

# EX30 Cross Country 2026 (25w17) User Manual

Version 2026-01-19

## Disclaimer

Due to the dynamic nature of our software-based product, the content of this PDF represents the most up-to-date version of the user manual as of the time of printing. As we continuously update and improve our product, certain content may not reflect the most up-to-date information in a future instance. Therefore, we strongly recommend utilizing the digital user manual app in your car's center display for the most accurate and up-to-date information. You can also access information in the Volvo Cars mobile app.

Please note that if you choose to print the manual, we cannot guarantee the validity of the information in future instances, as updates may have occurred since the time of printing. To ensure the highest level of safety and optimal product usage, we strongly advise relying on the digital user manual, which can be easily accessed through your car's center display.

This printable version is generic and does not correspond to your car. If there are discrepancies between this printable manual and the manual you see in your car's center display, the latter takes precedence.

## Contents

1. [Consumer information](#)
  - 1.1 [About the user manual](#)
    - 1.1.1 [Reading the user manual](#)
  - 1.2 [Customer support and contact information](#)
  - 1.3 [Driver responsibility](#)
  - 1.4 [Modifications, repairs and accessory installations](#)
  - 1.5 [Certified technicians](#)
  - 1.6 [Information about recalls](#)
  - 1.7 [Reporting safety defects](#)
  - 1.8 [Finding the vehicle identification number](#)
  - 1.9 [Approval of terms and conditions and data collection](#)
  - 1.10 [Handling of recorded and collected data](#)
  - 1.11 [About connected services and the fair use policy](#)
  - 1.12 [Changing ownership of the vehicle](#)
  - 1.13 [Resetting user data](#)
  - 1.14 [Recommendations when changing regions](#)
2. [User accounts, profiles and services](#)
  - 2.1 [Setting up your vehicle for the first time](#)
  - 2.2 [Volvo ID](#)
    - 2.2.1 [Creating a Volvo ID](#)
  - 2.3 [Volvo EX30 app](#)
  - 2.4 [Getting started with Google services](#)
  - 2.5 [Customization and settings](#)
  - 2.6 [Vehicle user profiles](#)
    - 2.6.1 [Switching profiles](#)
    - 2.6.2 [Adding a profile](#)
    - 2.6.3 [Removing a profile](#)
    - 2.6.4 [Assigning a key to profile](#)
    - 2.6.5 [Managing keys assigned to profiles](#)
    - 2.6.6 [Restricting access to a profile](#)
    - 2.6.7 [Adding an account to a profile](#)

The content of this manual represents the status of the user manual at the time of printing and may not be completely valid in future instances. For more information refer to the first page for the complete disclaimer note.

- 2.7 Volvo Assistance
  - 2.7.1 Calling Volvo Assistance for roadside assistance
- 2.8 Emergency assistance
  - 2.8.1 Calling emergency services with SOS button
- 3. Display, software and phone
  - 3.1 Display
    - 3.1.1 Main area of the display
      - 3.1.1.1 Display views
      - 3.1.1.2 Status symbols in the display
      - 3.1.1.3 Keyboard
        - 3.1.1.3.1 Changing the keyboard language
        - 3.1.1.3.2 Adding and removing keyboard languages
    - 3.1.2 Driver information area of the display
      - 3.1.2.1 Warning and indicator symbols
      - 3.1.2.2 Battery meter
    - 3.1.3 System settings
      - 3.1.3.1 Changing date and time
      - 3.1.3.2 Changing the system language
      - 3.1.3.3 Changing system units
    - 3.1.4 Restarting the display
  - 3.2 Phone
    - 3.2.1 Connecting your phone to the vehicle
    - 3.2.2 Using your phone in the vehicle
    - 3.2.3 Switching between paired phones
    - 3.2.4 Apple CarPlay
      - 3.2.4.1 Connecting your iPhone to Apple CarPlay
    - 3.2.5 Android Auto™
  - 3.3 Sound and media
    - 3.3.1 Radio
      - 3.3.1.1 Adding radio favorites
    - 3.3.2 Sound settings
    - 3.3.3 Media players
  - 3.4 In-vehicle apps
    - 3.4.1 Downloading apps
    - 3.4.2 Uninstalling apps
  - 3.5 Connectivity and software
    - 3.5.1 Internet connection
      - 3.5.1.1 Connecting to the internet via Wi-Fi
    - 3.5.2 Over-the-air updates
  - 3.6 Voice control
    - 3.6.1 Using voice control
- 4. Interior comfort and climate
  - 4.1 Interior
    - 4.1.1 Using the wireless charger
    - 4.1.2 USB ports
    - 4.1.3 12 V socket
    - 4.1.4 Sun visors
  - 4.2 Comfort
    - 4.2.1 Activating refresh mode
    - 4.2.2 Activating relax mode
  - 4.3 Climate
    - 4.3.1 Climate controls

- 4.3.1.1 Activating seat heating
      - 4.3.1.2 Activating the steering wheel heating
    - 4.3.2 Climate settings
    - 4.3.3 Temperature and air conditioning
      - 4.3.3.1 Activating air conditioning
      - 4.3.3.2 Setting the temperature
      - 4.3.3.3 Synchronizing temperature
      - 4.3.3.4 Activating eco climate
    - 4.3.4 Air distribution and climate modes
      - 4.3.4.1 Adjusting air vents
      - 4.3.4.2 Activating auto climate mode
      - 4.3.4.3 Activating manual climate mode
    - 4.3.5 Ice, condensation and defrosters
      - 4.3.5.1 Activating max defroster
      - 4.3.5.2 Activating rear windshield and door mirror heating
    - 4.3.6 Interior climate when parked
      - 4.3.6.1 Setting the preconditioning timer
      - 4.3.6.2 Activating parking comfort
    - 4.3.7 Air quality
      - 4.3.7.1 Air quality indication
      - 4.3.7.2 Activating air recirculation
    - 4.3.8 Climate system
      - 4.3.8.1 Climate zones
      - 4.3.8.2 Perceived and actual temperature
      - 4.3.8.3 Climate sensors
      - 4.3.8.4 Heaters
  - 4.4 Windows and glass panes
    - 4.4.1 Operating the windows
      - 4.4.1.1 Locking the rear windows
    - 4.4.2 Pinch protection
    - 4.4.3 Resetting windows
  - 4.5 Seats
    - 4.5.1 Front seats
      - 4.5.1.1 Adjusting the front seats
    - 4.5.2 Rear seats
      - 4.5.2.1 Adjusting rear seat headrests
      - 4.5.2.2 Removing rear seat headrests
      - 4.5.2.3 Folding down the rear seats
  - 4.6 Interior lighting
    - 4.6.1 Adjusting the reading lights
    - 4.6.2 Adjusting interior lights
    - 4.6.3 Adjusting ambience lighting
5. Safety
- 5.1 Collision response
  - 5.2 Occupant detection
  - 5.3 Proper seating
  - 5.4 Seat belts
    - 5.4.1 Fastening and adjusting seat belt
    - 5.4.2 Setting seat belt to only retract
    - 5.4.3 Seat belt reminder
  - 5.5 Airbags
    - 5.5.1 Airbag deployment

- 5.5.2 Front airbags
  - 5.5.2.1 Sensor-controlled passenger airbag status
- 5.5.3 Side airbags
- 5.5.4 Inflatable curtains
- 5.5.5 Airbag maintenance and servicing
- 5.5.6 Airbag labels
- 5.6 Child safety
  - 5.6.1 Child restraints
    - 5.6.1.1 Installing child restraints
      - 5.6.1.1.1 Installing child restraints in the outer rear seat positions
      - 5.6.1.1.2 Installing child restraints in the center rear seat
    - 5.6.1.2 Child restraint attachment points
      - 5.6.1.2.1 LATCH attachment points
      - 5.6.1.2.2 Top tether attachment points
      - 5.6.1.2.3 Lower tether attachment points
- 6. Entry and security
  - 6.1 Keys
    - 6.1.1 Key tag
      - 6.1.1.1 Replacing the key tag battery
    - 6.1.2 Key card
    - 6.1.3 Digital key
      - 6.1.3.1 Creating a digital key
      - 6.1.3.2 Deleting a digital key
    - 6.1.4 Key reading locations
  - 6.2 Opening and closing
    - 6.2.1 Opening the hood
    - 6.2.2 Closing the hood
    - 6.2.3 Trunk access
      - 6.2.3.1 Adjusting trunk opening height
  - 6.3 Locking and unlocking
    - 6.3.1 Activating child lock
    - 6.3.2 Settings for locking and unlocking
      - 6.3.2.1 Adjusting locking and unlocking settings
    - 6.3.3 Unresponsive lock
  - 6.4 Anti-theft
    - 6.4.1 Alarm
      - 6.4.1.1 Reducing alarm sensitivity
- 7. Charging your vehicle
  - 7.1 Charging types
    - 7.1.1 Charging cables
  - 7.2 Charging view and settings
    - 7.2.1 Setting a target battery level for charging
    - 7.2.2 Setting the amperage limit for charging
    - 7.2.3 Adding and managing charging schedules
  - 7.3 Starting and stopping charging
    - 7.3.1 Starting AC charging
    - 7.3.2 Starting DC charging
    - 7.3.3 Stopping AC charging
    - 7.3.4 Stopping DC charging
    - 7.3.5 Releasing the charging cable
      - 7.3.5.1 Manually releasing the charging cable
  - 7.4 Charging time and statuses



- 7.4.1 Charging times
  - 7.4.2 Charging status
    - 7.4.2.1 Charging status in the charging port
    - 7.4.2.2 Charging status in the display
- 8. Driving
  - 8.1 A typical driving cycle
  - 8.2 Trips app
  - 8.3 Starting the vehicle
    - 8.3.1 Startup checks
  - 8.4 Turning the vehicle off
  - 8.5 Driving characteristics
    - 8.5.1 Drive modes
      - 8.5.1.1 Selecting a drive mode
    - 8.5.2 One Pedal Drive
      - 8.5.2.1 Adjusting One Pedal Drive
    - 8.5.3 Enabling automatic creeping
    - 8.5.4 Activating hill descent
    - 8.5.5 Stability control
      - 8.5.5.1 Disabling electronic stability control
    - 8.5.6 Suspension
  - 8.6 Range
    - 8.6.1 Trip information
      - 8.6.1.1 Resetting the trip meter
  - 8.7 Steering
    - 8.7.1 Steering wheel
      - 8.7.1.1 Steering wheel controls
        - 8.7.1.1.1 Assigning an action to the customizable button
      - 8.7.1.2 Adjusting the steering wheel position
    - 8.7.2 Adjusting steering feel
  - 8.8 Brakes
    - 8.8.1 Foot brake
    - 8.8.2 Parking brake
      - 8.8.2.1 Engaging the parking brake
    - 8.8.3 Auto hold
    - 8.8.4 Post-impact braking
  - 8.9 Selecting the gear
- 9. Visibility, mirrors, and exterior lights
  - 9.1 Exterior lights
    - 9.1.1 Driving lights
      - 9.1.1.1 Selecting a primary lighting mode
      - 9.1.1.2 High beam
        - 9.1.1.2.1 Operating the high beam
      - 9.1.1.3 Operating the turn signals
      - 9.1.1.4 Activating the rear fog light
      - 9.1.1.5 Adjusting headlight height
      - 9.1.1.6 Hazard warning lights
        - 9.1.1.6.1 Activating the hazard warning flashers
    - 9.1.2 Exterior convenience lights
      - 9.1.2.1 Enabling the guidance light
      - 9.1.2.2 Enabling the welcome lights
  - 9.2 Mirrors
    - 9.2.1 Adjusting door mirrors

- 9.3 Wipers and washers
  - 9.3.1 Controlling the front wipers
  - 9.3.2 Controlling the rear wiper
  - 9.3.3 Activating washers
- 10. Driver support and navigation
  - 10.1 Navigation
    - 10.1.1 Finding and selecting a navigation destination
  - 10.2 Detection of surroundings and traffic
    - 10.2.1 Locations of cameras, sensors and radar units
    - 10.2.2 Camera detection and limitations
    - 10.2.3 Radar detection and limitations
    - 10.2.4 Parking sensor detection and limitations
  - 10.3 Safety interventions and warnings
    - 10.3.1 Collision warnings and mitigation
      - 10.3.1.1 Adjusting the sensitivity for forward collision warnings
      - 10.3.1.2 Enabling and disabling rear collision warnings
    - 10.3.2 Interventions and warnings when reversing
      - 10.3.2.1 Alerts about traffic crossing behind the vehicle
        - 10.3.2.1.1 Disabling rear cross traffic alert
      - 10.3.2.2 Disabling automatic braking when reversing
    - 10.3.3 Lane keeping aid
      - 10.3.3.1 Disabling lane keeping aid
      - 10.3.3.2 Disabling lane departure warnings
    - 10.3.4 Blind spot information
      - 10.3.4.1 Enabling blind spot alerts
    - 10.3.5 Door opening alerts
      - 10.3.5.1 Enabling door opening alerts
    - 10.3.6 Driver alert
      - 10.3.6.1 Disabling driver alerts
  - 10.4 Assisted driving
    - 10.4.1 Road signs and speeding response
      - 10.4.1.1 Speed limiter
        - 10.4.1.1.1 Activating the speed limiter
        - 10.4.1.1.2 Deactivating the speed limiter
        - 10.4.1.1.3 Adjusting the speed limiter value
        - 10.4.1.1.4 Enabling the speed limiter in settings
      - 10.4.1.2 Speed limit warnings
        - 10.4.1.2.1 Adjusting speed limit warnings
      - 10.4.1.3 Road sign information
    - 10.4.2 Pilot Assist
      - 10.4.2.1 Pilot Assist communication and status
      - 10.4.2.2 Activating Pilot Assist
      - 10.4.2.3 Deactivating Pilot Assist
      - 10.4.2.4 Adjusting the target speed for Pilot Assist
      - 10.4.2.5 Enabling and disabling steering assistance when driving
      - 10.4.2.6 Changing lanes with Pilot Assist
      - 10.4.2.7 Enabling Pilot Assist in settings
      - 10.4.2.8 Adjusting Pilot Assist settings
      - 10.4.2.9 Pilot Assist conditions and limitations
  - 10.5 Assisted parking
    - 10.5.1 Parking view
    - 10.5.2 Park Pilot Assist

- 10.5.2.1 Parking using Park Pilot Assist
- 10.5.2.2 Leaving a parking space using Park Pilot Assist

- 11. Scenarios and driving recommendations
  - 11.1 Cold conditions
    - 11.1.1 Winter driving recommendations
  - 11.2 Recommendations for driving through water
  - 11.3 Preparations for a long trip
  - 11.4 Long-term parking
- 12. Storage, stowing and towing
  - 12.1 Passenger compartment storage
    - 12.1.1 Glove compartment
      - 12.1.1.1 Locking the glove compartment
  - 12.2 Trunk space and storage
    - 12.2.1 Parcel shelf
      - 12.2.1.1 Removing the parcel shelf
    - 12.2.2 Removing the cargo hatch
    - 12.2.3 Stowing cargo in the trunk
      - 12.2.3.1 Accessing the cargo hold
  - 12.3 Storage under the hood
  - 12.4 Towing a trailer
  - 12.5 Determining the permitted gross vehicle weight
  - 12.6 Recommendations for loading
- 13. Care and maintenance
  - 13.1 Vehicle status
    - 13.1.1 Battery status and health
  - 13.2 Exterior cleaning and care
    - 13.2.1 Washing the exterior by hand
    - 13.2.2 Washing the vehicle in an automatic car wash
      - 13.2.2.1 Activating vehicle wash mode
    - 13.2.3 Polishing and waxing
    - 13.2.4 Touching up paintwork damage
      - 13.2.4.1 Finding the paint color code
    - 13.2.5 Windshield damage
    - 13.2.6 Refilling washer fluid
    - 13.2.7 Cleaning wipers
    - 13.2.8 Replacing front wiper blades
    - 13.2.9 Replacing the rear wiper blade
    - 13.2.10 Activating the wiper service position
    - 13.2.11 Corrosion protection
  - 13.3 Interior cleaning and care
    - 13.3.1 Cleaning fabrics and textiles
    - 13.3.2 Cleaning glass and glossy surfaces
      - 13.3.2.1 Activating display cleaning mode
    - 13.3.3 Cleaning interior plastic and metal components
    - 13.3.4 Cleaning mats
  - 13.4 Wheels and tires
    - 13.4.1 Wheel and tire recommendations
      - 13.4.1.1 Tires and wheel storage
      - 13.4.1.2 Tire economy
    - 13.4.2 Designations on tire sidewall
      - 13.4.2.1 Tire tread wear indicators

- 13.4.3 Changing wheels
  - 13.4.3.1 Spare wheel
  - 13.4.3.2 Winter tires
  - 13.4.3.3 Using snow chains
- 13.4.4 Punctures
  - 13.4.4.1 Temporary puncture repair
    - 13.4.4.1.1 Using the temporary puncture repair kit
    - 13.4.4.1.2 Inflating tires with the puncture repair compressor
- 13.4.5 Tire pressure
  - 13.4.5.1 Tire pressure monitoring
    - 13.4.5.1.1 Limitations of tire pressure monitoring
  - 13.4.5.2 Adjusting tire pressure
- 13.4.6 Tire terminology
- 13.5 Vehicle electrical system and batteries
  - 13.5.1 Traction battery
    - 13.5.1.1 Managing battery health and performance
    - 13.5.1.2 Powertrain cooling system
  - 13.5.2 12 V battery
    - 13.5.2.1 Battery labels
  - 13.5.3 Battery recycling
  - 13.5.4 Fuses
- 13.6 Tools and equipment
  - 13.6.1 Using a warning triangle
  - 13.6.2 Attaching the towing eye
- 13.7 Raising the vehicle
- 13.8 Servicing and repairs
  - 13.8.1 Booking servicing or repairs
  - 13.8.2 On-board diagnostic port
- 14. Immobilized vehicle and recovery
  - 14.1 Damaged vehicle
  - 14.2 Malfunction
  - 14.3 Vehicle has no power or is not responding
  - 14.4 Recovery
  - 14.5 Safety mode
  - 14.6 Having your vehicle towed
    - 14.6.1 Activating tow mode
- 15. Specifications
  - 15.1 General vehicle characteristics
    - 15.1.1 Vehicle dimensions
    - 15.1.2 Weights
    - 15.1.3 Towing specifications and capabilities
    - 15.1.4 Towbar specifications
    - 15.1.5 Type designations
  - 15.2 Powertrain specifications
    - 15.2.1 Electric motor specifications
    - 15.2.2 Performance
    - 15.2.3 Charging cable specifications
    - 15.2.4 Charging port label
  - 15.3 Wheel and tire specifications
    - 15.3.1 Approved tire pressures
  - 15.4 Fluid specifications
    - 15.4.1 Brake fluid specifications

- 15.4.2 Climate system specifications
- 15.5 Certificates and type approvals
  - 15.5.1 Procedure to temporarily change the automatic high beam sensitivity
  - 15.5.2 Radar type approvals
  - 15.5.3 Type approval for TPMS radio frequency
  - 15.5.4 Type approvals for wireless charger and NFC
  - 15.5.5 Key system certification
- 15.6 Labels

# 1. Consumer information

There's a lot to learn about your Volvo vehicle. This section covers some essential topics, such as where you can find support if you need it and information about certain consumer rights and responsibilities.



Tip

## Where to start?

Technically, the whole manual is recommended reading for anyone new to the vehicle. However, you can start by reading the information about how this user manual works so you know how to find what you need.

## Driver responsibility

The information about driver responsibility is also a good place to start reading. It covers some general principles for safe use of the vehicle and its features.

## 1.1. About the user manual

Learn how the user manual applies to using your vehicle, as well as where you can find the manual and how to navigate its content.

### An important part of your vehicle

Your vehicle is a highly advanced product. However, as a well-designed product, advanced doesn't have to mean it's difficult to use. The aim here is to give you an intuitive experience, with natural interactions that work for both driver and passenger alike. This manual is designed to be a part of the vehicle, giving you information for safe and effective use. It is your resource on the vehicle's functions and features.



Tip

## New user

If you are new to this vehicle, take some time to explore the different areas of the manual. Knowing the vehicle's capabilities and limitations is your responsibility and a necessity for safe and effective use.

### Keep the manual up to date

Make sure that you keep the manual up to date by always having the latest version. Take a look any time a software update introduces changes or new features.

### A guide to your vehicle's intended use

The user manual establishes the vehicle's intended use, as defined by Volvo. Whenever you are directed to the manual, consider it an instruction to make sure that you are using the vehicle as intended. This is recommended, as both the descriptive and prescriptive parts of the user manual provide important knowledge that contributes to safe and effective use.

**The content of this manual represents the status of the user manual at the time of printing and may not be completely valid in future instances. For more information refer to the first page for the complete disclaimer note.**

***i* Note**

### Intended use

If you use the vehicle in a manner which Volvo has not intended, it can negatively affect how it works. This includes shortening the vehicle's service life and limiting your ability to use the vehicle safely and effectively. It may also affect the validity of the vehicle warranty.

Volvo is not the only authority that defines proper use of the vehicle. It is your responsibility to use the vehicle in accordance with local laws and restrictions.

## Accuracy in representing your vehicle

The primary goal of this manual is to accurately describe how your vehicle works. However, certain differences between produced vehicles are not reflected in the manual, such as colors, materials and certain equipment.

***i* Note**

Vehicles are equipped and adapted to meet specific market needs, as well as local legislation and requirements. Certain regional variations in configuration may not be reflected in the user manual's content.

## Where to find the user manual

Your vehicle's user manual is available as an app in the vehicle's display, via the mobile app for the vehicle and at [volvocars.com/intl/support](https://www.volvocars.com/intl/support) [<https://www.volvocars.com/intl/support>].

***i* Note**

### Volvo's support site

The version of the user manual on Volvo's support site is for a fully-equipped vehicle with all of the available options, functions and features. Therefore, it may differ from this user manual due to what's available in your vehicle.<sup>[1]</sup>

### Printed supplements

The user manual is fully digital, but a selection of its content may be included with your vehicle as a printed supplement. The inclusion of printed supplements depends on your region and how your vehicle is configured.

## Applicability

 **Important**

- Maintain and handle the vehicle according to Volvo's recommendations in the user manual. Volvo accepts no responsibility for damage or accidents if you disregard the instructions in this manual.
- It is recommended that you read all the user information before you drive for the first time.
- If you find information that differs from the information in your vehicle through other channels, such as the Volvo website, it is always the user information in the vehicle's display that is valid.
- Volvo works continuously to improve the quality of the user information and make it more accessible and useful. This means that descriptions and illustrations may change. Volvo reserves the right to make changes without prior notice.
- The original version of this user manual is written in British English. Therefore, there may be certain differences between the descriptions in the manual and the actual vehicle.
- The descriptions in this manual are based on general usage conditions. Remember that they can change depending on location, environment and driving behavior.
- No illustrations or texts in this manual may be copied without permission from Volvo.

<sup>[1]</sup> Availability may vary between regions and equipment levels.

---

## 1.1.1. Reading the user manual

Learn how the content in this manual is organized so you can find what you need when you need it.

Your vehicle's user manual is designed to guide you, both when you're looking for a specific piece of information and when you're simply exploring to learn more about your vehicle.

### Structure

This user manual is a large network of informational pages. Each page has its own content and a list of links that take you to related pages. The links can take you to subsections of the page you're on or to other sections that are related to what you're currently reading.

 **Tip**

#### Finding the right level of information

Sometimes the answer to what you're looking for might not lie in the details. Moving up a level or two in the structure might provide the context and perspective you need, or just a better idea of where to look.

#### Searching for information

You can use the search field for quicker access to what you're looking for.

#### All main areas

To get you started, the related information links on this page include all main sections in this manual.



## Navigate through interactive images

Some of the manual pages have images with interactive markers. You can tap these markers to reveal links to relevant parts of the manual. These interactive markers allow you to explore the manual in a more visual way.



**Tip**

### Animated introductions

Some pages show a short animation as an introduction. This provides you with a few visual hints of what you can expect to find in that part of the manual.

## Images and videos

Images in the user manual are sometimes schematic and intended to give an overview or an example. Images can differ from your vehicle due to equipment level or market requirements.

## Highlighted content

Throughout this manual you will find content that is highlighted in various ways.



**Warning**

Content that is highlighted like this primarily provides information about conditions or use with a clear potential to cause severe harm to health.



**Important**

Content that is highlighted like this primarily provides information about conditions or use with a clear potential to cause material damage.



**Note**

Content that is highlighted like this primarily contains information that can help you avoid incorrect use or information that is easily missed or misunderstood.



**Tip**

Content that is highlighted like this primarily provides tips for use or where to find related content.

## Options or accessories

Some equipment and features are only available for certain vehicle configurations or markets. Even if the information is available to you, it is not a guarantee that the specific equipment described is available in your vehicle.

**Note**

There may be differences in terminology between the user manual and materials for marketing, sales and advertisements.

For more information on standard and optional equipment, contact a Volvo retailer.

---

## 1.2. Customer support and contact information

If you have any questions regarding your vehicle, you can find answers or solutions in a number of places. In addition to searching the user manual you are reading now, you can visit Volvo's website, Volvo's support site or contact Volvo Assistance.

### Website and support site

Volvo's website [volvocars.com](https://www.volvocars.com) [https://www.volvocars.com] has several customer support resources.

The support section [volvocars.com/intl/support](https://www.volvocars.com/intl/support) [https://www.volvocars.com/intl/support] provides contact information, software news and answers to frequently asked questions. You can also find your closest Volvo retailer or contact Volvo via phone or chat.

### Volvo Assistance

Volvo Assistance can offer help in the event of a breakdown or if your vehicle unexpectedly becomes immobilized. This includes roadside assistance. Volvo Assistance is available 24 hours a day, 7 days a week.

Press the assist button  on the roof or use the mobile app for the vehicle to contact Volvo Assistance.

### Contact information

For questions that can't be solved by Volvo's other support services, contact Volvo using the following information:

#### Volvo Vehicle Canada Ltd.

Customer Care Centre

9130 Leslie Street, Suite 101

Richmond Hill, Ontario L4B 0B9

Telephone: 1-800-663-8255

[volvocars.com/ca](https://www.volvocars.com/ca) [https://www.volvocars.com/ca]

---

## 1.3. Driver responsibility

The content of this manual represents the status of the user manual at the time of printing and may not be completely valid in future instances. For more information refer to the first page for the complete disclaimer note.

As a driver, you are responsible for doing everything possible to ensure your own safety, as well as that of your passengers and other road users.

Your knowledge, decisions and actions determine how safely you drive. Your vehicle has features that, in certain situations, can compensate for mistakes and lapses in judgment. However, they do not change where the responsibility lies. They are a supplement to good driver practices, which you are responsible for as a driver.

You have likely studied and practiced to ensure you have the necessary knowledge and abilities to be a safe driver. This section covers a few essentials you may recognize, such as:

- Driving and using driver support functions
- Knowing the vehicle's capabilities and limitations
- Driver distraction
- Driver fatigue
- Laws and regulations

## Driving

You are responsible for adapting your driving to the current conditions, even when using driver support functions. This includes adapting your distance to other vehicles' speeds, as well as being ready to react to traffic and road hazards. Your vehicle's safety interventions and warnings rely on accurate detection and identification of surrounding traffic and road conditions. The detection systems cannot handle all driving, traffic, weather and road conditions.

### Note

#### Driver support

Driver support functions can assist you with certain driving tasks and improve driving awareness. When used correctly, they can improve safety and convenience, but they are not a replacement for safe driving practices. Drive the vehicle with the same attention to safety as you would need to in a vehicle without these functions.

## Knowing the vehicle's capabilities and limitations

Before driving, all drivers are advised to familiarize themselves with the vehicle and any functions and features they might use. The driver has a responsibility to ensure they have sufficient knowledge of the vehicle to use it safely.

If you are uncertain about any of the vehicle's functions or have questions about its intended use, consult the manual. If you can't find the information you need, contact Volvo Support.

## Driver distraction

Distractions reduce your attentiveness and focus when driving. As a driver, you are always responsible for assessing whether a task is safe to perform. Your assessment should take the situation as a whole into account, as well as specific conditions and circumstances that can cause distraction. It might be safe to adjust the volume when you're driving on a straight empty road, but not in more demanding situations, such as when overtaking.



### Warning

#### Avoid distractions

Any task that prevents you from keeping your attention on the road and surrounding traffic should only be performed when the vehicle is parked. The following are some examples of tasks you should not do while driving:

- Do not hold your phone while driving. Local laws often restrict or forbid phone use while driving.
- Do not manually change the navigation route while driving.
- Do not change detailed sound settings while driving.

#### Driver responsibility and safety features

Your vehicle has several safety features designed to reduce the risk of an accident. They do not reduce the driver's responsibility to remain attentive or the need to operate the vehicle as safely as possible.



### Tip

#### Help from passengers

Tasks that risk distracting the driver can often be done by a passenger instead. However, certain actions are simply not available in the vehicle when driving, such as reading this manual on the display. For these actions, you need to be parked.

#### Voice control

Voice commands can, in some situations, be less distracting than doing the same task manually.

## Driver fatigue

The driver is always responsible for being well-rested. Your vehicle has some functions with abilities to warn you if you show signs of fatigue. It's important to always stop and take a break at the slightest feeling of fatigue, regardless of whether a function has given you a warning.

## Laws and regulations

The driver is always responsible for knowing and following local laws and regulations. If you drive to a region with different traffic laws, make sure that the vehicle is equipped as required and read up on how the traffic laws differ from what you're used to.

---

# 1.4. Modifications, repairs and accessory installations

Modifications<sup>[1]</sup>, repairs and installation of accessories or extra equipment require proper knowledge, quality workmanship and quality parts. Otherwise, they risk impairing your vehicle's functionality and safety. Contact a Volvo retailer before making any alterations to your vehicle.

For any alterations<sup>[2]</sup> to the vehicle, Volvo strongly recommends that:

**The content of this manual represents the status of the user manual at the time of printing and may not be completely valid in future instances. For more information refer to the first page for the complete disclaimer note.**

- you seek prior advice of a trained and qualified Volvo service technician.
- work is only carried out by trained and qualified Volvo service technicians.
- installed parts and accessories are approved by Volvo.<sup>[3]</sup>
- parts and accessories are installed according to their installation instructions.
- they comply with local laws and regulations.<sup>[4]</sup>

Contact a Volvo retailer for more information.



### Warning

#### Systems can be negatively affected

Unapproved or incorrectly installed accessories can negatively affect your vehicle's performance, communication and safety systems. Certain accessories only work with associated software that needs to be installed in the vehicle.

#### Electrical installations

For additional electrical installations, it is essential to use appropriate connection points to ensure the integrity of the vehicle's electrical system. The vehicle has a specific ground attachment point designated for aftermarket installations, which is separate from those reserved for critical components. Volvo recommends an authorized Volvo workshop for any electrical installations.

#### End-of-life handling

Some parts of the vehicle are dangerous to handle. Special handling is required when servicing or scrapping after the vehicle has reached its end-of-life.

- Electrical components in the vehicle<sup>[5]</sup> may contain harmful substances and can deliver lethal electrical shock if handled incorrectly.
- Components such as airbag modules, seat belt tensioners, adaptable steering columns and button cell batteries may contain perchlorate materials.



### Note

#### Non-approved changes and liability

Volvo does not accept any liability for damage, incurred cost, personal injury or fatality that is caused by changes to the vehicle<sup>[6]</sup> not approved by Volvo.

<sup>[1]</sup> Modifications include changes to the vehicle's software, including but not limited to tuning.

<sup>[2]</sup> This means modifications, repairs and installation of accessories and extra equipment.

<sup>[3]</sup> Accessories that are not approved by Volvo may not have been specifically tested for use with your vehicle.

<sup>[4]</sup> This applies to both the act of making the alteration and subsequent use of the altered vehicle.

<sup>[5]</sup> Such as batteries

<sup>[6]</sup> Including but is not limited to modification, repair and installation of accessories or extra equipment.

## 1.5. Certified technicians

Ensure that the technicians handling your vehicle have the qualifications required to do so safely.

Certified technicians have met high competence requirements within specific areas. In addition to having passed the exam, every technician must also have worked in the field for at least two years before a certificate is issued. These professional technicians have the best capacity to analyze vehicle problems and carry out the maintenance that is necessary to keep your Volvo in the best possible condition.

### Electric vehicles

Technicians who carry out work on vehicles with electric drive should also have the necessary training and special certification required to carry out repairs and/or maintenance on electrically powered vehicles.

#### **Warning**

A number of electrical components in vehicles with electric drive use current with high voltage and can be extremely dangerous if they are handled incorrectly. These components, as well as all orange-colored cables in the vehicle, must only be handled by trained and qualified Volvo service technicians.

## 1.6. Information about recalls

It is important that you stay updated about open recalls.

To find out if your vehicle has any open recalls, you can:

- Contact an authorized Volvo retailer or Volvo support
- Search the recall database on the Transport Canada website [www.tc.gc.ca](http://www.tc.gc.ca) [<https://tc.canada.ca/>]

#### **Note**

You will need your vehicle's Vehicle Identification Number<sup>[1]</sup> to check whether it is affected by a recall or safety alert.

<sup>[1]</sup> VIN

## 1.7. Reporting safety defects

If you think there is a safety defect with your vehicle, you need to report it to the correct authorities. The following information is phrased according to external legal requirements.

If you think your vehicle has a defect that may cause an accident or that may cause injury or death, you must immediately notify both Transport Canada and Volvo Car Canada Ltd.

You can contact Transport Canada at:

**Telephone:** 1-866-995-9737  
**Teletypewriter (TTY):** 1-888-675-6863  
**Fax:** 613-954-4731  
**Mailing address:** Transport Canada - 330 Sparks St, Ottawa, (Ontario) K1A 0N5  
**Website:** [www.tc.gc.ca](http://www.tc.gc.ca) [<https://tc.canada.ca>]

---

## 1.8. Finding the vehicle identification number

There are several ways to find your vehicle's unique vehicle identification number. <sup>[1]</sup> You might need your vehicle's VIN if you contact Volvo about any questions or problems regarding your vehicle.

You can find the number in one of the following ways:

- In the display.
- On a label on the dashboard close to the lower edge of the windshield. It can typically be read from outside the vehicle.
- In the vehicle's registration documentation.
- By contacting a service technician, who can retrieve it through the on-board diagnostics socket.

### On the display

- 1 Press the vehicle symbol  in the bottom bar and go to **Settings**.
- 2 Go to **System** → **About** → **VIN number**.

<sup>[1]</sup> VIN

---

## 1.9. Approval of terms and conditions and data collection

You will see messages about different terms and conditions and data collection <sup>[1]</sup> in the display. Your agreement is necessary for certain apps and services to work properly.

The first time you use your vehicle, a guide opens in the display to assist you in choosing various settings. In connection with the guide, you are prompted to give your agreement to different types of terms and conditions, as well as data collection. You can do this later in privacy settings as well.

You may also need to give your consent at other times, such as when you:

- Use an app or service for the first time

**The content of this manual represents the status of the user manual at the time of printing and may not be completely valid in future instances. For more information refer to the first page for the complete disclaimer note.**

- Add a new profile
- Sign out from and delete a profile
- Change ownership
- Reset the settings

#### Accept privacy settings

- 1 Press the vehicle symbol  in the bottom bar and go to **Settings**.
- 2 Go to **Privacy**.



#### Tip

You can also find the privacy settings in profile settings.

- 3 Select the privacy setting you want to change and follow the instructions in the display.



#### Note

##### Before using the internet

The terms of use must be accepted once per vehicle in order to use the internet.

##### Volvo services

You can manage your consent to data sharing with Volvo here.

##### Vehicle location sharing

Give your consent for the vehicle to be able to share its location. This is necessary if you want to use certain apps and functions. For example, location sharing is required for remote vehicle services via Volvo Assistance and the mobile app for the vehicle, such as Find my vehicle and the Trips app. <sup>[2]</sup>

##### Vehicle Analytics & Improvement

Vehicle Analytics & Improvement can improve aftermarket services such as customer support, service planning and workshop visits. For this to work, you need to give your consent in the display.

<sup>[1]</sup> Data is collected to provide better vehicle, safety and app functions.

<sup>[2]</sup> The Trips app can then collect data such as the vehicle's position, speed, mileage and power consumption.

## 1.10. Handling of recorded and collected data



Certain information about the vehicle's status and operation is recorded and collected for quality and safety reasons. This can provide an understanding of the circumstances around traffic accidents involving the vehicle and other usage scenarios.

## Event Data Recorder (EDR)

This vehicle is equipped with an event data recorder (EDR). The main purpose of an EDR is to record, in certain crash or near crash-like situations, such as an air bag deployment or hitting a road obstacle, data that will assist in understanding how a vehicle's systems performed. The EDR is designed to record data related to vehicle dynamics and safety systems for a short period of time, typically 30 seconds or less. The EDR in this vehicle is designed to record such data as:

- How various systems in your vehicle were operating;
- Whether or not the driver and passenger seat belts were buckled/fastened;
- How far (if at all) the driver was depressing the accelerator and/or brake pedal; and,
- How fast the vehicle was traveling.

These data can help provide a better understanding of the circumstances in which crashes and injuries occur. NOTE: EDR data is recorded by your vehicle only if a non-trivial crash situation occurs; no data is recorded by the EDR under normal driving conditions and no personal data (e.g., name, gender, age, and crash location) is recorded. However, other parties, such as law enforcement, could combine the EDR data with the type of personally identifying data routinely acquired during a crash investigation.

To read data recorded by an EDR, special equipment is required, and access to the vehicle or the EDR is needed. In addition to the vehicle manufacturer, other parties, such as law enforcement, that have the special equipment, can read the information if they have access to the vehicle or the EDR.

## Additional recorded data

In addition to the EDR, the vehicle is equipped with a number of computers designed to continually check and monitor the vehicle's functioning. They can record data during normal driving conditions, but in particular they record register faults affecting the vehicle's operation and functionality, or upon activation of the vehicle's active driver support function.

Some of the recorded data is required to enable service and maintenance technicians to diagnose and remedy any faults that occurred in the vehicle. The recorded information is also needed to enable Volvo to satisfy legal requirements laid out in laws and government regulations. Information registered in the vehicle is stored in its computer until the vehicle is serviced or repaired.

In addition to the above, the registered information can be used in combined form for research and product development with the aim of continuously improving the safety and quality of Volvo vehicles.

Volvo will not contribute to the above-described information being disclosed to third parties without the vehicle owner's consent. To comply with national legislation and regulations, Volvo may be forced to disclose information of this nature to the police or other authorities who may assert a legal right to access such information. Special technical equipment which Volvo and workshops that have entered into agreements with Volvo have access to is required to be able to read and interpret the recorded data. Volvo is responsible for ensuring that the information, which is transferred to Volvo during servicing and maintenance, is securely stored and managed and that its management complies with relevant legal requirements. For further information, contact a Volvo retailer.

## 1.11. About connected services and the fair use policy

Use of your vehicle's connected services is subject to certain conditions.

Where Volvo Cars is responsible for the provision of mobile connectivity services to enable use of certain functions, and excluding any separate contract for mobile connectivity services of the owner or any other user of the vehicle that Volvo Cars is not party to, each user understands and agrees that, to the extent permitted by law, they: (1) have no contractual relationship with the underlying wireless service carrier, (2) are not a third-party beneficiary of any agreement between the vehicle owner and the underlying carrier, (3) that the underlying carrier has no liability of any kind to the user, whether for breach of contract, warranty, negligence, strict liability in tort or otherwise, (4) that data transmissions and messages may be delayed, deleted or not delivered, and emergency calling may not be completed, (5) the underlying carrier cannot guarantee the security of wireless transmissions and will not be liable for any lack of security relating to the use of the services.

### Fair use policy

Your use of the connectivity services that are part of your vehicle is subject to this fair use policy.

When using these services, you agree not to:

- submit content that is unlawful, obscene, libelous, threatening, harassing, hateful, racially or ethnically offensive or otherwise inappropriate.
- use the services in violation of any applicable law.
- use the services for commercial purposes.

Your access to these services is part of a shared access. Volvo Cars reserves the right to suspend your access to or use of the services if your use involves very high volumes of data, disproportionate to other users. Volvo Cars may also suspend your access for technical reasons or to protect other functions of your vehicle.

---

## 1.12. Changing ownership of the vehicle

The vehicle driver must be registered with Volvo to use all available functions and services. Therefore, when there is a change of ownership, the current owner needs to be removed to give the new owner access.

The current owner needs to remove the link between the mobile app and the vehicle. The new owner then needs to link their mobile app to the vehicle before using it.

### Note

#### Reset the vehicle

When the current owner has ended their ownership, an automatic factory reset of the vehicle takes place. This means that profiles, user data and other individual settings are removed.

---

## 1.13. Resetting user data

The content of this manual represents the status of the user manual at the time of printing and may not be completely valid in future instances. For more information refer to the first page for the complete disclaimer note.

You can reset the system settings and user data in the display.

You can reset app settings or network settings to their standard values or do a complete factory reset by resetting the vehicle. If you reset the vehicle, you will delete all of the vehicle's data, including profiles, accounts and other customized settings.

 **Note**

Only the owner can reset the vehicle.

- 1 Press the vehicle symbol  in the bottom bar and go to **Settings**.
- 2 Go to **System** → **Reset options**.
- 3 Select what you want to reset and follow the instructions in the display.

After resetting the vehicle, the setup guide will automatically start to set up a new owner profile.

---

## 1.14. Recommendations when changing regions

When relocating or importing your vehicle to a new region, you need to register your vehicle and Volvo ID there.

To get help registering your vehicle in a new region, contact Volvo Support.

 **Note**

Available services may vary over time and depend on region. This may also have an effect when visiting another region temporarily.

Do not export your Volvo to another country without researching the country's current safety requirements. In some cases, it may be difficult or impossible to meet these requirements.

## 2. User accounts, profiles and services

Get more out of your vehicle by customizing it using profiles and connecting it to the phone app. This gives you access to more features and services, such as support if you're having issues on the road.

### Note

Many of the services available for your vehicle require a registered personal account, such as your Volvo ID.

To get the most out of your vehicle experience:

- Connect your Volvo ID
- Download the mobile app for this vehicle to your phone
- Set up your user profile and customize your vehicle's settings
- Sign in with your Google account

---

### 2.1. Setting up your vehicle for the first time

A guide will help you set up your vehicle the first time you use it.

The setup guide for your vehicle automatically starts in the display. It guides you through profile creation and other essential settings.

### Tip

#### Before getting your vehicle

Before you start, you will need to create a Volvo ID and download the mobile app for the vehicle. This makes the in-vehicle setup faster.

The setup guide covers the following:

- Important settings, such as your vehicle's system language
- Setting up user profiles
- Connecting a key
- Consent to terms and conditions for various vehicle services and other third-party services
- Connecting the vehicle to the mobile app

 **Note**

### Stay parked during setup

The vehicle needs to be stationary and in P when you go through the setup guide.

### Complete setup

It is advisable to complete the setup before driving the vehicle. If you exit the guide before going through the necessary steps, certain features will be unavailable until you go back and complete the process. You will also be reminded about the setup the next time you drive the vehicle.

### No guide?

If the vehicle has already been set up by someone else, such as a previous owner, you can reset the vehicle to access the setup guide again.

---

## 2.2. Volvo ID

Your Volvo ID is a personal account that gives you access to various services connected to your vehicle.

You will need your Volvo ID when you use remote features via the mobile app for the vehicle.

 **Note**

Available services can vary over time and depend on both region and equipment level.

---

### 2.2.1. Creating a Volvo ID

Create your Volvo ID in the mobile app for the vehicle or on Volvo's website.

If you want to use the mobile app to create your Volvo ID, make sure that you have the latest version installed on your phone.

- 1 Open the app on your phone or go to [volvocars.com \[https://www.volvocars.com\]](https://www.volvocars.com).

 **Note**

If you use the website, make sure that you are signed in.

- 2 Select the option to create a new Volvo ID and follow the instructions.

**i Note**

After creating your Volvo ID, you may need to confirm your email address to fully activate your account.

---

## 2.3. Volvo EX30 app

The Volvo EX30 app allows you to control certain functions and interact with the vehicle via your phone.

The Volvo EX30 app is available for iPhone and Android phones. You can download it for free from your phone's app store. The app is updated regularly, so make sure that you have the latest version on your phone.

**i Note**

The Volvo EX30 app and your vehicle need to be connected to the internet for all services to work properly.

Here are a few things you can do in the Volvo EX30 app:

- Lock and unlock doors.
- Manage charging.
- Control climate features when parked.
- Check the vehicle's status, such as its battery level and lock status.
- View your account information.
- Explore the user manual.
- Find customer services, such as assistance and support.

---

## 2.4. Getting started with Google services

Signing in with your Google account gives you a personalized experience when using Google services and apps such as Maps.

To sign in to your Google account and take full advantage of Google services, the vehicle needs to be connected to the internet.

- 1 If you don't already have a Google account, go to [accounts.google.com/signup](https://accounts.google.com/signup) [https://accounts.google.com/signup] and create one.
- 2 Sign in using your Google account via the vehicle display and follow the instructions.

## 2.5. Customization and settings

You can customize many of your vehicle's features and behaviors by accessing its settings.

### Where to find settings

Settings and adjustments are available in the following places:

- The settings tab in the display contains most of your vehicle settings and adjustments. To access it, press the vehicle symbol  in the bottom bar and go to **Settings**. There are several categories to explore within the tab.
- Some views and in-vehicle apps have their own settings sections. Open the app or view and look around to find available customization options.
- The mobile app for the vehicle has settings related to remote and connected features.

### Setting types

Your vehicle's settings apply differently depending on their type. Most settings are specific to a user profile, but some apply to all users of the vehicle. A few settings are only available to adjust when the owner profile is in us, since only it has administrative privileges.



Tip

#### Customized experience

Set up user profiles for all drivers to get a customized experience. There are many profile-specific settings that are applied automatically when you select your profile.

Some settings apply indefinitely from the moment you change them, while others may only be temporarily applied, such as until the end of the current drive.

## 2.6. Vehicle user profiles

For a more customized experience, you can set up user profiles for different drivers.

To access all of your vehicle's features, you need to set up the owner profile. You can then add co-driver profiles for more users. Having individual user profiles allows each driver to save customized settings and adjustments that are automatically applied when their profile is selected.

| Profile type     | Who uses it?  |
|------------------|---|
| <b>Owner</b>     | The permanent user profile for the owner of the vehicle.                  |
| <b>Guest</b>     | A guest user profile that's available for temporary users of the vehicle. |
| <b>Co-driver</b> | Up to four additional user profiles for regular users of the vehicle.     |

The owner has all the administrative privileges, while the co-drivers have some of them. Guests can make some adjustments, but the profile resets after every driving cycle.

You can find the profile settings in settings, where you can do the following:

- Switch profiles
- Change your profile name
- Add an account to your profile
- Connect a key to your profile
- Enable profile lock
- View and change your privacy settings
- Connect the mobile app for the vehicle to your vehicle
- Remove your profile

 **Note**

The owner can also manage other profiles in their profile settings.

## 2.6.1. Switching profiles

You can switch between profiles in the display.

 **Note**

Only available while stationary

You can only switch profiles when the vehicle is stationary and in P. Switching is also unavailable during certain tasks.

Locked profile?

You might need a PIN, pattern or password to unlock a profile before using it.

- 1 Press the vehicle symbol  in the bottom bar and go to **Settings**.
- 2 Go to **Profiles** → **Switch profile**.
- 3 Select your profile from the profile picker.
  - > The vehicle switches to your profile.

## 2.6.2. Adding a profile



You can add different profiles in the vehicle's display.

## In the setup guide

The setup guide in the display has instructions for how to add the owner profile. You can also add other co-driver profiles later in profile settings.

 **Note**

If you don't complete the setup guide, some features and services are unavailable.

### Add a profile in profile settings

- 1 Press the vehicle symbol  in the bottom bar and go to **Settings**.
- 2 Go to **Profiles** → **Switch profile**.
- 3 Press **Add new profile** and follow the instructions in the display.

## 2.6.3. Removing a profile

Find out how to remove a profile in the display.

### Note

#### Guest profile

You cannot remove the guest profile.

#### Removing the owner profile

You can only remove the owner profile by resetting the vehicle.

- 1 Press the vehicle symbol  in the bottom bar and go to **Settings**.
- 2 Go to **Profiles** → **Manage profile** → **Remove profile**.
- 3 Select **Remove**.

### Tip

The owner can remove other profiles if they have access to them.

When you have removed a profile, the vehicle will automatically go to the guest profile.

## 2.6.4. Assigning a key to profile

You can only assign one key to your profile. Choose distance-capable key or a key card.

### In the setup guide

You can assign your key to the owner profile in the setup guide. When it's time, place your key on the NFC reader and follow the instructions in the display. You can also do this later in profile settings.

#### Assigning a key to a profile in profile settings

- 1 Press the vehicle symbol  in the bottom bar and go to **Settings**.
- 2 Go to **Profiles** → **Access and privacy** → **Connect key to profile**.
- 3 Press **Connect** and follow the instructions in the display.

---

## 2.6.5. Managing keys assigned to profiles

You can only assign one key to your profile. If you want to assign another key, you need to remove the connected key first.

- 1 Press the vehicle symbol  in the bottom bar and go to **Settings**.
- 2 Go to **Profiles** → **Access and privacy** → **Connected key**.
- 3 Press **Remove**.

---

## 2.6.6. Restricting access to a profile

You can restrict access to a profile by adding a profile lock. When a profile lock is active, you need a PIN, pattern or password to unlock the profile.

- 1 Press the vehicle symbol  in the bottom bar and go to **Settings**.
- 2 Go to **Profiles** → **Access and privacy** → **Enable profile lock**.
- 3 Press **Enable**.
- 4 Select your preferred lock type and follow the instructions in the display.

If you want to change the profile lock, press **Edit**.

---

## 2.6.7. Adding an account to a profile

You can add different accounts to your profile. This includes accounts from third-party apps.

- 1 Press the vehicle symbol  in the bottom bar and go to **Settings**.
- 2 Go to **Profiles** → **Accounts** → **Add new account**.
- 3 Press **Add**.
- > You will see a list of possible accounts to add.

- 4 Select the account you want to add and follow the instructions in the display.

If you want to remove an account from your profile, select the account under **Accounts** and press **Remove**.

---

## 2.7. Volvo Assistance

Volvo Assistance is a service that provides assistance and remote access to certain vehicle features. You can contact a Volvo Assistance service center at any time for assistance.

If you experience any unpredictable problems on the road, you can call Volvo Assistance. For example, if:

- your vehicle's battery runs out of charge
- your vehicle breaks down
- you get a flat tire.

Volvo Assistance is available in the mobile app for the vehicle and by pressing the assist button  in the vehicle's roof.

### Note

#### Not for emergencies

If you need assistance in an emergency situation, press the SOS button instead. Situations that could require immediate emergency assistance include traffic accidents, acute illness and external threats.

## An included service

Volvo Assistance is included with new Volvo vehicles for the first few years of ownership.<sup>[1]</sup> For more information regarding your vehicle, contact Volvo support or a Volvo retailer.

### Note

If you don't have a Volvo Assistance agreement, you will still be able to use the service for an extra cost.

## Terms and conditions

Volvo Assistance is intended to be active for as long as the vehicle is used and the technology it relies on is supported, such as the vehicle's mobile network connectivity.

Certain information, including personal data, needs to be shared with Volvo in order to use Volvo Assistance. Read more about data processing at [volvocars.com/intl/legal/privacy](https://www.volvocars.com/intl/legal/privacy) [<https://www.volvocars.com/intl/legal/privacy>].

 **Note**

Volvo reserves the right to reduce Volvo Assistance functionalities that it deems no longer practically possible to maintain.

If a vehicle remains unused for more than one year, it is considered no longer in use.

If you need any help or have any questions regarding Volvo Assistance, contact Volvo support.

<sup>[1]</sup> Availability and inclusion with new vehicles varies between regions.

---

## 2.7.1. Calling Volvo Assistance for roadside assistance

You can press the assist button on the vehicle's roof to contact Volvo Assistance for roadside assistance.<sup>[1]</sup> For example, if you experience any unpredictable problems on the road, such as if your vehicle's battery runs out of charge, your vehicle breaks down or you get a flat tire.

### Note

#### Not for emergencies

If you need assistance in an emergency situation, press the SOS button instead. Situations that could require immediate emergency assistance include traffic accidents, acute illness and external threats.

#### Using Volvo Assistance abroad

If you press the assist button  when you are abroad, you will reach Volvo Assistance in your home country.

### Tip

You can also use the mobile app for the vehicle to contact Volvo Assistance.



The assist button is located on the roof, to the right of the overhead console.

- 1 Press and hold the assist button for at least 2 seconds.



- The vehicle makes a voice call to Volvo Assistance. It also sends information, such as its location and status. The Volvo Assistance call center will try to communicate with you to find out what kind of help you need.

### Tip

If you leave the call view during the voice call, you can always press the phone widget to return to the call view again. You can also end the voice call in the call view.

If the voice call fails, the Volvo Assistance call center has the ability to respond based on information sent by the vehicle.

<sup>[1]</sup> Availability depends on region.

---

## 2.8. Emergency assistance

In an emergency, the vehicle can connect you to an emergency call center. This is done automatically in response to severe collisions or manually by pressing the SOS button on the roof. <sup>[1]</sup>

### Note

#### Strictly for emergencies

Situations that could require immediate emergency assistance include traffic accidents, acute illness and external threats.

#### Built to work after a collision

In order to call an emergency call center after a collision, the system must not be critically damaged. The system is designed to survive severe collisions and has its own backup battery in case the regular power supply fails.

When an emergency call is made, the following happens:

1. The vehicle makes a voice call to an emergency call center. It also sends information, such as its location and status.
2. The emergency call center will try to communicate with you to find out what kind of help you need.
3. If the voice call fails, the emergency call center has the ability to respond based on information sent by the vehicle.

### Automatic emergency response

The vehicle automatically attempts to contact an emergency call center if it registers a collision above a certain level of severity. <sup>[2]</sup>

### Note

#### Not an emergency?

If you need help on the road but aren't in an emergency situation, press the assist button  to call Volvo Assistance instead. Volvo Assistance can help you in certain situations, such as if your vehicle's battery runs out of charge, your vehicle breaks down or you get a flat tire.

<sup>[1]</sup> Availability varies between regions. Contact Volvo Support for more information.

<sup>[2]</sup> For example, when safety features such as airbags or seat belt pretensioners have deployed.

## 2.8.1. Calling emergency services with SOS button

A long press of the SOS button in the vehicle's ceiling connects you to an emergency call center.<sup>[1]</sup>

### Note

#### Strictly for emergencies

Situations that could require immediate emergency assistance include traffic accidents, acute illness and external threats.

#### Not an emergency?

If you need help on the road but aren't in an emergency situation, press the assist button  to call Volvo Assistance instead. Volvo Assistance can help you in certain situations, such as if your vehicle's battery runs out of charge, your vehicle breaks down or you get a flat tire.



The SOS button is located on the roof, to the left of the overhead console.

- 1 Press and hold the SOS button for at least 2 seconds.

**SOS** 

- > The vehicle makes a voice call to an emergency call center. It also sends information, such as its location and status. The emergency call center will try to communicate with you to find out what kind of help you need.

### Tip

If you leave the call view during the voice call, you can always press the phone widget to return to the call view again. You can also end the voice call in the call view.

If the voice call fails, the emergency call center has the ability to respond based on information sent by the vehicle.



 **Note**

If you press the SOS button for too long, it will restart the system.

<sup>[1]</sup> Availability may vary between regions.

---

## 3. Display, software and phone

Explore how to interact with your vehicle. Here's where you can find more information on your vehicle's display, connectivity features, sound and media, in-vehicle apps, software and voice control.



You can access most of your vehicle's functions via its display, but there's also plenty you can do by using your phone.

An internet-connected vehicle makes remote access possible and keeps the vehicle up to date by downloading software updates. Learn how everything is connected.

---

### 3.1. Display

The different areas of the display show you information related to the vehicle and your driving. You can also control many of the vehicle's functions by interacting with the display.



The display is divided up into two areas.

- ① The driver information area, which is always at the top of the display.
- ② The main area, which takes up most of the display.

The display sits in the middle of the dashboard.

 **Warning**

If the driver information area turns off, doesn't turn on or is only partially legible, you must not use the vehicle. This is because the driver will not receive warnings and vehicle status information shown in the driver information area, such as warnings and information relating to brakes, airbags or other safety systems. If there is an issue with the driver information area, contact an authorized Volvo workshop.

 **Important**

Do not use sharp objects on the display, as they may cause damage.

 **Tip**

You can change the theme and brightness of the display in settings.

## 3.1.1. Main area of the display

The content of this manual represents the status of the user manual at the time of printing and may not be completely valid in future instances. For more information refer to the first page for the complete disclaimer note.

You can control many of the vehicle's functions and view detailed information and notifications in the main area of the display.



The main area takes up the majority of the display, and you interact with it by touching the display.

Frequently used features such as climate, vehicle overview and the app library are available at the bottom of the main area.

Examples of functions that can be viewed and controlled via the main area of the display are:

- Navigation
- Media players
- In-vehicle apps
- Phone

---

### 3.1.1.1. Display views

Learn about some of the views that you can see in the main area of the display.

The different bars provide status information, display shortcuts to apps or quick controls, and allow you to navigate around the display views. The main views let you use and access navigation information, in-vehicle apps, climate, vehicle status and settings. There are also some specialized views for managing specific vehicle functions.

#### Display bars







The status bar is located at the top of the main area of the display, underneath the driver information area. It shows you symbols relating to the vehicle's status and apps, along with the time and outside temperature. You can press the right-hand of the status bar to access some quick controls for a selection of system settings, as well as to access the profile picker and settings view.

The bottom bar is your main way of navigating around the display views. By pressing the symbols, you can get to other views and functions as well as access the comfort view and activate the hazard warning flasher. The status bar and bottom bar are always visible, regardless of which view you're looking at.

In some views, you will see the contextual bar appear above the bottom bar. This bar contains shortcuts to recently used functions or apps that only appear when you can use them. Sometimes these shortcuts are replaced by quick controls, which allow you to control ongoing phone calls and media when the associated views or widgets aren't visible.

## Main views

The following list contains the main views that you will see and use in the main area of the display.

|                            |  |
|----------------------------|--|
| <b>Welcome view</b>        | The welcome view gives you quick access to some of the vehicle's functions and the profile picker when you get into the vehicle. It disappears when you start the vehicle.   |
| <b>Home view</b>           | The home view shows a large navigation map, and so it also works as the navigation view. There are widgets with quick controls for media and phone underneath the map. You can hide these widgets by pressing the home symbol and bring them back by pressing the symbol again. You can access the home view from other views by pressing the home symbol  in the bottom bar. |
| <b>App library</b>         | You can access in-vehicle apps and the app store in this view. To get to this view, press the app library symbol  in the bottom bar.  |
| <b>Climate view</b>        | You can change a variety of climate settings in this view, such as activating or deactivating defrosters and adjusting settings for air conditioning. The climate view is opened by pressing the fan symbol  in the bottom bar.   |
| <b>Vehicle overview</b>    | This view gives you access to quick controls and the vehicle status and settings views, as well as user profiles. These come together to give you an overview of the vehicle. You can get to the vehicle overview by pressing the vehicle symbol  in the bottom bar.  |
| <b>Quick controls view</b> | This view gives you quick and easy access to some of the vehicle's functions, such as exterior lights and door mirror adjustments. You can get to the quick controls view by pressing the vehicle symbol  in the bottom bar.  |
| <b>Vehicle status view</b> | This view shows you important information relating to your vehicle's status, such as issues that need to be resolved and their severity. You can also access the user manual, as well as see the total distance driven in the vehicle and when a service is due. You can access the vehicle status view by pressing the vehicle symbol  in the bottom bar.                  |
| <b>Settings view</b>       | This view is where you can access all of the different settings tabs and views for your vehicle. You can get to the settings view by pressing the vehicle symbol  in the bottom bar.  |

## Specialized views

The following views are related to specific functions in the vehicle.

|                     |  |
|---------------------|--|
| <b>Comfort view</b> | The comfort view appears when you press the temperature displayed in the bottom bar. This view gives you quick access to some essential climate and comfort settings, such as temperature control.   |
| <b>Volume view</b>  | You can adjust the volume for many types of sound in this view. To get to it, press the volume symbol  in the bottom bar.   |
| <b>Parking view</b> | The parking view contains features that help you park. When shown, it takes up most of the main display area. If the parking view doesn't automatically appear when you need it to, you can open it yourself by pressing the camera symbol in the contextual bar above the bottom bar. |

### Note

#### Driver distraction overlay

What you can see and do in the main area of the display sometimes depends on whether or not the vehicle is moving. To minimize driver distraction while the vehicle is moving, some views become unavailable, such as certain settings. When this happens, the display shows the driver distraction overlay. When the vehicle stops moving, the overlay disappears and you can interact with the view again.

## 3.1.1.2. Status symbols in the display

The content of this manual represents the status of the user manual at the time of printing and may not be completely valid in future instances. For more information refer to the first page for the complete disclaimer note.

Status symbols are shown in the status bar at the top of the main area of the display. The symbols tell you important information about your vehicle's system status.













## Symbol types

Some status symbols, such as the clock and temperature, will always be visible in the status bar. Others may be disabled or only visible when that particular function is active, such as wireless charging.

 **Note**

Make sure you look up any status symbols that you are unfamiliar with. They might not appear with any extra information or notifications.

This is a list of some status symbols that can appear in the status bar. It is not an exhaustive list, and you might also see status symbols in the status bar from third-party apps.

|   |                                    |  |
|---|------------------------------------|--|
|    | Clock                              | The clock shows you the current time. You can choose whether to display the time in the 12-hour or 24-hour format.   |
| 12:31   |                                    |  |
|    | Outside temperature                | This is the current ambient temperature outside the vehicle. You can choose to have the temperature displayed in degrees Celsius or Fahrenheit in the vehicle's system settings. |
| 8°C   |                                    |  |
|    | Outside temperature with snowflake | This is the current ambient temperature outside the vehicle. The snowflake appears when the outside temperature is low.  |
| -8°C *  |                                    |  |
|  | Microphone is listening            | The vehicle's microphone is active and recording.  |
|  | Microphone is not listening        | The vehicle's microphone is not recording.   |
|  | New notification                   | There is a new notification in the notification center.  |
|  | Wireless charging active           | A device is charging on the wireless charger.  |
|  | Bluetooth connected                | Bluetooth is enabled and a device is connected to the vehicle.   |
|  | Location                           | Your location is being shared.   |
|  | Wi-Fi signal                       | Wi-Fi is enabled and active. The number of bars indicates the signal strength. If no bars are shown, this indicates that a Wi-Fi connection is active but there is no signal.    |
|  | Mobile internet signal             | Mobile internet is active and being used by the vehicle. The number of bars indicates the signal strength.   |
|  | 5G internet                        | A 5G internet connection is active.  |

### 3.1.1.3. Keyboard

The display keyboard appears when you can write text or numbers. You can customize many of its features in settings.

You can use the on-screen keyboard to write text or numbers. For example, when searching for a destination in the navigation app or entering the password for a Wi-Fi network.

The keyboard layout can change depending on the type of input field you are writing in.

The keyboard supports some alternative ways of inputting text. These include:

- Glide typing
- Speech-to-text
- Handwriting



**Tip**

You can download other keyboards to use by going to the app store in the app library.

### 3.1.1.3.1. Changing the keyboard language

You can change the language for the display keyboard on the keyboard itself.

Change the keyboard language when you want to write text in a different language. This can be useful when you are driving abroad and need to search for a destination or address in the local language.

#### Note

To be able to change the keyboard language, you need to have more than one language available for the keyboard. If you only have one language available, the languages symbol won't be shown on the keyboard.

#### Changing language to the next available language

- 1 Press the languages symbol  at the bottom of the keyboard.
  - > The keyboard language switches to the next one in the available languages list.

#### Changing language to any available language

- 2 Press and hold the languages symbol  at the bottom of the keyboard.
  - > A list of available languages appears.
- 3 Select the language you want to use.
  - > The keyboard language changes to the one you selected.

---

### 3.1.1.3.2. Adding and removing keyboard languages

You can add and remove keyboard languages in settings.

You can add languages to the display's on-screen keyboard if you want to write in a language that isn't already available. Languages can also be removed from the keyboard if you find that you no longer need them.

- 1 Press the vehicle symbol  in the bottom bar and go to **settings**.
- 2 Go to **System** → **Language and input** → **Keyboard**.
- 3 Choose the keyboard you want to make changes to.
- 4 Select **Languages**.

#### Adding a language

Press the plus sign  above the currently available languages and search for your desired language.

The content of this manual represents the status of the user manual at the time of printing and may not be completely valid in future instances. For more information refer to the first page for the complete disclaimer note.



5  
6 Select the language you want to add, then press the download symbol .

➤ The language is added to the list of languages available to use on your keyboard.

#### Removing a language

7 Press the edit symbol  above the list of currently available languages.

8 Select the language you want to remove from the list of available languages, then press the trash can symbol .

➤ The language is removed from the list of languages available to use on your keyboard.

---

## 3.1.2. Driver information area of the display

The driver information area of the display shows you information related to your driving and the vehicle itself.



The driver information area is not touch sensitive, so you can't interact with it via the display's surface. You can interact with the driver information area using the steering wheel buttons.

Examples of information that can be shown in the driver information area include:

- Warning and indicator symbols
- Speed
- Road sign information
- Notification messages
- Battery meter
- Power meter

## Driver information area display modes

While driving, there are two display modes you can choose from: calm and surround. If the customizable button  on the steering wheel has the display mode switching function assigned to it, press the button to change display mode. You can read more about the steering wheel's customizable button in a separate section of the manual.

**Calm** This displays essential information, such as speed, battery level and range, as well as warning and indicator symbols.

**Surround** In this mode, you can see a depiction of the vehicle, its positioning on the road and other vehicles. The same essential information as calm mode is also displayed.

### Important

#### Using surround mode

Surround mode cannot perfectly depict what is really happening on the road around you, so do not rely on it when you are driving.

## 3.1.2.1. Warning and indicator symbols

The symbols in the driver information area tell you the status of different systems in your vehicle. Some indicate whether a system is active and operating as it should, and others alert you to important information or detected faults.

### Symbol types and colors

Some symbols are warnings that require immediate action, while others indicate the current status of specific functions. The symbol color roughly signifies the level of importance. Red symbols are the most critical, while amber symbols represent less urgent warnings and alerts. Symbols in other colors typically convey status information about the vehicle's functions.

### Tip

Be sure to look up the meaning of symbols you are unfamiliar with. Many symbols will appear with a notification providing more information.



Brake system warning

A fault is detected in the brake system. Take immediate action and contact an authorized Volvo workshop.



Parking brake warning

Continuous illumination indicates that the parking brake is engaged. Flashing indicates a parking brake fault.



Low battery voltage warning

The vehicle's battery has low voltage. Charge it as soon as possible.



Power system failure warning

A fault is detected in the vehicle's power system. Take immediate action and contact an authorized Volvo workshop.



Seat belt reminder





















Someone in the vehicle isn't wearing their seat belt.



Airbag fault warning

A fault is detected with the airbags.

|   |  |  |
|---|--|--|
|    | Charging cable connected                   | The charging cable is still connected to the vehicle.  |
|    | Power steering failure                     | The power steering system no longer works due to a fault. Stop driving as soon as it is safe to do so.   |
|    | Driver alert warning                       | Flashing indicates that the Driver alert function senses you are tired and should take a break as soon as possible. A constant illumination indicates that there is a fault detected with the Driver alert system. |
|    | Vehicle status warning                     | There is at least one critical level notification in the vehicle status view. Go to the vehicle status view to see what the issue is and resolve it as soon as possible.   |
|    | Evasive maneuver warning                   | Steering is temporarily enhanced during an evasive maneuver.   |
|    | Rear auto brake failure                    | There is a fault with the rear auto brake.   |
|    | Artificial external sound error            | There is an issue with the vehicle's artificial external sound.  |
|    | Rear radar system failure                  | There is a fault with the rear radar system. If the symbol flashes, it means that there is a calibration failure.  |
|    | Rear collision avoidance system failure    | There is an issue with the collision avoidance system at the rear of the vehicle.  |
|    | Lane keeping aid failure                   | There is an issue with the lane keeping aid function.  |
|  | Front wiper failure                        | A fault is detected with the front wipers.   |
|  | Brake system warning                       | A fault is detected in the brake system.   |
|  | Anti-lock braking system warning           | The anti-lock braking system is disengaged. The friction brakes still function but without anti-lock braking.  |
|  | Forward collision avoidance system warning | There is an issue with the collision avoidance system at the front of the vehicle.   |
|  | Tire pressure warning                      | Constant illumination indicates low tire pressure. If there is a system fault, the symbol will flash for a short while and then illuminate steadily.   |
|  | Electronic stability control alert         | Constant illumination indicates that there is a problem with electronic stability control. Flashing indicates that electronic stability control is intervening.  |
|  | Electronic stability control off           | Electronic stability control is turned off.  |
|  | Interior presence detection off            | The interior presence detection function is turned off.  |
|  | Reduced performance alert                  | The vehicle's performance is reduced.  |
|  | Rear fog light                             | The rear fog light is on.  |
|  | Driver alert system limitation             | Something is blocking the driver monitoring camera's view.   |
|  | Power steering fault                       | There is a fault with the power steering. The power steering system is working with reduced effect.  |

|   |                                      |  |
|---|--------------------------------------|--|
|    | Vehicle status warning               | There is an important vehicle status notification. Go to the vehicle status view to see what the issue is and resolve it as soon as possible.  |
|    | Hill descent control warning         | There is an issue with the hill descent control function and it is currently unavailable.  |
|    | Lane keeping aid off                 | Lane keeping aid is turned off, and lane keeping assistance is not provided.   |
|    | Manual leveling failure              | There is an issue with the manual leveling of the lights.  |
|    | Position lights failure              | There is an issue with the position lights.  |
|    | Passing beam failure                 | There is an issue with the passing beam.   |
|    | Automatic high beam failure          | There is an issue with the automatic high beam.  |
|    | Manual high beam failure             | There is an issue with the manual high beam.   |
|    | Automatic high beam on               | The automatic high beam is on.   |
|    | Manual high beam                     | The manual high beam is on.  |
|   | Left turn signal                     | The left turn signal is active and indicating a left turn. When there is a fault with the turn signal, the symbol flashes twice as fast.   |
|  | Right-hand turn signal.              | The right turn signal is active and indicating a right turn. When there is a fault with the turn signal, the symbol flashes twice as fast.   |
|  | Parking lights                       | The position lights are on.  |
|  | Passing beam is active               | The passing beam is on.  |
|  | Automatic hold is active             | The automatic hold braking function is active. The vehicle automatically brakes while stationary.  |
|  | Hill descent control is active       | The hill descent control function is active and working.   |
|  | Rear radar system active and working | The rear radar system is active and working normally.  |
|  | Ready                                | The ready symbol appears when you put the vehicle in a driving gear. It disappears when the vehicle's speed exceeds walking pace. It reappears whenever the vehicle slows down below the same threshold. |
|  | Automatic high beam enabled          | The automatic high beam is enabled and available to use.   |
|  | Rain sensor                          | The rain sensor is active and the front wipers are in auto mode.   |
|  | Driver alert                         | The Driver alert function senses you are tired and should take a break.  |



Towbar unlocked

The towbar is unlocked.

[1]



Hill descent control enabled

The hill descent control function is enabled but not currently active.

[1]



Trailer fault

There is a fault with the trailer.

[1]



Trailer light fault

A fault was detected with the trailer lights during the trailer light check.

[1]

[1] Depending on the vehicle's current theme, this symbol can be a different color.

---

## 3.1.2.2. Battery meter

The battery meter shows the charge level percentage and estimated range of your vehicle.



380 km  80%

The battery meter is shown in the driver information area at all times. The battery icon's color changes depending on the level of charge remaining on the battery.

### Remaining battery

The battery percentage indicates the level of charge left in your vehicle's battery. The estimated range tells you how far you can drive with the battery's current charge level.

 **Note**

Driving style and external factors, such as outside temperatures and driving for prolonged periods at high speeds, can have different effects on the estimated battery range.

### Cold battery indicator

The content of this manual represents the status of the user manual at the time of printing and may not be completely valid in future instances. For more information refer to the first page for the complete disclaimer note.

When the vehicle has a cold battery, a snowflake ❄️ appears next to the battery icon. This indicates that the battery's charge capacity and range are reduced compared to normal conditions.

When the battery warms up, for example when driving, the snowflake disappears from the driver information area of the display.

---

## 3.1.3. System settings

You can change the system settings so that the vehicle displays information in a way that suits you.

There are a number of system settings that you can change, including:

- System language
- Date and time
- Units of measurement
- Keyboard languages

---

### 3.1.3.1. Changing date and time

You can manually change the date, time and local time zone in settings.

By default, your vehicle uses information from the internet to automatically change the date, time and local time zone for you. You can also manually change these yourself, as well as the time format in settings.

- 1 Press the vehicle symbol  in the bottom bar and go to **settings**.
- 2 Go to **System** → **Date and time**.
- 3 If **Automatic date and time** and **Automatic time zone** are enabled, turn them off.
- 4 Select your desired setting and make any changes.
  - The changes are shown in the display.  
The clock in the status bar updates if you make changes to the time setting.



Tip

To change the time format, turn it on for 24-hour format or off for 12-hour format.

## 3.1.3.2. Changing the system language

You can change the language of the vehicle's system in settings.

If you want your vehicle's systems to use a language that is different from the current language, you need to change the system language.

### Important

Only select a system language that you can fully understand. The vehicle communicates safety-critical information and notifications to you through messages, so you need to be able to understand them at all times.

- 1 Press the vehicle symbol  in the bottom bar and go to **settings**.
- 2 Go to **System** → **Language and input** → **Language**.
- 3 Choose the language you want to change to.
  - > The new language is shown in the display.

---

## 3.1.3.3. Changing system units

You can go to setting to changes the units of measurement, such as for speed and distance.

### Tip

When driving abroad, it can be useful to change the vehicle's units of measurement to match the local ones. It can be especially helpful if road signs display distances and speeds in units that are different from those currently displayed in your vehicle.

- 1 Press the vehicle symbol  in the bottom bar and go to **settings**.
- 2 Go to **System** → **Units**.
- 3 Select the units of measurement you want the vehicle to display.
  - > The vehicle displays units in the new format.

## 3.1.4. Restarting the display

You can restart the display using specific buttons on the steering wheel.

If you are having problems with the display, such as it freezing or the vehicle not being able to connect to the internet, you might be able to resolve these issues by restarting it.

To restart the display, the vehicle must be at a standstill with the parking brake applied.

- 1 Simultaneously press and hold the decrease set speed — and decrease volume ▾ buttons on the steering wheel until the display changes.  
  
> The display restarts.

---

## 3.2. Phone

Connect your phone to the vehicle via Bluetooth to be able to use it while driving. When you are away from your vehicle, you can also use your phone to read the manual or use certain features remotely via the mobile app for the vehicle.

### Connect your phone to your vehicle

Connecting your phone to the vehicle via Bluetooth allows you to use it through the vehicle's interface. You can also stream media directly from your phone to the vehicle.

You can use voice control or the display to search for your contacts, make and receive phone calls, and respond to text messages without even touching your phone.

### Other uses for your phone

Using your phone with your vehicle isn't limited to just when you're inside the vehicle. Download the mobile app to remotely use certain vehicle functions or read the user manual when you're away from the vehicle.

---

## 3.2.1. Connecting your phone to the vehicle

Connect your phone to the vehicle via Bluetooth to use your phone through the vehicle's interface.

Bluetooth must be enabled for both the vehicle and your phone for them to be able to pair. You can turn Bluetooth on in settings. Make sure that your phone is set as discoverable so that the vehicle can find it when pairing.



- 1 Press the vehicle symbol  in the bottom bar and go to **settings**.
  - 2 Go to **Connectivity** → **Bluetooth**.
  - 3 Select **Add** to start the pairing process.
  - 4 Choose the device you want to pair the vehicle with from the list of available devices.
  - 5 Check that the confirmation code in the display matches the one shown on your phone.
  - 6 Select your preferred services, then press **Save**.
  - 7 Grant the vehicle permission to access your phone in your phone's Bluetooth settings and via the display.<sup>[1]</sup>
- Your phone is now connected to the vehicle. It will automatically connect next time, as long as Bluetooth is enabled on your phone.

 **Note**

You can have multiple phones paired with the vehicle, but only one can be connected to the vehicle at a time. To change the active phone, select it from the list of paired devices or add a new device.

<sup>[1]</sup> You can still connect your phone to the vehicle even if you don't allow the vehicle to access your contacts, but there will be reduced functionality.

---

## 3.2.2. Using your phone in the vehicle

You can use your phone via the display and voice control.

 **Important**

Make sure that you comply with all local laws and regulations regarding mobile phone use while driving.

 **Note**

You need to connect your phone to the vehicle via Bluetooth and accept the corresponding phone settings permissions to be able to use these features.

## Calling





There are a few different ways you can make and receive phone calls while in your vehicle. You can:

- accept and reject incoming calls using the display
- call someone while driving by asking the digital assistant to make the call for you

The content of this manual represents the status of the user manual at the time of printing and may not be completely valid in future instances. For more information refer to the first page for the complete disclaimer note.

- use the in-vehicle phone app via the display to call contacts, or type a phone number in using the on-screen keypad.

When you have an ongoing call, it will be shown in the display. If you open the in-vehicle phone app when you have an ongoing call, you can:

- mute and unmute your microphone 
- change the sound input and output, such as through the vehicle or your mobile phone's microphone and speakers 
- end the call 
- use the keypad to input numbers, such as when asked to select an option in a service menu .

If you receive a second phone call while in the middle of an ongoing call, answering the second phone call automatically puts the first one on hold. However, you can switch between the two calls .

## Messaging

You can write and send text messages via the digital assistant using voice control<sup>[1]</sup>. If you receive a text message, a notification will appear in the display with the following options:

- **Play** to hear the digital assistant read the message out loud.
- **Mute** to stop receiving new message notifications from this specific conversation for the rest of the time you are in the vehicle.

You can also ignore the notification and view it later in the notification center.

## Looking through and searching for your contacts

Use the in-vehicle phone app to search for a specific contact by:

- pressing the search symbol 
- going to the contacts tab and typing their name
- going to the keypad tab and entering their number.

You can also just ask the digital assistant to find the contact you are looking for.

<sup>[1]</sup> Only applies to Android phones or phones with iOS 13 or later.

---

## 3.2.3. Switching between paired phones

You can change which Bluetooth-paired phone the vehicle is connected to in settings.

The vehicle can connect to and remember multiple phones, but it can only be actively connected to one phone at a time.

If you want to switch the Bluetooth connection to a new device, you need to pair it with the vehicle first. You can do this in settings.

Before trying to switch to a different paired device, make sure that Bluetooth is enabled on the device you want to switch to.

- 1 Press the vehicle symbol  in the bottom bar and go to **settings**.
- 2 Go to **Connectivity** → **Bluetooth** → **Saved devices**.
- 3 Press the name of the phone you want to connect to.
  - If the connection is successful, the phone's name moves to the top of the saved devices list.

If you can't see the device you want to switch to in the saved devices list, try pairing it with the vehicle again.

---

## 3.2.4. Apple CarPlay

Activate Apple CarPlay to use your iPhone wirelessly via the vehicle.

Apple CarPlay gives you another way of using your iPhone via the vehicle's interface. You can use certain communication, navigation and media apps on your iPhone via the main area of the display, as well as voice control.

### Important

#### Local laws and regulations

Make sure that you comply with all local laws and regulations regarding mobile phone use while driving.

#### CarPlay content

Volvo does not accept responsibility for the content available in Apple CarPlay.

### Note

#### Phone compatibility and supported apps

Apple CarPlay only works with iPhones, but it doesn't work with all iPhone models. To find out if your iPhone is compatible or to learn more about which apps are supported, go to Apple's website [www.apple.com/ios/carplay](https://www.apple.com/ios/carplay) [<https://www.apple.com/ios/carplay>].

### Tip

Keep your iPhone and apps updated to the latest versions.

## Connect your iPhone and start CarPlay

The content of this manual represents the status of the user manual at the time of printing and may not be completely valid in future instances. For more information refer to the first page for the complete disclaimer note.

Connect your iPhone to the vehicle via Bluetooth and activate Apple CarPlay. After setting up CarPlay for the first time, it automatically starts when you connect your phone via Bluetooth again.

## CarPlay view

You can access the CarPlay view by opening the CarPlay app in the app library. If the CarPlay symbol  is shown in the contextual bar, you can also access the view by pressing this symbol.

Once active, the CarPlay view takes up the whole of the main area of the display. However, the bottom bar, contextual bar and status bar will still be visible at all times if you want to return to the vehicle's own system.

## Navigation with CarPlay

You can use navigation apps on your iPhone via Apple CarPlay. If you start a navigation route via CarPlay, you can see the guidance in the display's CarPlay view.

## Using Siri

If you want to use Siri instead of the vehicle's in-built digital assistant, press and hold the voice control button  on the steering wheel while CarPlay is active.

You can use Siri to read out, write and send messages. Siri will read and write messages in the language selected in the Siri settings on your iPhone. If you write a message via Siri, the vehicle's display won't show you your message, but it will be displayed on your iPhone.

---

### 3.2.4.1. Connecting your iPhone to Apple CarPlay

Connect your iPhone to the vehicle via Bluetooth to start using Apple CarPlay.

Bluetooth must be enabled for both the vehicle and your phone for them to be able to pair. You can turn Bluetooth on in settings. Make sure that your phone is set as discoverable so that the vehicle can find it when pairing.

To be able to use CarPlay, you need to activate Siri on your iPhone and have an active internet connection. You also need to turn the vehicle's Wi Fi off, as CarPlay can't be active while Wi Fi is enabled.

- 1 Press the vehicle symbol  in the bottom bar and go to **settings**.
- 2 Go to **Connectivity** → **Bluetooth** → **Add new device**.
- 3 Press **Add** to search for your iPhone.
- 4 Select your iPhone from the list of discovered devices.
- 5 Check that the confirmation code in the display matches the one shown on your phone.
- 6 On your iPhone, consent to using CarPlay.
- 7 In the vehicle's display, read and accept CarPlay's terms and conditions.

- Your iPhone will connect to CarPlay, and the CarPlay view will open in the vehicle's display. A CarPlay symbol  also appears in the status bar to indicate that CarPlay is active.

CarPlay automatically starts the next time you connect your iPhone via Bluetooth.

 **Tip**

You can disconnect from CarPlay but keep your iPhone connected to the vehicle by pressing the CarPlay symbol  next to your device's name in the vehicle's Bluetooth settings.

## 3.2.5. Android Auto™

Connect your phone via Bluetooth and activate Android Auto™ to use your Android™ phone through the vehicle.

Android Auto gives you another way to use your Android phone via the vehicle's interface. With Android Auto, you can safely access your phone's communication, navigation and media apps via the display, as well as via the steering wheel buttons.

 **Important**

### Local laws and regulations

Make sure that you comply with all local laws and regulations regarding mobile phone use while driving.

### Android Auto content

Volvo does not accept responsibility for the content available in Android Auto.

 **Note**

### Phone compatibility and supported apps

Android Auto only works with Android phones, but it doesn't work with all phone models. To find out if your phone is compatible or to learn more about which apps are supported, go to Android Auto's website [www.android.com/auto/](https://www.android.com/auto/) [<https://www.android.com/auto/>].

### Google Trademarks and compatibility

Google, Android and Android Auto are trademarks of Google LLC. Compatible Android phone and compatible active data plan required.



Tip

### Keep your phone updated

Keep your phone and apps updated to the latest versions.

## Connect your phone and start Android Auto



Note

Install Android Auto on your phone and make sure you have an active internet connection

To be able to use Android Auto, you need to have the Android Auto app installed on your phone and an active internet connection.

Connect your phone to the vehicle via Bluetooth. If you are using Android Auto for the first time, you need to accept the terms and conditions in the display, then Android Auto will start. If you have used Android Auto before, it will automatically start when you connect your phone to the vehicle.

### Android Auto view

You can access the Android Auto view by opening the Android Auto app in the app library. If the Android Auto symbol  is shown in the contextual bar, you can also access the view by pressing this symbol.

Once active, the Android Auto view takes up the entire main area of the display. However, the bottom bar, contextual bar and status bar will still be visible at all times if you want to return to the vehicle's own system.

### Navigation with Android Auto

You can use navigation apps on your phone via Android Auto. If you start a navigation route via Android Auto, you can see the guidance in the main area of the display's Android Auto view. If you are following a navigation route in the vehicle's own navigation app and then start another navigation route in Android Auto, the navigation for the vehicle's own app will end.

### Using Google Assistant

Talk to Google Assistant on Android Auto to carry out tasks with your voice so that you can keep your focus on driving. To use Google Assistant, just say "Ok Google" or press and hold the voice control button  on the steering wheel while Android Auto is active.

You can use Google Assistant to carry out tasks such as sending messages, getting directions or controlling media.

---

## 3.3. Sound and media

Listen to music and media through the vehicle's sound system. You can adjust how it sounds in settings.

### Sound settings

The sound settings allow you to change and adjust a variety of sound options.

## Radio and media players

You can listen to live radio via the pre-installed radio app and stream media from your phone to the vehicle via the Bluetooth media player.

### Tip

You can find and download more third-party media apps via the vehicle's app store.

## Controlling media playback

You can control media playback in a number of ways by using:

- media playback controls in the display
- the steering wheel buttons
- voice control.

## 3.3.1. Radio

Use the pre-installed radio app to listen to live radio in your vehicle.

### Radio favorites

You can add stations to your radio favorites list for quicker access.

### Tip

You can find and download other radio apps via the app store.

### 3.3.1.1. Adding radio favorites

You can add radio stations to the favorites list in the radio app.

Add the radio stations you listen to frequently to the favorites list for quicker access. You can add up to 50 radio stations to the list.

- 1 Press the app library symbol  on the bottom bar and open the radio app.
- 2 Find the station you want to add as a favorite from the list of currently available radio stations.

The content of this manual represents the status of the user manual at the time of printing and may not be completely valid in future instances. For more information refer to the first page for the complete disclaimer note.

3 Press the star symbol ☆ to the right of the station name.

➤ The appearance of the station's star symbol changes and the radio station appears in the favorites list.

If you want to remove a station from the favorites list, just press the star next to its name.

---

## 3.3.2. Sound settings

You can change and adjust a variety of sound options in settings.

The sound settings view has two tabs: audio and volume.

### Audio tab

|                              |   |
|------------------------------|---|
| <b>Sound focus</b>           | You can choose from three sound focus settings: all, driver and rear. All is the default setting and doesn't focus the sound in a particular direction. It provides a neutral sound focus where occupants in the front and rear seats have the same sound experience. The driver setting focuses the sound towards the driver, while the rear setting focuses sound towards the rear seats. |
| <b>QuantumLogic surround</b> | QuantumLogic surround gives you a surround sound experience. You can choose QuantumLogic surround to be low, medium or high, or simply turn it off.   |
| <b>Equalizer</b>             | Access the equalizer settings in the audio tab by pressing Equalizer. You can change the tone of the in-vehicle sound using the six adjustment levels, as well as adjust the subwoofer. There are also four EQ presets available to choose from: Dynamic, Soft, Voice and Custom. When Custom is selected, you can reset the equalizer values back to 0 by pressing Reset custom.           |

### Volume tab

In this tab, you can adjust the volume for the following:

- Media
- Ringtone
- Call
- Voice assistant
- Navigation
- Notifications
- Parking assistance

The noise compensation setting automatically adjusts the sound volume inside the vehicle according to the level of noise outside the vehicle. You can select low, medium and high compensation levels or turn the feature on or off.

You can also turn display touch sounds on or off in this tab.

---

## 3.3.3. Media players



Your vehicle comes with a pre-installed media player. You can download more third-party media apps from Google Play in the app library.

Your vehicle comes with the Bluetooth media player pre-installed in the app library.

Use the Bluetooth media app to stream media from a Bluetooth-connected device straight to the vehicle.

---

## 3.4. In-vehicle apps

All of the vehicle's apps can be found in the app library.

You can access the app library by pressing its symbol in the bottom bar.



App library symbol

The apps in the library are shown in chronological order, starting with the app installed first and ending with the most recently installed app.

Some apps are pre-installed, such as Bluetooth media, Google Maps and Google Assistant. You can search for and download new apps via Google Play, which can be accessed in the app library.

---

### 3.4.1. Downloading apps

Download more apps to your vehicle from the app store in the app library.

Your vehicle comes with some apps pre-installed, but you can find and download more in the app store.

- 1 Press the app library symbol  in the bottom bar.
  - 2 Press **Get more apps** to go to the app store.
  - 3 Search for the app you want to download.
  - 4 Download and install your desired app.
- If the app is successfully downloaded and installed, it appears in the app library.
-

## 3.4.2. Uninstalling apps

You can uninstall apps you no longer want or use in the app library.

### Note

Pre-installed apps, such as phone and radio, can't be uninstalled.

- 1 Press the app library symbol  in the bottom bar.
- 2 Find the app you want to uninstall, then press and hold the app until a menu appears.
- 3 Select **Uninstall** from the menu.
- 4 Press **Ok** to continue uninstalling the app.
  - The app is uninstalled and disappears from the app library.

---

## 3.5. Connectivity and software

Connect your vehicle to the internet to get more from your vehicle and receive over-the-air software updates.

### Internet connectivity

Connect your vehicle to the internet via Wi-Fi or the vehicle's in-built mobile network connection.

### Software updates

Over-the-air updates keep your vehicle's software up to date.

---

## 3.5.1. Internet connection

Connecting your vehicle to the internet gives you access to more features and over-the-air software updates.

There are a few ways to connect your vehicle to the internet. When the vehicle can access the internet in more than one way, it prioritizes them in the following order:

- Wi-Fi network
- Mobile network

### Wi-Fi

The content of this manual represents the status of the user manual at the time of printing and may not be completely valid in future instances. For more information refer to the first page for the complete disclaimer note.

You can connect the vehicle to a Wi-Fi network for internet access. The vehicle can automatically connect to the network whenever it is within range.

## Mobile network

Your vehicle has a built-in modem for connecting to a mobile network. As long as the vehicle has an active mobile network service plan and it's in an area with network reception, it can connect to the internet. Contact an authorized Volvo workshop for information about mobile connectivity services for your vehicle.

The vehicle supports mobile networks up to, and including, 5G. The available mobile network speeds depend on the SIM card installed in your vehicle.

### Note

#### Mobile network connectivity conditions and limitations

- The vehicle needs to be in an area with mobile network reception.
- Mobile connectivity services must be active for the region where the vehicle is located.
- Obstacles such as buildings, hills and mountains can weaken or block the mobile network signal.

## Internet connection settings

You can find the connectivity settings in the display.

---

### 3.5.1.1. Connecting to the internet via Wi-Fi

Connect your vehicle to a Wi-Fi network for internet access.

- 1 Press the vehicle symbol  in the bottom bar and go to **settings**.
  - 2 Go to **Connectivity** → **Wi-Fi**.
  - 3 Enable Wi-Fi if it is disabled.
  - 4 Select the Wi-Fi network you want to connect to.
  - 5 Enter the Wi-Fi network password using the display keyboard and press **Connect**.
- The vehicle connects to the Wi-Fi network.

---

### 3.5.2. Over-the-air updates

The content of this manual represents the status of the user manual at the time of printing and may not be completely valid in future instances. For more information refer to the first page for the complete disclaimer note.

Over-the-air updates keep your vehicle's software up to date.

 **Note**

To enable over-the-air<sup>[1]</sup> updates, you must accept the OTA consent in the mobile app for the vehicle during onboarding or in the app's privacy settings. You cannot enable updates or consent to them via the vehicle display.

When your vehicle is connected to the internet, it can receive over-the-air updates to keep the vehicle's software up to date. When you have enabled software updates in the mobile app, the vehicle will automatically download the updates and tell you when they can be installed. You will get installation notifications via the app and the vehicle's display.

You can also check for new software updates by going to **System** → **Software update** in settings.

## Installing software updates

When a new software update is available, the vehicle will automatically download the update, but it won't install it for you. You need to start the installation yourself, either via the mobile app for the vehicle, a notification in the display or in the software update view. The notification only appears in the display when you put the vehicle into P and unbuckle your seat belt. You can cancel the installation after confirming it if you change your mind about installing the update.

You can't access or use your vehicle while a software update is installing. Therefore, make sure that there is approximately 50% battery charge remaining and that you don't need to use your vehicle during the installation process. The vehicle will give you an estimation for how long it will take to install the update.

 **Important**

There might be updates that you can't install yourself. If this happens, contact an authorized Volvo workshop to book a service.

If there is a critical update failure, avoid driving the vehicle and call roadside assistance to take you to an authorized Volvo workshop.

 **Note**

You can't install software updates while the reduced alarm sensitivity setting is active.

## Scheduling updates

If you want to install an update at a later time, you can schedule the installation in both the mobile app and the display. Scheduling an update sets a timer for when you want the vehicle to attempt to install the update: for example, in 4 hours' time. The maximum amount of time you can schedule an update for is 24 hours.

<sup>[1]</sup> OTA

## 3.6. Voice control

Keep your hands on the wheel and use your voice to interact with the vehicle via the digital assistant.

With the help of the digital assistant, you can use voice control to carry out tasks, such as searching the internet and getting weather forecasts. You can also use your voice to interact with the vehicle and control a number of its functions, including:

- Media player
- Phone
- Navigation
- Climate

### Speaking to the digital assistant

The assistant understands everyday speech, so you don't need to know any specific voice commands to use it. You can ask the assistant anything, and it responds by confirming what you said, then doing what you asked. It will let you know if it doesn't understand you.

#### Note

- The voice control feature is from a third-party supplier. Availability, how to use it and how it works may vary over time and between regions.
- A poor internet connection may limit the number of available functions.

### 3.6.1. Using voice control

Use your voice to control and interact with a number of the vehicle's functions via the digital assistant.

The only time you need to use specific voice commands to interact with the digital assistant is when you activate it. After activating the assistant, just speak or give instructions to it using everyday phrases.

#### Note

Google Assistant isn't available in every language yet. Find out more at [support.google.com](https://support.google.com) [<https://support.google.com>] or try to use another language if you can.

- 1 Say "Ok Google" or "Hey Google" to activate Google Assistant.
  - > The assistant confirms that it's listening.
- 2 Speak or give instructions to the digital assistant using everyday phrases.



Tip

### Other ways to activate

You can also activate the digital assistant by pressing the microphone button  on the right-hand side of the steering wheel and via the display.

### Sign in to your Google account

If you sign in with a Google account, Google Assistant will be more personalized when the vehicle is online. For example, you can easily call contacts stored in your Google contacts or check what's in your Google Calendar.

## 4. Interior comfort and climate

Get familiar with your vehicle interior and the controls for seat adjustment, climate and windows.

Your vehicle is equipped with multiple features to assist you in your driving. While some features are mainly for comfort, others improve visibility. Reading this section of the manual can assist in making your driving experience more comfortable.

---

### 4.1. Interior

Get to know the interior layout and its practical features, such as cup holders and charging ports for your devices.

#### Interior walk-through

It's good to know the names and locations of a few places and components, as they are referenced throughout the manual.

|                              |   |
|------------------------------|---|
| <b>Passenger compartment</b> | The passenger compartment is divided into the front and rear passenger compartment.   |
| <b>Trunk</b>                 | The trunk, or cargo area, is the space behind the rear seats, which you typically access from behind the vehicle.   |
| <b>Dashboard</b>             | The dashboard refers to the whole set of panels and components in front of the driver and front passenger. It has some of your vehicle's main interaction areas, such as the display, steering wheel, USB ports, air vents and glove compartment. |
| <b>Center armrest</b>        | The center armrest sits between the front seats, above the center console. This is where you'll find the controls for windows and locks, storage compartments, a cup holder and a rearward-facing utility panel.                                  |
| <b>Overhead console</b>      | The overhead console sits on the roof against the windshield. It provides easy access to certain important functions and status indicators.   |

#### Note

##### Using the cup holder

To access the cup holder, push the lower front section of the center armrest and let go. The cup holder will slide out fully.

The cup holder tray needs to be handled carefully to avoid damaging it. It retracts in two steps, one for each cup hole. It's important to slide it back one cup hole at a time. Do not try to force the tray back in one motion.

---

#### 4.1.1. Using the wireless charger

Use the wireless charger to charge Qi-certified devices, such as a phone.



The wireless charger under the display

To use the wireless charger, your device should be certified to the Qi wireless charging standard. Also make sure that wireless charging is enabled on the device<sup>[1]</sup> you want to charge.

 **Warning**

Wireless charging may affect the operation of a pacemaker or other implanted medical devices. If you have one, consult your doctor before using the wireless charging system.

 **Important**

### Signal disturbances

The vehicle uses electromagnetic fields, Bluetooth and NFC<sup>[2]</sup>. These signals may cause disturbances in other devices at certain distances. Make sure you are aware of what these issues may be. You can read more about different specifications in their separate sections in this manual.

### NFC cards and charging

Avoid storing cards or keys with NFC near the wireless charger when using the charging function, as this could damage them.

Before charging a device, make sure there are no other objects on the charger.

- 1 Place the device in the middle of the charger.
- The device starts charging.



 **Warning**

Never leave your phone on the wireless charger when you leave the vehicle.

 **Note**

- Your results may differ when charging different devices: For example, the time it takes before charging starts and how quickly a device is fully charged.
- Your device might get hot during charging. This is normal and nothing to worry about. If the device battery gets too hot, charging is deactivated.

## If the device doesn't charge

If your device doesn't charge when placed on the charger, here are some steps you can try:

- Make sure there are no items on the charger apart from the device you want to charge.
- Lift the device and then place it back in the middle of the charger.
- Remove any cases or covers from the device.

<sup>[1]</sup> Many Qi-certified devices are always enabled

<sup>[2]</sup> Near-Field Communication

---

## 4.1.2. USB ports

You can use your vehicle's USB ports to charge phones, tablets, and other devices.

## Location of the USB ports



USB port locations.

There are two USB ports <sup>[1]</sup> under the display.

There are also two USB ports <sup>[1]</sup> in the rear part of the center console.

## Using the USB ports

Always disconnect devices from the ports when not in use.

Some devices may become hot during charging. This is normal.

The vehicle turns off power to the USB ports automatically when you leave the vehicle. If you leave the vehicle unlocked, the outlet remains active for a while longer before turning off.

### Tip

If you would like to keep the USB ports active while parked, read about parking comfort in this manual. When this function is on, the USB ports will continue to provide power even if the vehicle is locked.

## USB port specifications

- Type C port
- Version 3.0
- Normal charge
  - Voltage supply 5 V
  - Current supply max. 3.0 A
- Quick charge
  - Voltage supply 9 V
  - Current supply max. 2.0 A

The content of this manual represents the status of the user manual at the time of printing and may not be completely valid in future instances. For more information refer to the first page for the complete disclaimer note.

### 4.1.3. 12 V socket

You can use the 12 V socket to power various electrical devices, such as a cool box.

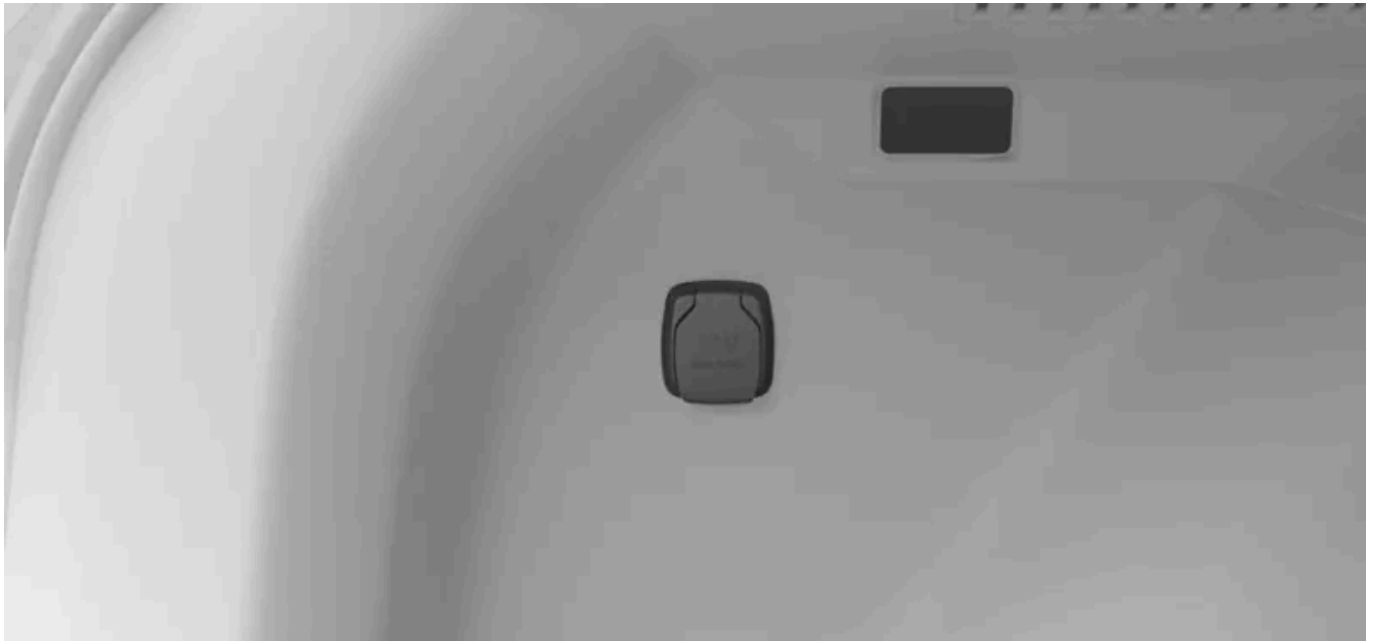

12 V outlet.

The 12 V electrical outlet is on the left-hand in the trunk.

The vehicle turns off power to the outlet automatically when you leave the vehicle. If you leave the vehicle unlocked, the outlet remains active for a while longer before turning off.

**i** Tip

If you would like to keep the 12 V outlet active while parked, read about parking comfort in this manual. When this function is on, the 12 V outlet will continue to provide power even if the vehicle is locked.

Always disconnect devices from the outlet and close the cover when not in use.

Some devices may become hot when charged through the 12 V outlet. This is normal for many devices.

 **Warning**

Failure to observe the following instructions could cause damage or personal injury.

- Do not use electrical devices with large, heavy plugs. They can damage the outlet or come loose while driving.
- Do not use electrical devices that could interfere with the vehicle's systems, such as the radio receiver.
- Only connect undamaged and fully working devices that meet all relevant safety standards<sup>[1]</sup>.
- Keep an eye on connected devices to prevent damage or injury if they malfunction.
- Do not connect adapters or extension cables to the 12 V socket, as they can override the socket's safety features.
- Do not expose the socket, connectors, or connected devices to water or other liquids.
- Do not touch or use the socket if it appears to be damaged or has come into contact with water or other liquids.

## Power rating

 **Important**

The maximum power draw is 120 W (10 A).

<sup>[1]</sup> CE marking, UL marking or similar compliance marking

## 4.1.4. Sun visors

There are sun visors overhead in front of the driver's seat and the front passenger seat.



You can fold the visors down and angle them to the side to block sunlight coming from the side of the vehicle.

There is also a mirror in the sun visor with a protective cover.

---

## 4.2. Comfort

Your vehicle has several features designed to enhance your comfort while driving or parked.

While many of your vehicle's features are designed to enable safe driving practices, others are more focused on enhancing your comfort. This includes certain climate features and comfort modes.

### Climate

Your vehicle has the ability to provide a comfortable climate in the passenger compartment. It can cool, heat and dehumidify the air for you when needed. There are also built-in features for providing good air quality.

Many of the climate features are automatic while others can be adjusted manually.

### Seats

The front seats of your vehicle are adjustable. While a good driving posture is necessary for visibility and safe driving practices, adjusting your seat also enables better comfort while driving or parked.

In colder temperatures, it's nice to heat your seat for a more comfortable driving experience. You can activate and adjust seat heating via the center display.

### Heated steering wheel

The steering wheel has built-in heating, which can provide comfort in colder temperatures. You can activate and adjust the steering wheel heating via the display.

### Refresh mode

When you turn on refresh mode, the air conditioning starts and quickly refreshes the air in the passenger compartment. This can be especially nice on longer drives.

### Relax mode

Relax mode can be activated to create a relaxing atmosphere in the vehicle while parked. When you activate this mode, the driver seat reclines, the interior lights dim or turn off, and your vehicle locks. You can activate relax mode in the display.

### Parking comfort

Parking comfort allows you to maintain a comfortable interior climate in your vehicle while parked. This includes keeping the climate functions and the entertainment system on. You can activate the parking comfort function via the display. Just be aware that range may be affected if you leave this setting on for too long.

---

## 4.2.1. Activating refresh mode

You can turn on refresh mode to quickly cool the air in the vehicle.

When you turn on refresh mode, the air conditioning starts and quickly refreshes the air in the passenger compartment. This can be especially nice on longer drives.

- 1 Press the vehicle symbol  in the bottom bar and go to **Settings**.
- 2 Go to **Controls** → **Car modes** → **Comfort**.
- 3 Go to **Refresh** and press **Start**.

The refresh mode will automatically turn off when the maximum running time is reached. You can also turn it off manually via the display by pressing **End**.

---

## 4.2.2. Activating relax mode

Activate relax mode to create a relaxing atmosphere when parked. You can do this via the display.

When you activate relax mode:

- the driver seat position adjusts and the back reclines
- the interior lights are dimmed down
- all closed doors are locked
- the windows close.



### Customize your relaxing experience

You can adjust your seat position and how much it reclines while relax mode is active using the seat adjustment controls. Your settings are saved and applied the next time you activate relax mode.



Never leave a child or pet unattended in your vehicle. You are responsible for their safety and well-being.

Before activating relax mode, make sure that the back seats are free from items and passengers so that the front seats can safely tilt back.

- 1 Press the vehicle symbol  in the bottom bar and go to **Settings**.
  - 2 Go to **Controls** → **Car modes** → **Comfort** → **Relax**.
  - 3 Set the timer for how long you want relax mode to stay on.
  - 4 Press **Start**.
- Relax mode is activated.

Relax mode turns off automatically when the set time limit is reached, when you start to drive, or when your vehicle's battery level reaches 20%. You can also turn it off manually via the display by pressing **End**.

---

## 4.3. Climate

Your vehicle has the ability to provide a comfortable climate in the passenger compartment. It will cool, heat and dehumidify the air for you when needed. There are also built-in features which will provide good air quality.

This section of the manual covers the various climate features in your vehicle, such as air conditioning, climate modes and heating options.

---

### 4.3.1. Climate controls

You can control the vehicle's interior climate through various means, both from inside the vehicle and from your phone.





Defroster button in the overhead console



The mobile app

You can control the vehicle's interior climate here:

- The display
- The overhead console
- The mobile app for the vehicle.

Most of your vehicle's climate settings can be found in the display. However, there is, one physical button in the overhead console which controls the defroster.



**Tip**

Use the mobile app for the vehicle to remotely precondition your vehicle. That way, you can ensure a comfortable interior climate when it's time to go for a drive.

### 4.3.1.1. Activating seat heating

You can activate the seat heating function via the comfort view in the display.

In colder temperatures, it's nice to heat your seat for a more comfortable driving experience. You can activate and adjust the seat heating via the display.



 **Warning**

Seat heating should not be used by individuals who:

- have difficulties sensing temperature shifts due to sensory loss.
- have trouble controlling the seat heating settings.

- 1 Press the temperature symbol in the bottom bar.
- 2 Select your preferred seat heating level.

To close comfort view, press the down arrow symbol on the bottom bar.

 **Tip**

#### Automatic seat heating

You can select automatic seat heating in the comfort view. This means your seat heating adjusts automatically.

## 4.3.1.2. Activating the steering wheel heating

Steering wheel heating can be controlled via the display. You can activate it manually or set it to automatic activation.

In colder temperatures, it's nice to heat your steering wheel for a more comfortable driving experience. You can activate and adjust the steering wheel heating via the display.

- 1 Press the temperature in the bottom bar.
- 2 Select your preferred steering wheel heating level.



 **Tip**

#### Automatic steering wheel heating

You can select automatic steering wheel heating in the comfort view. This means your steering wheel heating adjusts automatically.

## 4.3.2. Climate settings

In climate settings, you can choose which functions should automatically activate when the vehicle turns on.

You can access the climate settings by pressing the fan symbol  in the bottom bar and going to settings .

There are a number of climate functions you can set to automatically turn on. These include:

- Air quality notification.
- Open window notification.

---

## 4.3.3. Temperature and air conditioning

With the automatic climate settings, the climate system aims to always provide you with a comfortable interior environment. However, if you want to, you can always make adjustments to your liking.

The auto climate mode provides a comfortable interior environment in most circumstances. However, adjustments can always be made. For example, you can make changes to the temperature settings, set different settings in different climate zones or change the air conditioning settings.

---

### 4.3.3.1. Activating air conditioning

The air conditioning cools and dehumidifies the incoming air.

When you select auto climate mode, the air conditioning is automatically activated or deactivated to maintain the set temperature. Deselecting the air conditioning while in auto climate mode will activate manual climate mode.

For the air conditioning to work efficiently, windows, doors and the trunk need to be closed.



Tip

#### Open window detection

In the climate settings view, you can choose to be notified when an open window severely affects climate performance.

- 1 Press the fan symbol  in the bottom bar and go to **Climate**.
- 2 Press the air conditioning symbol **A/C**.

## 4.3.3.2. Setting the temperature

You can change the temperature in the passenger compartment via the display.

- 1 Press the temperature in the bottom bar.
- 2 Use the plus or minus symbol to adjust the temperature.

### Tip

You can set the temperature in your vehicle hands-free via voice control.

## 4.3.3.3. Synchronizing temperature

By default, the driver's temperature setting is used for all climate zones. However, each climate zone can also have its own individual setting. You can switch between the two options by desynchronizing and synchronizing the temperature.

- 1 Press the temperature in the bottom bar.
- 2 Press the synchronization symbol  to desynchronize or synchronize the temperature.

### Tip

The temperature setting is also desynchronized when the passenger sets a different temperature on their side.

## 4.3.3.4. Activating eco climate

Your vehicle has an eco climate function which prioritizes the vehicle's range over climate-related features.

Eco climate prioritizes range over climate comfort. The heating, cooling and air conditioning functions are limited in this mode.

### Note

Problems with fogging may occur, as the air conditioning function that adjusts humidity is limited when eco climate is active. This can also affect the air quality, especially in the rear seat, as air recirculation increases.

- 1 Press the fan symbol  in the bottom bar and go to **Climate**.
- 2 Press the eco climate symbol **Eco**.

## 4.3.4. Air distribution and climate modes

The general air distribution is decided by the selected climate mode and settings. There are also air vents that offer additional airflow adjustments throughout the vehicle.

### Adjustable air vents



The positions of the adjustable air vents.

The adjustable air vents can be opened, closed and angled to control the intensity and direction of airflow.

### Climate modes

There are two climate modes – automatic and manual. Automatic mode takes care of most adjustments and climate functions for you. However, in manual mode, you can control more of the available adjustments and functions yourself.

You can also turn the climate system off completely.

 **Important**

### Condensation risk

Turning the climate system off completely can cause condensation on the windows, which impacts visibility.

The climate modes and their settings are available in the display's climate view.

---

## 4.3.4.1. Adjusting air vents

You can adjust the air vents via the display's climate view, as well as by using the physical air vent controls.

You can open and close the air vents via the climate view in the display. Use the physical knob on each air vent to adjust the air vents and air flow.

#### Opening and closing air vents via the display

- 1 Press the fan symbol in the bottom bar .
- 2 Select the air vents you want to open or close.

#### Physically adjusting the air vents

- 3 Use the physical air vent knobs to adjust the air vents and the airflow.

To close an air vent, press the same vent again in the display.

If you only have one air vent open, you can't close it in the climate view. Instead, press **Climate off** to close the open vent.

 **Tip**

If you choose a specific air vent while auto climate mode is active, the climate system will change to manual mode. You can always go back to auto climate mode again by selecting **Auto** in the climate view.

## 4.3.4.2. Activating auto climate mode

When you activate auto climate mode, the climate system controls several of its functions automatically.



Tip

In auto climate mode, the climate system automatically adjusts the air flow towards the windshield when needed.

- 1 Press the fan symbol  in the bottom bar and go to **Climate**.
- 2 Select **Auto**.
- 3 You can change the fan power level if you prefer.

---

## 4.3.4.3. Activating manual climate mode

If you activate manual climate mode, you can set your preferred airflow direction and choose the fan power level.

- 1 Press the fan symbol  in the bottom bar and go to **Climate**.
- 2 Select **Manual**.
- 3 Choose your preferred airflow direction and the fan power level.

---

## 4.3.5. Ice, condensation and defrosters

In cold conditions, ice and condensation can obstruct visibility. Your vehicle is equipped with defrosters, a heated rear windshield and heated door mirrors to prevent this from happening.

There are defrosters positioned by the windows and windshields. The side mirrors heat up at the same time as the rear windshield. Together, these functions seek to ensure good visibility.

---



### 4.3.5.1. Activating max defroster

Activate max defroster to quickly remove condensation and ice from the front windshield and windows.

Max defroster raises the temperature and fan speed. Air conditioning is activated and air recirculation is unavailable while max defroster is active. When max defroster is turned off again, the climate settings return to their previous levels.

 **Note**

When max defroster uses the high fan speed, the noise level of the fans increases.

- 1 Press the fan symbol  in the bottom bar and go to **Climate**.
- 2 Press **Max defroster** .



 **Tip**

The defroster button  in the overhead console activates max defroster, as well as the heating of the rear windshield.

---

## 4.3.5.2. Activating rear windshield and door mirror heating

Activate the rear windshield and door mirror heating to get rid of condensation and ice.

- 1 Press the fan symbol  in the bottom bar and go to **Climate**.
- 2 Press **Rear defroster** .

 **Tip**

The defroster button  in the overhead console activates max defroster, as well as the heating of the rear windshield.

---

## 4.3.6. Interior climate when parked

Your vehicle can maintain a comfortable interior climate when parked. You can also precondition your vehicle so that the passenger compartment is prepared for your next trip.

**Note**

The parking climate functions automatically turn off when the maximum running time is reached or the vehicle's battery level is too low.

## preconditioning

Preconditioning automatically activates auto climate mode to warm up or cool down the passenger compartment to a comfortable temperature before you enter the vehicle.

You can schedule a single or recurring preconditioning timer in the display, or via the mobile app for the vehicle. Preconditioning automatically deactivates when you enter the vehicle or when the scheduled time is reached.

For preconditioning to be available, the traction battery must be sufficiently charged. If preconditioning is started when your vehicle is not connected for charging, the vehicle's range will be affected.

**Note**

When preconditioning in a hot climate, condensation might drip under the vehicle. This is normal.

**Tip**

In colder weather, your vehicle's seat and steering heating activates automatically during preconditioning.

## Parking comfort

Parking comfort allows you to maintain a comfortable interior climate in your vehicle while parked. This includes keeping the climate functions and the entertainment system on. You can activate the parking comfort function via the display. Just be aware that range may be affected if you leave this setting on for too long.

### 4.3.6.1. Setting the preconditioning timer

You can set and activate a timer to precondition your vehicle for a specific departure time. If you want, you can set it to recur on specific days.

If you choose to precondition the passenger compartment, the vehicle will cool or heat it before your scheduled departure time.

The timer can be set to repeat on a weekly schedule or set for a single departure time.

- 1 Press the fan symbol  in the bottom bar and go to **Parking**.
- 2 Press the timer to open and modify it.
- 3 Choose a time when the preconditioning should be ready.



Activate **Repeat every week** and select one or more weekdays to set a repeating schedule.

4 Select **Save**.

➤ The timer is saved and activated.

---

## 4.3.6.2. Activating parking comfort

You can activate the parking comfort function to maintain a comfortable climate in the vehicle while you are away from it.

### **Warning**

Never leave a child or pet unattended in your vehicle. You are responsible for their safety and well-being. Some regions have laws prohibiting people or pets being left inside a locked vehicle.

### **Note**

The parking comfort function will automatically turn off when the maximum running time is reached, the vehicle's battery level is too low or you start a new drive cycle. If you activate it when your vehicle battery level is already low, the maximum running time will be shorter.

- 1 Press the fan symbol  in the bottom bar and go to **Parking**.
- 2 Go to **Parking comfort**.
- 3 Select **Start**.

Press **Stop** to turn it off again.

---

## 4.3.7. Air quality

Your vehicle is designed to provide a pleasant and healthy interior climate. Air filtering helps to remove odors, substances and particles from the passenger compartment.

### Passenger compartment air filter

The air going into the passenger compartment is first filtered through the climate control system. To ensure high performance, the filter needs to be replaced regularly. If the filter is exposed to intense use, such as prolonged driving through areas with smog or dust clouds, the filter needs to be changed more frequently. If you are uncertain about what kind of filter to use, contact Volvo support.

## Air quality system

The air in the passenger compartment is purified by:

- filtering out allergy- and asthma-inducing substances.
- removing gases and particles to reduce odors.
- removing air contaminants such as particles.

If the air quality sensors detect contaminants in the outside air, the air intake closes and internal air recirculation activates.

---

### 4.3.7.1. Air quality indication

In the display's climate view, you can find information about the air quality inside the vehicle.

In the climate tab, the color and number following the dot indicate the AQI <sup>[1]</sup> value inside the vehicle.

The air quality tab shows more information, including the detailed AQI and the actual concentration of airborne particles. A sensor measures the content of particles smaller than 2.5 µm in the passenger compartment.

<sup>[1]</sup> Air Quality Index

---

### 4.3.7.2. Activating air recirculation

Air recirculation helps you keep out harmful or foul-smelling air from the passenger compartment. In some cases, it's activated automatically but you can also activate it manually in the climate view.



When air recirculation is not manually activated, the climate system automatically decides whether to recirculate the air depending on certain environmental conditions. These include the temperature inside and outside the vehicle, as well as the air quality outside. You can also manually activate constant air recirculation to close the air intake if you want to.

#### Important

If air is recirculated for a long period of time, condensation can fog up the windows, which can affect visibility.

**Note**

Air recirculation is unavailable while max defroster is active.

- 1 Press the fan symbol  in the bottom bar and go to **Climate**.
- 2 Press the recirculation symbol .

## 4.3.8. Climate system

Your vehicle's climate system seeks to provide everyone in the vehicle with a comfortable environment using electronic climate control.

All climate control system functions are controlled via the display.

Your vehicle uses sensors to automatically control different capabilities that are designed to offer a comfortable interior climate at all times.

**Tip**

Most climate functions can also be controlled using voice control. Most features require an internet connection for voice control use.

### 4.3.8.1. Climate zones

The passenger compartment is divided into different climate zones. These zones enable passengers to set their own preferred temperature to enjoy a comfortable environment.



Available climate zones.

There are two different climate zones in the passenger compartment. All zones are directly synced to the driver's preferred climate settings by default. However, each zone can have its own individual temperature setting.

---

## 4.3.8.2. Perceived and actual temperature

Your temperature perception is affected by several factors besides the actual temperature of the air around you. Knowing the difference between perceived and actual temperature can benefit your climate comfort experience.

Whether the air in your vehicle feels warm or cold depends not only on its temperature but also several other factors. These factors include your own body temperature, airflow and humidity in the vehicle, and whether you're exposed to direct sunlight. When you adjust the temperature setting, the vehicle considers some of the factors contributing to your perceived temperature. The vehicle then continuously adapts its climate functions to make the interior climate feel like the temperature you selected, regardless of any changing conditions. This means that the actual temperature in your vehicle may differ from the temperature you selected to give you a more consistent climate comfort experience.

---

## 4.3.8.3. Climate sensors

There are several climate sensors located inside and outside of your vehicle. These sensors help to provide a comfortable climate in the passenger compartment.

For the interior sensors to be able to perform as intended, it's important that you don't cover them.

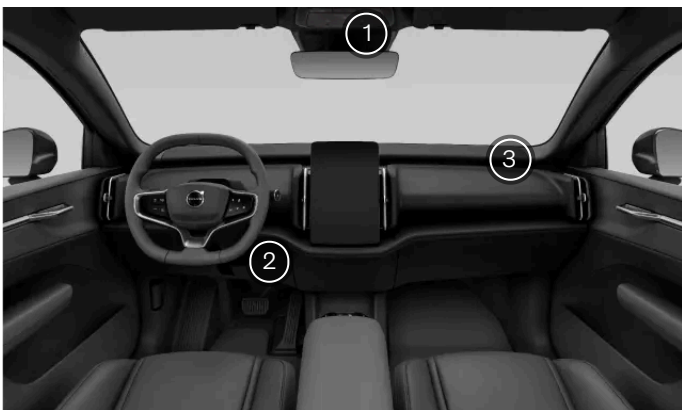

- ① Sunlight, rain and humidity sensor in the rearview mirror console.
- ② Passenger compartment temperature sensor, located behind the dashboard panel on the driver's side next to the glove compartment.
- ③ Airborne particulate matter sensor, located under the speaker cover on the passenger's side.

The exterior ambient temperature sensor is located in the right door mirror.

---

## 4.3.8.4. Heaters

If the ambient temperature is lower than the temperature you prefer in your vehicle, the heating system can help provide a comfortable interior climate.

### Electric heater

The electric heater is powered by the vehicle's traction battery. It is used to heat the battery and for heating the passenger compartment during preconditioning.

If the traction battery's charge level is too low, the heater will turn off.

### Heat pump

The heat pump works primarily as a range extender. In low temperatures, the heat pump helps to warm up the passenger compartment while using less energy compared to the electric heater, which extends the battery's power availability. The heat pump operates during both preconditioning and driving. It also helps to maintain the traction battery at its desired operating temperature, which enhances performance.

---

## 4.4. Windows and glass panes

Your vehicle has several different windows and glass panes. Some of them are laminated for added safety and security. The lamination also provides better sound insulation in the passenger compartment.

There are four power-operated side windows in the vehicle: one for each door.

The rear windows are equipped with privacy glass, which restricts the view from outside the vehicle and reduces glare.

### Panoramic roof

Your vehicle's panoramic roof has an infrared coating which helps to keep the passenger compartment cool in sunny conditions.

#### Note

Do not use tinted film with a metallized surface coating on the rear windshield. This can cause problems with signal reception because this is where the antenna is located.

---

### 4.4.1. Operating the windows

You can use the power switches at the front and back of the center armrest to operate the windows.

The power windows may still work for a while after you exit the vehicle. Keep this in mind when leaving the vehicle unattended.

 **Warning**

Always consider the safety risks while operating the windows. The vehicle's moving parts can injure children or other occupants, as well as damage objects.

- Make sure you have a clear view of the windows you operate.
- Don't allow children to play with the window controls.
- Never leave children alone in the vehicle.
- Never put an object or body part through an open window, even if the vehicle's electrical system is fully disconnected.

All of the windows have built-in pinch protection to help prevent injuries. Be sure to read the relevant information on pinch protection in a separate section of the manual.

 **Note**

Situations where the windows cannot be opened

- The windows cannot be opened at speeds above approximately 180 km/h (112 mph) but they can be closed.
- At very low temperatures, the windows might freeze in place and you won't be able to operate them.

**Operating windows from the front seats**

1



From the front seats, you can control all of the power windows. Press the button with the text REAR to switch between operating the front or rear windows. The button turns amber to indicate that the rear windows are selected. The controls will switch back to the front windows if you press the button again or after a few seconds of inactivity.

## Operating the windows from the rear seats

2



From the rear seats, you can operate the rear windows using the switches at the back of the center armrest.

3 Use the switches to open or close the windows:

- A slight push or pull allows you to manually operate the window until you release the switch.
- If you push or pull the switch fully, the window moves automatically even if you release the switch. Stop it by moving the switch in the opposite direction.

### Tip

#### Noise reduction

One way to reduce the noise of the wind when the rear windows are open is to also open the front windows slightly.

#### Close by locking

If you want to close all the windows at the same time when you lock the vehicle, you can enable this feature in the settings. Look up automatic window closing in this manual for more information.

#### Locking the rear windows

You can disable the rear window controls in settings. This prevents rear seat passengers from operating the windows.

### Note

If automatic window movement or pinch protection isn't working properly, you may need to reset the windows. You can learn how to do this in a separate section of the manual.

## 4.4.1.1. Locking the rear windows

You can lock the rear power windows via a setting in the display. This can be important to consider when driving with children in the rear seats.

 **Important**

## Child lock

Locking the rear windows does not affect the door locks. If you want to prevent rear seat passengers from opening the doors, read more about the child lock in a separate section in this manual.

When driving with children in the rear seats, check that the rear doors are secured with an active child lock.

- 1 Press the vehicle symbol  in the bottom bar and go to **Settings**.
- 2 Go to **Controls** → **Locking** → **Lock rear power windows**.
- 3 Turn on to lock the rear windows.

## 4.4.2. Pinch protection

To help prevent injuries from power-operated windows and other moving parts, your vehicle has a built-in pinch protection system. Occupants should also keep proper user practices in mind to reduce the risk of getting caught between moving or closing parts.

If something is blocking the window when it is closing, the window will stop and then slightly reverse, allowing you to remove what's in the way.

 **Warning**

Always consider the safety risks while operating the windows. The vehicle's moving parts can injure children or other occupants, as well as damage objects.

- Make sure you have a clear view of the windows you operate.
- Don't allow children to play with the window controls.
- Never leave children alone in the vehicle.
- Never put an object or body part through an open window, even if the vehicle's electrical system is fully disconnected.

If a window stops closing automatically due to obstructions such as ice, you can still try to close the window manually by continuing to pull the control switch. However, always try to remove the cause of the obstruction first and make sure nothing is blocking the path of the window before trying to close it again.

If there is a problem with the pinch protection, you can try to solve the issue by resetting the windows.



 **Warning**

The power window pinch protection may not work properly if the vehicle loses track of the current window position. The window positions are recalibrated when you reset the windows. Always reset them to make sure the window positions are correctly calibrated if:

- the vehicle has lost power: for instance, if the 12 V battery has been disconnected.
- the automatic window movement does not work properly.

This restores automatic window movement and re-enables the pinch protection function.

---

### 4.4.3. Resetting windows

If you're experiencing issues with the power-operated windows, you need to reset them. This allows the vehicle to recalibrate their position, restoring both pinch protection and automatic movement.

 **Important**

The pinch protection system will not work properly until the window has been reset after losing calibration.

- 1 Lightly pull the window switch until the window is completely closed, then continue to hold for at least two seconds.
  - 2 Lightly press the switch until the window is completely open, then continue to press for at least two seconds.
  - 3 Lightly pull the switch again until the window is completely closed, and then continue to hold for at least two seconds.
- Recalibration is now done, re-enabling both pinch protection and the automatic window movement.

If the problem persists, contact an authorized Volvo workshop.

---

## 4.5. Seats

The seats are all designed to provide comfort and safety. Adjust the seats, headrests and other comfort functions and make sure to sit properly.

The vehicle seats have a range of features to provide comfort, safety and flexibility.

In this section of the manual, you'll get to know the comfort features and adjustments available for the vehicle seats. This includes features such as the front seat positional adjustments and how to fold the rear seats to get more space for stowing. At the same time, you will learn the essentials of how to use these features safely and properly.

A separate safety section in this manual provides more information about the seats' passive safety functions and how to accommodate them through proper seating.

## 4.5.1. Front seats

The front seats have plenty of adjustments to increase comfort.



### Adjustments

The power seat adjustments are divided into separate adjustment modes:

- Basic adjustments** Height and position of the seat, as well as backrest tilt.
- Tilt adjustments** Seat cushion tilt.
- Lumbar adjustments** The driver seat also has access to lumbar support height and depth adjustments.



Tip

#### Seat adjustment knob

All power seat adjustments are done using the knob on the side of the seat. When you press the center button, the seat adjustment view appears in the display to guide you.

### Seat heating

The front seats have three levels of heating to choose from.

#### 4.5.1.1. Adjusting the front seats

The content of this manual represents the status of the user manual at the time of printing and may not be completely valid in future instances. For more information refer to the first page for the complete disclaimer note.

Adjust the front seats with the seat adjustment knob. You can find this on the side of the seat closest to the door.

## Seat adjustment knob

The seat adjustment knob can move up and down, forward and backward, as well as rotate in both directions. In the middle of the knob there is also a button you can use to change the active adjustment mode.

There are lots of different changes you can make to the seats. To control them all with the adjustment knob, the available changes have been grouped into separate adjustment modes. Each mode is visually represented in the display to guide you while adjusting the seat.

### **Warning**

Never adjust the seat while driving. This can cause dangerous distraction and loss of control. Instead, be sure to make all necessary adjustments to the seat before starting a drive.

### **Adjusting the seat**

- 1 Start by pressing the button on the adjustment knob.
  - The seat adjustment view appears in the display.
- 2 To cycle through the different adjustment modes, press the button on the knob repeatedly.
- 3 Rotate or move the knob to adjust the seat according to your preference.
  - The visual guide in the display indicates which part of the seat you are adjusting.

### **Tip**

#### Quick adjustments

You can also customize the seat without visual guidance from the display. Just move or rotate the seat adjustment knob to start adjusting. Note, however, that only the basic adjustment mode is available this way.

#### Saving a preset seat adjustment

If you have adjusted your seat position, the display shows a notification where you can save the adjustments to your profile. When you save a preferred seat position, your vehicle automatically saves your current positions for the door mirrors.

### **Note**

#### Adjustment lock

If you move the adjustment knob an excessive number of times within a short time frame, the knob becomes unresponsive for 20 seconds. This is to prevent unintentional use of the adjustment knob.

**!** Important

Once you've finished adjusting the seat to your liking, it's important to make sure other parts of the vehicle are aligned correctly. Your driving posture is important and is affected by more than your seat adjustments, such as the position of the steering wheel and mirrors.

## 4.5.2. Rear seats

You can adjust the rear seats to get more space or to provide more comfort.

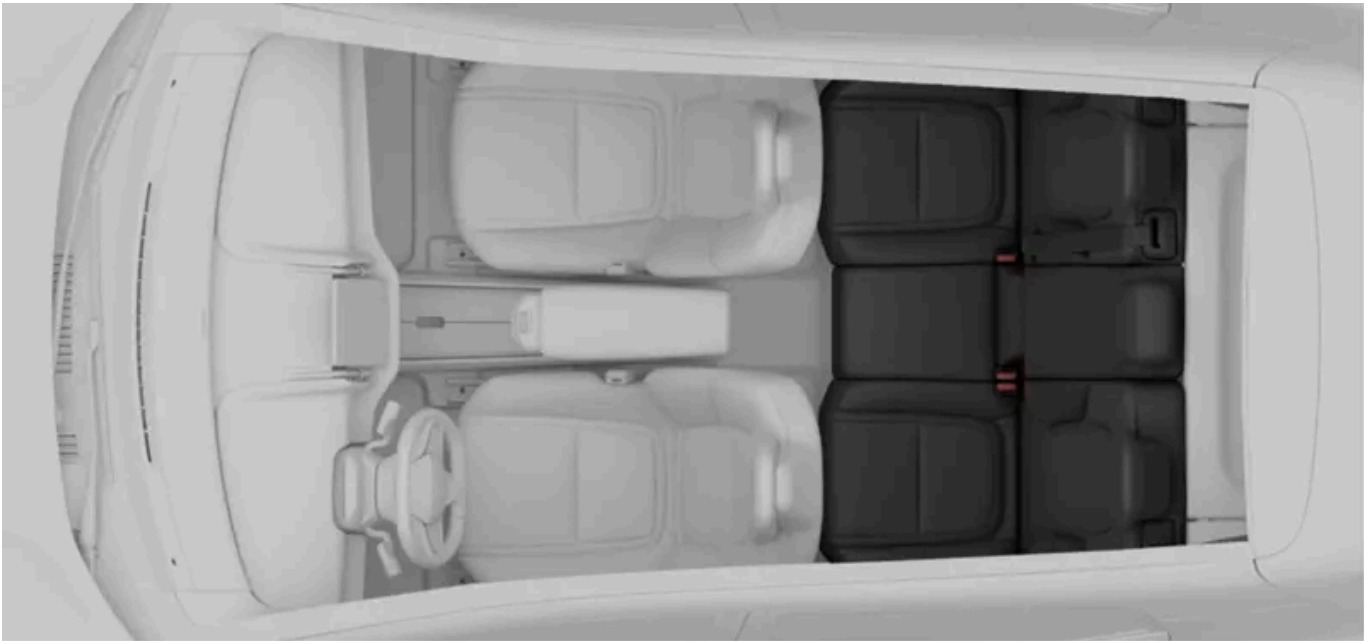

The rear seats have the following features:

- |   |   |
|---|---|
| <b>Adjustable and removable headrests</b> | The rear seats have adjustable headrests. They can be raised or lowered to better support your head. You can also remove the headrests for more space when folding the seats. |
| <b>Foldable backrests</b>                 | You can fold the rear seats to create more cargo space. The left seat can fold on its own, while the center and right seats fold together.                                    |

**i** Tip

### Small item storage

There is a pocket for storing small items on each outer seat, on the side closest to the door.

### 4.5.2.1. Adjusting rear seat headrests

All three rear seats have adjustable headrests. The headrest should be adjusted according to your height so it fully supports the back of your head, if possible.

A correctly adjusted headrest can help prevent neck injury during collisions. It's important to align the headrest to cover as much as possible of the back of the head.

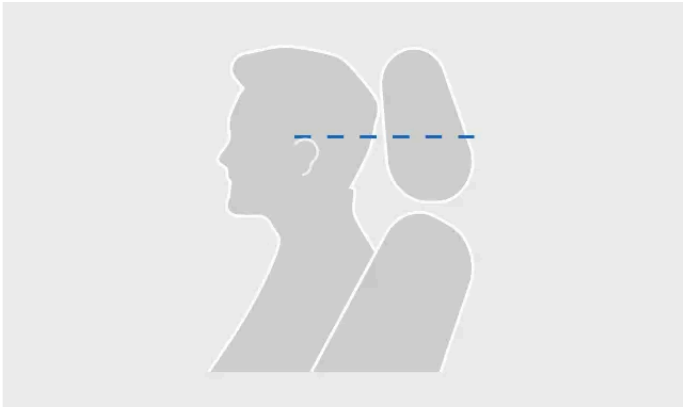

Correct headrest level

Upward movement of the headrest is not locked.

- 1 Pull the headrest upwards to a level that suits your height.

To lower the headrest, press and hold the button at the base of the right support to release the lock. Then, carefully push the headrest down.



Locking button on the headrest

**i Tip**

Make a habit of lowering the headrest when the seat is not in use. In the lowered position, it doesn't risk obstructing the rear view.

## 4.5.2.2. Removing rear seat headrests

If you need more room to fold the rear seats, you can remove the headrests.

There are two buttons involved when removing the headrests. The first button is located on the base of the right headrest support. This is the same button you use to adjust the headrest height. The second button is smaller and located on the base of the left support. This button is integrated into a larger button.

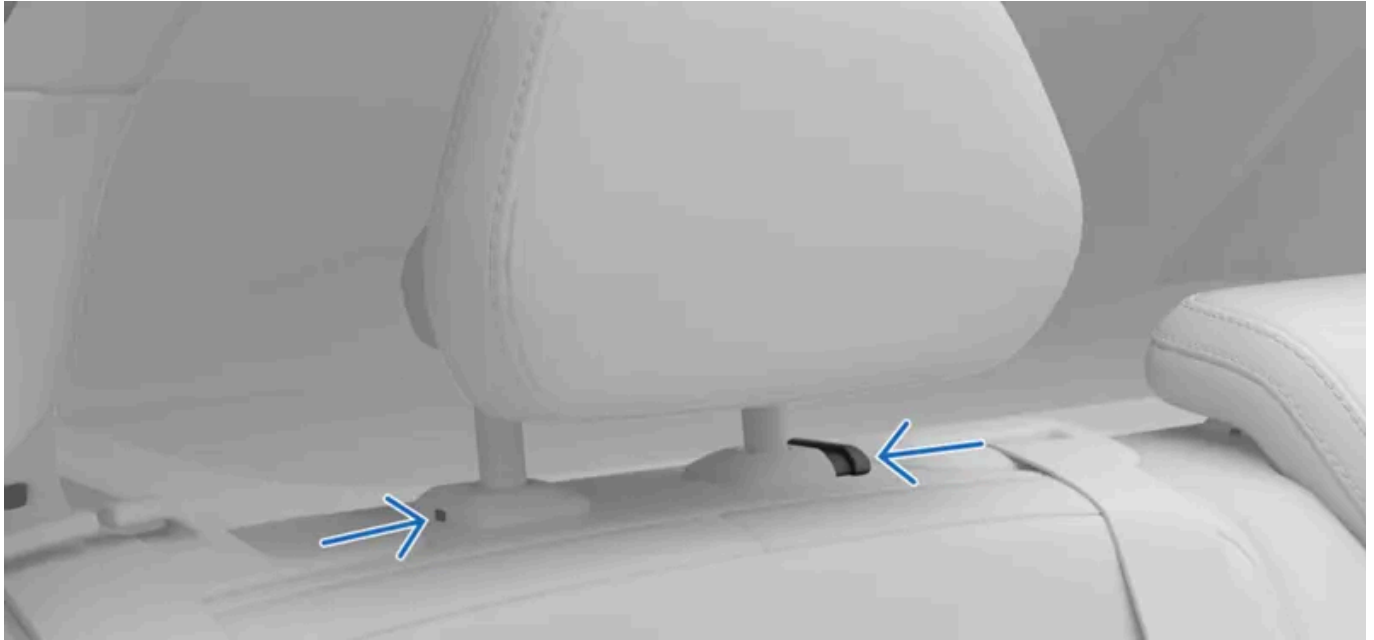

Buttons used to remove headrest.

- 1 Press and hold both buttons on the support bases.
- 2 Move the headrest upwards until it detaches from the seat.

### **Warning**

Never drive with a passenger sitting in a seat without an attached and properly adjusted headrest. This can result in serious or fatal personal injury.

Make sure to stow the removed headrests properly while the rear seats are folded down. Always reattach the headrests once you raise the seats again.

## 4.5.2.3. Folding down the rear seats

You can fold the rear seats with a button on the seat backrest. The left seat can be folded on its own while the center and right seats fold together.

**!** Important

Before folding the seats, make sure:

- there are no objects on the seats.
- the seat belts are not buckled.
- there is enough space to fold the seats down. If needed, move the front seats forwards and adjust or remove the rear seat headrests.

**!** Warning

If any of the rear seats are folded down, they must not be in contact with the front seats. This can impede the safety of other occupants.

1



Press the button on the seat backrest.

➤ The seat releases and folds forwards.

Manually push the backrests to their upright position when you no longer need the extra cargo space. Make sure they lock into place.

---

## 4.6. Interior lighting

The lights in your vehicle's passenger compartment provide illumination for different purposes. There are lights for reading, as well as for general illumination and lighting up storage areas.

### Reading lights

The front and rear seats have reading lights. You can adjust their intensity to suit your needs. In the rear seat, the reading lights also work as general lighting.

## General illumination

Your vehicle has lights to provide general illumination of the passenger compartment, such as when you get into the vehicle. General illumination can be activated both manually and automatically.

## Ambiance lights

The passenger compartment also has ambiance lights to provide comfortable illumination when it's dark outside. The lights can be adjusted in terms of both intensity and color theme.

## Storage area lights

There are lights in different storage areas, such as the trunk, to make it easier to find what you're looking for.

---

### 4.6.1. Adjusting the reading lights

There are reading lights available for the front and rear seats. You can adjust the brightness according to your needs.

The front seat reading lights are located in the overhead console and the rear reading lights can be found over the rear doors.



The front seat reading lights in the overhead console



Rear seat reading lights



- Press the button next to your reading light to turn it on and off. The button is marked with a reading light symbol.



- Hold the button down to adjust the brightness.



**Tip**

Turning all reading lights on

You can turn all reading lights on at the same time in settings.

---

## 4.6.2. Adjusting interior lights

You can adjust the interior lights in the lights and displays section of the settings.

- 1 Press the vehicle symbol  in the bottom bar and go to **Settings**.

- 2 Go to **Controls** → **Lights and displays** → **Interior lights**.

### Selecting light color

- 3 Go to **Neutral ambience color**.

- 4 Select which color the neutral light should be. Choose between white light or light matching the interior of your vehicle.



**Tip**

The brightness of both the neutral light and the ambience light themes can be adjusted in the ambience settings.

You can read more about the ambience light in a separate section of this manual.

### Adjusting button brightness

- 5 Go to **Button brightness**.

- 6 Adjust the backlight brightness of the vehicle's physical buttons.



Tip

### Courtesy light

If the courtesy light feature is enabled, the interior lights will temporarily turn on when you enter the vehicle. The extra light can be helpful while getting seated when it's dark outside. You can enable or disable the feature in the lights and displays section of the settings.

### Turning all reading lights on

You can turn all reading lights on at the same time in the lights and displays section of the settings.

## 4.6.3. Adjusting ambience lighting

The ambience lighting in the vehicle can provide comfortable illumination of the passenger compartment. There are several color themes to choose from, along with matching ambient sounds.

- 1 Press the vehicle symbol  in the bottom bar and go to **Quick controls**.
- 2 Press the ambience symbol.



- > The ambience view appears.

#### Selecting theme

- 3 Select one of the color themes at the bottom of the ambience view or select Off to use neutral static light.



Tip

Even if there is no active theme selected, you can still change the color of the neutral light. It can either be white or match the color of your vehicle's interior. To change this setting, go to **Controls** → **Lights and displays** in settings. You can read more about adjusting the interior lights in a separate section of this manual.

#### Adjusting light brightness

- 4 Press the brightness symbol.



- 5 Adjust the brightness to your preference.

#### Enabling ambience theme sound

- 6 Press the sound symbol to turn sound on and off.



**Note**

There is a dedicated sound loop for each ambience theme. The ambient sound is designed to be unintrusive and will temporarily turn off while you are on a phone call. If you start playing music it will turn all the way off, and you will have to turn it on again in the ambience view.

## 5. Safety

Get to know your vehicle's collision protection features, such as airbags and seat belts, and what is needed for safe use.

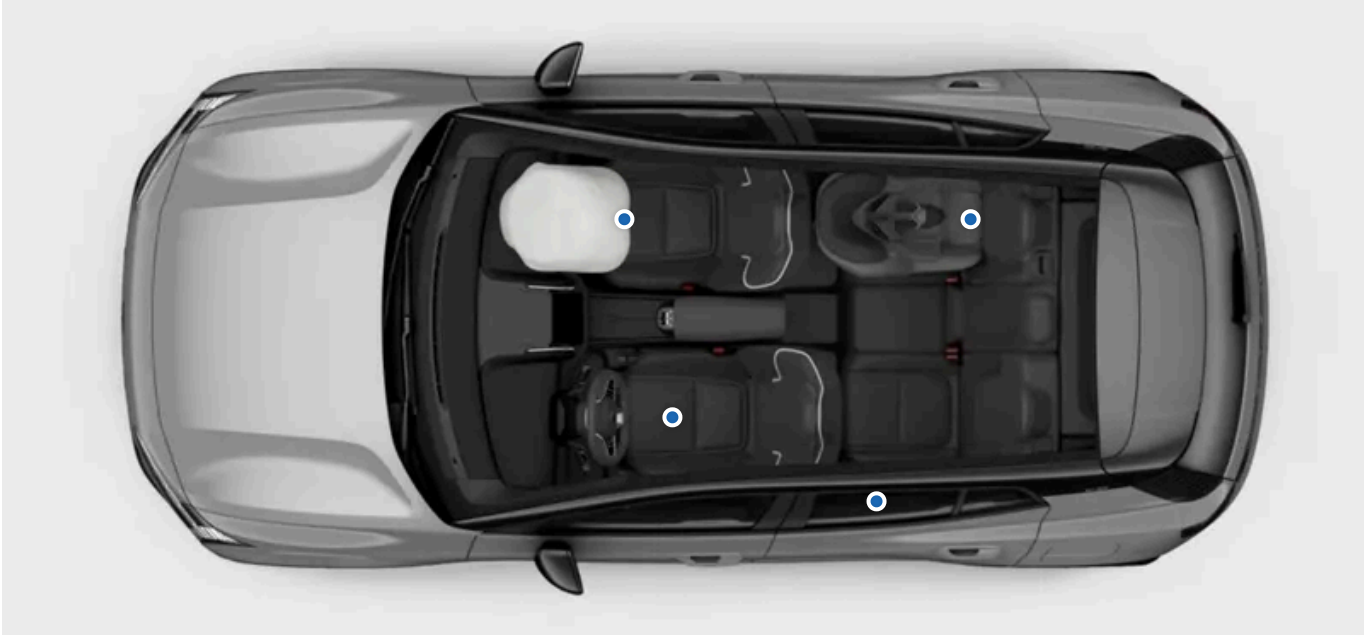

The safety section describes features designed to reduce the risk of serious injury in the event of a collision. They include seat belts, airbags, child restraints and other features that can help save lives when used correctly.

Your vehicle is designed to promote and provide the conditions for safe use. Safety features never replace the need for safe user practice. This applies to features directly related to safety, but also to the rest of your vehicle. It's your responsibility to use the vehicle's functions safely.

### **Warning**

#### Safety synergy

The safety features are designed to work together to increase the safety of all occupants in the vehicle. No feature replaces the need for another unless the user manual explicitly states so. For example, the presence of airbags in no way reduces the need to wear a seat belt.

#### SRS warning

Sensors in the vehicle can detect if there is something wrong with the airbags or related safety systems. A warning symbol will appear in the driver information area of the display to alert you if any faults are found.



SRS warning symbol

If the SRS warning symbol appears, immediately contact an authorized Volvo workshop.

**Note**

### Startup checks

Several safety systems are part of the vehicle's startup check. Address any indicated faults.

### Safety-related areas

Some driver support functions are related to safety. Instead of keeping you safe in the event of an accident, they are designed to prevent them in the first place. Get to know those functions as well for a safer trip.

---

## 5.1. Collision response

In the event of a collision, your vehicle has many features designed to help mitigate the effects. Your vehicle's response to a collision happens before, during, and after the impact.

**Tip**

You can find information related to collision response in many places throughout this manual. Therefore, this section exists to provide a more comprehensive overview of your vehicle's capabilities in this area.

### Before

Before an impact, several driver support functions can work to avoid the collision or reduce its effects. If the vehicle senses that a collision is likely or unavoidable, it has the ability to preemptively activate protective systems before the impact occurs.

### During

During a collision, sensors throughout the vehicle continuously provide information about the states of the vehicle and its occupants. The vehicle uses the information to selectively time and activate protective functions such as airbag deployment and seat belt pretensioning. Collisions are complex events that can unfold in several stages, where the first impact isn't necessarily the most severe. Good timing is essential for the best chance of effective protection.

The vehicle's safety systems work in synergy with passive safety features. In the event of a collision, your vehicle's construction distributes forces to specific structural components. It also takes advantage of crumple zones that absorb energy from the impact. Using similar principles, the exterior has been designed with the protection of pedestrians in mind.

### After

After a collision, the vehicle tries to stop in a controlled and safe manner. It can also make an automated call for emergency response.

 **Note**

### Safety mode

The vehicle can enter safety mode after certain collisions, even without airbag deployment. The traction power supply is cut off in safety mode, and the vehicle cannot be driven.

Do not try to move the vehicle in safety mode. If the vehicle poses an acute traffic hazard and is able to move, an exception can be made to move it a short distance out of immediate danger. Tow mode needs to be activated before towing the vehicle.

 **Important**

Your vehicle is designed around safety, but no protective system is 100% effective in all situations. Safety features never replace the need for safe user practice.

---

## 5.2. Occupant detection

Your vehicle can remind you not to leave anyone or anything important in the vehicle when you leave it.

### Presence reminders

By default, your vehicle monitors your use of the doors and alerts you if it suspects that passengers, pets or belongings are still inside the vehicle when you open the driver's door after a drive.

When this happens, you will see a notification in the display.

 **Warning**

Volvo recommends that you do not leave people or pets in a locked vehicle.

Some regions have laws prohibiting people or pets being left inside a locked vehicle.

---

## 5.3. Proper seating

Appropriate seating and proper seat belt use are essential for the safety and comfort of everyone in the vehicle. There are also specific recommendations for pregnancy and child seating.

**!** Important

### Importance of proper seating

Safety features, such as seat belts and airbags, require that all occupants are properly seated for the best chance of effective protection in a collision. Failure to follow the seating instructions can endanger life or lead to serious injury.

### Pregnancy

Take extra care to follow all seating recommendations if the occupant is pregnant. The following are either additions or of extra importance:

- Make sure that the seat belt does not cross the abdomen. The hip strap should be under it, and the shoulder section should pass above it.
- In the driver's seat, avoid sitting closer to the steering wheel than necessary. Adjust the seat to create as much distance as possible between your abdomen and the steering wheel while still keeping all driver controls comfortably within reach.

### Child seating needs

Always seat children with extra care and attention to their needs. Make sure you have the required child restraint, that it's installed correctly, and that the child remains safely seated throughout the entire trip. For children traveling facing forward, the same seating recommendations apply as for adults. Always make sure the seat belt is properly adjusted and that the headrest is at a height suitable for the child when possible.

**i** Note

### Physical limitations

Physical limitations can prevent an occupant from following the seating recommendations. The vehicle may need modifications to accommodate safe use. Contact an authorized Volvo workshop for information about Volvo-approved modifications.

## Sitting posture

Both sitting posture and proper seat belt adjustment are important for safety. Avoid irregular sitting postures.

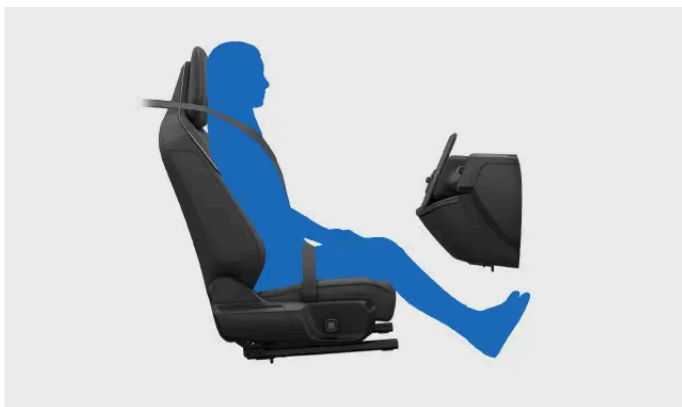

A correctly seated occupant. Do not adopt other postures when the vehicle is moving.



Do not slide forward in the seat. The lower back should have contact with the backrest.



Keep both feet planted on the floor.



Do not fold the backrest to a lying position. The seat belt must remain tensioned against the shoulder.

## Proper headrest use

Proper headrest use is essential to reduce the risk of neck injuries in a collision. All of the car's headrests are designed to help protect the head and neck when used correctly.

- Keep the back of your head against the headrest.
- Make sure occupants have correctly adjusted headrests when possible.



## 5.4. Seat belts

When you use seat belts correctly, they can help prevent serious injury in situations ranging from sudden braking to severe collisions.

### Seat belt features



The seat belt locks itself to act as a safety restraint under certain conditions. These include sudden and forceful pulling of the belt, aggressive driving, and steep inclines.

When installing certain child restraints<sup>[1]</sup>, several of the vehicle's seat belts can be set to only retract.

### Seat belt reminder

The vehicle uses built-in sensors to detect if the driver or any of the passengers aren't using their seat belts. The system alerts the driver with a warning sound and the seat belt reminder symbol appears in the display.



Seat belt reminder symbol.

 **Important**

## Wearing seat belts

These are the essentials for wearing seat belts properly. There is also more detailed information in other sections of the manual covering proper seating and seat belt adjustments.

- Make sure that everyone in the vehicle wears their seat belt and that all belts are properly adjusted.
- Adjust the seat belt for the wearer's size.
- Wear the seat belt closely against the body.
- Minimize slack in all belt segments.
- Allow the belt to run as straight as possible between its three anchor points.<sup>[2]</sup>
- Have the backrest in an upright position.
- Follow all seating and posture recommendations.<sup>[3]</sup>
- Do not wear your seat belt in ways other than those described in this user manual.
- Always use seat belts when driving.
- Never use the same seat belt for more than one individual at a time.

 **Warning**

## Seat belt care and maintenance

- Never modify or repair seat belts or related parts such as fittings and hooks yourself. Any service or replacement must be done by a trained technician with access to type-approved parts.<sup>[4]</sup>
- Contact an authorized Volvo workshop if the seat belt or a related part shows signs of damage or wear.
- Replace the seat belt if it has been subjected to a heavy load, such as in a collision. It may have lost protective properties even if there is no apparent damage.
- Clean the seat belt as soon as possible if anything is spilled onto it. The spilled substance can enter the mechanism and deteriorate the material.

<sup>[1]</sup> Read everything about child safety before installing a child restraint.

<sup>[2]</sup> For example, never wrap it around or attach it to other items or fittings in the vehicle.

<sup>[3]</sup> There are general seating recommendations, as well as specific recommendations for children and pregnant occupants.

<sup>[4]</sup> Volvo recommends an authorized Volvo workshop.

---

## 5.4.1. Fastening and adjusting seat belt

A correctly fastened and adjusted seat belt is important for your safety and comfort.



Correctly fastened and adjusted seat belt.

**Note**

These instructions apply to adults and children who are seated normally or are using a booster seat or booster cushion. Read the separate section covering child safety for detailed information about child seating and different types of child restraints.

Before fastening the seat belt on an outer rear seat, make sure the belt runs flat through the seat belt guide on top of the backrest. If the seat belt has worked its way outside of the guide, reinsert it through the gap.



Seat belt guide

**Important**

Leaving the seat belt outside the guide when fastening can cause the belt to shift position. This could have a negative impact on passenger safety or comfort. It can also lead to problems with retracting, which can damage the belt over time.

**Fastening the seat belt**

- 1 Pull the seat belt out by the latch plate. If you pull too fast, the locking mechanism will engage.
- 2 While extended, check the belt for twists, knots or damage.

The content of this manual represents the status of the user manual at the time of printing and may not be completely valid in future instances. For more information refer to the first page for the complete disclaimer note.

3 Insert the latch plate into the buckle.

➤ The latch plate clicks into place.

 **Warning**

**Check when seat belt is fastened**

- The seat belt should run directly and as straight as possible between its three anchor points. Any unnecessary slack increases the risk of injury.
- Make sure everyone in the vehicle is wearing their seat belt correctly.

**Adjusting the seat belt**

4 For front seat occupants, adjust the height of the seat belt upper attachment point.

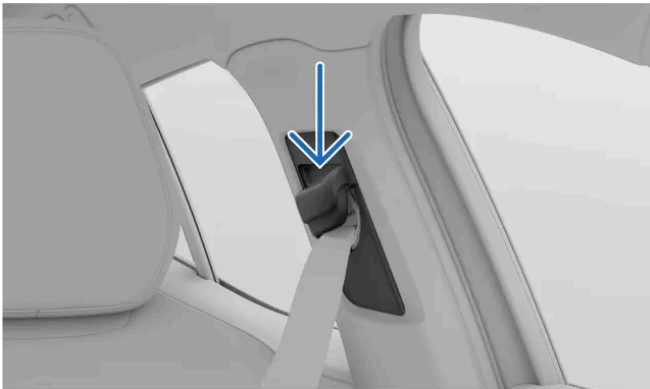

Seat belt top attachment point

Hold the button on the upper attachment point down to allow it to slide up and down.

Place it as high as possible without the belt touching the throat or neck.

5 Tension the hip strap to remove slack by pulling upwards on the diagonal chest strap. It should be as straight and low as possible, running below the abdomen.

 **Important**

**Pregnancy**

Take extra care to follow all seating recommendations if the occupant is pregnant. Make sure that the seat belt does not cross the abdomen. The hip strap should be under the belly and the shoulder section should pass above it.

**Releasing the seat belt**

6 Release the seat belt by pressing the buckle button.

7 Guide the seat belt back to its retracted position.

 **Important**

Make sure the seat belt retracts fully after using it. Closing a door with the seat belt caught in the gap can damage both the seat belt and the door.

---

## 5.4.2. Setting seat belt to only retract

By setting the seat belt to only retract, you can tighten the belt without it loosening when you let go. This allows you to install certain child restraints in your vehicle that are secured using the seat belt.

When set to only retract, the seat belt's locking mechanism will engage continuously. This allows you to tighten the belt manually to secure a seat belt-installed child restraint.

All seat belts in your vehicle, except for the driver's seat belt, can be set to only retract.

- 1 Pull the seat belt out fully.
  - > When the full length is unfurled, the belt switches to only being able to retract.

Allow the seat belt to retract fully to return the seat belt's function to normal.

### Important

Seat belts can only be used to install child restraints specifically designed for seat belt installation. Always follow the instructions that come with the child restraint.

---

## 5.4.3. Seat belt reminder

The vehicle uses built-in sensors to detect if the driver or any of the passengers aren't using their seat belts.

If the vehicle detects any occupants that are not wearing their seat belts, the system alerts the driver with a warning sound, and the seat belt reminder symbol appears in the display.



Seat belt reminder symbol.

You can find information about which seat belts aren't fastened in the driver information area of the display.



Vehicle overview in the display.

If the reminder appears, buckle the indicated seat belts as soon as possible in a safe manner. Stop the vehicle, if necessary, to avoid distracted driving.

In some cases, the sensors may mistake an object on the seat for a passenger and alert you if the seat belt hasn't been fastened. If you dismiss these reminders in the display, the large graphic will disappear, but the other warning indicators will remain active. Buckle the seat belt to remove them.

 **Warning**

Always make sure everyone in the vehicle wears their seat belt.

## 5.5. Airbags

There are several airbags that your vehicle can deploy in a collision. They can help reduce the impact forces experienced by occupants.



The image shows a selection of available airbags. Continue reading for details on the airbags in your vehicle.

The airbags are designed to work with the rest of the vehicle's safety features. Their effectiveness especially relies on proper seating and seat belt use. An airbag deployment is a sudden, forceful but controlled event that can significantly lower the risk of serious injury for correctly seated occupants.

 **Warning**

The airbags cannot work as intended in the event of a collision if an occupant is incorrectly seated. Always use seat belts.

Sensors throughout your vehicle allow it to deploy different airbags based on information about the collision itself, as well as the status of the vehicle and its occupants.

### Airbag types

The content of this manual represents the status of the user manual at the time of printing and may not be completely valid in future instances. For more information refer to the first page for the complete disclaimer note.

Your vehicle has the following airbag types:

- Front airbags** Frontal collision airbags for the front occupants.
- Side airbags** Seat-integrated side-on collision airbags for the front occupants.
- Inflatable curtains** Ceiling-mounted airbags for occupants seated by a window.

---

## 5.5.1. Airbag deployment

If an airbag has deployed, your vehicle needs to be recovered and serviced.

When the vehicle deploys an airbag, it inflates almost instantly with considerable force, accompanied by a loud noise. After that point, it behaves differently depending on the type of airbag. The front and side airbags deflate as they are compressed and provide controlled cushioning for a single severe impact. The inflatable curtains stay inflated longer to protect against repeated impacts.



### Warning

#### Airbag-related injuries

No safety feature can prevent all possible injuries in a collision. The airbags are designed to reduce the risk of severe injuries. Impacting an airbag often results in some form of injury, and several factors affect the type and severity of the injury. Reading the user manual allows you to recognize and avoid practices known to increase the risk of injury.

To reduce the risk of airbag-related injuries in a collision:

- Follow the user manual's instructions for proper seating and use of seat belts.
- Learn the placement of all airbags and how they affect the use of your vehicle.
- Do not store or place any objects in the airbag deployment areas.
- Do not make any modifications to the interior or electrical systems of your vehicle that are not approved by Volvo.



### Note

#### Deployment conditions

Not all airbags may deploy in a collision. This is because different airbags require different conditions and forces to deploy. The severity of damage to the vehicle after a collision is not a reliable indicator of whether any airbags should have deployed.

#### Airbag gases and smoke

- The gas inside an airbag contains smoke that releases into the interior compartment when the airbag deflates.
- Always be attentive to signs of fire after a severe collision, but keep in mind that some smoke is normal if an airbag has deployed.

## After airbag deployment

After a collision in which the airbags have deployed, prioritize the safety and medical needs of those involved in the accident. Before handling the vehicle, contact an authorized Volvo workshop. Follow the user manual's instructions for safe handling and recovery of a vehicle that is immobilized or in safety mode.

 **Important**

### Safety mode

The vehicle can enter safety mode after certain collisions, even without airbag deployment. The traction power supply is cut off in safety mode, and the vehicle cannot be driven.

Do not try to move the vehicle in safety mode. If the vehicle poses an acute traffic hazard and is able to move, an exception can be made to move it a short distance out of immediate danger. Tow mode needs to be activated before towing the vehicle.

## 5.5.2. Front airbags

The front airbags are designed to deploy in certain frontal collisions. An occupant sensor controls whether the front passenger airbag is enabled or disabled.

The front airbags can help protect the driver and front passenger from severe injury if they are properly seated during a collision. The airbags on each side deploy independently of one another.



The driver side airbag is packed inside the steering wheel.

The passenger side airbag is packed behind a panel on the dashboard.

All front airbag locations are marked with the text AIRBAG or SRS AIRBAG.





### Warning

#### Do not block the front airbags

- Do not place luggage, children or pets in the space between the seated occupant and the front airbags, including in the occupant's lap.
- Legs or feet must never be placed on the dashboard. This could endanger life or lead to serious injury.
- Do not place or mount any items on the dashboard. Even small objects can become dangerous projectiles in a collision and end up between inflating airbags and occupants.

#### Blocking airbags in general

Keep all airbag locations and expansion spaces free of obstructions. Obstructions can reduce airbag effectiveness and cause serious injury.

- Follow the instructions for a correct sitting posture.
- Properly stow luggage and other objects. The vehicle has several luggage compartments for safe stowing.
- Do not modify or mount accessories onto any panel covering an airbag or adjacent panels.

## Passenger airbag status

The vehicle is equipped with an occupant sensor that controls whether the passenger airbag is enabled or disabled. In addition to the passenger airbag, the system also controls the status of the passenger seat side airbag, as well as the driver's seat inner side airbag. Read its separate section for detailed information about sensor-controlled airbag status.

If the occupant sensor has disabled the front passenger airbag, the status will be shown in the overhead console.



This icon indicates that the passenger airbag is disabled and cannot be deployed by the vehicle.



### Warning

#### Child restraints and front passenger seat

Never use a child restraint in the front passenger seat. Volvo follows NHTSA's and Transport Canada's recommendations and recommends that all children up to and including 12 years of age sit in the rear seat. This is a particularly strong recommendation for children in rearward-facing child restraints.



### Tip

#### Read everything about airbags

There is more information about airbags and safety in general. Make sure you have read everything about these topics so that you understand the capabilities and limitations of your vehicle's safety features.

## 5.5.2.1. Sensor-controlled passenger airbag status

The vehicle has a system for detecting the presence of a correctly seated occupant in the front passenger seat. It includes a weight sensor built into the seat. The system disables the front passenger's airbags under certain conditions. When disabled, the airbags will not deploy in a collision.

The vehicle determines whether the front passenger airbag should be enabled or disabled. This requires that the seat be used as Volvo intended. Follow all available recommendations about proper seating and use.

### **Warning**

Always check the status if you are not sure whether the front passenger airbags are enabled or disabled. If the passenger airbag is disabled, this will be visible in the overhead console.

### **Note**

#### Child seating recommendations

Volvo follows NHTSA's and Transport Canada's recommendations and recommends that all children up to and including 12 years of age sit in the rear seat. This is a particularly strong recommendation for children in rearward-facing child restraints.

## Conditions for enabled and disabled airbag

The front passenger airbag status depends on the sensor reading of the occupant's presence and classification.

| Classification of passenger in front passenger seat         | Front passenger airbag status   |
|---|---|
| Classified as an adult person.                              | Enabled   |
| Classified as a child in a forward-facing child restraint.  | Enabled or disabled depending on several parameters that determine the most suitable status |
| Classified as a child in a rearward-facing child restraint. | Disabled  |
| Classified as empty.  | Disabled  |

Pay close attention to the airbag status in the overhead console. When the passenger airbag is disabled, this is communicated with a symbol and the text PASSENGER AIRBAG OFF.



Symbol indicating disabled airbag

## Safe and correct use

 **Warning**

Pay attention to the occupant classification system<sup>[1]</sup>. Failure to follow these instructions could adversely affect the system's function, lead to incorrect airbag status and result in serious injury of an occupant.

- Do not place any objects that add to the total weight on the seat when it is occupied.
- Do not use the seat belt in a way that exerts more pressure on the passenger than normal.
- The full weight of the front-seat passenger should always be on the seat cushion. The passenger should never lift themselves off the seat cushion using the armrest in the door or the center console, by pressing their feet on the floor, by sitting on the edge of the seat cushion or by pressing against the backrest in a way that reduces pressure on the seat cushion.
- Never wrap the seat belt around an object on the front passenger's seat.
- Do not place any object around or under the front passenger's seat in such a way that jamming, pressing or squeezing occurs between the object and the front seat.

<sup>[1]</sup> OCS

### 5.5.3. Side airbags

The side airbags are designed to deploy in the event of a side-on collision.

The side airbags can help protect the driver and front passenger, if they are properly seated, in certain side-on collisions. The outer side airbag will typically only deploy on the collision side of each front seat. The inner side airbag, which is only installed on the driver seat, will typically deploy in the event of a side-on collision on either side of the vehicle.



Side-on collision airbags for the front occupants.

The side airbags are packed into the sides of the seat's back frame. Both front seats have outer side airbags, but the driver seat also has an inner side airbag.

Both front seats have markings with the text AIRBAG.

 **Warning**

### Do not block the side airbags

- Do not place any objects on either side of the front seats. Objects between the seats and the door panel, or between the seats and the tunnel console, can interfere with the side airbags.
- Do not use seat covers that have not been approved by Volvo.

### Blocking airbags in general

Keep all airbag locations and expansion spaces free of obstructions. Obstructions can reduce airbag effectiveness and cause serious injury.

- Follow the instructions for a correct sitting posture.
- Properly stow luggage and other objects. The vehicle has several luggage compartments for safe stowing.
- Do not modify or mount accessories onto any panel covering an airbag or adjacent panels.

 **Tip**

### Read everything about airbags

There is more information about airbags and safety in general. Make sure you have read everything about these topics so that you understand the capabilities and limitations of your vehicle's safety features.

## 5.5.4. Inflatable curtains

Your vehicle's inflatable curtains help protect occupants seated by a window in certain collisions. They are placed above the doors on both sides of the vehicle.

The inflatable curtains are designed to help protect the head of a properly seated and secured occupant. Unlike conventional airbags, the inflatable curtains stay inflated for an extended time after deployment.



Inflatable curtain deployed on one side of the vehicle.

The inflatable curtains are packed behind panels along the ceiling's edges on both sides of the vehicle. The panels are marked IC AIRBAG.

 **Warning**

#### Do not block the inflatable curtains

- Do not hang heavy items from the ceiling hooks or handles. The hooks are meant for light coats and jackets.
- Do not modify or mount accessories to the panels covering the inflatable curtains, the ceiling, pillars or adjacent panels.

#### Blocking airbags in general

Keep all airbag locations and expansion spaces free of obstructions. Obstructions can reduce airbag effectiveness and cause serious injury.

- Follow the instructions for a correct sitting posture.
- Properly stow luggage and other objects. The vehicle has several luggage compartments for safe stowing.
- Do not modify or mount accessories onto any panel covering an airbag or adjacent panels.

 **Tip**

#### Read everything about airbags

There is more information about airbags and safety in general. Make sure you have read everything about these topics so that you understand the capabilities and limitations of your vehicle's safety features.

## 5.5.5. Airbag maintenance and servicing

Contact an authorized Volvo workshop if there is any indication of faults or damage to the airbags or other safety systems.

Any servicing or repairs of the airbags and related safety systems must be performed by authorized service technicians.<sup>[1]</sup> Never attempt to alter or repair any part of the vehicle's safety systems yourself. Incorrectly performed repairs can lead to malfunctions and serious injury. Contact an authorized Volvo workshop when your vehicle needs servicing or repairs.



### Warning

#### Vehicle modifications and airbags

Modifications to the vehicle risk affecting airbags and other safety systems. Carefully read the section about vehicle modifications, and contact Volvo <sup>[2]</sup> if you are considering modifying your vehicle in any way <sup>[3]</sup>, such as when accommodating a disability.

#### Airbags and water damage

If the vehicle has been flooded or the interior has been exposed to excessive amounts of water, there may be water damage affecting the safety systems. This can lead to unintentional airbag deployment and cause injury.

- Do not use the vehicle if you suspect it has water damage.
- Contact Volvo Assistance for recovery support.



### Note

A warning appears in the driver information area of the display if the vehicle detects any airbag faults. Immediately contact an authorized Volvo workshop if this happens.



SRS warning symbol

<sup>[1]</sup> Volvo recommends an authorized Volvo workshop for any repairs or servicing.

<sup>[2]</sup> You can find detailed contact information in a separate section in this manual or by contacting Volvo support.

<sup>[3]</sup> This applies to all parts of the vehicle, but the front seats and all airbag locations are especially necessary to consider.

## 5.5.6. Airbag labels

The airbag labels in your vehicle provide essential information about the airbags or can act as airbag location markers.

### Airbag location labels

Places in your vehicle marked either AIRBAG, IC AIRBAG or SRS AIRBAG indicate that there is an airbag in that location.



**Warning**

#### Airbag label locations

The airbag label locations tell you where your vehicle's airbags are located. Keep these locations and the space around them free of objects. Obstructions can interfere with airbag deployment, reduce their effectiveness and cause serious injury. The airbags section contains more detailed information about use and conditions that can affect the airbags.

### Airbag information labels

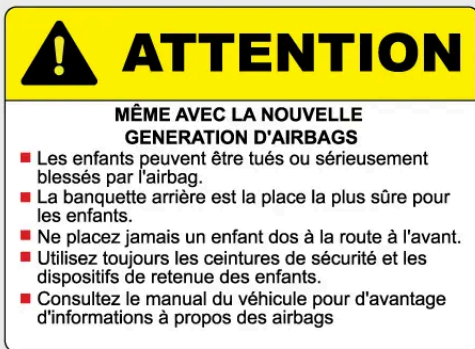

This label is located on the front passenger side sun visor.



This label is located on the front passenger side sun visor.



### Warning

#### Child restraints and front passenger seat

Never use a child restraint in the front passenger seat. Volvo follows NHTSA's and Transport Canada's recommendations and recommends that all children up to and including 12 years of age sit in the rear seat. This is a particularly strong recommendation for children in rearward-facing child restraints.

## 5.6. Child safety

Several features in the vehicle aim to increase child safety, including anchor points for child restraint installation and child locks.

Children in the vehicle should always be securely seated and kept under adult supervision. Follow the recommendations in this manual, as well as local regulations and recommendations that apply to you.



### Warning

#### Securely seated

- Children should be securely seated in a child restraint or with the vehicle's seat belt, depending on their age and size. Never let a child sit in the lap of another passenger or in a location not intended for passengers.
- Other occupants in the vehicle should be properly seated and use their seat belts correctly. This can help prevent serious injury to children in the vehicle in situations, ranging from sudden braking to severe collisions.

#### Under supervision

- Never leave children alone in the vehicle. Children may be exposed to potentially harmful temperatures on hot or cold days, or may lock themselves in.
- Do not allow children to play in the vehicle or play with any of the vehicle's controls. This reduces the risk of injury to the child or inadvertent activation or deactivation of the vehicle's features.

### 5.6.1. Child restraints

Children should always use suitable child restraints and be securely seated in the vehicle according to given recommendations.

Different types of child restraints are specifically designed for certain age and height ranges. Your vehicle is equipped with child restraint attachment points that suit different types of child restraints.

Volvo follows NHTSA's and Transport Canada's recommendations and recommends that all children up to and including 12 years of age sit in the rear seat. This is a particularly strong recommendation for children in rearward-facing child restraints.



Child restraints are classified into different approval levels:

|                         |   |
|-------------------------|---|
| <b>Universal</b>        | A child restraint of this approval level can be installed on a seat in any vehicle model, as long as the vehicle seat position is suitable for universally approved child restraints according to the vehicle's manual. |
| <b>Vehicle specific</b> | A child restraint of this approval level can be installed on a seat in specific vehicle models, as long as the child restraint manufacturer has included the vehicle model in the type list for the specific restraint. |

 **Warning**

### Child restraints and front passenger seat

Never use a child restraint in the front passenger seat. Volvo follows NHTSA's and Transport Canada's recommendations and recommends that all children up to and including 12 years of age sit in the rear seat. This is a particularly strong recommendation for children in rearward-facing child restraints.

### Damaged and old child restraints

Never use or reuse a child restraint:

- if the restraint has been involved in an accident or is damaged in any way
- if the expiration date or service life of the restraint has been exceeded
- if you don't know the full history of the restraint.

 **Important**

### Loose child restraints

Never leave a loose child restraint in the passenger compartment. When not in use, keep it installed according to the manufacturer's instructions or store it securely in the trunk. A loose child restraint can cause damage in the event of a collision or sudden braking.

### General safety recommendations

When applicable, follow the general safety recommendations regarding seat belt use, headrest adjustment and proper seating.

### Local regulations

Regulations on where and how children should be seated and secured differ between regions. Make sure that you know what applies to the region you are in.

## Child restraint registration and recalls

Child restraints could be recalled for safety reasons. You must register your child restraint to be reached in a recall. To stay informed about child safety seat recalls, be sure to fill out and return the registration card that comes with new child restraints.

Child restraint recall information is readily available in both the U.S. and Canada.

For recall information in the U.S., call the U.S. Government Auto Safety Hotline at 1-800-424-9393 or go to <https://www-odi.nhtsa.dot.gov/owners/SearchSafetyIssues> [<https://www-odi.nhtsa.dot.gov/owners/SearchSafetyIssues>].

In Canada, visit Transport Canada's Child Safety website at <https://www.tc.gc.ca/en/services/road/child-vehicle-seat-safety.html> [<https://www.tc.gc.ca/en/services/road/child-car-seat-safety.html>].

The content of this manual represents the status of the user manual at the time of printing and may not be completely valid in future instances. For more information refer to the first page for the complete disclaimer note.

## Airbag information labels



This label is located on the front passenger side sun visor.



This label is located on the front passenger side sun visor.

---

### 5.6.1.1. Installing child restraints

When installing and using a child restraint, there are several things to keep in mind, depending on the location of the child restraint in your vehicle.

#### Warning

##### Child restraints and front passenger seat

Never use a child restraint in the front passenger seat. Volvo follows NHTSA's and Transport Canada's recommendations and recommends that all children up to and including 12 years of age sit in the rear seat. This is a particularly strong recommendation for children in rearward-facing child restraints.

 **Important**

### Local regulations

Regulations on where and how children should be seated and secured differ between regions. Make sure that you know what applies to the region you are in.

### Manufacturer's instructions

Always follow the instructions from the manufacturer of the child restraint.

## 5.6.1.1.1. Installing child restraints in the outer rear seat positions

To securely install a child restraint on either of the outer rear seats, there is important information to read and recommendations to follow.

ISOFIX<sup>[1]</sup>, top and lower tether attachment points can be used when installing a child restraint on the outer rear seats.

 **Tip**

Long-term use of a child restraint may cause wear and tear on the vehicle interior. Use a kick guard accessory to protect the vehicle interior.

### Allowed child restraints

- Only use child restraints that are recommended by Volvo, universally approved or are vehicle-specific approved, where the vehicle is included in the child restraint manufacturer's vehicle list.

### Seat preparations

- Remove cushion extenders, leg supports and other accessories from the seat before installing a child restraint. If you use a kick guard accessory, this can remain on the seat.
- Child restraint support legs, if any, should always be mounted directly to the floor. Do not fit support legs to any raised or uneven floor surfaces, footrests or other objects. Adjust the position of the seat in front, if necessary, to get enough space.
- Loose objects should not be stored around any support legs of a child restraint.
- Any restraining straps for a child restraint should always be secured to designated attachment points. Do not secure restraining straps to seat rails, handles or other parts of the interior.
- When installing an adjustable, rearward-facing child restraint, adjust the child restraint according to the child's age. Older children should be seated in a more upright position than younger ones.
- When installing a forward-facing child restraint, make sure you adjust the headrest of the seat to the child's height. Even if the child restraint includes a head support, it might not have been built to withstand the forces involved in a collision.

### Seat belt us

- When installing a child restraint secured using the vehicle's seat belt, or when the vehicle's seat belt is used to secure a child, make sure that brackets or other parts of the restraint do not come into contact with the seat belt buckle release button.
- If you use the vehicle seat belt when installing a child restraint, you can set the seat belt to only retract. Read more about this in a separate section of the manual.

 **Warning**

### Follow the instructions

Take extra care to read all information about child safety in this manual and follow the instructions from the manufacturer of your child restraint. If you do not, the child could sustain serious injury in the event of an accident.

 **Important**

Follow the general recommendations for any child restraint attachment points used to install a child restraint.

- 1 Follow the instructions from the manufacturer to install the child restraint.

 **Note**

### Installation questions

If you have installation questions, contact the manufacturer of the child restraint for more detailed instructions.

### Protecting the vehicle interior

During installation, be careful to avoid damage to the vehicle interior caused by protruding parts or sharp edges on the child restraint.

- If the child restraint uses lower tether straps, never adjust the position of the front seats after the straps have been secured to the lower tether attachment points. Always remember to remove the straps when the child restraint is not installed.
- Fasten loose parts of child restraints, such as restraining straps, according to the manufacturer's instructions.

 **Important**

### Raised headrest

The headrest must always be raised when a child restraint is installed.

### General safety recommendations

When applicable, follow the general safety recommendations regarding seat belt use, headrest adjustment and proper seating.

### Local regulations

Regulations on where and how children should be seated and secured differ between regions. Make sure that you know what applies to the region you are in.

<sup>[1]</sup> Also known as LATCH or LUAS

---

## 5.6.1.1.2. Installing child restraints in the center rear seat

To securely install a child restraint in the center rear seat, there is important information to read and recommendations to follow.

Top tether attachment points can be used when installing a child restraint on the center rear seat.

 **Tip**

Long-term use of a child restraint may cause wear and tear on the vehicle interior. Use a kick guard accessory to protect the vehicle interior.

### Allowed child restraints

- Only use child restraints that are recommended by Volvo, universally approved or are vehicle specific approved where the vehicle is included in the child restraint manufacturer's vehicle list.
- Child restraints that use support legs are not allowed on the center rear seat.

### Seat preparations

- Remove cushion extenders, leg supports and other accessories from the seat before installing a child restraint. If you use a kick guard accessory, this can remain on the seat.
- Any restraining straps for a child restraint should always be secured to designated attachment points. Do not secure restraining straps to seat rails, handles or other parts of the interior.
- When installing an adjustable, rearward-facing child restraint, adjust the child restraint according to the child's age. Older children should be seated in a more upright position than younger ones.

- When installing a forward-facing child restraint, make sure you adjust the headrest of the seat to the child's height. Even if the child restraint includes a head support, it might not have been built to withstand the forces involved in a collision.

#### Seat belt us

- When installing a child restraint secured using the vehicle's seat belt, or when the vehicle's seat belt is used to secure a child, make sure that brackets or other parts of the restraint do not come into contact with the seat belt buckle release button.
- If you use the vehicle seat belt when installing a child restraint, you can set the seat belt to only retract. Read more about this in a separate section of the manual.

#### **Warning**

##### Follow the instructions

Take extra care to read all information about child safety in this manual and follow the instructions from the manufacturer of your child restraint. If you do not, the child could sustain serious injury in the event of an accident.

#### **Important**

Follow the general recommendations for any child restraint attachment points used to install a child restraint.

- 1 Follow the instructions from the manufacturer to install the child restraint.

#### **Note**

##### Installation questions

If you have installation questions, contact the manufacturer of the child restraint for more detailed instructions.

##### Protecting the vehicle interior

During installation, be careful to avoid damage to the vehicle interior caused by protruding parts or sharp edges on the child restraint.

- Fasten loose parts of child restraints, such as restraining straps, according to the manufacturer's instructions.

**!** Important

### General safety recommendations

When applicable, follow the general safety recommendations regarding seat belt use, headrest adjustment and proper seating.

### Local regulations

Regulations on where and how children should be seated and secured differ between regions. Make sure that you know what applies to the region you are in.

## 5.6.1.2. Child restraint attachment points

Your vehicle has different types of attachment points. Be sure to use the correct attachment points for your specific child restraint.

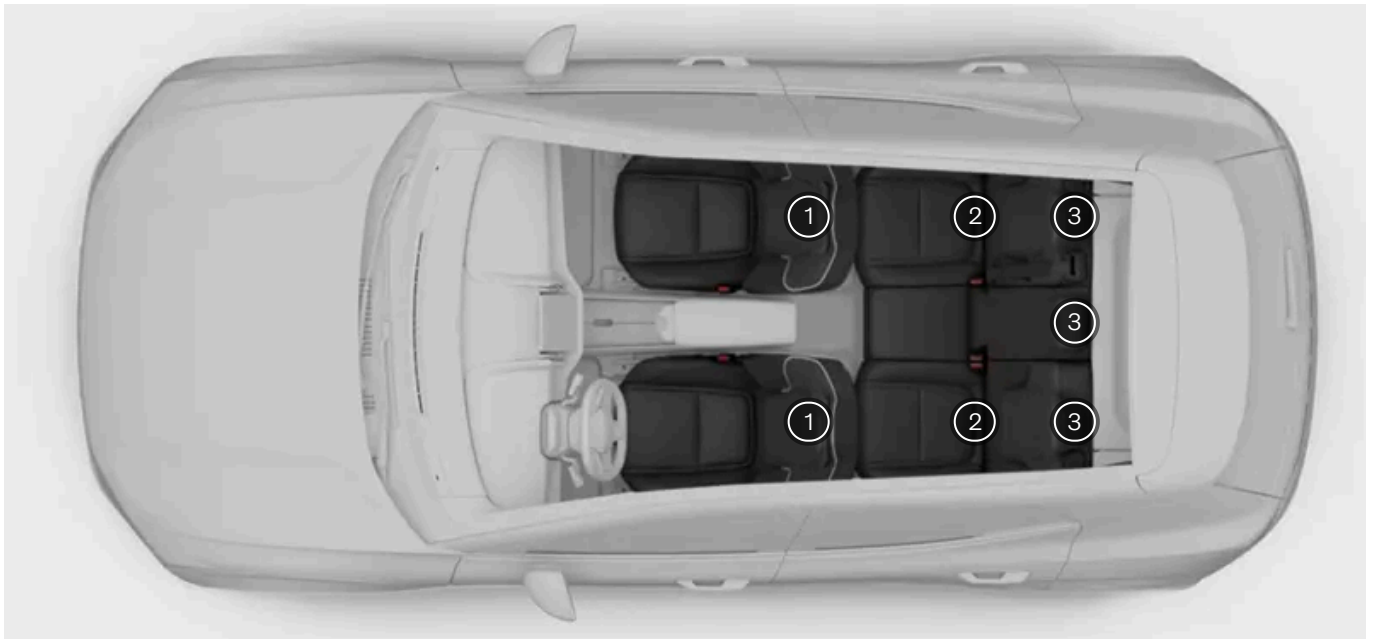

- ① Lower tether attachment points on the floor rails of the front seats
- ② ISOFIX attachment points in the lower part of the backrests of the rear seats
- ③ Top tether attachment points on the backs of the rear seats

Your vehicle's various attachment points can be used in combination with each other or together with other fastening methods to secure different types of child restraints.

ISOFIX, also known as LATCH or LUAS, is an international standard for child restraint attachment points that can be used in combination with the top tether attachment points or a support leg.

Some child restraints are secured using a vehicle seat belt, usually in combination with other fastening methods.

**Note**

**Manufacturer's instructions**

When using attachment points, always follow the instructions from the manufacturer of the child restraint.

### 5.6.1.2.1. LATCH attachment points

Your vehicle is equipped with ISOFIX<sup>[1]</sup> attachment points that can be used to secure child restraints on a rear seat.

The ISOFIX<sup>[1]</sup> attachment points can be used in combination with other fastening methods to secure ISOFIX<sup>[1]</sup> child restraints. These attachment points are part of an international standard for child restraints.

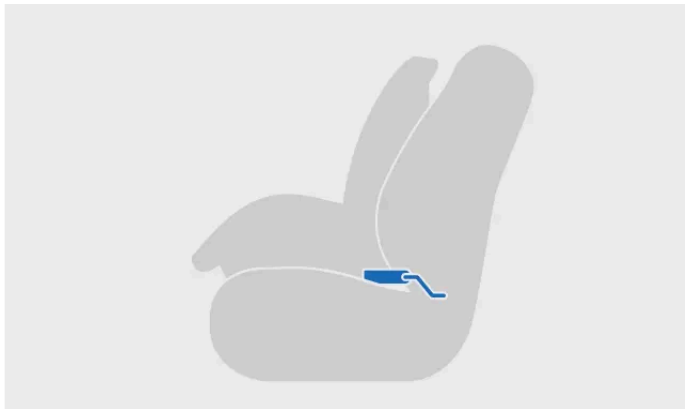

Child restraint installed using ISOFIX<sup>[1]</sup>



Attaching to ISOFIX<sup>[1]</sup> attachment point

Child restraints installed in the outer rear seats can use these attachment points.



**i Note**

ISOFIX is an international standard for child restraint attachment points. It is also known by other regional names such as LATCH and LUAS.



The ISOFIX<sup>[1]</sup> attachment points for the rear seats are located behind a flap in the lower part of the backrest on the outer rear seats. The flap needs to be unfolded to access the anchor points behind it.

**i Note**

The unfolded flap should lie flat between the seat cushion and an installed child restraint.

The anchor locations are indicated by the ISOFIX symbol.



**i Note**

**Manufacturer's instructions**

When using attachment points, always follow the instructions from the manufacturer of the child restraint.

<sup>[1]</sup> Also known as LATCH or LUAS

---

## 5.6.1.2.2. Top tether attachment points

Your vehicle is equipped with top tether attachment points that can be used to secure child restraints in a rear seat.

The top tether attachment points can be used in combination with other fastening methods to secure different types of child

restraints.

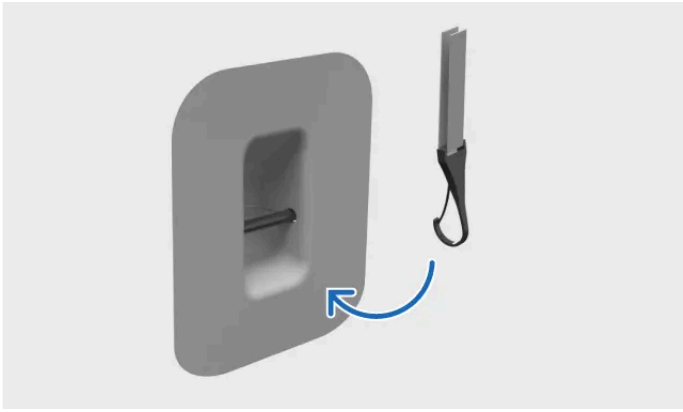

Fastening tether to top tether attachment point

Child restraints installed in any rear seat can use these attachment points.

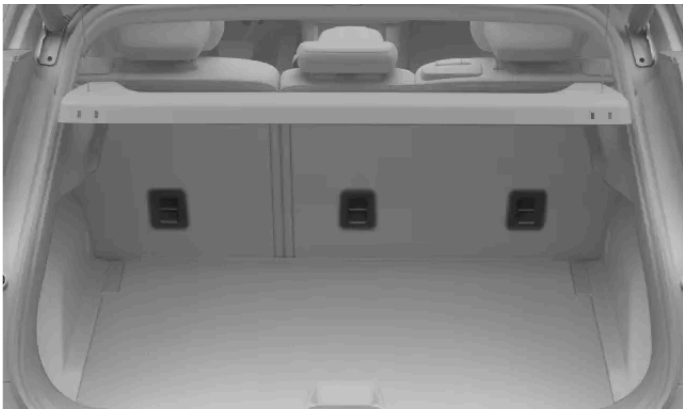

The top tether attachment points for the rear seats are located on the back of the rear seats.

The anchor locations are indicated by the top tether symbol.



**!** Important

### Manufacturer's instructions

When using attachment points, always follow the instructions from the manufacturer of the child restraint.

### Parcel shelf

If the parcel shelf is installed behind the rear seats, the narrow gap between backrest and parcel shelf can make it difficult to attach the top tether strap. If necessary, remove the parcel shelf temporarily to make installation easier. Always make sure the parcel shelf is not in contact with the top tether strap.

### 5.6.1.2.3. Lower tether attachment points

Your vehicle is equipped with lower tether attachment points that can be used to secure child restraints on a rear seat.

The lower tether attachment points are mainly used together with the vehicle seat belt to secure certain rearward-facing child restraints.

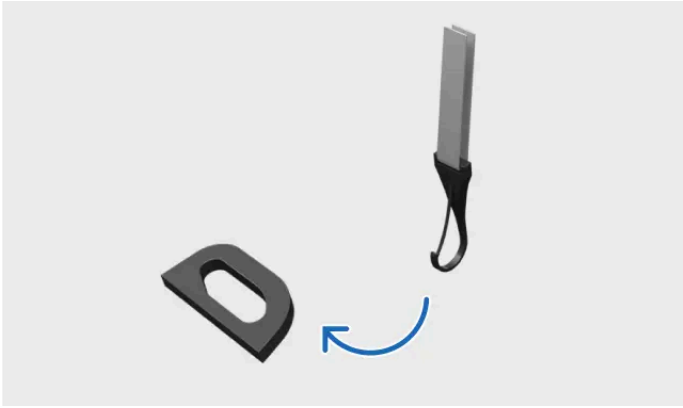

Fastening tether to lower tether attachment point

Child restraints installed in any rear seat can use these attachment points.

#### Tip

It is possible to attach two lower tether straps from different child restraints to the single lower tether anchorage point closest to the center of the vehicle, such as when installing two rearward-facing child restraints next to each other.

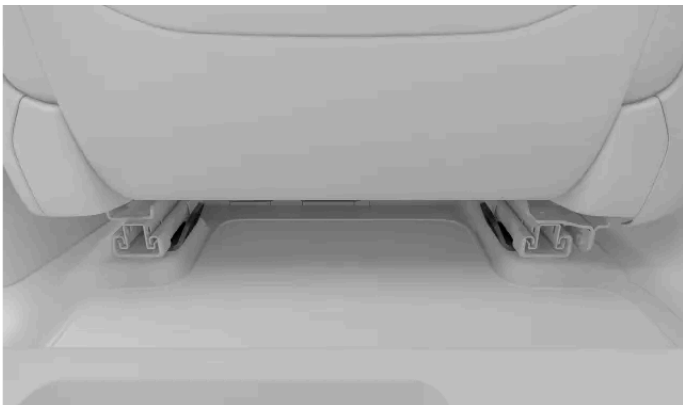

The lower tether attachment points for the rear seats can be found at the back of the floor rails of the seats in front.

#### Note

##### Manufacturer's instructions

When using attachment points, always follow the instructions from the manufacturer of the child restraint.

## 6. Entry and security

Learn about the various features associated with entering and exiting the vehicle, including how the keys and alarm work.

This section of the manual covers the different types of keys, opening and closing the doors, locking and unlocking, and the alarm.

Learn more about the different types of keys and how you can customize your vehicle's responses when you lock, unlock, approach or leave it.

---

### 6.1. Keys

Your vehicle supports several types of keys. Some keys can be sensed by the vehicle as you approach or leave it, whereas key cards need to be placed on the driver's door pillar.

#### Important

Using keys is fairly straightforward, but you should be aware of the limitations of each key type for safety and security reasons. Therefore, it is important to read all of the information in this manual about keys and how to use them.

Vehicle and key wireless technologies may cause disturbances in other devices. You can find more information about these systems in the specifications section of this manual.

For safety and security reasons, never leave unattended keys in an exposed place.

The vehicle supports the following types of keys:

- Digital key
- Key card
- Key tag

Charged key tags and digital keys are distance-capable, meaning your vehicle can detect them when you approach or leave it. This allows for automatic locking and unlocking.

Keys without power, such as a key card or a distance-capable key with a discharged battery, use NFC<sup>[1]</sup>. This means they can only be read at specific key reading locations.

#### Note

##### Ordering new or additional keys

Your vehicle comes with a limited number of keys. Contact a Volvo retailer if you lose a key or simply require additional keys.

### Key reading locations

The content of this manual represents the status of the user manual at the time of printing and may not be completely valid in future instances. For more information refer to the first page for the complete disclaimer note.

There are two ways your vehicle can detect your key and use it to lock or unlock:

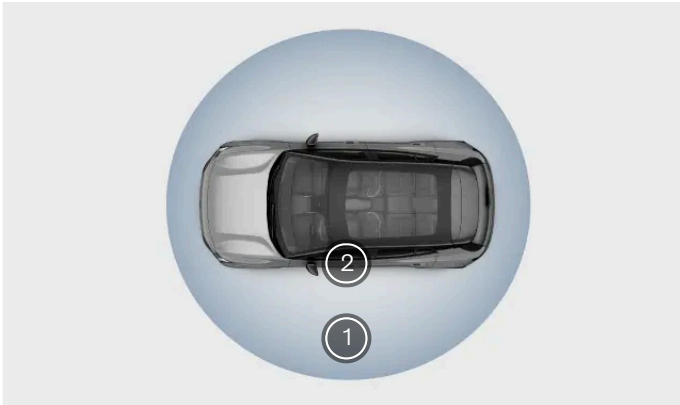

- ① Distance-capable keys can lock or unlock the vehicle from a distance.
- ② Key cards require physical contact with the vehicle.

There is also a card reader between the front seats where you can place a key card or a discharged distance-capable key to start the vehicle.

## User profiles and keys

You can assign keys to a user profile. This allows the vehicle to automatically identify the person unlocking it and apply all of their customizations. You can read more about which customization options are available in a separate section of this manual.

### Note

#### Unresponsive vehicle

If the vehicle has been turned off for a long time, it may take several seconds for it to unlock. This is because the vehicle needs time to turn its systems back on, to recognize the key and to give you access.

If the vehicle's batteries are drained down completely, it will not respond to any key.

## Locking keys in

If you lock the vehicle while a distance-capable key is still inside, that key's distance capability will be temporarily deactivated. You can still use one of your other keys on the driver's door pillar to enter the vehicle.

### Important

When the vehicle is locked, key cards can still be used to start the vehicle. For safety and security reasons, never leave unattended keys in an exposed place.

 **Warning**

Improper use of vehicle opening and starting systems can result in serious personal injury. Always take your keys with you when you leave the vehicle, including distance-capable keys. The vehicle can be started, and systems such as the power windows can be operated, leading to serious personal injury. Never leave children, disabled persons or anyone who cannot help themselves in the vehicle. The doors can be locked using a distance-capable key or by touching the capacitive lock sensor area of the door handle. This could result in people being trapped in the vehicle in an emergency. For example, depending on the time of year, people trapped in the vehicle can be exposed to very high or low temperatures.

The keyless entry system for distance-capable keys may sometimes be affected by other devices or signals. Key reading signals can be blocked or affected by proximity to wireless emissions from powerful interference sources such as telecommunication towers or power stations.

Do not place the key tag near a smartphone, Bluetooth earphones or other similar devices; they can cause signal interference to the keys.

Keep your key card away from devices such as smartphones while charging; they can damage the NFC capability in the card.

Key tags and key cards are sensitive to extreme temperatures.

<sup>[1]</sup> Near-Field Communication

---

## 6.1.1. Key tag

You can use your key tag to lock, unlock and drive the vehicle.



The key tag works at a distance to lock, unlock and start the vehicle, but it can also be used in the same way as a key card.

If the vehicle doesn't detect your key tag, it may be due to signal interference or low battery. In that case, you can still use it like

a key card. Place it on the driver's door pillar with the logo facing towards you to lock or unlock the vehicle.



To start your vehicle using the key tag, just keep it with you inside the vehicle.

**!** Important

If your key tag has a discharged battery or suffers signal interference, you can place it on the key reader between the front seats and the vehicle will be ready to drive. This is because the wireless charger also works as a card reader by using NFC<sup>[1]</sup>. Keep this in mind if you leave the vehicle momentarily unattended, especially if there are occupants in the vehicle.

**i** Note

You can replace the key tag battery. It uses a CR2450 battery.

Be aware that the signals between the key and the vehicle can be affected by obstacles or interference from other signals.

If you are in close proximity to the vehicle for long periods of time without opening the driver's door, there might be a delay when you try to open or unlock the vehicle using the driver's door handle. If the vehicle doesn't immediately unlock or open, this is normal. Just wait a few seconds and try again.

<sup>[1]</sup> Near-Field Communication

---

## 6.1.1.1. Replacing the key tag battery

You can replace the battery in your key tag when it gets discharged.

If the key tag signal appears to be unreliable, this may be due to a low battery. You can replace the battery yourself. The tag requires a flat CR2450 disc or button battery.

**i Tip**

- You may find it helpful to use a small screwdriver to unlock the tag lid and lift the battery from its slot.
- You only need to replace the key tag battery if you're using the proximity lock feature. If you're only using your key tag like a key card, you don't need to replace the battery.

**! Important**

- For safety reasons and to ensure optimal battery performance, use hand protection such as a medical glove when handling a new battery.
- Used batteries must be recycled in an environmentally sound manner.

**⚠ Warning**

Check that the battery is installed correctly, with the correct polarity. If the key tag won't be used for a long time, remove the battery to avoid battery leakage and damage. Damaged or leaky batteries can cause corrosive injury on contact with the skin. Therefore, use protective gloves when handling old or damaged batteries.

- Keep batteries out of the reach of children.
- Do not leave batteries lying around since they can be swallowed by children or pets.
- Batteries must not be dismantled, short-circuited or thrown into an open flame.
- Do not try to charge non-rechargeable batteries. They may explode.
- Check battery-operated products for signs of damage on a regular basis. The key tag should not be used if anything indicates that the tag or its battery has been damaged or has started to leak.
- Keep defective products out of the reach of children.

**1**



Hold the tag with the Volvo logo facing upwards. There is a small opening on one of the tag's short sides. Pry open the tag from this side by pulling the edge outwards and upwards.

- 2** Lift the tag lid to access the battery.
- 3** Pry the battery from the locking teeth and slide it towards you to remove it.



- 4 Slide the new battery into the slot and press it down to lock it into place. Make sure the positive side of the battery is facing upwards.
- 5 Close the tag lid so that it clicks into place.

If the key tag signal is still unreliable, this may be due to signal interference outside of the vehicle. If the tag fails to work at all, repeat the steps and ensure that a fully-charged battery is properly installed. If you think that you may need a new key tag, contact a Volvo retailer.

---

## 6.1.2. Key card

Your key card can lock and unlock the vehicle, and allows you driving access.



You can lock and unlock the vehicle by placing the key card on the driver's door pillar.



Key reading location on the driver's door pillar.

The key card starts the vehicle when you place it on the card reader located between the two front seats. When you start using the pedals, you can remove the card from the card reader.

If the vehicle is stationary without a card on the card reader for a while, you will need to put the card back on the reader for the vehicle to reactivate driving mode.

**i Note**

The card reader and wireless charger are located in the same place. Therefore, if you have any kind of vehicle key on the card reader, you have to remove it to be able to wirelessly charge a phone.

**! Important**

Do not place cards with NFC<sup>[1]</sup>, such as key cards or electronic payment cards, between the wireless charger and the device when using the charging function. This could damage them.

**! Warning**

The vehicle's use of Bluetooth, UWB<sup>[2]</sup> and NFC signals may cause disturbances in other devices at certain distances.

**i Tip**

### Key card as backup access

If your vehicle is unresponsive when you try to unlock it with a distance-capable key, try unlocking the driver's door with your key card. The key card is designed specifically to also act as a backup in this kind of situation. You will be able to get to any belongings inside even if the other doors don't work. If your vehicle is unresponsive, contact Volvo support.

Keep in mind that if the vehicle battery is discharged, you won't be able to open the doors.

<sup>[1]</sup> Near-Field Communication

<sup>[2]</sup> Ultra-wideband

## 6.1.3. Digital key

You can lock, unlock and start the vehicle using your phone or smart watch as a digital key. The digital key is stored in your phone's wallet app.



With a digital key, your vehicle can recognize your phone or smart watch and automatically unlock or lock the doors when you approach or leave the vehicle. It also lets you lock and unlock the vehicle via the wallet app on your device.

 **Note**

- Some devices might not be compatible with the digital key. If you're not sure if your device supports digital keys, check with your phone's manufacturer.

## Using your digital key

When you set up a digital key on a device with UWB<sup>[1]</sup> capability, you can use it like a key tag. This means that you can unlock the vehicle by grasping the door handle or using the approach unlock feature. To get driving access, you just need to bring your device with you inside the vehicle or place it on the card reader.

If your device doesn't have UWB capability, your digital key works as a key card. Unlock the vehicle by placing the device on the door pillar and start the vehicle by placing the device on the card reader.

## Sharing a digital key

As the vehicle's owner, you can share your digital key with family and friends. You can also delete any shared keys at any time. To share a digital key, look for the sharing icon in your phone's wallet app.

Owners can also share their digital key to another compatible device or move their main digital key to another device: for example, when they get a new phone. You can find these options in the owner's profile settings.

## Digital key on a device with a discharged battery

Your digital key may still work for a while even after the device that it's on has run out of battery.

Whether you can use your digital key when your device has a discharged battery depends on how the key is set up in the wallet app. Contact the device manufacturer for more information.

 **Note**

Sometimes, signal interference may affect distance-capability functions.

If a digital key appears to not be working as intended, try restarting your phone or turn Bluetooth off and on. If you still experience issues, contact Volvo support.

If you're having problems with your connection, make sure that:

- your phone is charged
- there are no obstructions, such as concrete pillars, between the phone and the vehicle
- your vehicle and phone are updated to the latest software version
- any required access settings are selected.



**Tip**

In case of any issues with using your digital key, keep a key card close to hand.

<sup>[1]</sup> UWB (Ultra-wideband)

---

## 6.1.3.1. Creating a digital key

The vehicle owner can create a new digital key at any time in the mobile app for the vehicle.

### Note

#### Digital key availability

Some devices might not be compatible with the digital key. If you're not sure if your device supports digital keys, check with your phone's manufacturer.

You need to be inside the vehicle while setting up your digital key. You also need to make sure that:

- your vehicle is updated to software version 1.5.2 or later
- the mobile app for your vehicle is updated to software version 1.7.4 or later
- the vehicle is stationary and all of the doors are closed
- you have selected the owner's profile<sup>[1]</sup>
- you have connectivity in both your vehicle and your phone
- Bluetooth is enabled on your phone
- you have a valid key with you, such as a key tag or key card.

### Tip

#### Activation link

If you have received an activation link via email, you can also use this link to start the setup process.

- 1 Place your key card on the card reader between the front seats. If you're carrying your key tag, you can just keep it with you in the vehicle.
- 2 Open the mobile app for your vehicle and start the guide.
  - > If pairing is successful, your digital key appears in your phone's wallet app.  
If the setup guide gets interrupted, for example by you getting a phone call, it might fail. If this happens, try turning Bluetooth off and on again on your device before restarting the guide.

## Sharing a key

As the owner, you can share keys with your family and friends. Open your digital key in your phone's wallet app to find the sharing option.

To share your digital key, the person you share it with needs to have the same brand of phone. Their phone also needs to be compatible with the digital key.



Tip

### Moving the key to another device

You can move an existing digital key to another device via the display by accessing the profile settings, selecting the owner profile and then selecting the option to change device.

<sup>[1]</sup> If you aren't the vehicle owner, you can't create your own digital key. You need to ask the owner to share their digital key with you instead.

---

## 6.1.3.2. Deleting a digital key

You can delete digital keys at any time.

### Deleting your own key

Anyone with a digital key can delete and remove it from their phone's wallet.

### Deleting friend keys

The owner can delete a shared key either by using their phone's wallet app or via the display. The key will then be instantly disabled. The owner can also delete all of the digital keys from the vehicle at the same time by selecting **Reset digital keys** in the profile settings.



Note

### Deleting the digital key on a lost phone

It's a good idea to keep a key card with you in case a device with a digital key is lost or stolen. This way, you can still access the vehicle and delete the digital key for the lost device via the display. You can also check with your phone's manufacturer to see if they are able to delete or suspend your digital key remotely.

If you have any shared keys, they will remain active until you remove them manually.

---

## 6.1.4. Key reading locations

There are some key interaction points where your vehicle can detect your keys to let you lock, unlock or drive it.

## Interaction points for keys

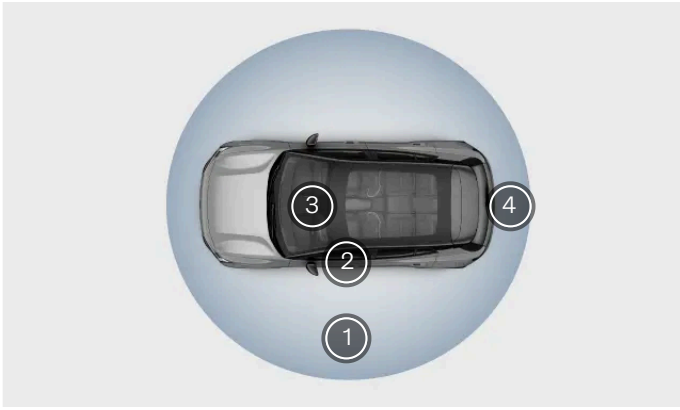

- ① Your vehicle can detect distance-capable keys from a short distance away.
- ② Key reading sensor in the driver's door pillar
- ③ Card reader between the front seats
- ④ Access button on the trunk hatch

## Distance-capable keys

Charged key tags and digital keys are distance-capable, meaning your vehicle can detect them when you approach or leave it. This allows for automatic locking and unlocking. Go to settings to select your preferences and to turn automatic locking and unlocking on or off.

Distance-capable keys also let you lock or unlock the vehicle by using the touch points on the door handle.

### *i* Note

Your distance-capable keys also have NFC<sup>[1]</sup> functionality. This means that even if the distance-capable key's battery is low or discharged, you can still use it as a key card. Therefore, any reference to key card functionality applies to discharged distance-capable keys too.

## Exterior key reader

You can lock and unlock the vehicle by placing any type of key on the key reading sensor in the driver's door pillar.



Key reading location on the driver's door pillar

Make sure the card or device is laid flat against the reader. If you're using a key tag, the logo should be facing towards you.

## Interior key reader

You can place your key card or a discharged key tag on the card reader between the front seats to get driving access.

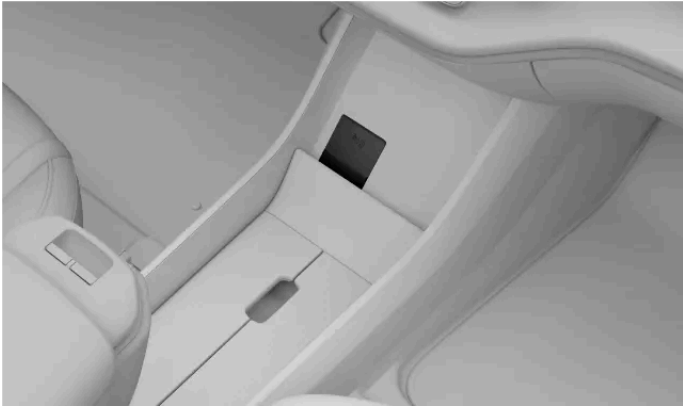

Card reader location

### **Note**

The card reader won't work at the same time as the wireless charger.

<sup>[1]</sup> Near-Field Communication

---

## 6.2. Opening and closing

Your vehicle has a few features and situation-specific behaviors you should be aware of when opening and closing the doors.

### Doors

You open the doors manually, but you can set how the doors unlock and under which conditions via the display.

The rear doors are equipped with a double-pull feature to help protect against accidental opening. To open the rear doors from the inside, you need to pull the door handle twice.

### Hood

The hood is opened using a lever near the driver's seat.

### Trunk

You can open the trunk via the display or using the button on the trunk hatch.



## Open door warning

Regularly check that the hood, trunk and doors are fully closed.



Open doors are highlighted in red on the vehicle symbol in the display. The vehicle will also use warning sounds to indicate improperly closed doors.

---

## 6.2.1. Opening the hood

Opening the hood provides access to the front storage compartment. Be sure to close the hood again before driving the vehicle.

### Location of release lever



The interior lever as seen from the driver's seat.

The lever to open the hood can be found below the dashboard on the driver's side, just in front of the door hinge.

#### Opening the hood

- 1 Pull the hood lever upwards twice.
  - The hood releases from its fully locked position.
- 2 Lift the hood by its front edge and open it to its fully extended height, which is just past a 45-degree angle.
  - The hood will stay in position.

 **Warning**

Do not drive with the hood open

Stop the vehicle immediately if there is any indication that the hood is not completely closed.

 **Note**

Open hood warning

If you see an open hood warning in the display, open the hood and check for obstructions before closing it again.

Contact Volvo support if the notification doesn't go away.

## 6.2.2. Closing the hood

Take extra care to ensure that the hood completely closes after it has been opened.

Make sure nothing gets in the way of the hood as it closes.

### **Warning**

#### Pinching and crushing hazard

Keep all hands away from the hood's closing path. Be extra cautious when children or pets are nearby.

- 1 From the fully opened position, simply pull the hood down by holding the outer edge.
- 2 Carefully lower the hood until it reaches the locking mechanism.



Press down with both hands on the front edge of the hood. Make sure the hood fits into the latches at the same time. Keep the front edge flat as it closes.

> The hood noticeably locks in place on both sides.

- 4 Make sure there are no significant gaps or any indication that the hood is not completely closed.

### **Note**

#### Open hood warning

If you see an open hood warning in the display, open the hood and check for obstructions before closing it again. Contact Volvo support if the notification doesn't go away.

### **Warning**

#### Do not drive with the hood open

Stop the vehicle immediately if there is any indication that the hood is not completely closed.

---

## 6.2.3. Trunk access

Open and close the trunk via the display or the button on the trunk hatch.

### **Warning**

Be aware when the trunk is opening or closing. Make sure that no people are in the vicinity of the trunk when it is in motion. Always use the trunk access functions with caution.

Do not interfere with the trunk support arms; they are highly pressurized, and tampering with them can result in serious injury.

After use, check the display for indications that the trunk is fully closed.

If the vehicle is unlocked, you can open the trunk using the button in the middle of the trunk hatch.

You can also open the trunk from inside the vehicle via the display.

### Button on the trunk's interior



Location of the trunk closing button.



Press the close button on the inner right side of the trunk hatch to close it. Press the button twice to activate a delayed close. The delay is approximately 30 seconds.

You can also use the close button to adjust how far the trunk opens. This is useful if you want the trunk hatch to stay within easy reach or if you are somewhere with a low ceiling, such as a garage.

### Locking with the trunk open

Locking the vehicle with the trunk open will lock all doors and set the alarm only for the closed doors. If you then close the trunk hatch, it will lock and the alarm will be set for the trunk.

## 6.2.3.1. Adjusting trunk opening height

You can adjust how much the trunk hatch opens.

If the vehicle is often in places with a low ceiling, such as a garage, you may want to reduce the trunk opening height. To have more room to access the trunk, you can raise the trunk opening height.

Once adjusted, the trunk hatch will continue to open to the newly set height until changed.

- 1 Open the trunk hatch.
- 2 Adjust the trunk hatch to the desired height using the close button on the inner right side of the trunk hatch.



Use the close button marked with the associated symbol.

To lower the trunk hatch, move it manually to the preferred height, then press the close button to stop it. If you do not press the close button, the hatch will continue to lower until it closes.

To raise the trunk hatch, move it manually to the preferred height.

- 3 Press and hold the close button for a few seconds to set the new height.
- > A chime will confirm that the new height is set.

A height adjustment is saved to the profile being used at that time.

---

## 6.3. Locking and unlocking

You have several options for locking and unlocking the vehicle, depending on what keys you use and which settings are enabled.

### Locking and unlocking from a distance

Your vehicle can unlock and lock automatically when you approach or leave it with a recognized distance-capable key. You can enable or disable this behavior in settings.

#### Important

It is the driver's responsibility to ensure the vehicle is locked, even when automatic functions are enabled.

Vehicle thieves can use frequency jamming to interfere with key functions and prevent vehicles from locking. When you leave your vehicle, always check that the driver door is locked.

### Using the driver's door handle

The content of this manual represents the status of the user manual at the time of printing and may not be completely valid in future instances. For more information refer to the first page for the complete disclaimer note.

If you want to lock or unlock your vehicle manually while still using a distance-capable key, you can use the touch points on the driver's door handle.

To unlock the vehicle, simply grasp the driver's door handle. To lock it, place a finger on the small indentation.

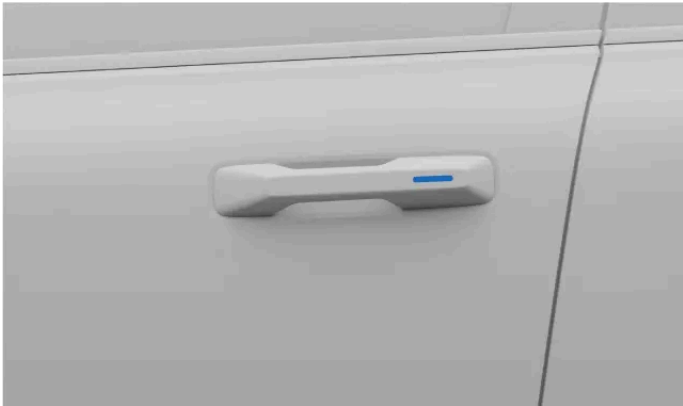

The indentation marks where you can place your thumb or fingers to lock the door.

**Note**

For the touch points to work, you need to keep a recognized distance-capable key where your vehicle can detect it.

To prevent your vehicle from unlocking or locking automatically when you approach or leave it, be sure to disable **Proximity lock** in settings.

If you are in close proximity to the vehicle for long periods of time without opening the driver's door, there might be a delay when you try to open or unlock the vehicle using the driver's door handle. If the vehicle doesn't immediately unlock or open, this is normal. Just wait a few seconds and try again.

## Using the key reader

If you're using a key card or a discharged distance-capable key, you can lock or unlock your vehicle by putting the key on the NFC<sup>[1]</sup> reader in the door pillar.



Key reading location on the door pillar

Make sure the card or device is laid flat against the reader. If you're using a key tag, the Volvo logo should be facing towards you.

## Using the button panels inside the vehicle

The content of this manual represents the status of the user manual at the time of printing and may not be completely valid in future instances. For more information refer to the first page for the complete disclaimer note.

You can lock or unlock your vehicle from inside using the buttons on the armrest between the front seats. The lock and unlock symbols are visible on the buttons.



Lock symbol



Unlock symbol

## Emergency unlock

In the event of a collision, the vehicle will automatically unlock. If the damage to the vehicle is minor, the vehicle can be locked again. With significant damage to the vehicle, you will not be able to lock the vehicle again. In that case, the locking function can only be restored by Volvo technicians<sup>[2]</sup>.

## Child lock

The child lock can increase passenger safety in the rear seats. When the child lock is active, the passengers in the rear seats are unable to open the rear doors. You can read about how to activate the child lock in a separate section of the manual.

## Double pull

The rear doors are equipped with a double-pull feature to help protect against accidental opening. This means that it takes two pulls on the inner door handle to unlock and open the door from inside the vehicle.



Volvo recommends that you do not leave people or pets in a locked vehicle. The driver is always fully responsible for the well-being and safety of anyone left inside.

Some regions have laws prohibiting people or pets being left inside a locked vehicle.

<sup>[1]</sup> Near-Field Communication

<sup>[2]</sup> Volvo recommends an authorized Volvo workshop.

---

## 6.3.1. Activating child lock

You can activate and deactivate the child lock manually.

**!** Important

The child lock does not affect the rear windows. You can lock the rear windows in settings.

When driving with children in the rear seats, check that the rear doors are secured with an active child lock.

The child lock can increase passenger safety in the rear seats. When the child lock is active, the passengers in the rear seats are unable to open the rear doors.



Child lock switch location.

The child locks are accessed from inside the vehicle and are located on the rear doors.

You need a tool, such as a flathead screwdriver, to activate or deactivate the child locks. The direction for enabling or disabling the locks is indicated around the switch.

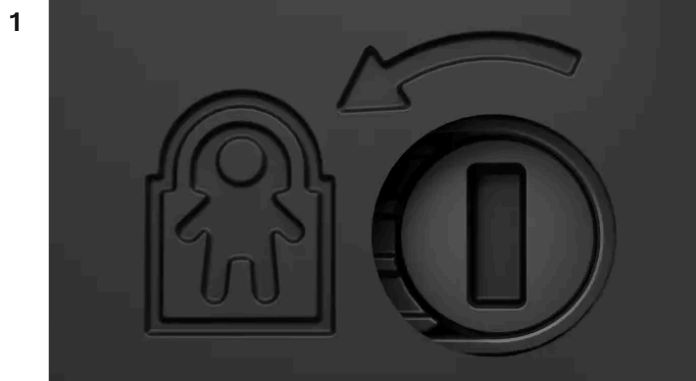

Child lock with turning direction for activation.

Insert a tool into the switch hole.

2 Turn the tool in the indicated direction to enable the lock.

➤ When the lock is enabled, you will hear a click.

## Disabling the child lock

To disable the child lock, use the tool to turn the lock in the direction opposite to the one indicated on the lock.



---

## 6.3.2. Settings for locking and unlocking

You can customize how your vehicle reacts when locking or unlocking.

### Note

Different settings affect how and when your vehicle is locked. Make sure to familiarize yourself with the different options and how they affect the locking and unlocking behaviors.

### Proximity lock

You can choose whether your vehicle should automatically unlock when you approach it and lock when you're walking away from it with the **Proximity lock** setting. For this feature to work, you need to carry a recognized distance-capable key.

### General locking behavior

You can customize many of your vehicle's general locking behaviors. For example, you can turn feedback responses on or off and choose whether all of the doors should unlock automatically when you park.

It's also possible to choose which doors unlock when you use the touch points on the driver's door handle.

### Note

When the **Proximity lock** setting is enabled, all of the doors unlock or lock simultaneously when you approach or leave the vehicle with a distance-capable key. Disable the **Proximity lock** setting if you want to select which doors unlock.

### Presence reminder

The presence reminder setting allows the vehicle to remind you that there might be passengers, pets or belongings still in the vehicle when you open the driver's door after a drive. You can turn these reminders off temporarily.

### Note

Once you disable the presence reminder setting, your vehicle won't give you any reminders until your next drive.

### Warning

Volvo recommends that you do not leave people or pets in a locked vehicle.

Some regions have laws prohibiting people or pets being left inside a locked vehicle.

---

## 6.3.2.1. Adjusting locking and unlocking settings

The content of this manual represents the status of the user manual at the time of printing and may not be completely valid in future instances. For more information refer to the first page for the complete disclaimer note.

You can adjust several of your vehicle's locking and unlocking responses and behaviors in settings.

 **Important**

### Changing locking and unlocking settings

Enabling or disabling certain features affects how and when your vehicle locks and unlocks. Make sure you familiarize yourself with the different key types, as well as the locking and unlocking features. Misunderstanding a feature might lead you to believe that your vehicle is locked when it isn't.

It is the driver's responsibility to ensure the vehicle is locked, even when automatic functions are enabled.

- 1 Press the vehicle symbol  in the bottom bar and go to **Settings**.
- 2 Go to **Controls** → **Locking**.
- 3 Adjust your locking and unlocking settings.

 **Warning**

Volvo recommends that you do not leave people or pets in a locked vehicle.

Some regions have laws prohibiting people or pets being left inside a locked vehicle.

## 6.3.3. Unresponsive lock

If your vehicle doesn't lock or unlock as expected, there are some steps you can try.

 **Note**

If the vehicle's batteries are drained down completely, it will not respond to any key.

If the vehicle has been turned off for a long time, it may take several seconds for it to unlock. This is because the vehicle needs time to turn its systems back on, to recognize the key and to give you access.

### Locking not working

If the vehicle won't lock, check that all of the doors are properly closed.

If you are in close proximity to the vehicle for long periods of time without opening the driver's door, there might be a delay when you try to open or unlock the vehicle using the driver's door handle. If the vehicle doesn't immediately unlock or open, this is normal. Just wait a few seconds and try again.

### Automatic locking not working

The content of this manual represents the status of the user manual at the time of printing and may not be completely valid in future instances. For more information refer to the first page for the complete disclaimer note.

For the vehicle to automatically unlock when you approach and lock when you leave, make sure that:

- **Proximity lock** is enabled in settings.
- your distance-capable key is charged.
- the key's wireless signals are not being blocked.

If your vehicle doesn't respond when you approach it with your distance-capable key, you can try unlocking it by pulling the door handle or placing your key on the key reader in the door pillar.

## Rear doors not unlocking

If the rear doors don't open when you pull the inner door handles, make sure the child lock isn't active and that you pull the handle twice. The first pull unlocks the door and the second pull opens it.

---

## 6.4. Anti-theft

Your vehicle has a number of systems and features which help to make your vehicle secure when it's locked.

When you lock the vehicle, some of its functions and systems are either shut down or activated to help protect the vehicle from theft. For example, the alarm is automatically armed.



### Warning

Do not leave your keys unattended in your vehicle. They can be used to disable the security systems.

## Alarm

The alarm is automatically armed when you lock the vehicle and disarmed when you unlock it.

You can adjust the alarm sensitivity in settings.

## Immobilizer

The immobilizer is an anti-theft system that prevents your vehicle from being driven until it is started using a valid key. If your vehicle can't find the key or fails to authenticate it, it will remain immobilized. A notification appears in the display if the key can't be found or has a low battery. If your vehicle is unresponsive to a battery-powered key, try using a key card. If the vehicle appears to have no power, the cause could be discharged batteries or something affecting its electrical systems.

---

### 6.4.1. Alarm

The alarm helps deter unwanted interference with your vehicle when it's parked.

The alarm is automatically enabled when you lock the vehicle from the outside and disabled when you unlock it.

 **Note**

### Locking with hood or trunk open

If the hood or the trunk are not properly closed when you lock the vehicle, the alarm won't be fully enabled. In these cases, the alarm will only protect the side doors.

The vehicle also won't detect any motion inside if you've locked it with the hood or trunk still open.

Once you close the hood or trunk, it will lock and be covered by the alarm.

## Triggering the alarm

The alarm triggers when an unauthorized attempt is made to open the hood, trunk or any door.

Movement inside the vehicle can also trigger the alarm.

Once the alarm is triggered, the following happens:

- The alarm warning lights flash for up to 5 minutes.
- The alarm sound starts.
- The alarm cycle restarts several times over if whatever triggered the alarm isn't resolved.

 **Tip**

### Alarm sensitivity

You can turn reduced alarm sensitivity on in settings, which is especially useful if the vehicle is parked on a ferry where it can be affected by external motion or vibrations.

The alarm may also be triggered if you use a vehicle jack, connect a trailer or have the vehicle towed. In such cases, you should always activate reduced alarm sensitivity.

## Stopping the alarm

Unlocking the vehicle while the alarm is triggered will stop any alarm sounds and warning lights.

 **Important**

Do not make any changes or additions to the alarm system, or it may not work properly.

### 6.4.1.1. Reducing alarm sensitivity

Reduce the alarm sensitivity when you expect significant movement in or around the vehicle when parked.

This setting is especially useful if the vehicle is parked where it can be affected by external motion, such as when traveling on a ferry.

 **Note**

You can't install software updates while the setting is active.

- 1 Press the vehicle symbol  in the bottom bar and go to **Settings**.
- 2 Go to **Controls** → **Locking** → **Reduced alarm mode**.
- 3 Turn reduced alarm sensitivity on or off.

## 7. Charging your vehicle

Learn how charging works and how you can make each charging session more efficient.

In this section, you can find out more about the different charging types, charging settings, and how to start and stop charging. You can also read about other types of charging-specific information.

### 7.1. Charging types

Learn more about the different types of charging for your vehicle and how to initiate charging for each type.

#### **Warning**

##### Charging components and high voltage

- The vehicle's charging components carry hazardous currents and voltages. They must be handled with care. Do not perform actions that are not clearly described in the user manual.
- Do not modify or make your own repairs to any charging components. Contact an authorized Volvo workshop for any required repairs or servicing.
- Installation and repairs of at-home charging equipment<sup>[1]</sup> must be performed by a licensed electrician.
- Damage to the vehicle's high voltage components, including the traction battery, can cause overheating, fire and serious personal injury. If there is a risk of damage, such as after battery leakage, flooding, fire or a collision, do not use the vehicle. Contact an authorized Volvo workshop as soon as possible. If possible, leave the vehicle outdoors and away from people, buildings, property and other objects that could catch or spread fire.

##### If you have a pacemaker or similar device

Charging may affect the operation of your pacemaker. Anyone with an implanted pacemaker or biventricular pacing pulse generator without defibrillation capability should not attempt to charge the vehicle on their own. Ask someone else to charge your vehicle. You should also stay away from the chargers and charging cables while charging the vehicle.

#### **Note**

##### 12 V battery charging

The vehicle keeps the 12 V battery charged as long as the traction battery has sufficient charge.

##### Condensation during charging

During charging, condensation from the cooling system can collect under the vehicle. This is perfectly normal and is caused by the traction battery cooling down.

## AC charging at a charging station or from a charging point at home

AC charging points are available at a variety of charging locations, both public and private. An AC charging point can be installed at home and is the recommended source for regular charging.

## AC charging with a household outlet

You can charge your vehicle from a regular household outlet. This type of charging is only suitable for occasional charging and is not recommended for regular use. If you are planning to charge your vehicle from a household outlet, there are additional steps you need to take to ensure it is done safely.

### **Warning**

Do not use visibly worn or damaged electrical sockets as they could cause overheating, electric shock or personal injury.

### **Important**

- The vehicle must only be charged from approved, grounded household outlets.
- Do not exceed the maximum permitted charging current when charging via a regular household outlet. Limits imposed by local and national charging recommendations may apply.
- Ensure that the household outlet breaker can handle the charging cable's specified current before you start charging. If you are uncertain, the outlet must be checked by a qualified and licensed electrician.
- Never connect the charging cable when there is a risk of thunderstorm or lightning strike.

## DC fast charging

DC fast charging is available at certain charging stations. These charging stations deliver very high power that allows for shorter charging times.

### **Note**

Charging stations with support for fast charging are usually clearly marked with CCS or Combo.

## Charging cables

There are different charging cables to use when you charge your vehicle. Mode 3 cables are the standard cables to use when charging electric vehicles. There are different versions of the mode 2 cable available. Mode 2 cables can be used as an emergency solution, but it is not recommended to use them as a daily charging method.

<sup>[1]</sup> Including any work on the electric meter housing or power distribution service panel.

### 7.1.1. Charging cables

When using a charging cable for the first time, always check to make sure it's compatible with your vehicle.

The content of this manual represents the status of the user manual at the time of printing and may not be completely valid in future instances. For more information refer to the first page for the complete disclaimer note.

## Charging cable recommendations and use

### **Warning**

#### High voltage

The cable is connected to a hazardous electrical system. Contact with high voltage currents can cause fatality or serious personal injury.

#### Damaged cables

Do not use a charging cable that shows any signs of damage or wear. This can cause an electric shock. A damaged or malfunctioning charging cable provided by Volvo may only be repaired at an authorized workshop. Contact an authorized Volvo workshop for more information. If you are charging at a charging station, try another cable or charging point.

#### Excessive wear and debris

Remember to always check the charging cable connector for excessive wear or debris. Do not touch the charging cable connector or use any tools to attempt to remove debris from the charging cable. This can cause an electric shock.

Public charging stations are in constant use and can be exposed to more wear and tear than a private charging station.

#### Cable placement

Remember to place the cable where there is minimal risk of it getting damaged or causing personal injury. A carelessly placed cable can easily get run over or tripped over.

#### Child safety

Keep children away from charging cables, especially when the cables are plugged in.

### **Important**

#### Liquids and cables

Do not submerge the charging cable or its components in liquid. If you need to clean the cable, use a clean cloth lightly dampened with water. If needed, use a mild detergent but never use chemicals or strong solvents.

#### Only use recommended cables

- Only use the cables originally provided with your vehicle or that are recommended by Volvo.
- Volvo takes no responsibility for damage or injury caused by charging equipment not recommended by Volvo.



 **Note**

### Recommended cables

Volvo recommends a charging cable according to IEC 62196 and IEC 61851 that supports temperature monitoring.

### Charging cable instructions

Before using a charging cable, make sure to read the instructions from the cable's manufacturer.

Some charging stations have a permanently attached charging cable. Be sure to follow the charging station's instructions for use.

## Mode 3 cable for charging stations

You can use this type of cable to charge your vehicle at AC charging stations.

## Mode 2 charging cables

Use a charging cable with a household plug to charge the vehicle from an ordinary household outlet, such as when no other charging options are available.

 **Important**

Do not use this type of charging as a daily charging method.

---

## 7.2. Charging view and settings

In the charging view, you can access information about the charging process, start or stop charging and set different charging settings. You can customize the charging settings according to your preferences. The charging view appears automatically when charging is initiated.

**Note**

The information content can vary depending on the current charging status.

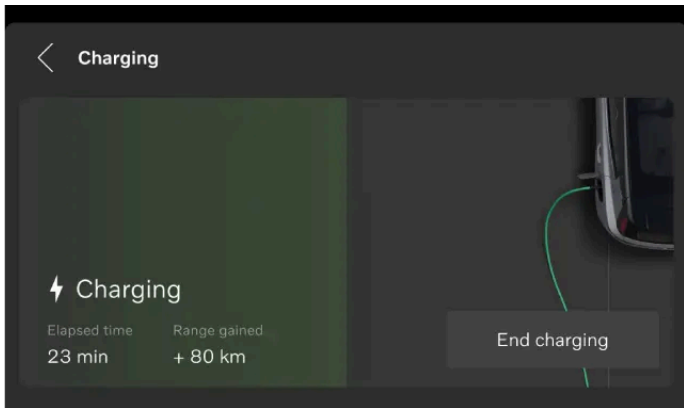

The following information, functions and settings are available in the main area of the display:

- Current battery level
- Target battery level
- Amperage<sup>[1]</sup>
- Charging status
- Start or stop charging<sup>[2]</sup>
- Set a target battery level for charging
- Limit the electrical current for AC charging
- Add and manage schedules

**Tip**

You can also access information about battery level, charging status and the charging process in the mobile app for the vehicle.

You can also access the charging view through the settings in the display.

<sup>[1]</sup> Amperage is only shown if a limit was set.

<sup>[2]</sup> The **Start charging** option is only available when the AC cable is still connected.

## 7.2.1. Setting a target battery level for charging

You can set a target battery level by selecting a value in the charging view. This will help you to maintain good charging performance and battery longevity.

There are two preset options: **Daily drive** and **Long trip**. **Daily drive** is the recommended charging level which charges your vehicle up to 90%. **Long trip** charges your vehicle up to 100% and can be selected if you want the maximum range possible from your vehicle. You can also choose to customize the target battery level value by selecting **Custom**.



**Tip**

You can also adjust the target battery level in the mobile app for the vehicle.

- 1 Press the vehicle symbol  in the bottom bar and go to **Settings**.
- 2 Go to **Charging** → **Target battery level**.
- 3 Select your preferred battery level.
  - The target battery level value changes. The value is saved until you change it again.

If the battery level is 20% or lower, the battery level status changes to orange.

---

## 7.2.2. Setting the amperage limit for charging

You can set an amperage limit for AC charging by selecting a value in the charging view.

The charging current limiting feature is turned off by default. When the charging current is not limited, the maximum available amperage value is applied. When the charging current is limited for the first time, the lowest available value is applied by default. Ampere, often written as "amp" or "A," is the unit for electric current.

- 1 Press the vehicle symbol  in the bottom bar and go to **Settings**.
  - 2 Go to **Charging** → **Limit charging current**.
  - 3 Turn the function on. <sup>[1]</sup>
  - 4 Adjust the amperage limit to your preferred value.
- The amperage limit changes, and the value is saved until you change it again. When your vehicle is charging, the actual amperage value and the limit are shown in the display.

### Note

The amperage limit may vary between regions.

When you turn the function off, the amperage limit that you set isn't saved. This means that you need to set a new limit if you turn the function on again.

<sup>[1]</sup> Only available for AC charging.

---

## 7.2.3. Adding and managing charging schedules

You can set and activate a charging schedule for your vehicle in the charging view. This means you can specify when you want the vehicle to charge, such as when it is plugged in overnight.

### Note

The charging schedule setting only applies to AC charging. When using DC charging, it will always override the charging schedule and start charging when the charging cable is plugged into the vehicle.

- 1 Press the vehicle symbol  in the bottom bar and go to **Settings**.
- 2 Go to **Charging** → **Charging schedule**.

The content of this manual represents the status of the user manual at the time of printing and may not be completely valid in future instances. For more information refer to the first page for the complete disclaimer note.

- 3 Select the start and stop times for the charging schedule by using the timer.
  - 4 Activate the schedule by turning it on.
- The timer is active and the scheduled charging time is visible in the display, both in the main area and in the driver information area.

You can deactivate the schedule by turning it off. The timer will not be active and no scheduled charging is planned.

---

## 7.3. Starting and stopping charging

You can charge your vehicle by using either AC <sup>[1]</sup> charging or DC <sup>[2]</sup> charging. How you start and stop the charging process depends on the type of charging you use.

AC charging is the recommended charging mode for everyday charging, as it maintains the condition of the battery over time. AC charging can be used if you are charging from a charging station, a charging point at home or a regular household outlet. DC charging is available at certain charging stations and charges your vehicle faster than AC charging. However, it also wears the battery out faster. DC charging can be used when you need to recharge your battery immediately.

<sup>[1]</sup> Alternating current

<sup>[2]</sup> Direct current

---

### 7.3.1. Starting AC charging

AC charging can be done at certain charging stations, from a charging point at home or from a regular household outlet. The cable you need depends on the charging mode.

To initiate charging, make sure:

- the vehicle is in park.
- the charging settings are set up according to your preferences. <sup>[1]</sup>

If you are using a regular household outlet, also make sure it meets the safety requirements for charging.

 **Warning**

Do not connect any equipment other than the charging cable between the charging source and the vehicle's charging port. <sup>[2]</sup> It can cause malfunction, damage or electric shock.

- 1 Connect the charging cable to the charging source. Some charging stations have a permanently attached charging cable that you connect to your vehicle.
- 2 Open the charging hatch by lightly pressing on its back edge.



- 3 Remove any protective covers from the charging port and cable connector.

 **Important**

To avoid damage to the paintwork, position the connector's protective cover so that it does not touch the vehicle.

- 4 Connect the cable to the charging port.
  - When the cable is fully inserted it locks into place. Charging starts within a few seconds.

You can see the charging status in the charging port and in the display.

## Recommended action if charging does not start

First, disconnect the cable from the vehicle's charging port, then from the charging source. Wait a moment before reconnecting it. If the problem persists, contact an authorized Volvo workshop.

<sup>[1]</sup> Some settings can be adjusted during charging.

<sup>[2]</sup> This includes extension cords, outlet splitters and power strips, travel adapters, external timers, surge protectors, and similar devices.

---

## 7.3.2. Starting DC charging

DC charging is available at certain charging stations.

DC charging stations have permanently attached charging cables, so you don't need to use your own.

 **Warning**

- Public charging stations are in constant use and can be exposed to more wear and tear than a private charging station. Remember to always check the charging cable connector for excessive wear or debris.
- Do not touch the charging cable connector or use any tools to attempt to remove debris from the charging cable. This can cause an electric shock.
- Do not use a charging cable that shows any signs of damage or wear. This can cause an electric shock. Try another cable or charging point at the charging station.
- Ensure that the charging cable connector connects all the way into the charging port. A worn connector may prevent a safe connection to your vehicle.

To initiate charging, make sure:

- the vehicle is in park.
- to check the charging station for any instructions before you begin.

- 1 Open the charging hatch by lightly pressing on its back edge.



- 2 Remove any covers from the port and cable connector.

- 3  **Tip**

#### Charging using North American Charging Standard (NACS)

When using a charging point or a charging station with a NACS charge connector, you need to use an adaptor to connect the charging cable to your charging port. Make sure to read the instructions included with the adaptor before using it.

Use both hands to press the cable's connector all the way into the charging port. Make a habit of pushing the charging cable upwards for a couple of seconds after inserting it to ensure connection and locking.

- The charging cable automatically locks in place after a few seconds.

- 4 After confirming that the cable is locked in place, follow the charging station's instructions for charging authorization.

- Charging starts after an insulation test has been completed by the charging station. It can take a minute to complete.

You can see the charging status in the charging port and in the display.

---

## 7.3.3. Stopping AC charging

You can stop the charging process at any time.

 **Important**

Stop the charging session before attempting to unplug the cable from the vehicle charging port. If you do not, you may cause damage to the cable or to the system.

 **Tip**

When AC charging is stopped, the charging cable unlocks.

Make sure that the vehicle is unlocked.

- 1 Press the vehicle symbol  in the bottom bar and go to **Settings**.
- 2 Go to **Charging**.
- 3 Press **End charging**.
  - The charging is stopped.
- 4 Unlock the charging cable using the handle on the cable.
- 5 Unplug the charging cable from the vehicle.
- 6 If available, reattach the protective cover on the cable connector.
- 7 Depending on the cable you have used:
  - Unplug the charging cable from the charging station.
  - Reattach the charging cable to the station's storage socket.
- 8 Reattach the charging port's protective cover and close the charging hatch.

 **Tip**

You can also stop the charging process by pressing the **End charging** button in either the welcome view, the home view or in the mobile app.



---

## 7.3.4. Stopping DC charging

You can stop the charging process at any time.

 **Important**

Stop the charging session before attempting to unplug the cable from the vehicle charging port. If you do not, you may cause damage to the cable or to the system.

- 1 Press the vehicle symbol  in the bottom bar and go to **Settings**.
- 2 Go to **Charging**.
- 3 Press **End charging**.
  - The charging is stopped.
- 4 Unlock the charging cable using the handle on the cable.
- 5 Unplug the charging cable from the vehicle.
- 6 If available, reattach the protective cover on the cable connector.
- 7 Reattach the charging port's protective cover and close the charging hatch.

 **Tip**

You can also stop the charging process from the charging station or by pressing the **End charging** button in either the welcome view or the home view.

---

## 7.3.5. Releasing the charging cable

If the charging cable doesn't automatically release after you have stopped charging, there are some steps you can try.

The charging cable usually releases automatically when you have stopped charging. However, if the charging cable is left in the charging port for a while after charging has stopped, the charging cable will automatically lock in again.<sup>[1]</sup>

Make sure that the key is within range and that the vehicle is unlocked.

- Stop charging by pressing **End charging** in the display.
- If you're charging at a public charging station, follow the instructions in the charging station's interface to stop charging.
- Carefully wiggle the charging cable.
- Lock and unlock the vehicle.
- Lock the vehicle and wait until the LED on the vehicle's charging port turns off. This can take some time. After that, unlock the vehicle and try to stop charging via the display again.

If the charging cable still doesn't release, stop charging via the charging station, charging point or household outlet in one of the following ways:

- Charging via a public charging station: Contact the charging station's customer service to get help with stopping the charging.
- Charging via a home charging point: Safely disconnect the power supply to your home charging point.
- Charging via a household outlet: Unplug the cable from the household outlet.

If the problem persists, contact an authorized Volvo workshop.

<sup>[1]</sup> Applies to AC charging.

---

### 7.3.5.1. Manually releasing the charging cable

If the charging cable doesn't release from the vehicle after you have stopped charging, you can use the emergency release handle. Never use the emergency release handle when charging is in progress.

- 1 Open the trunk and the cargo hatch.
- 2 Locate the cap on the left side of the trunk.



- 3 Remove the cap by prying it off with a screwdriver or a similar tool.

4

 **Warning**

Before using the emergency release handle, check the display or the charging port to make sure the charging process has stopped. The emergency release handle should not be used when charging is in progress.

Carefully pull the emergency release handle until you feel resistance.



➤ The charging cable unlocks from the charging port.

 **Note**

The emergency release handle automatically retracts when the next charging cycle is started.

- 5 Unplug the charging cable from the vehicle.
- 6 Put the cap back and close the cargo hatch and the trunk.

If the problem persists, contact an authorized Volvo workshop.

---

## 7.4. Charging time and statuses

Learn more about charging times so that you have an idea of what to expect in different situations and what the different charging statuses mean.

---

### 7.4.1. Charging times

The time it takes to charge your vehicle depends on the charging type and several factors. The charging times mentioned are approximate.

Some examples of factors that can affect the charging time are:

- preconditioning

The content of this manual represents the status of the user manual at the time of printing and may not be completely valid in future instances. For more information refer to the first page for the complete disclaimer note.

- ambient temperature
- battery temperature
- charging equipment
- battery size
- battery condition and vehicle condition
- infrastructure
- charging settings such as amperage limit.

## AC charging from a household outlet<sup>[1]</sup>

| Current (A) <sup>[2]</sup> | Charging power (kW) | Charging time (hours) <sup>[3]</sup> |
|----------------------------|---------------------|--------------------------------------|
| 10                         | 2.2                 | 39.5                                 |
| 16                         | 3.6                 | 23.5                                 |
| 32                         | 7.2                 | 11.5                                 |
| 45                         | 10                  | 8                                    |

## AC charging from a household outlet<sup>[4]</sup>

| Current (A) <sup>[2]</sup> | Charging power (kW) | Charging time (hours) <sup>[3]</sup> |
|----------------------------|---------------------|--------------------------------------|
| 10                         | 1.1                 | 84                                   |
| 16                         | 1.8                 | 48                                   |

## DC charging at a charging station

| Station power (kW) <sup>[5]</sup> | Charging time (minutes) <sup>[6]</sup> |
|-----------------------------------|--|
| 50                                | 56                                     |
| 175                               | 30                                     |

### Note

The battery can charge the fastest when the battery level is low. After reaching 30%, the maximum charging speed gradually decreases as the battery level increases.

### Tip

When you use Google Maps to set a fast-charging station as your destination, the vehicle preconditions the battery to improve charging performance once you get there.

<sup>[1]</sup> Using a 200-240 V socket.

<sup>[2]</sup> Maximum charging current may vary depending on region.

<sup>[3]</sup> From 0-100%

<sup>[4]</sup> Using a 100-120 V outlet.

<sup>[5]</sup> Maximum power that the charging station can supply.

[6] Applies at 10-80% state of charge, provided that the temperature of the battery is approximately 25 °C to 30 °C (77 °F to 86 °F).

## 7.4.2. Charging status

The vehicle's charging status is shown using different colors, both in the charging port and in the display.



- ① Charging status information in the display
- ② Charging status information in the charging port





The charging port light only indicates the current status of the charging cycle. If you would like more comprehensive information, you can find this in the display.

### *i* Tip



You can also access information about charging status in the vehicle's mobile app.

### 7.4.2.1. Charging status in the charging port

You can see the vehicle's current charging status in the charging port.

| Color   | Color name       | Description  |
|---|------------------|--|
|  | White, solid     | The charging lid is open, and no cable is connected or the cable is connected but the vehicle is not charging. |
|  | Yellow, solid    | The charging cable is attached and the battery is being preheated.   |
|  | Green, pulsating | Charging is in progress or the cable is unlocked.  |
|  | Blue, solid      | Charging is scheduled.   |

The content of this manual represents the status of the user manual at the time of printing and may not be completely valid in future instances. For more information refer to the first page for the complete disclaimer note.

| Color   | Color name   | Description  |
|---|--------------|--|
|  | Green, solid | The vehicle is either done charging or has stopped charging.   |
|  | Red          | Charging fault. Check the display for additional information. Always make sure that the charging cable is correctly connected to the vehicle charging port and that the power source, such as the cable or the charging station, works correctly. If an error is indicated, try to disconnect the cable from the vehicle, then reconnect it and re-initiate charging to see if the problem is solved. If the problem persists, contact an authorized Volvo workshop. |

## 7.4.2.2. Charging status in the display

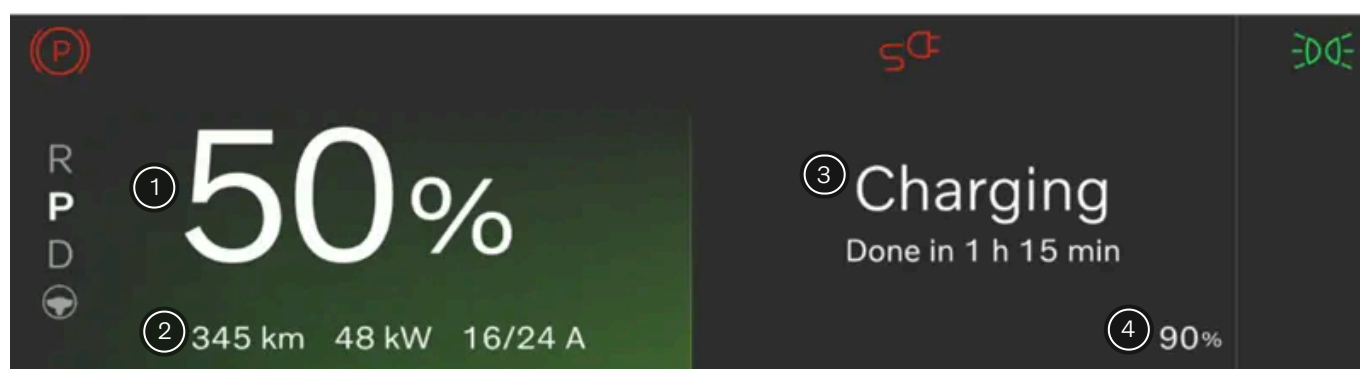

You can see the vehicle's current charging status in the display.





Information available in the driver information area.

- ① Battery level information
- ② Current range, charging power and amperage<sup>[1]</sup>
- ③ Charging status information
- ④ Target battery level

The driver information area contains charging status information, such as status text, battery level, current range, amperage, remaining charging time and scheduled time information. Different colors of the progress bar are also visible. The information may vary depending on the charging status.

| Status    | Color   | Color name       | Description   |
|-----------|---|------------------|---|
| Waiting   |  | White, solid     | The cable is connected, but the vehicle is not charging. The status can also be visible when heating or cooling is needed before starting the charging session. |
| Charging  |  | Green, pulsating | The vehicle is charging manually. <sup>[2]</sup>  |
| Scheduled |  | Blue, solid      | The cable is plugged in, and your vehicle is scheduled to charge at a later time. Information about the scheduled time is visible in the display.               |

| Status                            | Color   | Color name   | Description  |
|-----------------------------------|---|--------------|--|
| Charging ended and Cable unlocked |  | Green, solid | The vehicle is either done charging or has stopped charging. When AC charging is stopped, the charging cable unlocks. The charging process is temporarily paused, and the charging cable can be removed. |
| Charging fault                    |  | Red, solid   | The cable is plugged in but there is an error in the charging connection. Depending on the error, the display shows different messages. If the problem persists, contact an authorized Volvo workshop.   |

[1] Amperage is only shown if a limit was set.

[2] AC manual, AC scheduled, DC.

## 8. Driving

Your vehicle is designed for driving. This section covers the essential driver controls that allow you to start, stop, steer and change gears. You can also find information about driving characteristics and handling here.

Many of your vehicle's driving features can be customized for a personalized experience. While some features are more directed towards comfort, others are strictly safety related. It's important to check your driving position, maintain good visibility and to always stay attentive and focused while driving.

---

### 8.1. A typical driving cycle

This description provides an overview of your vehicle's capabilities and behavior in the different stages of a typical driving cycle.

A driving cycle starts when you unlock your vehicle and ends when your vehicle is powered down after driving.

The different situations and scenarios described here have their own sections in this manual with more detailed information.

#### Approaching and unlocking

Your vehicle unlocks differently depending on which type of key you use. When your vehicle unlocks, it also powers on.

#### Entering

When you enter your vehicle, it can automatically select your profile if you use a connected key. It adjusts the driver's space and applies your profile settings for features and vehicle behavior. Additional features can be accessed when you are seated and ready to drive, such as climate and comfort.

#### Beginning your drive

The type of key you are using affects how you start the vehicle. If you are using a key card or a discharged key, it needs to be placed on the card reader for you to be able to start driving. If your vehicle detects a distance-capable key, you just have to keep it inside of the vehicle.

To start driving, press the brake pedal and select a gear. Your vehicle can notify you of any open doors, unbuckled seat belts or other issues related to driving.



Tip

This manual contains information that might be useful, depending on what kind of trip you're about to go on. For example, you can find information about your vehicle's stowing capabilities or what you need to think about when driving in winter conditions.

#### Parking

The content of this manual represents the status of the user manual at the time of printing and may not be completely valid in future instances. For more information refer to the first page for the complete disclaimer note.



Your vehicle will automatically apply the parking brake and enter a parked state. This is part of a gradual power-down as you get ready to leave the vehicle. If you want to remain in your vehicle after parking, with the climate and media features still available, you can activate the parking comfort feature.

You can also manually activate the parking brake by pressing the P button on the right-hand steering wheel stalk.

## Powering down, locking and leaving

When you leave and lock your vehicle, it will gradually power down. This is done automatically and the vehicle will enter a stand-by state.

You can also manually turn your vehicle off via the display.



**Tip**

If possible, charge your vehicle when you leave it for longer periods of time.

## 8.2. Trips app

The Trips app is a driving journal that automatically logs all trips made with your vehicle.

When this app is enabled, it automatically collects your vehicle's identification number<sup>[1]</sup>, location and other trip-related data, such as time, distance and battery consumption.



**Note**

The Trips app calculates battery consumption based on pure consumption during a trip. If you see a different value in your vehicle's trip meter, it's because the trip meter also takes energy regeneration into account.

In the Volvo EX30 app, you can:

- View, manage and delete all of your trips.
- Export your driving journal.
- Stay informed if a trip isn't uploaded due to an issue, such as network problems.

When the Trips app is enabled, all users that have paired the Volvo EX30 app with the vehicle can see the trips. If the Trips app is disabled, the vehicle stops sending information about new trips.



**Note**

### Vehicle location sharing

You need to enable vehicle location sharing in the display and in the Volvo EX30 app to start logging your trips.

## Storage limits

The content of this manual represents the status of the user manual at the time of printing and may not be completely valid in future instances. For more information refer to the first page for the complete disclaimer note.

When a trip is logged, it can be stored in the Trips app for up to 400 days. The app has the capacity to store approximately 500 trips. When this limit is reached, older trips are automatically deleted to free up space and make room for new trips.

**Note**

If the journal isn't logging trips, the reasons for this might include:

- Weak or no network connection.
- The app isn't receiving GPS coordinates.
- Location permissions are disabled, preventing Trips app from accessing the vehicle's location.

[1] VIN

## 8.3. Starting the vehicle

Starting your vehicle requires a key to be present and used correctly, and you must press down on the brake pedal while starting and select a driving gear.



Your main interaction points for starting your vehicle are the brake pedal and the gear stalk.

If you are using a distance-capable key, your vehicle gradually powers on when you approach it and take your seat. If you are using a key card or a distance-capable key with a discharged battery, you must unlock the vehicle manually for it to power on. Many features, such as the climate system, will be accessible once you enter your vehicle.

To start your vehicle, press down the brake pedal and select a driving gear.

Before you start driving, make sure that:

- All doors are closed.

- All occupants are properly seated and wearing their seat belts correctly.
- The driver's seat, steering wheel position and mirrors are adjusted to your driving position.
- No charging cables are connected.
- The driver area is unobstructed and the pedals can move freely.

**i Tip**

The vehicle can alert you to certain conditions you should address before driving. If something is preventing you from starting the vehicle, have a look in the driver information area for guidance.

- 1 If you are using a distance-capable key, make sure to keep it with you.

If you are using a key card or a discharged distance-capable key, place it on the card reader.



The location of the key card reader used to start the vehicle with a key card or a discharged distance-capable key.

- 2 Press and the brake pedal and hold it down.
  - 3 Select D or R using the right-hand steering wheel stalk.
- The selected gear is indicated in the driver information area. The ready symbol also appears, emphasizing the transition from parked to a driving gear.

**READY**

**i Note**

The ready symbol disappears when the vehicle's speed exceeds a walking pace. It reappears whenever the vehicle slows down below the same threshold.

## 8.3.1. Startup checks

When you select a gear to start driving, the vehicle performs a number of self-checks of important systems and functions. This short test is indicated in the driver information area.

The startup check is indicated by several warning and indicator symbols in the driver information area. If any of the warning or indicator symbols remain visible after a few seconds, it tells you that there's a fault or condition you need to address before driving.

If a fault is indicated:

- Read any related information presented in the driver information area.
- For additional information about warning and indicator symbols, consult that section of the manual.
- Resolve the indicated fault before driving.
- If you cannot resolve the issue yourself, do not hesitate to contact an authorized Volvo workshop.

After performing the startup check, the vehicle continues to actively monitor many of its systems and functions.

---

## 8.4. Turning the vehicle off

The vehicle typically powers down automatically, but you can also manually turn it off in the display.

Your vehicle can automatically turn itself off after you leave it and lock it from the outside. However, in some situations, you may want to manually turn it off. You can do this in the display.

### Note

Leaving your vehicle without locking it starts a 30-minute timer before the vehicle automatically turns itself off. If you return to the driver seat before the timer runs out, it will be canceled.

To turn the vehicle off manually, the vehicle has to be in P. If the parking brake has not been automatically applied, press the parking brake button.

#### Turning the vehicle off manually

- 1 Press the vehicle symbol  in the bottom bar and go to **Settings**.
- 2 Go to **Controls** → **Vehicle modes** → **Turn off car**.
- 3 Turn the vehicle off.
  - The vehicle powers down.
  - The vehicle can now be locked and left.

**Note**

After being turned off, a number of essential systems remain available, such as key detection, alarm, internet connectivity and battery monitoring. Under normal conditions, they only use a small amount of power.

## 8.5. Driving characteristics

Explore the features that affect driving performance and dynamics. This allows you to customize your driving experience.



Your vehicle has several features that affect your vehicle's driving dynamics and performance.

|                                     |  |
|-------------------------------------|--|
| <b>One Pedal Drive</b>              | This allows you to both brake and accelerate using only the accelerator pedal. The function can be turned on or off in the display.                    |
| <b>Drive modes</b>                  | You can configure the vehicle for daily driving or set your vehicle's power delivery to prioritize range or performance.                               |
| <b>Electronic stability control</b> | You can turn the electronic stability control <sup>[1]</sup> off if you want a more active driving experience or if you are stuck in mud or deep snow. |
| <b>Hill descent</b>                 | By activating hill descent, your vehicle can brake in a more controlled and active way. This can be useful if you are driving downhill at low speeds.  |
| <b>Steering feel</b>                | Adjusting the steering feel affects the steering wheel resistance and firmness.  |

**Tip**

### Exterior sound

Your vehicle plays an artificial driving sound when you are driving at low speeds. This is to alert others of your presence.

<sup>[1]</sup> ESC

---

## 8.5.1. Drive modes

The drive modes change the driving dynamics of your vehicle.

The different drive modes available in your vehicle are all suitable for different scenarios and types of driving. Depending on which drive mode you select, certain driving dynamics may be affected, such as steering, braking and acceleration. Your vehicle's fuel consumption and estimated range are also affected.

The vehicle has three drive modes:

- Standard** This is the default mode and is recommended for everyday use. It's also selected automatically every time you start the vehicle.
- Range** This mode limits climate and driving performance to maximize range.
- Performance** The performance mode lets your vehicle prioritize performance over range, which allows for a more active and dynamic driving experience.

---

### 8.5.1.1. Selecting a drive mode

You can select a drive mode in settings.

Your vehicle is equipped with different drive modes for different driving conditions and situations. Selecting a drive mode allows your vehicle to adjust the driving characteristics and dynamics for the intended use, which might disable certain settings. You can select a drive mode in settings.

The standard drive mode is selected by default every time you start your vehicle.

- 1 Press the vehicle symbol  in the bottom bar and go to **Settings**.
  - 2 Go to **Driving** → **Driving dynamics** → **Drive modes**.
  - 3 Select a drive mode.
- Your vehicle's driving characteristics and settings are adjusted based on your selected drive mode.

---

## 8.5.2. One Pedal Drive

You control both braking and acceleration with the accelerator pedal when One Pedal Drive is active.



Braking behavior changes through the use of the accelerator pedal. When you press the accelerator, the vehicle accelerates normally, but releasing the pedal engages braking. The more you ease up on the pedal, the more braking action you get.

Regenerative braking is prioritized by One Pedal Drive. However, the disc brakes can be applied if the braking action demands it.

To conserve battery power, One Pedal Drive can be used in driving sessions where you expect to vary your speed.

 **Important**

You can only use One Pedal Drive after buckling your seat belt and selecting driving gear D. Otherwise, no braking force will be applied when you ease up on the accelerator, even if One Pedal Drive is enabled in settings.

 **Warning**

**Keep the brake pedal in mind**

There is a limit to the braking force that can be applied by releasing the accelerator when using One Pedal Drive. For hard braking, you need to use the brake pedal.

## 8.5.2.1. Adjusting One Pedal Drive

Braking by using One Pedal Drive can be adjusted, enabled or disabled in drive settings.

The level of applied braking force from One Pedal Drive can be adjusted in settings.

The available One Pedal Drive settings are:

Off The function is off. Releasing the accelerator does not engage the brakes.

**The content of this manual represents the status of the user manual at the time of printing and may not be completely valid in future instances. For more information refer to the first page for the complete disclaimer note.**

**Low** When you ease up on the accelerator, the vehicle will apply regenerative braking.

**High** When you ease up on the accelerator, the vehicle will brake with more force than in the low setting.

 **Tip**

### Quick access

The adjustment settings for One Pedal Drive are available in quick controls and via the customizable steering wheel button  as well. These allow you to quickly adjust the level of braking force from One Pedal Drive without going into settings.

 **Warning**

### Keep the brake pedal in mind

There is a limit to the braking force that can be applied by releasing the accelerator when using One Pedal Drive. For hard braking, you need to use the brake pedal.

- 1 Press the vehicle symbol  in the bottom bar and go to **Settings**.
- 2 Go to **Driving** → **Driving dynamics** → **One pedal drive**.
- 3 Select a setting.

## 8.5.3. Enabling automatic creeping

When creeping is enabled, the vehicle can automatically move slowly without you using the accelerator. Automatic creeping can be enabled or disabled in settings.

When you start the vehicle or if you're at a standstill with creeping enabled, the vehicle will begin creeping after you release the brake pedal. Once the vehicle is moving, you can release the accelerator to make the vehicle slow down and start to creep.

Automatic creeping can be useful in driving situations such as traffic jams or parking lots.

 **Tip**

Pressing down hard on the brake pedal temporarily pauses creeping and activates auto hold. Press the accelerator to initiate creeping again.

- 1 Press the vehicle symbol  in the bottom bar and go to **Settings**.



2 Go to **Driving** → **Driving dynamics** → **Creep forwards**.

3 Turn it on or off.

---

## 8.5.4. Activating hill descent

Hill descent can help you with speed control during steep downhill driving.

By activating hill descent, your vehicle can brake in a more controlled and active way. This can be useful if you are driving downhill, as it can help you avoid unwanted acceleration. You can activate hill descent in the display.



Hill descent availability is indicated with the hill descent symbol in the driver information area. The symbol turns green when hill descent is active.

### Note

Hill descent is only available at speeds below 40 km/h (25 mph). If you drive faster than this, the function will be deactivated.

1 Press the vehicle symbol  in the bottom bar and go to **Settings**.

2 Go to **Driving** → **Driving dynamics** → **Hill descent**.

3 Activate hill descent.

---

## 8.5.5. Stability control

Your vehicle has stability control systems in place that can help to prevent skidding.

### Electronic stability control

Electronic stability control<sup>[1]</sup> can automatically apply your vehicle's brakes to prevent skidding when your vehicle detects a loss of traction or steering control. To do so, ESC applies the brakes to each wheel individually. When this intervention happens, the symbol for ESC flashes in the driver information area.



The function can be turned off to allow for a more active driving experience. It can also be useful to turn ESC off if the vehicle is stuck in mud or deep snow.

 **Note**

### Towing a trailer

When you are towing a trailer, electronic stability control should always be enabled, as it helps to prevent fishtailing. You can read more about this in the manual section about towing.

Your vehicle's stability control includes several other features, such as:

- Anti-lock braking system**<sup>[2]</sup> The vehicle's anti-lock braking system prevents the brakes from locking up during hard braking. This improves maneuverability and helps with stabilizing the vehicle.
- Trailer stability assist** This is part of the ESC and can intervene if fishtailing is detected when you are towing a trailer.
- Spin control and active yaw control** These features act to prevent the wheels from slipping against the road surface.
- Regeneration stability control** Helps with preventing wheel locking when regenerative braking is applied.

 **Note**

Some of the other stability functions are partially disabled when ESC is turned off. None of them are completely turned off, but their threshold of activation will be increased to allow for a more active driving experience.

<sup>[1]</sup> ESC

<sup>[2]</sup> ABS

## 8.5.5.1. Disabling electronic stability control

You can disable the electronic stability control for a more active driving experience.

Electronic stability control<sup>[1]</sup> can be turned on or off in the display. When it is turned off, it is still active to a certain extent for safety reasons. However, turning the function off limits interactions from ESC. This can give you a more active driving experience, as more control is transferred to the driver. ESC will still step in and help the driver in many scenarios.

Turning ESC off can also be useful for off-road driving or if the vehicle is stuck in mud or deep snow.

When ESC is deactivated, the stability system off symbol is shown in the driver information area.



- 1 Press the vehicle symbol  in the bottom bar and go to **Settings**.

2 Go to **Driving** → **Driving dynamics** → **ESC OFF**.

3 Turn ESC on or off.

The function resets when the vehicle is powered down.

 **Note**

Disabling ESC also disables lane keeping aid.

<sup>[1]</sup> ESC

---

## 8.5.6. Suspension

Your vehicle's suspension is designed to create a pleasant driving experience.

Your vehicle's suspension affects the comfort and handling of your drive. The suspension is fully automatic and cannot be customized or adjusted in any way.

 **Warning**

The shock absorbers are gas pressurized. Do not heat or open the shock absorbers.

---

## 8.6. Range

Your vehicle's expected range is shown in the display and depends on several factors.



380 km  80%

Your range is primarily related to your vehicle's battery level and your driving practices, but external conditions can also be a factor. The battery level and expected range are displayed in the driver information area. The expected range tells you how far you can drive with the current battery level. It is calculated based on your driving pattern, both current and historical, and on real-time driving conditions.

## Factors that affect your vehicle's range

How you drive your vehicle, which settings or features are activated, weather conditions and traffic can all affect your vehicle's range in different ways.

|   |   |
|---|---|
| <b>Speed</b>                              | Driving at higher speeds drains the battery more.   |
| <b>City driving and traffic situation</b> | Varying your speed through frequent acceleration and braking will increase your battery consumption compared to keeping a constant speed.                           |
| <b>Eco driving</b>                        | Keep track of your driving and consumption to drive as economically as possible.  |
| <b>Range mode</b>                         | Selecting the range mode will limit climate and driving performance to maximize range.  |
| <b>Outside temperature</b>                | The outside temperature can affect your battery consumption and range.  |
| <b>Battery temperature</b>                | A cold battery is less efficient and needs more energy to be heated.  |
| <b>preconditioning</b>                    | By preconditioning your vehicle, you can decrease the energy used to heat up both the vehicle and the battery. This can be done in the climate settings.            |
| <b>Climate settings</b>                   | Which climate features are activated and to what extent affects your battery consumption.   |
| <b>Tires and tire pressure</b>            | Tire condition and tire pressure can affect your range.   |
| <b>Road condition and topography</b>      | The condition of the road, along with any potential slopes, can affect your vehicle's battery consumption.  |
| <b>Towing</b>                             | Towing a trailer demands more power from your vehicle and will therefore adversely affect battery consumption. This is relative to the type of trailer being towed. |

## Range in cold temperatures

Cold temperatures can negatively affect your vehicle's battery. When the vehicle has a cold battery, a snowflake ❄️ appears next to the battery percentage. This indicates that the battery's charge capacity and range are reduced compared to normal conditions. You can avoid this by always charging your vehicle while it's parked, which can prove especially useful if you are parking in a cold climate.

## Factory reset and range value

After a factory reset or when the vehicle is delivered from the factory, the estimated range is based on a certified value. After driving your vehicle for a while, the estimated range is instead based on your historical driving patterns. You can change this back again in settings in the display.

---

### 8.6.1. Trip information

Trip information can provide you with an overview of your current consumption, along with your trip meter.

You can view trip information such as mileage, average consumption and average speed. There is also a setting to show the current consumption in the driver information area of the display.

This information is accessed by pressing the vehicle symbol  in the bottom bar and going to **Car status**.

Trip information is divided into:

- Current trip** Information from your current trip. This can be set to show data from your ongoing driving cycle or since you last charged your vehicle.
- Since last reset** Displays information about your trip since the last time you reset the trip meter.
- Consumption** You can view your consumption, which is separated into spent and regenerated energy.

## Trip information symbols

Different symbols represent different types of data in the trip information:



Distance driven.



Your average consumption.



Your average speed.



How much time has passed since you began your current trip.

---

### 8.6.1.1. Resetting the trip meter

You can reset your vehicle's trip meter.

The trip meter can show you information such as mileage, average consumption and average speed.

- 1 Press the vehicle symbol  in the bottom bar and go to **Car status**.
- 2 Go to **Trip info** → **Since last reset** → **Reset**.
- 3 Reset the trip meter.

---

## 8.7. Steering

Get familiar with your vehicle's steering-related functions.



Your vehicle has been designed to provide a responsive and intuitive steering experience. Be sure to adjust your driving posture and preferred steering feel before driving.



Tip

#### Steering and driver support interactions

Several of your vehicle's driver support features can affect steering. Read the user manual sections about these features for a more complete understanding of how they can interact with and affect your steering experience.

## Speed-dependent steering response

Steering resistance and firmness change with the speed of the vehicle. At low speeds, steering resistance is low for precision maneuvering. At high speeds, the steering adapts to be firmer.

## Steering feel

You can adjust the steering feel via the settings in the display. Steering feel affects the firmness of the steering wheel's turning.

---

## 8.7.1. Steering wheel

Get to know the steering wheel and some of its features.

You can use your steering wheel for more than just steering the vehicle.



### **Heated steering wheel**

The steering wheel has built-in heating. The function can be turned on manually or set to automatic activation.

### **Adjust the steering wheel position**

The steering wheel can be adjusted to suit your driving posture.

### **Steering wheel touch buttons**

There are touch zone buttons on the steering wheel that can control certain settings and adjustments.

### **Horn**

The horn button is located in the middle of the steering, indicated with the horn symbol .

---

## **8.7.1.1. Steering wheel controls**

The steering wheel has several buttons and control surfaces. They control specific functions, such as the horn, as well as certain settings, adjustments and what's shown in the driver information area.









- Horn
- Touch-sensitive buttons
- Left-hand stalk
- Right-hand stalk

## Touch-sensitive buttons



- ↺ Resume or increase set speed
- Decrease set speed
- ⊞ Alternate steering assist



-  Customizable button
-  Voice control
-  Increase volume or confirm
-  Decrease volume or decline
-  Media: Previous or rewind
-  Media: Next or fast-forward

The button functions change depending on the context, typically controlling what's currently shown in the display.

You can set the customizable button to always correspond to a certain action.

## Interacting with the touch-sensitive buttons

The buttons on the right-hand of the steering wheel often control what you see on the right-hand of the driver information area. The buttons on the left-hand side often control what you see on the left-hand side. The driver information area in the display typically shows which action each zone is assigned to.

You can find the touch button zone you're looking for by moving your finger across the buttons. The display reacts and shows what the button's assigned behavior or action is. When the function you want is indicated, press the button.

### 8.7.1.1.1. Assigning an action to the customizable button

You can set the customizable steering wheel button to correspond to a certain action.

You can assign a specific action to the customizable steering wheel button . By doing this, you select which function you want to be able to control with it.

The available settings are:

- Screen view    Switch between display modes in the driver information area.
- One pedal drive    Adjust One Pedal Drive settings.

- 1 Press the vehicle symbol  in the bottom bar and go to **Settings**.
- 2 Go to **Controls** → **Steering wheel controls** → **Customizable button**.
- 3 Assign an action to the customizable button.

### 8.7.1.2. Adjusting the steering wheel position

You can adjust the steering wheel position to suit your driving posture.

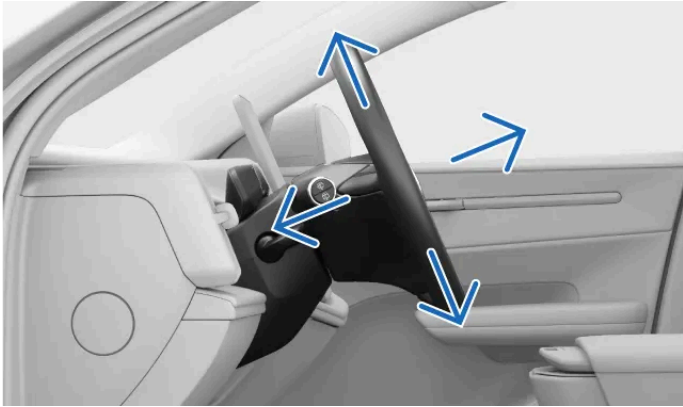

Adjusting the steering wheel position is fundamental to your driving posture, offering you better comfort and control of the vehicle.

 **Warning**

Make sure that you adjust your steering wheel position when you are parked, as this should not be done while driving.

- 1 Push the steering wheel adjustment lever located on the steering wheel column.

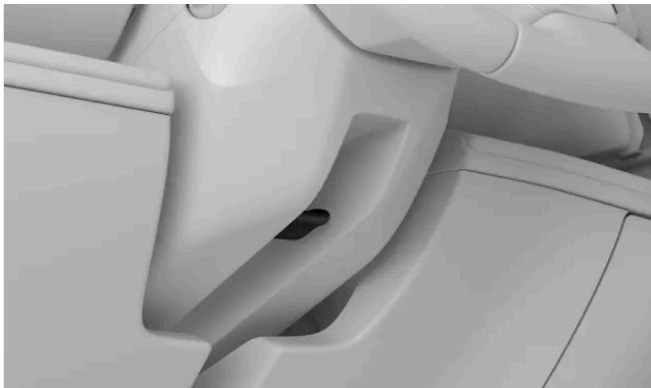

- 2 Grasp the steering wheel and adjust its position.  
Move it up or down and backwards or forwards to suit your driving posture.
- 3 Pull the steering wheel adjustment lever up to secure the position of the steering wheel.

 **Important**

Once you've finished adjusting the steering wheel position to your liking, it's important to make sure other parts of the vehicle are aligned correctly. Your driving posture is important and is affected by more than the steering wheel adjustments, such as the position of your seat and mirrors.

## 8.7.2. Adjusting steering feel

You can adjust the steering wheel resistance and driving feel via settings.

A range of predefined settings are available to control the steering feel. These options are selected in the display.

### Note

Your vehicle has speed-dependent steering wheel resistance, in addition to the manually adjusted steering feel. This means that your vehicle automatically adjusts the steering wheel resistance in line with your driving speed, giving you enhanced control and stability.

- 1 Press the vehicle symbol  in the bottom bar and go to **Settings**.
- 2 Go to **Driving** → **Driving dynamics** → **Steering feel**.
- 3 Select a steering feel setting.

---

## 8.8. Brakes

Your vehicle has several types of braking functions, both manual and automatic.

Your vehicle has several features and capabilities when it comes to braking.

|   |  |
|---|--|
| <b>Foot brake</b>                                 | Your main way of braking manually. Pressing the brake pedal may activate regenerative braking or engage the friction brakes, depending on the driving conditions.                        |
| <b>One Pedal Drive</b>                            | When One Pedal Drive is active, you control both braking and acceleration with the accelerator pedal.  |
| <b>Regenerative braking</b>                       | Slows the vehicle down by using the vehicle's movement to charge the battery. <sup>[1]</sup>   |
| <b>Friction brakes</b>                            | Slows the vehicle down by engaging the disc brakes.  |
| <b>Parking brake</b>                              | Keeps the vehicle in place while parked.   |
| <b>Auto hold</b>                                  | Automatically applies the brake to hold the vehicle when coming to a stop.   |
| <b>Automatic braking</b>                          | This is a general term for the vehicle's braking interventions. Several driver support and safety systems can intervene and perform braking maneuvers for safety reasons or convenience. |
| <b>Post-impact braking</b>                        | Automatic braking after severe collisions to avoid further hazards.  |
| <b>Electronic stability control<sup>[2]</sup></b> | Helps prevent skidding and other stability-related issues by automatically applying the brakes.  |

**Note**

### Brake lights

Your vehicle's brake lights automatically light up during braking maneuvers. The lights respond to manual braking from the brake pedal and One Pedal Drive, as well as automatic braking from any driver support system.

### Emergency brake lights

During hard braking maneuvers, or if the ABS system is activated, the emergency brake lights will activate. This causes additional brake lights to light up to alert vehicles behind you.

<sup>[1]</sup> Converts kinetic energy to electricity

<sup>[2]</sup> ESC

---

## 8.8.1. Foot brake

The foot brake engages different types of braking mechanisms, depending on the situation.



The foot brake engages either regenerative braking or the friction brakes, depending on how hard you press the pedal. Light braking activates regenerative braking, whereas harder braking engages the friction brakes.

 **Note**

### Automatic disc brake engagement

Regenerative braking often covers the majority of your braking needs. Therefore, it's possible that the disc brakes won't be engaged for long periods of time. To keep them clean, dry and ready for use, the vehicle will regularly engage the disc brakes along with regenerative braking in light braking maneuvers.

## Electronically controlled braking<sup>[1]</sup>

The foot brake is electronically controlled. As the braking force is transmitted electronically rather than physically, there are no natural reaction forces traveling from the brakes to the pedal.

## Anti-lock braking system<sup>[2]</sup>

The vehicle's anti-lock braking system prevents the brakes from locking up during hard braking. This improves maneuverability.

 **Note**

### P button

At high speeds, pressing and holding the P button slows the vehicle down at a steady rate. This provides a backup alternative to braking normally. Only use the P button in this way if you are unable to brake using the brake pedal.

### Startup checks

Several brake systems are part of the vehicle's startup check. Make sure to resolve any indicated brake faults before driving.

 **Warning**

### Wet brakes

The vehicle's stopping distance is longer if the brake discs are wet. If they have been exposed to water, safely perform a braking maneuver to remove water from the brakes. Engaging the disc brakes while driving heats up and dries them.

<sup>[1]</sup> Also called brake-by-wire.

<sup>[2]</sup> ABS

---

## 8.8.2. Parking brake

The parking brake engages when you transition from a driving gear to the vehicle's parked state.

The parking brake locks the vehicle's rear wheels. When parked, the vehicle monitors and automatically tightens the grip if necessary.

By pressing the stalk button marked P, you put the vehicle in park and the parking brake is engaged.<sup>[1]</sup>

Your vehicle will automatically engage the parking brake in several situations. These include:

- Your vehicle has been stationary in auto hold for an extended period of time.
- You leave your vehicle.
- A charging cable is connected to your vehicle.
- At the end of an assisted parking maneuver.

The driver information area indicates when the vehicle is in park and the parking brake is engaged.

 **Warning**

Avoid parking on a slope in winter conditions. The tires might lose traction, even if the parking brake is engaged. You are always responsible for safe parking. Check the parking brake warning symbol for the parking brake status.



## Automatic release

The parking brake releases automatically when you select a driving gear.

 **Note**

### P button

At high speeds, pressing and holding the P button slows the vehicle down at a steady rate. This provides a backup alternative to braking normally. Only use the P button in this way if you are unable to brake using the brake pedal.

<sup>[1]</sup> The vehicle needs to be stationary to be put in park.

---

## 8.8.2.1. Engaging the parking brake

Engage the parking brake by pressing the button marked P on the right-hand steering wheel stalk.

Your vehicle can automatically apply the parking brake in several situations. You can also apply the parking brake manually.

- 1 After coming to a stop, press the button marked P on the right-hand steering wheel stalk.

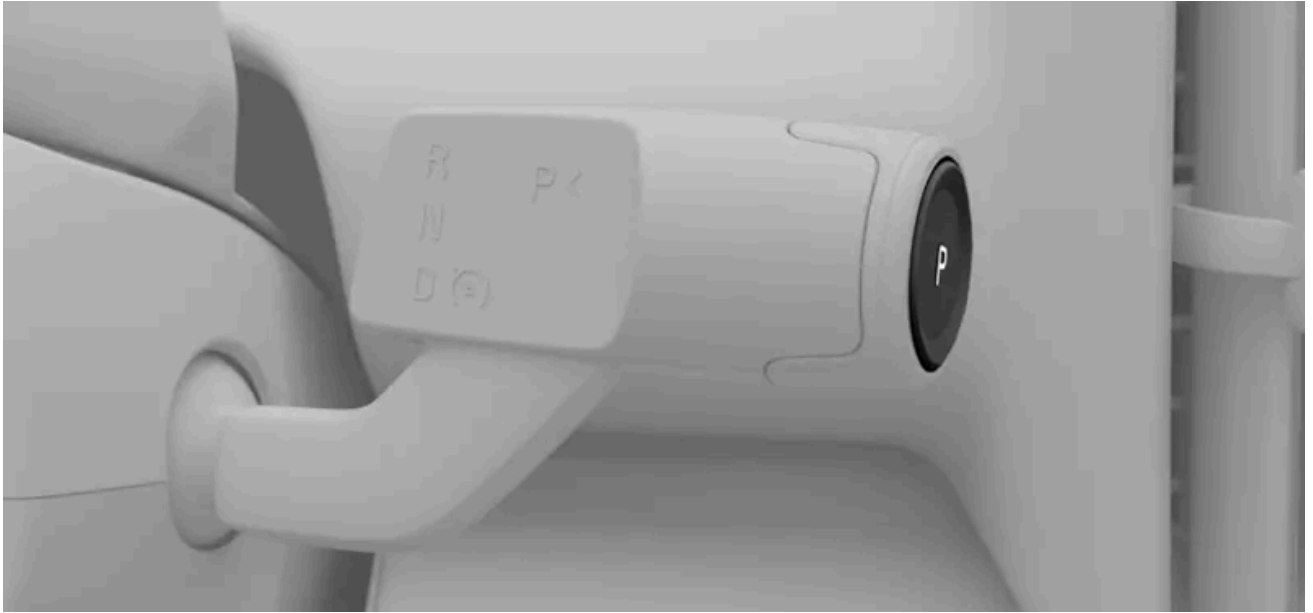

- The vehicle transitions to a parked state, which includes engaging the parking brake. The new state is indicated in the driver information area.



The parking brake releases automatically when you select a driving gear.

---

### 8.8.3. Auto hold

Auto hold helps to keep the vehicle stationary after coming to a full stop, allowing you to release the brake pedal.

When the vehicle comes to a stop while automatic creeping is enabled, auto hold will only activate automatically if the necessary conditions are met. When creeping is disabled, the vehicle will slow down gradually until it comes to a standstill. Auto hold is then activated automatically.

Activation of auto hold is indicated by the auto hold activation symbol in the driver information area.



To exit auto hold and continue driving in the selected gear, press the accelerator. If you are in gear D, you can also exit auto hold by changing gear.

 **Note**

### Transitioning from auto hold to parked

Your vehicle will transition to P if auto hold is active for several minutes, if you unbuckle your seat belt or if you open the driver door.

### Conditions

Auto hold is available when you are in gear D. You must also have your seat belt buckled and the driver door closed.

---

## 8.8.4. Post-impact braking

The vehicle automatically applies the brakes when a severe collision is detected. This can reduce the risks associated with additional impacts.

In the moments after a collision, the vehicle may still be moving at high speed. There is also a major risk that the driver is not in full control of the vehicle, which could lead to additional impacts.

In the event of a severe collision<sup>[1]</sup>, automatic braking reduces your speed in a controlled manner, bringing the vehicle to a halt. Reducing your speed is especially important if there are pedestrians, vehicles or objects in the vehicle's path.

The brake lights and hazard warning lights activate during the maneuver. When the vehicle comes to a stop, the hazard warning lights stay on and the parking brake activates.

 **Note**

### Manual override

Pressing down on the accelerator overrides the braking maneuver, allowing the driver to select a safe place to stop.

Post-impact braking requires that the brake system is intact after the collision.

<sup>[1]</sup> The severity of the collision must exceed a certain threshold for post-impact braking to activate. For example, if airbags have deployed.

---

## 8.9. Selecting the gear



Select a gear with the right-hand side steering wheel stalk. The current gear is indicated in the driver information area.

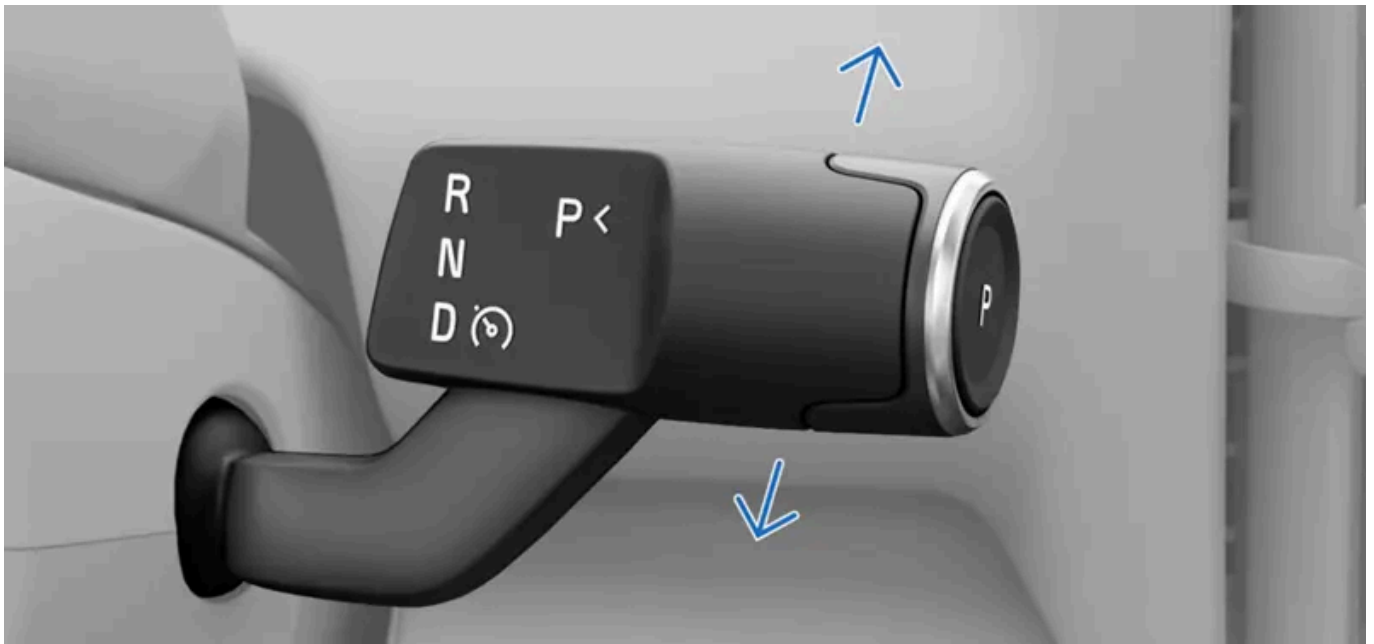

R Reverse  
N Neutral  
D Drive

In addition to gear selection, the right-hand stalk also controls the parking brake and certain driver support functions.

Changing gears is only possible when the vehicle is stationary or when you are driving at walking pace.

- 1 Press the brake pedal<sup>[1]</sup>.
  - 2 Move the stalk up or down to select a gear.
- Your selection is indicated in the driver information area.

**Note**

When moving the gear selector either up or down, you can feel that it has two positions in each direction. Select R by moving the gear selector all the way up. Move the selector all the way down to select D.

You can select the neutral gear, N, by moving the gear selector to the first position in either direction, and holding it there for a couple of seconds. The stalk always returns to its middle position between gear selections.

<sup>[1]</sup> only necessary if your vehicle is stationary

## 9. Visibility, mirrors, and exterior lights

Learn how to control your car's lights, mirrors, and wipers for better visibility when conditions call for it.

Your vehicle is equipped with multiple features to assist you in your driving. Some are designed to improve safety, while others improve visibility. Some features are designed with both purposes in mind. Reading this section of the manual can assist in making your driving experience safer and more comfortable.

### 9.1. Exterior lights

Your vehicle has a range of lighting capabilities. You can select and control the different lighting options in the display and on the left-hand steering wheel stalk.

#### **Warning**

Vehicle light systems that are dependent on ambient light detection do not relieve you from your responsibility to ensure that proper lighting is used for all situations according to local laws and traffic regulations.

Exterior lights refers to all of the exterior illumination functions and features that affect visibility.



- ① You control certain driving lights, such as the high beam and the turn signals, with the left-hand steering wheel stalk.
- ② You select primary lighting modes, additional driving lights and exterior convenience lights in the main area of the display.
- ③ The hazard warning lights button is located on the overhead console.

Some lighting features rely on the vehicle's ability to sense poor light conditions outside. Make sure that the vehicle's cameras are kept clean and are well-maintained. If the cameras' views are affected by dirt, they can't do their job properly. They need to be able to obtain enough information so that they can properly direct the car's lighting responses.

 **Note**

There is a forward-facing camera located behind the windshield. Do not clean the camera or any area behind the windshield cover by yourself, it should only be carried out by an authorized Volvo workshop or similarly qualified service professional. If you are concerned that the camera's visibility is obscured by dirt, use the windshield wipers and washer fluid to clean the windshield in front of the camera. The camera will be cleaned during regular scheduled servicing. If in doubt, or if you suspect that the camera needs immediate cleaning, contact Volvo Support.

 **Note**

Exterior lighting may temporarily contain water from condensation. This is normal and all exterior lights are designed to withstand this. Condensation is normally vented out of the light housing after a period of time.

## 9.1.1. Driving lights





Driving lights mix automatic behaviors and direct controls in a way that allows you to adapt to any situation or visibility condition.

 **Important**

The driver is always responsible for ensuring that the vehicle is driven while using a lighting mode that is suitable for the current driving conditions and local traffic regulations.

### Primary lighting

You can choose between several different primary lighting modes in the display. Your selection sets a standard lighting behavior.

|   |   |  |
|---|---|--|
| <b>Auto</b>   |  | Automatic lights mode <sup>[1]</sup> allows your vehicle to automatically detect and calculate which lighting mode is most suitable for the driving and environmental lighting conditions.                                 |
|  | Passing beam  | You can manually select the passing beam to keep the front lights dipped.  |
|  | Parking lights  | The position lights are points of illumination around the vehicle that make it more visible to other road users. You can lock the vehicle with the parking lights on if you intend to leave it for a short period of time. |
| <b>Off</b>  |  | Off deactivates all primary lighting modes. <sup>[2]</sup>   |

 **Note**

You can only turn the lights off or select the position lights when your vehicle is parked. Automatic lights mode automatically activates when you start driving.

## Additional lights

You can control the high beam and the turn signals with the left-hand steering wheel stalk.

The hazard warning flasher helps you to warn others of potential risks. You can turn it on or off by pressing the button in the display or the overhead console.

There are additional lights that can be enabled or adjusted in the display, such as:

**Rear fog light** The rear fog light warns traffic behind you of your presence in poor visibility conditions.

**Adjust height of light beam** You can counteract any changes to the vehicle's balance by adjusting the height of the headlights.

<sup>[1]</sup> Auto

<sup>[2]</sup> Some exterior lights may remain on when driving based on regulations in various market regions.

---



### 9.1.1.1. Selecting a primary lighting mode

You can select a primary lighting mode via the display.

The primary lighting mode sets the vehicle's standard lighting behavior. In certain lighting modes, you can activate or enable additional features to help you adapt to the driving conditions.

#### Note

Some primary lighting modes can only be selected in certain conditions. You can only turn the lights off or select the position lights when your vehicle is parked. Automatic lights mode<sup>[1]</sup> automatically activates when you start driving and stays on until you select a different primary lighting mode.

- 1 Press the vehicle symbol  in the bottom bar and go to **Settings**.
- 2 Go to **Controls** → **Lights and displays** → **Exterior lights**.
- 3 Select a primary lighting mode.
- 4 Confirm your selection by pressing the OK button  on the steering wheel.

<sup>[1]</sup> Auto

---

### 9.1.1.2. High beam

The content of this manual represents the status of the user manual at the time of printing and may not be completely valid in future instances. For more information refer to the first page for the complete disclaimer note.

The high beam is important for your driving visibility. There are different options you can use to suit your needs.

 **Important**

Remember that your ability to see the road properly in low lighting conditions is important not just for your own safety, but for other road users and pedestrians too.

The high beam is more powerful and has a longer reach of illumination than the passing beam. To use the high beam, you must first select the automatic or passing beam primary lighting mode.

When automatic high beam is active, the vehicle automatically reacts to oncoming traffic to avoid causing glare to other road users.

 **Note**

The automatic high beam only activates at speeds over approximately 40 km/h (25 mph) and in low light.

You can use the left-hand steering wheel stalk to switch between the manual high beam and the automatic high beam. There are symbols in the driver information area that show which high beam setting is currently active. These include:



Manual high beam is active.



The automatic high beam is enabled but not active.



The automatic high beam is active and the lights are turned on.

 **Important**

Make sure that the vehicle cameras are well-maintained and kept clean. If the cameras' views are obscured by dirt, they will not be able to obtain enough information to properly direct the car's lighting responses.

## 9.1.1.2.1. Operating the high beam

You can control the high beam using the left-hand steering wheel stalk.

There are several different high beam options you can choose from to suit the driving conditions.

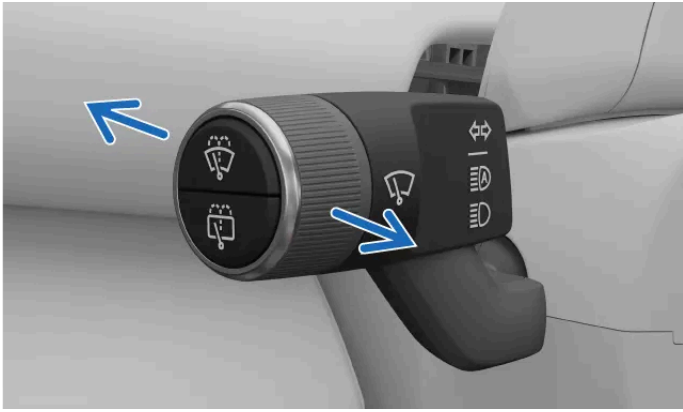

You can move the left-hand stalk forward or backward to switch between the different high beam options. The stalk always springs back to the neutral position.

The options available are:

- Automatic high beam
- Manual high beam
- High beam flash

**Note**

#### Primary lighting modes

When you are in the automatic primary lighting mode, the high beam becomes part of the adaptive front-light system and works in different ways depending on the outside light conditions. You can enable the automatic high beam in all lighting conditions, but both the automatic and manual high beam can only be activated in low light conditions.

When passing beam is selected as the primary lighting mode, you can only activate the manual high beam.

#### Enabling or activating the high beam

- When the high beam is turned off, push the stalk once to enable the automatic high beam or activate the manual high beam.

#### Deactivating the high beam

- Pull the stalk all the way towards you to turn the high beams off.

#### Flashing the high beam

- A short pull of the stalk activates the high beam flash.

#### Switching between manual and automatic high beam

- When the automatic lights mode<sup>[1]</sup> is selected and the high beam is activated, push the stalk once to switch between the automatic high beam and the manual high beam.

**!** Important

Make sure that the vehicle cameras are well-maintained and kept clean. If the cameras' views are obscured by dirt, they will not be able to obtain enough information to properly direct the car's lighting responses.

[1] Auto

### 9.1.1.3. Operating the turn signals

Use turn signals to communicate how you intend to maneuver your vehicle. The controls are located on the left-hand steering wheel stalk.

The turn signals have two types of activation – quick and standard. While the turn signals are blinking, you will hear a clicking sound and see a turn signal symbol in the driver information area of the display.



#### Quick turn signal

- Move the left-hand steering wheel stalk slightly up or down and allow it to spring back to the middle.
- The signal will blink three times before turning off.

#### Standard turn signal

- Move the left-hand steering wheel stalk up to turn the right turn signal on and down to turn the left turn signal on.
- The stalk moves back to its original position and the turn signal will turn off when you straighten the steering wheel out after turning.

**i** Note

You can cancel a standard turn signal by moving the left-hand steering wheel stalk slightly up or down.

 **Note**

### Turn signal malfunction



In the event of any malfunction or damage to the turn signal function, the malfunction symbol  appears in the display.

---

## 9.1.1.4. Activating the rear fog light

The rear fog light is designed to warn traffic behind you of your presence in bad weather with poor light conditions.

The rear fog light needs to be manually activated in the main area of the display.



- 1 Press the vehicle symbol  in the bottom bar and go to **Settings**.
- 2 Go to **Controls** → **Lights and displays** → **Exterior lights** → **Rear fog light**.
- 3 Turn it on or off by pressing the fog light symbol .

---

## 9.1.1.5. Adjusting headlight height

You can adjust the height of the front headlights.

Changing the vertical tilt of the low beam allows you to control how far ahead the beam will illuminate. You can use the headlights' height adjustment to counteract any changes to the vehicle's balance. Keep in mind that a high beam angle can cause glare to other road users.

- 1 Press the vehicle symbol  in the bottom bar and go to **Settings**.
- 2 Go to **Controls** → **Lights and displays** → **Exterior lights** → **Adjust height of light beam**.
  - > The height adjustment page opens.
- 3 Select the height you want.
- 4 Confirm your selection by pressing the OK button  on the steering wheel.



## 9.1.1.6. Hazard warning lights

If there is a potential risk to surrounding traffic, you should turn the hazard flashers on. This helps to alert other road users of the need for greater awareness.

### ! Important

It is the driver's responsibility to use hazard lights according to local laws and traffic regulations.

The hazard lights button is located in the overhead console. You can also access the lights in the bottom bar in the display.



The location of the hazard lights button in the overhead console



The location of the hazard lights button in the display

The status and interaction points to control the hazard flashers are signified by the associated symbol.



### In the event of a collision

Your hazard lights will automatically turn on in the event of a collision.<sup>[1]</sup>

There is a cool-down period which disables the option to turn the hazard flashers off. When you are able use them normally, the hazard lights button begins flashing again.

[1] This is dependent on local regulations and regional standards.

---

## 9.1.1.6.1. Activating the hazard warning flashers

The hazard warning lights are essential for driving safety. Be sure that you know how to work them.



Hazard warning flasher symbol

When you get into the vehicle, the hazard warning lights button in the overhead console lights up, showing that you can use it. There's also a button located in the bottom bar in the display.

- 1 Press the hazard warning lights button, either in the overhead console or the display.
  - Both of the turn signal symbols the driver information area of the display and the hazard warning lights buttons flash simultaneously in the same rhythm as the lights. You will also hear a ticking sound.

---

## 9.1.2. Exterior convenience lights

There are lighting functions available that make it easier to see when you are outside your vehicle.

The convenience lights are the lights that come on when the vehicle is parked.

### Welcome lights

The welcome lights display a short light sequence and give better visibility as you approach your vehicle. The welcome lights sequence is triggered when you unlock your vehicle. It can be enabled via the display.

### Guidance light

The guidance light provides extra lighting around your vehicle and activates when your vehicle is locked. This is useful when you are parked in a dark location. You can use the display to set your desired time duration or turn the guidance light on or off.

---

## 9.1.2.1. Enabling the guidance light

The guidance light helps you to see when you're outside of the vehicle and helps others to see you.

**The content of this manual represents the status of the user manual at the time of printing and may not be completely valid in future instances. For more information refer to the first page for the complete disclaimer note.**

The guidance light illuminates the area surrounding your vehicle to help you see in low light conditions. You can enable it and select a time duration via the display. The guidance light automatically activates when your vehicle is locked and deactivates after the selected time period.

- 1 Press the vehicle symbol  in the bottom bar and go to **Settings**.
- 2 Go to **Controls** → **Locking** → **Guidance light**.
- 3 Turn it on or off, or set your desired time duration.

The guidance light stays enabled between drives. You can disable it via the display.

---

## 9.1.2.2. Enabling the welcome lights

In addition to the default lights that activate when you unlock your vehicle, you can turn on the welcome lights sequence.

The welcome lights display a short lighting sequence and give better visibility as you approach your vehicle.

- 1 Press the vehicle symbol  in the bottom bar and select **Settings**.
- 2 Go to **Controls** → **Locking** → **Welcome light**.
- 3 Enable or disable the welcome lights.

Your vehicle will keep these features active until deselected.

---

## 9.2. Mirrors

The rearview mirror and the two door mirrors are important for your driving awareness. Make sure that you adjust the mirrors to your needs before driving.

### Rearview mirror

You can adjust the interior rearview mirror by angling it manually.

### Door mirrors

You can adjust the door mirror positions using the buttons on the right side of the steering wheel.

You can save the door mirror positions to your user profile.

Via the locking settings, you can set the mirrors to automatically fold and unfold when you lock or unlock the vehicle.

The door mirrors are heated to prevent ice and frost from impeding visibility.

 **Note**

**Alerts about vehicles in blind spots**

The door mirrors have lights on them to give you greater driving awareness. They activate when vehicles are detected in or near the blind spots.

**Open door warning**

The door mirror lights will also illuminate when a door is open.

 **Warning**

The passenger side's door mirror is curved to improve visibility. Objects may appear to be further away than they actually are.

## Mirror dimming

The dimming function reduces strong reflections from bright lights.

The driver side door mirror and the rearview mirror have automatic dimming.

## 9.2.1. Adjusting door mirrors

Before you start driving, make sure that the door mirrors are in positions that give you good visibility.

- 1 Press the vehicle symbol  in the bottom bar and select **settings**.
- 2 Go to **Controls** → **Mirrors and wipers** → **Adjust side mirrors**.
- 3 Press **Adjust**.
  - The adjustment settings view appears.
- 4 Select the door mirror you want to adjust.
- 5 Use the steering wheel buttons to adjust the selected mirror.



Tip

### Folding and unfolding the door mirrors

You can fold and unfold the door mirrors in the adjustment settings view. This can be useful to do when you are parking or driving in narrow spaces.

If you fold the door mirrors and start driving, they will fold out again when the vehicle reaches a certain speed.

## 9.3. Wipers and washers

The wipers and washers work together to keep the windshields clean and clear.

### Wiper and washer controls



You can control the wipers and washers using the scroll wheel and buttons on the left-hand steering wheel stalk.



Front wipers and washers



Rear wiper and washer

The front washer nozzles are located on the underside of the hood, at the base of the windshield. The rear washer nozzle is on the underside of the roof spoiler, above the rear windshield.

### Front wiper modes

The front wipers have an automatic mode as well as multiple manual speeds. Each wiper mode sets a different speed for the wiper movements, so you need to select the appropriate mode for the conditions you are driving in. You can see the current wiper mode in the display. Between drives, the vehicle resets to automatic mode by default.

When automatic mode is active, the vehicle uses information from its rain sensor to activate the wipers and control their speed. You can change the rain sensor sensitivity in settings and the quick controls view. When the rain sensor is active, you can see a symbol in the display.



Active rain sensor symbol

## Rear wiper

Use the left-hand steering wheel stalk to manually turn the rear wiper on or off. The driver information area of the display shows whether the rear wiper is active or not.

You can also enable a setting to allow the rear wiper to activate automatically when you are reversing the vehicle. When this setting is enabled via the display, the rear wiper automatically activates if the front windshield wipers are active while you are reversing. If you change gear, the rear wiper will stop wiping the rear windshield.

### Important

#### Maintenance, refilling and replacing

- Clean the wiper blades regularly.
- Replace the wiper blades if they show signs of wear.
- Refill washer fluid when your vehicle tells you to.
- Avoid using the wipers without lubrication from either rain or washer fluid. It can cause wear or damage.

#### Car wash safety

Turn the automatic wiper mode off when you enter a car wash. Otherwise, the rain sensor will cause the wipers to activate, which could lead to damage.

---

## 9.3.1. Controlling the front wipers

You can manually activate the windshield wipers or change the way they work. When the vehicle detects rain in automatic mode, the wipers will activate.

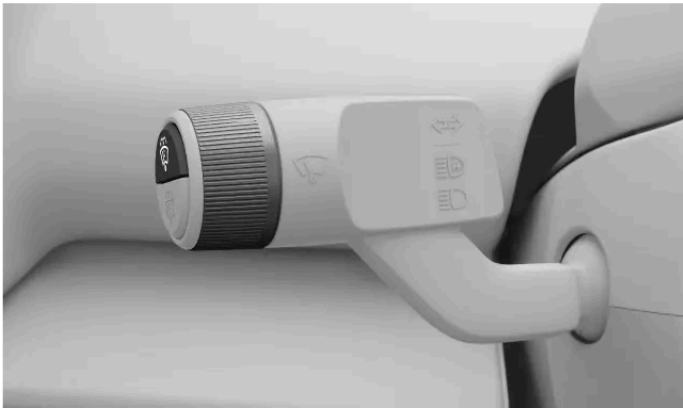

There are different front wiper modes that you can activate by using the left-hand stalk. The modes are:

- Off** Wipers are turned off
- Auto** Automatic mode using rain sensor
- 1x** Low
- 3x** High

#### Single wipe

- 1 Press once on the upper button on the end of the left-hand steering wheel stalk.



- The wipers will swipe once across the front windshield.

#### Changing wiper mode

- 2 Rotate the scroll wheel on the end of the left-hand steering wheel stalk.
- The display shows the wiper menu as you scroll through the wiper mode options. The currently selected mode is also highlighted.

---

## 9.3.2. Controlling the rear wiper

The rear wiper can be manually turned on and off. You can also enable a setting via the display to allow the rear wiper to activate automatically when you are reversing the vehicle.



You control the rear windshield wiper by using the lower button on the left-hand steering wheel stalk.

#### Turning on and off

- 1 Press once on the lower button on the end of the left-hand steering wheel stalk.



> The rear wiper turns on.

- 2 Press the button again to turn the rear wiper off.

#### Enabling automatic rear wiper while reversing

- 3 Press the vehicle symbol  in the bottom bar and go to **Settings**.
- 4 Go to **Controls** → **Mirrors and wipers** → **Auto rear wiper while reversing**.
- 5 Turn it on.

---

## 9.3.3. Activating washers



Activate the front or rear windshield washers using the buttons on the left-hand steering wheel stalk.



Washer buttons on the left-hand steering wheel stalk.

- Press and hold the button on the left-hand steering wheel stalk for the washer you want to activate. The front washer is activated by the upper button, and the rear washer is activated by the lower button.



Front wipers and washers symbol



Rear wiper and washer symbol

- The washers and wipers work together to distribute washer fluid across the windshield. When you release the button, the wipers make a few more passes to wipe away excess fluid.

## 10. Driver support and navigation

Driver support features are designed to improve safety, comfort and convenience when you are using your vehicle. They assist you with your driving, route-planning and decision-making on the road.



The collection of driver support features in this vehicle can assist you in driving, navigating and parking. Some are exclusively designed to improve safety, while others improve convenience. Some features are designed with both purposes in mind.

When used correctly, driver support features can reduce the effort of driving, help reduce distractions and improve safety for you and others. They often take advantage of the vehicle's ability to monitor and keep track of its surroundings. Some features deliver that information to you for increased driver awareness, while other features provide fast reactions to hazards that the vehicle identifies.

---

### 10.1. Navigation

Use the Google Maps navigation app to get directions and traffic information, as well as to find the nearest charging station.

When the vehicle is connected to the internet, it can continuously download map and traffic information to help you navigate to a destination. Navigation guidance can appear in the vehicle's display.

The vehicle knows its location through GPS and shows it in the vehicle's display.

# Navigation app



Google Maps symbol

## Note

### Latest app version

Be sure to update the app whenever there's a new version available. Functionality and support for old versions may vary.

## Connected navigation features

Whenever your vehicle is connected to the internet, it can get the latest navigation information.

|  |   |
|--|---|
| <b>Real-time traffic information</b>             | You can get real-time traffic information if the vehicle is connected to the Internet. For example, you can see if traffic is moving slowly. Different colored lines that correspond to traffic situations will appear on your chosen map route. If the Internet connection is lost, the lines disappear after a while. You also get information about traffic conditions along the chosen route, such as roadworks or accidents. |
| <b>Alternative routes and redirected traffic</b> | When you set a destination in the navigation app, the fastest route is suggested while also taking your navigation settings into account. For example, you can choose to avoid tolls or ferries. The chosen route can be redirected while you are driving, such as when there is an accident or a traffic condition that affects your travel time.  |
| <b>Sharing information with other devices</b>    | Link your Google account to an active user profile to get the same Google Maps information in your vehicle as on your other devices. Destinations saved to your Google account using other devices, such as home, work, favorites and last searches, are then also available in your vehicle.   |

## Offline maps

When you are connected to the internet, you can download map areas so that they are available in the vehicle even if your vehicle has poor reception or no internet connection. This feature is available in Google Maps' settings.

## Displayed information

When a route is added, the following travel information about the trip is shown in the display:

- Travel time
- Distance to the next destination on your route, such as an extra stop
- Estimated time of arrival
- The name of the next destination on your route

## Navigation settings

You can change the navigation settings in the navigation app.

## Warning

### Avoid driver distraction

Avoid any interaction with the vehicle's systems or other devices that may distract you from driving safely. Any task that does not allow you to keep your attention on the road and surrounding traffic should be done when the vehicle is parked.

 **Note**

### Navigation limitations

- The navigation feature is from a third-party supplier. Availability and functionality may vary over time and depend on region.
- Navigation instructions can sometimes be less reliable than usual due to factors such as weather or road conditions.

### Poor or no internet connection

The navigation app can have trouble finding a route or signal when you are in a location which can interfere with your internet connection, such as a tunnel or multi-story parking garage.

 **Tip**

### Range and charging

There are features in navigation that can help you plan your trip based on charging stations, estimated charging time, estimated battery level upon arrival and range.

---

## 10.1.1. Finding and selecting a navigation destination

Find your destination using the search field or a voice command. The vehicle then suggests routes for you to choose from.

- 1 Press the app library symbol  in the bottom bar and open Google Maps.
- 2 Enter an address or destination in the search field.
  - > A route is suggested, together with alternative routes.
- 3 Select your preferred route.
- 4 Select start.
  - > Navigation instructions start.

---

## 10.2. Detection of surroundings and traffic

This section covers the essentials of how cameras, radar units and other sensors work, including their limitations. Understanding how your vehicle perceives its surroundings can help you use features that rely on this capability.

Your vehicle's ability to understand its surroundings is achieved through many systems and types of sensors. The vehicle's interpretation of the data it collects helps inform its behavior, especially for driver support features.

|                                   |  |
|-----------------------------------|--|
| <b>Cameras</b>                    | Cameras work similarly to the human eye. What they capture is used for different purposes, which depends on the camera. For example, the upper front-facing camera helps the vehicle identify things such as traffic signs and road markings, while the rear parking camera feed appears in the display. |
| <b>Radar units</b>                | The radar units use radio waves to collect information about the vehicle's surroundings. They can identify the distance to objects and certain aspects of their movement. This information is essential for many features in the vehicle.  |
| <b>Ultrasonic parking sensors</b> | These sensors use sound waves to detect relatively close objects. They work by sending out ultrasound pulses that can bounce back to the sensors when they encounter an object.  |

## How the systems work together

The different detection types complement each other. They are sometimes used on their own and sometimes together.

### Important

Even when used together, these detection systems cannot handle all conditions and traffic situations. This is why it's important for the driver to never rely fully on driver support features. Always be attentive to conditions and situations where driver support feature performance is affected by the limitations of these features.

## General detection and identification limitations

Each type of detection has its own set of limitations, but there are a few general things to consider as well.

- The vehicle can't always handle unpredictable or unusual situations. When the vehicle finds it difficult to correctly identify the environment or traffic situation, the accuracy of its response is affected.
- Damage to the vehicle can affect detection and features that rely on it. Many faults can be identified by the vehicle, but some may not be possible to self-identify. This is why it's important to make sure that the vehicle is in good condition and working order. Contact an authorized Volvo workshop if you suspect there are any faults or if you notice damage to the vehicle.
- Limiting factors and conditions can and often do coincide. They can compound and interact in ways that lead to an incorrect response from the vehicle.

## Obstacle detection limitations

Obstacle detection helps the vehicle identify certain stationary and moving objects. These objects include other road users such as pedestrians or other vehicles, as well as animals, barriers or other objects. If obstacles are in or close to the vehicle's driving path, they could pose a collision risk. Depending on the circumstances, the vehicle might be able to warn or intervene if the object is accurately identified. For every type of object the vehicle can identify, there are many factors that can prevent accurate identification. Examples of limiting factors, situations and events include:

- Closely spaced, overlapping or partially blocked objects and road users.
- Objects and road users that blend in with the background.
- Objects and road users that move or accelerate particularly fast.
- Uncommon vehicles, such as recumbent bicycles, combine harvesters or trailers with oddly shaped loads.

The content of this manual represents the status of the user manual at the time of printing and may not be completely valid in future instances. For more information refer to the first page for the complete disclaimer note.

- Bicycles of a different type or size compared to a regular adult bicycle.
- New modes of transportation.
- Pedestrians wearing clothing or carrying objects that alter their silhouette.
- Pedestrians shorter than 80 cm (32 inches).
- Obstacles angled in ways that create an unknown silhouette.
- Size and speed of animals. Cats and dogs are often too small to be reliably identified.

**Note**

### Traffic detection examples

The following examples of different traffic scenarios can help you understand some of the limitations of your vehicle's detection systems. Real-world scenarios are often more complex than the following illustrative<sup>[1]</sup> examples in this manual.

## Out of view and late detection

The various detection zones around your vehicle are static, each with a limited range and field of view. If something enters a detection zone at an unusual angle, at high speed or very close to your vehicle, it can cause a rapid response. This reduces safety margins compared to a situation in which earlier detection is possible.

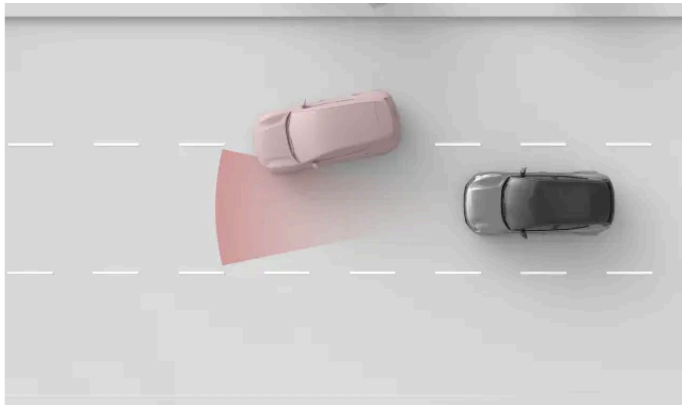

The front radar's detection zone has a limited width. If you get cut off by another vehicle, detection can occur relatively late, causing your vehicle to respond suddenly.

**Important**

### Lane placement and small vehicles

Forward detection works better for objects in the middle of the lane than for those on the outer edges. Vehicles can go undetected if they don't occupy the middle of the lane. While this can happen for any vehicle, the risk is higher for small vehicles such as motorcycles. They take up less of the lane's width and can move about more within the lane. Always pay extra attention to any vehicle not driving in the middle of the lane.

## Shape, size and number of objects

Detection can be less reliable depending on the shape, size and number of objects in a detection zone. These factors can make identification of the distance to the closest vehicle ahead less accurate, especially if several of these factors come into play.

**The content of this manual represents the status of the user manual at the time of printing and may not be completely valid in future instances. For more information refer to the first page for the complete disclaimer note.**

- Small objects are harder to identify.
- The more objects in the detection field, the harder it is to identify individual ones.
- Objects close together that overlap are harder to identify.
- Objects with irregular shapes, such as overhanging or projecting parts, are harder to identify.

The presence of a large vehicle in front of you can make it difficult to identify a smaller one like a motorcycle between you and the large vehicle.

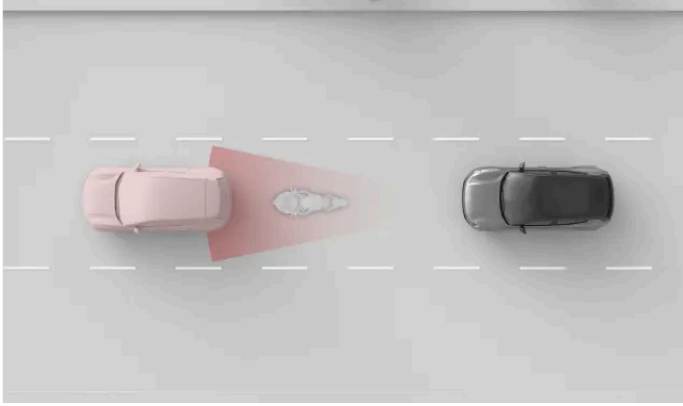

If the motorcycle and the larger vehicle are close to each other, they may appear to overlap to the detection systems, making detection of the motorcycle less accurate.

**!** Important

**Trailer in front**

Trailer detection is often less reliable than the detection of other vehicles due to their shape and height. This applies, in particular, to narrow trailers, flatbed trailers and trailers with high load beds. These types of trailers often don't have enough surface area at the height where forward detection systems focus.

**Road and infrastructure**

Curves in the road can cause the vehicle to misinterpret the traffic situation. For example, it can lose track of a vehicle or misidentify which lane a vehicle ahead is in.

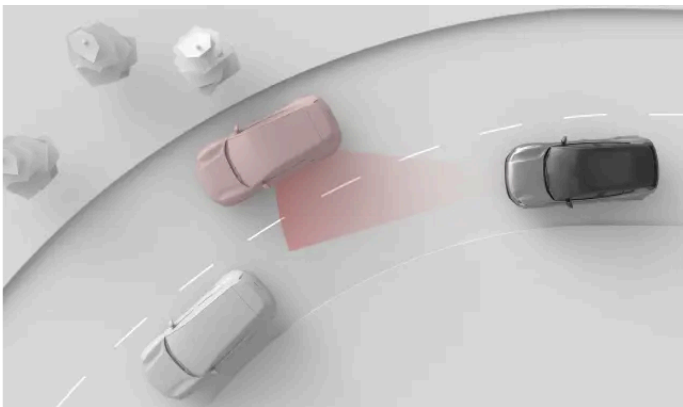

On a curve, the vehicle ahead may slip out of the detection zone. Vehicles in the adjacent lane may also enter the zone, affecting your vehicle's perception of the distance to traffic ahead.

 **Important**

### Road condition and irregularities

Both common and uncommon road features can impact the effectiveness of the vehicle's detection systems.

- Sharp bends and bumps in the road can temporarily obscure important parts of the vehicle's surroundings, such as other vehicles or road markings.
- Non-standard or unusual road infrastructure might not be correctly identified by the vehicle. For example, road work or traffic diversions can result in conflicting or multiple sets of road markings.
- Worn road markings or signs might not be correctly identified.

<sup>[1]</sup> The representations of detection systems and the vehicle's surroundings are not to scale.

---

## 10.2.1. Locations of cameras, sensors and radar units

Knowing the placement of different components the vehicle uses to map its surroundings helps you keep them free of dirt, obstructions and accidental damage.

Many of your vehicle's driver support features rely on data from components that scan and map your vehicle's surroundings, such as cameras, sensors and radar units. This section doesn't show all components and their precise locations, but it gives you a general idea of where they are. Areas pointed out in this section are particularly important to keep clean. Damage to these areas can also affect functions that rely on components located there.



 **Warning**

### Clean regularly

Camera, sensor and radar locations on the vehicle must be cleaned on a regular basis and kept free from labels, objects, dirt and other potential obstructions. Otherwise, vehicle functions may respond incorrectly or become less responsive or deactivated.

### Mounted accessories

Be mindful of the effects of mounted vehicle accessories, such as cargo carriers or exterior light accessories. The items themselves or the load you add may obstruct cameras, sensors or radar units.

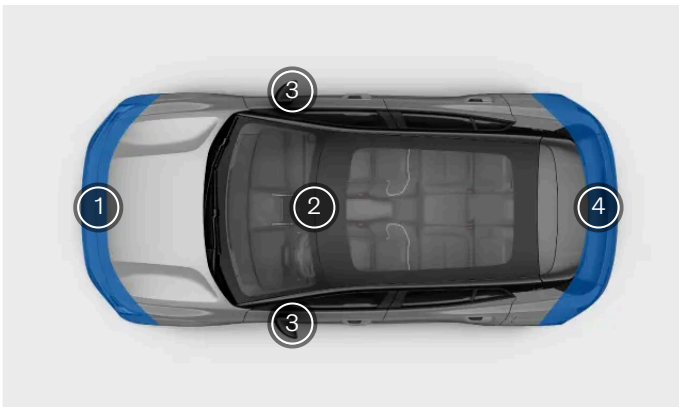

- ① The front of the vehicle houses several detection components. There is a radar in center, just below the license plate, as well as additional radar units in each corner. There is also a camera in the center and several parking sensors along the lower edge.
- ② The top center of the windshield houses a front-facing camera.
- ③ The vehicle's side-view cameras are located on the door mirrors. The right-side door mirror also houses the ambient climate temperature sensor.
- ④ The rear of the vehicle houses a rear-view camera in the center and radar units in each corner. There are also several parking sensors along the lower edge.

 **Tip**

### Finding the parking sensors

You can see the exact location of your vehicle's ultrasonic parking sensors by looking for their button-like cover plates along the bumper panel.

 **Important**

### Cleaning in front of radar units

If you find dirt, snow or ice, or if the vehicle indicates that a radar unit is blocked, you should address it as soon as possible. Always clean and clear a large area around the radar units to so their full field of view is available.

## 10.2.2. Camera detection and limitations

The vehicle cameras capture the surroundings in a way similar to the human eye. This comparison is useful for understanding their capabilities and limitations.

Cameras help the vehicle identify certain objects and surfaces that visually stand out against their backgrounds. This includes things such as road markings, traffic signs, pedestrians and other vehicles.

Camera information in the parking view can provide you with an additional way to monitor the vehicle's surroundings.

### Light conditions

Cameras need light to work and are affected by light conditions.

- Strong light sources, such as the sun, can cause glare and reflections that negatively affect camera detection.
- Low light can negatively affect certain types of camera detection.
- Some detection types require low-light conditions. When it's dark, the lights from other vehicles can be identified, as they stand out against the background.

#### Important

##### Camera detection in darkness

For the vehicle to be able to identify other vehicles when it's dark, the other vehicles must have their headlights and tail-lights turned on and be clearly visible. While the vehicle also uses other types of detection, such as radar, it may not have enough information to reliably identify vehicles that are not seen by the cameras. Several driver support features can be affected by this, such as safety interventions, collision warnings and features that provide distance-keeping.

### Visibility

Poor visibility for the driver typically means poor visibility for the cameras. Objects that are hard to detect for the human eye can sometimes be hard to detect for the cameras as well. This can include well-camouflaged objects or objects where the outlines don't stand out against the background.

- Fog, heavy rain, snow or dust storms can severely limit visibility for the cameras.
- Beware of dust, water or snow on the ground that may be disturbed and kicked up into the air by your vehicle, other traffic or the wind.

### Field of view and obstructions

Cameras see in the direction they're facing and only within their field of view. The field of view differs for each camera and depends on their intended purpose.

Obstructions limit what the camera sees. Each camera views the surroundings from its mounting position, and anything that enters its field of view blocks its view of what lies behind the obstruction. Objects close to a camera will block more of the camera's field of view than objects that are further away. If the vehicle detects that a camera is blocked, it can disable certain features that rely on that camera.

- Make sure that any mounted accessories, extra equipment or externally-stowed cargo don't block part of the cameras' fields of view. For example, far-extending roof loads may block part of the top view for front- and rear-facing cameras.

- Trailers, bike racks or other towbar-mounted equipment can block the rear camera view.
- Dirt, ice, snow, water droplets and condensation on camera lenses obstruct the cameras' view to some extent. In some cases, the vehicle may be able to identify that something is in the way and notify you. However, it is still recommended to regularly inspect the cameras and make sure that they are clean and unobstructed.

 **Warning**

### Clean regularly

Camera, sensor and radar locations on the vehicle must be cleaned on a regular basis and kept free from labels, objects, dirt and other potential obstructions. Otherwise, vehicle functions may respond incorrectly or become less responsive or deactivated.

## Other limitations

If the cameras become too hot, they can be temporarily switched off to protect them from damage. This can happen when starting the vehicle after being parked in high temperatures in combination with direct sunlight hitting a camera. The camera will become available again once it has sufficiently cooled down.

 **Important**

### Windshield damage

Windshield damage in the camera area, including small chips, scratches or cracks, can negatively affect performance of the camera and features that use it. This can cause reduced functionality, unreliable vehicle response, and disabling of features. If damage occurs, follow this manual's separate recommendations for handling windshield damage.

---

## 10.2.3. Radar detection and limitations

The radar units use radio waves to collect information about the vehicle's surroundings. They can identify the distance to objects and certain aspects of their movement. It's important not to block the radar units.

There are several radar units aimed in different directions to collect information about the vehicle's surroundings. This information is primarily used by the vehicle's driver support features. Radio waves are continuously sent out and bounce back if they encounter an object in their path. As the waves return, the vehicle can calculate things such as the position and motion of the object.

The radar units are not affected by lighting conditions and work equally well on sunny days and in complete darkness.

 **Important**

### Use responsibly

The radar units and the features that rely on them are supplements to safe driving practices. They do not reduce or replace the need for the driver to stay attentive and focused on driving safely.

## Detection zone and field of view

Each radar unit in the vehicle has its own detection zone. The zone is limited by the radar's field of view and range.

Objects in the field of view block what's behind them. The closer something is to the radar, the more it blocks the radar's field of view.

- If a radar is blocked, certain features may become less effective or respond incorrectly.
- If the vehicle detects that a radar is blocked, it may disable certain features.
- Do not place or mount anything in front of or close to the vehicle's radar units. This includes stickers, vehicle body foil and adhesive tape.
- Paintwork damage in front of a radar can affect its performance. Contact an authorized Volvo workshop for repairs if there is any damage near the radar units.<sup>[1]</sup>
- Make sure that any mounted accessories, extra equipment or externally-stowed cargo don't block the vehicle's radar units.
- Trailers, bike racks or other towbar-mounted equipment can block the radar, making it and certain features unavailable.
- The radar units are sensitive to the buildup of dirt, ice or snow in front of them. This affects the radio waves and can reduce the radar's ability to detect objects. Radar obstruction cannot always be identified by the vehicle. In situations where it is detected, the vehicle communicates this via notifications in the display. However, it is still recommended to regularly inspect the radar units and make sure the areas around them are clean and free of obstructions.



### Warning

#### Clean regularly

Camera, sensor and radar locations on the vehicle must be cleaned on a regular basis and kept free from labels, objects, dirt and other potential obstructions. Otherwise, vehicle functions may respond incorrectly or become less responsive or deactivated.

## Other conditions and limitations

Other radar sources can cause interference and reduce the effectiveness of your vehicle's radar units.

<sup>[1]</sup> Volvo recommends using authorized Volvo workshops to perform any service and maintenance work.

---

## 10.2.4. Parking sensor detection and limitations

The ultrasonic parking sensors allow the vehicle to detect objects and their distance from the vehicle. They operate at relatively close range during slow and tight maneuvering, such as when parking.

Ultrasonic sensors use sound waves to detect obstacles close to the vehicle. They work by sending out ultrasound pulses that can bounce back to the sensor when they encounter an object or barrier. This allows the vehicle to identify the distance to obstacles in the direction of detection.

Information from these sensors is only available at low speeds. They provide distance information when the parking view is shown in the display.

 **Important**

### Use responsibly

Ultrasonic parking sensors and features that rely on them are supplements to safe driving practices. They do not reduce or replace the need for the driver to stay aware of the vehicle's surroundings and focused on driving safely.

## Detection range

Ultrasonic sensors are typically located relatively low on the bumper.

- Obstacles whose supports are outside of the detection zone can go undetected. Such obstacles include objects that are suspended from above or objects that extend far from their ground support, such as certain barriers and gates.

## Blocked sensors

Ultrasonic sensors can get blocked, either reducing distance and obstacle detection or making it unavailable. To avoid blocked sensors or to better understand when they may be unavailable, consider the following:

- If a sensor is blocked, certain features may become less effective or not respond correctly.
- Heavy rain or snowfall can lead to unreliable detection, and features relying on the ultrasonic sensors becoming unavailable.
- If the vehicle detects that a sensor is blocked, it may disable certain features.
- Do not place or mount anything in front of or close to the vehicle's sensors. This includes stickers, vehicle body foil and adhesive tape.
- Bodywork damage where the sensors are located can affect their performance. Contact a workshop for repairs if there is any damage in the sensor areas.<sup>[1]</sup>
- Make sure that any mounted accessories, extra equipment or externally stowed cargo don't block the sensors.
- Trailers, bike racks or other towbar-mounted equipment can block sensors, making detection and certain features unavailable.
- Ultrasonic sensors are sensitive to the buildup of dirt, ice or snow in front of them. This can reduce their ability to detect objects. The vehicle cannot always identify parking sensor obstruction. In situations where it is detected, the vehicle communicates this via notifications in the display. However, it is still recommended to regularly inspect the sensor locations and make sure the areas around them are clean and free of obstructions.

 **Warning**

### Clean regularly

Camera, sensor and radar locations on the vehicle must be cleaned on a regular basis and kept free from labels, objects, dirt and other kinds of potential obstructions. Otherwise, vehicle functions may respond incorrectly or become less responsive or deactivated.

<sup>[1]</sup> Volvo recommends authorized Volvo workshops for all servicing and repairs.

## 10.3. Safety interventions and warnings

Your vehicle has features that directly or indirectly help prevent collisions. If your vehicle detects a dangerous traffic situation, it can intervene by warning the driver or performing an evasive driving maneuver.

Safe driving begins with good user practices. As an additional level of protection against incidents, your vehicle can warn you if it detects a situation that requires your immediate attention or action. In addition to making the driver aware through warnings, the vehicle can intervene by steering or braking to avoid or mitigate a collision.

Features that are designed to provide warnings or perform interventions in different ways include:

- Collision warnings and mitigation
- Blind spot information
- Lane keeping aid
- Driver focus and alertness notifications<sup>[1]</sup>
- Alerts about traffic crossing behind the vehicle when reversing<sup>[2]</sup>
- Automatic braking when reversing<sup>[3]</sup>



Tip

### What are safety interventions?

Safety interventions are responses from the vehicle in situations in which it identifies a high or imminent risk of collision. Warnings can be provided to alert you to hazards so that you can take action, but the vehicle is also capable of performing emergency steering or braking maneuvers depending on the situation. Some types of warnings and interventions are always enabled, while others are part of features that you may be able to customize or choose to turn on or off.

### Safety interventions to avoid collisions

When the vehicle identifies a risk of collision, it reacts according to the level of urgency. It can identify objects such as pedestrians, cyclists and vehicles that are approaching or are in your driving path. Many factors can affect how early and effectively the vehicle can detect the risk of an incident. There are situations that are beyond the vehicle's capabilities, which is why safe driving practices are essential.

If the vehicle identifies an increasing risk of collision, alerts can quickly escalate to evasive maneuvers by the vehicle. If a threat appears suddenly, the vehicle can immediately perform evasive maneuvers.

Safety interventions can include:

|                           |   |
|---------------------------|---|
| <b>Collision warnings</b> | When the vehicle identifies that there's a risk of collision, the first step is to get the driver's attention. The vehicle can warn you visually, with sound or with brake pulses.  |
| <b>Braking maneuvers</b>  | If the vehicle determines that immediate action is required, it can brake independently of the driver's actions. This can occur at the same time as a steering maneuver. The amount the vehicle brakes when intervening depends on the situation. An obstacle that suddenly appears just in front of the vehicle may cause the brakes to be fully applied, whereas another situation might require less braking to avoid a potential collision. |
| <b>Steering maneuvers</b> | If the vehicle determines that immediate action is required, it can steer independently of the driver's actions. This can occur at the same time as a braking maneuver.   |

The display can show messages about safety interventions that are performed.

 **Note**

### Overriding steering and braking interventions

- You can always override the vehicle's steering by intentionally steering the vehicle yourself.
- To override a braking intervention, you must firmly press down on the accelerator pedal. Past a certain threshold, you override the braking action.

### Knowing your vehicle's capabilities

Safety interventions by the vehicle can occur suddenly and catch you by surprise. This can cause concern, despite the benefit they provide. The more you know about your vehicle, the less unsettling these safety interventions will feel when they are activated. Be sure to read any notifications following an intervention to better understand why the vehicle intervened.

### Reducing the amount of interventions and warnings

The amount of safety interventions and warnings you experience depends on the driving conditions and your driving style. Certain combinations of factors might result in responses you perceive to be unnecessary or too sensitive. In general, the most effective way to reduce the amount of warnings and interventions is to drive responsibly. Adapt your speed to the driving conditions and keep a safe distance to other vehicles. You can also adjust or turn off certain features in settings.

## Balancing the need for responses

When the vehicle suggests, guides or performs a driving action, it is considered a response. Most driver support features have some set of possible responses. For instance, automatic braking to prevent a collision with a vehicle that suddenly brakes in front of you is a response. Features that can provide you with warnings and safety interventions are designed to limit unnecessary responses.

Your vehicle's responses each have their own set of conditions. These conditions may be related to the traffic situation, the state of the vehicle and driver, and information collected using the vehicle's detection systems. For a response to occur, all of the required conditions must be met, and the vehicle must have a high certainty that the response is needed. As a situation develops, the vehicle continuously evaluates the conditions and the need for a response. If the response need or conditions are uncertain, then the vehicle won't respond.

If you are able to address a potentially hazardous situation yourself, it is better for you to respond than to depend on a response from the vehicle. The vehicle can delay or avoid providing a response in situations where you have the opportunity to address it using non-emergency maneuvering. This helps reduce unnecessary warnings and safety interventions. You can address most potential hazards that the vehicle identifies through minor adjustments well ahead of the need for emergency evasive maneuvering. In most instances, you will perceive these as routine actions that are part of normal driving.

 **Important**

### Always address driving hazards

The vehicle can and will compensate for some instances where you are unable to or fail to respond to a driving hazard, but it will not be able to handle every situation. There are situations where an effective response is beyond the capabilities of the vehicle, as well as situations where the vehicle does not respond because it expects the driver to address the potential hazard. When driving, you must stay alert and attentive so that you can respond to hazards just like you would driving a vehicle without driver support features.

## Conditions and limitations

### Warning

Never rely on the vehicle's safety interventions as a replacement for safe driving practices. Drive the vehicle with the same attention to safety as you would need to in a vehicle without these features.

Warnings and interventions cannot be guaranteed in any situation. The vehicle cannot handle all driving, traffic, weather and road conditions. Failure of the vehicle to detect or respond to a hazard can happen for reasons that you may not be able to identify or predict.

The vehicle's ability to respond to hazards varies depending on many factors. May of them fall into the following categories:

- Your vehicle's speed and movement.
- Size, shape, speed and movement of objects or road users around the vehicle.
- Environmental conditions.
- The condition of the driving infrastructure.
- The complexity of the traffic situation.

Notable examples:

- Sharp turns can cause detection to become less consistent. The vehicle might be unable to identify hazards that appear suddenly as a result of turning sharply.
- Low traction, such as when the road is wet or icy, can reduce the effectiveness of interventions.
- Conditions and limitations affecting obstacle detection can prevent the vehicle from accurately identifying potential hazards. Obstacle detection limitations are described in detail in the separate manual section about how the vehicle detects the surroundings and traffic.
- The vehicle won't perform automatic braking interventions if you are driving forwards at or below walking pace. This is to avoid unwanted braking interventions when you are maneuvering in tight spaces.



## Important

### General limitations

You have good reason to feel safe in a vehicle capable of intervening in dangerous situations, but it's important to still do your best to drive safely and responsibly. The vehicle's capabilities are always limited by technological factors and constraints, vehicle condition and the driving environment.

### Detection capabilities

The vehicle's ability to monitor its surroundings is used by features that can provide warnings and interventions. To better understand the limitations of such features, read the separate section about detection of traffic and surroundings. It provides an overview of how important components work, such as cameras and radar units, detailing both capabilities and limitations.

### Reaction times

In favorable conditions, the vehicle can perceive and react to certain hazards: in some cases, faster than a human driver can. However, this capability is not a guarantee of intervention, as the vehicle cannot detect all potential hazards that may require a response.

### Availability of responses

All of the vehicle's response types have their own set of conditions that define when they are available. This means that the available responses change continually as you drive. Certain conditions are strictly defined, such as an exact speed range, a setting being enabled or the driver wearing their seat belt. Other conditions have more imprecise thresholds that can depend on a combination of factors. This means that you cannot know for certain whether the vehicle will respond in a given situation, or how, but you can develop a sense of what responses are likely or not.

### Read everything about the features you use

It is recommended that you read all information about driver support features before using them. It's essential to understand both their capabilities and limitations.

### Wear your seat belt

Emergency braking interventions require the driver to be wearing their seat belt. Also make sure that any passengers also wear their seat belts. The risk of injury from hard braking rises significantly for unrestrained occupants.

### Driver responsibility

Features that provide interventions and warnings are supplements to safe driving practices. They do not reduce or replace the need for the driver to stay attentive and focused on driving safely. The section covering driver responsibility is essential reading to understand the limitations of safety interventions and warnings. If you find anything unclear or have further questions, do not hesitate to contact your Volvo retailer.

<sup>[1]</sup> Driver Alert

<sup>[2]</sup> Rear Cross Traffic Alert (RCTA)

<sup>[3]</sup> Rear Auto Brake (RAB)

## 10.3.1. Collision warnings and mitigation

Your vehicle has warning features designed to reduce the risk of a collision. If a collision cannot be avoided, early warning and response can help reduce its effects.

Collision warning features include:

- Forward collision warnings
- Warnings about vehicles cutting across your lane
- Rear collision warnings

### Note

#### Safety interventions

If a sufficiently urgent risk of collision is identified, the vehicle can intervene to avoid or mitigate the collision without any preceding collision warnings.

### Warning

Never rely on collision warnings or safety interventions by the vehicle as a replacement for safe driving practices. Drive the vehicle with the same attention to safety as you would need to in a vehicle without these features.

### Forward collision warnings

Forward collision warnings can occur if you are getting too close to a vehicle in front of you. The vehicle warns you if it identifies a collision risk that requires your immediate attention. This is done through notifications in the driver information area. If you are using the driving view, animations can be shown in combination with the notifications.

The situation and level of urgency affect how forward collision warnings are communicated. Warnings can be communicated visually in the driver information area, with sound and with brake pulses.

There are three levels of escalation for forward collision warnings.

1. **Increase distance to vehicle ahead**
2. **Brake!**
3. **Safety intervention. Forward collision risk.**

You can adjust how early you want to be warned. This is done in settings.

### Warnings about vehicles cutting across your lane

Your vehicle can warn you if you are about to be cut off, such as when a vehicle changes lanes just in front of you. Vehicles that swerve or move unpredictably in adjacent lanes can trigger these warnings as well. Your vehicle uses messages in the driver information area to warn you in these situations. If you are using the driving view, the messages can be shown in combination with animations.

### Rear collision warnings

The content of this manual represents the status of the user manual at the time of printing and may not be completely valid in future instances. For more information refer to the first page for the complete disclaimer note.

If your vehicle identifies a situation with a high risk of a rear collision, it can flash its rear lights to warn drivers behind you. Rear collision warnings appear automatically if you slow down suddenly<sup>[1]</sup>, such as during very hard braking. Warnings can also be provided if your vehicle detects a vehicle rapidly approaching from behind. In this case, you do not need to be slowing down for a warning to appear. Warnings can appear both when you're driving and when stopped, but only if your vehicle detects a sufficiently high risk of collision.

If your vehicle identifies a risk of a rear collision, it will indicate this in the driver information area if you are using the driving view.

You can turn rear collision warnings on or off in settings.

 **Note**

**Collision response**

If a collision cannot be avoided, the vehicle can respond in other ways to protect occupants and reduce the danger to surrounding traffic. Read more about these features in the safety section of this manual.

<sup>[1]</sup> The rate of deceleration must exceed a certain threshold.

---

## 10.3.1.1. Adjusting the sensitivity for forward collision warnings

You can adjust the sensitivity of forward collision warnings in settings, giving you earlier or later warnings.

 **Important**

**Changing driver support settings**

Make sure that you understand how changing your vehicle's settings affects its behavior. It is particularly important when it comes to features that affect the level of assistance the vehicle can provide.

- 1 Press the vehicle symbol  in the bottom bar and go to **Settings**.
- 2 Go to **Driving** → **Safety assistance** → **Forward collision warning**.
- 3 Adjust how early or late forward collision warnings appear.

---

## 10.3.1.2. Enabling and disabling rear collision warnings

Rear collision warnings can be enabled or disabled in settings.

 **Important**

### Changing driver support settings

Make sure that you understand how changing your vehicle's settings affects its behavior. It is particularly important when it comes to features that affect the level of assistance the vehicle can provide.

- 1 Press the vehicle symbol  in the bottom bar and go to **Settings**.
- 2 Go to **Driving** → **Safety assistance** → **Rear collision warning**.
- 3 Enable or disable rear collision warnings.

## 10.3.2. Interventions and warnings when reversing

Your vehicle has specialized features that can intervene and help prevent collisions when you are reversing at low speeds, such as when parking.

### Forms of detection

The vehicle has several ways to identify objects that are in or approaching your reversing path. If it detects an object, the vehicle can provide warnings or intervene by braking.

- Ultrasonic parking sensors** These sensors can identify certain obstacles immediately behind the vehicle when reversing at low speeds.
- Rear-facing radar** The vehicle's rear radar can detect traffic approaching your reversing path from the sides.
- Camera** Certain features may use camera detection to help identify obstacles when reversing.

 **Important**

These types of detection have limitations and cannot detect all obstacles in every situation. Be sure to read the separate manual sections about their conditions and limitations.

When you are reversing, some information from the detection systems can be communicated in the parking view.

## Warning and intervention features

The following features are designed to react when the vehicle identifies a risk of collision when reversing.

**Alerts about traffic crossing behind the vehicle**<sup>[1]</sup>

Your vehicle can provide visual alerts if it detects traffic about to cross your reversing path.

**Automatic braking when reversing**<sup>[2]</sup>

The vehicle can automatically brake if an obstacle is detected immediately behind the vehicle while reversing at low speeds.



Tip

### Temporary deactivation

These features can be temporarily turned off if their interventions are too frequent or distracting. For example, reversing in tall grass or maneuvering in very tight spaces can cause unwanted braking interventions.



Important

### Use responsibly

Warnings and interventions when reversing are supplements to safe driving practices. They do not reduce or replace the need for the driver to stay attentive and focused on driving safely.

### Pay attention to surroundings

The driver is always responsible for paying attention to the vehicle's surroundings and ensuring that it is safe to maneuver the vehicle.

<sup>[1]</sup> Rear Cross Traffic Alert (RCTA)

<sup>[2]</sup> Rear Auto Brake (RAB)

---

### 10.3.2.1. Alerts about traffic crossing behind the vehicle

When you're reversing at low speeds, the vehicle can alert you if it detects traffic about to pass behind you. The name of this feature is Rear Cross Traffic Alert<sup>[1]</sup>.

Alerts about traffic crossing behind the vehicle are only available when the vehicle is in reverse or neutral. Using the rear radar units, this feature can detect traffic approaching from the sides and provide a visual alert in the parking view. The visual alert can also be accompanied by a sound.

These alerts are primarily for larger vehicles in motion, such as cars and trucks. In favorable conditions, the vehicle may also be able to warn you of smaller moving objects.

**!** Important

### Driver responsibility

Alerts about traffic behind the vehicle are a supplement to safe driving practices. They do not reduce or replace the need for the driver to stay attentive and focused on driving safely.

**i** Note

### Automatic braking for crossing traffic

If the separate Rear Auto Brake function is enabled, the vehicle may also intervene by braking to prevent or mitigate an imminent collision with traffic detected behind you.

## Detection zones

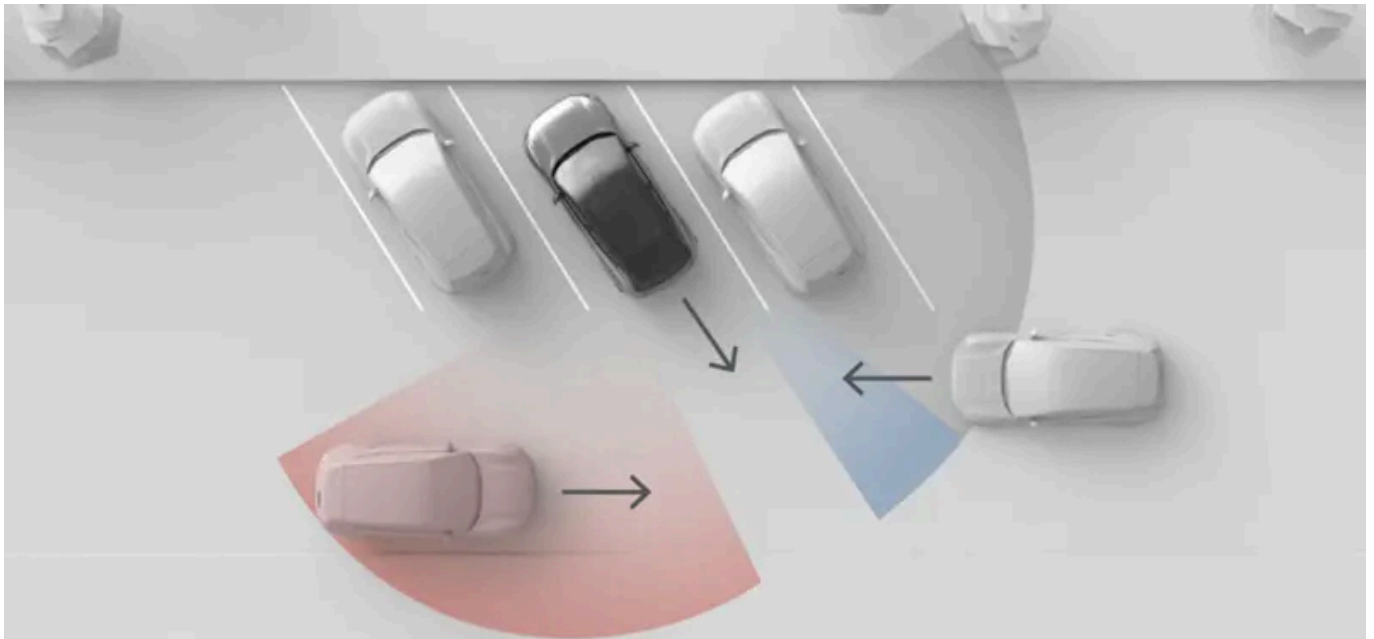

The situation shown in this image illustrates how surrounding objects, such as parked vehicles, can limit the radar's view. In a situation without obstacles, the effective detection zones are the same on both sides.

**i** Note

### Backing out of a parking space

When parked, your rear corner radar views might be obstructed to the sides, which affects detection of crossing traffic. This happens when you are parked with the back corners of your vehicle further forward in the space than adjacent vehicles or other objects. This effect is particularly noticeable in angled parking spaces. However, as you back out of a parking space, the radar units gradually increase their view, making detection possible. To minimize the risk of delayed or no detection when backing out of a parking space, go slowly.

## Conditions and limitations

- The alerts are only available when reversing at speeds below 15 km/h (9 mph).

The content of this manual represents the status of the user manual at the time of printing and may not be completely valid in future instances. For more information refer to the first page for the complete disclaimer note.

- If the vehicle deactivates the rear radar units, this feature is automatically disabled. This happens if a trailer is connected. Towbar-mounted accessories that are not connected electrically to the vehicle does not disable the rear radar units but can obstruct them.
- Detection of traffic behind the vehicle relies on detection by the rear radar. Be sure to read the separate section about the limitations of radar detection.

[1] RCTA

---

## 10.3.2.1.1. Disabling rear cross traffic alert

The rear cross traffic alerts can be temporarily disabled in settings.

### Important

By disabling rear cross traffic alert, you also disable your vehicle's ability to perform braking interventions if it detects a vehicle approaching your reversing path.

### Changing driver support settings

Make sure that you understand how changing your vehicle's settings affects its behavior. It is particularly important when it comes to features that affect the level of assistance the vehicle can provide.

- 1 In the parking view, press the RCTA button.



RCTA

- Alerts about traffic crossing behind your vehicle are temporarily disabled.

### Note

Disabling rear cross traffic alerts is only temporary for your current drive. The next time you start your vehicle, the function will be re-enabled by default.

---

## 10.3.2.2. Disabling automatic braking when reversing

The rear auto brake can be temporarily disabled in the parking view.

By disabling the rear auto brake, your vehicle will not brake for obstacles detected immediately behind it. However, if rear cross traffic alerts are enabled, it can still intervene by braking if it detects traffic approaching your reversing path.

 **Important**

### Changing driver support settings

Make sure that you understand how changing your vehicle's settings affects its behavior. It is particularly important when it comes to features that affect the level of assistance the vehicle can provide.

- 1 In the parking view, press the RAB button.



RAB

- The rear auto brake is temporarily disabled.

---

## 10.3.3. Lane keeping aid

The lane keeping aid helps prevent accidental high-speed lane departures by providing warnings and steering interventions.

When lane keeping aid is enabled, the vehicle can alert you if you are about to drift out of your lane. It can also perform steering interventions. The lane keeping aid relies on the vehicle's forward-facing camera to identify road markings and your position in the lane.

 **Warning**

Lane keeping aid warnings and interventions are supplements to safe driving practices. They do not reduce or replace the need for the driver to stay attentive and focused on driving safely. Drive the vehicle with the same attention to safety as you would need to in a vehicle without the ability to intervene.

### Main conditions for using the lane keeping aid

For lane keeping aid to work, several conditions need to be met. The following are the most essential:

- Your speed must be in the range of 65-180 km/h (40-110 mph).
- The lane markings must be clearly visible for the vehicle's camera to see.
- The lane must be wide enough. A very narrow lane does not provide enough space between the vehicle and the road markings.
- You must keep your hands on the steering wheel and actively steer the vehicle.



 **Important**

## Steering actively

Never let go of the steering wheel when driving. Do not dismiss the vehicle's requests for you to steer actively and keep your attention on the road.

## Lane keeping aid intervention types

If you are about to cross your lane's road markings, your vehicle can intervene in either or both of the following ways:

**Steering intervention** The vehicle tries to steer back into the lane.

**Lane departure warning** The vehicle alerts you using steering wheel vibrations.

You can enable or disable both the steering interventions and the lane departure warnings in settings.

 **Note**

### Signaling a turn or lane change

As long as you use the turn signals when changing lanes, the vehicle assumes you are making an intentional maneuver.

### Safety interventions are always enabled

Some situations can cause a steering intervention to prevent a dangerous lane departure even if lane keeping aid is turned off in settings.

## Display symbols and communication

Lane keeping aid warnings and interventions are communicated in the driver information area.

When the driver information area shows the driving view, warnings and interventions are shown as road marking animations.



Interventions by the lane keeping aid are indicated with a solid line in red.



Warnings are indicated with a solid line in amber.

When the display shows the calm view, symbols are used instead.



This symbol appears if you are about to cross your lane's road markings on the left-hand side.



This symbol appears if you are about to cross your lane's road markings on the right-hand side.

## Lane keeping aid inactive



This symbol indicates that lane keeping aid is disabled in settings.



This symbol appears when there is a lane keeping aid malfunction. This means that lane keeping aid and safety interventions to prevent lane departures are disabled due to a system malfunction.

## Conditions and limitations

For lane keeping aid to work, road markings must be present and visible. The vehicle identifies them using a forward-facing camera. This form of detection requires the camera view to be unobstructed and the conditions for visual detection to be present. Read the separate section of this manual about conditions and limitations of your vehicle's cameras to understand how features relying on camera detection are affected.

The appearance, condition and layout of road markings can affect their detection in the following ways:

- Lane splits and merges can cause temporary misidentification of the lane.
- Non-standard or unusual road marking layouts might not be identified correctly by the vehicle. For example, road work or traffic diversions can result in conflicting or multiple sets of road markings.
- The vehicle may be unable to detect deteriorated road markings: for example, if they are worn, misshapen or discolored.
- Other edges or lines can be misidentified as road markings, such as curbs, road surface repair edges, barriers or well-defined shadows.
- Road markings must be sufficiently illuminated to be detected. In low-light conditions, they need to be illuminated by the vehicle or street lights.

### 10.3.3.1. Disabling lane keeping aid

You can enable or temporarily disable lane keeping aid in settings.

When lane keeping aid is enabled, the vehicle can alert you or intervene by steering if you are about to drift out of your lane.

You can temporarily disable lane keeping aid if it interferes too much with your driving. This can be useful if the road markings are partially obscured or faded, which can cause unwanted warnings.

#### Important

#### Changing driver support settings

Make sure that you understand how changing your vehicle's settings affects its behavior. It is particularly important when it comes to features that affect the level of assistance the vehicle can provide.

- 1 Press the vehicle symbol  in the bottom bar and go to **Settings**.
- 2 Go to **Driving** → **Safety assistance** → **Lane keeping aid**.

The content of this manual represents the status of the user manual at the time of printing and may not be completely valid in future instances. For more information refer to the first page for the complete disclaimer note.

### 3 Enable or disable lane keeping aid.

#### Note

##### Disabled

A symbol is shown in the driver information area when lane keeping aid is disabled.



#### Tip

If you want to disable alerts about accidental lane departures, you can do this in settings as well.

## 10.3.3.2. Disabling lane departure warnings

You can disable lane departure warnings in settings.

When lane departure warnings are enabled, the vehicle can alert you with steering wheel vibrations if you are about to drift out of your lane.

You can temporarily disable lane departure warnings if they interfere too much with your driving. This can be useful if the road markings are partially obscured or faded, which can cause unwanted warnings.

#### Important

##### Changing driver support settings

Make sure that you understand how changing your vehicle's settings affects its behavior. It is particularly important when it comes to features that affect the level of assistance the vehicle can provide.

- 1 Press the vehicle symbol  in the bottom bar and go to **Settings**.
- 2 Go to **Driving** → **Safety assistance** → **Lane departure warning**.
- 3 Disable lane departure warnings,

## 10.3.4. Blind spot information

The blind spot information feature helps increase your awareness of vehicles in or approaching your blind spots. A light appears in the door mirror when a vehicle is detected.

Blind spot alerts can increase your awareness of vehicles to the side of your vehicle, which can help you avoid making dangerous lane changes. The alerts primarily appear as a light in the door mirror on the side of detection. They rely on your vehicle's rear radar units for detection of vehicles in adjacent lanes.

Traffic situations in which blind spot alerts appear include:

- When you are being overtaken by another vehicle.
  - In some cases, they can appear before the passing vehicle reaches your blind spot. This happens if a vehicle is approaching quickly from behind in an adjacent lane.
- When you are overtaking another vehicle.

Regardless of the situation, the alert remains as long as the other vehicle is detected to your side.



Tip

### Blind spot alerts and door opening alerts

Door opening alerts are indicated in the same way as blind spot alerts. These two features also rely on the same rear radar units to detect traffic. However, the features are enabled or disabled independently of each other.

## Alerts in the door mirrors



When a vehicle is detected in or approaching your blind spot, a light appears in the door mirror.

## Detection areas

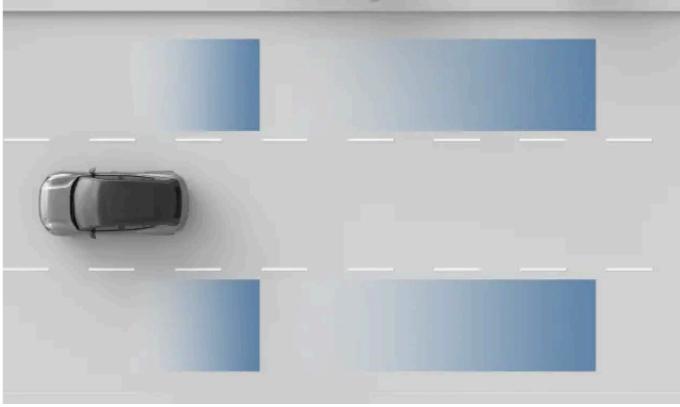

Radar detection areas.

### ! Important

The detection areas may not perfectly cover your own blind spots. Be sure to adjust your driving posture to allow for a good overview of surrounding traffic.

## Conditions and limitations

- Blind spot information is active at speeds above 15 km/h (10 mph). It is not available when reversing.
- When passing other vehicles, the speed difference between your vehicle and the other vehicles must be below 15 km/h (9 mph) for the alerts to appear.
- Blind spot information relies on detection by the rear radar units. Be sure to read the separate section of this manual about the limitations of radar detection.
- If the rear radar units are obstructed, such as by an attached trailer or mounted bike rack, blind spot alerts are automatically disabled.

### ! Important

#### Driver responsibility

Alerts about vehicles in the blind spots are a supplement to safe driving practices. They do not reduce or replace the need for the driver to stay attentive and focused on driving safely.

The lack of a blind spot indication is not a confirmation that it is safe to change lanes. It is one of several pieces of information that inform your assessment of whether it is safe to proceed.

## 10.3.4.1. Enabling blind spot alerts

You can enable or disable blind spot alerts in settings.

When blind spot alerts are enabled, your vehicle can alert you of vehicles in or approaching your blind spots.

 **Important**

## Changing driver support settings

Make sure that you understand how changing your vehicle's settings affects its behavior. It is particularly important when it comes to features that affect the level of assistance the vehicle can provide.

- 1 Press the vehicle symbol  in the bottom bar and go to **Settings**.
- 2 Go to **Driving** → **Safety assistance** → **Blind spot information**.
- 3 Enable or disable blind spot alerts.

---

## 10.3.5. Door opening alerts

Door opening alerts are designed to make exiting your vehicle safer. They can warn you of traffic approaching from behind so that you don't open a door in its path.

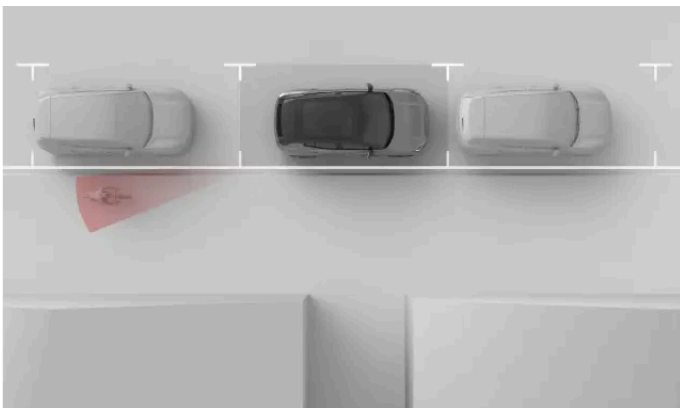

Door opening alerts are designed to warn you of passing traffic so that you don't open a door in its path. These alerts can be provided when the vehicle is stationary or moving very slowly<sup>[1]</sup>.



When the vehicle detects traffic that is about to pass close to the vehicle's sides, a light appears in the door mirror along with a notification in the display. If you begin to open the door on the side of the detected traffic, the alert intensifies. An audible alert can occur along with the visual alerts, depending on how urgent the warning is.

Door opening alerts can be turned on or off in settings.



Tip

### Door opening alerts and blind spot information

Door opening alerts are indicated in a similar way to alerts about vehicles in your blind spot. These two features also rely on the same rear radar units to detect traffic. However, the features are enabled or disabled independently, as they are used for different scenarios.

## Limitations

The vehicle uses its rear radar system to detect approaching traffic. Be sure to read about radar and detection conditions and limitations in their separate section of the manual.



Important

Door opening alerts are supplements to safe user practices. The driver and passengers are fully responsible for making sure that the vehicle doors can be safely opened.

<sup>[1]</sup> Below 3.6 km/h (2.2 mph)

---

## 10.3.5.1. Enabling door opening alerts

Door opening alerts can warn you of traffic approaching from behind so that you don't open a door in its path. You can enable or disable these alerts in settings.

- 1 Press the vehicle symbol  in the bottom bar and go to **Settings**.
- 2 Go to **Driving** → **Safety assistance** → **Door opening alert**.
- 3 Enable or disable door opening alerts.

---

## 10.3.6. Driver alert

The vehicle continuously observes your behavior while driving and can alert you if you seem unfocused. A lack of focus can be caused by distractions or being tired.

The vehicle analyzes your driving behavior and can detect signs of fatigue. If the vehicle identifies signs of reduced driver focus, it will notify you in the driver information area and with a sound.



The vehicle uses sensor tracking of your face and eye movements to assess your focus when driving. This allows the vehicle to determine where you are directing your attention and to detect signs of tiredness.

Driver alert notifications can be turned off in settings. This does not disable the systems that monitor your driving, as they are used by other features.

 **Warning**

### The importance of a well-rested driver

Take any notifications about signs of driver tiredness seriously, as a tired driver is often unaware of their condition. If you feel tired or get an alert about it from the vehicle, stop as soon as possible in a suitable location for a rest. Always plan for regular breaks and start all trips with a well-rested driver.

Driving while tired is comparable to driving under the influence of alcohol.

## Conditions and limitations

- Attention tracking requires an unobscured view of the driver's face.
  - Improperly stowed items can obscure the view of the driver, as can dust and dirt on the sensor. Keep the driver's space clean and clutter-free.
  - Wearing certain clothing and accessories can obstruct parts of the driver's face that need to be visible for attention tracking, such as the eyes.

 **Important**

### Driver responsibility

Alerts about poor focus when driving are a supplement to safe driving practices. The driver is fully responsible for making sure they are able to stay alert and maintain focus when driving.

## 10.3.6.1. Disabling driver alerts

You can disable or enable driver alert notifications in settings.

Disabling driver alert notifications is only temporary, as this setting automatically resets to enabled between drives.



 **Warning**

### The importance of a well-rested driver

Take any notifications about signs of driver tiredness seriously, as a tired driver is often unaware of their condition. If you feel tired or get an alert about it from the vehicle, stop as soon as possible in a suitable location for a rest. Always plan for regular breaks and start all trips with a well-rested driver.

Driving while tired is comparable to driving under the influence of alcohol.

 **Note**

### Driver responsibility

Alerts about poor focus when driving are a supplement to safe driving practices. They do not reduce the driver's responsibility to continuously assess whether they are too tired or unfocused to drive safely.

- 1 Press the vehicle symbol  in the bottom bar and go to **Settings**.
- 2 Go to **Driving** → **Safety assistance** → **Driver alert**.
- 3 Turn driver alert notifications on or off.

## 10.4. Assisted driving

Assisted driving features use the vehicle's ability to monitor its surroundings to make driving safer and less demanding.

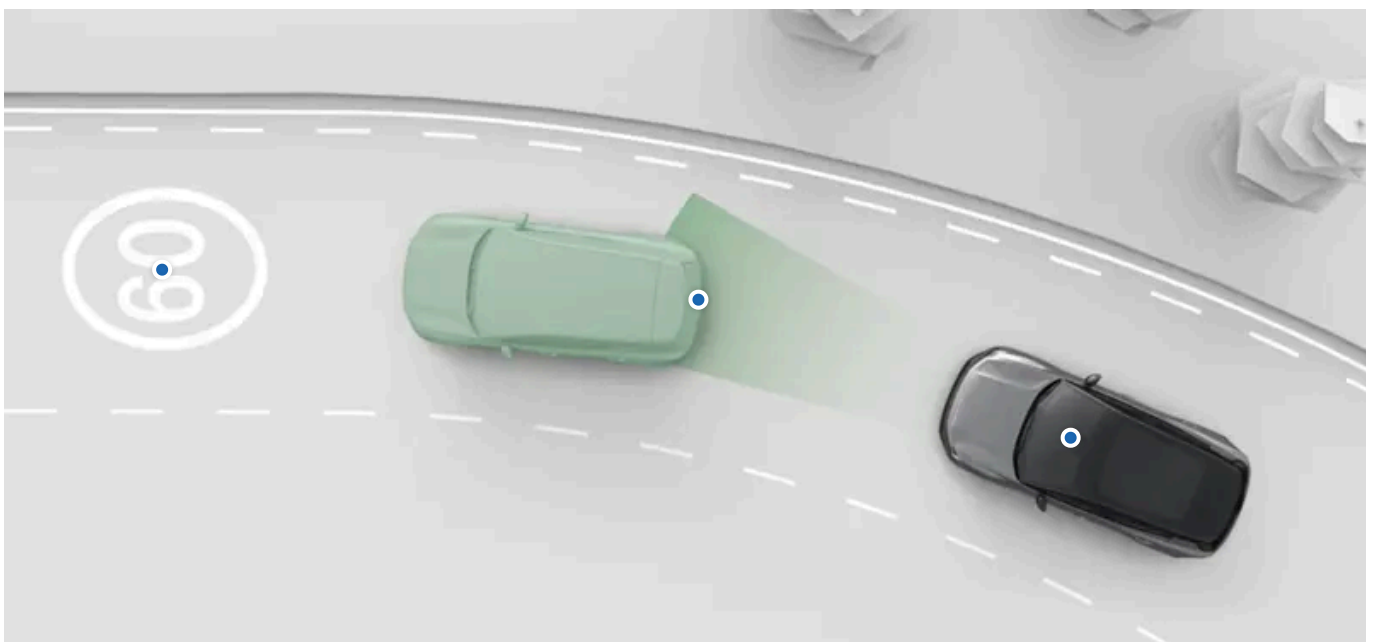

There are several forms and levels of assistance. They can actively assist you with a number of driving tasks and provide informational support for better driver decision-making.

You can enable, disable or customize many of your vehicle's assisted driving features in settings.

|   |   |
|---|---|
| <b>Pilot Assist</b>                     | This feature can assist you in several driving tasks, such as steering, managing speed and changing lanes. Pilot Assist can be customized in settings.  |
| <b>Road signs and speeding response</b> | Several features can assist you with keeping track of the speed limit and preventing unintentional speeding. They include road sign information, which makes you aware of the speed limit, and different responses from the vehicle designed to prevent you from exceeding the speed limit. These features can be customized in settings. |



Tip

### Safety interventions and warnings

Many of the driver support features are designed to improve both convenience and safety. Features that primarily provide safety interventions and warnings have their own, separate section in this manual.

### Assisted parking

There is a separate section of this manual covering assisted parking features.



Important

### Required knowledge and driver responsibility

Assisted driving features are designed to make driving safer and less demanding, but they do not reduce the driver's responsibility to operate the vehicle as safely as possible. Be sure to read all related information about a feature before using it. The section covering driver responsibility is essential reading to understand the capabilities and limitations of your vehicle's assisted driving features.

If you find anything unclear or have further questions, do not hesitate to contact your Volvo retailer.

### Detection capabilities

The vehicle's ability to monitor its surroundings is used by assisted driving features. To better understand the limitations of such features, read the separate section about detection of traffic and surroundings. It provides an overview of how important components work, such as cameras and radar units, by detailing both capabilities and limitations.

---

## 10.4.1. Road signs and speeding response

Several features can assist you with keeping track of the speed limit and preventing unintentional speeding.

To encourage maintaining a legal speed, your vehicle is designed to make you aware of the current speed limit by showing it in the driver information area. It can also respond with warnings if you exceed the speed limit.

|                              |   |
|------------------------------|---|
| <b>Road sign information</b> | The vehicle can detect and display information from road signs, such as the speed limit.                      |
| <b>Speed limiter</b>         | When enabled, this feature reduces the response from the accelerator pedal if you exceed your selected limit. |
| <b>Speed limit warning</b>   | This feature can alert you visually and with a sound when you exceed the speed limit.                         |

**The content of this manual represents the status of the user manual at the time of printing and may not be completely valid in future instances. For more information refer to the first page for the complete disclaimer note.**

 **Important**

Speed-related information and warning features are supplements to safe driving practices. They do not reduce or replace the need for the driver to stay attentive and focused on driving safely. It is the driver's responsibility to observe and maintain a legal and safe speed.

## 10.4.1.1. Speed limiter

The speed limiter can help you avoid unintentional speeding. When the speed limiter is active, the vehicle's acceleration response is limited after you exceed the selected speed limit.

When active, the speed limiter can gradually reduce the response from the accelerator pedal and provide light braking when you exceed your selected limit. These two responses help nudge you down to the selected max speed. You can always override the speed limiter by pressing the accelerator pedal down further.

To use the speed limiter, it needs to be enabled in settings. You can then activate it with the right-hand steering wheel stalk during driving.

When the speed limiter is active, its symbol appears below the gear indication in the driver information area. You can adjust the limit with the steering wheel buttons.



 **Important**

### Driver responsibility

The speed limiter feature is a supplement to safe driving practices. It does not reduce or replace the need for the driver to stay attentive and focused on driving safely. It is the driver's responsibility to observe and maintain a legal and safe speed.

### 10.4.1.1.1. Activating the speed limiter

You can activate or deactivate the speed limiter by moving the right-hand steering wheel stalk downwards while driving.

When driving, a grey speed limiter symbol in the driver information area indicates that the function is available but not yet activated.

The speed limiter must be enabled in settings before it can be activated.<sup>[1]</sup>

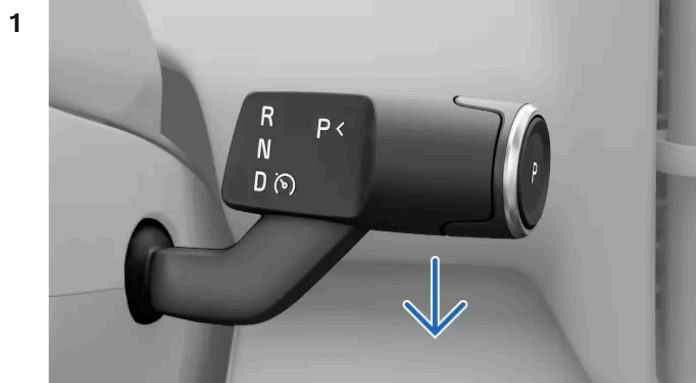

When appropriate, pull the right-hand steering wheel stalk all the way down.

➤ Your action is confirmed in the driver information area.



<sup>[1]</sup> Enabling either of the speed limiter or Pilot Assist features automatically disables the other feature.

---

## 10.4.1.1.2. Deactivating the speed limiter

When you want to stop driving with the speed limiter, you can deactivate it manually.

Deactivating and activating the speed limiter is done in the same way. You simply pull the right-hand steering wheel stalk downwards.

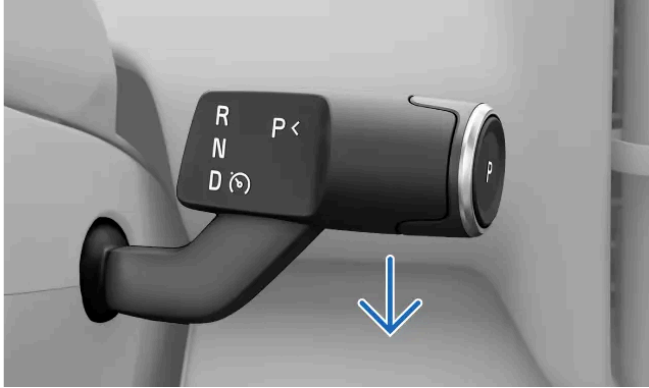

Pull the right-hand steering wheel stalk all the way down.

➤ Deactivation is confirmed in the driver information area.

---

## 10.4.1.1.3. Adjusting the speed limiter value

You can adjust the speed limiter value using the steering wheel buttons.

When the speed limiter is active, you can adjust the set limit manually.

Adjustment actions:

**Pressing once** Adjusts the limit by 5 km/h or 5 mph<sup>[1]</sup>.

**Press and hold** Continuously adjust your set limit by 1 km/h or 1 mph by pressing and holding the button.

1 Adjust the set speed value with the  and  buttons on the steering wheel.

➤ Your new speed limiter value is shown next to the speedometer.

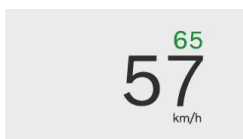

<sup>[1]</sup> The limit will default to speed increments that are divisible by five, such as 25, 30 and 35.

---

## 10.4.1.1.4. Enabling the speed limiter in settings

You can enable or disable the speed limiter in settings. When enabled, it can help you to avoid unintentional speeding.

- 1 Press the vehicle symbol  in the bottom bar and go to **Settings**.
- 2 Go to **Driving** → **Driver support**.
- 3 Select **Speed limiter** as your default driver support function.

---

## 10.4.1.2. Speed limit warnings

Speed limit warnings can be provided to help prevent speeding.

Speed limit warnings are provided when you exceed the speed limit.

These warnings are enabled and disabled in your vehicle's settings. When enabled, you can choose between visual warnings in the driver information area or visual warnings with the addition of a sound. The warnings can also be offset in relation to the speed limit.

### Conditions and limitations

Speed limit warnings use road sign information to keep track of the speed limit. If information about the speed limit is unavailable for some reason, no warning can be provided.

 **Important**

#### Driver responsibility

Speed limit warnings are supplements to safe driving practices. They do not reduce or replace the need for the driver to stay attentive and focused on driving safely. It is the driver's responsibility to observe and maintain a legal and safe speed.

---

### 10.4.1.2.1. Adjusting speed limit warnings

Speed limit warnings can be enabled, disabled and customized in settings.

The following options are available:

- Off** Speed limit warnings are disabled.
- Visual** The speed limit symbol in the driver information area flashes if you exceed the speed limit.
- Sound and visual** An audible alert accompanies the visual alert if you exceed the speed limit.
- Speed limit offset** Allows you to set an offset for the warnings so that they occur below or above the speed limit.

- 1** Press the vehicle symbol  in the bottom bar and go to **Settings**.
  - 2** Go to **Driving** → **Safety assistance** → **Sound for new speed limit**.
  - 3** Choose one of the available speed limit warning options.
- After enabling speed limit warnings, you can also choose an offset for the speed limit.

---

### 10.4.1.3. Road sign information

The vehicle can identify and display road signs as you pass them. This allows you to keep track of the speed limit. The road sign information feature combines the direct detection of signs with information from map data.

The signs shown in the driver information area come from two different sources – either from real-world signs identified by cameras or from map data. The vehicle automatically prioritizes which source to use depending on the situation.

The vehicle can only show signs that are part of the vehicle's sign library.

## How signs are shown

Detected road signs appear next to the speedometer in the driver information area. Different signs are shown in different areas.



Road sign symbols can also appear on the other side of the speedometer, depending on the current driver information area display mode.

- ① Warning signs and upcoming speed limit signs
- ② Current speed limit sign
- ③ Traffic information signs.

The vehicle can simultaneously display several sign types. This can include the current speed limit, an upcoming speed limit or a warning sign, or an additional traffic information sign.

## Displayed road signs

This list contains examples of road sign types that can be shown in the vehicle.



Speed limit



No entry

### *i* Note

#### Symbol availability

Road signs available to display in your vehicle can change over time and vary between regions. The selection presented in this manual may not include every sign that can appear in your vehicle's display.

#### Symbol design

Road sign styles vary between regions. The symbol style displayed by the vehicle will not exactly match the symbol style on signs you encounter. If you have any issues interpreting a displayed sign despite the information provided in this manual, contact Volvo support.

## Road sign display times

The sign display time typically depends on the type of sign and whether you pass additional signs. Road signs can be shown in the following ways:

**The content of this manual represents the status of the user manual at the time of printing and may not be completely valid in future instances. For more information refer to the first page for the complete disclaimer note.**



- Briefly as one-time alerts after passing a sign.
- Until the sign no longer applies.
- Until you pass another sign with higher display priority.

 **Note**

### Lingering signs

The vehicle might fail to identify a sign indicating the end of a traffic limitation. If this happens, a symbol for the previous limitation can linger in the driver information area. It will eventually be replaced or canceled. In the meantime, drive according to the applicable rules of the road.

## Conditions and limitations

 **Important**

### Driver responsibility and road signs

Road sign information is designed to help you manage information while driving. It is a supplement to safe driving practices. The driver is fully responsible for remaining attentive, keeping track of road signs and following local regulations. Do not prioritize the vehicle's road sign detection over your own observations if they conflict.

### Why all signs are not shown

The vehicle cannot detect and show every sign that is relevant to the driver.

- The system does not support all signs.
- Signs may go undetected in certain conditions and traffic situations.

Conditions that affect road sign detection or identification:

- The vehicle's forward-facing camera must be clean and free of obstructions.
- The road sign must be clearly visible and properly illuminated.
- The road sign must be within a certain distance of the vehicle and within the camera's field of view.
- The vehicle may not be able to identify misaligned road signs, such as signs placed too high or at an angle.
- The vehicle may not be able to identify damaged or worn road signs.

Conditions that affect sign information from map data:

- An internet connection is required to download map data that contains information about road signs.
- The coverage of road sign information from map data varies between regions.

 **Note**

For consistent and up-to-date road sign information in your vehicle, be sure to accept Google's Terms of service. Contact an authorized Volvo workshop if you experience any issues with the road sign information feature.

## 10.4.2. Pilot Assist

Pilot Assist combines several support capabilities to make driving safer, more convenient and less demanding. It can assist you with speed management and steering guidance in a wide variety of situations.

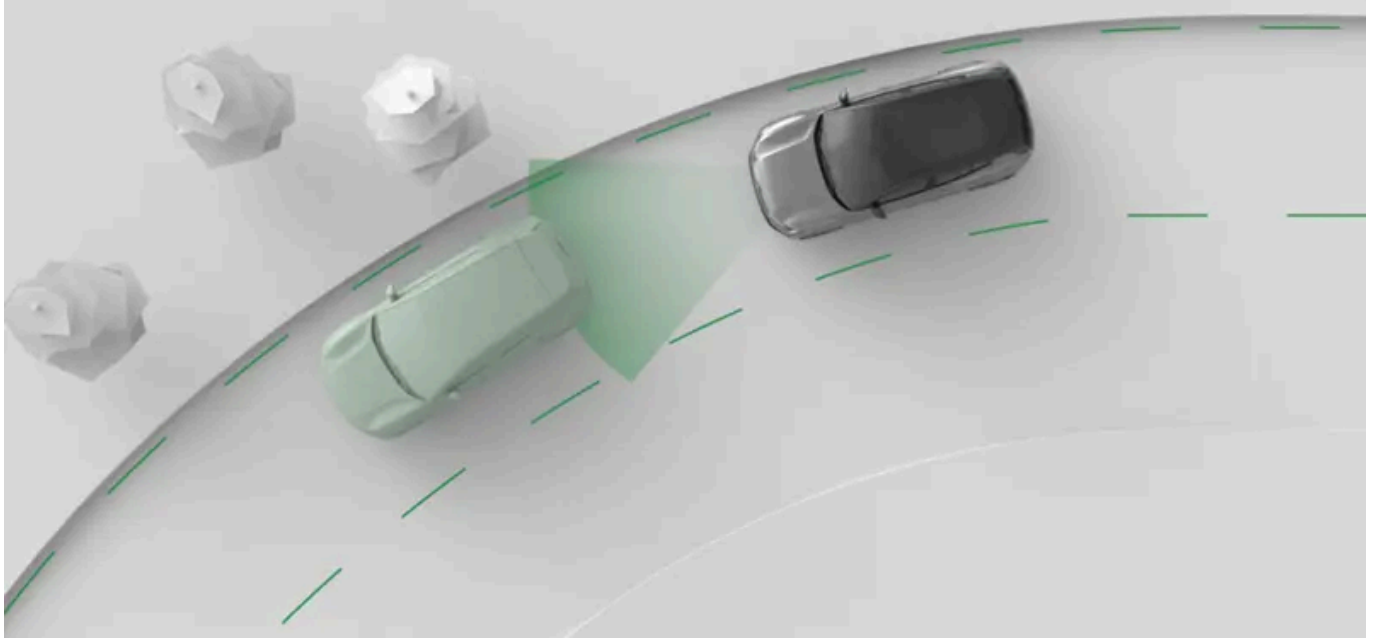

Pilot Assist actively guides your driving in a number of ways. When driving with Pilot Assist, you select the target speed. The vehicle then manages acceleration and braking to meet that target while also adapting to surrounding traffic.

It's also capable of steering assistance. When enabled, steering assistance helps with road positioning by guiding your steering wheel movement.

### Important

#### Before using Pilot Assist

- Take the time to read everything the manual has to say about Pilot Assist before using it.
- This support feature depends on information from radar and camera detection systems. Understanding their capabilities and limitations is necessary for safe use.

#### The driver is in control

When using Pilot Assist, you are still in control of the vehicle. It's your responsibility to continuously assess Pilot Assist's performance. As long as you judge its input to be correct, you can let it guide your driving.

### Tip

#### Customize Pilot Assist

Some of Pilot Assist's capabilities can be customized in settings. This allows you to set it up for the level of support you want.

## Managing speed and distance to vehicles ahead

When you activate Pilot Assist, a set speed value appears next to the speedometer. This represents the target speed that Pilot Assist tries to maintain. You can adjust the set speed with the steering wheel buttons.

Instead of manually adjusting the set speed, you also have the option to use the current speed limit as your target speed. The set speed then automatically updates when the speed limit changes. This can be enabled in Pilot Assist's settings.

If your vehicle detects a vehicle ahead that's either slower than you or a bit too close, Pilot Assist will slow down to maintain a certain distance to the vehicle in front. Once the road ahead becomes clear again, your vehicle returns to the target speed. You can adjust the general distance to vehicles ahead in Pilot Assist's settings.

## Steering assistance

The availability of active steering assistance depends on the conditions you are experiencing. For example, if you encounter a stretch of road with worn-out markings, the vehicle may temporarily turn steering assistance off and tell you to increase your level of control. As soon as the necessary conditions are met again, steering assistance reactivates.

Steering assistance can be enabled in Pilot Assist's settings.

## Pilot Assist features and settings

There are a number of Pilot Assist capabilities and settings to read about in this manual.

|                                       |   |
|---------------------------------------|---|
| <b>Steering assist</b>                | When driving with steering assistance, your steering is actively guided. This can help you maintain correct lane positioning. |
| <b>Lane change assist</b>             | Guides lane change maneuvers initiated by the driver.   |
| <b>Adapt to speed limit</b>           | Adapts the set target speed to follow the speed limit.  |
| <b>Time interval to vehicle ahead</b> | Adjust the target time interval to the vehicle ahead.   |

## Status and availability

To use Pilot Assist, it needs to be enabled in settings. It is then available for activation when you are driving. Availability is indicated in the driver information area and depends on the current driving conditions. You can always see the current level of support you're getting from Pilot Assist in the driver information area.



### Note

#### Pause

In some situations, Pilot Assist can be temporarily paused. This can happen when a driver decision is needed to resume driving with Pilot Assist, such as after coming to a stop. When Pilot Assist is paused, a message with instructions for resuming is typically shown in the display.





## 10.4.2.1. Pilot Assist communication and status

Learn how Pilot Assist's status and actions are communicated in the vehicle.

The driver information area of the display shows the status of Pilot Assist using graphics and symbols. Important information can also appear as notifications.

Some situations, such as a temporary loss of steering assistance, may cause steering wheel vibrations along with notifications in the display.

The primary status is shown below the gear indicator. It tells you whether Pilot Assist is active or not.

-  Pilot Assist is off but available to activate if all conditions are met.
-  Pilot Assist is active without providing steering assistance.
-  Pilot Assist is active and providing steering assistance.
-  Lane change assist communication. The color and direction of the arrows are different depending on the situation.
-  Steering assistance is temporarily unavailable.

The target speed appears in green next to the speedometer.

## Communication in surround display mode



- ① An assisted lane change is possible
- ② Pilot Assist is adapting your speed to a vehicle ahead
- ③ Steering assistance is active and providing support

When the driver information area is in surround mode, Pilot Assist's status and actions are shown as animations. The animations can show what level of support Pilot Assist is currently providing, depending on your Pilot Assist settings. This may include speed-keeping, distance-keeping, adjusting the speed to other vehicles ahead, available assisted lane changes and steering assistance.

 **Important**

## Using surround mode

Surround mode cannot perfectly depict what is really happening on the road around you, so do not rely on it when you are driving.

## Communication in calm display mode

When the driver information area of the display is in calm mode, Pilot Assist's status is communicated using symbols. They can show what level of support Pilot Assist is currently providing, depending on your Pilot Assist settings.



Pilot Assist is off but available to activate if all conditions are met.



Pilot Assist is active without providing steering assistance.



Pilot Assist is active and providing steering assistance.



Pilot Assist is adapting the vehicle's speed and distance to a vehicle ahead.



An assisted lane change is available. The arrow indicates the direction of the available lane change.



A lane change is ongoing. The arrow indicates the direction of the initiated lane change.



Lane change assist is unavailable and any ongoing lane change is canceled. This can happen if there is a fault affecting critical systems, such as steering assistance. Be attentive to any messages that may follow.

## Notifications and messages

When using Pilot Assist, notifications can appear in the driver information area. They may contain important information about the status of Pilot Assist features, as well as instructions for you to follow, such as not letting go of the steering wheel.

### 10.4.2.2. Activating Pilot Assist

You activate Pilot Assist by moving the right-hand steering wheel stalk downwards while driving. It's important to assess whether the current driving conditions allow you to use Pilot Assist safely.

When driving, a grey Pilot Assist symbol in the driver information area indicates that the function is available but not yet activated.



Pilot Assist is only available for activation if it is enabled in settings.<sup>[1]</sup>

**!** Important

### Before using Pilot Assist

Take the time to read everything about Pilot Assist in this manual before using it for the first time. Understanding its capabilities and limitations is important for safe use.

### Assess the situation

Make sure the traffic situation and conditions are suitable for activation. Wait until you complete any ongoing maneuvers, such as a lane change, before activating Pilot Assist.

### Activating Pilot Assist when driving

1

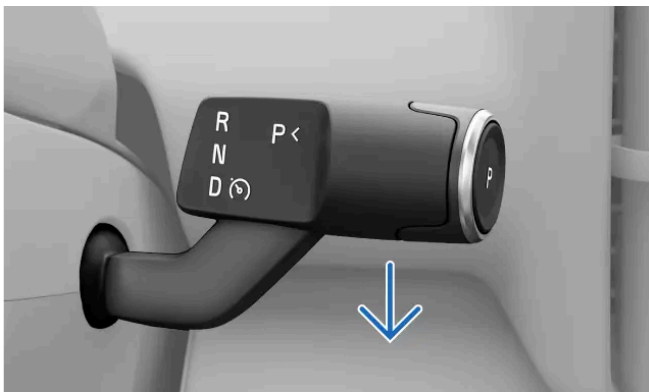

When appropriate, pull the right-hand steering wheel stalk all the way down.

➤ Activation is confirmed in the driver information area.



The first time you activate Pilot Assist during a drive, your speed at the time of activation becomes the set speed. If Pilot Assist is set to adapt to the speed limit, it will use the current speed limit as its target speed.

**i** Tip

### Resume

If you recently used Pilot Assist and you want to activate it again you can use the resume button  on your steering wheel. In this case, your previously used set speed is used instead of your current driving speed.

### Pilot Assist symbols

When Pilot Assist is active, its level of support is shown via symbols and graphics in the driver information area.

<sup>[1]</sup> Enabling either of the Pilot Assist or speed limiter features automatically disables the other feature.

---

## 10.4.2.3. Deactivating Pilot Assist

When you want to stop driving with Pilot Assist, you can deactivate it manually. There are also situations in which Pilot Assist deactivates automatically.

Deactivating and activating Pilot Assist is done in the same way. You simply pull the right-hand steering wheel stalk downwards. You can also deactivate Pilot Assist by braking.

When you deactivate Pilot Assist, all of its assistance is turned off. This includes speed- and distance-keeping, as well as steering assistance.

### Deactivating Pilot Assist using the stalk

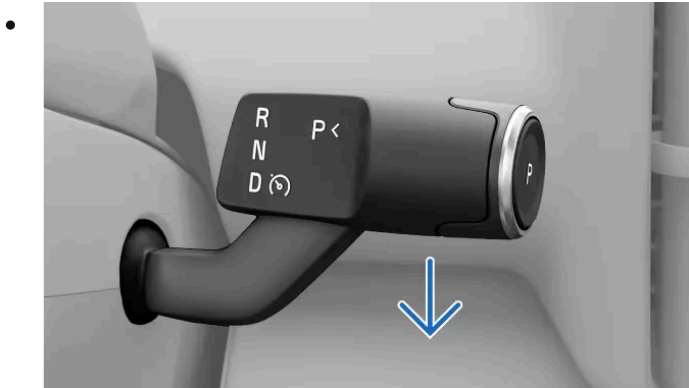

Pull the right-hand steering wheel stalk all the way down.

- Deactivation is confirmed in the driver information area.

### Deactivating by braking

- Press down on the brake pedal.
- Deactivation is confirmed in the driver information area.

**Note**

### Automatic deactivation

Pilot Assist has several limitations and only works if all the necessary conditions are met. If the driving conditions change during your drive, Pilot Assist can deactivate automatically.

Examples of scenarios where Pilot Assist may automatically deactivate include instances where:

- You are not driving actively. You must stay attentive and keep both of your hands on the steering wheel, even if steering assistance is activated.
- You open a door or unbuckle your seat belt.
- You change gears. Pilot Assist can only support you when D is selected.
- You manually speed up and exceed 150 km/h (90 mph).
- Camera or radar conditions for Pilot Assist are not met.

## 10.4.2.4. Adjusting the target speed for Pilot Assist

Pilot Assist can support you in keeping a set target speed. You can adjust the target speed with the steering wheel control buttons.

When you are driving with Pilot Assist active, you can select a target speed. The vehicle then manages acceleration and braking to meet that target while also adapting to surrounding traffic.

You can adjust your set speed target by pressing the set speed adjustment buttons on your steering wheel's left-hand control area.

Adjustment actions:

**Pressing once** Adjusts the target speed by 5 km/h or 5 mph<sup>[1]</sup>.

**Press and hold** Continuously adjust your set target speed by 1 km/h or 1 mph by pressing and holding the button.

1 Adjust the set speed value with the  and  buttons on the steering wheel.

> Your new set target speed is shown next to the speedometer.

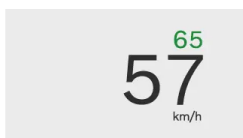

<sup>[1]</sup> The target speed will default to speed increments that are divisible by five, such as 25, 30 and 35.



## 10.4.2.5. Enabling and disabling steering assistance when driving

Pilot Assist steering assistance can be easily enabled or disabled using the steering wheel buttons. This allows you to control it without going into settings while driving.

Steering assistance is part of Pilot Assist and can only be used when Pilot Assist is active.

If steering assistance is unavailable for some reason, such as deteriorated lane markings, you won't be able to activate it. However, if steering assistance is enabled, it will automatically activate when the required conditions are met.

### Note

#### Temporary loss of steering assistance

The availability of active steering assistance depends on the conditions you are experiencing. For example, if you encounter a stretch of road with worn out markings, the vehicle may temporarily turn steering assistance off. If this happens you are notified with vibrations in the steering wheel.

- 1 Press the steering assistance button  on the steering wheel.
  - > Steering assistance is either enabled or disabled.
    - If enabled, steering assistance activates automatically when the required conditions are met.
    - If disabled, Pilot Assist will remain active but mainly provide speed- and distance-keeping.

---

## 10.4.2.6. Changing lanes with Pilot Assist

Pilot Assist can provide steering assistance during lane changes in certain conditions. This Pilot Assist feature is called lane change assist.

Pilot Assist automatically provides steering assistance during lane changes if all conditions are met.

In addition to the general conditions for using Pilot Assist, conditions for assisted lane changes include:

- Both steering assistance and lane change assist are enabled in Pilot Assist's settings.
- Pilot Assist is active.
- The conditions for steering assistance are met.
- The traffic situation allows a lane change.
  - The vehicle checks if the conditions for an assisted lane change are met, such as the adjacent lane being available. However, the responsibility to assess and decide whether a lane change can be done safely ultimately lies with the driver.
  - There are road and driving conditions that do not provide the vehicle enough information for it to provide steering assistance during a lane change. In such situations, the driver can still perform unassisted lane changes. This disables

steering assistance until its conditions are met again.

The primary status of Pilot Assist, including available lane changes, is shown below the gear indicator.



The color and direction of the arrows are different depending on the situation.

If the driver information area is in surround mode, assisted lane changes are shown as animations.

If the driver information area is in calm mode, lane change status is communicated via symbols instead.



An assisted lane change is available.



A lane change is ongoing. The arrow indicates the direction of the initiated lane change.



Lane change assist is unavailable and any ongoing lane change is canceled. This can happen if there is a fault affecting critical systems, such as steering assistance. Be attentive to any messages that may follow.

### **Warning**

Lane change assist is a supplement to safe driving practices. It does not reduce or replace the need for the driver to stay attentive and focused on driving safely. Drive the vehicle with the same attention to safety as you would need to in a vehicle without the ability to intervene.

1 Use the turn signal to initiate the lane change.

➤ The vehicle recognizes that you want to change lanes. If the necessary conditions are met, the vehicle begins to guide your steering during the lane change.

The turn signals turn off automatically after the lane change is completed.

### **Note**

#### Keep your hands on the steering wheel

Keep both hands on the steering wheel during the lane change. You are responsible for intervening if necessary. You can override the vehicle's guidance by braking, accelerating or steering at any time.

#### Interrupted lane change

The lane change can be interrupted if there is a change in conditions or traffic situation. This is indicated in the driver information area and the maneuver is canceled immediately. Take full control of the vehicle as required.

## 10.4.2.7. Enabling Pilot Assist in settings

The content of this manual represents the status of the user manual at the time of printing and may not be completely valid in future instances. For more information refer to the first page for the complete disclaimer note.

You can enable or disable Pilot Assist in settings. When enabled, it can be activated while driving.

- 1 Press the vehicle symbol  in the bottom bar and go to **Settings**.
- 2 Go to **Driving** → **Driver support**.
- 3 Select **Pilot Assist** as your default driver support function.

---

## 10.4.2.8. Adjusting Pilot Assist settings

You can adjust or change which features are enabled for Pilot Assist in settings.

Pilot Assist includes several features, some of which you can enable, disable or customize in settings. This allows you to set Pilot Assist up for the level of support you want.

The customizable settings include:

|                                |   |
|--------------------------------|---|
| Steering assist                | Guides the steering wheel movement to correctly position the vehicle in the lane.   |
| Lane change assist             | Provides steering assistance for lane changes. Available lane changes are indicated by the vehicle but initiated by the driver. |
| Adapt to speed limit           | The set speed is automatically updated if the speed limit changes.  |
| Time interval to vehicle ahead | Adjust the target time interval to the vehicle ahead. This way, you can adjust the distance to vehicles in front of you.        |

### Important

#### Changing driver support settings

Make sure that you understand how changing your vehicle's settings affects its behavior. It is particularly important when it comes to features that affect the level of assistance the vehicle can provide.

- 1 Press the vehicle symbol  in the bottom bar and go to **Settings**.
- 2 Go to **Driving** → **Driver support**.
- 3 Customize Pilot Assist settings. Pilot Assist must be selected as your default driver support function for the settings to appear.

---

## 10.4.2.9. Pilot Assist conditions and limitations

To use Pilot Assist safely, it's important to be aware of its limitations. Although it is an advanced function, there are conditions and situations that it cannot handle.

## Driver responsibility when using Pilot Assist

One main limitation of Pilot Assist that you need to be aware of concerns driver responsibility. When using the function, you are still required to actively and attentively drive the vehicle. You are responsible for all decision-making, actions and responses that are part of driving.

Pilot Assist does not know your intentions or the intentions of other drivers. It cannot predict or identify every potentially hazardous situation that an attentive driver can. It's your responsibility to continuously assess Pilot Assist's performance and act if necessary. As long as you judge its input to be correct, you can let it guide your driving.

### Important

#### Driving conditions

Assessing Pilot Assist's performance requires that you take all driving, traffic, weather or road conditions into consideration. For example, if visibility is poor, you may need to increase the distance to vehicles ahead compared to the distance kept by Pilot Assist. The same applies to maintaining a speed that is safe for the current road and traffic conditions.

#### Improved safety and convenience

When used correctly, Pilot Assist can improve safety and reduce the effort of driving. In some cases, it can compensate for driver errors, such as mistakes caused by lapses of attention or distractions. This potential benefit is a supplement to safe driving practices. It does not reduce or replace the need for the driver to stay attentive and focused on driving safely.

#### Driver readiness

Using speed- and distance-keeping features can mean you may not use the pedals for long periods of time. However, you must remain prepared and ready to brake or accelerate manually if necessary. Avoid changing your driving posture in ways that can delay your response time.

#### Hands on the wheel

Pilot Assist can guide your steering, but you are still required to keep your hands on the steering wheel, just like when driving unassisted. As long as you believe the steering input is correct, you can let Pilot Assist guide your steering.

#### Emergency stop

The vehicle can initiate a controlled stop if the driver doesn't respond to requests to actively drive the vehicle and keep their hands on the steering wheel. During the stopping maneuver, the vehicle utilizes all of the information it continuously collects about its surroundings to come to a controlled stop in the lane of the road you're on. It also activates the hazard lights to warn other drivers.

You can always override the stop maneuver by actively steering, braking or accelerating. This indicates that you are attentive again and available to continue the drive.

## Speed range for Pilot Assist

Pilot Assist is available at different speeds depending on the context of activation and use.

- You can set target speeds between 30-150 km/h (20-90 mph).
- When following another vehicle, Pilot Assist can stay active below 30 km/h (20 mph).

**The content of this manual represents the status of the user manual at the time of printing and may not be completely valid in future instances. For more information refer to the first page for the complete disclaimer note.**

- In situations where you are driving slowly behind other vehicles, such as in a line of traffic, you may be able to activate Pilot Assist even if you are driving slower than 30 km/h (20 mph). This requires a vehicle ahead whose speed your vehicle can match.<sup>[1]</sup>

## Activation and availability

Several conditions must be met to activate Pilot Assist. They are related to current traffic and road conditions and the vehicle's system status. Some are related to the vehicle being ready to drive, such as the driver wearing their seat belt and all doors being closed. Others relate to your current driving situation, such as driving at a speed within the speed range for Pilot Assist. If activation is prevented, the specific reason is typically communicated in the driver information area.

## Keeping track of vehicles ahead

One of Pilot Assist's capabilities is adapting the vehicle's speed to a vehicle ahead and maintaining a certain distance to it. Pilot Assist's behavior and ability to track traffic ahead depends on several factors, such as your speed and the speed of the vehicle in front.

Very slow or stationary vehicles in front of you can make Pilot Assist behave differently, depending on the situation and your speed:

- If Pilot Assist follows a vehicle that comes to a stop, Pilot Assist slows your vehicle down to a stop behind the other vehicle.
- If a stopped vehicle is detected ahead of you, Pilot Assist will slow you down in an attempt to stop behind the other vehicle.
  - Depending on your driving speed, the vehicle may not be able to reach a full stop behind the vehicle in front. You are always responsible for keeping track of the surrounding traffic and driving in a way that allows you to react and control your vehicle safely.
- When driving at high speeds, Pilot Assist can misinterpret stationary vehicles in front of you, such as when catching up to a stationary line of traffic. In a situation like this, Pilot Assist will not consider the stopped vehicles or slow you down. Always be attentive and available to control your vehicle and brake when necessary.



### Warning

#### Stopped or slow vehicles ahead

A stopped vehicle in your lane is a collision risk that requires you to act by braking or steering.<sup>[2]</sup>

- At low speeds, Pilot Assist may pause when following another vehicle if:
  - there is uncertainty whether the object detected in front is a stopped vehicle or another object<sup>[3]</sup>.
  - the vehicle ahead makes a turn and leaves your driving path.
  - you manually steer the vehicle out of your current lane.

## Vehicle status and systems

Pilot Assist relies on the accurate detection and identification of surrounding traffic and road conditions. This includes using information from cameras, radar units and other sensors. The detection system cannot handle all driving, traffic, weather or road conditions. Read the separate manual sections about detection types, how they work and their limitations to better understand how Pilot Assist's performance can be affected.

Several of Pilot Assist's features depend on other systems in the vehicle.

- To adapt the speed to vehicles ahead, the vehicle uses a combination of radar and camera detection. Consequently, conditions and limitations of these systems can affect the availability and performance of this feature.
- When Pilot Assist's set speed is set to adapt to the speed limit, the value is provided by the vehicle's road sign information system. In some conditions, it may not be able to provide an accurate speed limit.
- Steering assistance is only available when the vehicle can identify its position on the road through camera detection of lane markings.
  - This requires the road to conform to certain standards.
  - Conditions and limitations of the vehicle's camera detection can affect the availability and performance of steering assistance.

### Important

#### Vehicle faults

Certain vehicle faults can affect the availability of driver support features. If Pilot Assist is unavailable, check the vehicle status view to see if there are any indicated issues.

#### Vehicle alterations

Modifications, repairs and accessory installations can negatively affect or limit driver support features. There is a separate manual section with detailed information on this topic.

## Other conditions and limitations

- Pilot Assist is primarily intended for use when driving on level road surfaces. It may have difficulty keeping the correct distance to vehicles ahead on steep downhill slopes.
- Do not use Pilot Assist when driving with a trailer or heavy loads.

<sup>[1]</sup> Pilot Assist's lowest target speed is 30 km/h (20 mph), even if your speed at activation is lower than that.

<sup>[2]</sup> Your vehicle can still warn you of the collision risk and perform a safety intervention if you fail to react in time. This can happen separately from Pilot Assist's capabilities.

<sup>[3]</sup> For example, obstacles designed to encourage slow driving.

---

## 10.5. Assisted parking

Your vehicle has several features that help you during parking, such as guidance through camera and sensor views. Learn how to use the different types of assistance.

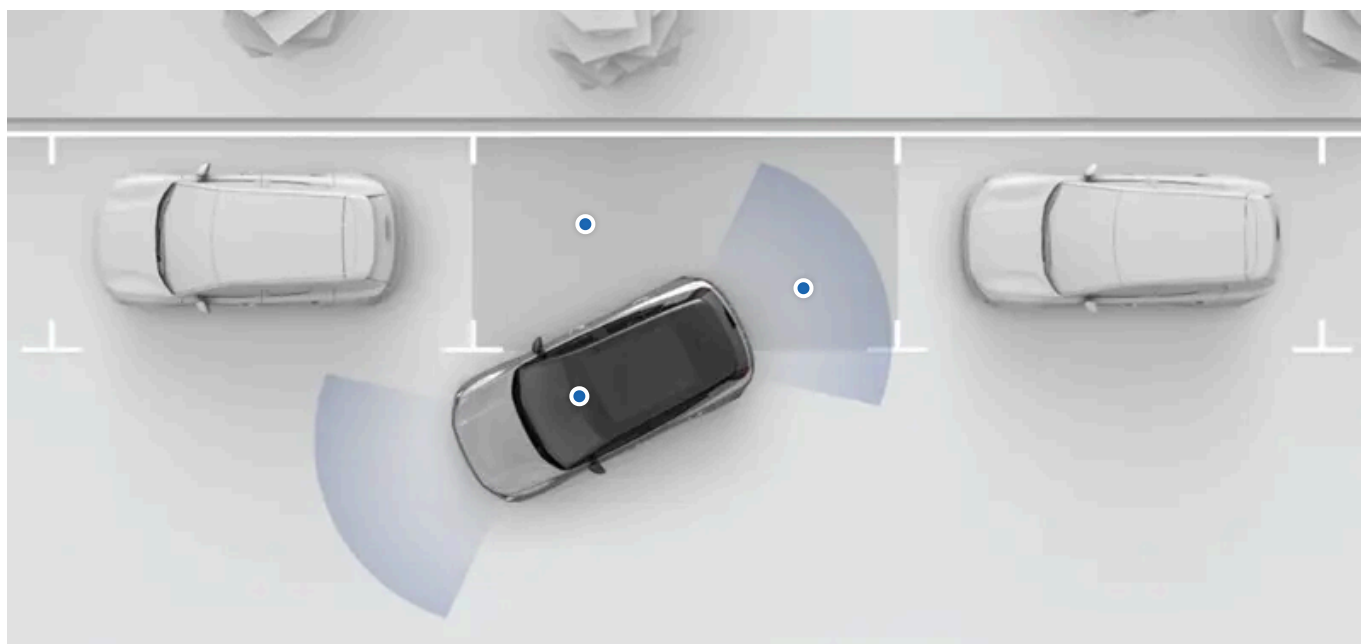

Your vehicle's parking assistance features are available in the display's parking view. In most cases, the parking view opens automatically when you need it, but you can also open it yourself in the display.

The following parking assistance features are available in the parking view:

|  |   |
|--|---|
| <b>Distance and obstacle detection</b> | The vehicle senses the surroundings using many different sensors. It uses this information to guide you with sound, graphics and warnings when driving at low speeds. |
| <b>Parking camera views</b>            | The vehicle shows your surroundings using cameras located around the vehicle.   |
| <b>Park Pilot Assist</b>               | This feature can actively steer the vehicle in and out of parking spaces.   |
| <b>Rear Auto Brake</b>                 | The vehicle can automatically brake if an obstacle is detected immediately behind the vehicle while reversing at low speeds.  |
| <b>Rear Cross Traffic Alert</b>        | This feature can warn you if the vehicle detects that traffic is about to cross your reversing path.  |

### Important

#### Required knowledge and driver responsibility

Assisted parking features are designed to make driving more comfortable and safer, but they do not reduce the need or responsibility of the driver to operate the vehicle as safely as possible. Be sure to read all related information about a feature before using it. The section covering driver responsibility is essential reading for understanding the capabilities and limitations of your vehicle's assisted driving features.

If you find anything unclear or have further questions, do not hesitate to contact your Volvo retailer.

### Note

#### Towbar

If you have installed a towbar on your vehicle, some of the parking assistance features might be affected or unavailable.

## 10.5.1. Parking view

The parking view contains both camera and parking sensor information to help improve your awareness of the vehicle's surroundings. This can be useful when maneuvering at slow speeds, such as when parking.



### Accessing the parking view

The parking view often appears automatically when you slow down to park, but sometimes you need to open it manually. Find the Camera app in the contextual bar to open the parking view.



The parking view closes automatically when you are parked or driving above a certain speed.

### Features in the parking view

The parking view contains the following features:

- Multiple camera views
- Front and rear distance and obstacle detection
- Rear Auto Brake, which can provide automatic braking for obstacles while reversing at low speeds
- Alerts about traffic crossing behind your vehicle<sup>[1]</sup>
- Park Pilot Assist, which can actively steer the vehicle in and out of parking spaces





Tip

### Temporary mute

You can turn the parking support sounds off by pressing the mute button  in the parking view. This lasts for the rest of the drive.

### Adjust volume

If you want to change the volume of the parking support sounds, go to sound settings.

### Check your selected gear

The availability of certain features depends on your gear selection.

## Camera views

There are several camera views to choose from in the parking view.



3D The vehicle combines front, rear and side camera views to show the vehicle in its surroundings.

3D



Rear A camera at the back of the vehicle provides the rear view.



Front A camera at the very front of the vehicle provides the front view.



Left A camera on the left side of the vehicle provides the left side view.



Right A camera on the right side of the vehicle provides the right side view.

## Top view



The top view shows the vehicle from above.

## Adjusting the 3D view

You can adjust the 3D view by changing the angle using your fingers. Adjusting the view can make it easier for you to navigate between different angles and get an overview of your vehicle in the parking view.



Tip

You can always recenter the view by pressing the 3D view symbol. This allows you to return to the default 3D view again.

## Obstacle and distance detection

The content of this manual represents the status of the user manual at the time of printing and may not be completely valid in future instances. For more information refer to the first page for the complete disclaimer note.

The parking view can provide both visual and audible alerts if your vehicle detects any obstacles in your surroundings.

These alerts escalate the closer you are to a detected obstacle. The color of the visual indication shifts towards red, and the sound intensifies.

 **Important**

### Driver responsibility

Obstacle and distance detection is a supplement to safe driving practices. It does not reduce the need or responsibility of the driver to operate the vehicle as safely as possible.

The driver is always responsible for paying attention to the vehicle's surroundings and ensuring that it is safe to maneuver the vehicle.

### Detection limitations

The vehicle's obstacle and distance detection capabilities have limitations. Read the separate section covering detection of vehicle surroundings and traffic before using features that rely on these capabilities.

[1] RCTA

---

## 10.5.2. Park Pilot Assist

Park Pilot Assist can help you maneuver in and out of parking spaces.

When active, Park Pilot Assist controls the vehicle with high precision, allowing you to park in parking spaces. It works for both parallel and perpendicular parking, as well as when leaving a parallel parking space. Park Pilot Assist controls steering, acceleration and braking during the maneuver.

 **Important**

### Read everything

Read all information about the function before using it. It is important to know its proper use and limitations.

### Detection of surroundings

Park Pilot Assist relies on the vehicle's ability to detect its surroundings. It primarily uses information from cameras and parking sensors.

## Parking in a parking space

You can use Park Pilot Assist during parallel and perpendicular parking. When you activate Park Pilot Assist, it identifies available spaces close to the vehicle and presents them in the display. After selecting a space to park in, supervise the maneuver and follow any instructions provided in the display.

## Leaving a parking space

You can use Park Pilot Assist to maneuver out of a parallel parking space if you used Park Pilot Assist to park there. When you activate Park Pilot Assist, the vehicle suggests an exit path. After confirming the path, supervise the maneuver and follow any instructions provided in the display.

### **Warning**

#### Pay attention

When using Park Pilot Assist, you must keep the same level of attention to your surroundings as if parking without assistance. Immediately take full control of the vehicle if necessary.

#### Driver responsibility

The driver is always responsible for driving safely and in accordance with traffic rules and regulations. Park Pilot Assist is not a substitution for the driver's attention and judgment.

#### Limitations

Park Pilot Assist cannot handle all traffic, weather and road conditions. Read the separate manual section covering detection of vehicle surroundings and traffic before using features that rely on these capabilities.

## Stopping Park Pilot Assist

You can always stop an ongoing maneuver. Depending on how you do so, Park Pilot Assist either pauses or ends the maneuver.

There are several reasons to stop an ongoing Park Pilot Assist maneuver, such as:

- You want to take over and complete the maneuver on your own.
- The current placement is good and you don't need it to continue.
- You want it to stop for safety reasons.

You can exit Park Pilot Assist in different ways. For example, you can:

- Press cancel in the display.
- Start steering manually.
- Press the accelerator or brake pedal.
- Change gear.

## Conditions and limitations

Certain events and conditions can prevent activation or pause Park Pilot Assist if they occur during the maneuver. For example:

- An obstacle is detected in the parking path.
- A camera becomes obscured.
- The trunk, hood, or a door is opened.
- The door mirrors are folded in.
- The driver's seat belt is unbuckled.

Park Pilot Assist can resume the maneuver when the condition no longer applies. You can also choose to exit Park Pilot Assist and complete the maneuver without using it.

### Note

#### Towbar

If you have a towbar installed, some of the parking assistance features might be affected or unavailable.

## 10.5.2.1. Parking using Park Pilot Assist

You can activate Park Pilot Assist in the parking view. It's capable of both parallel and perpendicular parking.

The parking view often appears automatically when you slow down to park, but sometimes you need to open it manually. Find the **Camera** app in the contextual bar to open the parking view.



### Important

#### Before using Park Pilot Assist

Take the time to read everything about Park Pilot Assist in this manual before using it for the first time. Understanding its capabilities and limitations is important for safe use.

#### Assess the situation

Make sure the traffic situation and conditions are suitable for activation.

- 1 In the parking view, press the Park Pilot Assist button.



- The vehicle begins scanning for available parking spaces.

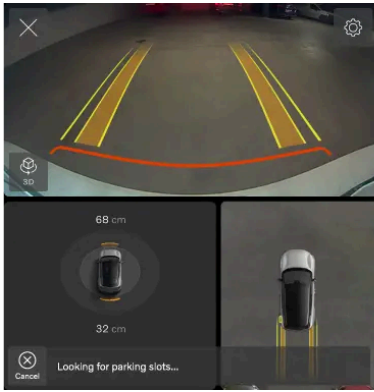

- 2 Drive slowly to continuously scan for available spaces.

- When the vehicle identifies an available parking space, it will be highlighted in the display. The vehicle is capable of identifying several spaces at the same time.



- 3 Select any of the highlighted spaces to park there.

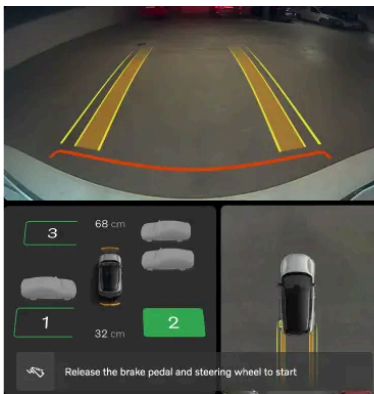

- The vehicle begins the parking maneuver. Follow any instructions in the display.



 **Warning**

As long as Park Pilot Assist is active

Pay attention to your surroundings and take control of the vehicle if necessary.

- 4 The vehicle confirms when it has completed the maneuver.

---

## 10.5.2.2. Leaving a parking space using Park Pilot Assist

You can activate Park Pilot Assist in the parking view. It's capable of maneuvering the vehicle out of a parking space when you're parallel parked, if you have used Park Pilot Assist to park there.

The parking view often appears automatically when you slow down to park, but sometimes you need to open it manually. Find the **Camera** app in the contextual bar to open the parking view.



 **Important**

### Before using Park Pilot Assist

Take the time to read everything about Park Pilot Assist in this manual before using it for the first time. Understanding its capabilities and limitations is important for safe use.

### Assess the situation

Make sure the traffic situation and conditions are suitable for activation.

- 1 In the parking view, press the Park Pilot Assist button.



- The vehicle begins scanning for an exit path.

When a path is identified, it is highlighted in the display.

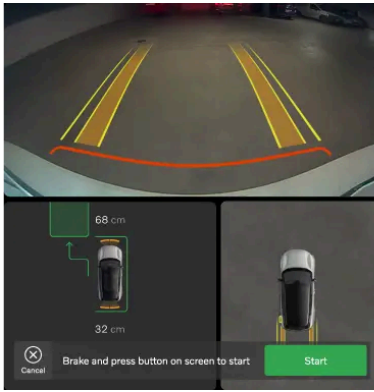

2 To confirm the path and start the maneuver, press the **Start** button in the display.

➤ The vehicle begins the parking maneuver. Follow any instructions in the display.

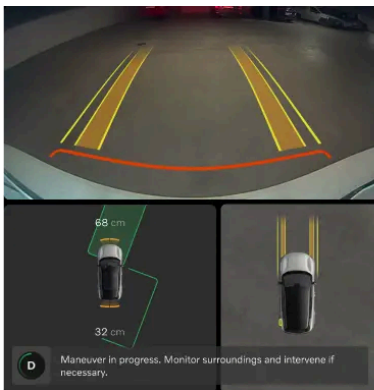

 **Warning**

As long as Park Pilot Assist is active

Pay attention to your surroundings and take control of the vehicle if necessary.

3 The vehicle confirms when it has completed the maneuver.

# 11. Scenarios and driving recommendations

The conditions you're experiencing sometimes affect how you can and should use your vehicle. Knowing its capabilities and how you can adapt to the situation can have a significant impact on the outcome. The benefits range from avoiding outright hazards to getting the most out of your vehicle's performance.



This section of the manual covers specific driving scenarios. These include preparing for a long trip, wading through water and driving on icy roads. Exploring this section gives you a good idea of what features and practices can support you in demanding conditions.

---

## 11.1. Cold conditions

Driving in cold conditions can be tricky. It requires different preparations and a different way of driving than driving in a warmer climate does.

When driving in cold conditions, there are many things to take into consideration. From energy consumption and battery health to a comfortable climate and different safety aspects. Be sure to familiarize yourself with what this way of driving entails, as well as which laws and regulations may apply.

### Visibility

In cold conditions, ice and condensation can obstruct visibility. Your vehicle is equipped with defrosters, a heated rear windshield and heated door mirrors to prevent this from happening.

### Range

Cold temperatures can negatively affect your vehicle's battery. When the vehicle has a cold battery, a snowflake ❄️ appears next to the battery percentage. This indicates that the battery's charge capacity and range are reduced compared to normal con-

**The content of this manual represents the status of the user manual at the time of printing and may not be completely valid in future instances. For more information refer to the first page for the complete disclaimer note.**



ditions. You can avoid this by always charging your vehicle while it's parked, which can prove especially useful if you are parking in a cold climate.

## Maintenance

### Note

As the temperature drops, the tire pressure drops. Remember to check the tire pressure regularly and adjust it as needed.

### Important

#### Cleaning in front of radar units

If you find dirt, snow or ice, or if the vehicle indicates that a radar unit is blocked, you should address it as soon as possible. Always clean and clear a large area around the radar units to so their full field of view is available.

## Parking in cold weather

When the battery is cold, the vehicle temporarily reduces battery performance until it has warmed up. Driving the vehicle in a state of reduced performance doesn't harm the battery.

To avoid temporarily reduced performance from a cold battery, connect the vehicle for charging and activate the vehicle's preconditioning prior to your trip. The vehicle can then heat the battery without affecting performance and available range.

If temperatures are below  $-30\text{ }^{\circ}\text{C}$  ( $-22\text{ }^{\circ}\text{F}$ ), avoid leaving the vehicle parked without charging for longer than 24 hours.

---

## 11.1.1. Winter driving recommendations

There are some things to keep in mind when driving in snow and on ice. Here are some tips and recommendations for safer driving and improved effectiveness of your vehicle's systems.

### Preparations for driving in winter conditions

- Cold weather is more demanding for the battery and can lead to temporarily reduced performance. For better battery performance, precondition your vehicle before driving.
- Use washer fluid with antifreeze to avoid ice forming in the washer fluid reservoir.
- Volvo recommends that winter tires be used when there's a risk of snow or ice.

### Note

In some regions, winter tires are required by law. However, keep in mind that not all locations allow studded tires.

## Recommendations for driving in winter conditions

Snowy and icy roads require careful driving practices that are different from driving on dry roads. There are a number of precautions to take that will help you drive more safely. For example:

- Remove all snow from your vehicle before you start driving, both for your own sake and for your fellow road users. Pay special attention to the sensor areas, lights, roof and hood.
- Avoid any sudden steering maneuvers, fast acceleration or hard braking, as such maneuvers can cause the vehicle to lose grip.
- Turn off One Pedal Drive drive or use the lowest One Pedal Drive setting.
- Keep a safe distance from the vehicle in front of you, as you are likely to require a longer braking distance.
- Keep in mind that even if the sun melts the snow and ice, it can still be slippery.
- Even when other parts of the road aren't icy, bridges can still be dangerous.
- Snow and ice can accumulate inside the mudguards, which can affect steering. Check regularly and remove any snow, ice, and debris.
- Snow and ice can collect in the braking system and reduce braking performance. Check that the brakes work properly on a regular basis. However, only do so in a safe and careful manner.
- Sometimes, using snow chains can be a good idea. However, be sure to read the instructions on how to use them safely and effectively.

 **Warning**

Avoid parking on inclines during winter conditions. The tires might lose traction, even if the parking brake is engaged. You are always responsible for safe parking.

 **Tip**

It's a good idea to practice driving on slippery surfaces under controlled conditions to learn how the vehicle reacts. Visit a skidpan if you have access to one.

## 11.2. Recommendations for driving through water

When driving through water, there are important limitations to consider regarding the water's depth and the driving speed.

 **Important**

Volvo recommends that wading be done with great caution and that you avoid it when possible. It can be difficult to accurately assess the water's depth and the strength of the current. The driver is always responsible for driving in a safe manner and in compliance with all applicable rules of the road.

- If possible, determine how deep the water is before you start driving. Only attempt to drive through if you are confident it's shallow enough to safely wade through.
- The recommended highest water level when wading is up to the bottom of the undercarriage.

**The content of this manual represents the status of the user manual at the time of printing and may not be completely valid in future instances. For more information refer to the first page for the complete disclaimer note.**

- Limit your speed to walking pace.
- Avoid wading in strong currents, especially if the water is deep enough to risk flowing over the vehicle.
- Oncoming traffic can cause waves that increase how high the water reaches.
- If possible, avoid stopping when you're in the water. Carefully keep driving forward or reverse out of it.
- Avoid driving through saltwater, as it can cause corrosion.

 **Warning**

### Wet brakes

The vehicle's stopping distance is longer if the brake discs are wet. Driving through water exposes the brake discs to water, and possibly mud or other sediment. After wading, safely perform a hard braking maneuver to remove dirt and water from the brakes. By engaging the brake discs while driving, they heat up and dry.

---

## 11.3. Preparations for a long trip

Before you head out on a long road trip, it's a good idea to check a few things.

- Make sure that the brakes work as intended.
- Check the tire tread depth and pressure. If there is a risk of snowy or icy roads, change to winter tires.
- Ensure that the wipers are in good shape and replace them if needed.
- Fill up the washer fluid.
- Charge the vehicle to the battery level you need for the first leg of your trip. It's a good idea to look up available charging stations along your planned route.
- Make sure that useful equipment is in place, such as charging cables, a puncture repair kit, a first aid kit, a warning triangle and a reflective vest.
- If you plan to visit a region that uses different units of measurement, such as miles or kilometers per hour, you can change the vehicle's unit settings.
- If driving in a region with different traffic laws, make sure the vehicle is equipped as required, and read up on how the rules of the road differ from what you're used to.
- Remote areas may have poor or no internet connection. If you plan to drive in these areas, download the maps you need in the navigation app so you can use them when your vehicle is offline.

---

## 11.4. Long-term parking

Follow the long-term parking recommendations if your vehicle will go unused for longer than one month. Remember to regularly check on the vehicle when it's parked.

### Long-term parking preparations

- When leaving your vehicle parked for longer than one month, the recommended battery level is 40-60%. Use or charge the vehicle to reach the recommended level.
- If you are leaving the vehicle parked for longer than three months, it's recommended to keep it plugged in but set the battery charging limit to 50%. This is for better battery health.
- Check and adjust the tire pressure. The recommended pressure during long-term parking is 330 kPA (48 psi).
- Choose a cool and shaded location. An environment with controlled and consistent conditions is recommended.

## During long-term parking

Regularly check:

- The state of charge and that charging is working properly
- The tire pressure



Tip

Keep the vehicle up to date

During periods when the vehicle goes unused, make a habit of checking for and installing software updates.

## After long-term parking

- Before driving the vehicle, make sure all core driving controls and functions work properly, such as the brakes.
- Install any available software updates.

## 12. Storage, stowing and towing

Your vehicle is designed to transport people as well as luggage and other cargo. Learn about the car's stowing and towing capabilities.

The storage space under the hood can be used to store items such as a puncture repair kit.

Your vehicle's passenger compartment and trunk have several areas for safely stowing items of different shapes and sizes. The trunk can be expanded to create more space for larger cargo.

You can also use the roof for transporting heavy cargo, and with a towbar, you can attach a trailer.

### **Warning**

It is important to properly store objects, even small items. Objects that are not stowed securely can be dangerous in the event of sudden braking or a collision.

Adding cargo to the vehicle changes the vehicle's weight and driving control properties. Always refer to the vehicle's permitted weight regulations and guidelines.

Before towing a trailer, make sure that all connectors and safety attachments are secured. Also be sure to follow local regulations regarding towing.

### **Important**

Carrying loads on the roof may interfere with vehicle sensors.

---

### 12.1. Passenger compartment storage

Find where the storage locations are in the passenger compartment.



- ① Door panel storage compartments.
- ② Pockets on the front seat backs.
- ③ Center console between the two front seats.
- ④ Space under the display.
- ⑤ Glove compartment.

The center console has several small utility and storage spaces. This includes a retractable cup holder tray.

**i Note**

**Using the cup holder**

To access the cup holder, push the lower front section of the center armrest and let go. The cup holder will slide out fully. The cup holder tray needs to be handled carefully to avoid damaging it. You need to slide it back one cup hole at a time. Do not try to force the tray back in one motion.

## 12.1.1. Glove compartment

Store items that you don't immediately need in the glove compartment.

In the event of sudden braking or a collision, loose items can be hazardous. The glove compartment is useful for storing small items safely and securely.

The glove compartment is located in the middle of the dashboard.

## Opening the glove compartment

You can open the glove compartment via the display. Just press the vehicle symbol in the bottom bar  and go to **Settings** → **Controls** → **More**.

### Tip

You can also open the glove compartment via the **Quick controls** view.

## Locking the glove compartment

You can lock the glove compartment with a PIN via the display.

### Note

If you forget the PIN to unlock the glove compartment, it can be reset.

### 12.1.1.1. Locking the glove compartment

You may want to temporarily lock the glove compartment when you are away from your vehicle.

You can lock and unlock the glove compartment with a PIN code via the display. The PIN will be deactivated after you unlock the glove compartment. Make sure you create a new PIN whenever you want to lock the glove compartment again.

- 1 Press the vehicle symbol  in the bottom bar and go to **Settings**.
- 2 Go to **Controls** → **Locking** → **Glove box lock**.
- 3 Press **Lock**.
- 4 Type in your four-digit PIN.
- 5 Type the same four-digit PIN again to confirm it.

To unlock the glove compartment, press the vehicle symbol in the bottom bar , go to **Settings** → **Controls** → **More** and type in your PIN.

### Tip

You can also unlock the glove compartment via the **Quick controls** view.

## Forgotten PIN

The content of this manual represents the status of the user manual at the time of printing and may not be completely valid in future instances. For more information refer to the first page for the complete disclaimer note.

If you forget the PIN to unlock the glove compartment, you can reset it via the mobile app for your vehicle or via the display with your NFC cards.

**i Note**

#### Resetting via the mobile app

You can reset your PIN via the mobile app for the vehicle to unlock the glove compartment. Follow the instructions shown in the app.

#### Resetting using your NFC cards

You can reset your PIN using your two NFC cards. In the display, press **Forgot PIN?** on the PIN number pad and follow the instructions.

You must have both of your NFC cards with you for the authentication process when resetting the PIN.

## 12.2. Trunk space and storage

The trunk can be configured to accommodate cargo of different shapes and sizes.

You can adapt the trunk in different ways and expand it to create a larger cargo space. This can be useful for storing larger items.



- ① Parcel shelf.
- ② Foldable rear seats.
- ③ Cargo hold.

Folding down the rear seats is ideal for loading large objects. Install a safety net when doing so to prevent objects moving into the front passenger compartment.





Tip

### Adjust trunk opening height

You can adjust how much the trunk hatch opens. This can be useful when you're parked in places with a low ceiling, such as a garage, and you want to reduce the trunk opening height. You can also raise the trunk opening height to create more room for accessing the trunk.

## Stowing cargo securely

You can also find options for stowing cargo securely, such as load-retaining eyelets and bag hooks. These features are useful for making sure cargo doesn't move around in the trunk while you're driving.

## 12.2.1. Parcel shelf

Use the parcel shelf to hide items in the trunk from view.

The parcel shelf is attached by two hinges at the back, near the rear seats, and two cords in the front. The cords hook onto attachment points on the trunk hatch.

Remove the parcel shelf to create more space or more easily access the rear interior of the vehicle.

### Important

- Do not place anything on the parcel shelf. In the case of sudden braking or a collision, loose objects can move abruptly and cause injury.
- Keep in mind that large objects stored in the vehicle can reduce your driving visibility.
- Do not leave the parcel shelf in the vehicle when it is not properly secured.
- When folding the rear seats down, first remove the parcel shelf.
- When placing tall objects in the trunk, it's best to remove the parcel shelf. This is because the shelf is attached to the trunk hatch and lies flat when the hatch is closed. If a tall object gets in the way of the parcel shelf, it can damage the shelf.

### Warning

#### Child restraints

Take care to keep the parcel shelf and objects in the trunk clear from the top tether straps of a child restraint. Contact with the straps can cause damage. Never use the child restraint if the top tethers are damaged in any way. When using a child restraint on the rear seats, remove the parcel shelf or detach it and keep it secure in the cargo area. Also secure all objects in the trunk.

## 12.2.1.1. Removing the parcel shelf

The parcel shelf can be removed to give you more space in the trunk.



There are two attachment points on the parcel shelf itself and two on the trunk hatch. When the parcel shelf is attached, cords run between attachment points on the parcel shelf and the trunk hatch.

The cords have loops at each end that you hook onto the trunk hatch attachment points.



- 1 Detach each cord from the trunk hatch attachment points.
  - The shelf is loose but lies flat in the same position.
- 2 Lift the shelf from the hinges at the back, near the rear seats.
- 3 Carefully move the parcel shelf towards you until it is completely removed from the trunk.
- 4 Store the removed parcel shelf somewhere it won't get damaged or be in the way for other people.

### Note

Keep in mind that large objects stored in the trunk can reduce your driving visibility.

## 12.2.2. Removing the cargo hatch

You can make the trunk space bigger and access the cargo hold more easily by removing the cargo hatch.

Removing the cargo hatch allows you to enlarge the trunk space.

Clear all items from the trunk and extend the trunk hatch to its full height. This ensures that nothing will get in the way when you remove the cargo hatch.

- 1 Grasp the hatch handle. It's located in the middle of the cargo hatch, near the outer edge.
- 2 Pull the hatch up.
  - The hatch is open and resting on its hinges.
- 3 Reach into the cargo hold and push the cargo hatch upwards near the hinges.



Illustrated guide to removing the cargo hatch.

- The cargo hatch lifts out from the hinges.
- 4 When the cargo hatch is free from the hinges and fully loose, pull it out from the trunk.

Place the cargo hatch where it can't get damaged or fall.

---

## 12.2.3. Stowing cargo in the trunk

The trunk has a number of options for stowing items. This can be useful for making sure that cargo doesn't move around in the trunk while you're driving.

The trunk has several features to help stow items. These include:

- Load-retaining eyelets in the lower four corners of the trunk for securely fastening objects with straps.
- Bag hooks for preventing shopping bags from falling over. They are located on the side panels.

- Cargo hold under the trunk floor for stowing items.



Load-retaining eyelets are located in the four corners of the trunk. You can use the load-retaining eyelets to attach straps and secure cargo in the trunk.

**i** Tip

You can find a 12 V socket on the right-hand side of your trunk. It can be useful for powering various electrical devices, such as a cool box.

---

### 12.2.3.1. Accessing the cargo hold

You can access a storage area under the floor of the trunk.

The cargo hatch can be lifted to store and protect fragile items in the cargo hold.

Make sure you can open the cargo hatch by removing any obstructions.

- 1 Grasp the hatch handle. It's located in the middle of the cargo hatch, near the outer edge.
- 2 Pull the hatch up.

---

## 12.3. Storage under the hood

In addition to the trunk, there is also a storage space under the hood.

Examples of items that can be stored in the front cargo area include the vehicle's warning triangle, tool kit, towing eye and puncture repair kit.

---

## 12.4. Towing a trailer

A towbar allows you to tow a trailer with your vehicle. Be sure to familiarize yourself with towing features and any relevant safety issues.

Before towing a trailer, consider how this will affect your journey. Make a thorough assessment based on your vehicle's capabilities.

- Keep in mind that the vehicle performs differently with added weight at the rear. This affects both handling and power usage. Expect a notable reduction in range when towing a trailer.
- Only use trailers in good working condition that comply with local regulations.
- Make sure you have read the separate section of the manual covering loading recommendations.

### Note

#### Software features connected to your towbar

Make sure that the towbar is properly installed.

If you've had the towbar installed after purchasing your vehicle, a system update may be needed for the towing features to work. Contact an authorized Volvo workshop to update the software.

#### Maximum permitted trailer weights

The stated maximum permitted trailer weights are those permitted by Volvo. National vehicle regulations can further limit permitted trailer weights and speeds. Your towbar may be certified for a higher towing weight than the vehicle can actually tow.

#### Towing preparations

- 1 Increase the tire pressure to the recommended pressure for a full load. This applies regardless of the trailer weight.

#### Driving with a trailer

- 2 Read the recommendations for driving with a trailer thoroughly before you start driving.

 **Important**

### While driving

- Maintain a low speed when driving with a trailer up long, steep ascents.
- Avoid driving with a trailer on inclines of more than 12%.
- The additional load increases the risk of overheating, which will be indicated in the driver information area of the display. Follow any instructions shown.
- Avoid parking on an incline if possible. The extra weight of the trailer can affect the parking brake's ability to securely hold the vehicle. If you cannot avoid parking on an incline, be sure to block the wheels<sup>[1]</sup> as a precaution.

### Fishtailing

Fishtailing is a phenomenon that can occur when towing a trailer. It causes the vehicle and trailer to oscillate in a side-to-side motion, which can escalate quickly and cause loss of control. Fishtailing primarily occurs at high speeds, especially if the trailer load is too heavy or improperly distributed. The vehicle continually monitors its movement and can intervene to help the driver regain control if it detects fishtailing.

Factors that introduce sideways motion can trigger fishtailing. For example:

- Sudden gusts and powerful side winds.
- Uneven road surfaces.
- Sweeping steering wheel movements from side to side.

### Trailer stability assistance

The stability control system<sup>[2]</sup> intervenes if it detects fishtailing when towing a trailer. The system precisely times individual braking actions for the front wheels to mitigate the fishtailing phenomenon. This is often enough to help the driver stabilize the vehicle and trailer. When the system intervenes to suppress fishtailing, the electronic stability control symbol flashes in the driver information area.



Electronic stability control symbol

### Interventions and warnings when reversing

The vehicle can automatically brake to prevent a collision when reversing if it detects an obstacle or crossing traffic behind the vehicle. Interventions and warnings when reversing are disabled when towing a trailer.

<sup>[1]</sup> If you do not have wheel chocks, you can use large stones or wooden blocks instead.

<sup>[2]</sup> Electronic Stability Control (ESC)

---

## 12.5. Determining the permitted gross vehicle weight

The content of this manual represents the status of the user manual at the time of printing and may not be completely valid in future instances. For more information refer to the first page for the complete disclaimer note.

Make sure to never exceed your vehicle's maximum gross vehicle weight. Calculate your load limits for transportation using the following information.

 **Warning**

- If the permitted axle weight, gross vehicle weight or another specified weight is exceeded then the tires may overheat. This could lead to serious tire damage and safety risks.
- Do not use replacement tires with a lower load capacity than the tires the vehicle was originally equipped with, as this lowers the vehicle's gross vehicle weight classification. Only use tires with the correct load capacity. For more information, contact Volvo Support.

Before you load the vehicle, you should familiarize yourself with the following weight terminology that can be found on the FMVSS/CMVSS label (Federal/Canadian Motor Vehicle Safety Standards) and the vehicle's tire information plate:

Terminology:

|                                |   |
|--------------------------------|---|
| <b>Curb weight</b>             | Weight of the vehicle, including all oil, fluids and all standard equipment. This does not include passengers, cargo or optional equipment.   |
| <b>Weight capacity</b>         | All weight added to the curb weight, including cargo and optional equipment. When towing, trailer hitch tongue load is also part of cargo weight.   |
| <b>Gross vehicle weight</b>    | The vehicle's curb weight + cargo + passengers.   |
| <b>Permissible axle weight</b> | The maximum allowed weight that can be carried by an individual axle (front or rear). These figures are specified on the FMVSS/CMVSS label (Federal/Canadian Motor Vehicle Safety Standards). The total load on each axle must never exceed its maximum permitted weight. |

**Steps for determining correct load limit**

- 1 Locate the statement "The combined weight of occupants and cargo should never exceed XXX kg or XXX lbs." on your vehicle's placard.
- 2 Determine the combined weight of the driver and passengers that will be riding in your vehicle.
- 3 Subtract the combined weight of the driver and passengers from XXX kg or XXX lbs.
- 4 The resulting figure equals the available amount of cargo and luggage load capacity. For example, if the "XXX" amount equals 1400 lbs. and there will be five 150 lb passengers in your vehicle, the amount of available cargo and luggage load capacity is 650 lbs. ( $1400 - 750 (5 \times 150) = 650$  lbs.)
- 5 Determine the combined weight of luggage and cargo being loaded on the vehicle. That weight may not safely exceed the available cargo and luggage load capacity calculated in Step 4.
- 6 If your vehicle will be towing a trailer, load from your trailer will be transferred to your vehicle. Consult this manual to determine how this reduces the available cargo and luggage load capacity of your vehicle.

---

## 12.6. Recommendations for loading

Proper loading is important for safety and vehicle performance on the road.

## Loading in general

Cargo weight and placement affect the vehicle's center of gravity, handling and performance.

### Warning

#### Unsecured cargo

In a 50 km/h (30 mph) frontal collision, a loose object weighing 20 kg (44 lbs) can generate 1,000 kg (2,200 lbs) of force on impact. Always follow the loading recommendations to reduce the risk of material damage or personal injury.

- Position heavy cargo as low as possible.
- Always secure cargo to the load-retaining eyelets with straps or web lashings. Otherwise, it may shift during heavy braking or sharp turns. This is particularly important if the rear seats are folded down.
- Do not stow cargo where it may obstruct airbag deployment. If stacked cargo reaches above the upper edge of the windows, be sure to have at least 10 cm (4 inches) of clear space between the window and the cargo. Otherwise, the intended protection of the inflatable curtain, which is concealed behind the panels above the windows, may be compromised.
- Always comply with the vehicle's specifications regarding weight and maximum permitted load.
- When loading the trunk, position cargo firmly against the rear seat backrests.
- Avoid placing cargo against the back of the front seats. This may compromise the effectiveness of the front-seat whiplash protection.
- Cover any sharp edges, corners and protrusions.
- Make sure that all cargo is secure for the duration of travel. You need to regularly check and re-tighten the straps because cargo can move during transit.
- Remove cargo you no longer need from the vehicle. Reducing the vehicle's overall weight improves both performance and range.

### Tip

#### Expand the stowing capabilities

For bulky cargo, expand the cargo area by removing the parcel shelf and folding the seats. You can also make space for long and narrow objects by folding the rear seats down.

## Roof loading

### Important

Use a roof rack recommended by Volvo when carrying loads on the roof. This reduces the risk of damage to the vehicle and helps ensure safety while traveling. Carefully follow the mounting instructions supplied with the load holders.

Exterior loads affect the vehicle's aerodynamics, handling and sensitivity to crosswinds. Increased drag affects energy consumption and range.

- Position heavy cargo as low as possible.

The content of this manual represents the status of the user manual at the time of printing and may not be completely valid in future instances. For more information refer to the first page for the complete disclaimer note.



- Distribute the load evenly across the load holders.
  - For long loads that extend over the hood, install the towing eye at the front of the vehicle and use it to secure the load.
  - Drive gently. Avoid rapid acceleration, hard braking and sharp cornering.
  - Remove the load holders when you are not using them. This improves both performance and range.
-

## 13. Care and maintenance

Keep the interior and exterior of your vehicle in good condition with regular care and maintenance.

This section of the manual covers regular care and cleaning you can do yourself, information about some of your vehicle's components that have specific maintenance needs and service maintenance information.

### Note

#### Volvo's service program

Adhering to your vehicle's service program is highly recommended. A vehicle in good condition contributes to traffic safety and operational reliability.

## 13.1. Vehicle status

The vehicle status view in the display is a useful aid for keeping track of your vehicle's health. This is where the vehicle shows you information about any detected issues.

The vehicle status view shows a visual overview of your vehicle and lists any detected issues. The issues are classified depending on severity. A minor issue may be something you can sort out on your own, such as refilling washer fluid. A critical issue may require a workshop visit before you can safely drive the vehicle again. It's recommended to address issues as soon as they appear, especially if they're not minor.

### Important

The vehicle is unable to detect and identify all types of issues that can occur. It is therefore important to regularly inspect the car's condition and address any service or maintenance needs you identify. Contact an authorized Volvo workshop for guidance if you are unsure of an issue's severity, regardless of whether it is indicated by the vehicle or not.

To open the car status view, press the vehicle symbol  in the bottom bar and go to **Car status**.

### 13.1.1. Battery status and health

You can find your vehicle's traction battery status and health in the display.

To open the vehicle status view, press the vehicle symbol  in the bottom bar and go to **Car status** and then **Battery status**.

Press the information symbol or downward arrow to find more information for each area:

**Charging power** Current estimation of your vehicle's charging power as well as the battery's preconditioning status. You can press the information symbol for more details on the actual charging power and the actual charging limit. If the vehicle is not plugged in, the values will be 0.

**The content of this manual represents the status of the user manual at the time of printing and may not be completely valid in future instances. For more information refer to the first page for the complete disclaimer note.**

**Battery health** Battery state of health is a measure of how much energy can be stored in the battery compared to when it was new. Distance driven since last estimation is also provided.

**Battery temperature** Here you can find information about the battery temperature, which can impact charging speed, range and acceleration.

You will get notifications if functions related to the battery health are affected or if you need to take action somehow.

---

## 13.2. Exterior cleaning and care

Keep your vehicle's exterior in good condition by getting rid of dirt and taking care of any paintwork scratches as soon as you notice them. Ensure good visibility by keeping wiper blades in good condition.



Wash your vehicle regularly, top up the washer fluid when needed and replace the wiper blades when they get worn. Taking care of your vehicle's exterior doesn't just make it look nice; it also keeps your vehicle in good condition.

---

### 13.2.1. Washing the exterior by hand

To avoid problems cleaning ingrained dirt, wash the vehicle regularly and as soon as it starts getting dirty. This reduces the risk of scratches and, of course, keeps your vehicle looking good.

 **Important**

### When and where to clean the exterior

- Clean your vehicle as soon as it has attracted dust or dirt. This prevents the build-up of ingrained dirt, which often contains larger particles and debris that cause wear and damage, especially during cleaning.
- Remove bird droppings and tree sap or resin as soon as possible. These contain substances that can quickly damage and discolor the paintwork.
- Avoid washing your vehicle in direct sunlight. This can cause cleaning agents or wax to dry out and act as abrasives.
- If the vehicle has been exposed to corrosive substances, such as acid rain, salt, chemicals, iron powder, soot or ash, it needs to be cleaned as soon as possible to prevent damage. In areas with a lot of industrial emissions, more frequent washing is recommended.
- Clean the vehicle in a dedicated cleaning area that collects the wastewater and make sure the water is treated according to environmental regulations. Make sure that there is an oil separator in the cleaning area.

### High-pressure washing

- Make sure that doors, windows and hatches are closed.
- Use a circular motion and keep the nozzle at least 30 cm (1 foot) from the vehicle's surface.
- Do not spray directly onto openings or sensitive areas such as locks, cameras, trim, air intakes or the charging port.

### Do not wash while charging

Do not wash your vehicle if the charging cable is connected.

 **Note**

- Be gentle and use the right cleaning equipment for the type of surface you are washing.
- Only use cleaning agents and vehicle care products recommended by Volvo, and follow each product's accompanying instructions.

#### Full exterior washing

- 1 Start by rinsing the underbody, including the wheel housings and bumpers.
- 2 Rinse the entire vehicle to dissolve and wash away dirt. For particularly dirty surfaces, you can use a cold degreasing agent.
- 3 Then use a sponge, car shampoo and plenty of lukewarm water to wash the entire vehicle.
- 4 Dry the vehicle with a clean, soft chamois cloth or a gentle squeegee. This reduces the risk of stains from dried water droplets, which require additional polishing.
- 5 Remove dirt from the drainage holes in the doors and clean out the door sills after washing the vehicle.
- 6 If any tar stains from the road-surface asphalt remain, use a tar remover to get rid of them.

If there are particularly stubborn dirt patches or if you don't get the desired results when cleaning your vehicle, contact Volvo support for advice.

---

## 13.2.2. Washing the vehicle in an automatic car wash

Volvo recommends that you wash the vehicle by hand so that you can properly reach all parts of the vehicle. However, an automatic car wash is a simple way to quickly clean your vehicle as soon as it gets dirty.

### Note

Volvo recommends that you do not use an automatic car wash during the first few months, when the vehicle is still new. This allows the paintwork to harden properly.

### Important

#### Before using an automatic car wash

Before driving up to the car wash, remember to:

- check that doors and hatches are closed
- disable the rear auto brake in the parking view
- reduce the alarm sensitivity if you won't be inside the vehicle while it's being washed
- secure any auxiliary lights.

Once you're waiting to enter the car wash, activate car wash mode in settings to get your vehicle ready. It will then:

- close all windows
- turn the wipers off
- fold the door mirrors in
- activate air recirculation.

Remember to perform these steps manually if you are not using car wash mode.

**1** Follow the instructions to drive into the automatic car wash and stop at the designated location.

**2** If you are using a rollover car wash:

- Put the gear in P to engage the parking brake.

If you are using a tunnel car wash:

- Put the gear in N and take your foot off the brake. Do not apply the parking brake.

 **Important**

In a tunnel car wash, your wheels will need to be able to roll freely throughout the washing process.

- 3 When the wash is completed, follow the instructions and drive out.
  - Car wash mode will automatically deactivate when you start driving again.
- 4 Be sure to reset any functions you changed manually before you drove in.

 **Warning**

Always test the brakes after washing, including the parking brake. This helps prevent moisture from causing corrosion, which could reduce brake performance.

 **Note**

To ensure that all vehicle features are available to you, it is recommended that car wash mode is turned off before you reach a public road.

## 13.2.2.1. Activating vehicle wash mode

You can get your vehicle ready to go into an automatic car wash by activating car wash mode in the display.

Instead of preparing the vehicle to be washed in an automatic car wash yourself, you can activate car wash mode. It ensures that your vehicle is ready to be washed and that certain capabilities, such as the rain sensor, remain deactivated while you wash the vehicle.

- 1 Press the vehicle symbol  in the bottom bar and go to **Settings**.
- 2 Go to **Controls** → **Car modes** → **Car wash mode**.
- 3 Activate vehicle wash mode.

 **Note**

Vehicle wash mode will deactivate automatically when you start driving again. However, to ensure that all vehicle features are available to you, it's recommended to deactivate car wash mode before you reach a public road.

## 13.2.3. Polishing and waxing

When your vehicle loses its luster, it's time for a new coat of polish. This gives the paintwork extra protection.

Feel free to wax your vehicle whenever necessary, but you shouldn't need to polish it during its first year.

### Important

#### Be careful

- Do not use products intended for high-gloss paintwork and do not polish surfaces that have matte paintwork. This may create a permanent gloss on the surface.
- Polishing glossy trim moldings could wear away or damage the glossy surface layer.
- Avoid using polish or wax on rubber and unpainted plastic components.

Contact a Volvo retailer for information on recommended cleaning agents and car care products.

- 1 Make sure the vehicle is protected from direct sunlight. The surface should be no more than 45 °C (113 °F) when applying polish or wax.
- 2 Wash and dry the vehicle thoroughly.
- 3 First polish the vehicle, then wax it. Follow the instructions on the packaging carefully. Many products contain both polish and wax.

---

## 13.2.4. Touching up paintwork damage

Taking care of your vehicle's paintwork helps to maintain the exterior. Inspect it regularly and repair damage right away to avoid further problems.

Common damage that may occur includes stone chips, scratches and marks along the edges of doors or bumpers.

### Important

Paintwork damage in front of a radar can affect the radar's detection capabilities. Contact a service point for repairs if you find any damage near the radars.<sup>[1]</sup> If you're unsure about where your vehicle's radars are, you can find an overview of their locations in a separate section of this manual.

 **Note**

Paint batches and brands may differ slightly in color even if the color code is the same. Therefore, even though you can fix these issues on your own, Volvo recommends that you always contact an authorized Volvo workshop to get help with any paintwork damage.

- Contact a Volvo retailer for recommendations on touch-up pens and spray paints.
  - The surface must be clean and dry before doing any touch-ups.
  - The temperature of the surface should be at least 15 °C (59 °F).
  - Follow the instructions for the touch-up pen or paint you're using.
- 
- 1 Apply masking tape over the damaged area. Then peel it off to remove all loose paint.
  - 2 If there are uneven edges, you may need to gently polish around the damaged area using a very fine abrasive cloth. Clean the area thoroughly afterwards and let it dry.
  - 3 If the damage:
    - has not reached the metal and an undamaged layer of paint remains, you can apply touch-up paint directly to the cleaned surface.
    - has reached the metal, first use a primer.
    - is on a plastic surface, first use an adhesive primer for better results. Spray into the lid of the spray can and brush on a thin layer.
    - is a long scratch, use masking tape around the damaged area to protect the undamaged paintwork.
  - 4 Stir the primer thoroughly and apply with a fine brush, matchstick or something similar. Let it dry.
  - 5 Finish with a base coat and clear coat.

<sup>[1]</sup> Volvo recommends authorized Volvo workshops for all servicing and repairs.

---

## 13.2.4.1. Finding the paint color code

You can find the vehicle body paint color code on the product label located on a pillar between the front and rear doors.



If there is damage to your vehicle's paintwork or it needs repairing or repainting, you need to know the exact color of the paint.

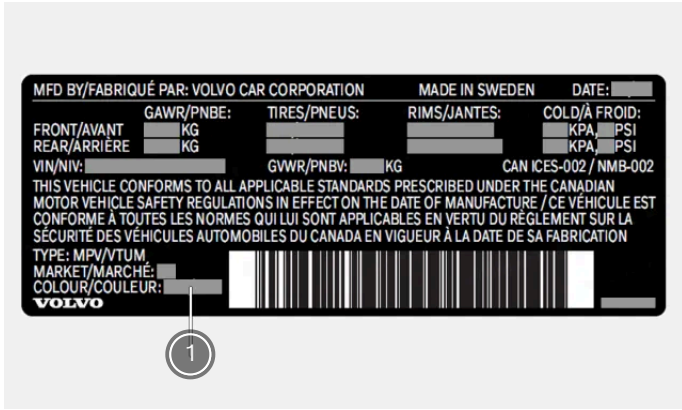

① Paint color code

- 1 Go to the left-hand side of the vehicle.
  - 2 Open the front and rear doors.
  - 3 Find the door pillar located between the front and rear doors.
- The product label containing the color code is located on the outer side of the door pillar, near the bottom.



---

## 13.2.5. Windshield damage

It's important to repair a damaged windshield as soon as possible. If you take immediate action, minor chips and cracks can often be repaired without replacing the entire windshield.

### Small cracks or chips

Small windshield cracks or chips can quickly spread, turning it from minor to severe damage. Contact an authorized Volvo workshop if you notice glass damage. Repair the windshield as soon as possible.

 **Important**

### Camera and sensor area

Any windshield damage in the camera and sensor area, including small chips, scratches or cracks, can negatively affect forward detection and features that use it.

- Any windshield damage in this area requires inspection by a service technician.
- Volvo recommends not repairing small damage in the camera and sensor area. Instead, the entire windshield should be replaced.

## Severe glass damage

If the windshield suffers severe damage, the entire glass panel needs to be replaced.

 **Warning**

### Compromised safety

Do not drive the vehicle if there is structural damage to the windshield. Weakened glass can degrade very quickly, impair visibility and seriously compromise safety.

 **Note**

### Compatibility of new windshield

It's important that the new windshield and its installation meet Volvo's specifications for safety and compatibility with the vehicle's features.

### Calibration

When a windshield is installed, the forward-facing camera behind the glass requires function checks and calibration by a service technician to ensure that it works correctly.

## 13.2.6. Refilling washer fluid

The washer fluid reservoir cap is located under the hood. Be sure to use high-quality washer fluid.

The vehicle notifies you when the washer fluid level is getting low.<sup>[1]</sup>

 **Note**

### Reservoir capacity

Your vehicle can hold 3.5 liters (approximately 3.7 U.S. quarts) of washer fluid.

 **Important**

### Washer fluid quality

- Use washer fluid with a pH between 6 and 8.
- If you use concentrated washer fluid, dilute it as instructed on the packaging and use clean pH-neutral water.
- Volvo recommends washer fluid with antifreeze in cold conditions, especially in temperatures below freezing. This is to prevent damage caused by the fluid freezing inside the pump, reservoir and hoses.

1 Open your vehicle's hood.



Locate the blue cap with the washer fluid symbol and open it.

3 Pour the washer fluid into the reservoir. Avoid spillage if possible.

4 Close the cap and hood.

<sup>[1]</sup> When there is about 1 liter (1 quart) left.

---

## 13.2.7. Cleaning wipers

Dirt, dust, sand, insects and different weather conditions are just a few of the things your wipers take care of. It's important to clean your wipers regularly to maintain good visibility and prolong the blades' service life.

- 1 To access the front wiper blades, activate the wiper service position. This is available in the vehicle's settings.
- 2 Rinse the area with water to get rid of any loose dust and dirt.
- 3 Use a soft sponge with a lukewarm soap solution or car shampoo to clean the area. Lift the wiper arms from the windshield for better access.
- 4 Use a clean, soft cloth to dry the wipers.

The content of this manual represents the status of the user manual at the time of printing and may not be completely valid in future instances. For more information refer to the first page for the complete disclaimer note.

- 5 Make sure the wiper arms are folded back down against the windshield, then deactivate the wiper service position.

 **Important**

Test the wipers before driving. Use plenty of washer fluid when the wipers are in motion. The windshield must be wet for the wipers to work properly.

---

## 13.2.8. Replacing front wiper blades

Your front wiper blades' service life is affected by the water, dirt and debris that they sweep off your windshield. The wiper blades need to be replaced when they show signs of wear.

- 1 Activate the wiper service position via settings in the display.
- 2 Fold the wipers up and away from the windshield.
- 3 Press the button on the wiper arm and pull the blade straight out so that it's parallel with the wiper arm.
- 4 Make sure that the blade for the driver side is longer than the blade for the passenger side. Slide the new blade into the wiper arm until you hear it click into place.
- 5 Check that the blade is firmly attached.
- 6 Fold the wiper arms back down against the windshield.
- 7 Deactivate the wiper service position.

---

## 13.2.9. Replacing the rear wiper blade

Your rear wiper blade's service life is affected by the water, dirt and debris that it sweeps off your rear windshield. The wiper blade needs to be replaced when it shows signs of wear.

- 1 Grasp the center of the wiper arm and lift it up and away from the rear windshield. You may feel some resistance halfway – this is the lock position. You need to pull the wiper arm past the lock position so that it doesn't fall back onto the windshield
- 2 Put your thumbs on top of the wiper blade, underneath the wiper arm, and push down on the blade until it loosens and comes away from the wiper arm.

The content of this manual represents the status of the user manual at the time of printing and may not be completely valid in future instances. For more information refer to the first page for the complete disclaimer note.

- 3 Press the new blade into place until you hear a click.
- 4 Check that the blade is firmly attached to the wiper arm.
- 5 Fold the arm back down against the windshield.

---

## 13.2.10. Activating the wiper service position

The wiper service position allows you to clean or replace the front wiper blades. When activated, the wipers move to a more accessible position on the windshield.

- 1 Press the vehicle symbol  in the bottom bar and go to **Settings**.
  - 2 Go to **Controls** → **Mirrors and wipers** → **Wipers** → **Wiper service position**.
  - 3 Activate the service position.
- The wipers move to a more accessible position and can be lifted up from the windshield for servicing.

### Important

#### Fold the wipers down

Be sure to fold the wipers back down against the windshield after servicing them. Activating the wipers when they are in a raised position can damage the vehicle.

Once you have folded the wipers back down, deactivate the service position. This can be done by either of these options:

- The setting in the display.
- Start driving.
- Start using the wipers or washers.

---

## 13.2.11. Corrosion protection

A good way to reduce the risk of corrosion is to keep your vehicle clean. Your vehicle also has durable corrosion protection.

Normally, the corrosion protection doesn't require maintenance apart from regular cleaning and washing, which removes corrosive substances. Avoid using strong alkaline or acidic cleaning solutions on glossy trim components because they can cause

**The content of this manual represents the status of the user manual at the time of printing and may not be completely valid in future instances. For more information refer to the first page for the complete disclaimer note.**

corrosion. Road surfaces with gravel or small stones can lead to paint chips that can act as entry points for corrosion. Deal with such damage as soon as you notice it.

The vehicle body's corrosion and abrasion protection consists of:

- protective coatings, both on the sheet metal and applied in a high-quality painting process
  - shielding with plastic components
  - corrosion-resistant cast aluminum used for exposed components of the wheel suspension.
- 

## 13.3. Interior cleaning and care

Keep the interior of your vehicle in good condition by taking care of its materials and keeping them clean.



Use the passenger compartment storage areas and cup holders to keep your vehicle tidy. Always take care of stains and dirt as soon as you notice them to avoid permanent staining.

If there are particularly stubborn dirt patches, or if you don't get the desired result when cleaning your vehicle, contact Volvo Support for advice.

---

### 13.3.1. Cleaning fabrics and textiles

If you get a stain on the vehicle's interior, such as on the headlining or seat upholstery, clean it as soon as possible.

These recommendations apply to various interior fabrics.

 **Important**

### When cleaning upholstery

- Never scrape or rub dirty surfaces. Instead, use gentle circular motions. Remember that sharp objects or abrasive materials can damage the vehicle.
- Always clean the entire upholstery. Cleaning only isolated spots on the upholstery can leave water rings or other marks.
- Do not remove surface upholstery during cleaning.
- Certain clothes, such as jeans or suede, can discolor the textile upholstery.
- Be careful when cleaning the headliner as harsh treatment may damage it.
- Only use cleaning agents and vehicle care products recommended for cleaning textiles, and follow each product's accompanying instructions.

 **Warning**

### Seats with side airbags

Never spray a cleaning agent directly on the sides of seats with side airbags. Instead, wipe them clean with a cloth lightly dampened with a suitable cleaning agent.

- 1 Vacuum or dust the area to remove loose dust and dirt.
- 2 Clean the area with a neutral-colored, clean and lint-free microfiber cloth that is lightly dampened with water or a colorless, mild cleaning agent. Use gentle circular motions.

 **Tip**

To wash the textile upholstery, an upholstery cleaning machine is recommended for extracting the cleaning solution and performing a water rinse.

- 3 Let the material dry fully before use.

 **Important**

### Cleaning seat belts

When cleaning a seat belt, keep it extended until fully dry.

## 13.3.2. Cleaning glass and glossy surfaces

Gently clean surfaces such as the display, mirrors and touch buttons on a regularly basis.

 **Important**

- Before you clean the display, remember to activate the display cleaning mode.
- Do not scrape or use any abrasive cleaning agent on mirrors, touch buttons and the display surface. This can damage the reflective surface.

- 1 Vacuum or dust the area to remove loose dust and dirt.
- 2 Use a clean microfiber cloth lightly dampened with water and clean the area with a gentle circular motion.
- 3 Let the surface dry fully before use.

---

### 13.3.2.1. Activating display cleaning mode

Before you clean the display, you need to activate the display cleaning mode.

- 1 Press the vehicle symbol  in the bottom bar and go to **Settings**.
- 2 Go to **Controls** → **Lights and displays** → **Display** → **Clean screen**.
- 3 Press to activate.

---

### 13.3.3. Cleaning interior plastic and metal components

Clean panels and controls regularly, and deal with stains straightaway.

 **Important**

**Be gentle**

Never scrape or rub dirty surfaces. Instead, use gentle circular motions. Remember that sharp objects or abrasive materials can damage the vehicle.

Vacuum or dust the area to remove loose dust and dirt.

The content of this manual represents the status of the user manual at the time of printing and may not be completely valid in future instances. For more information refer to the first page for the complete disclaimer note.



- 1
- 2 Use a clean microfiber cloth lightly dampened with water and clean the area with a gentle circular motion.

 **Important**

Never spray fluids directly on electrical components such as buttons or controls.

- 3 Let the material dry fully before use.

---

## 13.3.4. Cleaning mats

Clean the mats regularly and always make sure they are properly in place.

 **Important**

**Be gentle**

Never scrape or rub dirty surfaces. Instead, use gentle circular motions. Remember that sharp objects or abrasive materials can damage the vehicle.

- 1 Remove the mats for separate cleaning and access to the floor. Grasp the mat by the fastening pins and lift straight up.
- 2 Vacuum the mats and floor to remove loose dust and dirt. Do not shake or beat the mats to remove dust and dirt, as they can crack.
- 3 Clean the area with a neutral-colored, clean microfiber cloth that is lightly dampened with water or a colorless, mild cleaning agent. Use gentle circular motions.
- 4 Let the mat dry fully before putting it back. Secure it in place by pressing down near each pin.

 **Warning**

Only use one mat for each seat and make sure they are properly secured using all pins. If the driver's mat is not properly attached, it can move around and hinder driving by getting caught near or under the pedals.

---

## 13.4. Wheels and tires

The purpose of the tires is to carry your vehicle's load, ensure a good grip on the road surface, reduce vibration and protect the wheel rim from wear. Familiarize yourself with the recommendations to get the most

The content of this manual represents the status of the user manual at the time of printing and may not be completely valid in future instances. For more information refer to the first page for the complete disclaimer note.

out of your wheels and tires.

Familiarize yourself with tasks such as how to maintain the correct tire pressure and how to change tires so you are comfortable in these situations.

---

## 13.4.1. Wheel and tire recommendations

Volvo recommends that you only use wheel rims and tires that have been tested and approved by Volvo and are genuine Volvo accessories. A complete wheel refers to a tire mounted onto a wheel rim.

### Recommended tires

On delivery, the vehicle is equipped with Volvo original tires that have the VOL marking on their sides <sup>[1]</sup>. These tires are carefully adapted to the vehicle. It is therefore important to use new tires with this marking when you change tires, in order to maintain the vehicle's driving characteristics, comfort and electricity consumption.

### Original tires

Your vehicle is originally equipped with tires that match the data on the label found on the pillar by the driver door.

The tires have good road-holding properties and provide good driving characteristics on dry and wet road surfaces. Remember, however, that the tires have been developed to provide these properties on roads that are free from ice and snow.

Some vehicles are equipped with tire and rim combinations that offer with extra-high performance. They are designed to be capable on dry road surfaces and with resistance against aquaplaning. These may be more sensitive to damage on the road surface and, depending on conditions, may have a service life of less than 30,000 km (20,000 miles). Even if the vehicle is equipped with AWD or stability systems, these tires are not designed for winter driving and should be changed to winter tires as the weather requires.

All-season tires provide slightly better roadholding on slippery road surfaces than tires without the "all-season" classification. However, for good road-holding on icy or snow-covered roads, Volvo recommends winter tires on all four wheels.

### Tire age

Volvo recommends that tires should be changed after 6 years of normal use. Tires age and deteriorate over time, even if they are rarely or never used. The function can therefore be affected. This applies to all tires that are stored for future use. Heat caused by hot climates, frequently carrying heavy loads or exposure to ultraviolet (UV) radiation may accelerate the aging process. Cracks or discoloration are examples of external signs indicating that the tire is unsuitable for use. A tire that has visible signs of deterioration should be changed immediately.

When you replace your tires, it is important to use the newest tires possible. This is especially important with regard to winter tires. Use the tires' DOT <sup>[2]</sup> markings to determine how old your tires are.

### Replacing tires

Never swap the originally mounted wheels between the front and rear axles.

When you replace your tires, you must make sure that all four tires have the same size designation, are of the same type (radial), and are preferably from the same manufacturer as the original tires. Otherwise, there is a risk of changing the vehicle's road-holding properties and driving characteristics.

**The content of this manual represents the status of the user manual at the time of printing and may not be completely valid in future instances. For more information refer to the first page for the complete disclaimer note.**

The wheel must always rotate in the same direction throughout its lifespan.

If the wheels are mounted incorrectly, the vehicle's braking characteristics and capacity to deflect rain and slush are adversely affected.

## Wheel rims and tire sizes

### Warning

- Your Volvo's wheel rim and tire sizes are specified to meet stringent requirements for stability and driving characteristics. Unapproved combinations of wheel rim size and tire size may have a negative effect on vehicle stability and driving characteristics.
- Any damage caused by the mounting of unapproved combinations of wheel rim size and tire size are not covered by the new car warranty. Volvo accepts no liability for death, personal injury or any costs caused by such installations.
- Do not use steel or aluminum wheel rims that are damaged, cracked or deformed, that have extensive corrosion damage, or that have been welded or repaired.

<sup>[1]</sup> There may be deviations for certain tire dimensions.

<sup>[2]</sup> Department of Transportation

---

### 13.4.1.1. Tires and wheel storage

To keep them in good condition, you should always store wheels that are not in use in a cool, dry, dark place. It is important to position them correctly and avoid exposure to chemicals.

When not in use, it is important to store wheels away from direct sunlight, rain, water, heat sources or sparks. You should never store them near solvents, gasoline, oils or similar substances – especially flammable ones.

Store wheels <sup>[1]</sup> hung up or lying on their sides on the floor. Never hang up tires not installed on rims for storage. Be sure to store them standing upright or lying on their sides. If you hang up tires without their rims, they may become deformed.

<sup>[1]</sup> Tires installed on rims

---

### 13.4.1.2. Tire economy

To preserve your tires as much as possible, there are some things you should keep in mind.

- Correct tire pressure reduces uneven wear. It's important to check the pressure regularly.
- Hard acceleration, heavy braking and driving in a way which causes screeching tires lead to increased tire wear.
- Tire wear increases with speed.

**The content of this manual represents the status of the user manual at the time of printing and may not be completely valid in future instances. For more information refer to the first page for the complete disclaimer note.**

- Unbalanced wheels cause uneven and excessive tire wear and reduced ride comfort.
- Wheels must have the same direction of rotation during their entire service life.
- The rear tire grip should always be equal to or better than the front tire grip to reduce the risk of oversteering in case of heavy braking.
- Tires or wheel rims may be damaged permanently if you hit curbs or drive into deep holes.
- Driving style, road conditions and climate affect the tire wear.

## 13.4.2. Designations on tire sidewall

There are many digits, numbers and symbols that may be found on a tire's sidewall. Here are some examples and explanations of what they indicate.

### Note

Be aware that the following tire designations are only examples. Not all of these designations may be available for your tires, and there may be designations on your tires which are not included here.

## Tire dimensions

All tires have a designation of dimensions, such as: 265/40 R21 98 W

- 265** Tire width (mm).
- 40** Ratio between tire wall height and tire width (%).
- R** Radial ply. The designation RF and symbol specify that the vehicle is equipped with puncture-resistant tires.
- 21** Rim diameter (inches).
- 98** Codes for the maximum permitted tire load, Load Index.
- W** Speed rating for maximum permitted speed, Speed Symbol.

## Wheel rim dimensions

All wheel rims have a designation of dimensions, such as: 8J x 19 x 50

- 8** Rim width (inches).
- J** Rim flange profile.
- 19** Rim diameter (inches).
- 50** Offset in mm (distance from wheel center to wheel contact surface against the hub).

## Weather condition classification

Here are some classification examples. Weather capabilities can also be defined with certain symbols.

- M+S or M/S** Mud and Snow.
- AT** All Terrain.
- AS** All Season.

## Tire age

**DOT YLX2 0819** Tire Identification Number or TIN. This information helps the tire manufacturer identify tires in the event of safety recalls.

1. DOT<sup>[1]</sup>
2. The first two characters are the code for the plant where the tire was manufactured.
3. The next two characters are the tire's size code.
4. The last four digits specify the week and year the tire was manufactured. For example, 0819 means that the tire was manufactured during week 08, year 2019.

Any numbers or letters shown in between are market codes chosen by the manufacturer.

## Max load and pressure

**Max load 685 kg (1610 lbs)** Specifies the maximum load that the tire can carry.

**Max pressure 240 kPa (35 psi)** The maximum tire pressure that the tire should ever be subjected to. This limit is specified by the tire manufacturer.

## Minimum permitted load index and speed rating

The tire load index and speed rating might not be shown on the sidewall as this is not a legal requirement.

## Type, materials and tire rotation

|  |  |
|--|--|
| <b>P</b>   | Indicates that the tire is for passenger vehicles.   |
| <b>VOL</b>   | Volvo original tires.  |
| <b>Plies: Tread 2 polyester, 2 steel, 1 polyamide. Sidewall 2 polyester.</b> | States the number of cord layers or number of layers with rubber-coated fabric in the tire's tread and sidewall. The tire manufacturers must also state the layer materials used in the tire and sidewall, which may be steel, nylon, polyester and certain other materials. |
| <b>Arrow symbol</b>  | Tires with a tread pattern designed to only turn in one direction have the direction of rotation marked with an arrow.   |

## Classification of uniform tire quality

|                             |  |
|-----------------------------|--|
| <b>Tread wear grade 200</b> | The tread wear grade is a comparative rating based on the wear rate of the tire in a standardized test. A higher value is better.  |
| <b>Traction grade AA</b>    | The traction grade is based on standardized straight-ahead braking traction tests. The traction grades, from highest to lowest, are AA, A, B and C.                            |
| <b>Temperature grade A</b>  | The temperature grade reflects the thermal performance of a tire that is properly inflated and not overloaded. The temperature grades, from highest to lowest, are A, B and C. |

## From the Consumer Guide to Uniform Tire Quality Grading

The purpose of this section is to aid the consumer in making an informed choice in the purchase of passenger vehicle tires.

All passenger vehicle tires must meet federal safety requirements apart from this classification.

Tread wear

The tread wear grade is a comparative rating based on the wear rate of the tire when tested under controlled conditions on a specified government test course. For example, a tire graded 150 would wear one and one-half (1 1/2) times as well on the government course as a tire graded 100. The relative performance of tires depends upon the actual conditions of their use, however,

and may depart significantly from the norm due to variations in driving habits, service practices and differences in road characteristics and climate.

#### Traction

The traction grades, from highest to lowest, are AA, A, B, and C. Those grades represent the tire's ability to stop on wet pavement as measured under controlled conditions on specified government test surfaces of asphalt and concrete. A tire marked C may have poor traction performance. Warning: The traction grade assigned to this tire is based on straight-ahead braking traction tests, and does not include acceleration, cornering, hydroplaning, or peak traction characteristics.

#### Temperature

The temperature grades are A (the highest), B, and C, representing the tire's resistance to the generation of heat and its ability to dissipate heat when tested under controlled conditions on a specified indoor laboratory test wheel. Sustained high temperature can cause the material of the tire to degenerate and reduce tire life, and excessive temperature can lead to sudden tire failure. The grade C corresponds to a level of performance that all passenger vehicle tires must meet under the Federal Motor Safety Standard No. 109. Grades B and A represent higher levels of performance on the laboratory test wheel than the minimum required by law. Warning: The temperature grade for this tire is established for a tire that is properly inflated and not overloaded. Excessive speed, underinflation, or excessive loading, either separately or in combination, can cause heat buildup and possible tire failure.

<sup>[1]</sup> Department of Transportation

---

## 13.4.2.1. Tire tread wear indicators

There are tread wear indicators to show the status of the tire's tread depth.



The narrow grooves that run lengthwise across the tire's tread pattern are tread wear indicators. On the side of the tire are the letters TWI <sup>[1]</sup>.

### ! Important

- Tires should be changed before wearing them down to the tread wear indicators to avoid poor traction in rain and snow.
- Volvo recommends that winter tires have a greater tread depth than 3 millimeters (1/8 inch) and summer tires 1.6 millimeters (1/16 inch).

<sup>[1]</sup> Tread Wear Indicator

## 13.4.3. Changing wheels

If you need to change a wheel, it's important to follow the recommended procedure.

### ⚠ Warning

#### Raising the vehicle to change a wheel

Changing a wheel requires that you raise the wheel off the ground. Carefully follow the separate instructions for raising the vehicle safely.

- If you are changing the wheel in or close to traffic, make sure you and the vehicle are clearly visible to others. Activate the hazard warning lights and put out a warning triangle in a visible but safe place.
- Designate a safe space for passengers to wait, away from both the vehicle and traffic.
- You are responsible for safety around the vehicle while it is raised. Do not allow people inside or close to the vehicle.
- Never get under the vehicle or let anyone reach under it with any part of their body while it is raised with a jack.

## Before removing the wheel

The wheels on your vehicle are fastened with wheel bolts. For extra security, you can use lockable bolts.

### Important

- Make sure that the dimensions of the replacement wheel are approved for your vehicle.<sup>[1]</sup>
- Make sure you read through all the instructions before you start. Get all the tools you need before the vehicle is raised.<sup>[2]</sup>

### Removing the wheel

- 1 Remove the wheel fastener cap.
- 2 While your vehicle is still on the ground, use the wheel wrench to loosen the wheel fasteners approximately 0.5-1 turn. Press the wrench downwards while the wrench is extended to the left to avoid personal injury. The counterclockwise rotation loosens the fastener. If you have fasteners that are lockable bolts, start with them.
- 3 Follow the instructions on how to safely raise the vehicle.
- 4 Raise the vehicle high enough so that the wheel you want to remove is off the ground. Remove the fasteners and lift off the wheel.

### Tip

When switching wheels between winter and summer, mark which side they were mounted on, for example L for left and R for right.

### Mounting the wheel

- 5 Clean the surfaces between the wheel and hub.
- 6 Mount the wheel. Make sure you tighten the fasteners. However, the final tightening to the specified torque is done when the wheel is back on the ground and unable to rotate while you do it.

### Warning

- Make sure that you put the wheels on the correct axle. Incorrectly mounted wheels can affect the vehicle's handling.
- Never use lubricant on the wheel fastener threads. This could cause the wheel fasteners to loosen after tightening.

- 7 Lower the vehicle back to the ground.
  - When on the ground, the wheel can't rotate, making final tightening easier.
- 8 Fasten the fasteners crosswise. If the vehicle is equipped with lockable bolts, finish with those. It's very important that the fasteners are properly secured. Tighten to 140 Nm (103 lb-ft). Check the tightening torque with a torque wrench. Over-



tightened or loosely tightened fasteners may damage the fastening threads or the wheel itself.

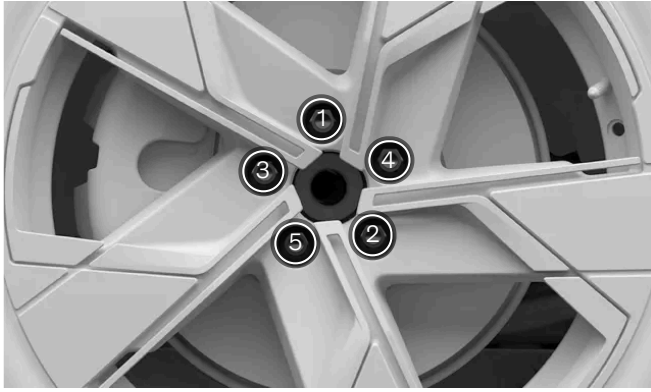

Tighten the wheel fasteners crosswise.

- 9 Place the wheel fastener cover back over the fasteners, using the guide markers to position it correctly, then press it into place. Ensure that it's securely fastened.

 **Warning**

#### Check the wheel fasteners

The wheel fasteners may need to be re-tightened a few days after the wheel has been changed. Temperature differences and vibrations may cause them to loosen.

#### Wheel properties after a wheel change

Be attentive to signs of incorrectly mounted wheels. This could affect the vehicle's braking characteristics and the ability to deflect rain and slush.

When you have changed the type or size of the wheels, you should drive carefully at first. The dynamics and driving characteristics of the wheels may have changed.

<sup>[1]</sup> Some spare wheels have different dimensions. If your vehicle is approved for the spare wheel you intend to use, the difference in dimensions is okay.

<sup>[2]</sup> Use tools that are designed for your vehicle model.

## 13.4.3.1. Spare wheel

If you get a flat tire, a spare wheel<sup>[1]</sup> can be temporarily used until the original wheel can be replaced or repaired.

The spare wheel is only designed for temporary use. You should replace the spare wheel with an ordinary wheel as soon as possible.

When not in use, you should store the spare wheel in a bag on the floor of the trunk. It must be secured by a strap attached to the vehicle's load-retaining eyelets.

 **Warning**

### Before driving with a spare wheel

- Only use a spare wheel that is approved for your vehicle.
- Never drive your vehicle with more than one spare wheel mounted.
- Snow chains cannot be used if the spare wheel is mounted on the front axle.
- The spare wheel should never be repaired.
- Make sure to follow the spare wheel manufacturer's recommendations regarding tire pressure.

### Driving with a spare wheel

- Never drive faster than 80 km/h (50 mph) when a spare wheel is mounted on your vehicle.
- Current laws prevents the use of the temporary spare wheel for anything other than as a temporary replacement for a punctured tire.
- Your vehicle's driving characteristics may be affected by using a spare wheel. It is important to replace the spare wheel with an original wheel as soon as possible.

 **Important**

The spare wheel is smaller than your vehicle's original wheels. This will affect the vehicle's ground clearance. Pay attention to high curbs, and don't wash your vehicle in an automatic car wash.

 **Note**

While a spare wheel is used, the tire pressure monitoring system might not work correctly.  
If the spare wheel is damaged, a new one can be purchased from a Volvo retailer.

<sup>[1]</sup> The spare wheel must be of the Temporary Spare type.

## 13.4.3.2. Winter tires

Winter tires are designed for driving in road conditions with ice and snow. Winter tire tread depth should be deeper than that of regular tires.

### Dimensions

When driving with winter tires, it's important that all four tires are of the correct type. Contact a Volvo retailer for advice.

### Studded tires

The content of this manual represents the status of the user manual at the time of printing and may not be completely valid in future instances. For more information refer to the first page for the complete disclaimer note.

Studded winter tires should be run-in gently for 500-1,000 km (300-600 miles) so that the studs settle properly into the tires. This gives the tire, and especially the studs, a longer service life.

 **Note**

Legal regulations regarding the use of studded tires may vary. Make sure the tires you have mounted are in full compliance with local regulations and laws.

## Tread depth

Road conditions with ice, slush, snow and low temperatures put higher demands on your tires than summer conditions. Volvo recommends that winter tires have a tread depth of at least 4 millimeters (0.15 inch).

 **Note**

### Speed rating

Winter tires<sup>[1]</sup> are allowed to have a lower speed rating than your vehicle's top speed. However, if your winter tires do have a lower speed rating than your vehicle's top speed, you are not allowed to drive faster than tire speed rating.

<sup>[1]</sup> Both studded and stud-free tires.

---

## 13.4.3.3. Using snow chains

Using snow chains can help to improve traction in winter conditions. However, there are some restrictions you have to keep in mind.

 **Warning**

You can use snow on your vehicle, with the following restrictions:

- Use genuine Volvo snow chains or equivalent chains designed for the vehicle model, tire and wheel rim dimensions.
- Only single-sided snow chains are permitted.
- The wrong snow chains may cause serious damage to the vehicle and lead to an accident.

 **Note**

Using snow chains may result in malfunction of the tire pressure monitoring system.

### Mounting snow chains

- Make sure you are in a safe place when mounting or removing the snow chains.
- Always comply with local regulations and laws regarding the use of snow chains.
- Always carefully follow the mounting instructions from the manufacturer.
- Always use the same type of chain on the left- and right-hand tires.
- Volvo recommends that you do not use snow chains on wheel dimensions greater than 18 inches.
- Make sure you use the correct size in relation to the wheels.
- Snow chains must only be used on the rear wheels.<sup>[1]</sup>
- If wheels of a different size than the original wheels are mounted, certain snow chains must not be used.
- There needs to be sufficient distance between the chains and the vehicle's brakes, suspension and body components. Chains that risk interfering with brake components must not be used.
- If you need to move your vehicle while installing or removing chains, do not let the wheels run over the chain attachments.
- Amount the chains tensioned as tightly as possible and on them at regular intervals.



Tip

Practice mounting the snow chains before winter comes.

#### Driving with snow chains

- Once the snow chains are mounted, drive about 200 meters (650 feet). Then stop the vehicle and check again that the chains are firmly attached.
- Never exceed the chain manufacturer's specified speed limit. You must never exceed 50 km/h (30 mph) under any circumstances.
- While snow chains improve grip in certain conditions, they negatively affect other driving characteristics. If possible, avoid driving over uneven ground, such as bumps or holes. Also avoid fast or sharp turns and hard braking.
- Avoid driving on ground not covered in snow or ice, as this wears out both the snow chains and the wheels.

Contact a Volvo retailer for more information.

<sup>[1]</sup> This also applies to all-wheel drive vehicles.

## 13.4.4. Punctures

If you experience a punctured tire, there are several actions you can take to recover safely, especially if it happens while you are driving.

If the puncture occurs while you are driving, it's important to think about safety first. Activate the hazard warning flashers and, if possible, move the vehicle away from immediate danger. If necessary, call roadside assistance.

 **Warning**

- Do not drive the vehicle if it has a flat tire. It is not safe and will damage the vehicle.
- If possible, exit your vehicle from the side with the least traffic to avoid causing an accident.
- Place a warning triangle so that others are warned of your vehicle well in advance of passing. Remember to first put on a reflective vest if you have one.

 **Tip**

If your vehicle is equipped with a temporary puncture repair kit, be sure to read its instructions before you use it.

## 13.4.4.1. Temporary puncture repair

A temporary puncture repair kit<sup>[1]</sup> can be used to repair a minor tire puncture. The kit includes a bottle of sealant fluid and a compressor.

 **Warning**

Read through all the instructions before using the repair kit.

You should not drive faster than 80 km/h (50 mph) after the repair kit has been used on your tires.



Temporary puncture repair kit

### Compressor

The compressor is intended to be used for temporary tire repair. You can also use the compressor to check and adjust the tire pressure on your original tires when needed.

The compressor is an electrical device. When it's time to dispose of it, be sure to follow local regulations related to waste management.

## Sealant fluid

The sealant fluid works as a temporary repair. It is effective at sealing a tread puncture but should not be used to seal a puncture in the sidewall of the tire. If the tire has larger slits, cracks or similar damage, you should not use the sealant to repair it.

The bottle of sealant fluid needs to be replaced if the expiration date has passed. The old bottle is considered hazardous waste.

<sup>[1]</sup> It's also called temporary mobility kit or TMK.

---

### 13.4.4.1.1. Using the temporary puncture repair kit





When using the temporary puncture repair kit, there are a number of important steps you need to follow. Make sure you read and understand each step before proceeding.

#### Note

These instructions apply to the temporary puncture repair kit supplied by Volvo.



Overview of the temporary puncture repair kit compressor

-  Pressure-reducing valve
-  Pressure gauge
-  Air hose
-  Power switch

⑤ Electrical cable



Overview of the temporary puncture repair kit sealing fluid bottle

① Sealing fluid hose

② Air hose connector

 **Warning**

**Sealing fluid can be harmful**

The sealing fluid contains substances that are harmful if swallowed. The contents can also cause allergic reactions or be otherwise harmful to the respiratory tract, the skin, the central nervous system and the eyes.

Precautions

- Store the kit out of reach of children.
- Avoid prolonged or repeated contact with the skin. If you get sealing fluid on your clothes, remove them.
- Wash hands thoroughly after handling.

First aid

- Ingestion: Do not induce vomiting unless directed to do so by medical personnel. Get medical attention.
- Skin: Wash affected areas of skin with soap and water. Get medical attention if symptoms occur.
- Eyes: Flush with plenty of water for least 15 minutes, occasionally lifting the upper and lower eyelids. Get medical attention if symptoms occur.
- Inhalation: Move the exposed person to fresh air. If irritation persists, get medical attention.

- Make sure the compressor power button is in the off position before starting.
- Don't remove the air hose or sealing fluid hose during repair.
- If the puncture was caused by a nail or similar and it's still in the tire, leave it in. This helps to seal the puncture.
- If the repair is carried out in an area where there might be other vehicles, activate the hazard warning flashers and use a warning triangle, if you have one.

## Preparations



Screw the air hose to the sealing fluid bottle. There's a place for it opposite the sealing fluid hose.

- 2 Unscrew the tire valve cap and attach the sealing fluid hose. Screw the hose connector as far down the thread as possible.

### Begin puncture repairs

- 3 Connect the compressor to the vehicle's 12 V outlet and ensure that the outlet works and is supplying current.<sup>[1]</sup>
- 4 Start the compressor by pressing the power button.

#### **Warning**

Never stand next to the tire while the compressor is on. If cracks or bumps appear, the compressor must be turned off immediately. Stop and contact Volvo Assistance for safe recovery.

#### **Note**

Avoid placing the compressor in water, directly on sand or on very dusty ground, as this may cause the compressor to malfunction.

- 5 Inflate the tire until the pressure is greater than 1.8 bar (26 psi).
- 6 Shut the compressor off to check the pressure on the pressure gauge. Minimum pressure is 1.8 bar (26 psi) and maximum is 2.8 bar (39 psi). Use the pressure-reducing valve if the pressure is too high.

#### **Warning**

If the pressure is below 1.8 bar (26 psi), the hole in the tire is too big. Do not continue and contact Volvo Assistance for safe recovery.

- 7 Unplug the compressor from the 12 V socket.
- 8 Unscrew the sealing fluid hose from the tire.
- 9 Replace the tire valve cap.
- 10 As soon as possible, drive for 10 minutes<sup>[2]</sup> at a maximum speed of 60 km/h (37 mph) and let the fluid seal the tire. After that, perform a follow-up check.

### Follow-up check

The content of this manual represents the status of the user manual at the time of printing and may not be completely valid in future instances. For more information refer to the first page for the complete disclaimer note.



**11** Connect the air hose to the tire air valve.

**12** Check the tire pressure on the compressor's pressure gauge.

- • If the pressure is below 1.3 bar (19 psi), the tire is insufficiently sealed. Stop and contact Volvo Assistance for safe recovery.
- If the pressure is higher than 1.3 bar (19 psi) but below 1.8 bar (26 psi), the tire must be inflated to a minimum pressure of 1.8 bar (26 psi) and a maximum pressure of 2.8 bar (39 psi). Connect the compressor to the 12 V outlet and inflate the tire. Release air using the pressure-reducing valve if the tire pressure is too high. Then repeat step 10.
- If the pressure is between 1.8 bar (26 psi) and 2.8 bar (39 psi), you can drive at a maximum speed of 80 km/h (50 mph).

**13** Replace the tire valve cap.

- Replace the sealing fluid bottle and hose after use. Contact a Volvo retailer to do so.
- Volvo recommends replacing or repairing the damaged tire as soon as possible. Inform the workshop that the tire contains sealing fluid.



**Warning**

Maximum mileage with tires containing sealing fluid is 200 km (125 miles).

<sup>[1]</sup> The outlet no longer supplies power for a while after the driver has exited of the vehicle. To resume power, just get back in the vehicle again.

<sup>[2]</sup> Or 5 kilometers (3 miles)

---

## 13.4.4.1.2. Inflating tires with the puncture repair compressor

Your vehicle's tires can be inflated with the compressor that is included in the temporary puncture repair kit.

Make sure the compressor power button is in the off position before starting.

- 1** Unscrew the tire valve cap and attach the compressor air hose. Screw the air hose connector as far down on the thread as possible.
- 2** Connect the compressor to the vehicle's 12 V outlet and ensure that the outlet works and is supplying current.<sup>[1]</sup>
- 3** Start the compressor by pressing the power button.

 **Important**

To avoid overheating, do not run the compressor for more than 10 minutes at a time.

- 4 Check the tire pressure on the compressor's pressure gauge<sup>[2]</sup>. Use the pressure-reducing valve if the pressure is too high.
- 5 Turn off the compressor and unplug it from the 12 V socket.
- 6 Unscrew the air hose from the tire.
- 7 Replace the tire valve cap<sup>[3]</sup>.

Return the kit to its storage location.

<sup>[1]</sup> The outlet no longer supplies power a while after the driver has got out of the vehicle. To resume power, just get back in the vehicle again.

<sup>[2]</sup> You can find the recommended tire pressure for the vehicle's original tires on a label on the driver side door pillar.

<sup>[3]</sup> Only use original Volvo dust caps or plastic dust caps.

---

## 13.4.5. Tire pressure

Correct tire pressure helps to improve driving stability, lower energy consumption and extend the lifespan of the tire.

Over time, tire pressure decreases. Pressure also varies depending on environmental conditions. All of this is normal. However, if you drive with the wrong tire pressure, the tires may overheat and become damaged. Tire pressure affects ride comfort, noise levels and handling characteristics.

Make it a habit to check the tire pressure monthly and before longer trips. Always make sure you use a reliable pressure gauge. To keep the tires in good shape, use the recommended tire pressure for cold tires.

 **Warning**

If the tire pressure is too high or too low, the tires can sustain severe damage. The tires can explode while you are driving, causing you to lose control of the vehicle.

 **Tip**

Maintaining the correct tire pressure will help you take advantage of your vehicle's full load capacity.

## 13.4.5.1. Tire pressure monitoring

Your vehicle can detect and indicate if the tire pressure is too low. Tire pressure monitoring cannot be disabled. If the system is unable to detect low tire pressure, it will indicate that there's a malfunction.

For the tire pressure monitoring system to provide updated information, you need to drive the vehicle above 35 km/h (22 mph) for several minutes.



An indicator symbol lights up if a low tire pressure is detected in any of the tires. It will stay illuminated until the problem is resolved.

In addition to messages in the display, you can also find information about the tire pressure monitoring in the vehicle status view.



### No advance warning possible

The system cannot give you any advance warning of potential tire damage.

### Ensure correct tire pressure immediately

When the low tire pressure symbol is lit, stop and check the tire pressures as soon as possible. Driving with under-inflated tires can cause tire failure.

If you experience a malfunction or a fault is permanently indicated for the tire pressure monitoring system, service is required. [\[1\]](#)

Remember:

- The system does not replace the need for regular tire inspection and maintenance.
- The low tire pressure symbol won't disappear until the low tire pressure has been corrected.
- When you change wheels or loads, you should store a new tire pressure reference value.



Tire pressure monitoring sensors need to be mounted on all wheels, including winter tires. If you use a spare tire or another wheel without a sensor, a fault message will appear in the driver information area after a few minutes of driving. Remember to make sure that new wheels have the sensor to avoid a system malfunction warning.

## System description

The following information is phrased according to external legal requirements.

Each tire, including the spare (if provided), should be checked monthly when cold and inflated to the inflation pressure recommended by the vehicle manufacturer on the vehicle placard or tire inflation pressure label. (If your vehicle has tires of a different

size than the size indicated on the vehicle placard or tire inflation pressure label, you should determine the proper tire inflation pressure for those tires.)

As an added safety feature, your vehicle has been equipped with a tire pressure monitoring system (TPMS) that illuminates a low tire pressure telltale when one or more of your tires is significantly underinflated. Accordingly, when the low tire pressure telltale illuminates, you should stop and check your tires as soon as possible, and inflate them to the proper pressure. Driving on a significantly under-inflated tire causes the tire to overheat and can lead to tire failure. Under-inflation also reduces fuel efficiency and tire tread life, and may affect the vehicle's handling and stopping ability.

Please note that the TPMS is not a substitute for proper tire maintenance, and it is the driver's responsibility to maintain correct tire pressure, even if under-inflation has not reached the level to trigger illumination of the TPMS low tire pressure telltale.

Your vehicle has also been equipped with a TPMS malfunction indicator to indicate when the system is not operating properly. The TPMS malfunction indicator is combined with the low tire pressure telltale. When the system detects a malfunction, the telltale will flash for approximately one minute and then remain continuously illuminated. This sequence will continue upon subsequent vehicle start-ups as long as the malfunction exists. When the malfunction indicator is illuminated, the system may not be able to detect or signal low tire pressure as intended. TPMS malfunctions may occur for a variety of reasons, including the installation of replacement or alternate tires or wheels on the vehicle that prevent the TPMS from functioning properly. Always check the TPMS malfunction telltale after replacing one or more tires or wheels on your vehicle to ensure that the replacement or alternate tires and wheels allow the TPMS to continue to function properly.

<sup>[1]</sup> Volvo recommends that you visit an authorized Volvo workshop for any repair or service needs.

---

### 13.4.5.1.1. Limitations of tire pressure monitoring

There are some circumstances in which the tire pressure monitoring may not function correctly. Be sure to familiarize yourself with them to understand the system's limitations.

Tire pressure monitoring can be negatively affected by:

- incompatible rims or tires
- wheel modifications
- injected liquids such as tire sealing fluid
- snow chains
- accessories that interfere with the system's wireless transmission or the vehicle's electrical system
- staying close to sources of strong radio waves or electrical fields. A few examples of locations that may cause this type of interference are gas stations, airports and TV stations.

If the vehicle detects a fault with the system, it is indicated in the display.

---

### 13.4.5.2. Adjusting tire pressure

The tire pressure needs to be adjusted if you're planning to drive with a heavy load or at high speeds for prolonged periods. It's also normal for tire pressure to decrease over time. Adjusting it so you have the

correct pressure for the current situation helps ensure even tire wear and high performance.

The tires need to be at ambient temperature when the pressure is checked and adjusted. This is referred to as having cold tires. Never release air from a warm tire. When it cools down, the internal air pressure drops, which can lead to underinflated or even entirely deflated tires.

The tires can warm up very quickly and should be considered warm if driven for more than approximately 1.5 km (1 mile). They often need about 3 hours of cooling down before reaching ambient temperature again.

- 1 Remove the tire valve's valve cap and then press the tire pressure gauge firmly onto the valve.
- 2 Check the gauge to see the current tire pressure.
- 3 If the pressure is low, inflate the tire to the correct pressure. The recommended pressure for factory-mounted tires is shown on the door pillar on the driver's side.
- 4 Refit the valve cap<sup>[1]</sup> to avoid damage to the valve.
- 5 Inspect the tire for stuck debris, such as nails or other objects, that could puncture the tire.
- 6 Check the sidewalls for any cavities, cuts, bumps or other irregularities.

If you accidentally over-inflate the tire, press the metal pin in the middle of the valve to let out the excess air. Then check the pressure again.

**Note**

Spare wheels may have recommended pressures that are different from those of the original tires. Always use the pressure recommended by the spare wheel manufacturer.

**Tip**

You can use the compressor from the temporary puncture repair kit to check and adjust the tire pressure on your original tires when needed.

<sup>[1]</sup> Only use original Volvo dust caps or plastic ones, as metal dust caps may corrode and stick to the valve.

## 13.4.6. Tire terminology

The following is a list of tire-related terminology.

**Tire information placard** A plate that specifies OE<sup>[1]</sup> tire size, recommended tire pressure and the maximum weight the vehicle can carry.

**Tire identification number (TIN)** A number on the sidewall of each tire with information about tire brand and manufacturing plant, tire size and date of manufacture.

**The content of this manual represents the status of the user manual at the time of printing and may not be completely valid in future instances. For more information refer to the first page for the complete disclaimer note.**

|   |  |
|---|--|
| <b>Inflation pressure</b>                     | A measurement of how much air is in the tire.  |
| <b>Standard load</b>                          | A class of P-metric or metric tires designed for a maximum load at 35 psi <sup>[2]</sup> . The load-bearing capacity of the tires does not increase if the tire pressure is increased above this pressure.             |
| <b>Extra load</b>                             | A class of P-metric or metric tires designed for a heavier maximum load at 41 psi <sup>[3]</sup> . The load-bearing capacity of the tires does not increase if the tire pressure is increased above this pressure.     |
| <b>kPa</b>                                    | Kilopascal, a metric unit for air pressure.  |
| <b>psi</b>                                    | Pounds per square inch, a standard unit for air pressure.  |
| <b>B-pillar</b>                               | The beam on the side of the vehicle behind the driver's door.  |
| <b>Bead area of the tire</b>                  | The tire's surface area next to the wheel rim.   |
| <b>Sidewall of the tire</b>                   | The surface between the base of the tire and the tread.  |
| <b>Tread area of the tire</b>                 | The surface around the tire in contact with the road when the tire is installed on the vehicle.  |
| <b>Rim</b>                                    | Metal support (wheel) for a tire or tire and inner tube unit against which the base of the tire seals.   |
| <b>Maximum load rating</b>                    | A figure that specifies the maximum load in pounds and kilograms that the tire can carry. This classification is made by the tire manufacturer.  |
| <b>Maximum permissible inflation pressure</b> | The maximum tire pressure that the tire should ever be subjected to. This limit is specified by the tire manufacturer.   |
| <b>Recommended tire inflation pressure</b>    | Tire pressure, specified by Volvo, based on the type of tires installed on a vehicle on delivery. This information is available on the tire plate on the B-pillar on the driver's side and in the tire pressure table. |
| <b>Cold tires</b>                             | Tires are considered cold when they have the same temperature as the surrounding air. This temperature is normally reached when the vehicle has been parked for at least three hours.                                  |

<sup>[1]</sup> Original Equipment

<sup>[2]</sup> 37 psi or 2.5 bar for metric tires

<sup>[3]</sup> 43 psi or 2.9 bar for metric tires

## 13.5. Vehicle electrical system and batteries

Your vehicle has a specialized electrical system that delivers electricity to and from the batteries. There are both high-voltage and low-voltage circuits for different electrical functions.

This section of the manual presents information about several of its electrical components. These include:

- Traction battery
- 12 V battery
- Emergency 12 V supply terminal
- Fuses

 **Important**

## 12 V terminal

In the event of a total loss of power, the vehicle can't be unlocked, as the locks are electrically operated. To access the vehicle and charge it, the vehicle can be powered for a short time using the externally accessible 12 V terminal. It can be accessed by removing a small panel below the front bumper, near the front left wheel.

Before any use of the 12 V terminal, consider the following:

- Volvo recommends that the 12 V terminal only be used by service technicians for the purpose of accessing the vehicle as part of immobilization recovery.
- The external 12 V terminal on your vehicle should only be used to make your vehicle accessible. Do not attempt to charge another vehicle or similar external source from this point.
- Only use a 12 V charger with a maximum charging current of less than 40 A.
- Connecting any power source that delivers current higher than 40 A will blow the terminal's fuse, thereby disabling it.
- Only use the 12 V terminal for short amounts of time. This is not meant as a way of powering the vehicle continuously.
- Make sure to follow the positive and negative markings on the terminals – reversing the polarity of the low-voltage system could lead to damaging the low-voltage system components or blowing the 40 A fuse.

 **Tip**

## Vehicle charging

Features and equipment related to charging, such as the charging port and cables, have their own section.

## Convenience features

Power-related features, such as USB ports and wireless device charging, are covered in other sections.

 **Warning**

- Do not handle or modify the vehicle's electrical components. Only perform actions that are clearly described in the user manual.
- High-voltage components can produce or conduct lethal currents and must only be handled by authorized technicians.
- Do not perform repairs on the vehicle's electrical system or components. Contact an authorized Volvo workshop for any required repairs or servicing.

## 13.5.1. Traction battery

The traction battery is the central energy and power source for your vehicle. It powers all electric propulsion and indirectly powers the rest of the vehicle by keeping the smaller 12 V battery charged.

**The content of this manual represents the status of the user manual at the time of printing and may not be completely valid in future instances. For more information refer to the first page for the complete disclaimer note.**

The traction battery sits low in the underbody of the vehicle.

## Battery care and health

How you use your vehicle affects the traction battery's condition. Over time its capacity decreases. There are recommended user practices that can help extend the battery's service life. These user practices cover events and conditions that can cause battery damage.

### Important

Leaving the vehicle with a low battery level can lead to battery damage. Make sure to charge the vehicle as soon as possible if the battery level is near empty.

### Tip

There are separate sections in this manual about battery health and what you can do to recover from a low-power scenario.

## Battery service and maintenance

The traction battery is a high-voltage component that only authorized technicians are equipped to service safely.

### Warning

- Do not handle or modify the vehicle's electrical components. Only perform actions that are clearly described in the user manual.
- High-voltage components can produce or conduct lethal currents and must only be handled by authorized technicians.
- Do not perform repairs on the vehicle's electrical system or components. Contact an authorized Volvo workshop for any required repairs or servicing.

### 13.5.1.1. Managing battery health and performance

There are user practices that can help maintain the traction battery's condition and performance over time. Some scenarios can lead to battery damage and should always be avoided.

#### Low battery level and discharged battery



 **Important**

The traction battery can sustain severe damage if it is not charged after the battery level reaches 0%. The vehicle draws a small amount of power when parked. This means that leaving the vehicle with a low battery level without charging can lead to a discharged battery and battery damage. If the battery level is below 20% when parked, it is recommended that you connect the vehicle for charging as soon as possible.

If the battery level reaches 0%, the battery is considered discharged or empty. The vehicle then needs to be charged as soon as possible to reduce the risk of battery damage.

The smaller 12 V battery is also at risk of going flat if the traction battery can't supply it with power. If both batteries have gone flat, the vehicle will have no power at all and no ability to initiate charging.

## High state of charge

 **Important**

The traction battery can sustain damage if the vehicle's battery level is kept very high for a long period of time.

If you are leaving the vehicle plugged in for charging without any immediate plans to drive it, select the target battery level recommended in the vehicle's charging view.

## Charging habits

AC charging is the recommended charging mode for everyday charging. This helps maintain the condition of the battery over time. DC charging causes more wear.

You can set a target battery level by selecting a value in the charging view. This will help you to maintain good charging performance and battery longevity.

## Long-term parking

When leaving your vehicle parked for longer than one month, the recommended battery level is 40-60%. Use or charge the vehicle to reach the recommended level.

If you are leaving the vehicle parked for longer than three months, it's recommended to keep it plugged in but set the battery charging limit to 50%. This is for better battery health.

Regularly check the battery level and make sure that charging is working.

 **Tip**

There is a separate section in this manual with more recommendations for long-term parking.

## Parking in hot weather

 **Important**

Avoid exposing the vehicle to extreme temperatures. Avoid leaving the vehicle parked for longer than 24 hours if there is a possibility that the temperature could reach 55 °C (131 °F).

When it is warm out, you should plug the vehicle in while it is parked. High temperatures cause battery damage, especially when the vehicle is exposed to hot weather for prolonged periods. The car can actively cool the battery while it's parked, but that uses energy. When you return to your parked vehicle, the battery level may be noticeably lower than before. If the vehicle is plugged in for charging, it can cool the battery without lowering the battery level and risking a discharged battery.

In hot temperatures, it is recommended that you park in a shaded spot. Strong sunlight combined with high temperatures can lead to very high battery temperatures and excessive cooling needs.

## Parking in cold weather

When the battery is cold, the vehicle temporarily reduces battery performance until it has warmed up. Driving the vehicle in a state of reduced performance doesn't harm the battery.

To avoid temporarily reduced performance from a cold battery, connect the vehicle for charging and activate the vehicle's preconditioning prior to your trip. The vehicle can then heat the battery without affecting performance and available range.

If temperatures are below -30 °C (-22 °F), avoid leaving the vehicle parked without charging for longer than 24 hours.

---

## 13.5.1.2. Powertrain cooling system

Your vehicle has an advanced temperature regulation system.

The system actively regulates the temperature of the traction battery while you're parked, charging or driving your vehicle. This happens if your vehicle experiences high or low temperatures and during preconditioning.

 **Important**

Never attempt to add coolant yourself.

The cooling system is a closed system. A trained technician must perform any required maintenance of the cooling system.<sup>[1]</sup>

<sup>[1]</sup> Volvo recommends an authorized Volvo workshop.

---

## 13.5.2. 12 V battery

The 12 V battery powers everything in your vehicle except the electric propulsion.

## Servicing and replacement

The 12 V battery is maintenance-free.

Contact an authorized Volvo workshop if the 12 V battery needs to be replaced.

### Important

#### 12 V terminal

In the event of a total loss of power, your vehicle can't be unlocked as the locks are electrically operated. To access your vehicle and charge it, it can be powered for a short time using the externally accessible 12 V terminal. The terminal can be accessed by removing a small panel below the front bumper, near the front left wheel.

Before any use of the 12 V terminal, consider the following:

- Volvo recommends that the 12 V terminal only be used by service technicians for the purpose of accessing the vehicle as part of immobilization recovery.
- The external 12 V terminal on your vehicle should only be used to make your vehicle accessible. Do not attempt to charge another vehicle or similar external source from this point.
- Only use a 12 V charger with a maximum charging current of less than 40 A.
- Connecting any power source that delivers current higher than 40 A will blow the terminal's fuse, thereby disabling it.
- Only use the 12 V terminal for short amounts of time. This is not meant as a way of powering the vehicle continuously.
- Make sure to follow the positive and negative markings on the terminals – reversing the polarity of the low-voltage system could lead to damaging the low-voltage system components or blowing the 40 A fuse.

12 V battery specifications

|                                      |  |
|--------------------------------------|--|
| Battery type                         | AGM H4   |
| Voltage                              | 12 V   |
| Dimensions (length × width × height) | 207 × 175 × 190 mm (8 <sup>5</sup> / <sub>32</sub> × 6 <sup>57</sup> / <sub>64</sub> × 7 <sup>31</sup> / <sub>64</sub> in) |
| Capacity                             | 50 Ah  |
| Cold start capacity <sup>[1]</sup>   | 540 A  |

<sup>[1]</sup> CCA

### 13.5.2.1. Battery labels

Low-voltage vehicle batteries have labels containing information for safe handling.

## Symbols



Avoid sparks and naked flames.



Risk of explosion.



The battery contains corrosive acid.



Wear protective goggles.



Store the battery out of reach of children.



The battery must be disposed of properly to be recycled.



Recycle properly.



More information in the vehicle's user manual.

 **Note**

### Depicted labels

Labels depicted in this manual are generic representations of those found around your vehicle. The manual only contains their location and what kind of information they contain. Find the actual label for specific information about your vehicle.

---

## 13.5.3. Battery recycling

Used batteries must be recycled in an environmentally sound manner.

Consult Volvo Support if you're unsure of how to dispose of batteries. The traction battery must only be handled by authorized technicians.

---

## 13.5.4. Fuses

Electrical fuses protect different parts of the vehicle's electrical system by shutting off the power if the current exceeds the fuse's threshold. A blown fuse must be replaced to restore functionality.

A blown fuse may be an indicator of an underlying electrical fault. Contact Volvo support if your vehicle indicates that a fuse has blown.

 **Important**

- Incorrect fuse replacement can cause severe damage to the electrical system.
- A replacement fuse must have the correct specifications, such as type and ampere value.
- Volvo recommends an authorized Volvo workshop for fuse replacements.

---

## 13.6. Tools and equipment

Your vehicle is equipped with some tools that may be useful in certain situations. For example, if you need to change a tire.

The tools and equipment in your vehicle are stored in different places, such as under the hood, in the glove compartment and in the trunk. Be sure to familiarize yourself with where everything is stored so you don't have to search for something when you need it.

 **Warning**

### Store tools appropriately

Always store loose tools and equipment in their designated storage areas when not in use. Otherwise, they can cause damage or injury in the event of a collision.

### Read all instructions before using tools

Before use, make sure you read and understand all the relevant instructions for tools and equipment.

Contact a Volvo retailer for recommendations concerning tools and equipment for your vehicle.

## Towing eye



The towing eye can be attached to the vehicle's bumper to enable towing. It can also be used to secure objects carried on the roof that are longer than the roof.

## Temporary puncture repair kit



Temporary puncture repair kit

Your vehicle is equipped with a temporary puncture repair kit that can be used to repair a minor tire puncture.

---

## 13.6.1. Using a warning triangle

The content of this manual represents the status of the user manual at the time of printing and may not be completely valid in future instances. For more information refer to the first page for the complete disclaimer note.

Assemble and set out a warning triangle if your vehicle is immobilized in an area where there might be other vehicles. The purpose of the warning triangle is to give other drivers advance notice of your vehicle or other stationary hazards.

 **Note**

**Local rules and regulations**

Rules and regulations about how and when to put out a warning triangle vary between regions. You are responsible for knowing and following the rules that apply in your location.

 **Tip**

- If it's dark when you set out the warning triangle, wear a reflective vest if you have one in the vehicle. If you don't have one, you can hold the warning triangle so that its reflective parts are visible as you carry it.
- You can use the case as a reminder to retrieve the warning triangle when you leave by placing it on the driver's seat.

- 1 Activate the hazard warning lights.
- 2 Position the warning triangle in a suitable place with respect to traffic, at a distance that ensures that other drivers are alerted far enough in advance before they reach your vehicle.

Remember to retrieve the warning triangle before you drive off again.

---

## 13.6.2. Attaching the towing eye

Use the towing eye to attach a winch wire when towing.

On the right-hand side of the vehicle, the towing eye is screwed into a threaded socket behind a cover located on the front and rear bumpers.

 **Important**

Be sure to read about towing and its limitations before you start.

Fetch the towing eye so you have it at hand.

1

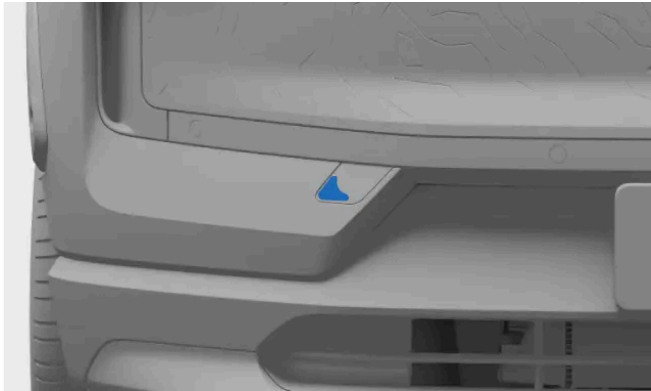

Front towing eye fastening cover.

To attach in the front: remove the cover by pushing the middle of the left-hand side edge. The cover pivots around its center line and can then be removed.

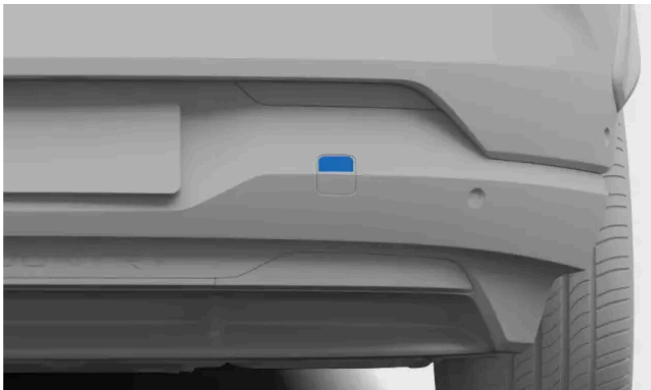

Rear towing eye fastening cover.

To attach in the rear: remove the cover by pushing its top edge. Fold it out entirely and take it off.

2 Screw the towing eye all the way into the socket.

 **Important**

It is important to screw the towing eye firmly into place. Putting something through the towing eye, such as a lug wrench, can provide extra leverage.

After you're done, remember to remove the towing eye and return it to its storage location.

---

## 13.7. Raising the vehicle

You can raise one wheel off the ground at a time using a jack. Be sure to read all instructions before raising the vehicle.



 **Important**

It is very important to place the jack on the jacking points, or the battery may get damaged.

### Recommended or supplied equipment

- The instructions for raising the vehicle presume use of a jack recommended or supplied<sup>[1]</sup> by Volvo.
- Only use tools and equipment designed for your vehicle model. Contact a Volvo retailer for tool recommendations.
- Volvo recommends that you visit an authorized Volvo workshop for tasks not described in the user manual.
- A portable jack designed for occasional and limited use is only suitable for short and urgent tasks, such as handling a flat tire. A workshop jack is recommended for frequent or extended use.
- Only raise the vehicle using its jacking points.

### Other lifting equipment

- If using lifting equipment not supplied by Volvo<sup>[2]</sup>, carefully read the instructions before raising the vehicle. Ensure that the equipment is compatible with the vehicle.
- Use additional safety equipment such as axle stands and wheel blocks when applicable.
- If you're using a workshop jack, make sure that the jack plate is fitted with a rubber guard to protect the vehicle as well as to ensure that the vehicle remains stable.

 **Warning**

### Safety around the vehicle

- If you are changing a wheel in or close to traffic, make sure you and the vehicle are clearly visible to others. Activate the hazard warning flasher, put out a warning triangle in a visible but safe place and wear a reflective vest.
- Designate a safe area for passengers to wait, away from both the vehicle and traffic.
- You are responsible for safety around the vehicle while it is raised. Do not allow people to stay inside of or close to the vehicle.

### Raising the vehicle

- Never get under the vehicle, or let anyone reach under it with any part of their body, while it is raised.
- Do not place any object between the ground and the jack or between the jack and the vehicle's jacking point.
- Do not use lifting equipment that shows any sign of damage.

#### Before raising the vehicle:

- Gather the tools and parts needed for your planned work.
- Make sure that the jack is in good condition and that its threads are properly lubricated and free of dirt.
- To avoid accidentally triggering the alarm, reduce your vehicle's alarm sensitivity.

- 1 Activate the parking brake.

The content of this manual represents the status of the user manual at the time of printing and may not be completely valid in future instances. For more information refer to the first page for the complete disclaimer note.

- 2 Place wheel blocks to reduce the risk of vehicle movement while raised. Large stones or wooden blocks work well. Place them both in front of and behind each wheel that will remain on the ground.
- 3 Locate the intended jacking point on the vehicle's underbody. Triangular markings low down along the vehicle sides indicate the locations of the jacking points.

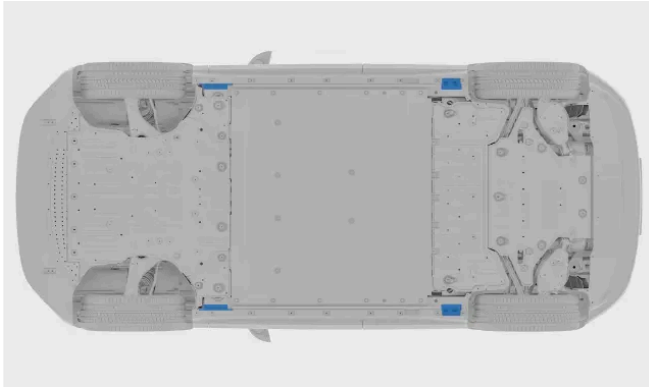

There are two jacking points on each side of the vehicle.

- 4 Place the jack under the vehicle's jacking point. The surface it stands on must be firm, non-slippery and level. Position the jack with the crank handle pointing away from the vehicle.
- 5 Crank the jack up until its head reaches the vehicle's jacking point. Ensure that the jacking point fits into the jack's slot properly.

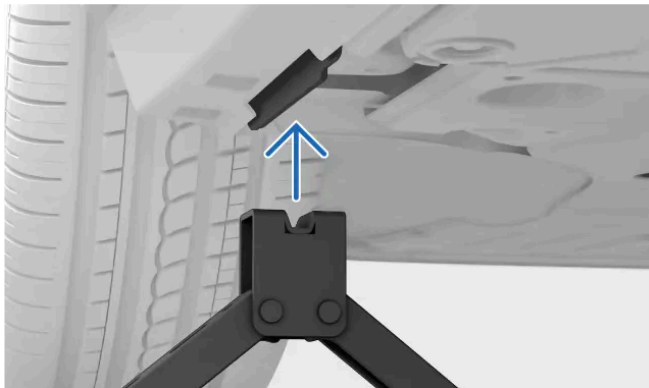

- 6 Make a final alignment. Make sure that:
  - the jack is not leaning in any direction
  - the base of the jack is centered under the jacking point
  - the jack head meets the jacking point correctly.

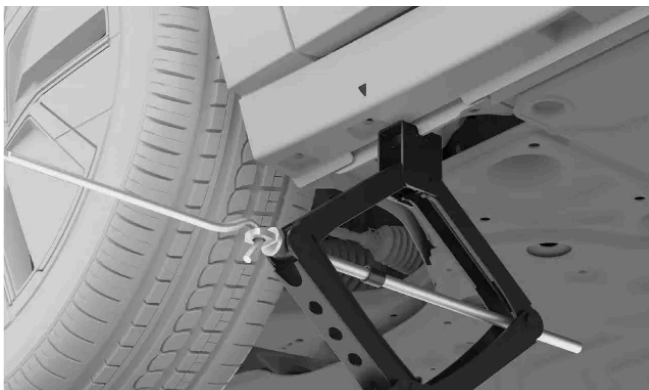

- 7 Raise the vehicle to an appropriate height. Do not raise it higher than necessary for the work you're doing.



#### Warning

Do not leave the vehicle unsupervised when raised.

Carefully lower the vehicle when you have finished your work. Remember to test important vehicle functions that may have been affected by the work you performed.

Put the jack back into its storage place.

<sup>[1]</sup> Depending on market, a jack for occasional and limited use may be included with your vehicle.

<sup>[2]</sup> Such as workshop jacks or other lifting equipment designed for frequent and extended use.

---

## 13.8. Servicing and repairs

Properly performed maintenance, servicing and repairs are essential for keeping your vehicle in good working condition.

Your vehicle keeps track of when it was last serviced and tells you when it's time to make a new appointment. It can self-diagnose many types of faults and notify you if you need to take action.

If you notice any service or repair needs that have not been detected by the vehicle, contact Volvo support.

Volvo recommends an authorized Volvo workshop for all servicing and repair needs.



#### Important

##### Faults and notifications

If a notification in the vehicle calls for a service, make a service appointment as soon as you can. The vehicle status view in the display also contains information about detected issues.



#### Warning

- Do not handle or modify the vehicle's electrical components. Only perform actions that are clearly described in the user manual.
- High-voltage components can produce or conduct lethal currents and must only be handled by authorized technicians.
- Do not perform repairs on the vehicle's electrical system or components. Contact an authorized Volvo workshop for any required repairs or servicing.

## Volvo's recommended service program

Volvo recommends using authorized Volvo workshops to perform any service and maintenance work. Volvo workshops have the personnel, special tools and service literature required to provide high-quality servicing. Volvo's recommended service program has been developed to give your vehicle a long service life. Servicing your vehicle according to its customized service program may be a prerequisite for coverage under Volvo's warranties. Your vehicle's service and warranty information<sup>[1]</sup> contains more details about maintenance service and warranty terms and conditions.

<sup>[1]</sup> This is a separate publication included with your vehicle.

---

## 13.8.1. Booking servicing or repairs

Volvo support handles bookings when you need a service or repair appointment. Authorized Volvo workshops have specialized training and equipment to take care of your vehicle.

Your vehicle notifies you when it's time for servicing.

- 1 Contact Volvo support to book an appointment. They can locate your closest service point.

If you are unable to reach Volvo support and urgently need servicing or repairs, contact a roadside assistance service available in your location.

---

## 13.8.2. On-board diagnostic port

Your vehicle has a diagnostic port that allows a workshop to connect to the vehicle and communicate with its systems. Do not connect equipment that has not been authorized by Volvo.

The diagnostic port is type OBDII.

The diagnostic port is located on the underside of the dashboard, close to the hood release lever.

Improper use of the diagnostic port can negatively affect the vehicle's systems and software. This includes connecting unauthorized equipment<sup>[1]</sup> and the installation of software or diagnostic tools.

### Note

Volvo accepts no liability if unauthorized equipment is connected to the on-board diagnostic port. Contact an authorized Volvo workshop for more information.

<sup>[1]</sup> Equipment not approved by Volvo.

The content of this manual represents the status of the user manual at the time of printing and may not be completely valid in future instances. For more information refer to the first page for the complete disclaimer note.



## 14. Immobilized vehicle and recovery

If you can't drive your vehicle, it's considered to be immobilized. You can always contact an authorized Volvo workshop if you're unable to find a solution in the user manual or if you are uncertain about how to proceed.

Depending on the nature of the problem, you may be able to solve it on your own or with assistance from an authorized Volvo workshop or other services. In this part of the user manual, you will find a number of scenarios and how to handle them safely.

In a situation where there are injuries or risk of injury, prioritize safety and medical needs over vehicle recovery. Don't hesitate to contact emergency services if necessary.

The following scenarios have their own manual sections that can help you identify the underlying issue and what the necessary steps for recovery are.

- The vehicle malfunctions and the vehicle can't be used as intended.
- The battery is dead and the vehicle is unresponsive.
- There is physical damage to the vehicle. The damage can make the vehicle unsuitable to drive or cause immobilization. Even superficial damage needs to be evaluated to ensure that you can safely use the vehicle.

### Important

#### Having your vehicle towed

If your vehicle requires towing, there are some guidelines you need to follow. If your vehicle is undamaged and has power, tow mode must be activated to pull your vehicle onto a recovery vehicle's platform. When your vehicle is in tow mode, the speed of the recovery vehicle should not exceed 5 km/h (3 mph) and the towing distance should not exceed 10 m (30 ft). If tow mode cannot be activated, the vehicle must be lifted onto a recovery vehicle.

### 14.1. Damaged vehicle

If your vehicle is damaged, it is important to identify the extent and severity of the damage to determine how to handle the vehicle safely.

Damage can immobilize your vehicle or make it unsafe to drive.

Contact an authorized Volvo workshop if your vehicle has been damaged or if it shows signs of damage sustained while parked. If the damage immobilizes or severely impairs your vehicle's performance, recovery through a roadside assistance and recovery service is necessary.

 **Important**

### Minor damage

Your vehicle can self-diagnose many defects, but it can't detect all types of damage or predict their consequences. A small impact resulting in superficial damage can harm components behind the affected area, such as misaligning a parking sensor behind a bumper. That's why it's important to have seemingly minor or superficial damage examined by a trained technician to determine the full extent of the damage.

## Immobilizing damage

There are several types of damage that can immobilise your vehicle. They include but are not limited to:

- Collision damage
- Flat tire
- Windshield damage
- Water damage
- Mechanical failure

## Collision damage

After a severe-enough collision, your vehicle enters safety mode and needs to be recovered.

 **Important**

If possible, do not try to drive or move your vehicle after a severe collision. The only exception is if the vehicle is a serious hazard to other vehicles on the road, in which case you should move it a short distance so it is out of immediate danger if the vehicle's condition allows you to do so.

## Water damage

Water damage can cause permanent damage to your vehicle and severely affect how well it works.

 **Important**

Simply drying the vehicle out or allowing it to dry will often be insufficient to resolve significant water damage. A trained technician should examine any water damage to determine its full extent and severity.

## Mechanical damage

The best way to avoid mechanical failures is to follow the intended use and to regularly maintain your vehicle. It is important to continuously perform check-ups of the vehicle.

---

## 14.2. Malfunction

The content of this manual represents the status of the user manual at the time of printing and may not be completely valid in future instances. For more information refer to the first page for the complete disclaimer note.

When part of your vehicle or one of its features is not working as designed, that is considered a malfunction. <sup>[1]</sup> It may not be safe to use the vehicle at all, depending on what type of malfunction the vehicle is experiencing.

**Note**

**Immobilized vehicle**

You should consider your vehicle immobilized if a malfunction prevents you from driving safely.

**Unresponsive vehicle**

There is a separate section in this manual for power-related issues.

## General advice for malfunctions

If a function doesn't work properly, try the following actions:

- Read the section of the user manual for that function. Make sure that you are aware of what's required for it to work properly. The problem might mean that you are unaware of a limitation to a specific function.
- Restart all related devices and systems. This applies to your vehicle itself, but can also include your phone or an app.
- If there is more than one way to use a function or perform a task, try the alternatives.

**Note**

**Changes after software updates**

Software updates can make changes to functions that affect how they work. Be sure to read the information provided with each update so that you understand why your vehicle may behave differently.

## Possible causes

When a function isn't working the way you expect it to, there are several possible causes:

- The vehicle's settings have been changed.
- Environmental conditions are affecting your vehicle and its systems.
- Signal interference is affecting connectivity and wireless systems.
- A fuse has blown and needs to be replaced.
- Software error.
- Mechanical failure.

## Contact an authorized Volvo workshop if needed

If you can't solve the problem using the information in the user manual, contact an authorized Volvo workshop.

Take note of what happened around the time the problem appeared. It may help identify the cause. Examples of key events include:

- Damage to your vehicle.

**The content of this manual represents the status of the user manual at the time of printing and may not be completely valid in future instances. For more information refer to the first page for the complete disclaimer note.**



- Exposure to extreme conditions.
- Recently performed servicing, maintenance or replacement of a component.
- Recently updated software.
- Any other faults or malfunctions.

[1] In some cases, a suspected fault or failure may instead be an intentional limitation under the conditions experienced by the vehicle.

---

## 14.3. Vehicle has no power or is not responding

If your vehicle is unresponsive or appears to have no power, the cause could be dead batteries or something affecting its electrical systems.

If your vehicle's batteries are discharged, the vehicle will not respond to some of your actions. This includes trying to unlock or start it.

If your vehicle doesn't respond due to low power, there are several recovery options depending on the situation.

The following situations can lead to both batteries in your vehicle discharging:

- The vehicle is driven to 0% battery level and is not then immediately recharged.
- The vehicle is left with a low battery level. If not plugged in for charging, the battery level drops further, as the vehicle uses a small amount of power while parked.
- The vehicle is left without charging for a long time, which allows the battery level to drop.
- Low temperatures temporarily reducing battery capacity below the required level to keep your vehicle powered.

Conditions or uses that increase power consumption and result in a faster-than-expected drop in battery level include:

- Use of accessories or power-consuming vehicle functions.
- High temperatures, triggering battery cooling.

### Recovery from a drained traction battery

If only the traction battery is dead, the vehicle's systems have power but it can't be started or driven. Your vehicle shows that the battery level is at 0%. In this situation, the 12 V battery can power the systems needed to initiate charging of the traction battery. It's important to conserve energy in the 12 V battery so that you can access and charge your vehicle.

Vehicle recovery actions:

- If you can charge your vehicle where it's parked, do so immediately.
- If your vehicle can't be charged at your current location, have the vehicle recovered and transported to a charging source. In the meantime, try to conserve the remaining power in the 12 V battery. This is important for battery health and also keeps essential functionality available for you to use in an emergency.

### Recovery from total loss of power

The content of this manual represents the status of the user manual at the time of printing and may not be completely valid in future instances. For more information refer to the first page for the complete disclaimer note.

If the 12 V battery goes flat, your vehicle will be completely unresponsive. This can happen if something prevents the traction battery from keeping the 12 V battery charged, such as allowing the traction battery to go dead and then not charging the vehicle in time. If both batteries are discharged, your vehicle is entirely unresponsive and cannot be charged as usual.

Recovery actions:

- Contact an authorized Volvo workshop or a recovery and roadside assistance service.
- If there is a charging source where your vehicle is immobilized, it may be possible to temporarily power the vehicle using a special exterior 12 V terminal. This can allow you to initiate charging.
- If your vehicle can't be charged where it is, it needs to be transported to a location with a charging source. An authorized Volvo workshop has the equipment to power your vehicle and charge it.

 **Important**

### 12 V terminal

In the event of a total loss of power, your vehicle can't be unlocked as the locks are electrically operated. To access your vehicle and charge it, it can be powered for a short time using the externally accessible 12 V terminal. The terminal can be accessed by removing a small panel below the front bumper, near the front left wheel.

Before any use of the 12 V terminal, consider the following:

- Volvo recommends that the 12 V terminal only be used by service technicians for the purpose of accessing the vehicle as part of immobilization recovery.
- The external 12 V terminal on your vehicle should only be used to make your vehicle accessible. Do not attempt to charge another vehicle or similar external source from this point.
- Only use a 12 V charger with a maximum charging current of less than 40 A.
- Connecting any power source that delivers current higher than 40 A will blow the terminal's fuse, thereby disabling it.
- Only use the 12 V terminal for short amounts of time. This is not meant as a way of powering the vehicle continuously.
- Make sure to follow the positive and negative markings on the terminals – reversing the polarity of the low-voltage system could lead to damaging the low-voltage system components or blowing the 40 A fuse.

## Other no-power scenarios

There may be cases where you are fairly sure that the battery level is not low. In those cases, a lack of power indicates that the 12 V battery isn't receiving power from the traction battery or can't deliver power to the vehicle.

Possible scenarios that affect the 12 V power delivery:

- A fuse has blown and needs to be replaced.
- The 12 V battery is defective.
- There is an electrical, hardware or software fault preventing the vehicle from turning on.

If you can't identify the cause of the problem or solve it by referring to the user manual, contact an authorized Volvo workshop.

## 14.4. Recovery

Vehicle recovery typically requires transporting your vehicle with a recovery vehicle. This is necessary if the vehicle is immobilized and its functions cannot be restored where it is.

Contact an authorized Volvo workshop if you need to recover your vehicle.<sup>[1]</sup>

The recommended recovery procedure depends on the conditions and state of the vehicle. If your vehicle is undamaged and has power, tow mode can be activated to pull the vehicle onto the recovery vehicle's platform. If the vehicle is damaged, unresponsive or in safety mode, it should be lifted onto the recovery vehicle's platform.

### Important

#### Wheels off the ground

Regardless of your vehicle's condition, it must be transported with all wheels off the ground when recovered. Forced wheel rotation during transportation can severely damage your vehicle.

#### Keep a safe distance

Do not allow anyone to stand directly behind your vehicle as it is pulled onto the recovery vehicle.

<sup>[1]</sup> For urgent recovery needs, you can also directly contact a recovery and roadside assistance service.

---

## 14.5. Safety mode

If your vehicle detects damage that compromises safety, it can enter safety mode.

Safety mode limits the available functions when your vehicle has sustained damage. When safety mode is active, you cannot drive your vehicle and it must undergo damage assessment and repairs<sup>[1]</sup>. Contact an authorized Volvo workshop if safety mode has been activated for any reason.

The display clearly indicates when your vehicle is in safety mode, if it is still functioning.

### Warning

- Do not use or stay in your vehicle when it is in safety mode.
- Do not tow your vehicle without first activating tow mode. You can do this in the display.
- Resetting your vehicle's status without performing damage assessment and repairs can result in further damage to the vehicle, as well as personal injury.

<sup>[1]</sup> Volvo recommends an authorized Volvo workshop.

## 14.6. Having your vehicle towed

Your vehicle can be towed short distances. For this, tow mode must first be activated.

### Important

#### Before having your vehicle towed

- To avoid triggering the alarm inadvertently, you need to reduce your vehicle's alarm sensitivity before towing it.
- You can only access tow mode if the vehicle has power. If your vehicle can't be powered on, it will need to be lifted onto the recovery vehicle's platform.
- Be sure to read all information about having your vehicle towed before you activate tow mode.
- You should not tow your vehicle further than 10 m (30 ft). Towing your vehicle longer distances can damage the vehicle by causing the battery to charge incorrectly.
- In tow mode, the towing speed of your vehicle should not exceed 5 km/h (3 mph).

To tow your vehicle, you must first activate tow mode, which involves attaching the towing eye and the winch wire. Make sure that you have all the necessary equipment ready.

- 1 Activate tow mode.
  - The tow mode activation confirmation appears in the display if it is still functioning.
- 2 Tow your vehicle onto a recovery vehicle or to a safe place, such as the side of the road.
- 3 When the vehicle is in the necessary place, engage the parking brake.
  - Tow mode deactivates.
- 4 If necessary, remove the towing eye and winch wire.

### Important

Always use a recovery vehicle to transport the vehicle whenever it cannot be driven. Forced wheel rotation during transportation can severely damage your vehicle. Make sure the vehicle is only transported by a recovery vehicle such as a flatbed, so that the vehicle's wheels do not touch the ground while being transported.

### 14.6.1. Activating tow mode

If your vehicle needs to be towed onto a flatbed recovery vehicle, you first need to activate tow mode in settings.

 **Important**

- Having your vehicle towed without activating tow mode may damage it. Be sure to follow the instructions in the display until you have received confirmation that tow mode is active before your vehicle is towed.
- To avoid accidentally triggering the alarm, reduce your vehicle's alarm sensitivity before towing it.
- Tow mode can only be accessed if the vehicle has power. If the vehicle can't be powered on it will need a full recovery.
- Be sure to read all information about having your vehicle towed before you activate tow mode.

 **Note**

Tow mode is only used when you have your vehicle towed. Do not activate it when towing other vehicles or trailers.

- 1 Press the vehicle symbol  in the bottom bar and go to **Settings**.
- 2 Go to **Controls** → **Car modes** → **Tow mode guide**.
  - The tow mode tutorial appears in the display.
- 3 Follow the tutorial until you get confirmation that tow mode is active.

Tow mode deactivates when you engage the parking brake and lock the vehicle, or when you start driving.

---

# 15. Specifications

These specifications describe your vehicle in technical terms and figures. You might need to find some of these details, such as when buying new tires.

This information is divided up in the following sections, with some examples of their content to help guide you.

- General vehicle characteristics – dimensions, weights, and type designations.
  - Powertrain specifications – performance, electric motor, range and electric consumption.
  - Wheel and tire specifications – approved tire pressures and tire sizes.
  - Fluid specifications – brake fluid and refrigerant.
  - Certificates and type approvals
- 

## 15.1. General vehicle characteristics

These are the basic facts about your vehicle. This information will help you determine your vehicle's specific setup.

You may need to know these things about your vehicle for a number of reasons. For example, to be able to order the right spare parts or accessories.

---

### 15.1.1. Vehicle dimensions

Here you can find your vehicle's measurements, such as length and height.

Locate the measurement you're looking for in the images first, then check the corresponding letter in the table below.

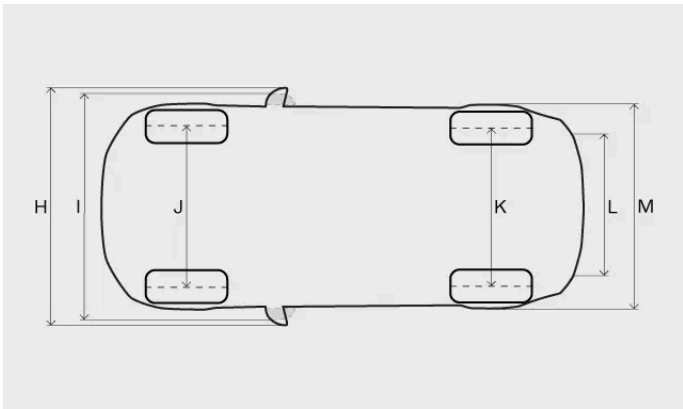
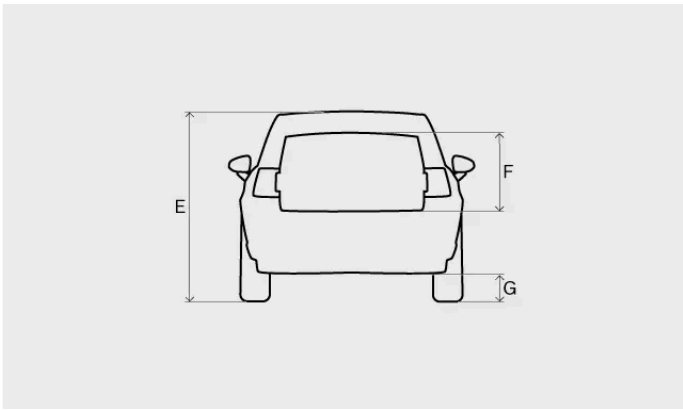
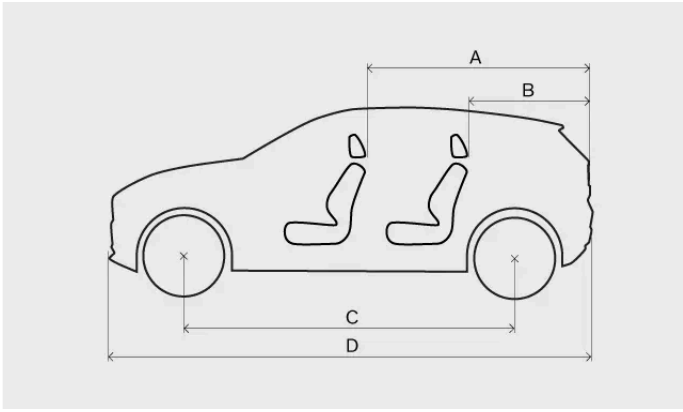

| Measurement |   | Millimeters | Inches |
|-------------|---|-------------|--------|
| A           | Load length, floor, folded seat         | 1460        | 57.5   |
| B           | Load length, floor                      | 720         | 28.3   |
| C           | Wheelbase                               | 2650        | 104.3  |
| D           | Length                                  | 4233        | 166.7  |
| E           | Height <sup>[1]</sup>                   | 1567        | 61.7   |
| F           | Load height                             | 581         | 22.9   |
| G           | Ground clearance <sup>[1]</sup>         | 190         | 7.5    |
| H           | Width including folded-out wing mirrors | 2040        | 80.3   |
| I           | Width including folded-in door mirrors  | 1953        | 76.9   |
| J           | Front wheel track                       | 1590        | 62.6   |

| Measurement |                   | Millimeters | Inches |
|-------------|-------------------|-------------|--------|
| K           | Rear track        | 1595        | 62.8   |
| L           | Load width, floor | 1019        | 40.1   |
| M           | Width             | 1850        | 72.8   |

<sup>[1]</sup> At curb weight plus one person.

## 15.1.2. Weights

You can find your vehicle's maximum gross vehicle weight and other weights below.

| Twin Motor Performance    |           |             |
|---------------------------|-----------|-------------|
|                           | USA (lbs) | Canada (kg) |
| Gross vehicle weight      | 5132–5143 | 2328–2333   |
| Load capacity             | 992       | 450         |
| Maximum front axle weight | 2535      | 1150        |
| Maximum rear axle weight  | 2866      | 1300        |
| Maximum roof load         | 165       | 75          |
| Curb weight               | 4140–4151 | 1878–1883   |

### Important

When the vehicle is loaded, it must not exceed the maximum gross vehicle weight and axle weights.

## 15.1.3. Towing specifications and capabilities

In the table you can see the gross trailer weights and tongue weights for driving with a trailer.

### Important

Always follow local rules and regulations when driving with a trailer, such as speed for the vehicle combination.

### Braked trailer

Max. gross trailer weight 907 kg

Max. towball load 91 kg



## Unbraked trailer

Max. gross trailer weight 748 kg

---

### 15.1.4. Towbar specifications

Here you can find measurements related to your towbar.

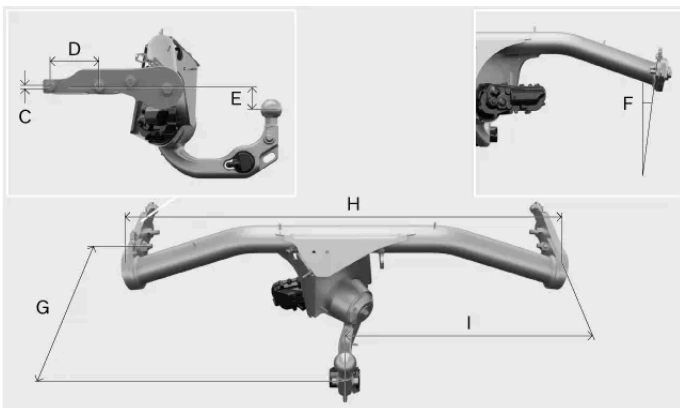
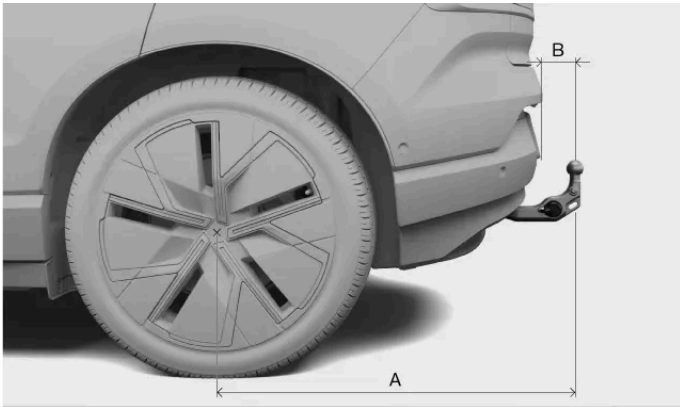

Dimensions, mounting points in millimeters (inches)

A 900.375 (35.447)

B 104.508 (4.114)

C 9.9 (0.389)

D 110 (4.33)

E 52.612 (2.07)

F 8°

G 395 (15.55)

H 1032.726 (40.658)

I 516.363 (20.329)

---

### 15.1.5. Type designations

The content of this manual represents the status of the user manual at the time of printing and may not be completely valid in future instances. For more information refer to the first page for the complete disclaimer note.

Knowing the vehicle's detailed information can help facilitate contact with a Volvo retailer and when ordering spare parts and accessories.

## Labels

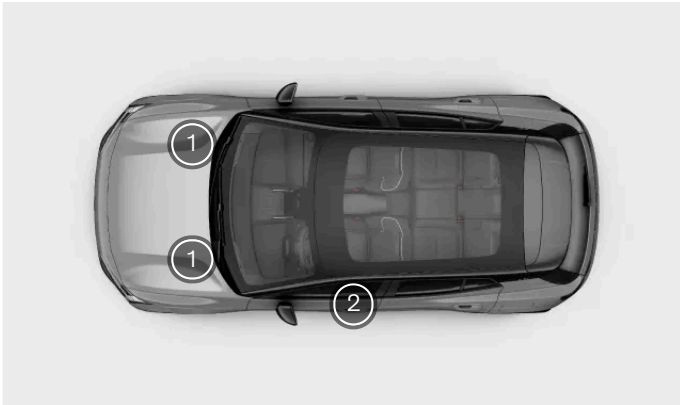

- ① Label Vehicle Emission Control Information
- ② Certification label

Your Volvo is designed to meet all applicable emission standards, as evidenced by the label. The label is located on the right and left side of the hood's inner panel and will be visible when the hood is opened.

The certification label is located on the left-hand door pillar and will be visible when the door is open.



Label Vehicle Emission Control Information



Certification label

Examples of information you can find on the certification label:

- Vehicle identification number
- Weight information
- Build date

### **i** Note

Labels depicted in this manual are generic representations of those found around your vehicle. The manual only contains their location and what kind of information they contain. Find the actual label for specific information about your vehicle.



Tip

For many markets, more information can also be found in the vehicle's registration document.

## 15.2. Powertrain specifications

Find the specifications regarding your vehicle's propulsion.

These specifications provide details about what your vehicle is capable of and certified for. They also specify data on relevant charging cables.

### 15.2.1. Electric motor specifications

Your vehicle is powered by two electric motors (front and rear) and you can find the specifications here.

| Twin Motor Performance |                                |     |   |
|------------------------|--------------------------------|-----|---|
| Front                  | Electric motor type            |     | Synchronous motor with permanent magnet |
|                        | Electric motor model           |     | TZ180XSB01                              |
|                        | Max. power output              | kW  | 115                                     |
|                        |                                | hp  | 156                                     |
|                        | Rated power (continuous power) | kW  | N/A                                     |
|                        | Max. torque                    | Nm  | 200                                     |
| lb-ft                  |                                | 147 |   |
| Rear                   | Electric motor type            |     | Synchronous motor with permanent magnet |
|                        | Electric motor model           |     | TZ220XSA02                              |
|                        | Max. power output              | kW  | 200                                     |
|                        |                                | hp  | 272                                     |
|                        | Rated power (continuous power) | kW  | N/A                                     |
|                        | Max. torque                    | Nm  | 343                                     |
| lb-ft                  |                                | 253 |   |
| Total vehicle (system) | Max. power output              | kW  | 315                                     |
|                        |                                | hp  | 428                                     |
|                        | Rated power (continuous power) | kW  | N/A                                     |
|                        | Max. torque                    | Nm  | 543                                     |
| lb-ft                  |                                | 400 |   |

 **Note**

If data is missing, it will be updated at a later stage.

---

## 15.2.2. Performance

You can find the vehicle's top speed and acceleration time in the table below.

### Twin Motor Performance

|  |                           |
|--|---------------------------|
| <b>Top speed</b>                               | 180 km/h (112 mph)        |
| <b>Acceleration time 0-100 km/h (0-60 mph)</b> | 3.7 seconds (3.5 seconds) |

 **Note**

If data is missing, it will be updated at a later stage.

---

## 15.2.3. Charging cable specifications

These specifications provide details about mode 2 charging cables. Mode 2 charging cables can be purchased from the Volvo Extras shop.

**Ambient temperature** -30 °C to 40 °C (-22 °F to 104 °F)

### Residual-current device

Mode 2 charging cables have a built-in residual current device that protects the vehicle and the user from electric shocks caused by system faults.

 **Warning**

The residual-current device helps to protect the vehicle's charging system, but there is no guarantee that an overload will never occur.

 **Important**

The residual-current device does not protect the household outlet.

### Temperature monitoring

The content of this manual represents the status of the user manual at the time of printing and may not be completely valid in future instances. For more information refer to the first page for the complete disclaimer note.

The mode 2 cable is also equipped with a control unit, which has a built-in overtemperature monitoring function. This monitors the temperature of the charging cable.

**!** Important

Avoid exposing the control unit and its plug connector to direct sunlight. The overheating protection in the plug connector may otherwise reduce or stop your vehicle's charging.

## 15.2.4. Charging port label

Your vehicle has a label with information about the different charging port statuses on the charging lid.

### Charging statuses

The label contains information about the different charging port statuses. The label is shown on the inside of the charging lid.

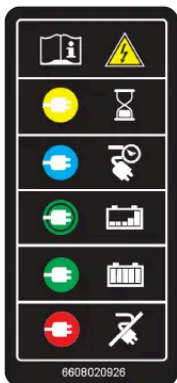

## 15.3. Wheel and tire specifications

Here you can find specific wheel and tire information applicable to your vehicle.

**i** Note

There are more recommendations regarding wheels and tires that are important to be aware of.

### 15.3.1. Approved tire pressures

You can find the approved tire pressures for your vehicle in the table below.

The recommended pressure for factory-equipped tires can be found on the tire pressure label. It's located on the door pillar on the driver's side and is visible when the door is opened.

| Tire size                | Max load           |                   |
|--------------------------|--------------------|-------------------|
|                          | Front<br>psi (kPa) | Rear<br>psi (kPa) |
| 235/55 R18<br>235/50 R19 | 41 (280)           | 41 (280)          |

## 15.4. Fluid specifications

Your vehicle has fluids to help its different systems function properly. When it is time to refill or perform maintenance, you may need to know the specifics of these fluids.

It is recommended that you get some fluids changed or filled by an authorized Volvo workshop. Check this section for the fluid you need information on and, if necessary, contact an authorized Volvo workshop to schedule an appointment.

### 15.4.1. Brake fluid specifications

The medium in your vehicle's brake system is called brake fluid.

**Prescribed grade** Volvo Original or equivalent brake fluid that fulfills a combination of the DOT 4, 5.1 and ISO 4925 class 6 classifications.

#### ! Important

It is recommended that brake fluid be changed or filled by an authorized Volvo workshop.

### 15.4.2. Climate system specifications

Here you will find information about the refrigerant quantity and the prescribed grade and volume of compressor oil.

#### Climate system label



The label with information on climate system fluids is located under the hood, on the right-hand side of the vehicle.

The content of this manual represents the status of the user manual at the time of printing and may not be completely valid in future instances. For more information refer to the first page for the complete disclaimer note.

On this label you can find:

- Refrigerant type (R1234yf)
- Refrigerant quantity

## Label symbols



Caution



A trained and certified technician is required to service the mobile air conditioning system<sup>[1]</sup>



Flammable refrigerants



Mobile air conditioning system<sup>[1]</sup>



Lubricant type

## Compressor oil

**Volume** 260 ml (8.79 US fl oz) (9.15 UK fl oz)

**Prescribed grade** PVE FVC56EA

## Servicing and repair of the climate system

### **Warning**

#### Servicing and repair

The climate system contains pressurized refrigerant. The climate system must only be serviced and repaired by trained and certified technicians in order to ensure the safety of the system<sup>[2]</sup>. Volvo recommends that you visit an authorized Volvo workshop for any repair or service needs.

### **Important**

#### Repairing the evaporator

The climate system's evaporator must never be repaired or replaced with a previously used evaporator. A new evaporator must be certified and labeled in accordance with SAE J2842.

<sup>[1]</sup> MAC

<sup>[2]</sup> In accordance with SAE J2845 (Technician Training for Safe Service and Containment of Refrigerants Used in Mobile A/C System).

## 15.5. Certificates and type approvals

This documentation shows that your vehicle meets certain standards and specifications.

User manuals are required by law to provide documentation of certain certificates and type approvals.

For more information, contact Volvo Support.

---

### 15.5.1. Procedure to temporarily change the automatic high beam sensitivity



You can set an alternative automatic high beam sensitivity in accordance with FMVSS108 requirements.

#### Important

The vehicle must be stationary to change the sensitivity. Keep the brake pedal pressed down throughout the procedure.

- 1 Put the vehicle in drive by selecting **D** with the right-hand steering wheel stalk.
- 2 Press the vehicle symbol  in the bottom bar and go to **Settings**.
- 3 Go to **Controls** → **Lights and displays** → **Exterior lights**.
  - Make sure that the default automatic lights mode<sup>[1]</sup> is selected.

The following steps must be completed within 30 seconds:

- 4 Press the low beam symbol .
- 5 Activate the high beam flash with a short pull on the left-hand steering wheel stalk.
- 6 Select automatic lights mode<sup>[1]</sup> again.
- 7 Activate the high beam flash again with a short pull on the left-hand steering wheel stalk.
- 8 Press the passing beam symbol  again.
- 9 Activate the high beam flash once more with a short pull on the left-hand steering wheel stalk.
- 10 Select automatic lights mode<sup>[1]</sup>.

#### Note



The sensitivity returns to the default setting when you start a new drive cycle.



## 15.5.2. Radar type approvals

Find the radar type approval you're looking for among the ones listed here.



### Front center radar

| Regions   | Labels and symbols  | Specification  |
|-----------|---|--|
| Argentina |  H-32185           |  |
| Brazil    | <br>06354-19-12386 | Este equipamento não tem direito à proteção contra interferência prejudicial e não pode causar interferência em sistemas devidamente autorizados |



| Regions               | Labels and symbols  | Specification  |
|-----------------------|---|--|
| Canada                |   | <p>This device contains license-exempt transmitter(s)/receiver(s) that comply with Innovation, Science and Economic Development Canada's licence-exempt RSS(s).</p> <p>Operation is subject to the following two conditions:</p> <p>(1) This device may not cause interference.</p> <p>(2) This device must accept any interference, including interference that may cause undesired operation of the device.</p> <p>Le présent appareil est conforme aux CNR d'Industrie Canada applicables aux appareils radio exempts de licence.</p> <p>L'exploitation est autorisée aux deux conditions suivantes:</p> <p>(1) l'appareil ne doit pas produire de brouillage, et</p> <p>(2) l'utilisateur de l'appareil doit accepter tout brouillage radioélectrique subi, même si le brouillage est susceptible d'en compromettre le fonctionnement.</p>   |
| European Union & EFTA |  | <p><b>Simplified EU declaration of conformity.</b></p> <p><b>English</b></p> <p>Hereby, Veoneer US, Inc. declares that the radio equipment type 77V12FLR is in compliance with Directive 2014/53/EU. The full text of the EU declaration of conformity is available at the following internet address: <a href="https://www.magna.com/type-approval/76-77-ghz/77v12flr">https://www.magna.com/type-approval/76-77-ghz/77v12flr</a> [<a href="https://www.magna.com/type-approval/76-77-ghz/77v12flr">https://www.magna.com/type-approval/76-77-ghz/77v12flr</a>]</p> <p>Operational frequency band: 76 – 77 GHz/ Maximum output power:&lt;55 dBm peak eirp</p> <p><b>Bulgarian</b></p> <p>С настоящото Veoneer US, Inc. декларира, че този тип радиосъоръжение 77V12FLR е в съответствие с Директива 2014/53/ЕС. Цялостният текст на ЕС декларацията за съответствие може да се намери на следния интернет адрес: <a href="https://www.magna.com/type-approval/76-77-ghz/77v12flr">https://www.magna.com/type-approval/76-77-ghz/77v12flr</a> [<a href="https://www.magna.com/type-approval/76-77-ghz/77v12flr">https://www.magna.com/type-approval/76-77-ghz/77v12flr</a>]</p> <p>Работна честотна лента: 76 – 77 GHz/ Максимална изходна мощност:&lt;55 dBm peak eirp</p> <p><b>Croatian</b></p> <p>Veoneer US, Inc. ovime izjavljuje da je radijska oprema tipa 77V12FLR u skladu s Direktivom 2014/53/EU. Cjeloviti tekst EU izjave o sukladnosti dostupan je na sljedećoj internetskoj adresi: <a href="https://www.magna.com/type-approval/76-77-ghz/77v12flr">https://www.magna.com/type-approval/76-77-ghz/77v12flr</a> [<a href="https://www.magna.com/type-approval/76-77-ghz/77v12flr">https://www.magna.com/type-approval/76-77-ghz/77v12flr</a>]</p> <p>Radni frekvencijski pojas: 76 – 77 GHz/ Maksimalna izlazna snaga:&lt;55 dBm peak eirp</p> <p><b>Czech</b></p> <p>Tímto Veoneer US, Inc. prohlašuje, že typ rádiového zařízení 77V12FLR je v souladu se směrnici 2014/53/EU. Úplné znění EU prohlášení o shodě je k dispozici na této internetové adrese: <a href="https://www.magna.com/type-approval/76-77-ghz/77v12flr">https://www.magna.com/type-approval/76-77-ghz/77v12flr</a> [<a href="https://www.magna.com/type-approval/76-77-ghz/77v12flr">https://www.magna.com/type-approval/76-77-ghz/77v12flr</a>]</p> <p>Provozní kmitočtové pásmo: 76 – 77 GHz/ Nejvyšší výstupní výkon:&lt;55 dBm peak eirp</p> <p><b>Danish</b></p> <p>Hermed erklærer Veoneer US, Inc., at radioudstyrstypen 77V12FLR er i overensstemmelse med direktiv 2014/53/EU. EU-overensstemmelseserklæringens fulde tekst kan findes på følgende internetadresse: <a href="https://www.magna.com/type-approval/76-77-ghz/77v12flr">https://www.magna.com/type-approval/76-77-ghz/77v12flr</a> [<a href="https://www.magna.com/type-approval/76-77-ghz/77v12flr">https://www.magna.com/type-approval/76-77-ghz/77v12flr</a>]</p> <p>Driftsfrekvensområde: 76 – 77 GHz/ Maksimal udgangseffekt:&lt;55 dBm peak eirp</p> <p><b>Dutch</b></p> <p>Hierbij verklaar ik, Veoneer US, Inc., dat het type radioapparatuur 77V12FLR conform is met Richtlijn 2014/53/EU. De volledige tekst van de EU-conformiteitsverklaring kan worden geraadpleegd op het volgende internetadres: <a href="https://www.magna.com/type-approval/76-77-ghz/77v12flr">https://www.magna.com/type-approval/76-77-ghz/77v12flr</a> [<a href="https://www.magna.com/type-approval/76-77-ghz/77v12flr">https://www.magna.com/type-approval/76-77-ghz/77v12flr</a>]</p> <p>Operationele frequentieband: 76 – 77 GHz/ Maximaal uitgangsvermogen:&lt;55 dBm peak eirp</p> <p><b>Estonian</b></p> <p>Käesolevaga deklareerib Veoneer US, Inc., et käesolev raadioseadme tüüp 77V12FLR vastab direktiivi 2014/53/EL nõuetele. ELi vastavusdeklaratsiooni täielik tekst on kätesaadav järgmisel internetiaadressil: <a href="https://www.magna.com/type-approval/76-77-ghz/77v12flr">https://www.magna.com/type-approval/76-77-ghz/77v12flr</a> [<a href="https://www.magna.com/type-approval/76-77-ghz/77v12flr">https://www.magna.com/type-approval/76-77-ghz/77v12flr</a>]</p> <p>Töösagedusriba: 76 – 77 GHz/ Maksimalne väljundvõimsus:&lt;55 dBm peak eirp</p> <p><b>Finnish</b></p> <p>Veoneer US, Inc. vakuuttaa, että radiolaitetyyppi 77V12FLR on direktiivin 2014/53/EU mukainen. EU-vaatimusten mukaisuus- vakuutuksen täysimittainen teksti on saatavilla seuraavassa internetosoitteessa: <a href="https://www.magna.com/type-approval/76-77-ghz/77v12flr">https://www.magna.com/type-approval/76-77-ghz/77v12flr</a> [<a href="https://www.magna.com/type-approval/76-77-ghz/77v12flr">https://www.magna.com/type-approval/76-77-ghz/77v12flr</a>]</p> <p>Käyttöraajuusalue: 76 – 77 GHz/ Enimmäislähtäteho:&lt;55 dBm peak eirp</p> <p><b>French</b></p> <p>Le soussigné, Veoneer US, Inc., déclare que l'équipement radioélectrique du type 77V12FLR est conforme à la directive 2014/53/UE. Le texte complet de la déclaration UE de conformité est disponible à l'adresse internet suivante: <a href="https://www.magna.com/type-approval/76-77-ghz/77v12flr">https://www.magna.com/type-approval/76-77-ghz/77v12flr</a> [<a href="https://www.magna.com/type-approval/76-77-ghz/77v12flr">https://www.magna.com/type-approval/76-77-ghz/77v12flr</a>]</p> <p>Bande de fréquences opérationnelle: 76 – 77 GHz/ Puissance de sortie max:&lt;55 dBm peak eirp</p> <p><b>German</b></p> <p>Hiermit erklärt Veoneer US, Inc., dass der Funkanlagentyp 77V12FLR der Richtlinie 2014/53/EU entspricht. Der vollständige Text der EU-Konformitätserklärung ist unter der folgenden Internetadresse verfügbar: <a href="https://www.magna.com/type-approval/76-77-ghz/77v12flr">https://www.magna.com/type-approval/76-77-ghz/77v12flr</a> [<a href="https://www.magna.com/type-approval/76-77-ghz/77v12flr">https://www.magna.com/type-approval/76-77-ghz/77v12flr</a>]</p> <p>Betriebsfrequenzband: 76 – 77 GHz/ Maximale Ausgangsleistung:&lt;55 dBm peak eirp</p> <p><b>Greek</b></p> <p>Με την παρούσα ο/η Veoneer US, Inc., δηλώνει ότι ο ραδιοεξοπλισμός 77V12FLR πληροί την οδηγία 2014/53/ΕΕ. Το πλήρες κείμενο της δήλωσης συμμόρφωσης ΕΕ διατίθεται στην ακόλουθη ιστοσελίδα στο διαδίκτυο: <a href="https://www.magna.com/type-approval/76-77-ghz/77v12flr">https://www.magna.com/type-approval/76-77-ghz/77v12flr</a> [<a href="https://www.magna.com/type-approval/76-77-ghz/77v12flr">https://www.magna.com/type-approval/76-77-ghz/77v12flr</a>]</p> <p>Ζώνη συχνότητας λειτουργίας: 76 – 77 GHz/ Μέγιστη Ισχύς Εξόδου:&lt;55 dBm peak eirp</p> |

| Regions | Labels and symbols | Specification  |
|---------|--------------------|--|
|         |                    | <p><b>Hungarian</b></p> <p>Veoneer US, Inc. igazolja, hogy a 77V12FLR típusú rádióberendezés megfelel a 2014/53/EU irányelvnek. Az EU-megfelelőségi nyilatkozat teljes szövege elérhető a következő internetes címen: <a href="https://www.magna.com/type-approval/76-77-ghz/77v12flr">https://www.magna.com/type-approval/76-77-ghz/77v12flr</a> [<a href="https://www.magna.com/type-approval/76-77-ghz/77v12flr">https://www.magna.com/type-approval/76-77-ghz/77v12flr</a>]</p> <p>Működési frekvenciasáv: 76 – 77 GHz/ Maximum kimeneti teljesítmény:&lt;55 dBm peak eirp</p> <p><b>Icelandic</b></p> <p>Í þessu sambandi lýsir Veoneer US, Inc. að búnaður útvarpsbúnaðarins 77V12FLR sé í samræmi við tilskipun 2014/53/EU. Fullkominn texti EU yfirlýsing um samræmi er að finna á eftirfarandi netfangi: <a href="https://www.magna.com/type-approval/76-77-ghz/77v12flr">https://www.magna.com/type-approval/76-77-ghz/77v12flr</a> [<a href="https://www.magna.com/type-approval/76-77-ghz/77v12flr">https://www.magna.com/type-approval/76-77-ghz/77v12flr</a>]</p> <p>Rekstrar tíðnisvið: 76 – 77 GHz/ Hámarks útgangsstyrkur:&lt;55 dBm peak eirp</p> <p><b>Italian</b></p> <p>Il fabbricante, Veoneer US, Inc., dichiara che il tipo di apparecchiatura radio 77V12FLR è conforme alla direttiva 2014/53/UE. Il testo completo della dichiarazione di conformità UE è disponibile al seguente indirizzo Internet: <a href="https://www.magna.com/type-approval/76-77-ghz/77v12flr">https://www.magna.com/type-approval/76-77-ghz/77v12flr</a> [<a href="https://www.magna.com/type-approval/76-77-ghz/77v12flr">https://www.magna.com/type-approval/76-77-ghz/77v12flr</a>]</p> <p>Banda di frequenza operativa: 76 – 77 GHz/ Massima potenza di uscita:&lt;55 dBm peak eirp</p> <p><b>Latvian</b></p> <p>Ar šo Veoneer US, Inc. deklarē, ka radioiekārta 77V12FLR atbilst Direktīvai 2014/53/ES. Pilns ES atbilstības deklarācijas teksts ir pieejams šādā interneta vietnē: <a href="https://www.magna.com/type-approval/76-77-ghz/77v12flr">https://www.magna.com/type-approval/76-77-ghz/77v12flr</a> [<a href="https://www.magna.com/type-approval/76-77-ghz/77v12flr">https://www.magna.com/type-approval/76-77-ghz/77v12flr</a>]</p> <p>Darba frekvenču josla: 76 – 77 GHz/ Maksimālā izejas jauda:&lt;55 dBm peak eirp</p> <p><b>Lithuanian</b></p> <p>Aš, Veoneer US, Inc., patvirtinu, kad radijo įrenginių tipas 77V12FLR atitinka Direktyvą 2014/53/ES. Visas ES atitikties deklaracijos tekstas prieinamas šiuo interneto adresu: <a href="https://www.magna.com/type-approval/76-77-ghz/77v12flr">https://www.magna.com/type-approval/76-77-ghz/77v12flr</a> [<a href="https://www.magna.com/type-approval/76-77-ghz/77v12flr">https://www.magna.com/type-approval/76-77-ghz/77v12flr</a>]</p> <p>Darbiinių dažnių diapazonas: 76 – 77 GHz/ Maksimali išėjimo galia:&lt;55 dBm peak eirp</p> <p><b>Maltese</b></p> <p>B'dan, Veoneer US, Inc., niddikjara li dan it-tip ta' tagħmir tar-radju 77V12FLR huwa konformi mad-Direttiva 2014/53/UE. It-test kollu tad-dikjarazzjoni ta' konformità tal-UE huwa disponibbli f'dan l-indirizz tal-Internet li ġej: <a href="https://www.magna.com/type-approval/76-77-ghz/77v12flr">https://www.magna.com/type-approval/76-77-ghz/77v12flr</a> [<a href="https://www.magna.com/type-approval/76-77-ghz/77v12flr">https://www.magna.com/type-approval/76-77-ghz/77v12flr</a>]</p> <p>Il-banda tal-frekwenzi operattivi: 76 – 77 GHz/ L-Energija Massima Maħruġa:&lt;55 dBm peak eirp</p> <p><b>Norwegian</b></p> <p>Hermed erklærer Veoneer US, Inc. at radioutstyrtypen 77V12FLR er i samsvar med direktiv 2014/53/EU. Den fulle teksten til EU-samsvarserklæringen er tilgjengelig på følgende internetadresse: <a href="https://www.magna.com/type-approval/76-77-ghz/77v12flr">https://www.magna.com/type-approval/76-77-ghz/77v12flr</a> [<a href="https://www.magna.com/type-approval/76-77-ghz/77v12flr">https://www.magna.com/type-approval/76-77-ghz/77v12flr</a>]</p> <p>Operasjonelt frekvensbånd: 76 – 77 GHz/ Maksimal utgangseffekt:&lt;55 dBm peak eirp</p> <p><b>Polish</b></p> <p>Veoneer US, Inc. niniejszym oświadcza, że typ urządzenia radiowego 77V12FLR jest zgodny z dyrektywą 2014/53/UE. Pełny tekst deklaracji zgodności UE jest dostępny pod następującym adresem internetowym: <a href="https://www.magna.com/type-approval/76-77-ghz/77v12flr">https://www.magna.com/type-approval/76-77-ghz/77v12flr</a> [<a href="https://www.magna.com/type-approval/76-77-ghz/77v12flr">https://www.magna.com/type-approval/76-77-ghz/77v12flr</a>]</p> <p>Pasma częstotliwości roboczej: 76 – 77 GHz/ Maksymalna moc wyjściowa:&lt;55 dBm peak eirp</p> <p><b>Portuguese</b></p> <p>O(a) abaixo assinado(a) Veoneer US, Inc. declara que o presente tipo de equipamento de rádio 77V12FLR está em conformidade com a Diretiva 2014/53/UE. O texto integral da declaração de conformidade está disponível no seguinte endereço de Internet: <a href="https://www.magna.com/type-approval/76-77-ghz/77v12flr">https://www.magna.com/type-approval/76-77-ghz/77v12flr</a> [<a href="https://www.magna.com/type-approval/76-77-ghz/77v12flr">https://www.magna.com/type-approval/76-77-ghz/77v12flr</a>]</p> <p>Faixa de frequência de funcionamento:76 - 77 GHz/ Potência de Saída Máxima:&lt;55 dBm peak eirp</p> <p><b>Romanian</b></p> <p>Prin prezenta, Veoneer US, Inc. declară că tipul de echipamente radio 77V12FLR este în conformitate cu Directiva 2014/53/UE. Textul integral al declarației UE de conformitate este disponibil la următoarea adresă internet: <a href="https://www.magna.com/type-approval/76-77-ghz/77v12flr">https://www.magna.com/type-approval/76-77-ghz/77v12flr</a> [<a href="https://www.magna.com/type-approval/76-77-ghz/77v12flr">https://www.magna.com/type-approval/76-77-ghz/77v12flr</a>]</p> <p>Bandă frecvență operațională: 76 – 77 GHz/ Putere maximă la ieșire:&lt;55 dBm peak eirp</p> <p><b>Slovenian</b></p> <p>Veoneer US, Inc. potrjuje, da je tip radijske opreme 77V12FLR skladen z Direktivo 2014/53/EU. Celotno besedilo izjave EU o skladnosti je na voljo na naslednjem spletnem naslovu: <a href="https://www.magna.com/type-approval/76-77-ghz/77v12flr">https://www.magna.com/type-approval/76-77-ghz/77v12flr</a> [<a href="https://www.magna.com/type-approval/76-77-ghz/77v12flr">https://www.magna.com/type-approval/76-77-ghz/77v12flr</a>]</p> <p>Operativni frekvenčni pas: 76 – 77 GHz/ Največja izhodna moč:&lt;55 dBm peak eirp</p> <p><b>Slovak</b></p> <p>Veoneer US, Inc. týmto vyhlasuje, že rádiové zariadenie typu 77V12FLR je v súlade so smernicou 2014/53/EÚ. Úplné EÚ vyhlásenie o zhode je k dispozícii na tejto internetovej adrese: <a href="https://www.magna.com/type-approval/76-77-ghz/77v12flr">https://www.magna.com/type-approval/76-77-ghz/77v12flr</a> [<a href="https://www.magna.com/type-approval/76-77-ghz/77v12flr">https://www.magna.com/type-approval/76-77-ghz/77v12flr</a>]</p> <p>Prevádzkové frekvenčné pásmo: 76 – 77 GHz/ Maximálny výstupný výkon:&lt;55 dBm peak eirp</p> <p><b>Spanish</b></p> <p>Por la presente, Veoneer US, Inc. declara que el tipo de equipo radioeléctrico 77V12FLR es conforme con la Directiva 2014/53/UE. El texto completo de la declaración UE de conformidad está disponible en la dirección Internet siguiente: <a href="https://www.magna.com/type-approval/76-77-ghz/77v12flr">https://www.magna.com/type-approval/76-77-ghz/77v12flr</a> [<a href="https://www.magna.com/type-approval/76-77-ghz/77v12flr">https://www.magna.com/type-approval/76-77-ghz/77v12flr</a>]</p> <p>Banda de frecuencias de funcionamiento: 76 – 77 GHz/ Potencia máxima de salida:&lt;55 dBm peak eirp</p> <p><b>Swedish</b></p> |

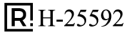

| Regions        | Labels and symbols  | Specification  |
|----------------|---|--|
| Thailand       |   | <p>1) [Placeholder text]</p> <p>2) [Placeholder text]</p>  |
| Ukraine        |  | <p>справжнім Veoneer заявляє, що тип радіобладнання (77V12FLR) відповідає Технічному регламенту радіобладнання; повний текст декларації про відповідність доступний на веб-сайті за такою адресою: <a href="https://www.magna.com/type-approval/76-77-ghz/77v12flr">https://www.magna.com/type-approval/76-77-ghz/77v12flr</a> [<a href="https://www.magna.com/type-approval/76-77-ghz/77v12flr">https://www.magna.com/type-approval/76-77-ghz/77v12flr</a>]</p>   |
| United Kingdom |  | <p>Hereby, Veoneer US, Inc. declares that the radio equipment type 77V12FLR is in compliance with radio regulation 2017. Operational frequency band: 76 – 77 GHz/ Maximum output power: &lt;55 dBm peak e.i.r.p</p> <p>The full text of the UK declaration of conformity is available at the following internet address: <a href="https://www.magna.com/type-approval/76-77-ghz/77v12flr">https://www.magna.com/type-approval/76-77-ghz/77v12flr</a> [<a href="https://www.magna.com/type-approval/76-77-ghz/77v12flr">https://www.magna.com/type-approval/76-77-ghz/77v12flr</a>]</p> |
| United States  |   | <p>This device complies with Part 15 of the FCC Rules. Operation is subject to the following two conditions:</p> <p>(1) this device may not cause harmful interference, and</p> <p>(2) this device must accept any interference received, including interference that may cause undesired operation.</p> <p>CAUTION TO USERS</p> <p>Changes or modifications not expressly approved by the party responsible for compliance could void the user's authority to operate the equipment.</p>  |

## Corner radar units



| Regions   | Labels and symbols  | Specification   |
|-----------|---|---|
| Argentina |   |   |
| Brazil    |  | <p>Este equipamento não tem direito à proteção contra interferência prejudicial e não pode causar interferência em sistemas devidamente autorizados</p> |

| Regions               | Labels and symbols  | Specification  |
|-----------------------|---|--|
| Canada                |   | <p>This device contains license-exempt transmitter(s)/receiver(s) that comply with Innovation, Science and Economic Development Canada's licence-exempt RSS(s).</p> <p>Operation is subject to the following two conditions:</p> <p>(1) This device may not cause interference.</p> <p>(2) This device must accept any interference, including interference that may cause undesired operation of the device.</p> <p>Le présent appareil est conforme aux CNR d'Industrie Canada applicables aux appareils radio exempts de licence.</p> <p>L'exploitation est autorisée aux deux conditions suivantes:</p> <p>(1) l'appareil ne doit pas produire de brouillage, et</p> <p>(2) l'utilisateur de l'appareil doit accepter tout brouillage radioélectrique subi, même si le brouillage est susceptible d'en compromettre le fonctionnement.</p>   |
| European Union & EFTA |  | <p><b>Simplified EU declaration of conformity.</b></p> <p><b>English</b></p> <p>Hereby, Veoneer US, Inc. declares that the radio equipment type 7713CRN is in compliance with Directive 2014/53/EU. The full text of the EU declaration of conformity is available at the following internet address: <a href="https://www.magna.com/type-approval/76-77-ghz/77v12flr">https://www.magna.com/type-approval/76-77-ghz/77v12flr</a> [<a href="https://www.magna.com/type-approval/76-77-ghz/77v12flr">https://www.magna.com/type-approval/76-77-ghz/77v12flr</a>]</p> <p>Operational frequency band: 76 – 77 GHz/ Maximum output power:&lt;55 dBm peak eirp</p> <p><b>Bulgarian</b></p> <p>С настоящото Veoneer US, Inc. декларира, че този тип радиосъоръжение 7713CRN е в съответствие с Директива 2014/53/ЕС. Цялостният текст на ЕС декларацията за съответствие може да се намери на следния интернет адрес: <a href="https://www.magna.com/type-approval/76-77-ghz/77v12flr">https://www.magna.com/type-approval/76-77-ghz/77v12flr</a> [<a href="https://www.magna.com/type-approval/76-77-ghz/77v12flr">https://www.magna.com/type-approval/76-77-ghz/77v12flr</a>]</p> <p>Работна честотна лента: 76 – 77 GHz/ Максимална изходна мощност:&lt;55 dBm peak eirp</p> <p><b>Croatian</b></p> <p>Veoneer US, Inc. ovime izjavljuje da je radijska oprema tipa 7713CRN u skladu s Direktivom 2014/53/EU. Cjeloviti tekst EU izjave o sukladnosti dostupan je na sljedećoj internetskoj adresi: <a href="https://www.magna.com/type-approval/76-77-ghz/77v12flr">https://www.magna.com/type-approval/76-77-ghz/77v12flr</a> [<a href="https://www.magna.com/type-approval/76-77-ghz/77v12flr">https://www.magna.com/type-approval/76-77-ghz/77v12flr</a>]</p> <p>Radni frekvencijski pojas: 76 – 77 GHz/ Maksimalna izlazna snaga:&lt;55 dBm peak eirp</p> <p><b>Czech</b></p> <p>Tímto Veoneer US, Inc. prohlašuje, že typ rádiového zařízení 7713CRN je v souladu se směrnicí 2014/53/EU. Úplné znění EU prohlášení o shodě je k dispozici na této internetové adrese: <a href="https://www.magna.com/type-approval/76-77-ghz/77v12flr">https://www.magna.com/type-approval/76-77-ghz/77v12flr</a> [<a href="https://www.magna.com/type-approval/76-77-ghz/77v12flr">https://www.magna.com/type-approval/76-77-ghz/77v12flr</a>]</p> <p>Provozní kmitočtové pásmo: 76 – 77 GHz/ Nejvyšší výstupní výkon:&lt;55 dBm peak eirp</p> <p><b>Danish</b></p> <p>Hermed erklærer Veoneer US, Inc., at radioudstyrstypen 7713CRN er i overensstemmelse med direktiv 2014/53/EU. EU-overensstemmelseserklæringens fulde tekst kan findes på følgende internetadresse: <a href="https://www.magna.com/type-approval/76-77-ghz/77v12flr">https://www.magna.com/type-approval/76-77-ghz/77v12flr</a> [<a href="https://www.magna.com/type-approval/76-77-ghz/77v12flr">https://www.magna.com/type-approval/76-77-ghz/77v12flr</a>]</p> <p>Driftsfrekvensområde: 76 – 77 GHz/ Maksimal udgangseffekt:&lt;55 dBm peak eirp</p> <p><b>Dutch</b></p> <p>Hierbij verklaar ik, Veoneer US, Inc., dat het type radioapparatuur 7713CRN conform is met Richtlijn 2014/53/EU. De volledige tekst van de EU-conformiteitsverklaring kan worden geraadpleegd op het volgende internetadres: <a href="https://www.magna.com/type-approval/76-77-ghz/77v12flr">https://www.magna.com/type-approval/76-77-ghz/77v12flr</a> [<a href="https://www.magna.com/type-approval/76-77-ghz/77v12flr">https://www.magna.com/type-approval/76-77-ghz/77v12flr</a>]</p> <p>Operationele frequentieband: 76 – 77 GHz/ Maximaal uitgangsvermogen:&lt;55 dBm peak eirp</p> <p><b>Estonian</b></p> <p>Käesolevaga deklareerib Veoneer US, Inc., et käesolev raadioseadme tüüp 7713CRN vastab direktiivi 2014/53/EL nõuetele. ELi vastavusdeklaratsiooni täielik tekst on kätesaadav järgmisel internetiaadressil: <a href="https://www.magna.com/type-approval/76-77-ghz/77v12flr">https://www.magna.com/type-approval/76-77-ghz/77v12flr</a> [<a href="https://www.magna.com/type-approval/76-77-ghz/77v12flr">https://www.magna.com/type-approval/76-77-ghz/77v12flr</a>]</p> <p>Töösagedusriba: 76 – 77 GHz/ Maksimalne väljundvõimsus:&lt;55 dBm peak eirp</p> <p><b>Finnish</b></p> <p>Veoneer US, Inc. vakuuttaa, että radiolaitetyyppi 7713CRN on direktiivin 2014/53/EU mukainen. EU-vaatimustenmukaisuusvakuutuksen täysimittainen teksti on saatavilla seuraavassa internetosoitteessa: <a href="https://www.magna.com/type-approval/76-77-ghz/77v12flr">https://www.magna.com/type-approval/76-77-ghz/77v12flr</a> [<a href="https://www.magna.com/type-approval/76-77-ghz/77v12flr">https://www.magna.com/type-approval/76-77-ghz/77v12flr</a>]</p> <p>Käyttöraajuusalue: 76 – 77 GHz/ Enimmäislähtäteho:&lt;55 dBm peak eirp</p> <p><b>French</b></p> <p>Le soussigné, Veoneer US, Inc., déclare que l'équipement radioélectrique du type 7713CRN est conforme à la directive 2014/53/UE. Le texte complet de la déclaration UE de conformité est disponible à l'adresse internet suivante: <a href="https://www.magna.com/type-approval/76-77-ghz/77v12flr">https://www.magna.com/type-approval/76-77-ghz/77v12flr</a> [<a href="https://www.magna.com/type-approval/76-77-ghz/77v12flr">https://www.magna.com/type-approval/76-77-ghz/77v12flr</a>]</p> <p>Bande de fréquences opérationnelle: 76 – 77 GHz/ Puissance de sortie max:&lt;55 dBm peak eirp</p> <p><b>German</b></p> <p>Hiermit erklärt Veoneer US, Inc., dass der Funkanlagentyp 7713CRN der Richtlinie 2014/53/EU entspricht. Der vollständige Text der EU-Konformitätserklärung ist unter der folgenden Internetadresse verfügbar: <a href="https://www.magna.com/type-approval/76-77-ghz/77v12flr">https://www.magna.com/type-approval/76-77-ghz/77v12flr</a> [<a href="https://www.magna.com/type-approval/76-77-ghz/77v12flr">https://www.magna.com/type-approval/76-77-ghz/77v12flr</a>]</p> <p>Betriebsfrequenzband: 76 – 77 GHz/ Maximale Ausgangsleistung:&lt;55 dBm peak eirp</p> <p><b>Greek</b></p> <p>Με την παρούσα ο/η Veoneer US, Inc., δηλώνει ότι ο ραδιοεξοπλισμός 7713CRN πληροί την οδηγία 2014/53/ΕΕ. Το πλήρες κείμενο της δήλωσης συμμόρφωσης ΕΕ διατίθεται στην ακόλουθη ιστοσελίδα στο διαδίκτυο: <a href="https://www.magna.com/type-approval/76-77-ghz/77v12flr">https://www.magna.com/type-approval/76-77-ghz/77v12flr</a> [<a href="https://www.magna.com/type-approval/76-77-ghz/77v12flr">https://www.magna.com/type-approval/76-77-ghz/77v12flr</a>]</p> <p>Ζώνη συχνότητας λειτουργίας: 76 – 77 GHz/ Μέγιστη Ισχύς Εξόδου:&lt;55 dBm peak eirp</p> |

| Regions | Labels and symbols | Specification   |
|---------|--------------------|---|
|         |                    | <p><b>Hungarian</b></p> <p>Veoneer US, Inc. igazolja, hogy a 7713CRN típusú rádióberendezés megfelel a 2014/53/EU irányelvnek. Az EU-megfelelőségi nyilatkozat teljes szövege elérhető a következő internetes címen: <a href="https://www.magna.com/type-approval/76-77-ghz/77v12flr">https://www.magna.com/type-approval/76-77-ghz/77v12flr</a> [<a href="https://www.magna.com/type-approval/76-77-ghz/77v12flr">https://www.magna.com/type-approval/76-77-ghz/77v12flr</a>]</p> <p>Működési frekvenciasáv: 76 – 77 GHz/ Maximum kimeneti teljesítmény:&lt;55 dBm peak eirp</p> <p><b>Icelandic</b></p> <p>Í þessu sambandi lýsir Veoneer US, Inc. að búnaður útvarpsbúnaðarins 7713CRN sé í samræmi við tilskipun 2014/53/EU. Fullkominn texti EU yfirlýsing um samræmi er að finna á eftirfarandi netfangi: <a href="https://www.magna.com/type-approval/76-77-ghz/77v12flr">https://www.magna.com/type-approval/76-77-ghz/77v12flr</a> [<a href="https://www.magna.com/type-approval/76-77-ghz/77v12flr">https://www.magna.com/type-approval/76-77-ghz/77v12flr</a>]</p> <p>Rekstrar tíðnisvið: 76 – 77 GHz/ Hámarks útgangsstyrkur:&lt;55 dBm peak eirp</p> <p><b>Italian</b></p> <p>Il fabbricante, Veoneer US, Inc., dichiara che il tipo di apparecchiatura radio 7713CRN è conforme alla direttiva 2014/53/UE. Il testo completo della dichiarazione di conformità UE è disponibile al seguente indirizzo Internet: <a href="https://www.magna.com/type-approval/76-77-ghz/77v12flr">https://www.magna.com/type-approval/76-77-ghz/77v12flr</a> [<a href="https://www.magna.com/type-approval/76-77-ghz/77v12flr">https://www.magna.com/type-approval/76-77-ghz/77v12flr</a>]</p> <p>Banda di frequenza operativa: 76 – 77 GHz/ Massima potenza di uscita:&lt;55 dBm peak eirp</p> <p><b>Latvian</b></p> <p>Ar šo Veoneer US, Inc. deklarē, ka radioiekārta 7713CRN atbilst Direktīvai 2014/53/ES. Pilns ES atbilstības deklarācijas teksts ir pieejams šādā interneta vietnē: <a href="https://www.magna.com/type-approval/76-77-ghz/77v12flr">https://www.magna.com/type-approval/76-77-ghz/77v12flr</a> [<a href="https://www.magna.com/type-approval/76-77-ghz/77v12flr">https://www.magna.com/type-approval/76-77-ghz/77v12flr</a>]</p> <p>Darba frekvenču josla: 76 – 77 GHz/ Maksimālā izejas jauda:&lt;55 dBm peak eirp</p> <p><b>Lithuanian</b></p> <p>Aš, Veoneer US, Inc., patvirtinu, kad radijo įrenginių tipas 7713CRN atitinka Direktyvą 2014/53/ES. Visas ES atitikties deklaracijos tekstas prieinamas šiuo interneto adresu: <a href="https://www.magna.com/type-approval/76-77-ghz/77v12flr">https://www.magna.com/type-approval/76-77-ghz/77v12flr</a> [<a href="https://www.magna.com/type-approval/76-77-ghz/77v12flr">https://www.magna.com/type-approval/76-77-ghz/77v12flr</a>]</p> <p>Darbinių dažnių diapazonas: 76 – 77 GHz/ Maksimali išėjimo galia:&lt;55 dBm peak eirp</p> <p><b>Maltese</b></p> <p>B'dan, Veoneer US, Inc., niddikjara li dan it-tip ta' tagħmir tar-radju 7713CRN huwa konformi mad-Direttiva 2014/53/UE. It-test kollu tad-dikjarazzjoni ta' konformità tal-UE huwa disponibbli f'dan l-indirizz tal-Internet li ġej: <a href="https://www.magna.com/type-approval/76-77-ghz/77v12flr">https://www.magna.com/type-approval/76-77-ghz/77v12flr</a> [<a href="https://www.magna.com/type-approval/76-77-ghz/77v12flr">https://www.magna.com/type-approval/76-77-ghz/77v12flr</a>]</p> <p>Il-banda tal-frekwenzi operattivi: 76 – 77 GHz/ L-Energija Massima Maħruġa:&lt;55 dBm peak eirp</p> <p><b>Norwegian</b></p> <p>Hermed erklærer Veoneer US, Inc. at radioutstyrtypen 7713CRN er i samsvar med direktiv 2014/53/EU. Den fulle teksten til EU-samsvarserklæringen er tilgjengelig på følgende internetadresse: <a href="https://www.magna.com/type-approval/76-77-ghz/77v12flr">https://www.magna.com/type-approval/76-77-ghz/77v12flr</a> [<a href="https://www.magna.com/type-approval/76-77-ghz/77v12flr">https://www.magna.com/type-approval/76-77-ghz/77v12flr</a>]</p> <p>Operasjonelt frekvensbånd: 76 – 77 GHz/ Maksimal utgangseffekt:&lt;55 dBm peak eirp</p> <p><b>Polish</b></p> <p>Veoneer US, Inc. niniejszym oświadczam, że typ urządzenia radiowego 7713CRN jest zgodny z dyrektywą 2014/53/UE. Pełny tekst deklaracji zgodności UE jest dostępny pod następującym adresem internetowym: <a href="https://www.magna.com/type-approval/76-77-ghz/77v12flr">https://www.magna.com/type-approval/76-77-ghz/77v12flr</a> [<a href="https://www.magna.com/type-approval/76-77-ghz/77v12flr">https://www.magna.com/type-approval/76-77-ghz/77v12flr</a>]</p> <p>Pasma częstotliwości roboczej: 76 – 77 GHz/ Maksymalna moc wyjściowa:&lt;55 dBm peak eirp</p> <p><b>Portuguese</b></p> <p>O(a) abaixo assinado(a) Veoneer US, Inc. declara que o presente tipo de equipamento de rádio 7713CRN está em conformidade com a Diretiva 2014/53/UE. O texto integral da declaração de conformidade está disponível no seguinte endereço de Internet: <a href="https://www.magna.com/type-approval/76-77-ghz/77v12flr">https://www.magna.com/type-approval/76-77-ghz/77v12flr</a> [<a href="https://www.magna.com/type-approval/76-77-ghz/77v12flr">https://www.magna.com/type-approval/76-77-ghz/77v12flr</a>]</p> <p>Faixa de frequência de funcionamento:76 - 77 GHz/ Potência de Saída Máxima:&lt;55 dBm peak eirp</p> <p><b>Romanian</b></p> <p>Prin prezenta, Veoneer US, Inc. declară că tipul de echipamente radio 7713CRN este în conformitate cu Directiva 2014/53/UE. Textul integral al declarației UE de conformitate este disponibil la următoarea adresă internet: <a href="https://www.magna.com/type-approval/76-77-ghz/77v12flr">https://www.magna.com/type-approval/76-77-ghz/77v12flr</a> [<a href="https://www.magna.com/type-approval/76-77-ghz/77v12flr">https://www.magna.com/type-approval/76-77-ghz/77v12flr</a>]</p> <p>Bandă frecvență operațională: 76 – 77 GHz/ Putere maximă la ieșire:&lt;55 dBm peak eirp</p> <p><b>Slovenian</b></p> <p>Veoneer US, Inc. potrjuje, da je tip radijske opreme 7713CRN skladen z Direktivo 2014/53/EU. Celotno besedilo izjave EU o skladnosti je na voljo na naslednjem spletnem naslovu: <a href="https://www.magna.com/type-approval/76-77-ghz/77v12flr">https://www.magna.com/type-approval/76-77-ghz/77v12flr</a> [<a href="https://www.magna.com/type-approval/76-77-ghz/77v12flr">https://www.magna.com/type-approval/76-77-ghz/77v12flr</a>]</p> <p>Operativni frekvenčni pas: 76 – 77 GHz/ Največja izhodna moč:&lt;55 dBm peak eirp</p> <p><b>Slovak</b></p> <p>Veoneer US, Inc. týmto vyhlasuje, že rádiové zariadenie typu 7713CRN je v súlade so smernicou 2014/53/EÚ. Úplné EÚ vyhlásenie o zhode je k dispozícii na tejto internetovej adrese: <a href="https://www.magna.com/type-approval/76-77-ghz/77v12flr">https://www.magna.com/type-approval/76-77-ghz/77v12flr</a> [<a href="https://www.magna.com/type-approval/76-77-ghz/77v12flr">https://www.magna.com/type-approval/76-77-ghz/77v12flr</a>]</p> <p>Prevádzkové frekvenčné pásmo: 76 – 77 GHz/ Maximálny výstupný výkon:&lt;55 dBm peak eirp</p> <p><b>Spanish</b></p> <p>Por la presente, Veoneer US, Inc. declara que el tipo de equipo radioeléctrico 7713CRN es conforme con la Directiva 2014/53/UE. El texto completo de la declaración UE de conformidad está disponible en la dirección Internet siguiente: <a href="https://www.magna.com/type-approval/76-77-ghz/77v12flr">https://www.magna.com/type-approval/76-77-ghz/77v12flr</a> [<a href="https://www.magna.com/type-approval/76-77-ghz/77v12flr">https://www.magna.com/type-approval/76-77-ghz/77v12flr</a>]</p> <p>Banda de frecuencias de funcionamiento: 76 – 77 GHz/ Potencia máxima de salida:&lt;55 dBm peak eirp</p> <p><b>Swedish</b></p> |











| Regions        | Labels and symbols  | Specification  |
|----------------|---|--|
| Thailand       |   | <p>1) [Placeholder text]</p> <p>2) [Placeholder text]</p>  |
| Ukraine        |  | <p>справжнім Veoneer заявляє, що тип радіобладнання (7713CRN) відповідає Технічному регламенту радіобладнання; повний текст декларації про відповідність доступний на веб-сайті за такою адресою: <a href="https://www.magna.com/type-approval/76-77-ghz/77v12flr">https://www.magna.com/type-approval/76-77-ghz/77v12flr</a> [<a href="https://www.magna.com/type-approval/76-77-ghz/77v12flr">https://www.magna.com/type-approval/76-77-ghz/77v12flr</a>]</p>  |
| United Kingdom |  | <p>Hereby, Veoneer US, Inc. declares that the radio equipment type 7713CRN is in compliance with radio regulation 2017. Operational frequency band: 76 – 77 GHz/ Maximum output power: &lt;55 dBm peak e.i.r.p<br/>The full text of the UK declaration of conformity is available at the following internet address: <a href="https://www.magna.com/type-approval/76-77-ghz/77v12flr">https://www.magna.com/type-approval/76-77-ghz/77v12flr</a> [<a href="https://www.magna.com/type-approval/76-77-ghz/77v12flr">https://www.magna.com/type-approval/76-77-ghz/77v12flr</a>]</p> |
| United States  |   | <p>This device complies with Part 15 of the FCC Rules. Operation is subject to the following two conditions:<br/>(1) this device may not cause harmful interference, and<br/>(2) this device must accept any interference received, including interference that may cause undesired operation.<br/>CAUTION TO USERS<br/>Changes or modifications not expressly approved by the party responsible for compliance could void the user's authority to operate the equipment.</p>  |

### 15.5.3. Type approval for TPMS radio frequency

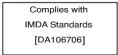
Here you will find the radio frequency type approvals for the tire pressure monitoring system.

| Region    | Specification  |
|-----------|--|
| Argentina |   |
| Canada    | <p>ISED Regulatory Compliance Statements<br/>This device contains licence-exempt that comply with Innovation, Science and Economic Development Canada's licence-exempt RSS(s). Operation is subject to the following two conditions:</p> <ol style="list-style-type: none"> <li>1. This device may not cause interference.</li> <li>2. This device must accept any interference, including interference that may cause undesired operation of the device.</li> </ol> <p>This equipment complies with ISED RSS-102 radio frequency exposure limits set forth by the Innovation, Science and Economic Development Canada for an uncontrolled environment. The further RF exposure reduction can be achieved if the product can be kept as far as possible from the user body or set the device to lower output power if such function available. This device must not be co-located or operating in conjunction with any other antenna or transmitter.</p> <p>Déclaration de conformité avec la réglementation d'ISDE<br/>Le présent appareil est conforme aux CNR d'Industrie Canada applicables aux appareils radio exempts de licence. L'exploitation est autorisée aux deux conditions suivantes:</p> <ol style="list-style-type: none"> <li>1. l'appareil ne doit pas produire de brouillage, et</li> <li>2. l'utilisateur de l'appareil doit accepter tout brouillage radioélectrique subi, même si le brouillage est susceptible d'en compromettre le fonctionnement.</li> </ol> <p>L'appareil est conforme aux limites d'exposition aux radiofréquences du CNR - 102 d'ISDE établies par innovation, sciences et développement économique Canada pour les environnements non contrôlés. L'exposition aux RF peut être encore réduite si le produit peut être placé aussi loin que possible du corps de l'utilisateur ou si la fonction peut être utilisée, l'appareil peut être réglé à une puissance de sortie inférieure. L'appareil ne doit pas coexister ou fonctionner en synergie avec d'autres antennes ou émetteurs.</p> |

| Region               | Specification  |
|----------------------|--|
| Mexico               | IFT NO.: VOSCAG23-34968  |
| Morocco              |   |
| Serbia               |   |
| Singapore            |   |
| South Africa         |   |
| Thailand             |   |
| United Arab Emirates |    |
| Ukraine              |   |
| United States        | <p>FCC Regulatory Compliance Statements</p> <p>This device complies with Part 15 of the FCC Rules. Operation is subject to the following conditions:</p> <ol style="list-style-type: none"> <li>1. This device may not cause harmful interference, and</li> <li>2. This device must accept any interference received, including interference that may cause undesired operation.</li> </ol> <p>Note: This equipment has been tested and found to comply with the limits for a Class B digital device, pursuant to Part 15 of the FCC Rules. These limits are designed to provide reasonable protection against harmful interference in a residential installation. This equipment generates, uses, and can radiate radio frequency energy and, if not installed and used in accordance with the instructions, may cause harmful interference to radio communications. However, there is no guarantee that interference will not occur in a particular installation. If this equipment does cause harmful interference to radio or television reception, which can be determined by turning the equipment off and on, the user is encouraged to try to correct the interference by one or more of the following measures:</p> <ul style="list-style-type: none"> <li>• Reorient or relocate the receiving antenna.</li> <li>• Increase the separation between the equipment and receiver.</li> <li>• Connect the equipment into an outlet on a circuit different from that to which the receiver is connected.</li> <li>• Consult the dealer or an experienced radio/TV technician for help.</li> </ul> <p>Caution: Changes or modifications not expressly approved by the party responsible for compliance could void the user's authority to operate the equipment.</p> <p>FCC Radiation Exposure Statement</p> <p>This equipment complies with the FCC portable RF exposure limit set forth for an uncontrolled environment and are safe for intended operation as described in this manual. The further RF exposure reduction can be achieved if the product can be kept as far as possible from the user body or set the device to lower output power if such function is available.</p> |

## 15.5.4. Type approvals for wireless charger and NFC

Below are the technical specifications and type approvals for the wireless charger and NFC reader.

The content of this manual represents the status of the user manual at the time of printing and may not be completely valid in future instances. For more information refer to the first page for the complete disclaimer note.

## Technical specification

The wireless charger and NFC reader are designed to work in ambient temperatures between -35 °C and 85 °C.

### Wireless charger

- Frequency Band: 127.7±10kHz
- Maximum Magnetic Field Strength: 65,69dBµA/m @10m

### NFC card reader

- Frequency Band 13.56MHz ±10%
- Maximum Magnetic Field Strength: 42dBµA/m @10m

## Declaration of conformity

|             |   |
|-------------|---|
| CE RED      | <p>Hefei Invispower Co.,Ltd., hereby declares that the radio equipment NFCR-INTERNAL (model: NFC-I-SX-21548) and Model-Wireless charging (model: WPC-15SN-21493) are in compliance with Directive 2014/53/EU.</p> <p>The Maximum Permissible Exposure (MPE) level for this equipment is based on a distance of 20 cm between the equipment and the human body. To comply with RF exposure requirements, it is recommended to maintain a distance of at least 20 cm between the equipment and body parts during use.</p>   |
| UKCA        | <p>Hefei Invispower Co.,Ltd., hereby declares that the radio equipment NFCR-INTERNAL (model: NFC-I-SX-21548) and Model-Wireless charging (model: WPC-15SN-21493) are in compliance with UK Radio Equipment Regulations (SI 2017/1206).</p>  |
| FCC ID & IC | <p>This device complies with part 15 of the FCC rules and with Canada's RSS-Gen, RSS-216 rules. Operation is subject to the following two conditions:</p> <ol style="list-style-type: none"><li>1. This device may not cause harmful interference, and</li><li>2. This device must accept any interference received, including interference that may cause undesired operation.</li></ol> <p>Any changed or modifications not expressly approved by the party responsible for compliance could void the user's authority to operate this equipment. FCC RF Radiation Exposure Statement: This equipment complies with FCC RF Radiation exposure limits set forth for an uncontrolled environment. This device and its antenna must not be co-located or operating in conjunction with any other antenna or transmitter. This equipment should be installed and operated with a minimum distance of 20 cm between the radiator and your body. Note: this equipment has been tested and found to comply with the limits for a Class B digital device, pursuant to part 15 of the FCC Rules. These limits are designed to provide reasonable protection against harmful interference in a residential installation. This equipment generates, uses and can radiate radio frequency energy and may cause harmful interference to radio communications if not installed and used in accordance with the instructions. However, there is no guarantee that interference will not occur in a particular installation. If this equipment does cause harmful interference to radio or television reception, which can be determined by turning the equipment off and on, the user is encouraged to try to correct the interference by one or more of the following measures:</p> <ul style="list-style-type: none"><li>• Reorient or relocate the receiving antenna.</li><li>• Increase the separation between the equipment and receiver.</li><li>• Connect the equipment into an outlet on a circuit different from the one to which the receiver is connected.</li><li>• Consult the retailer or an experienced radio/TV technician for help.</li></ul> <p>Déclaration d'avertissement ISED Son fonctionnement est soumis aux deux conditions suivantes:</p> <ol style="list-style-type: none"><li>1. Cet appareil ne doit pas provoquer d'interférences nuisibles, et</li><li>2. Cet appareil doit accepter toute interférence reçue, y compris les interférences pouvant entraîner un fonctionnement indésirable.</li></ol> <p>Les changements ou modifications non expressément approuvés par la partie responsable de la conformité peut annuler l'autorité de l'utilisateur à utiliser l'équipement. Déclaration d'exposition aux radiations RF de l'ISED: Cet équipement est conforme aux limites d'exposition aux rayonnements RF de l'ISED définies pour un environnement non contrôlé. Cet appareil et son antenne ne doivent pas être situés ou fonctionner conjointement avec une autre antenne ou un autre émetteur</p> |
| ANATEL      | <p>This equipment is not entitled to protection against harmful interference and may not cause interference to properly authorized systems. For more information, see the ANATEL website – <a href="https://www.gov.br/anatel">https://www.gov.br/anatel</a> [<a href="https://www.gov.br/anatel">https://www.gov.br/anatel</a>]</p> <p>Este equipamento não tem direito à proteção contra interferência prejudicial e não pode causar interferência em sistemas devidamente autorizados. Para maiores informações, consulte o site da ANATEL – <a href="https://www.gov.br/anatel">https://www.gov.br/anatel</a> [<a href="https://www.gov.br/anatel">https://www.gov.br/anatel</a>]</p>   |

|              |   |
|--------------|---|
| China (SRRC) | <p>“ ”</p> <p>ISM</p> <p>5000</p>   |
| Mexico       | <p>La operación de este equipo está sujeta a las siguientes dos condiciones : (1) es posible que este equipo o dispositivo no cause interferencia perjudicial y (2) este equipo o dispositivo debe aceptar cualquier interferencia , incluyendo la que pueda causar su operación no deseada</p> |
| Thailand     |    |

### 15.5.5. Key system certification

Here you can find certification for compliance to standards for distance-capable keys and the associated key readers.

#### General info

- BNCM Model GE1.
- UWB anchor Model GU1.
- NFC Reader: Model GR4.
- Key tag: Model GK2.

Manufacturer: Marquardt GmbH Rietheim-Weilheim, Germany. Made in China.















| Country/Region | Model/Product | Compliance   | Label |
|----------------|---------------|--|-------|
| FCC/IC         | GE-1          | <p>FCC Regulations: This device complies with Part 15 of the FCC Rules. Operation is subject to the following two conditions: (1) This device may not cause harmful interference, and (2) this device must accept any interference received, including interference that may cause undesired operation. This equipment has been tested and found to comply with the limits for a Class B digital device, pursuant to Part 15 of the FCC Rules. These limits are designed to provide reasonable protection against harmful interference in a residential installation. This equipment generates, uses and can radiate radio frequency energy and, if not installed and used in accordance with the instructions, may cause harmful interference to radio communications. However, there is no guarantee that interference will not occur in a particular installation. If this equipment does cause harmful interference to radio or television reception, which can be determined by turning the equipment off and on, the user is encouraged to try to correct the interference by one of the following measures: Reorient or relocate the receiving antenna. Increase the separation between the equipment and receiver. Connect the equipment into an outlet on a circuit different from that to which the receiver is connected. Consult the dealer or an experienced radio/TV technician for help. FCC Caution: Any changes or modifications not expressly approved by the party responsible for compliance could void the user's authority to operate this equipment. Radiation Exposure Statement: This equipment complies with FCC radiation exposure limits set forth for an uncontrolled environment. This equipment should be installed and operated with minimum distance 20cm between the radiator &amp; your body. IC[?] ISED Notice: This device complies with Industry Canada license-exempt RSS standard(s). Operation is subject to the following two conditions: 1) this device may not cause interference, and 2) this device must accept any interference, including interference that may cause undesired operation of the device. Le présent appareil est conforme aux CNR d'Industrie Canada applicables aux appareils radio exempts de licence. L'exploitation est autorisée aux deux conditions suivantes: 1) l'appareil ne doit pas produire de brouillage, et 2) l'utilisateur de l'appareil doit accepter tout brouillage radioélectrique subi, même si le brouillage est susceptible d'en compromettre le fonctionnement. This device and its antenna(s) must not be co-located or operating in conjunction with any other antenna or transmitter, except tested built-in radios. Cet appareil et son antenne ne doivent pas être situés ou fonctionner en conjonction avec une autre antenne ou un autre émetteur, exception faites des radios intégrées qui ont été testées. The County Code Selection feature is disabled for products marketed in the US/ Canada. La fonction de sélection de l'indicatif du pays est désactivée pour les produits commercialisés aux États-Unis et au Canada. Radiation Exposure Statement: This equipment complies with IC radiation exposure limits set forth for an uncontrolled environment. This equipment should be installed and operated with minimum distance 20cm between the radiator &amp; your body. Déclaration d'exposition aux radiations: Cet équipement est conforme aux limites d'exposition aux rayonnements IC établies pour un environnement non contrôlé. Cet équipement doit être installé et utilisé avec un minimum de 20 cm de distance entre la source de rayonnement et votre corps.</p> |       |





| Country/Region | Model/Product | Compliance  | Label |
|----------------|---------------|---|-------|
| FCC/IC         | GK2           | <p>WARNING: Do not ingest the battery, Chemical Burn Hazard (The remote control supplied with) This product contains a coin/button cell battery. If the coin/button cell battery is swallowed, it can cause severe internal burns in just 2 hours and can lead to death. Keep new and used batteries away from children. If the battery compartment does not close securely, stop using the product and keep it away from children. If you think batteries might have been swallowed or placed inside any part of the body, seek immediate medical attention. WARNING 1. Replacement of a battery with an incorrect type that can defeat a safeguard; Disposal of a battery into fire or a hot oven, or mechanically crushing or cutting of a battery, that can result in an explosion; Leaving a battery in an extremely high temperature surrounding environment that can result in an explosion or the leakage of flammable liquid or gas A battery subjected to extremely low air pressure that may result in an explosion or the leakage of flammable liquid or gas 2. The exclamation point within an equilateral triangle is intended to alert the user to the presence of important operating and maintenance (servicing) instructions in the literature accompanying the appliance. 3. CAUTION For coin/button battery used, please refer for further information to the user manual FCC [?] FCC Regulations: This device complies with Part 15 of the FCC Rules. Operation is subject to the following two conditions: (1) This device may not cause harmful interference, and (2) this device must accept any interference received, including interference that may cause undesired operation. This equipment has been tested and found to comply with the limits for a Class B digital device, pursuant to Part 15 of the FCC Rules. These limits are designed to provide reasonable protection against harmful interference in a residential installation. This equipment generates, uses and can radiate radio frequency energy and, if not installed and used in accordance with the instructions, may cause harmful interference to radio communications. However, there is no guarantee that interference will not occur in a particular installation. If this equipment does cause harmful interference to radio or television reception, which can be determined by turning the equipment off and on, the user is encouraged to try to correct the interference by one of the following measures: Reorient or relocate the receiving antenna. Increase the separation between the equipment and receiver. Connect the equipment into an outlet on a circuit different from that to which the receiver is connected. Consult the dealer or an experienced radio/TV technician for help. FCC Caution: Any changes or modifications not expressly approved by the party responsible for compliance could void the user's authority to operate this equipment. Radiation Exposure Statement: This equipment complies with FCC radiation exposure limits set forth for an uncontrolled environment. This equipment should be installed and operated with minimum distance 20cm between the radiator &amp; your body. Device may not be employed for the operation of toys. Operation onboard an aircraft, a ship or a satellite is prohibited. IC: ISED Notice: This device complies with Industry Canada license-exempt RSS standard(s). Operation is subject to the following two conditions: 1) this device may not cause interference, and 2) this device must accept any interference, including interference that may cause undesired operation of the device. Le présent appareil est conforme aux CNR d'Industrie Canada applicables aux appareils radio exempts de licence. L'exploitation est autorisée aux deux conditions suivantes: 1) l'appareil ne doit pas produire de brouillage, et 2) l'utilisateur de l'appareil doit accepter tout brouillage radioélectrique subi, même si le brouillage est susceptible d'en compromettre le fonctionnement. This device and its antenna(s) must not be co-located or operating in conjunction with any other antenna or transmitter, except tested built-in radios. Cet appareil et son antenne ne doivent pas être situés ou fonctionner en conjonction avec une autre antenne ou un autre émetteur, exception faites des radios intégrées qui ont été testées. The County Code Selection feature is disabled for products marketed in the US/ Canada. La fonction de sélection de l'indicatif du pays est désactivée pour les produits commercialisés aux États-Unis et au Canada. Radiation Exposure Statement: This equipment complies with IC radiation exposure limits set forth for an uncontrolled environment. This equipment should be installed and operated with minimum distance 20cm between the radiator &amp; your body. Déclaration d'exposition aux radiations: Cet équipement est conforme aux limites d'exposition aux rayonnements IC établies pour un environnement non contrôlé. Cet équipement doit être installé et utilisé avec un minimum de 20 cm de distance entre la source de rayonnement et votre corps.</p> |       |











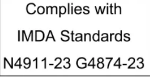
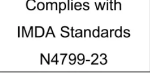



| Country/Region | Model/Product | Compliance  | Label |
|----------------|---------------|---|-------|
| FCC/IC         | GR4           | <p>FCC Regulations: This device complies with Part 15 of the FCC Rules. Operation is subject to the following two conditions: (1) This device may not cause harmful interference, and (2) this device must accept any interference received, including interference that may cause undesired operation. This equipment has been tested and found to comply with the limits for a Class B digital device, pursuant to Part 15 of the FCC Rules. These limits are designed to provide reasonable protection against harmful interference in a residential installation. This equipment generates, uses and can radiate radio frequency energy and, if not installed and used in accordance with the instructions, may cause harmful interference to radio communications. However, there is no guarantee that interference will not occur in a particular installation. If this equipment does cause harmful interference to radio or television reception, which can be determined by turning the equipment off and on, the user is encouraged to try to correct the interference by one of the following measures: Reorient or relocate the receiving antenna. Increase the separation between the equipment and receiver. Connect the equipment into an outlet on a circuit different from that to which the receiver is connected. Consult the dealer or an experienced radio/TV technician for help. FCC Caution: Any changes or modifications not expressly approved by the party responsible for compliance could void the user's authority to operate this equipment. Radiation Exposure Statement: This equipment complies with FCC radiation exposure limits set forth for an uncontrolled environment. This equipment should be installed and operated with minimum distance 20cm between the radiator &amp; your body. IC[?] ISED Notice This device complies with Industry Canada license-exempt RSS standard(s). Operation is subject to the following two conditions: 1) this device may not cause interference, and 2) this device must accept any interference, including interference that may cause undesired operation of the device. Le présent appareil est conforme aux CNR d'Industrie Canada applicables aux appareils radio exempts de licence. L'exploitation est autorisée aux deux conditions suivantes: 1) l'appareil ne doit pas produire de brouillage, et 2) l'utilisateur de l'appareil doit accepter tout brouillage radioélectrique subi, même si le brouillage est susceptible d'en compromettre le fonctionnement. This device and its antenna(s) must not be co-located or operating in conjunction with any other antenna or transmitter, except tested built-in radios. Cet appareil et son antenne ne doivent pas être situés ou fonctionner en conjonction avec une autre antenne ou un autre émetteur, exception faites des radios intégrées qui ont été testées. The County Code Selection feature is disabled for products marketed in the US/ Canada. La fonction de sélection de l'indicatif du pays est désactivée pour les produits commercialisés aux États-Unis et au Canada. Radiation Exposure Statement: This equipment complies with IC radiation exposure limits set forth for an uncontrolled environment. This equipment should be installed and operated with minimum distance 20cm between the radiator &amp; your body. Déclaration d'exposition aux radiations: Cet équipement est conforme aux limites d'exposition aux rayonnements IC établies pour un environnement non contrôlé. Cet équipement doit être installé et utilisé avec un minimum de 20 cm de distance entre la source de rayonnement et votre corps.</p> |       |
| FCC/IC         | GU1           | <p>FCC Regulations: This device complies with Part 15 of the FCC Rules. Operation is subject to the following two conditions: (1) This device may not cause harmful interference, and (2) this device must accept any interference received, including interference that may cause undesired operation. This equipment has been tested and found to comply with the limits for a Class B digital device, pursuant to Part 15 of the FCC Rules. These limits are designed to provide reasonable protection against harmful interference in a residential installation. This equipment generates, uses and can radiate radio frequency energy and, if not installed and used in accordance with the instructions, may cause harmful interference to radio communications. However, there is no guarantee that interference will not occur in a particular installation. If this equipment does cause harmful interference to radio or television reception, which can be determined by turning the equipment off and on, the user is encouraged to try to correct the interference by one of the following measures: Reorient or relocate the receiving antenna. Increase the separation between the equipment and receiver. Connect the equipment into an outlet on a circuit different from that to which the receiver is connected. Consult the dealer or an experienced radio/TV technician for help. FCC Caution: Any changes or modifications not expressly approved by the party responsible for compliance could void the user's authority to operate this equipment. Radiation Exposure Statement: This equipment complies with FCC radiation exposure limits set forth for an uncontrolled environment. This equipment should be installed and operated with minimum distance 20cm between the radiator &amp; your body. Device may not be employed for the operation of toys. Operation onboard an aircraft, a ship or a satellite is prohibited. IC[?] ISED Notice This device complies with Industry Canada license-exempt RSS standard(s). Operation is subject to the following two conditions: 1) this device may not cause interference, and 2) this device must accept any interference, including interference that may cause undesired operation of the device. Le présent appareil est conforme aux CNR d'Industrie Canada applicables aux appareils radio exempts de licence. L'exploitation est autorisée aux deux conditions suivantes: 1) l'appareil ne doit pas produire de brouillage, et 2) l'utilisateur de l'appareil doit accepter tout brouillage radioélectrique subi, même si le brouillage est susceptible d'en compromettre le fonctionnement. This device and its antenna(s) must not be co-located or operating in conjunction with any other antenna or transmitter, except tested built-in radios. Cet appareil et son antenne ne doivent pas être situés ou fonctionner en conjonction avec une autre antenne ou un autre émetteur, exception faites des radios intégrées qui ont été testées. The County Code Selection feature is disabled for products marketed in the US/ Canada. La fonction de sélection de l'indicatif du pays est désactivée pour les produits commercialisés aux États-Unis et au Canada. Radiation Exposure Statement: This equipment complies with IC radiation exposure limits set forth for an uncontrolled environment. This equipment should be installed and operated with minimum distance 20cm between the radiator &amp; your body.</p>   |       |







| Country/Region | Model/Product              | Compliance   | Label  |
|----------------|----------------------------|--|--|
| Israel         | BNCM <sup>®</sup> 51-93994 | מספר אישור התאמה מטעם משרד התקשורת: חל איסור לבצע פעולות במכשיר שיש בהן כדי לשנות את תכונותיו האלחוטיות של המכשיר, ובכלל זה שינוי תוכנה, החלפת אנטנה מקורית או הוספת אפשרות לחיבור לאנטנה חיצונית, בלא קבלת אישור משרד התקשורת, בשל החשש להפרעות אלחוטיות. |  |
| Israel         | UWB anchor: 51-93993       | מספר אישור התאמה מטעם משרד התקשורת: חל איסור לבצע פעולות במכשיר שיש בהן כדי לשנות את תכונותיו האלחוטיות של המכשיר, ובכלל זה שינוי תוכנה, החלפת אנטנה מקורית או הוספת אפשרות לחיבור לאנטנה חיצונית, בלא קבלת אישור משרד התקשורת, בשל החשש להפרעות אלחוטיות. |  |
| Israel         | key tag: 51-99616          | מספר אישור התאמה מטעם משרד התקשורת: חל איסור לבצע פעולות במכשיר שיש בהן כדי לשנות את תכונותיו האלחוטיות של המכשיר, ובכלל זה שינוי תוכנה, החלפת אנטנה מקורית או הוספת אפשרות לחיבור לאנטנה חיצונית, בלא קבלת אישור משרד התקשורת, בשל החשש להפרעות אלחוטיות. |  |
| Israel         | NFC Reader: 51-98998       | מספר אישור התאמה מטעם משרד התקשורת: חל איסור לבצע פעולות במכשיר שיש בהן כדי לשנות את תכונותיו האלחוטיות של המכשיר, ובכלל זה שינוי תוכנה, החלפת אנטנה מקורית או הוספת אפשרות לחיבור לאנטנה חיצונית, בלא קבלת אישור משרד התקשורת, בשל החשש להפרעות אלחוטיות. |  |
| Japan          | BNCM                       |  |  218-230158 |
| Japan          | UWB anchor                 |  |  218-230167 |
| Japan          | Key tag                    |  |  218-230159 |
| Japan          | NFC Reader                 |  | 総務省指定[MICROS]第AC-23100号  |

| Country/Region | Model/Product | Compliance  | Label   |
|----------------|---------------|---|---|
| Jordan         | All           | BNCM: TRC/34/11930/2023<br>UWB anchor: TRC/34/11931/2023<br>key tag: TRC/34/12858/2023<br>NFC reader: TRC/15/13157/2023 |   |
| Korea          | BNCM          |   | <br>R-R-MQU-GE1  |
| Korea          | UWB anchor    |   | <br>R-R-MQU-GU1  |
| Korea          | Key tag       |   | <br>R-R-MQU-GK2  |
| Korea          | NFC Reader    |   | <br>R-R-MQU-GR4  |
| Lebanon        | BNCM          |   |  5601/E&M/2023   |
| Lebanon        | UWB anchor    |   |  5599/E&M/2023   |
| Lebanon        | Key tag       |   |  9814/E&M/2023 |
| Lebanon        | NFC Reader    |   |  9817/E&M/2023 |

| Country/Region | Model/Product | Compliance  | Label  |
|----------------|---------------|---|--|
| Mexico         |               | BNCM: IFETEL:TEMAGE23-38667<br>UWB anchor: IFETEL:SYMAGU23-26221<br>key tag: IFETEL:TEMAGK23-44107<br>NFC Reader: IFETEL:SYMAGR23-34983 |  |
| Moldova        | All           |   |                         |
| Morocco        | BNCM          |   | <p>AGREE PAR L'ANRT MAROC</p> <p>Numéro d'agrément : MR00038206ANRT2023<br/>Date d'agrément : 20230517</p> |
| Morocco        | UWB anchor    |   | <p>AGREE PAR L'ANRT MAROC</p> <p>Numéro d'agrément : MR00038196ANRT2023<br/>Date d'agrément : 20230516</p> |
| Morocco        | Key tag       |   | <p>AGREE PAR L'ANRT MAROC</p> <p>Numéro d'agrément : MR00039920ANRT2023<br/>Date d'agrément : 20230912</p> |
| Morocco        | NFC Reader    |   | <p>AGREE PAR L'ANRT MAROC</p> <p>Numéro d'agrément : MR00040022ANRT2023<br/>Date d'agrément : 20230919</p> |
| Oman           | BNCM          |   | <p>OMAN-TRA<br/>TRA/TA-R/15622/23<br/>D202897</p>  |
| Oman           | UWB anchor    |   | <p>OMAN-TRA<br/>TRA/TA-R/15648/23<br/>D202897</p>  |
| Oman           | Key tag       |   | <p>OMAN-TRA<br/>TRA/TA-R/16718/23<br/>D202897</p>  |
| Oman           | NFC Reader    |   | <p>OMAN-TRA<br/>TRA/TA-R/16798/23<br/>D202897</p>  |
| Paraguay       | BNCM          |   |                       |
| Paraguay       | UWB anchor    |   |                       |
| Paraguay       | Key tag       |   |                       |
| Paraguay       | NFC Reader    |   |                       |
| Singapore      | BNCM          |   | <p>Complies with<br/>IMDA Standards<br/>N4800-23</p>   |

| Country/Region | Model/Product | Compliance | Label   |
|----------------|---------------|------------|---|
| Singapore      | UWB anchor    |            |    |
| Singapore      | Key tag       |            |    |
| Singapore      | NFC Reader    |            |    |
| Serbia         | All           |            |    |
| South Africa   | BNCM          |            |    |
| South Africa   | UWB anchor    |            |    |
| South Africa   | Key tag       |            |   |
| South Africa   | NFC Reader    |            |  |
| Thailand       | BNCM          |            |  |
| Thailand       | UWB anchor    |            |  |
| Thailand       | Key tag       |            |  |
| Thailand       | NFC Reader    |            |  |
| UAE            | BNCM          |            |  |
| UAE            | UWB anchor    |            |  |
| UAE            | Key tag       |            |  |
| UAE            | NFC Reader    |            |  |

| Country/Region | Model/Product | Compliance   | Label   |
|----------------|---------------|--|---|
| Ukraine        | BNCM          |  |  |
| Ukraine        | UWB anchor    |  |  |
| Ukraine        | Key tag       |  |  |
| Ukraine        | NFC Reader    |  |  |
| USA            |               | BNCM: FCC ID: IYZGE1. UWB anchor: FCC ID: IYZGU1. NFC Reader: FCC ID: IYZGR4. key tag: FCC ID: IYZGK2. |   |

## 15.6. Labels

Your vehicle has a number of labels that provide information about the vehicle and its use, such as specifications and warnings.

### Label types



Black ISO symbols on a yellow header with white text, or an illustration on a black background.

Indicates a risk of serious injury or death if the warning is ignored.



White ISO symbols and white text, or an illustration on a black or blue background.

Indicates a risk of material damage if the warning is ignored.



White ISO symbols and white text, or an illustration on a black background.

Contains information about the vehicle and its use.

 **Note**

### Depicted labels

Labels depicted in this manual are generic representations of those found around your vehicle. The manual only contains their location and what kind of information they contain. Find the actual label for specific information about your vehicle.