

S60 2024 (23w46) User Manual

Version 2026-04-09

Disclaimer

Due to the dynamic nature of our software-based product, the content of this PDF represents the most up-to-date version of the user manual as of the time of printing. As we continuously update and improve our product, certain content may not reflect the most up-to-date information in a future instance. Therefore, we strongly recommend utilizing the digital user manual app in your car's center display for the most accurate and up-to-date information. You can also access information in the Volvo Cars mobile app.

Please note that if you choose to print the manual, we cannot guarantee the validity of the information in future instances, as updates may have occurred since the time of printing. To ensure the highest level of safety and optimal product usage, we strongly advise relying on the digital user manual, which can be easily accessed through your car's center display.

This printable version is generic and does not correspond to your car. If there are discrepancies between this printable manual and the manual you see in your car's center display, the latter takes precedence.

Contents

1. [Consumer information](#)
 - 1.1 [About the user manual](#)
 - 1.1.1 [Reading the user manual](#)
 - 1.2 [Customer support and contact information](#)
 - 1.3 [Driver responsibility](#)
 - 1.4 [Modifications, repairs and accessory installations](#)
 - 1.5 [Certified technicians](#)
 - 1.6 [Information about recalls](#)
 - 1.7 [Reporting safety defects](#)
 - 1.8 [Finding the vehicle identification number](#)
 - 1.9 [Approval of terms and conditions and data collection](#)
 - 1.10 [Handling of recorded and collected data](#)
 - 1.11 [About connected services and the fair use policy](#)
 - 1.12 [Changing ownership of the vehicle](#)
 - 1.13 [Resetting user data](#)
 - 1.14 [Recommendations when changing regions](#)
2. [User accounts, profiles and services](#)
 - 2.1 [Setting up your vehicle for the first time](#)
 - 2.2 [Volvo ID](#)
 - 2.2.1 [Creating a Volvo ID](#)
 - 2.3 [Volvo Cars app](#)
 - 2.4 [Getting started with Google services](#)
 - 2.5 [Customization and settings](#)
 - 2.6 [Vehicle user profiles](#)
 - 2.6.1 [Switching profiles](#)
 - 2.6.2 [Adding a profile](#)
 - 2.6.3 [Removing a profile](#)
 - 2.6.4 [Assigning a key to a profile](#)
 - 2.6.5 [Managing keys assigned to profiles](#)
 - 2.6.6 [Restricting access to a profile](#)
 - 2.6.7 [Adding an account to a profile](#)

The content of this manual represents the status of the user manual at the time of printing and may not be completely valid in future instances. For more information refer to the first page for the complete disclaimer note.

- 2.7 Volvo Assistance
 - 2.7.1 Calling Volvo Assistance for roadside assistance
- 2.8 Emergency assistance
 - 2.8.1 Calling emergency services with SOS button
 - 2.8.2 Changing the emergency call recipient
- 2.9 HomeLink
- 3. Displays, software and phone
 - 3.1 Displays
 - 3.1.1 Center display
 - 3.1.1.1 Center display views
 - 3.1.1.2 Status symbols in the center display
 - 3.1.1.3 Restarting the center display
 - 3.1.1.4 Keyboard
 - 3.1.1.4.1 Changing the keyboard language
 - 3.1.1.4.2 Adding and removing keyboard languages
 - 3.1.2 Instrument panel
 - 3.1.2.1 Warning and indicator symbols
 - 3.1.2.2 Fuel gauge
 - 3.1.3 System settings
 - 3.1.3.1 Changing time and date
 - 3.1.3.2 Changing the system language
 - 3.1.3.3 Changing system units
 - 3.2 Phone
 - 3.2.1 Connecting your phone to the vehicle
 - 3.2.2 Using your phone in the vehicle
 - 3.2.3 Switching between paired phones
 - 3.2.4 Apple CarPlay
 - 3.2.5 Android Auto™
 - 3.3 Sound and media
 - 3.3.1 Radio
 - 3.3.1.1 Adding radio favorites
 - 3.3.2 Sound settings
 - 3.3.3 Media players
 - 3.4 In-vehicle apps
 - 3.4.1 Downloading apps
 - 3.4.2 Uninstalling apps
 - 3.5 Connectivity and software
 - 3.5.1 Internet connection
 - 3.5.1.1 Connecting to the internet via a Bluetooth-connected phone
 - 3.5.1.2 Connecting to the internet via Wi-Fi
 - 3.5.2 Restarting the vehicle's connectivity module
 - 3.5.3 Over-the-air updates
 - 3.6 Voice control
 - 3.6.1 Using voice control
- 4. Interior comfort and climate
 - 4.1 Interior
 - 4.1.1 USB ports
 - 4.1.2 12 V socket
 - 4.1.3 Sun visors
 - 4.2 Climate
 - 4.2.1 Climate controls
 - 4.2.1.1 Activating seat heating

- 4.2.1.2 Activating seat ventilation
 - 4.2.1.3 Activating the steering wheel heating
 - 4.2.2 Climate settings
 - 4.2.3 Temperature and air conditioning
 - 4.2.3.1 Activating air conditioning
 - 4.2.3.2 Setting the temperature
 - 4.2.3.3 Synchronizing temperature
 - 4.2.4 Air distribution and climate modes
 - 4.2.4.1 Adjusting air vents
 - 4.2.4.2 Activating auto climate mode
 - 4.2.4.3 Activating manual climate mode
 - 4.2.5 Ice, condensation and defrosters
 - 4.2.5.1 Activating max defroster
 - 4.2.5.2 Activating rear windshield and door mirror heating
 - 4.2.6 Interior climate when parked
 - 4.2.6.1 Keeping heating active after parking
 - 4.2.6.2 Air purification
 - 4.2.6.2.1 Activating air purification
 - 4.2.7 Air quality
 - 4.2.7.1 Air quality indication
 - 4.2.7.2 Air cleaning
 - 4.2.7.2.1 Advanced air cleaning
 - 4.2.7.3 CleanZone
 - 4.2.7.4 Activating air recirculation
 - 4.2.8 Climate system
 - 4.2.8.1 Climate zones
 - 4.2.8.2 Perceived and actual temperature
 - 4.2.8.3 Climate sensors
 - 4.3 Windows and glass panes
 - 4.3.1 Operating the windows
 - 4.3.2 Operating the panoramic roof
 - 4.3.3 Pinch protection
 - 4.3.4 Resetting windows
 - 4.4 Seats
 - 4.4.1 Front seats
 - 4.4.1.1 Adjusting the front seats
 - 4.4.1.2 Saving a preset seat adjustment
 - 4.4.1.3 Activating seat massage
 - 4.4.2 Rear seats
 - 4.4.2.1 Adjusting center rear seat headrest
 - 4.4.2.2 Folding down the outer rear seat headrests
 - 4.4.2.3 Folding down the outer rear seats
 - 4.4.2.4 Rear seat center armrest
 - 4.5 Interior lighting
 - 4.5.1 Adjusting the reading lights
 - 4.5.2 Adjusting interior lights
 - 4.5.3 Disabling interior auto lights
 - 4.5.4 Activating all interior lights
5. Safety
- 5.1 Collision response
 - 5.2 Occupant detection
 - 5.3 Proper seating

- 5.4 Seat belts
 - 5.4.1 Fastening and adjusting seat belt
 - 5.4.2 Setting seat belt to only retract
 - 5.4.3 Seat belt reminder
- 5.5 Airbags
 - 5.5.1 Airbag deployment
 - 5.5.2 Front airbags
 - 5.5.2.1 Sensor-controlled passenger airbag status
 - 5.5.3 Side airbags
 - 5.5.4 Inflatable curtains
 - 5.5.5 Airbag maintenance and servicing
 - 5.5.6 Airbag labels
- 5.6 Child safety
 - 5.6.1 Child restraints
 - 5.6.1.1 Installing child restraints
 - 5.6.1.1.1 Installing child restraints in the outer rear seat positions
 - 5.6.1.1.2 Installing child restraints in the center rear seat
 - 5.6.1.2 Child restraint attachment points
 - 5.6.1.2.1 ISOFIX/LATCH attachment points
 - 5.6.1.2.2 Top tether attachment points
 - 5.6.1.2.3 Lower tether attachment points
- 6. Entry and security
 - 6.1 Keys
 - 6.1.1 Standard key
 - 6.1.1.1 Detachable key blade
 - 6.1.2 Care Key
 - 6.1.2.1 Setting a speed limitation for the Care Key
 - 6.1.3 Key tag
 - 6.1.4 Replacing the standard key battery
 - 6.2 Opening and closing
 - 6.2.1 Opening the hood
 - 6.2.2 Closing the hood
 - 6.2.3 Trunk access
 - 6.2.3.1 Opening the trunk hands-free
 - 6.3 Locking and unlocking
 - 6.3.1 Keyless locking and unlocking
 - 6.3.2 Locking and unlocking using the key buttons
 - 6.3.3 Locking and unlocking using the detachable key blade
 - 6.3.4 Locking and unlocking from inside the vehicle
 - 6.3.5 Activating child lock
 - 6.3.6 Settings for locking and unlocking
 - 6.3.6.1 Adjusting locking and unlocking settings
 - 6.4 Anti-theft
 - 6.4.1 Alarm
 - 6.4.1.1 Activating and deactivating the alarm
- 7. Refueling
 - 7.1 Refueling your vehicle
 - 7.2 Fuel/Gasoline information
- 8. Driving
 - 8.1 Trips app
 - 8.2 Starting the vehicle

- 8.2.1 Startup checks
- 8.2.2 Alcohol lock
- 8.3 Turning the vehicle off
- 8.4 Driving characteristics
 - 8.4.1 Drive modes
 - 8.4.1.1 Selecting a drive mode
 - 8.4.2 Using the launch feature
 - 8.4.3 Activating start and stop
 - 8.4.4 Stability control
 - 8.4.5 Suspension
- 8.5 Range
 - 8.5.1 Trip meter
 - 8.5.1.1 Resetting the trip meter
- 8.6 Steering
 - 8.6.1 Steering wheel
 - 8.6.1.1 Steering wheel controls
 - 8.6.1.2 Adjusting the steering wheel position
 - 8.6.2 Adjusting steering feel
- 8.7 Brakes
 - 8.7.1 Foot brake
 - 8.7.2 Parking brake
 - 8.7.2.1 Engaging the parking brake
 - 8.7.3 Auto hold
 - 8.7.3.1 Enabling auto hold
 - 8.7.4 Post-impact braking
- 8.8 Transmission
 - 8.8.1 Selecting the gear
 - 8.8.2 Shifting gears manually
- 9. Visibility, mirrors, and exterior lights
 - 9.1 Exterior lights
 - 9.1.1 Driving lights
 - 9.1.1.1 Operating the driving lights
 - 9.1.1.2 High beam
 - 9.1.1.3 Passing beam
 - 9.1.1.3.1 Activating the low beams
 - 9.1.1.4 Active bending lights
 - 9.1.1.5 Activating the front fog lights
 - 9.1.1.6 Activating the rear fog light
 - 9.1.1.7 Activating the position lights
 - 9.1.1.8 Hazard warning lights
 - 9.1.1.8.1 Activating the hazard warning flashers
 - 9.1.2 Operating the turn signals
 - 9.1.3 Exterior convenience lights
 - 9.1.3.1 Welcome lights
 - 9.1.3.1.1 Enabling the welcome lights
 - 9.1.3.2 Guidance light
 - 9.1.3.2.1 Activating the guidance light
 - 9.2 Mirrors
 - 9.2.1 Enabling automatic dimming
 - 9.2.2 Adjusting door mirrors
 - 9.2.3 Folding door mirrors
 - 9.2.4 Resetting door mirror positions

- 9.3 Wipers and washers
 - 9.3.1 Controlling the front wipers
 - 9.3.2 Activating washers
- 10. Driver support and navigation
 - 10.1 Navigation
 - 10.1.1 Finding and selecting a navigation destination
 - 10.2 Detection of surroundings and traffic
 - 10.2.1 Locations of cameras, sensors and radar units
 - 10.2.2 Camera detection and limitations
 - 10.2.3 Radar detection and limitations
 - 10.2.4 Parking sensor detection and limitations
 - 10.3 Driver behavior detection
 - 10.4 Safety interventions and warnings
 - 10.4.1 Collision warnings and mitigation
 - 10.4.2 Interventions and warnings when reversing
 - 10.4.2.1 Alerts about traffic crossing behind the vehicle
 - 10.4.2.2 Disabling automatic braking when reversing
 - 10.4.3 Lane keeping aid
 - 10.4.3.1 Adjusting lane keeping aid
 - 10.4.4 Blind spot information
 - 10.4.5 Driver alert
 - 10.4.5.1 Disabling distraction alert notifications
 - 10.4.6 Connected safety
 - 10.4.6.1 Enabling connected safety
 - 10.4.7 Ready to drive notification
 - 10.4.7.1 Enabling ready to drive notification
 - 10.5 Assisted driving
 - 10.5.1 Road signs and speeding response
 - 10.5.1.1 Speed limit warnings
 - 10.5.1.1.1 Disabling speed limit warnings
 - 10.5.1.2 Enabling sound alerts for speed cameras
 - 10.5.1.3 Road sign information
 - 10.5.1.3.1 Enabling road sign information
 - 10.5.2 Pilot Assist
 - 10.5.2.1 Pilot Assist communication and status
 - 10.5.2.2 Activating Pilot Assist
 - 10.5.2.3 Deactivating Pilot Assist
 - 10.5.2.4 Adaptive cruise control
 - 10.5.2.5 Switching between Pilot Assist and adaptive cruise control while driving
 - 10.5.2.6 Adjusting the target speed for Pilot Assist
 - 10.5.2.7 Adjusting the time interval to vehicles ahead
 - 10.5.2.8 Selecting Pilot Assist as default driver support
 - 10.5.2.9 Pilot Assist conditions and limitations
 - 10.6 Assisted parking
 - 10.6.1 Parking view
 - 10.6.1.1 Disabling assisted parking sound alerts
- 11. Scenarios and driving recommendations
 - 11.1 Cold conditions
 - 11.1.1 Winter driving recommendations
 - 11.2 Recommendations for driving through water
 - 11.3 Preparations for a long trip

- 12. Storage, stowing and towing
 - 12.1 Passenger compartment storage
 - 12.1.1 Glove compartment
 - 12.2 Trunk space and storage
 - 12.2.1 Installing the safety net
 - 12.2.2 Opening the ski hatch
 - 12.2.3 Stowing cargo in the trunk
 - 12.3 Towing a trailer
 - 12.4 Determining the permitted gross vehicle weight
 - 12.5 Recommendations for loading
- 13. Care and maintenance
 - 13.1 Vehicle status
 - 13.2 Exterior cleaning and care
 - 13.2.1 Washing the exterior by hand
 - 13.2.2 Washing the vehicle in an automatic car wash
 - 13.2.3 Polishing and waxing
 - 13.2.4 Touching up paintwork damage
 - 13.2.4.1 Finding the paint color code
 - 13.2.5 Windshield damage
 - 13.2.6 Refilling washer fluid
 - 13.2.7 Cleaning wipers
 - 13.2.8 Replacing front wiper blades
 - 13.2.9 Activating the wiper service position
 - 13.2.10 Corrosion protection
 - 13.3 Interior cleaning and care
 - 13.3.1 Cleaning fabrics and textiles
 - 13.3.2 Cleaning leather or vinyl
 - 13.3.3 Cleaning glass and glossy surfaces
 - 13.3.4 Cleaning interior plastic, metal, and wood components
 - 13.3.5 Cleaning mats
 - 13.4 Wheels and tires
 - 13.4.1 Wheel and tire recommendations
 - 13.4.1.1 Tires and wheel storage
 - 13.4.1.2 Tire economy
 - 13.4.2 Designations on tire sidewall
 - 13.4.2.1 Tire tread wear indicators
 - 13.4.3 Changing wheels
 - 13.4.3.1 Spare wheel
 - 13.4.3.2 Winter tires
 - 13.4.3.3 Using snow chains
 - 13.4.4 Punctures
 - 13.4.5 Tire pressure
 - 13.4.5.1 Tire pressure monitoring
 - 13.4.5.1.1 Saving a new reference value for tire pressure monitoring
 - 13.4.5.2 Adjusting tire pressure
 - 13.4.6 Tire terminology
 - 13.5 Engine compartment
 - 13.5.1 Engine cooling system
 - 13.5.1.1 Refilling engine coolant
 - 13.5.2 Engine oil
 - 13.5.2.1 Refilling engine oil
 - 13.6 Vehicle electrical system and batteries

- 13.6.1 12 V battery
 - 13.6.1.1 Battery labels
- 13.6.2 48 V battery
- 13.6.3 Battery recycling
- 13.6.4 Fuses
 - 13.6.4.1 Replacing a fuse
 - 13.6.4.2 Fuse box in the trunk
 - 13.6.4.3 Fuse box in the engine compartment
 - 13.6.4.4 Fuse box underneath the glove compartment
- 13.7 Tools and equipment
 - 13.7.1 Using a warning triangle
 - 13.7.2 Attaching the towing eye
- 13.8 Raising the vehicle
 - 13.8.1 Workshop lifting areas
- 13.9 Servicing and repairs
 - 13.9.1 Booking service or repairs
 - 13.9.2 On-board diagnostic port
- 14. Immobilized vehicle and recovery
 - 14.1 Damaged vehicle
 - 14.2 Malfunction
 - 14.3 Vehicle has no power or is not responding
 - 14.3.1 Jump-starting your vehicle
 - 14.4 Recovery
 - 14.5 Safety mode
 - 14.6 Having your vehicle towed
- 15. Specifications
 - 15.1 General vehicle characteristics
 - 15.1.1 Vehicle dimensions
 - 15.1.2 Weights
 - 15.1.3 Towing specifications and capabilities
 - 15.1.4 Towbar specifications
 - 15.1.5 Type designations
 - 15.2 Powertrain specifications
 - 15.2.1 Engine specifications
 - 15.2.2 Fuel consumption
 - 15.2.3 Fuel tank volume
 - 15.3 Wheel and tire specifications
 - 15.3.1 Approved tire pressure
 - 15.4 Fluid specifications
 - 15.4.1 Engine oil specifications
 - 15.4.2 Transmission fluid specifications
 - 15.4.3 Brake fluid specifications
 - 15.4.4 Climate system specifications
 - 15.5 Certificates and type approvals
 - 15.5.1 Procedure to temporarily change the automatic high beam sensitivity
 - 15.5.2 Type approvals for radar
 - 15.5.3 Type approval for antenna
 - 15.5.4 Type approvals for HomeLink
 - 15.5.5 Type approval for on-board diagnostics port
 - 15.5.6 Type approval for anti-theft systems
 - 15.5.7 Key systems certification
 - 15.5.8 Advanced air cleaning certification

15.5.9 Instrument panel license agreements

15.6 Labels

1. Consumer information

There's a lot to learn about your Volvo vehicle. This section covers some essential topics, such as where you can find support if you need it and information about certain consumer rights and responsibilities.



Tip

Where to start?

Technically, the whole manual is recommended reading for anyone new to the vehicle. However, you can start by reading the information about how this manual works so you know how to find what you need.

Driver responsibility

The information about driver responsibility is also a good place to start reading. It covers some general principles for safe use of the vehicle and its features.

1.1. About the user manual

Learn how the user manual applies to using your vehicle, as well as where you can find the manual and how to navigate its content.

An important part of your vehicle

Your vehicle is a highly advanced product. However, as a well-designed product, advanced doesn't have to mean it's difficult to use. The aim here is to give you an intuitive experience, with natural interactions that work for both driver and passenger alike. This manual is designed to be a part of the vehicle, giving you information for safe and effective use. It is your resource on the vehicle's functions and features.



Tip

New user

If you are new to this vehicle, take some time to explore the different areas of the manual. Knowing the vehicle's capabilities and limitations is your responsibility and a necessity for safe and effective use.

Keep the manual up to date

Make sure that you keep the manual up to date by always having the latest version. Take a look any time a software update introduces changes or new features.

A guide to your vehicle's intended use

The manual establishes the vehicle's intended use, as defined by Volvo. Whenever you are directed to the manual, consider it an instruction to make absolutely sure that you are using the vehicle as intended. This is the recommendation, as both the descriptive and prescriptive parts of the manual provide important information that contributes to safe and effective use.

The content of this manual represents the status of the user manual at the time of printing and may not be completely valid in future instances. For more information refer to the first page for the complete disclaimer note.

Note

Intended use

If you use the vehicle in a manner which Volvo has not intended, it can negatively affect how it works. This includes shortening the vehicle's service life and limiting your ability to use the vehicle safely and effectively. It may also affect the validity of the vehicle warranty.

Volvo is not the only authority that defines proper use of the vehicle. It is your responsibility to use the vehicle in accordance with local laws and restrictions.

Accuracy in representing your vehicle

The primary goal of this manual is to accurately describe how your vehicle works. However, certain differences between produced vehicles are not reflected in the manual, such as colors, materials and certain equipment.

Note

Vehicles are equipped and adapted to meet specific market needs, as well as local legislation and requirements. Certain regional variations in configuration may not be reflected in the manual's content.

Where to find the manual

Your vehicle's user manual is available as an app in the vehicle's display, via the mobile app for the vehicle and at [volvocars.com/intl/support](https://www.volvocars.com/intl/support) [<https://www.volvocars.com/intl/support>].

Note

Volvo's support site

The version of the user manual on Volvo's support site is for a fully-equipped vehicle with all of the available options, functions and features. Therefore, it may differ from this user manual due to what's available in your vehicle.^[1]

Printed supplements

The manual is fully digital, but a selection of its content may be included with your vehicle as a printed supplement. The inclusion of printed supplements depends on your region and how your vehicle is configured.

Applicability

 **Important**

- Maintain and handle the vehicle according to Volvo's recommendations in the user manual. Volvo accepts no responsibility for damage or accidents if you disregard the instructions in this manual.
- It is recommended that you read all the user information before you drive for the first time.
- If you find information that differs from the information in your vehicle through other channels, such as the Volvo website, it is always the user information in the vehicle's display that is valid.
- Volvo works continuously to improve the quality of the user information and make it more accessible and useful. This means that descriptions and illustrations may change. Volvo reserves the right to make changes without prior notice.
- The original version of this user manual is written in British English. Therefore, there may be certain differences between the descriptions in the manual and the actual vehicle.
- The descriptions in this manual are based on general usage conditions. Remember that they can change depending on location, environment and driving behavior.
- No illustrations or texts in this manual may be copied without permission from Volvo.

^[1] Availability may vary between regions and equipment levels.

1.1.1. Reading the user manual

Learn how the content of this user manual is organized so that you can find what you need, when you need it.

Your vehicle's user manual is designed to guide you, both when you're looking for a specific piece of information and when you're simply exploring to learn more about your vehicle.

Structure

This manual is a large network of informational pages. Each page has its own content and might have a list of links that take you to related pages. The links can take you to subsections of the section you're in or to other sections that are connected to what you're currently reading.



Tip

Finding the right level of information

Sometimes the answer to what you're looking for might not lie in the details. Moving up a level or two in the structure might provide the context and perspective you need, or just a better idea of where to look.

Searching for information

You can use the search field for quicker access to what you're looking for.

All main areas

To get you started, the related information links on this page include all of the main sections in this user manual.

Navigate through interactive images

Some of the manual pages have images with interactive markers. You can tap these markers to reveal links to relevant parts of the manual. These interactive markers allow you to explore the user manual in a more visual way.



Tip

Animated introductions

Some pages show a short animation as an introduction. This provides you with a few visual hints of what you can expect to find in that part of the user manual.

Images and videos

Images in the user manual are sometimes schematic and intended to give an overview or an example. Images can differ from your vehicle due to equipment level or market requirements.

Highlighted content

You can find content that is highlighted in various ways throughout this user manual.



Warning

Content that is highlighted like this primarily provides information about conditions or use with a clear potential to cause severe harm to health.



Important

Content that is highlighted like this primarily provides information about conditions or use with a clear potential to cause material damage.

 **Note**

Content that is highlighted like this primarily contains information that can help you avoid incorrect use or information that is easily missed or misunderstood.

 **Tip**

Content that is highlighted like this primarily provides tips for use or where to find related content.

Equipment, accessories and features

Some equipment, accessories and features might be limited or only available for certain vehicle configurations or markets. Even if the information is available to you, it does not guarantee that the specific equipment, accessory or feature described is available in your vehicle.

 **Note**

There may be differences in terminology between the manual and materials used for marketing, sales and advertisements.

For more information on standard and optional equipment, contact Volvo Support.

1.2. Customer support and contact information

If you have any questions regarding your vehicle, you can find answers or solutions in a number of places. In addition to searching the user manual you are reading now, you can visit Volvo's website, Volvo's support site or contact Volvo Assistance.

Website and support site

Volvo's website [volvocars.com](https://www.volvocars.com) [https://www.volvocars.com] has several customer support resources.

The support section [volvocars.com/intl/support](https://www.volvocars.com/intl/support) [https://www.volvocars.com/intl/support] provides contact information, software news and answers to frequently asked questions. You can also find your closest Volvo retailer or contact Volvo via phone or chat.

Volvo Assistance

Volvo Assistance can offer help in the event of a breakdown or if your vehicle unexpectedly becomes immobilized. This includes roadside assistance. Volvo Assistance is available 24 hours a day, 7 days a week.

Press the assist button  on the roof or use the mobile app for the vehicle to contact Volvo Assistance.

Contact information

The content of this manual represents the status of the user manual at the time of printing and may not be completely valid in future instances. For more information refer to the first page for the complete disclaimer note.

For questions that can't be solved by Volvo's other support services, contact Volvo using the following information:

Volvo Vehicle Canada Ltd.

Customer Care Centre

9130 Leslie Street, Suite 101

Richmond Hill, Ontario L4B 0B9

Telephone: 1-800-663-8255

[volvocars.com/ca](https://www.volvocars.com/ca) [<https://www.volvocars.com/ca>]

1.3. Driver responsibility

As a driver, you are responsible for doing everything possible to ensure your own safety, as well as that of your passengers and other road users.

Your knowledge, decisions and actions determine how safely you drive. Your vehicle has features that, in certain situations, can compensate for mistakes and lapses in judgment. However, they do not change where the responsibility lies. They are a supplement to good driver practices, which you are responsible for as a driver.

You have likely studied and practiced to ensure you have the necessary knowledge and abilities to be a safe driver. This section covers a few essentials you may recognize, such as:

- Driving and using driver support functions
- Knowing the vehicle's capabilities and limitations
- Driver distraction
- Driver fatigue
- Laws and regulations

Driving and using driver support functions

You are responsible for adapting your driving to the current conditions, even when using driver support functions. This includes adapting your distance to other vehicles' speeds, as well as being ready to react to traffic and road hazards. Your vehicle's safety interventions and warnings rely on accurate detection and identification of surrounding traffic and road conditions. The detection systems cannot handle all driving, traffic, weather and road conditions.

Note

Driver support

Driver support functions can assist you with certain driving tasks and improve driving awareness. When used correctly, they can improve safety and convenience, but they are not a replacement for safe driving practices. Drive the vehicle with the same attention to safety as you would need to in a vehicle without these functions.

Knowing the vehicle's capabilities and limitations

The content of this manual represents the status of the user manual at the time of printing and may not be completely valid in future instances. For more information refer to the first page for the complete disclaimer note.

Before driving, all drivers are advised to familiarize themselves with the vehicle and any functions and features they might use. The driver has a responsibility to ensure they have sufficient knowledge of the vehicle to use it safely.

If you are uncertain about any of the vehicle's functions or have questions about its intended use, consult the manual. If you can't find the information you need, contact Volvo Support.

Driver distraction

Distractions reduce your attentiveness and focus when driving. As a driver, you are always responsible for assessing whether a task is safe to perform. Your assessment should take the situation as a whole into account, as well as specific conditions and circumstances that can cause distraction. It might be safe to adjust the volume when you're driving on a straight empty road, but not in more demanding situations, such as when overtaking.



Warning

Avoid distractions

Any task that prevents you from keeping your attention on the road and surrounding traffic should only be performed when the vehicle is parked. A few examples include:

- Do not hold your phone while driving. Local laws often restrict or forbid phone use while driving.
- Do not manually change the navigation route while driving.
- Do not change detailed sound settings while driving.

Driver responsibility and safety features

Your vehicle has several safety features designed to reduce the risk of an accident. They do not reduce the driver's responsibility to remain attentive or the need to operate the vehicle as safely as possible.



Tip

Help from passengers

Tasks that risk distracting the driver can often be done by a passenger instead. However, certain actions are simply not available in the vehicle when driving, such as reading this manual in the center display. For these actions, you need to be parked.

Voice commands

Voice commands can, in some situations, be less distracting than doing the same task manually.

Driver fatigue

The driver is always responsible for being well-rested. Your vehicle has some functions with abilities to warn you if you show signs of fatigue. It's important to always stop and take a break at the slightest feeling of fatigue, regardless of whether a function has given you a warning.

Laws and regulations

The driver is always responsible for knowing and following local laws and regulations. If you drive to a region with different traffic laws, make sure that the vehicle is equipped as required and read up on how the traffic laws differ from what you're used to.

1.4. Modifications, repairs and accessory installations

Modifications^[1], repairs and installation of accessories or extra equipment requires proper knowledge and quality of both work and parts. Otherwise, they risk impairing your vehicle's functionality and safety. Contact a Volvo retailer before making any alterations to your vehicle.

For any alterations^[2] to the vehicle, Volvo strongly recommends that:

- you seek prior advice of a trained and qualified Volvo service technician.
- work is only carried out by trained and qualified Volvo service technicians.
- installed parts and accessories are approved by Volvo.^[3]
- parts and accessories are installed according to their installation instructions.
- they comply with local laws and regulations.^[4]

Contact a Volvo retailer for more information.



Warning

Systems can be negatively affected

Unapproved or incorrectly installed accessories can negatively affect your vehicle's performance, communication and safety systems. Certain accessories only work with associated software that needs to be installed in the vehicle.

Electrical installations

For additional electrical installations, it is essential to use appropriate connection points to ensure the integrity of the vehicle's electrical system. The vehicle has a specific ground attachment point designated for aftermarket installations, which is separate from those reserved for critical components. Volvo recommends an authorized Volvo workshop for any electrical installations.

End-of-life handling

Some parts of the vehicle are dangerous to handle. Special handling is required when servicing or scrapping after the vehicle has reached its end-of-life.

- Electrical components in the vehicle^[5] may contain harmful substances and can deliver lethal electrical shock if handled incorrectly.
- Components such as airbag modules, seat belt tensioners, adaptable steering columns and button cell batteries may contain perchlorate materials.



Note

Non-approved changes and liability

Volvo does not accept any liability for damage, incurred cost, personal injury or death that is caused by changes to the vehicle^[6] not approved by Volvo.

- [1] Modifications include changes to the vehicle's software, including but not limited to tuning.
- [2] This means modifications, repairs and installation of accessories and extra equipment.
- [3] Accessories that are not approved by Volvo may not have been specifically tested for use with your vehicle.
- [4] This applies to both the act of making the alteration and subsequent use of the altered vehicle.
- [5] Such as batteries
- [6] Including but is not limited to modification, repair and installation of accessories or extra equipment.

1.5. Certified technicians

Ensure that the technicians handling your vehicle have the qualifications required to do so safely.

Certified technicians have met high competence requirements within specific areas. In addition to having passed the exam, every technician must also have worked in the field for at least two years before a certificate is issued. These professional technicians have the best capacity to analyze vehicle problems and carry out the maintenance that is necessary to keep your Volvo in the best possible condition.

Electric vehicles

Technicians who carry out work on vehicles with electric drive should also have the necessary training and special certification required to carry out repairs and/or maintenance on electrically powered vehicles.



Warning

A number of electrical components in vehicles with electric drive use current with high voltage and can be extremely dangerous if they are handled incorrectly. These components, as well as all orange-colored cables in the vehicle, must only be handled by trained and qualified Volvo service technicians.

1.6. Information about recalls

It is important that you stay updated about open recalls.

To find out if your vehicle has any open recalls, you can:

- Contact an authorized Volvo retailer or Volvo support

The content of this manual represents the status of the user manual at the time of printing and may not be completely valid in future instances. For more information refer to the first page for the complete disclaimer note.

- Search the recall database on the Transport Canada website www.tc.gc.ca [<https://tc.canada.ca/>]

 **Note**

You will need your vehicle's vehicle identification number^[1] to check if it's affected by a recall or safety alert.

^[1] VIN

1.7. Reporting safety defects

If you think there is a safety defect with your vehicle, you need to report it to the correct authorities. The following information is phrased according to external legal requirements.

If you think your vehicle has a defect that may cause an accident, or that may cause injuries or death, you must immediately notify both Transport Canada and Volvo Car Canada Ltd.

You can contact Transport Canada at:

Telephone: 1-866-995-9737

Teletypewriter (TTY): 1-888-675-6863

Fax: 613-954-4731

Mailing address: Transport Canada - 330 Sparks St, Ottawa, (Ontario) K1A 0N5

Website: www.tc.gc.ca [<https://tc.canada.ca/>]

1.8. Finding the vehicle identification number

There are several ways to find your vehicle's unique vehicle identification number.^[1] You might need your vehicle's VIN if you contact Volvo about any questions or problems regarding your vehicle.

You can find the number in one of the following ways:

- In the center display.
- On a label on the dashboard, close to the bottom edge of the windshield. It can typically be read from outside the vehicle.
- In the vehicle's registration documentation.
- By contacting a service technician, who can retrieve it through the on-board diagnostics socket.

In the center display

1. Press the vehicle symbol  in the bottom bar and go to **Settings**.
2. Go to **System** → **About** → **VIN number**.

^[1] VIN

1.9. Approval of terms and conditions and data collection

You will see messages about different terms and conditions and data collection^[1] in the center display. Your agreement is necessary for certain apps and services to work properly.

The first time you use your vehicle, a guide opens in the center display to assist you in making various settings. In connection with the guide, you are prompted to consent to different types of terms and conditions and the collection of information. You can do this later in privacy settings as well.

You may also need to give your consent in other situations, such as when you:

- Use an app or service for the first time.
- Add a new profile.
- Delete a profile.
- Change the ownership of the vehicle.
- Reset user data or do a factory reset.

If you decide not to accept the privacy settings, you may not experience full functionality from apps and services.

Manage privacy settings

1. Press the vehicle symbol  in the bottom bar and go to **Settings**.

2. Go to **Privacy**.

3. Select the privacy setting you want to change and follow the instructions in the center display.

 **Note**

Sharing data with Volvo

You can manage your consent to sharing data with Volvo in privacy settings.

Before using the internet

The terms of use must be accepted once per vehicle in order to use the internet.

Vehicle location sharing

You need to enable location sharing in your vehicle to use certain apps and functions. For example, location sharing is required to use remote vehicle services via Volvo Assistance and for apps such as Find my vehicle and the Trips app.

^[2] Maps features also rely on location sharing. If you disable location sharing via the privacy settings, location sharing is also disabled for any features or apps that use it.

 **Note**

General Privacy Notice

Depending on your market, Volvo Cars may collect and process different types of personal data for various purposes. You can find more information about how Volvo Cars processes your personal data in the Volvo Cars General Privacy Notice available on Volvo's website. If there are any differences between the user manual and the privacy notice related to the processing of personal data, the privacy notice takes precedence.

^[1] Data is collected to provide better vehicle, safety and app functions.

^[2] The Trips app can then collect data such as the vehicle's position, speed, mileage and power consumption.

1.10. Handling of recorded and collected data

Certain information about the vehicle's status and operation is recorded and collected for quality and safety reasons. This can provide an understanding of the circumstances around traffic accidents involving the vehicle and other usage scenarios.

Event Data Recorder (EDR)

This vehicle is equipped with an event data recorder (EDR). The main purpose of an EDR is to record, in certain crash or near crash-like situations, such as an air bag deployment or hitting a road obstacle, data that will assist in understanding how a vehicle's systems performed. The EDR is designed to record data related to vehicle dynamics and safety systems for a short period of time, typically 30 seconds or less. The EDR in this vehicle is designed to record such data as:

- How various systems in your vehicle were operating;
- Whether or not the driver and passenger seat belts were buckled/fastened;
- How far (if at all) the driver was depressing the accelerator and/or brake pedal; and,
- How fast the vehicle was traveling.

These data can help provide a better understanding of the circumstances in which crashes and injuries occur. NOTE: EDR data is recorded by your vehicle only if a non-trivial crash situation occurs; no data is recorded by the EDR under normal driving conditions and no personal data (e.g., name, gender, age, and crash location) is recorded. However, other parties, such as law enforcement, could combine the EDR data with the type of personally identifying data routinely acquired during a crash investigation.

To read data recorded by an EDR, special equipment is required, and access to the vehicle or the EDR is needed. In addition to the vehicle manufacturer, other parties, such as law enforcement, that have the special equipment, can read the information if they have access to the vehicle or the EDR.

Additional recorded data

In addition to the EDR, the vehicle is equipped with a number of computers designed to continually check and monitor the vehicle's functioning. They can record data during normal driving conditions, but in particular record faults affecting the vehicle's operation and functionality, or upon activation of the vehicle's active driver support function.

Some of the recorded data is required to enable service and maintenance technicians to diagnose and remedy any faults that occurred in the vehicle. The recorded information is also needed to enable Volvo to satisfy legal requirements laid out in laws and government regulations. Information registered in the vehicle is stored in its computer until the vehicle is serviced or repaired.

In addition to the above, the registered information can be used in combined form for research and product development with the aim of continuously improving the safety and quality of Volvo vehicles.

Volvo will not contribute to the above-described information being disclosed to third parties without the vehicle owner's consent. To comply with national legislation and regulations, Volvo may be forced to disclose information of this nature to the police or other authorities who may assert a legal right to access such information. Special technical equipment which Volvo and workshops that have entered into agreements with Volvo have access to is required to be able to read and interpret the recorded data. Volvo is responsible for ensuring that the information, which is transferred to Volvo during servicing and maintenance, is securely stored and managed and that its management complies with relevant legal requirements. For further information, contact a Volvo retailer.

TCAM

Vehicles equipped with TCAM can share data with Volvo about the vehicle's safety functions as well as other functions in the vehicle. Data are collected for product development, quality follow-up and safety work, as well as to improve and monitor the vehicle's quality and its safety functions. The purpose of data collection is also to manage Volvo Car Corporation's warranty undertakings, as well as to meet legal requirements related to engine emissions data.

1.11. About connected services and the fair use policy

Use of your vehicle's connected services is subject to certain conditions.

Where Volvo Cars is responsible for the provision of mobile connectivity services to enable use of certain functions, and excluding any separate contract for mobile connectivity services of the owner or any other user of the vehicle that Volvo Cars is not party to, each user understands and agrees that, to the extent permitted by law: (1) they have no contractual relationship with the underlying wireless service carrier, (2) they are not a third-party beneficiary of any agreement between the vehicle owner and the underlying carrier, (3) the underlying carrier has no liability of any kind to the user, whether for breach of contract, warranty, negligence, strict liability in tort or otherwise, (4) data transmissions and messages may be delayed, deleted or not delivered, and emergency calling may not be completed, (5) the underlying carrier cannot guarantee the security of wireless transmissions and will not be liable for any lack of security relating to the use of the services.

Fair use policy

Your use of the connectivity services which are part of your vehicle is subject to this fair use policy.

When using these services, you agree not to:

- submit content that is unlawful, obscene, libelous, threatening, harassing, hateful, racially or ethnically offensive or otherwise inappropriate
- use the services in breach of any applicable law
- use the services for commercial purposes.

Your access to these services is part of a shared access. Volvo reserves the right to suspend your access to or use of the services if your use involves very high volumes of data, disproportionate to other users. Volvo may also suspend your access for technical reasons or to protect other functions of your vehicle.

1.12. Changing ownership of the vehicle

The driver of the vehicle must be registered with Volvo in order to use all available functions and services. Therefore, when there is a change of ownership, the current owner needs to be removed to give the new owner access.

The current owner needs to end their ownership by removing the vehicle connection in the Volvo Cars app or by visiting a Volvo retailer. The new owner can also get help with registering their ownership by contacting a Volvo retailer or Volvo support.

Note

Reset the vehicle

When the current owner has ended their ownership, an automatic factory reset of the vehicle takes place. This means that profiles, user data and other individual settings are removed.

No owner?

If the vehicle doesn't have an owner, you can claim the ownership by connecting your Volvo ID to your profile in profile settings via the center display. Make sure that you have two keys in the vehicle as you will need both of them for the setup process.

1.13. Resetting user data

You can reset the user data and system settings in the center display.

You can reset the app settings or network settings to their standard values or do a complete factory reset. If you do a factory reset, you will delete profiles, user data and other customized settings.

Note

Owner

Only the owner can reset the network settings and do a factory reset.

App connection

If you do a factory reset in the vehicle, the app will still be connected and may recreate your profile using cloud data. To avoid this, you need to remove the vehicle connection in the Volvo Cars app.

1. Press the vehicle symbol  in the bottom bar and go to **Settings**.
2. Go to **System** → **Reset options**.
3. Select what you want to reset and follow the instructions in the center display.

1.14. Recommendations when changing regions

When relocating or importing your vehicle to a new region, you need to register your vehicle and Volvo ID there. This is to make sure that digital services work correctly and that the vehicle complies with local laws and regulations.

To get help registering your vehicle in a new region, contact Volvo Support.

Note

Available services

Available services may vary over time and depend on region. This may also have an effect when visiting another region temporarily.

Exporting your vehicle to another country

Do not export your Volvo to another country before researching the country's safety and exhaust emission requirements. In some cases, it may be difficult or impossible to meet these requirements. Modifying the emission control system may cause your Volvo to lose certification for legal use in the U.S., Canada and other countries.

2. User accounts, profiles and services

Get more out of your vehicle by customizing it using profiles and connecting it to the phone app. This gives you access to more features and services, such as support if you're having issues on the road.

Note

Some of the services available for your vehicle require a registered personal account, such as your Volvo ID.

To get the most out of your vehicle experience:

- Connect your Volvo ID
- Download and sign in to the Volvo Cars app on your phone
- Set up your user profile and customize the vehicle's settings, such as ergonomic settings and other preferences
- Sign in with your Google account

2.1. Setting up your vehicle for the first time

There is a guide that helps you set up your vehicle the first time you use it.

The setup guide for your vehicle automatically starts in the center display. It guides you through setting up the owner profile and other essential settings.

Tip

Before getting your vehicle

Before you start, you will need to create a Volvo ID and download the Volvo Cars app. This makes the in-vehicle setup faster.

The setup guide covers the following:

- Important settings, such as your vehicle's system language
- Connecting the vehicle to your Volvo ID and the Volvo Cars app
- Consent to terms and conditions for various vehicle services, including third-party services
- Setting up Internet access
- Consent to software updates
- Setting up your profile

 **Note**

Stay parked during setup

The vehicle needs to be stationary and in P when you go through the setup guide.

Complete setup

It is advisable to complete the setup before driving the vehicle. If you exit the guide before going through the necessary steps, certain features will be unavailable until you complete the process. You will be reminded about the setup the next time you drive the vehicle. You can also go to profile settings and complete it whenever you want to.

No guide?

If the vehicle has already been set up by someone else, such as a previous owner, you can reset the vehicle by ending the ownership. This will allow you to access the setup guide again.

2.2. Volvo ID

Your Volvo ID is a personal account that gives you access to various services connected to your vehicle. You can connect your Volvo ID to your profile in profile settings.

You will need your Volvo ID when you use remote features via the Volvo Cars app.

 **Note**

Available services can vary over time and depend on both region and equipment level.

 **Tip**

You can also connect your Volvo ID to your profile in settings.

2.2.1. Creating a Volvo ID

Create your Volvo ID in the Volvo Cars app on your phone or on Volvo's website.

If you want to use the Volvo Cars app to create your Volvo ID, make sure that you have the latest version installed on your phone.

1. Open the app on your phone or go to [volvocars.com](https://www.volvocars.com) [<https://www.volvocars.com>].

 **Note**

If you use the website, make sure that you are signed in.

2. Select the option to create a new Volvo ID and follow the instructions.

 **Note**

After creating your Volvo ID, you may need to confirm your email address to fully activate your account.

2.3. Volvo Cars app

The Volvo Cars app allows you to control certain functions and interact with the vehicle via your phone.

The Volvo Cars app is available for iPhone and Android phones. You can download it for free from your phone's app store. The app is updated regularly, so make sure that you have the latest version on your phone.

 **Note**

Sign in with your Volvo ID

You need to sign in to the app and the vehicle using the same Volvo ID.

Give your consent

Give your consent to Volvo services in privacy settings to be able to connect the app to the vehicle.

Check the internet connection

The Volvo Cars app and your vehicle need to be connected to the internet for all services to work properly.

Here are a few things you can do in the Volvo Cars app: ^[1]

- Check the fuel level, lock status and other vehicle statuses
- Lock and unlock doors
- Start and stop parking climate control
- Contact Volvo for more assistance
- View your account information

 **Note**

If you haven't used your vehicle for a few days, you will not be able to use the remote functions via the app. The functions will be available again when you start your vehicle.

^[1] Available services may vary over time and depend on region.

2.4. Getting started with Google services

Signing in with your Google account gives you a personalized experience when using Google services and apps such as Maps.

To sign in to your Google account and take full advantage of Google services, the vehicle needs to be connected to the internet.

1. If you don't already have a Google account, go to accounts.google.com/signup and create one.
 2. Sign in using your Google account via the center display and follow the instructions.
-

2.5. Customization and settings

You can customize many of your vehicle's features and behaviors by accessing its settings.

Where to find settings

Settings and adjustments are available in the following places:

- The settings tab in the display contains most of your vehicle settings and adjustments. To access it, press the vehicle symbol  in the bottom bar and go to **Settings**. There are several categories to explore within the tab.
- Some views and in-vehicle apps have their own settings sections. Open the app or view and look around to find available customization options.
- The mobile app for the vehicle has settings related to remote and connected features.

Setting types

Your vehicle's settings apply differently depending on their type. Most settings are specific to a user profile, but some apply to all users of the vehicle. A few settings are only available to adjust when the owner profile is in use, since only it has administrative privileges.



Tip

Customized experience

Set up user profiles for all drivers to get a customized experience. There are many profile-specific settings that are applied automatically when you select your profile.

Some settings apply indefinitely from the moment you change them, while others may only be temporarily applied, such as until the end of the current drive.

2.6. Vehicle user profiles

For a more customized experience, you can set up user profiles for different drivers.

To access all of your vehicle's features, you need to set up the owner profile. You can then add co-driver profiles for more users. Having individual user profiles allows each driver to save customized settings and adjustments that are automatically applied when their profile is selected.

Profile type	Who uses it?
--------------	--------------

Owner	The permanent user profile for the owner of the vehicle.
Guest	A guest user profile that's available for temporary users of the vehicle.
Co-driver	Up to five additional user profiles for regular users of the vehicle.

The owner has all the administrative privileges, while the co-drivers have some of them. The guest can make some adjustments, but the guest profile resets when you start using another profile.

You can find the profile settings in settings, where you can do the following:

- Add and switch profiles
- Restrict access to your profile
- Connect the Volvo Cars app to the vehicle
- Connect keys to your profile
- Change your profile name
- Sign out from a profile
- Remove your profile, if you are a co-driver

The owner can also do the following:

- Remove co-driver profiles.
- Enable a Care key and set a speed limitation for it.

The content of this manual represents the status of the user manual at the time of printing and may not be completely valid in future instances. For more information refer to the first page for the complete disclaimer note.

2.6.1. Switching profiles

You can switch between profiles in the center display.

 **Note**

Only available while stationary

It's only possible to switch profiles when the vehicle is stationary and in P. It's also unavailable during certain tasks.

Can't switch?

If you have problems switching to another profile, you will just stay in the current profile. Try again later.

Locked profile?

You might need a PIN or pattern to unlock a profile before using it. If it's not your profile, you can switch to your own profile instead or create a new profile.

1. Press the vehicle symbol  in the bottom bar and go to **Settings**.
2. Go to **Profiles**.
3. Select your profile.

 **Tip**

You can also switch profiles by opening the notification center and selecting your profile from the profile picker.

2.6.2. Adding a profile

You can add new profiles in the center display.

When you add a new profile, the setup guide starts automatically in the center display. It guides you through all of the essential settings.

 **Note**

If you don't complete the setup guide, some features and services will be unavailable.

 **Tip**

The owner can invite new co-drivers in the Volvo Cars app. The vehicle then automatically creates a new profile for that co-driver's Volvo ID in the vehicle.

Add a profile in profile settings

1. Press the vehicle symbol  in the bottom bar and go to **Settings**.

 **Tip**

You can also press the profile symbol at the top for quicker access to profile settings.

2. Go to **Profiles**.
3. Press **Add new** and follow the instructions in the center display.

2.6.3. Removing a profile

You can remove your user profile in the center display.

 **Note**

You cannot remove the owner or the guest profile, but you can reset them. If you want to reset the owner profile, you need to do a factory reset. The owner profile also resets when you end your ownership. The guest profile resets when you switch to another profile.

1. Press the vehicle symbol  in the bottom bar and go to **Settings**.

 **Tip**

You can also press the profile symbol at the top for quicker access to profile settings.

2. Go to **Profiles**.
 3. Select **Remove this profile**.
- > The vehicle will switch to the guest profile automatically.

 **Tip**

The owner can remove co-driver profiles in the vehicle by going to **Manage other profiles** in profile settings. The owner can also remove user profiles from the vehicle via the Volvo Cars app. This only works if a profile is connected to a Volvo ID; otherwise it won't show up in the mobile app.

2.6.4. Assigning a key to a profile

You can assign keys to your profile.

In the setup guide

You can assign a key to your profile during the setup guide. When it's time, place your key on the backup key reader and follow the instructions in the center display. You can also do this later in profile settings.

 **Tip**

Assign a key to your profile so that your profile is automatically selected when you unlock the vehicle or open the driver's door using the key. If you use a key that's not assigned to any profile, the most recently used profile will be selected.

Assigning a key to a profile in Profile settings

1. Press the vehicle symbol  in the bottom bar and go to **Settings**.

 **Tip**

You can also press the profile symbol at the top for quicker access to profile settings.

2. Go to **Profiles** → **Car keys**.
3. Select the key you want to assign and follow the instructions in the center display.

 **Note**

If the key is already assigned to another profile, it will be moved to your profile instead.

2.6.5. Managing keys assigned to profiles

You can manage your assigned keys in profile settings.

 **Note**

You can only remove keys that are connected to your own profile.

1. Press the vehicle symbol  in the bottom bar and go to **Settings**.

 **Tip**

You can also press the profile symbol at the top for quicker access to profile settings.

2. Go to **Profiles** → **Car keys**.
 - > You will see a list of all the assigned keys.
3. Select the key you want to manage and follow the instructions in the center display.

2.6.6. Restricting access to a profile

You can restrict access to a profile by adding a profile lock in the center display. When a profile lock is active, you need a PIN or pattern to unlock the profile.

1. Press the vehicle symbol  in the bottom bar and go to **Settings**.

 **Tip**

You can also press the profile symbol at the top for quicker access to profile settings.

2. Go to **Profiles** → **Profile lock**.
3. Select your preferred lock type and follow the instructions in the center display.

2.6.7. Adding an account to a profile

You can add different accounts to your profile, such as your Volvo ID and accounts for third-party apps.

 **Tip**

You can also connect your Volvo ID to your profile in profile settings.

Adding your Volvo ID to your profile allows you to access the vehicle via the mobile app.

1. Press the vehicle symbol  in the bottom bar and go to **Settings**.
 2. Go to **System** → **Accounts**.
 3. Select **Add account**.
- > You will see a list of possible accounts to add.
4. Select the account you want to add and follow the instructions in the center display.

If you want to remove an account from your profile, select the account and press **Remove**.

2.7. Volvo Assistance

Volvo Assistance is a service that provides assistance and remote access to certain vehicle features. You can contact a Volvo Assistance service center at any time for assistance.

If you experience any unpredictable problems on the road, you can call Volvo Assistance. For example, if:

- your vehicle doesn't start
- your vehicle breaks down
- you get a flat tire.

Volvo Assistance is available in the Volvo Cars app and by pressing the assist button  on the ceiling.

 **Note**

Not for emergencies

If you need assistance in an emergency situation, press the SOS button instead. Situations that could require immediate emergency assistance include traffic accidents, acute illness and external threats.

Stolen vehicle

If your vehicle has been stolen and you need help tracking it down, contact Volvo Assistance.^[1]

An included service

Volvo Assistance is included with new Volvo vehicles for the first few years of ownership.^[2] For more information regarding your vehicle, contact Volvo support or a Volvo retailer.

Note

If you don't have a Volvo Assistance agreement, you will still be able to use the service for an extra cost.

Terms and conditions

Volvo Assistance is intended to be active for as long as the vehicle is used and the technology it relies on is supported, such as the vehicle's mobile network connectivity.

Certain information, including personal data, needs to be shared with Volvo in order to use Volvo Assistance.

Note

Volvo reserves the right to reduce Volvo Assistance functionality that is deemed no longer practically possible to maintain.

If a vehicle remains unused for more than one year, it is considered no longer in use.

If you need any help or have any questions regarding Volvo Assistance, contact Volvo support.

^[1] Availability and inclusion varies between regions.

^[2] Availability and inclusion with new vehicles varies between regions.

2.7.1. Calling Volvo Assistance for roadside assistance

You can press the assist button in the ceiling to contact Volvo Assistance for roadside assistance^[1]. You might want to do this if you experience any unpredictable problems on the road, such as if your vehicle won't start, it breaks down, or you get a flat tire.

Note

Not for emergencies

If you need assistance in an emergency situation, press the SOS button instead. Situations that could require immediate emergency assistance include traffic accidents, acute illness and external threats.

Using Volvo Assistance abroad

If you press the assist button  when you are abroad, you will reach Volvo Assistance in your home country.

 **Tip**

You can also use the mobile app for the vehicle to contact Volvo Assistance.



The assist button is located on the roof, to the right of the overhead console.

1. Press and hold the assist button for at least 2 seconds.



- > The vehicle makes a voice call to Volvo Assistance. It also sends information, such as its location and status. The Volvo Assistance call center will try to communicate with you to find out what kind of help you need.

If the voice call fails, the Volvo Assistance call center has the ability to respond based on information sent by the vehicle.

^[1] Availability depends on region.

2.8. Emergency assistance

In an emergency, the vehicle can connect you to an emergency call center. This is done automatically in response to severe collisions or manually by pressing the SOS button on the roof.^[1]

 **Note**

Strictly for emergencies

Situations that could require immediate emergency assistance include traffic accidents, acute illness and external threats.

Built to work after a collision

In order to call an emergency call center after a collision, the system must not be critically damaged. The system is designed to survive severe collisions and has its own backup battery in case the regular power supply fails.

When an emergency call is made, the following happens:

1. The vehicle makes a voice call to an emergency call center. It also sends information, such as its location and status.
2. The emergency call center will try to communicate with you to find out what kind of help you need.
3. If the voice call fails, the emergency call center has the ability to respond based on information sent by the vehicle.

Automatic emergency response

The vehicle automatically attempts to contact an emergency call center if it registers a collision above a certain level of severity. [\[2\]](#)

Using the SOS button

The SOS button is located on the roof, on the left side of the overhead console. You can read more about using the SOS button in a separate section of the manual.

When the system is working normally, the SOS button LED is white. In other cases, the light may change to red or flash at varying intervals.

LED behavior	Description
Blinking	The system is performing a self-check.
Solid red with SOS symbol showing in the instrument panel	The system had detected a critical fault. Immediate service is recommended.
Moderate flashing	An emergency call is starting.
Rapid flashing	The system is transmitting data to the emergency services.
Slow flashing	The system is connected to the emergency services.
Solid white	The system is working normally.

 **Note**

Not an emergency?

If you need help on the road but aren't in an emergency situation, press the assist button  to call Volvo Assistance instead. Volvo Assistance can help you in certain situations, such as if your vehicle won't start, it breaks down, or you get a flat tire.

[\[1\]](#) Availability varies between regions. Contact Volvo Support for more information.

[\[2\]](#) For example, when safety features such as airbags or seat belt pretensioners have deployed.

2.8.1. Calling emergency services with SOS button

A long press of the SOS button in the vehicle's ceiling connects you to an emergency call center.^[1]

Note

Strictly for emergencies

Situations that could require immediate emergency assistance include traffic accidents, acute illness and external threats.

Not an emergency?

If you need help on the road but aren't in an emergency situation, press the assist button  to call Volvo Assistance instead. Volvo Assistance can help you in certain situations, such as if your vehicle won't start, it breaks down, or you get a flat tire.

Using the SOS button abroad

If you press the SOS button when you are abroad, you will reach the local emergency services.



The SOS button is located on the roof, to the left of the overhead console.

1. Press and hold the SOS button for at least 2 seconds.



- > The vehicle makes a voice call to an emergency call center. It also sends information, such as its location and status. The emergency call center will try to communicate with you to find out what kind of help you need.

If the voice call fails, the emergency call center has the ability to respond based on information sent by the vehicle.

^[1] Availability varies between regions.

2.8.2. Changing the emergency call recipient

When pressing the SOS button, your vehicle will make a call to a Volvo emergency service by default. If you want your vehicle to call an emergency center instead, you need to change this in your profile settings.

 **Note**

Default settings

In some regions, the vehicle calls an emergency center by default instead of Volvo's emergency service.

Unable to change recipient?

The ability to change the emergency call recipient depends on your region and may vary over time.

1. Press the vehicle symbol  in the bottom bar and go to **Settings**.
2. Go to **Controls** → **More** → **SOS button calls Volvo Cars emergency service**.
3. Select one of the options.

2.9. HomeLink

HomeLink® lets you control other devices remotely, such as the garage door or an alarm system, and can be used instead of the original remote controls for these devices.

You can use the HomeLink buttons on the rearview mirror to remotely control other devices, such as garage doors, gates or an alarm system, from inside your vehicle.



HomeLink is integrated in the rearview mirror and consists of three buttons and an indicator light. You can connect one device per button. You can add, change or delete a connection to a device.

Note

Save the original remotes

You can still use the original device remotes as well as HomeLink if you want to. Make sure that you keep the original remotes, since you need them if you want to reconnect the devices, such as in a new vehicle.

Selling the vehicle

If you sell your vehicle, it's recommended that you delete the connection between the vehicle and the connected devices.

Setting HomeLink up

To get more information about how to set HomeLink up, go to homelink.com and follow the instructions.

Using HomeLink

When you have connected a device to a specific HomeLink button, you can use that button instead of the device's original remote. Simply press the button to activate the device and wait a few seconds for it to respond.

Warning

If HomeLink is used to control a garage door or gate, make sure that nobody is near the door or gate while it is in motion.

Do not use HomeLink for any garage door that does not have safety stop and safety reverse.

 **Note**

It is not possible to use HomeLink if the vehicle is locked from the outside and the alarm is active.

 **Tip**

HomeLink works for a few minutes after you have turned the ignition off.

3. Displays, software and phone

Explore how to interact with your vehicle. Here's where you can find more information on your vehicle's displays, connectivity features, sound and media, in-vehicle apps, software and voice control.



You can access many of your vehicle's functions via the displays, but there's also plenty you can do using your phone.

An internet-connected vehicle makes remote access possible and keeps the vehicle up to date by downloading software updates. Learn how everything is connected.

3.1. Displays

The different displays show you information related to the vehicle and your driving. You can also control many of the vehicle's functions by interacting with the displays.

3.1.1. Center display

Interact with the center display to control and view information about many of the vehicle's features and functions.



The center display sits in the middle of the dashboard and automatically activates when the driver's door is opened.

Frequently used features such as climate, settings and the app library can be accessed by pressing the symbols at the bottom of the display.

i Tip

Two people, such as the driver and front passenger, can use the center display at the same time.

Examples of functions that can be viewed and controlled via the center display are:

- Navigation
- Media players
- In-vehicle apps
- Phone

! Important

Do not use sharp objects on the center display, as they may damage it.

3.1.1.1. Center display views

Learn about some of the views that you can see in the center display.

The various bars provide status information, display shortcuts to apps or quick controls, and allow you to navigate around the center display views. The main views let you use and access navigation information, in-vehicle apps, climate controls and settings. There are also some specialized views for managing specific vehicle functions.







Center display bars

The status bar at the top of the center display shows you symbols relating to the vehicle's status and apps, along with the time and outside temperature. The bottom bar is your main way of navigating around the center display views. By pressing the symbols, you can get to other views and functions. The status bar and bottom bar are always visible, regardless of which view you're looking at.

In some views, you will see the contextual bar appear above the bottom bar. This bar contains shortcuts to recently used functions or apps that only appear when you can use them. Sometimes these shortcuts are replaced by quick controls, which allow you to control ongoing phone calls and media when the associated views or widgets aren't visible.

Main views

The following list contains the main views that you will see and use in the center display.

- Home view** The home view shows a large navigation map, and so it also works as the navigation view. There are widgets with quick controls for media and phone underneath the map. You can access home view from other views by pressing the home button  underneath the bottom bar.
- App library** You can access the manual, in-vehicle apps and the app store in this view. To get to this view, press the app library symbol  in the bottom bar.
- Climate view** You can change a variety of climate settings in this view, such as activating or deactivating defrosters and adjusting settings for air conditioning. The climate view is accessed by pressing the fan symbol  on the bottom bar.
- Vehicle overview** This view gives you access to the quick controls and settings views, as well as user profiles. These come together to give you an overview of the vehicle, which can be accessed by pressing the vehicle symbol  on the bottom bar.
- Quick controls view** This view gives you quick and easy access to some of the vehicle's functions, such as folding the headrests. You can get to the quick controls view by pressing the vehicle symbol  in the bottom bar.
- Settings view** This view is where you can access all of the different settings tabs and views for your vehicle. You can get to the settings view by pressing the vehicle symbol  in the bottom bar.

Specialized views

The following views are related to specific functions in the vehicle.

- Seat adjustments view** You can adjust the seats in the adjustments view. For example, you can adjust the side support, as well as the lumbar support and seat cushion extension.
- Parking view** The parking view contains features that help you park. When shown, it takes up most of the center display. If the parking view doesn't automatically appear when you need it to, you can open it yourself by pressing the camera symbol  in the contextual bar above the bottom bar.

Note

Driver distraction overlay

What you can see and do in the center display sometimes depends on whether the vehicle is moving or not. To minimize driver distraction while the vehicle is moving, some views become unavailable, such as certain settings. If this happens, the center display shows the driver distraction overlay. When the vehicle stops moving, the overlay disappears and you can interact with the view again.

3.1.1.2. Status symbols in the center display

The content of this manual represents the status of the user manual at the time of printing and may not be completely valid in future instances. For more information refer to the first page for the complete disclaimer note.

Status symbols are shown in the status bar at the top of the center display. The symbols tell you important information about your vehicle's system status.







Symbol types

Some status symbols, such as the clock, will always be visible in the status bar. Others are only visible when a particular function is active, such as wireless charging, or even disabled. You will also see symbols that tell you when there is an error, such as when you have an internet connection issue.

 **Note**

Make sure you look up any status symbols that you are unfamiliar with. They might not appear with any extra information or notifications.

This is a list of some status symbols that can appear in the status bar. It is not an exhaustive list, and you might also see status symbols in the status bar from third-party apps.

12:31	Clock	The clock shows you the current time. You can choose whether to display the time in the 12-hour or 24-hour format.
	Mobile internet signal	Mobile internet is active and being used by the vehicle. The number of bars indicates signal strength.
	Mobile internet error	There is an issue with the mobile internet connection. If you see this symbol with a type of connection next to it, such as 3G or LTE, it means that the vehicle is connected to a network but doesn't have a working internet connection.
	No internet connection	The vehicle is not connected to the internet.
LTE	LTE mobile internet signal	Your vehicle has an active LTE mobile internet connection.
E	EDGE mobile internet signal	Your vehicle has an active EDGE mobile internet connection.
3G	3G mobile internet signal	Your vehicle has an active 3G mobile internet connection.
4G	4G mobile internet signal	Your vehicle has an active 4G mobile internet connection.
R	Roaming active	Roaming is active.
	Wi-Fi signal	Wi-Fi is enabled and active. The number of bars indicates the signal strength. If no bars are shown, this indicates that a Wi-Fi connection is active but there is no signal.
	Wi-Fi internet error	There is an issue with the Wi-Fi internet connection.
	Bluetooth connected	Bluetooth is enabled and a device is connected to the vehicle.
	Location	Your location is being shared.

3.1.1.3. Restarting the center display

You can restart the center display using the home button underneath the bottom bar.

If you are having problems with the center display, such as it freezing or issues with connectivity, restarting it might resolve these issues.

1. Press and hold the home button — underneath the bottom bar of the center display until the display turns off.
 - > The center display will show the Volvo logo to indicate that it's restarting.

3.1.1.4. Keyboard

The center display keyboard appears any time you can enter text or numbers. You can customize many of its features in settings.

You can use the on-screen keyboard to write text or numbers. For example, when searching for a destination in the navigation app or entering the password for a Wi-Fi network.

The keyboard layout can change depending on the type of input field you are writing in.

The keyboard supports some alternative ways of inputting text. These include:

- Glide typing
- Speech-to-text
- Handwriting



Tip

You can download other keyboards to use by going to the app store in the app library.

3.1.1.4.1. Changing the keyboard language

You can change the language for the center display keyboard on the keyboard itself.

Change the keyboard language when you want to write text in a different language. This can be useful when you are driving abroad and need to search for a destination or address in the local language.

 **Note**

To be able to change the keyboard language, you need to have more than one language available for the keyboard. If you only have one language available, the languages symbol won't be shown on the keyboard.

Changing language to the next available language

1. Press the languages symbol  at the bottom of the keyboard.
- > The keyboard language switches to the next one in the available languages list.

Changing language to any available language

2. Press and hold the languages symbol  at the bottom of the keyboard.
- > A list of available languages appears.
3. Select the language you want to use.
- > The keyboard language changes to the one you selected.



3.1.1.4.2. Adding and removing keyboard languages

You can add and remove keyboard languages in settings.

You can add languages to the center display's on-screen keyboard if you want to write in a language that isn't already available. Languages can also be removed from the keyboard if you find that you no longer need them.

1. Press the vehicle symbol  in the bottom bar and go to **Settings**.
2. Go to **System** → **Languages and input** → **Keyboard**.
3. Choose the keyboard you want to make changes to.
4. Select **Languages**.

Adding a language

5. Press the plus sign  above the currently available languages and search for your desired language.
 6. Select the language you want to add, then press the download symbol .
- > The language is added to the list of languages available to use on your keyboard.

Removing a language

7. Press the edit symbol  above the list of currently available languages.

8. Select the language you want to remove from the list of available languages, then press the trash can symbol .

> The language is removed from the list of languages available to use on your keyboard.

3.1.2. Instrument panel

The instrument panel shows notifications and information related to your driving and the vehicle itself.



The instrument panel is located in front of the driver, behind the steering wheel.

The instrument panel activates as soon as you open a door and turns off if it isn't used for a short period of time. To turn it back on, either open a door or turn the start knob clockwise and quickly let it go.

Use the steering wheel buttons to interact with the display and control what's shown on it.

Examples of information that can be shown in the instrument panel are:

- Warning and indicator symbols
- Speed
- Navigation
- Notification messages
- Fuel gauge
- Trip meter

Display modes

There are two instrument panel modes that you can choose from: calm and map. Use the instrument panel mode button  on the steering wheel to change the display mode.

Calm This displays essential information, such as speed, as well as warning and indicator symbols.

Map The instrument panel shows your current navigation route on a map, as well as essential driving and vehicle information.

 **Warning**

If the instrument panel turns off, doesn't turn on or is only partially legible, you must not use the vehicle. This is because the driver will not receive warnings and vehicle status information shown in the instrument panel, such as warnings and information relating to brakes, airbags or other safety systems. If there is an issue with the instrument panel, contact an authorized Volvo workshop.

 **Tip**

You can change the instrument panel settings in the center display.

3.1.2.1. Warning and indicator symbols

The instrument panel symbols tell you the status of different systems in your vehicle. Some indicate whether a system is active and operating as it should, and others alert you to important information or detected faults.

Symbol types and colors

Some symbols are warnings that require immediate action, while others indicate the current status of specific functions. The symbol color roughly signifies the level of importance. Red symbols are the most critical, while amber symbols represent less urgent warnings and alerts. Symbols in other colors typically convey status information about the vehicle's functions.

 **Tip**

Be sure to look up the meaning of symbols you are unfamiliar with. Many symbols will appear with a notification providing more information.



Warning

A fault is detected that could affect safety or your vehicle's ability to be driven.



Brake system warning

A fault is detected in the brake system. Take immediate action and contact an authorized Volvo workshop.

























Parking brake warning

Continuous illumination indicates that the parking brake is engaged. Flashing indicates a parking brake fault.



Electrical system fault warning

A fault is detected in the vehicle's electrical system. Take immediate action and contact an authorized Volvo workshop.

	Emergency call	There is an issue with the emergency call system.
	Seat belt reminder	Someone in the vehicle isn't wearing their seat belt.
	SRS warning	A fault is detected with the airbags or related safety systems. Take immediate action and contact an authorized Volvo workshop.
	Collision risk warning	There is a risk of collision with another vehicle, a pedestrian, a cyclist or a large animal.
	High engine temperature	The engine is too hot.
	Low oil pressure	The engine oil pressure is too low.
	Information	A problem has occurred with one of the vehicle's systems.
	Brake system warning	A fault is detected in the brake system.
	Anti-lock braking system warning	The anti-lock braking system is disengaged. The friction brakes still function but without anti-lock braking.
	Emission control system warning	A fault is detected in the emission control system. Contact an authorized Volvo workshop and have the vehicle checked.
	Lane keeping aid alert or intervention	Lane keeping aid is alerting you to something or performing an intervention.
	Tire pressure warning	Constant illumination indicates low tire pressure. Flashing followed by constant illumination indicates a system fault or inability to measure the tyre pressure.
	Stability system alert	A flashing symbol indicates that the stability system is intervening. A fault in the system is indicated by steady illumination.
	Stability system off	The stability system is turned off.
	Collision risk system issue	The collision risk system is not available or is working with reduced performance.
	Rear fog light on	The rear fog light is on.
	Headlight system malfunction	There is an issue with the headlight system.
	Automatic high beam active	Automatic high beam is active.
	Manual high beam on	Manual high beam is on.
	Automatic hold	The automatic hold braking function is active. The vehicle automatically brakes while stationary.
	Left turn signal	The left turn signal is active and indicating a left turn.
	Right-hand turn signal.	The right turn signal is active and indicating a right turn.



Parking lights

The position lights are on.



Automatic high beam enabled

Automatic high beam is enabled.



Vehicle key not detected

The vehicle couldn't detect the key when the vehicle was started.



Driver alert

The Driver Alert function is active.



Lane keeping aid active and road markings detected

Lane keeping aid is active and has detected the road's markings.



Lane keeping aid active and no road markings detected

Lane keeping aid is active and has not detected any road markings.



Rain sensor

The rain sensor is active.

3.1.2.2. Fuel gauge

The fuel meter indicates how much fuel you have left in your fuel tank, as well as an estimated fuel range.

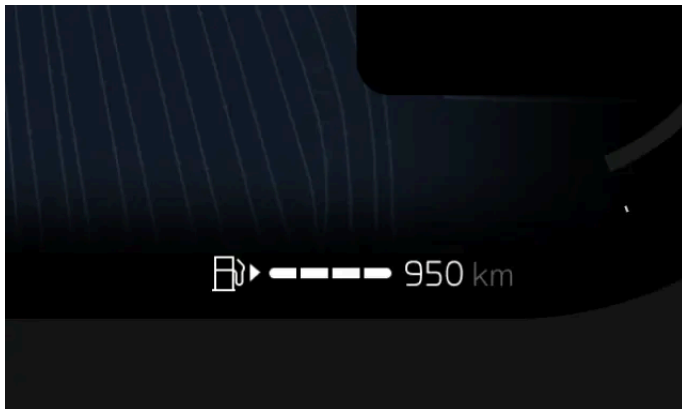

The instrument panel shows the fuel gauge at all times.

Remaining fuel

The fuel meter indicates the amount of fuel left in your vehicle's tank. When the vehicle's tank is low on fuel, the fuel pump symbol changes color.

The meter also displays an estimated fuel range for how much further you can drive before the tank is empty. This range is calculated by the trip meter based on your average fuel consumption over the last 30 km (20 miles) and how much fuel is left in the tank. When you can see a dotted line instead of a range, it means that there isn't enough remaining fuel to calculate the range and you should refuel as soon as possible.

Note

Your driving style can have different effects on the estimated fuel range.

3.1.3. System settings

You can change the system settings so that the vehicle displays information in a way that suits you.

There are a number of system settings that you can change, including:

- System language
- Time and date
- Units of measurement
- Keyboard languages

3.1.3.1. Changing time and date

You can manually change the time, date and local time zone in settings.

By default, your vehicle uses information from the internet to automatically change the time, date and local time zone for you. You can also manually change these yourself, as well as the time format in settings.

1. Press the vehicle symbol  in the bottom bar and go to **Settings**.
 2. Go to **System** → **Date and time**.
 3. If **Automatic date and time** and **Automatic time zone** are enabled, turn them off.
 4. Select your desired setting and make any changes.
- > The changes are shown on the displays.
The clock in the center display's status bar updates if you made changes to the time settings.



Tip

You can change the time format so that it's displayed in the 24-hour or 12-hour format.

3.1.3.2. Changing the system language

You can change the language of the vehicle's system in settings.

If you want your vehicle's systems to use a language that is different from the current language, you need to change the system language.

 **Important**

Only select a system language that you can fully understand. The vehicle communicates safety-critical information and notifications to you through messages, so you need to be able to understand them at all times.

 **Note**

When you change the system language, the digital assistant language also changes.

1. Press the vehicle symbol  in the bottom bar and go to **Settings**.
 2. Go to **System** → **Languages and input** → **Languages**.
 3. Choose the language you want to change to.
- > The new language is shown in the displays.

3.1.3.3. Changing system units

You can go to setting to changes the units of measurement, such as for speed and distance.

 **Tip**

When driving abroad, it can be useful to change the vehicle's units of measurement to match the local ones. It can be especially helpful if road signs display distances and speeds in units that are different from those currently displayed in your vehicle.

1. Press the vehicle symbol  in the bottom bar and go to **Settings**.
 2. Go to **System** → **Units**.
 3. Select the units of measurement you want the vehicle to display.
- > The vehicle displays units in the new format.

3.2. Phone

The content of this manual represents the status of the user manual at the time of printing and may not be completely valid in future instances. For more information refer to the first page for the complete disclaimer note.

Connect your phone to the vehicle via Bluetooth to be able to use it while driving. When you are away from your vehicle, you can also use your phone to read the manual and use some vehicle features remotely via the Volvo Cars app.

Connect your phone to your vehicle

Connecting your phone to the vehicle via Bluetooth allows you to use it through the vehicle's interface. You can also stream media directly from your phone to the vehicle, as well as share its internet connection.

You can use voice control or the center display to search for your contacts, make and receive phone calls, and respond to text messages^[1] without even touching your phone.

Other uses for your phone

Using your phone with your vehicle isn't limited to just when you're inside the vehicle. Download the Volvo Cars app to remotely use certain vehicle functions or read the manual when you're away from the vehicle.

^[1] Only applies to Android phones or phones with iOS 13 or later.

3.2.1. Connecting your phone to the vehicle

Connect your phone to the vehicle via Bluetooth to use your phone through the vehicle's interface.

Bluetooth must be enabled for both the vehicle and your phone for them to be able to pair. You can turn Bluetooth on in settings. Make sure that your phone is set as discoverable so that the vehicle can find it when pairing.

1. Press the vehicle symbol  in the bottom bar and go to **Settings**.
 2. Go to **Connectivity** → **Bluetooth**.
 3. Choose the device you want to pair the vehicle with from the list of available devices.
 4. Check that the confirmation code in the center display matches the one shown on your phone.
 5. Accept the settings and permission requests that appear on your phone.^[1]
- > Your phone is now connected to the vehicle. It will automatically connect next time, as long as Bluetooth is enabled on your phone.

Note

You can have multiple phones paired with the vehicle, but only one can be connected to the vehicle at a time. To change the active phone, select it from the list of paired devices or add a new device.

Issues with connecting?

If you have issues with connecting your phone to the vehicle via Bluetooth, try connecting another phone to check whether the problem is with your phone or the vehicle. If the problem persists, remove all saved devices in the vehicle's Bluetooth settings and try to connect your phone again.

- [1] You can still connect your phone to the vehicle even if you skip over permission requests, but there will be reduced functionality.

3.2.2. Using your phone in the vehicle

You can use your phone via the center display and voice control.

Important

Make sure that you comply with all local laws and regulations regarding mobile phone use while driving.

Note





You need to connect your phone to the vehicle via Bluetooth and accept the corresponding phone settings permissions to be able to use these features.

Calling

There are a few different ways you can make and receive phone calls while in your vehicle. You can:

- answer and decline incoming calls using the center display
- call someone while driving by asking the digital assistant to make the call for you
- use the in-vehicle phone app via the center display to call contacts, or enter a phone number using the on-screen keypad.

When you have an ongoing call, it will be shown in the center display. If you open the in-vehicle phone app when you have an ongoing call, you can:

- mute and unmute your microphone 
- change the sound input and output, such as through the vehicle or your mobile phone's microphone and speakers 
- end the call 
- use the keypad to input numbers, such as when asked to select an option in a service menu .

If you receive a second phone call while in the middle of an ongoing call, answering the second phone call automatically puts the first one on hold. You can switch between the two calls by pressing the switch symbol .

Messaging

You can write and send text messages via the digital assistant using voice control^[1]. If you receive a text message, a notification will appear in the center display with the following options:

- **Play** to hear the digital assistant read the message out loud.
- **Mute** to stop receiving new message notifications from this specific conversation for the rest of the time you are in the vehicle.

You can also ignore the notification and view it later in the notification center.

Looking through and searching for your contacts

Use the in-vehicle phone app to search for a specific contact by:

- pressing the search symbol 
- going to the contacts tab and typing their name
- going to the keypad tab and entering their number.

You can also just ask the digital assistant to find the contact you are looking for.

^[1] Only applies to Android phones or phones with iOS 13 or later.

3.2.3. Switching between paired phones

You can change which Bluetooth-paired phone the vehicle is connected to in settings.

The vehicle can connect to and remember multiple phones, but it can only be actively connected to one phone at a time.

If you want to switch the Bluetooth connection to a new device, you need to pair it with the vehicle first. You can do this in settings.

Before trying to switch to a different paired device, make sure that Bluetooth is enabled on the device you want to switch to.

1. Press the vehicle symbol  in the bottom bar and go to **Settings**.
2. Go to **Connectivity** → **Bluetooth**.
3. Press the name of the phone you want to connect to.
4. Select the services you want the phone to be used for, such as media or phone services.

Tip

You can also switch devices in the center display's phone view by pressing the switch device symbol .

If you can't see the device you want to switch to in the paired devices list, try pairing it with the vehicle again.

3.2.4. Apple CarPlay

Connect your phone via a USB cable and activate Apple CarPlay to use your iPhone via the vehicle.

Apple CarPlay gives you another way of using your iPhone via the vehicle's interface. You can use certain communication, navigation and media apps on your iPhone via the center display, as well as the steering wheel buttons and voice control.

Important

Local laws and regulations

Make sure that you comply with all local laws and regulations regarding mobile phone use while driving.

CarPlay content

Volvo does not accept responsibility for the content available in Apple CarPlay.

 **Note**

Phone compatibility and supported apps

Apple CarPlay only works with iPhones, but it doesn't work with all iPhone models. To find out if your iPhone is compatible or to learn more about which apps are supported, go to Apple's website www.apple.com/ios/carplay.

 **Tip**

CarPlay not installed?

If your vehicle doesn't come with CarPlay, you can install it at a later time. Contact a Volvo retailer to ask about installing CarPlay in your vehicle.

Keep your phone updated

Keep your iPhone and apps updated to the latest versions.

Connect your iPhone and start CarPlay

 **Note**

Disable Bluetooth to use CarPlay

CarPlay can't be enabled at the same time as your vehicle's Bluetooth. To use CarPlay, you need to turn the vehicle's Bluetooth off.

Activate Siri and have an internet connection

To be able to use CarPlay, you need to activate Siri on your iPhone and have an active internet connection.

Connect your iPhone to the vehicle by plugging a USB-C to lightning cable into your iPhone and the vehicle's USB port, which has a white highlight around it. If you're using CarPlay for the first time, you need to accept the terms and conditions in the center display first; then CarPlay will start. If you have used CarPlay before, it will automatically start when you connect your phone to the vehicle.

CarPlay view

You can access the CarPlay view by opening the CarPlay app in the app library. If the CarPlay symbol  is shown in the contextual bar, you can also access the view by pressing this symbol.

Once active, the CarPlay view takes up the whole of the center display. However, the bottom bar, contextual bar and status bar will still be visible at all times if you want to return to the vehicle's own system.

Navigation with CarPlay

You can use navigation apps on your iPhone via Apple CarPlay. If you start a navigation route via CarPlay, you can see the guidance in the center display's CarPlay view, as well as in the instrument panel. If you are following a navigation route in the

vehicle's own navigation app and then start another navigation route in CarPlay, instrument panel navigation using the vehicle's own app will end.

Using Siri

If you want to use Siri instead of the vehicle's in-built digital assistant, press and hold the voice control button  on the steering wheel while CarPlay is active.

You can use Siri to read out, write and send messages. Siri will read and write messages in the language selected in the Siri settings on your iPhone. If you write a message via Siri, the center display won't show you your message, but it will be displayed on your iPhone.

3.2.5. Android Auto™

Connect your phone via a USB cable and activate Android Auto™ to use your Android™ phone via the vehicle.

Android Auto gives you another way to use your Android phone via the vehicle's interface. With Android Auto, you can safely access your phone's communication, navigation and media apps via the center display as well as the steering wheel buttons.

Important

Local laws and regulations

Make sure that you comply with all local laws and regulations regarding mobile phone use while driving.

Android Auto content

Volvo does not accept responsibility for the content available in Android Auto.

Note

Phone compatibility and supported apps

Android Auto only works with Android phones, but it doesn't work with all phone models. To find out if your phone is compatible or to learn more about which apps are supported, go to Android Auto's website www.android.com/auto/ [<https://www.android.com/auto/>].

Google Trademarks and compatibility

Google, Android and Android Auto are trademarks of Google LLC. Compatible Android phone and compatible active data plan required.



Tip

Keep your phone updated

Keep your phone and apps updated to the latest versions.

Connect your phone and start Android Auto



Note

Install Android Auto on your phone and make sure you have an active internet connection

To be able to use Android Auto, you need to have the Android Auto app installed on your phone and an active internet connection.

Connect your phone to the vehicle by connecting a suitable USB cable between your phone and the vehicle's white-outlined USB port. If you are using Android Auto for the first time, you need to accept the terms and conditions in the center display. Android Auto will then start. If you have used Android Auto before, it will automatically start when you connect your phone to the vehicle.

Android Auto view

You can access the Android Auto view by opening the Android Auto app in the app library. If the Android Auto symbol  is shown in the contextual bar, you can also access the view by pressing this symbol.

Once active, the Android Auto view takes up the entire the center display. However, the bottom bar, contextual bar and status bar will still be visible at all times if you want to return to the vehicle's own system.

Navigation with Android Auto

You can use navigation apps on your phone via Android Auto. If you start a navigation route via Android Auto, you can see the guidance in the center display's Android Auto view as well as in the instrument panel. If you are following a navigation route in the vehicle's own navigation app and then start another navigation route in Android Auto, the instrument panel navigation for the vehicle's own app will end.

Using Google Assistant

Talk to Google Assistant on Android Auto to carry out tasks with your voice so that you can keep your focus on driving. To use Google Assistant, just say "Hey Google" or press and hold the voice control button  on the steering wheel while Android Auto is active.

You can use Google Assistant to carry out tasks such as sending messages, getting directions or controlling media.

3.3. Sound and media

Listen to music and media through the vehicle's sound system. You can adjust how it sounds in settings.

Sound settings

There is a variety of sound settings for you to customize your sound experience.

Radio and media players

You can listen to live radio via the pre-installed radio app and stream media from your phone to the vehicle via the Bluetooth media player.

Your vehicle also comes with SiriusXM so you can listen to satellite and IP radio.



Tip

You can find and download more third-party media apps via the vehicle's app store.

Controlling media playback

You can control media playback in a number of ways by using:

- the media playback controls in the center display
- the media knob and buttons underneath the center display
- the steering wheel buttons
- voice control.

3.3.1. Radio

Use the pre-installed radio app to listen to live radio in your vehicle.

Radio favorites

You can add stations to your radio favorites list for quicker access.





Tip

You can find and download other radio apps via the app store.

3.3.1.1. Adding radio favorites

You can add radio stations to the favorites list in the radio app.

Add the radio stations you listen to frequently to the favorites list for quicker access.

1. Press the app library symbol  on the bottom bar and open the radio app.
 2. Find the station you want to add as a favorite from the list of currently available radio stations.
 3. Press the star symbol  to the right of the station name.
- > The appearance of the station's star symbol changes and the radio station appears in the favorites list.

If you want to remove a station from the favorites list, just press the star next to its name.

3.3.2. Sound settings

You can change and adjust a variety of sound options in settings.

Focus

You can choose from four sound focus settings: all, driver, front and rear. All is the default setting and doesn't focus the sound in a particular direction. It provides a neutral sound focus where occupants in the front and rear seats have the same sound experience. The driver setting focuses sound toward the driver. The front setting focuses sound towards the front seats, while the rear setting focuses it towards the rear seats.

If you select all or driver as your preferred sound focus, you can also turn surround sound on and adjust it.

Tone

Customize how your media sounds by adjusting the values for the different tone qualities.

Volume

You can adjust the volume of a variety of sounds via the center display, such as:

- Media
- Ringtone
- Calls
- Voice assistant
- Navigation
- Notifications
- Parking assistance



Tip

There are other ways to adjust the volume of sounds in your vehicle. You can turn the media knob underneath the center display or press the buttons on the right-hand side of the steering wheel.

3.3.3. Media players

Your vehicle comes with a pre-installed media player. You can download more third-party media apps from the app store in the app library.

Your vehicle comes with the Bluetooth media player pre-installed in the app library.

Use the Bluetooth media app to stream media from a Bluetooth-connected device straight to the vehicle.

3.4. In-vehicle apps

All of the vehicle's apps can be found in the app library.

You can access the app library by pressing its symbol in the bottom bar.



App library symbol

Some apps are pre-installed, such as Bluetooth media, Google Maps and Google Assistant. You can search for and download new apps via Google Play, which can be accessed in the app library.

3.4.1. Downloading apps

Download more apps to your vehicle from the app store in the app library.

Your vehicle comes with some apps pre-installed, but you can find and download more in the app store.

To be able to download apps, your vehicle must be at a standstill and connected to the internet.

1. Press the app library symbol  in the bottom bar.
2. Press **Get more apps** to go to the app store.

 **Note**

To be able to open Google Play, the current user profile must be signed in to a Google account.

3. Search for the app you want to download.

4. Download and install your desired app.

> If the app is successfully downloaded and installed, it appears in the app library.

3.4.2. Uninstalling apps

You can uninstall apps you no longer want or use in the app library.

 **Note**

Pre-installed apps, such as phone and radio, can't be uninstalled.

1. Press the app library symbol  in the bottom bar.
 2. Find the app you want to uninstall, then press and hold the app until a menu appears.
 3. Select **Uninstall** from the menu.
 4. Press **Uninstall** to continue uninstalling the app.
- > The app is uninstalled and disappears from the app library.

 **Tip**

You can also uninstall apps by going to the privacy settings, pressing **Show all apps**, and selecting the app you want to uninstall.

3.5. Connectivity and software

Connect your vehicle to the internet to get more from your vehicle and receive over-the-air software updates.

Internet connectivity

Connect your vehicle to the internet via Wi-Fi, a Bluetooth-connected mobile phone or the vehicle's built-in mobile network connection^[1].

Software updates

Over-the-air updates keep your vehicle's software up to date.

^[1] Availability may vary between regions.

3.5.1. Internet connection

Connecting your vehicle to the internet gives you access to certain features and over-the-air software updates.

There are several ways to connect your vehicle to the internet. When the vehicle can access the internet in more than one way, it prioritizes them in the following order:

- Wi-Fi network
- Bluetooth-connected phone tethering
- Mobile network^[1]

Wi-Fi

You can connect the vehicle to a Wi-Fi network for internet access. The vehicle can automatically connect to the network whenever it is within range.

Bluetooth-connected phone tethering

When a phone is connected to the vehicle via Bluetooth, the vehicle can use the phone's mobile internet connection. To do this, Bluetooth tethering needs to be enabled for the phone in the vehicle's connectivity settings. Both the phone and mobile network provider need to support sharing an internet connection through tethering.

Mobile network^[1]

Your vehicle has a built-in modem for connecting to a mobile network. The mobile internet connection is set up before you get your vehicle and is included for a certain number of years. As long as the vehicle has an active mobile network service plan and it's in an area with network reception, it can connect to the internet. Contact an authorized Volvo workshop for information about mobile connectivity services for your vehicle.

The vehicle supports mobile networks up to and including 4G. The available mobile network speeds depend on the SIM card installed in your vehicle.

 **Note**

Internet consent

You need to accept the internet terms and conditions before using the mobile network internet. Just go to **Internet terms of service** in the privacy settings to accept and also check that you have accepted the terms and conditions.

Mobile network connectivity conditions and limitations

- The vehicle needs to be in an area with mobile network reception.
- Mobile connectivity services must be active for the region where the vehicle is located.
- Obstacles such as buildings, hills and mountains can weaken or block the mobile network signal.

Internet connection settings

You can find the connectivity settings in the center display.

^[1] Availability may vary between regions.

3.5.1.1. Connecting to the internet via a Bluetooth-connected phone

Connect your phone to the vehicle via Bluetooth and share its internet connection.

 **Note**

Sharing your phone's mobile internet connection with the vehicle will affect the amount of mobile data you use. Some mobile data providers might not allow this kind of data use. It's possible that the amount available will be limited or that your provider may charge you extra for it. Make sure you check your provider's conditions for data usage before activating Bluetooth tethering.

You need to connect your phone to the vehicle via Bluetooth before you can share your phone's internet connection.

1. Press the vehicle symbol  in the bottom bar and go to **Settings**.
 2. Go to **Connectivity** → **Bluetooth**.
 3. Press the Bluetooth tethering symbol  for the phone that you want to share the internet connection from.
 4. Press **Accept** to continue with the tethering activation.
- > The Bluetooth tethering symbol changes color, indicating that tethering is now active.

3.5.1.2. Connecting to the internet via Wi-Fi

Connect your vehicle to a Wi-Fi network for internet access.

 **Note**

You can only connect to a new Wi-Fi network while the vehicle is stationary. If you are driving and want to connect to a Wi-Fi network, you can only connect to a saved network.

1. Press the vehicle symbol  in the bottom bar and go to **Settings**.
 2. Go to **Connectivity** → **Wi-Fi**.
 3. Enable Wi-Fi if it is disabled.
 4. Select the Wi-Fi network you want to connect to.
 5. Enter the Wi-Fi network password using the center display's keyboard and press **Done**.
- > The vehicle connects to the Wi-Fi network.

3.5.2. Restarting the vehicle's connectivity module

You can restart the vehicle's connectivity module using the max defroster button in the button panel underneath the center display.

If you are having problems with the vehicle's connectivity, such as losing its internet connection, restarting it might be a way to resolve any issues.

 **Warning**

You must park your vehicle when restarting the connectivity module, because the automatic collision alarm related to emergency assistance will be disabled during the restart.

1. Press and hold the max defroster button  in the button panel underneath the center display. Keep pressing the button until the SOS button in the vehicle's ceiling starts to flash.
 2. Stop pressing the max defroster button .
- > The connectivity module restarts.

The content of this manual represents the status of the user manual at the time of printing and may not be completely valid in future instances. For more information refer to the first page for the complete disclaimer note.

3. Wait a few minutes for connectivity to come back.

Internet connection still not working?

If the internet connection still isn't working after two days, try restarting the connectivity module again. If this doesn't resolve the issue, contact an authorized Volvo workshop.

3.5.3. Over-the-air updates

Over-the-air updates keep your vehicle's software up to date.

When your vehicle is connected to the internet, it can receive over-the-air^[1] updates to keep the vehicle's software up to date. The vehicle will tell you when there is an update available to download and install by displaying a notification.

You can also check for new software updates by going to **System** → **System details** → **Software update** in settings.

Downloading software updates

To be able to download a software update, your vehicle must be connected to a mobile network and you must have approved the use of connected services. Your vehicle downloads the update using a mobile network.

Note

You might incur data usage charges when downloading software updates. This depends on what data usage is included in your mobile network contract.

Installing software updates

When a new software update is available, the vehicle will download the update but it won't install it for you. You need to start the installation yourself, either via a notification in the center display or in the software update view. You can also choose to postpone the update so that it installs at a later time.

You can't use your vehicle's functions while a software update is installing, so make sure that you don't need to use your vehicle at all while installing the update. The installation process only starts after you get out of your vehicle and lock it. If you don't lock your vehicle within a few minutes of starting the installation, the update will be canceled and you can try to install it again later.

Note

If you really need to access your vehicle during the installation process, you need to use the standard key's detachable key blade to open the vehicle.

 **Note**

Installation issues

There might be updates that you can't install yourself. If this happens, you will see a notification in the center display telling you what to do next.

Don't use the diagnostic port

Don't use the diagnostic port while a software update is installing. Using the diagnostic port during installation might affect the vehicle's systems and the software update.

Alarm disabled

To avoid any false alarms, the vehicle's alarm is disabled during the software installation process.

[\[1\]](#) OTA

3.6. Voice control

Keep your hands on the wheel and use your voice to interact with the vehicle via the digital assistant.

With the help of the digital assistant, you can use voice control to carry out tasks, such as searching the internet and getting weather forecasts. You can also use your voice to interact with the vehicle and control a number of its functions, including:

- Media player
- Phone
- Navigation
- Climate

Speaking to the digital assistant

The assistant understands everyday speech, so you don't need to know any specific voice commands to use it. You can ask the assistant anything, and it responds by confirming what you said, then doing what you asked. It will let you know if it doesn't understand you.

 **Note**

- The voice control feature is from a third-party supplier. Availability, how to use it and how it works may vary over time and between regions.
- A poor internet connection may limit the number of available functions.

3.6.1. Using voice control

Use your voice to control and interact with a number of the vehicle's functions via the digital assistant.

The only time you need to use specific voice commands to interact with the digital assistant is when you activate it. After activating the assistant, just speak or give instructions to it using everyday phrases.

Note

Google Assistant isn't available in every language yet. Find out more at support.google.com [<https://support.google.com>] or try to use another language if you can.

1. Say "Ok Google" or "Hey Google" to activate Google Assistant.
 - > The assistant confirms that it's listening.
2. Speak or give instructions to the digital assistant using everyday phrases.

Tip

Other ways to activate

You can also activate the digital assistant by pressing the voice control button on the steering wheel  and via the center display.

Sign in to your Google account

If you sign in with a Google account, Google Assistant will be more personalized when the vehicle is online. For example, you can easily call contacts stored in your Google contacts or check what's in your Google Calendar.

4. Interior comfort and climate

Get familiar with your vehicle interior and the controls for seat adjustment, climate and windows.



Your vehicle is equipped with multiple features to assist you in your driving. While some features are mainly for comfort, others improve visibility. Reading this section of the manual can assist in making your driving experience more comfortable.

4.1. Interior

Get to know the interior layout and its practical features, such as cup holders and charging ports for your devices.

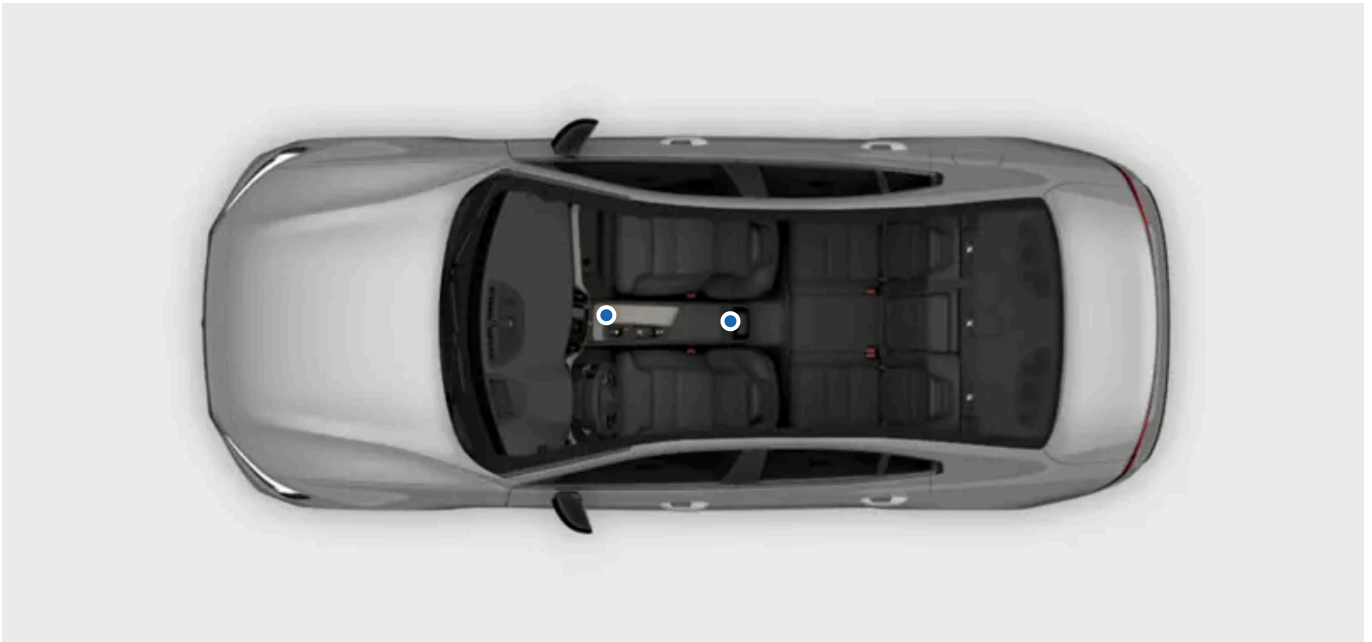

Interior walk-through

It's good to know the names and locations of a few places and components, as they are referenced throughout the manual.

Passenger compartment	The passenger compartment is divided into the front and rear passenger compartment.
Trunk	The trunk, or cargo area, is the space behind the rear seats, which you typically access from behind the vehicle.
Dashboard	The dashboard refers to the whole set of panels and components in front of the driver and front passenger. It has some of the main areas for interaction, such as displays, steering wheel, air vents and glove compartment.
Center console	The center console sits between the front seats. Here you'll find a storage compartment, an electrical outlet, USB ports, and a cup holder.
Door control panel	Each door has its own set of controls for windows and locks.

i Note

There's a backup key reader in the bottom of the center console's storage compartment.

One of the detectors for the alarm is located under the reader. Avoid leaving coins, keys, and other metal objects on the reader as this may trigger the alarm.

4.1.1. USB ports

You can use your vehicle's USB ports to charge phones, tablets, and other devices.

Location of the USB ports

There are two USB ports inside the storage space in the center console.



Using the USB ports

Some devices may become hot during charging. This is normal.

The ports are usually disabled if you leave the vehicle. If you leave the vehicle unlocked, the ports will remain active for a while longer.

Important

When using the USB ports, make sure you place the connected device where it won't injure any of the passengers in the event of heavy braking or a crash.

Note

Always disconnect devices from the ports when not in use.

Devices connected to a 12 V socket may be activated even when the vehicle is turned off.

USB port specifications

The power output from the USB ports depends on the device you are charging. The voltage and current is modulated to what the device will accept.

- Type C port
- Version 3.1
- Voltage supply 5 V
- Current supply max. 3.0 A

4.1.2. 12 V socket

You can use the 12 V outlet to power various electrical devices, such as an electric cooler.



The 12 V socket in the center console



The 12 V electrical outlet on the right side of the trunk

Turn the ignition on to send power to the outlet. The outlet is then active as long as the 12 V battery level doesn't become too low.

The vehicle turns off power to the outlet automatically when the engine is turned off and you lock the vehicle. If you leave the vehicle unlocked, the socket remains active for a while longer.

i Note

Always disconnect devices from the outlet and close the cover when not in use.

Devices connected to a 12 V socket may be activated even when the vehicle is turned off.

Some devices may become hot when charged through the 12 V outlet. This is normal for many devices.

 **Warning**

Failure to observe the following instructions could cause damage or personal injury.

- Do not use electrical devices with large, heavy plugs. They can damage the outlet or come loose while driving.
- Do not use electrical devices that could interfere with the vehicle's systems, such as the radio receiver.
- Only connect undamaged and fully working devices that meet all relevant safety standards^[1].
- Keep an eye on connected devices to prevent damage or injury if they malfunction.
- Do not connect adapters or extension cables to the 12 V socket, as they can override the socket's safety features.
- Do not expose the socket, connectors, or connected devices to water or other liquids.
- Do not touch or use the socket if it appears to be damaged or has come into contact with water or other liquids.

Power rating

 **Important**

The maximum power draw is 120 W (10 A).

^[1] CE marking, UL marking, or similar compliance marking.

4.1.3. Sun visors

There are sun visors overhead in front of the driver's seat and the front passenger seat.



The visors can be folded down and angled to the side when necessary.

There is a covered mirror in the sun visor. The mirror light comes on automatically when you open the cover.

There is also a clip on the sun visor that can be used to conveniently store cards, tickets, etc.

4.2. Climate

Your vehicle has the ability to provide a comfortable climate in the passenger compartment. It will cool, heat and dehumidify the air for you when needed. There are also built-in features which will provide good air quality.



This section of the manual covers the various climate features in your vehicle, such as air conditioning, climate modes and heating options.

4.2.1. Climate controls

You can control the vehicle's interior climate through various means, both from inside the vehicle and from your phone.

Most of your vehicle's climate controls and settings can be found in the center display. Passengers in the rear seats can set their own preferred temperature and blower level via the rear seat panel on the tunnel console. There are also some physical buttons, such as the defroster buttons, located below the center display.

You can control the vehicle's interior climate here:

- The center display
 - The center console's rear seat panel
 - The button panel below the center display.
-

4.2.1.1. Activating seat heating



You can activate seat heating via the comfort view in the center display. There are three levels of heating to choose from.

In colder temperatures, it's nice to heat your seat for a more comfortable driving experience. You can activate and adjust seat heating via the center display.

 **Warning**

Seat heating should not be used by individuals who:

- have difficulties sensing temperature shifts due to sensory loss.
- have trouble controlling the seat heating settings.

1. Open the comfort view for the seat by pressing the corresponding seat symbol   in the bottom bar.
2. Select your preferred heating level.

To close comfort view, press the down arrow symbol on the bottom bar.

 **Tip**

Rear seat heating

Passengers can control their seat heating via the climate control panel on the back of the center console. Their seat heating can also be controlled from the center display. Press the fan symbol  in the bottom bar and go to **Rear** to access the seat heating settings.



Automatic seat heating

In cold weather, you may appreciate automatic seat heating. Go to climate settings to turn on automatic activation.

4.2.1.2. Activating seat ventilation

You can activate the seat ventilation via the comfort view in the center display.

In warmer temperatures, it's nice to use seat ventilation for a more comfortable driving experience. You can activate and adjust seat ventilation via the center display.

1. Open the comfort view for the seat by pressing the corresponding seat symbol   in the bottom bar.
2. Select your preferred level of ventilation.

To close comfort view, press the down arrow symbol on the bottom bar.



Tip

4.2.1.3. Activating the steering wheel heating

Steering wheel heating can be controlled via the center display. You can activate it manually or set it to automatic activation.

In colder temperatures, it's nice to heat your steering wheel for a more comfortable driving experience. You can activate and adjust steering wheel heating via the center display.

1. Press the driver side's seat symbol in the bottom bar .
2. Select your preferred steering wheel heating level.



Tip



Automatic steering wheel heating

In cold weather you, may appreciate automatic steering wheel heating. Go to climate settings to turn on automatic activation.

4.2.2. Climate settings

The content of this manual represents the status of the user manual at the time of printing and may not be completely valid in future instances. For more information refer to the first page for the complete disclaimer note.

In climate settings, you can choose which functions should automatically activate when the vehicle turns on.

You can access the climate settings by pressing the fan symbol  in the bottom bar and go to settings .

There are a number of climate functions you can set to automatically turn on and set the heat level for. These include:

- Seat heating
 - Steering wheel heating
 - Rear defroster
-

4.2.3. Temperature and air conditioning

With the automatic climate settings, the climate system aims to always provide you with a comfortable interior environment. However, if you want to, you can always make adjustments to your liking.

The auto climate mode provides a comfortable interior environment in most circumstances. However, adjustments can always be made. For example, you can make changes to the temperature settings, set different settings in different climate zones or change the air conditioning settings.

4.2.3.1. Activating air conditioning

The air conditioning cools and dehumidifies the incoming air.

When you select air conditioning, it automatically activates or deactivates to maintain the set temperature.

For the air conditioning to work efficiently, windows, doors and the trunk need to be closed.

1. Press the fan symbol  in the bottom bar.
 2. Press the air conditioning symbol *A/C*.
-

4.2.3.2. Setting the temperature

You can change the temperature in the passenger compartment via the center display.

1. Press the temperature in the bottom bar.



2. Use the plus or minus symbol to adjust the temperature.

 **Tip**

The passengers in the rear can adjust the temperature via the rear display.

4.2.3.3. Synchronizing temperature

By default, the driver's temperature setting is used for all climate zones. However, each climate zone can also have its own individual setting. You can switch between the two options by desynchronizing and synchronizing the temperature.

1. Press the temperature setting in the bottom bar.
2. Press the synchronization symbol  to desynchronize the temperature.
 - > The climate zones are desynchronized and the desynchronization symbol appears.
3. Press the desynchronization symbol  to resynchronize the temperature.

 **Tip**

The temperature setting is also desynchronized when the passenger sets a different temperature on their side.

4.2.4. Air distribution and climate modes

The general air distribution is decided by the selected climate mode and settings. There are also air vents that offer additional airflow adjustments throughout the vehicle.

Adjustable air vents



The locations of the adjustable air vents

The adjustable air vents can be redirected to control the direction of the airflow.

Climate modes

There are two climate modes – automatic and manual. Automatic mode takes care of most adjustments and climate functions for you. However, in manual mode, you can control more of the available adjustments and functions yourself.

You can also turn the climate system off completely.

! Important

Condensation risk

Turning the climate system off completely can cause condensation on the windows, which impacts visibility.

The climate modes and their settings are available in the center display climate view.

4.2.4.1. Adjusting air vents

You can adjust the air vents in the center display or by using the physical vent knobs.

You can change the air flow direction via the climate view in the center display or physically using the air vent knobs on the air vents.

To open the air vent, turn the physical air vent knob. This allows the air to flow.

Redirecting air flow via the center display

1. Press the fan symbol  in the bottom bar.
2. Press the air flow symbols to select your preferred air flow direction.

The content of this manual represents the status of the user manual at the time of printing and may not be completely valid in future instances. For more information refer to the first page for the complete disclaimer note.

Redirecting the air flow physically

3. Move the physical air vent knobs to redirect the airflow.

Tip

If you choose a specific air flow direction in the center display while auto climate mode is active, the climate system will change to manual mode. You can always go back to auto climate mode again by selecting **Auto** in the climate view.

4.2.4.2. Activating auto climate mode

When you activate auto climate mode, the climate system controls several of its functions automatically.

Note

The automatically regulated climate control system is deactivated when the air distribution is changed manually or when maximum defroster is activated.

1. Press the fan symbol  in the bottom bar.
2. Press **Auto**.
3. You can change the fans' power level and the temperature if you prefer.

4.2.4.3. Activating manual climate mode

If you activate manual climate mode, you can set your preferred airflow direction.

1. Press the fan symbol in the bottom bar .
2. Select **Manual**.
3. Choose your preferred airflow direction and fan power level.

4.2.5. Ice, condensation and defrosters

In cold conditions, ice and condensation can obstruct visibility. Your vehicle is equipped with defrosters, a heated rear windshield and heated door mirrors to prevent this from happening.

There are defrosters placed by the windows and windshield. The side mirrors heat up at the same time as the rear windshield. Together, these functions seek to ensure good visibility.

Important

Always make sure the windows and windshields have good visibility before you start driving.

4.2.5.1. Activating max defroster

Activate max defroster to quickly remove condensation and ice from the front windshield and windows.



Max defroster button on the button panel below the center display

Max defroster increases the fan speed and temperature. Air conditioning is activated and air recirculation is unavailable while max defroster is active. When max defroster is turned off again, the climate settings return to their previous levels.

Note

When max defroster uses the high fan speed, the noise level of the fans increases.



You can activate the max defroster via both the center display and the button panel below the center display.

Activating via the button panel

1. Press the max defroster button  once to activate max defroster.
2. Press the button again to deactivate max defroster.

Activating via the center display

The content of this manual represents the status of the user manual at the time of printing and may not be completely valid in future instances. For more information refer to the first page for the complete disclaimer note.

3. Press the fan symbol in the bottom bar .
4. Press the max defroster symbol  to activate max defroster.
5. Press the symbol again to turn it off.

4.2.5.2. Activating rear windshield and door mirror heating



Activate the rear windshield and door mirror heating to get rid of condensation and ice.



Rear defroster button on the button panel below the center display

You can activate the rear windshield and door mirror heating via both the center display and the button panel below the center display.

Activating via the center display

1. Press the fan symbol in the bottom bar .
2. Press the rear defroster symbol .

Activating via the button panel

3. Press the rear defroster button .

Tip

Automatic rear defroster

In climate settings, you can set the rear defroster to automatically turn on when you start the vehicle in cold conditions.

Press  in the climate view and go to **Rear defroster**.

4.2.6. Interior climate when parked

Your vehicle can maintain a comfortable interior climate when parked.

Keeping heating active after parking

You can keep the passenger compartment warm after parking by using the heat generated from your drive. You can activate the function via the center display.

 **Note**

Parking climate functions automatically turn off when their maximum running time is reached.

 **Warning**

Never leave a child or pet unattended in your vehicle. You are responsible for their safety and well-being. Some regions have laws prohibiting people or pets being left inside a locked vehicle.

4.2.6.1. Keeping heating active after parking

You can keep the passenger compartment warm after parking by using the heat generated from your drive.

When the engine is off and you want to stay in the vehicle, you can choose to use the heat generated from your drive to keep the passenger compartment warm.

 **Note**

The amount of residual heat available limits how long the passenger compartment can stay heated in a cold climate.

1. Press the fan symbol in the bottom bar .
 2. Press **Use heat from drive**.
- > The vehicle uses heat generated from your drive to keep the passenger compartment warm.

Press **Stop using heat from drive** to turn it off.

The heating is automatically turned off when you lock and leave the vehicle.

4.2.6.2. Air purification

Air purification improves the air quality in the passenger compartment of your vehicle prior to departure.

You can start air purification via the center display, or via the mobile app for the vehicle. It also starts automatically when pre-conditioning ends.

Air purification improves the interior air quality by blowing fresh air into the passenger compartment and letting the air circulate through an air filter.



Tip

You can check the content of small particulate matter^[1] via the mobile app for the vehicle during the pre-cleaning cycle.

^[1] PM2.5

4.2.6.2.1. Activating air purification

Activate air purification to improve the air quality in the passenger compartment.

You must close all windows and doors for air purification to be possible.

1. Press the fan symbol  in the bottom bar and go to **Timers**.
2. Go to **Air purification**.
3. Press **Start**.



Note

Air purification starts automatically when preconditioning is finished.

4.2.7. Air quality

Your vehicle is designed to provide a pleasant and healthy interior climate. Air filtering helps to remove odors, substances and particles from the passenger compartment.

Passenger compartment air filter

The content of this manual represents the status of the user manual at the time of printing and may not be completely valid in future instances. For more information refer to the first page for the complete disclaimer note.

The air going into the passenger compartment is first filtered through the climate control system. To ensure high performance, the filter needs to be replaced regularly. If the filter is exposed to intense use, such as prolonged driving through areas of smog or dust clouds, then the filter needs to be changed more frequently. If you are uncertain about what kind of filter to use, contact Volvo support.

Air quality system

The air in the passenger compartment is purified by:

- filtering allergy- and asthma-inducing substances.
- removing gases and particles to reduce odors.
- removing air contaminants such as particles.

If the air quality sensors detect contaminants in the outside air, the air intake closes and internal air recirculation activates.

Air purification

In addition to the passenger compartment filter, your vehicle is equipped with an air purification system that helps to maintain high air quality in the passenger compartment.

CleanZone

CleanZone indicates whether conditions for good air quality are met or not.

4.2.7.1. Air quality indication

The air quality tab in the center display's climate view provides you with information on air quality both inside and outside of the vehicle.

Information in the air quality tab indicates the quality of the inside and outside air. A sensor measures the content of particles smaller than 2.5 µm in the passenger compartment. The information on the content of contaminants outside the vehicle is provided by an external service and is based on modeled data.



Tip

For some regions, information on pollen levels is available. Press **Air quality and pollen** to see more detailed information.

4.2.7.2. Air cleaning

To provide good air quality, your vehicle is equipped with different air cleaning capabilities.

Your vehicle has multiple functions to ensure good air quality. Some of these are passive, while others can be controlled in the center display.

4.2.7.2.1. Advanced air cleaning

Advanced air cleaning aims to minimize the amount of hazardous particles and harmful gases in the passenger compartment.

Advanced air cleaning is always active except during air recirculation or when the climate system is turned off.

4.2.7.3. CleanZone

CleanZone is an air quality function that controls and indicates whether all conditions for providing good air quality are met.

You can find information regarding air quality in the climate view. CleanZone is achieved if all conditions to provide a good air quality in the passenger compartment are met. If it can't be obtained, you can see in the center display which condition is still not met.

4.2.7.4. Activating air recirculation

Air recirculation helps you keep out harmful or foul-smelling air from the passenger compartment. In some cases, it's activated automatically but you can also activate it manually in the climate view.

By default, the climate system automatically decides whether to recirculate air depending on certain environmental conditions. If the air quality sensor notices that the outside air is polluted, your vehicle will automatically close the air intake and instead recirculate the air in the passenger compartment. You can also manually activate constant air recirculation to close the air intake if you want to.

Important

If air is recirculated for a long period of time, condensation can fog up the windows, which can affect visibility.

Note

Air recirculation is unavailable while max defroster is active.

If you activate air recirculation manually, it will time out after a while.

In colder climates, air recirculation may not activate due to a risk of mist.

1. Press the fan symbol  in the bottom bar.

2. Press the recirculation symbol .

4.2.8. Climate system

Your vehicle's climate system seeks to provide everyone in the vehicle with a comfortable environment using electronic climate control.

All climate control system functions are controlled via the center display.

Your vehicle uses sensors to automatically control different capabilities that are designed to offer a comfortable interior climate at all times.

4.2.8.1. Climate zones

The passenger compartment is divided into different climate zones. These zones enable passengers to set their own preferred temperature to enjoy a comfortable environment.

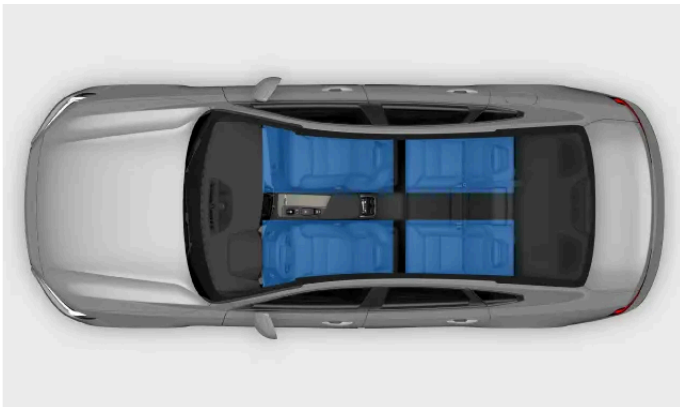

Climate zones

Your vehicle's passenger compartment is divided into different climate zones. All zones are directly synced to the driver's preferred climate settings by default. However, the rear zones can have their own individual temperature setting.

4.2.8.2. Perceived and actual temperature

Your temperature perception is affected by several factors besides the actual temperature of the air around you. Knowing the difference between perceived and actual temperature can benefit your climate comfort experience.

Whether the air in your vehicle feels warm or cold depends not only on its temperature but also several other factors. These factors include your own body temperature, airflow and humidity in the vehicle, and whether you're exposed to direct sunlight.

The content of this manual represents the status of the user manual at the time of printing and may not be completely valid in future instances. For more information refer to the first page for the complete disclaimer note.

When you adjust the temperature setting, the vehicle considers some of the factors contributing to your perceived temperature. The vehicle then continuously adapts its climate functions to make the interior climate feel like the temperature you selected. This means that the actual temperature in your vehicle may differ from the temperature you selected, giving you a more consistent climate comfort experience.

Your vehicle takes exposure to sunlight into consideration when regulating the climate in the vehicle. For example, if the sun hits the driver's side, it can adjust the airflow and temperature to balance the perceived temperature on that side.

4.2.8.3. Climate sensors

There are several climate sensors located inside and outside of your vehicle. These sensors help to provide a comfortable climate in the passenger compartment.

For the interior sensors to be able to perform as intended, it's important that you don't cover them.

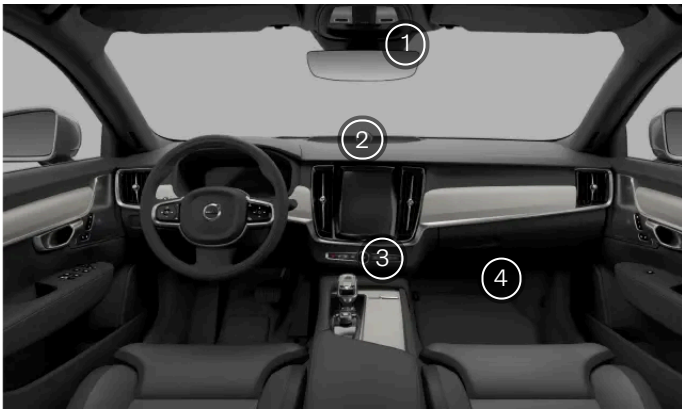

Interior climate sensors

- ① Moisture sensor in the rearview mirror console.
- ② Sunlight sensor on the upper side of the dashboard.
- ③ Passenger compartment temperature sensor under the center display.
- ④ Airborne particulate matter sensor on the underside of the glove compartment.

The exterior ambient temperature sensor is located in the right door mirror.

4.3. Windows and glass panes

Your vehicle has several different windows and glass panes. The windshield is laminated for added safety and security.

Any laminated windows, except for the windshield and panoramic roof, are labeled with a laminated glass symbol.



Panoramic roof

The panoramic roof is divided into two glass sections. You can open the front part vertically or horizontally using the control in the overhead console, but the glass in the rear section is fixed.

4.3.1. Operating the windows

You can use the power switches in the door panels to operate the windows. The switches in the driver door can control all of the windows in your vehicle.

Warning

Always consider the safety risks while operating the windows. The vehicle's moving parts can injure children or other occupants, as well as damage objects.

- Make sure you have a clear view of the windows you operate.
- Don't allow children to play with the window controls.
- Never leave children alone in the vehicle.
- Always switch off the power supply to the power windows by turning the ignition off. Take the key with you when leaving the vehicle.
- Never put an object or body part through an open window, even if the vehicle's electrical system is fully disconnected.

All of the windows have built-in pinch protection to help prevent injuries. Be sure to read the relevant information on pinch protection in its separate section of the manual.

To use the power windows, you need to turn the ignition on. However, if you turn the ignition off and don't open any of the doors, the windows may still work for a few minutes.

i Note

Situations where the windows can't be opened

- The windows cannot be opened at speeds above approximately 180 km/h (112 mph) but they can be closed.
- At very low temperatures, the windows might freeze in place and you won't be able to operate them.

1.



Use the switches to open or close the windows:

- A slight push or pull allows you to manually operate the window until you release the switch.
- If you push or pull the switch fully, the window automatically moves even if you release the switch. Stop it by moving the switch in the opposite direction.

i Tip

Operating all of the windows at the same time

If you're carrying a key, you can open or close all of the windows at the same time by holding a finger against the indentation on the outside of the door handle. You can also press and hold the locking button on your standard key.

Noise reduction

One way to reduce wind noise when the rear windows are open is to also open the front windows slightly.

Child lock

You can disable the rear window controls. This prevents rear seat passengers from operating the windows.

i Note

If automatic window movement or pinch protection isn't working properly, you may need to reset the windows. You can learn how to do this in a separate section of the manual.

4.3.2. Operating the panoramic roof

You can open and close the panoramic roof and the sun blind to control how much air or sunlight you let in.

You can operate the panoramic roof and the sun blind by using the touch-sensitive control in the overhead console.



By touching or swiping over the control in different ways you can:

- open and close the sun blind
- tilt the front part of the panoramic roof to open it in the vent position
- retract the panoramic roof partially or fully
- close the panoramic roof.

i Note

- Remember to remove ice and snow before opening the panoramic roof. Take care not to scratch surfaces or damage trims.
- At very low temperatures, the panoramic roof might freeze in place and you won't be able to operate it.

Opening the vent position

- Tap anywhere on the control.
- > The panoramic roof tilts open to the vent position.

Closing the vent position

- From the vent position, tap anywhere on the control.
- > The panoramic roof closes.

Opening the sun blind

- Swipe backward once over the control.
- > The sun blind opens.

Opening the panoramic roof

The content of this manual represents the status of the user manual at the time of printing and may not be completely valid in future instances. For more information refer to the first page for the complete disclaimer note.

- Swipe backward twice over the control.
- > The roof opens partially.
- Swipe backward three times over the control.
- > The roof opens fully.

Closing the sun blind and panoramic roof

- Swipe forward over the control.
- > The sun blind and the panoramic roof close.

Note

Make sure to close the sun blind when your vehicle is parked in direct sunlight for extended periods of time. This can decrease the risk of damage to your vehicle's interior due to heat buildup from the crystal gear selector.

Tip

Closing the sun blind automatically

You can turn on **Auto-close sunroof curtain** in settings to make the sun blind close automatically after 15 minutes if the vehicle is parked and locked in warm weather. This helps ensure a comfortable passenger compartment temperature and protects the vehicle's upholstery from fading in the sun.

Operating all of the windows at the same time

If you're carrying a key, you can open or close all of the windows at the same time by holding a finger against the indentation on the outside of the door handle. You can also press and hold the locking button on your standard key.

Warning

Always consider the safety risks while operating the panoramic roof. The vehicle's moving parts can injure children or other occupants, as well as damage objects.

- Make sure you have a clear view of the panoramic roof when operating it.
- Do not allow children to play with the panoramic roof controls.
- Never leave children alone in the vehicle.
- Always switch off the power supply to the power windows by turning the ignition off. Take the key with you when leaving the vehicle.
- Never put an object or body part through an open window or the panoramic roof, even if the vehicle's electrical system is fully disconnected.
- Do not open the panoramic roof when load carriers are fitted.
- Do not place any heavy objects on the panoramic roof.

 **Note**

If pinch protection for the panoramic roof isn't working properly, contact an authorized Volvo workshop.

4.3.3. Pinch protection

To help prevent injuries from power-operated windows and other moving parts, your vehicle has a built-in pinch protection system. Occupants should also keep proper user practices in mind to reduce the risk of getting caught between moving or closing parts.

If something is blocking the window or panoramic roof when it's closing, it will stop and then slightly reverse, allowing you to remove what's in the way. The trunk is covered by pinch protection in a similar way when opening or closing.

 **Warning**

Always consider the safety risks while operating the windows. The vehicle's moving parts can injure children or other occupants, as well as damage objects.

- Make sure you have a clear view of the windows you operate.
- Don't allow children to play with the window controls.
- Never leave children alone in the vehicle.
- Never put an object or body part through an open window, even if the vehicle's electrical system is fully disconnected.

If a window stops closing automatically due to obstructions such as ice, you can still try to close the window manually by continuing to pull the control switch. However, always try to remove the cause of the obstruction first and make sure nothing is blocking the path of the window before trying to close it again.

If there is a problem with the pinch protection for the power windows, you can try to solve the issue by resetting them.

If pinch protection for the panoramic sun roof isn't working properly, contact an authorized Volvo workshop.

 **Warning**

The power window pinch protection may not work properly if the vehicle loses track of the current window position. The window positions are recalibrated when you reset automatic window movement. Always reset it to make sure the window positions are correctly calibrated if:

- the vehicle has lost power: for instance, if the 12 V battery has been disconnected.
- the automatic window movement does not work properly.

This restores the automatic window functionality and re-enables the pinch protection function.

4.3.4. Resetting windows

If you're experiencing issues with a power-operated window, you may need to reset it. This allows the vehicle to recalibrate their position, restoring both pinch protection and automatic movement.

 **Warning**

The pinch protection system might not work properly until the window has been reset after losing calibration.

If the 12 V battery has been disconnected, a reset is required for pinch protection to work.

 **Note**

If the panoramic roof isn't working properly, contact an authorized Volvo workshop.

Before resetting a window, make sure it's fully closed.

Resetting window

1. Pull the window switch upward to the manual position three times, toward the closed position.
- > Recalibration is now done, re-enabling both pinch protection and the automatic window movement.

Check to make sure that the window operates correctly after following the reset steps. The window should close completely when you pull the switch all the way and release. If the problem persists, contact an authorized Volvo workshop.

4.4. Seats

The seats are all designed to provide comfort and safety. Adjust the seats, activate comfort functions, and make sure to sit properly.

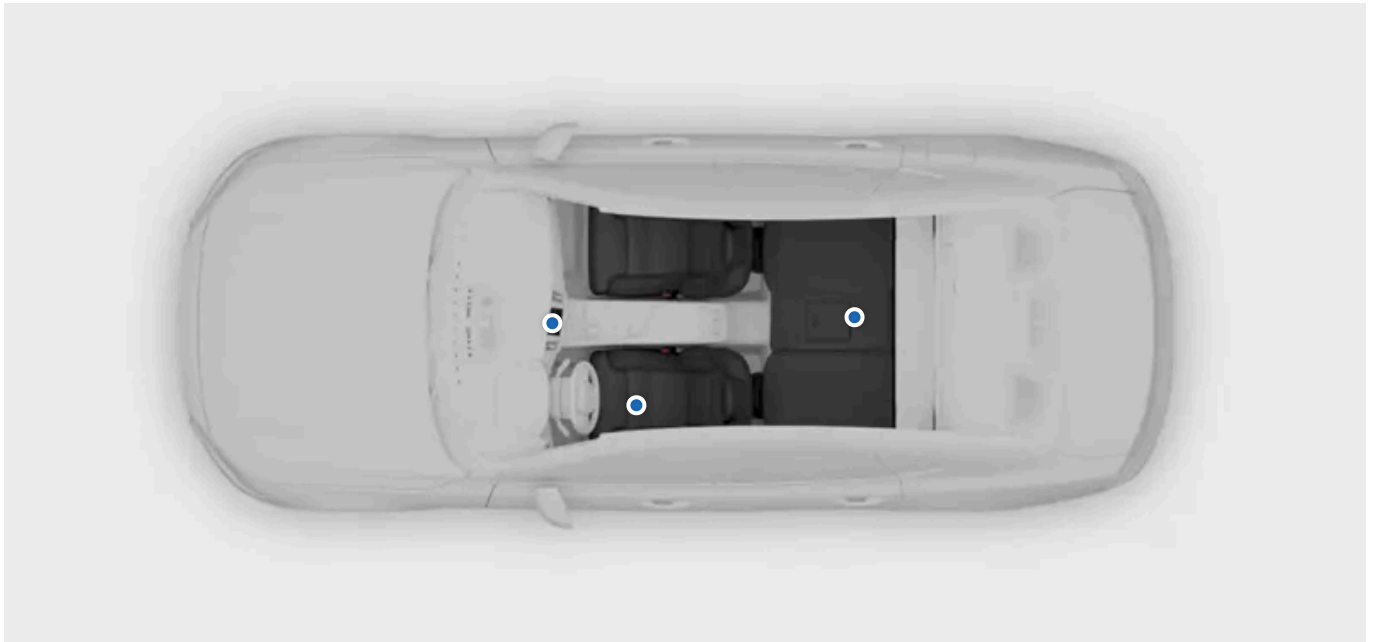

The vehicle seats have a range of features to provide comfort, safety and flexibility.

In this section of the manual, you'll get to know the comfort features and adjustments available for the vehicle seats. This includes features such as the seat positional adjustments and how to fold the rear seats to get more space for stowing. At the same time, you will learn the essentials of how to use these features safely and properly.

A separate safety section in this manual provides more information about the seats' passive safety functions and how to accommodate them through proper seating.

4.4.1. Front seats

The front seats have plenty of adjustments to increase comfort.



Adjustments

The seats have the following adjustment options:

The content of this manual represents the status of the user manual at the time of printing and may not be completely valid in future instances. For more information refer to the first page for the complete disclaimer note.

- Driver seat cushion tilt
- Extending the seat cushion
- Seat position
- Lumbar support
- Seat height
- Backrest tilt



Tip

Seat adjustment knob

You can use the knob on the sides of the seats to make several seat adjustments. By using the knob, you can select what kind of seat adjustments you want to make. The selected adjustments are shown in the center display.

Features

The front seats also have the following comfort features:

Massage You can choose from five different massage programs with three different speeds and intensities.

Ventilation Most parts of the front seats are ventilated. There are three levels of cooling to choose from.

Heating The seats have three levels of heating available.

4.4.1.1. Adjusting the front seats

The vehicle's front seats have a variety of settings to enhance comfort.

Seat adjustment controls

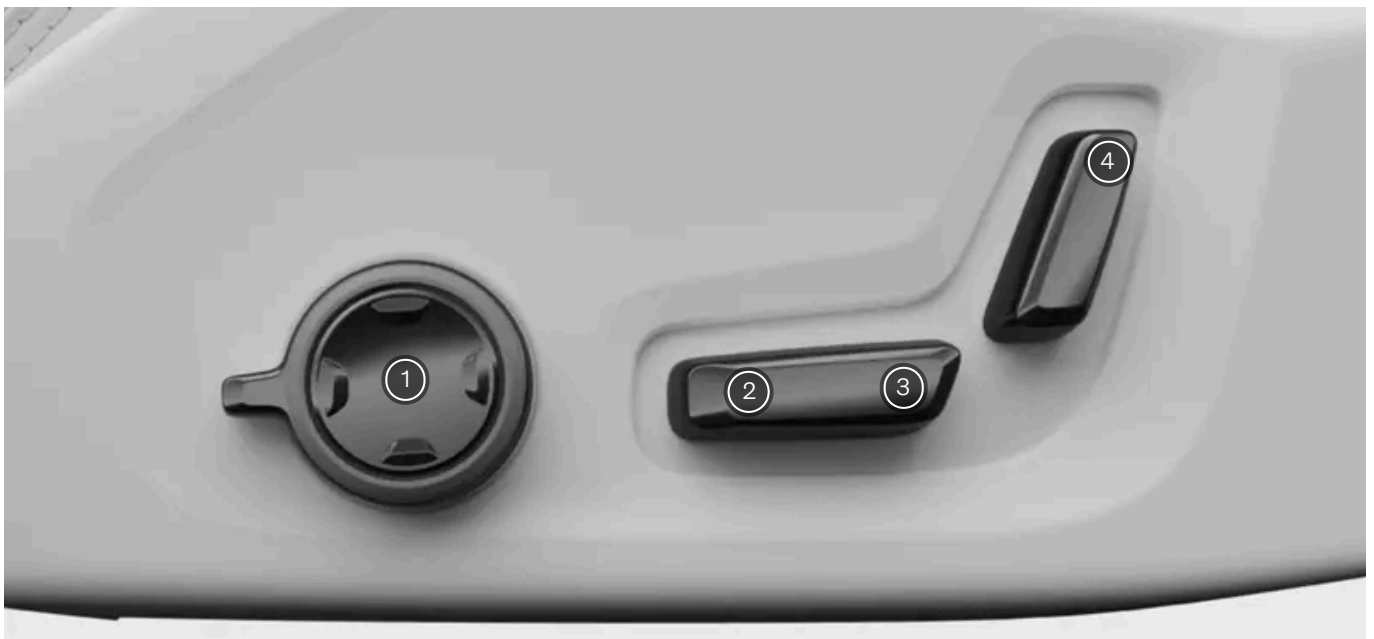

Controls on the side of the seat

The content of this manual represents the status of the user manual at the time of printing and may not be completely valid in future instances. For more information refer to the first page for the complete disclaimer note.

- ① Seat adjustment knob
- ② Seat cushion control
- ③ Seat position control
- ④ Backrest control

The seat adjustment knob controls the following adjustments:

- Side support
- Lumbar support
- Seat cushion extension

When you press the seat adjustment knob, the seat adjustment view appears in the center display to guide you. The different adjustments are shown as separate selections so that you can control them with the same button. To switch between the different adjustment selections, turn the seat adjustment knob and release it. Repeat this until you have selected the adjustment you would like to control.

 **Warning**

Never adjust the seat while driving. This can cause dangerous distraction and loss of control. Instead, be sure to make all necessary adjustments to the seat before starting a drive.

Adjusting the seat using the adjustment knob

1. Turn the seat adjustment knob upward or downward.
 - > The seat adjustments view appears in the center display.
2. Continue to turn the knob repeatedly to cycle through the different adjustment selections.
3. Select the adjustment you want to make via the center display.
4. Adjust the seat using the buttons on the adjustments knob.

 **Tip**

Use a saved seat position

 **Note**

Adjustment lock

If you move the adjustment knob in the same direction 10 times within a short time frame, the knob becomes unresponsive for 1 minute. A message also appears in the center display telling you the seat adjustment controls have been disabled. This is to prevent unintentional use of the adjustment knob.

Adjusting seat cushion tilt

The content of this manual represents the status of the user manual at the time of printing and may not be completely valid in future instances. For more information refer to the first page for the complete disclaimer note.

5. Tilt the seat cushion control up or down to adjust the seat cushion.

Adjusting seat position

6. Move the seat position control left or right and up or down to adjust the position of the seat.

Adjusting backrest tilt

7. Tilt the backrest control in the same direction you want to tilt the backrest.

Important

After adjusting, folding or raising a seat, make sure all parts of the seat are properly locked in place.

4.4.1.2. Saving a preset seat adjustment

You can save preset seat adjustments for the front seats.

Warning

- Because the driver's seat can be adjusted with the ignition off, children should never be left unattended in the vehicle.
- Movement of the seat can be STOPPED at any time by pressing any button on the power seat control panel.
- Do not adjust the seat while driving.
- Adjust the seat so that you can reach and operate the pedals and gear lever in a safe and comfortable way.
- The seat rails on the floor must not be obstructed in any way when the seat is in motion.

By using the preset seat adjustment buttons, you can easily sit in your preferred position again without needing to adjust the seat yourself. The buttons are located on the inside of either one or both front doors.



Location of the preset seat adjustment buttons

1. Adjust the seat to your preferred position.

The content of this manual represents the status of the user manual at the time of printing and may not be completely valid in future instances. For more information refer to the first page for the complete disclaimer note.

2. Press the M button.
 - > The button's indicator light turns on.
3. Press and hold down one of the memory buttons within three seconds of pressing the M button.
 - > When the position has been saved, you will hear a sound signal, and the indicator light will turn off.

Note

If none of the memory buttons are pressed within three seconds, the M button turns off and no position is saved. The seats must be readjusted before a new position can be set.

Your preferred positions are saved in the active user profile.

Use a saved seat position

A saved position can be used with the front door open or closed. However, the process for activating the saved seat position differs.

If your front door is open, you can activate a saved position by pressing one of the memory buttons. The seat moves and stops in the saved position.

If your front door is closed, press and hold one of the memory buttons until the seat stops in the saved position.

If you want to change a saved seat position, adjust the seat to your preferred position and repeat the process again. A new seat position is saved on the selected memory button.

4.4.1.3. Activating seat massage

The front seat has a massage function in the backrest that uses air cushions to give you a massage. There are several different massage programs and settings you can choose from.

The massage function can only be activated when the engine is running.

1. Activate the seat adjustment knob by turning it up or down. You can also press one of the four buttons on the control.



The seat adjustment knob is located on the side of the seat closest to the door.

- > The seat adjustment view appears in the center display.
2. Select **Message**.
 3. Select your preferred program, speed and intensity shown in the center display or use the multifunction control.
 4. Select **Start**.
- > Message starts and a notification appears in the center display telling you how long the message will run for.

If you would like to stop the massage before the massage program finishes, select **Stop** from the message view in the center display.

4.4.2. Rear seats

You can adjust the rear seats in a number of ways to get more space or use the additional features to better suit your needs.

The rear seats are divided into a second and third row, each offering its own set of features and adjustments. Both rows have two seats that can be folded separately.



There are several adjustments and features you can use in the rear seats to increase comfort or meet your needs for cargo space.

Foldable headrests	The outer seats have foldable headrests. This can give you more space when you fold the seats.
Adjustable center headrest	You can adjust the height of the center headrest to fit the passenger or set it to its lowest position when the seat is not in use.
Foldable backrests	You can fold the rear seats to create more cargo space. The left seat can fold on its own, while the center and right seats fold together.
Seat heating	The outer seats have access to three levels of heating. You can control this from the panel on the back of the center console or from the center display.



Tip

Rear seat center armrest

Fold out the center seat backrest to access cup holders and get additional arm support.

4.4.2.1. Adjusting center rear seat headrest

The center seat headrest should be adjusted according to your height and should fully support back of your head if possible.

A correctly adjusted headrest can help prevent neck injury during collisions. It's important to align the headrest to cover as much as possible of the back of the head.

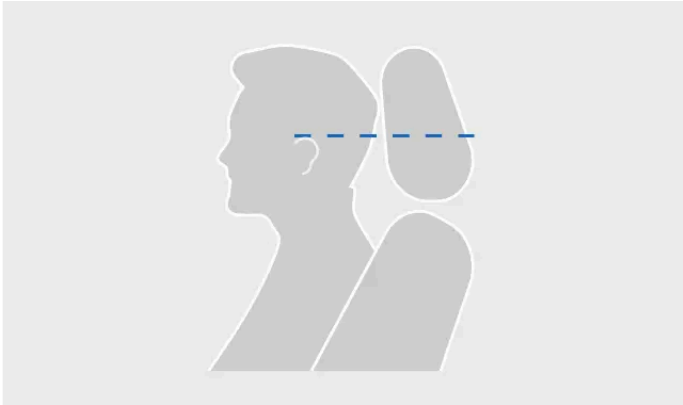

Correct headrest level

Upward movement of the headrest is not locked.

1. Pull the headrest upwards to a level that suits your height.

To lower the headrest, press and hold the button at the base of the right support to release the lock. Then, carefully push the headrest down.



Locking button on the headrest

Tip

Make a habit of lowering the headrest when the center seat is not in use. In the lowered position, it doesn't risk obstructing the rear view.

4.4.2.2. Folding down the outer rear seat headrests

You can fold down the outer second-row seat headrests to improve rear visibility.

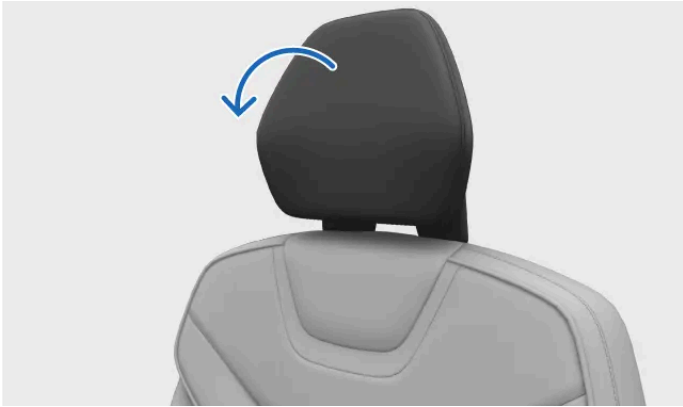

Folding motion of the headrest

 **Warning**

Never fold a headrest while a passenger is using the seat. This can cause serious injury.

 **Note**



You will not be able to fold the headrests if the child lock is active.

 **Important**

Before folding the headrests, make sure:

- there are no loose items left on the seats.
- the seat belts are not buckled.

The headrest must always be raised when a child restraint is installed on the seat.

1. Press the vehicle symbol  in the bottom bar and go to **Quick controls**.
 2. Press the headrest fold button .
- > The headrest folds down.

To raise the headrest again, manually move the headrest back until you hear a click.

4.4.2.3. Folding down the outer rear seats

You can fold the outer rear seats to get more stowing space. The left seat can be folded on its own while the center and right seats fold together.

! Important

Before folding the seats, make sure:

- there are no objects on the seats.
- the seat belts are not buckled.
- there is enough space to fold the seats down. If needed, move the front seats forward.

! Warning

If any of the rear seats are folded down, they must not be in contact with the front seats. This can impede the safety of other occupants.



Press and hold one of the buttons located behind the rear seats on the left-hand side of the vehicle.

- > The backrest and headrest release but remain in the same position.
- Guide the backrest down to its folded position.

Manually push the backrests to their upright position when you no longer need the extra cargo space. Make sure the backrest locks into place. Finally, move the headrest back to its locked position.

! Important

After adjusting, folding or raising a seat, make sure all parts of the seat are properly locked in place.

4.4.2.4. Rear seat center armrest

Part of the center rear seat backrest can be folded out to act as an armrest.

There is a strap attached near the top of the center rear seat. Pull this strap to fold the rear center armrest down.



Rear center armrest with cup holder

The center armrest can provide additional arm support but also contains a cup holder with two slots.

4.5. Interior lighting

The lights in your vehicle's passenger compartment provide illumination for different purposes. There are lights for reading, as well as for general illumination and lighting up storage areas.

Reading lights

The front and rear seats have reading lights. You can adjust their intensity to suit your needs. In the rear, they also work as the general lighting.

General illumination

Your vehicle has lights to provide general illumination of the passenger compartment, such as when you get into the vehicle. General illumination can be activated both manually and automatically.

Ambiance lights

The ambiance lights in the vehicle provide comfortable illumination in the passenger compartment when it's dark outside.

Storage area lights

There are lights in different storage areas, such as the trunk and door pockets, to make it easier to find what you're looking for.

4.5.1. Adjusting the reading lights

There are reading lights available for the front and rear seats. You can adjust the brightness according to your needs.

The front seat reading lights are located in the overhead console and the rear reading lights can be found over the rear doors.



The front reading lights in the overhead console

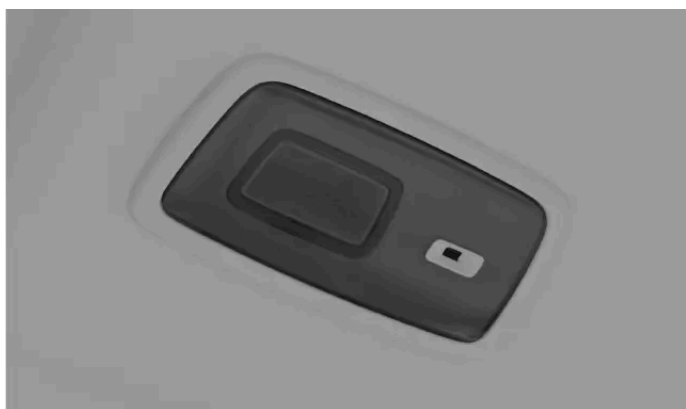

The rear seat reading lights

1. Press the reading light you want to turn on or off.
2. Hold the button down to adjust the brightness.

4.5.2. Adjusting interior lights

You can adjust the brightness of the interior lights to your liking.

You adjust the brightness of the interior lighting via the center display.

1. Press the vehicle symbol  in the bottom bar and go to **Settings**.
2. Go to **Controls** → **Lights and displays** → **Interior lights**.
3. Adjust the brightness or select your preferred intensity.

4.5.3. Disabling interior auto lights

The auto lights off function keeps the interior lights off, even when you are entering or exiting your vehicle.



The auto lights off button in the overhead console

The interior auto lights function, sometimes called courtesy lights, turns the interior lights on automatically when a door is opened. The auto lights can make it easier to enter and exit the vehicle if it's dark outside. However, there may also be situations where you don't want the lights to turn on, such as when passengers are sleeping in the vehicle.

The auto lights off button is located in the overhead console and is marked with an auto lights symbol.



When the function is turned off, the button illumination changes color.

1. Press and hold the button to turn the auto lights function on or off.

 **Tip**

A short press of the auto lights button switches on general lighting, such as the overhead and footwell lights.

4.5.4. Activating all interior lights

Activating all interior lights turns on most of the interior lights. This can be helpful when you're looking for something in the passenger compartment.



All interior lights on button in the overhead console

The activate all interior lights button is located in the overhead console and is marked with a light symbol.



1. Press the button to turn all interior lights on or off.

Note

Holding the button down will disable auto lights, and the button will change color. Even if auto lights have been disabled, the lights will still turn on if you use the lights all on function.

5. Safety

Get to know your vehicle's collision-protection features and what is required for safe use of the vehicle.

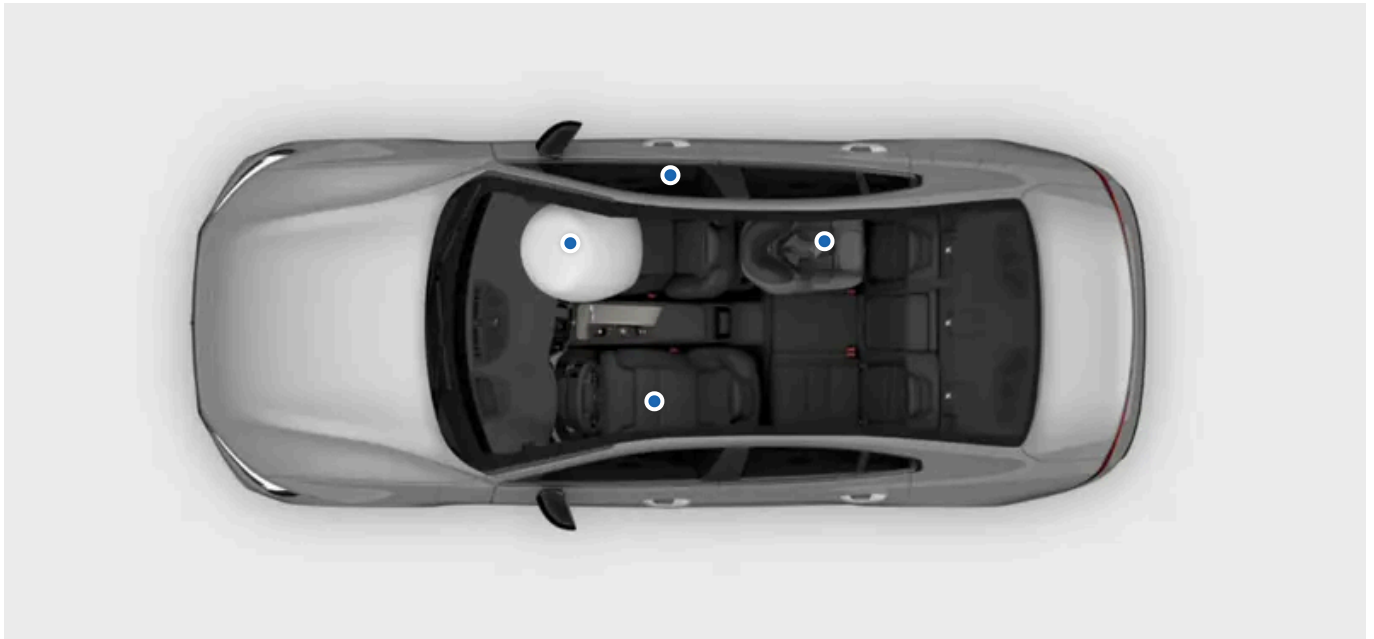

The safety section describes features designed to reduce the risk of serious injury in the event of a collision. The safety features include seat belts, airbags, child restraints and other components or functions that can help save lives when used correctly.

Your vehicle is designed to promote and provide the conditions for safe use. Safety features never replace the need for safe user practice. This not only applies to features directly related to safety but also to the rest of your vehicle. It's your responsibility to use the vehicle's functions safely.

Warning

Safety synergy

The safety features are designed to work together to increase the safety of all occupants in the vehicle. No feature replaces the need for another unless the manual explicitly states so. For example, the presence of airbags in no way reduces the need to wear a seat belt.

SRS warning

Sensors in the vehicle can detect if there is something wrong with the airbags or related safety systems. A red warning symbol will appear in the instrument panel to alert you if any faults are found.



SRS warning symbol

If the red SRS warning symbol appears in the instrument panel, immediately contact an authorized Volvo workshop.

 **Note**

Safety-related areas

Some driver support functions are related to safety. Instead of keeping you safe in the event of an accident, they are designed to prevent them in the first place. Get to know those functions as well for a safer trip.

5.1. Collision response

In the event of a collision, your vehicle has many features designed to help mitigate the effects. Your vehicle's response to a collision happens before, during, and after the impact.

 **Tip**

You can find information related to collision response in many places throughout this manual. Therefore, this section exists to provide a more comprehensive overview of your vehicle's capabilities in this area.

Before

Before an impact, several driver support functions can work to avoid the collision or reduce its effects. If the vehicle perceives a collision to be likely or unavoidable, it has the ability to preemptively activate protective systems, such as seat belt pretensioning, before the impact occurs.

During

During a collision, sensors throughout the vehicle continuously provide information about the states of the vehicle and its occupants. The vehicle uses the information to selectively time and activate protective functions such as airbag deployment and seat belt pretensioning. Collisions are complex events that can unfold in several stages, where the first impact isn't necessarily the most severe. Good timing is essential for the best chance of effective protection.

The vehicle's safety systems work in synergy with passive safety features. In the event of a collision, your vehicle's construction distributes forces to specific structural components. It also takes advantage of crumple zones that absorb energy from the impact. Using similar principles, the exterior has been designed with the protection of pedestrians in mind.

After

After a collision, the vehicle tries to stop in a controlled and safe manner. It can also make an automated call for emergency response.

 **Note**

Safety mode

During a collision, the safety systems of the vehicle may deactivate certain functions. This is to protect both the occupants and the vehicle itself from potential damage caused by collision. At the same time, the vehicle enters safety mode. When safety mode is active, you cannot drive the vehicle. However, depending on the severity of the collision, you may be able to exit safety mode by restarting the vehicle if you need to move the vehicle out of immediate danger. This in turn reactivates the necessary functions and enables short-distance driving.

 **Important**

Your vehicle is designed around safety, but no protective system is 100% effective in all situations. Safety features never replace the need for safe user practice.

5.2. Occupant detection

Your vehicle can remind you not to leave anyone or anything important in the vehicle when you leave it.

Presence reminders

Your vehicle monitors your use of the doors and alerts you if it suspects that passengers, pets or belongings are still inside the vehicle when you turn it off.

When this happens, a notification in the instrument panel reminds you to check that no passenger or object was forgotten in the rear seat.

 **Warning**

Volvo recommends that you do not leave people or pets in a locked vehicle.

Some regions have laws prohibiting people or pets being left inside a locked vehicle.

5.3. Proper seating

Appropriate seating and proper seat belt use are essential for the safety and comfort of everyone in the vehicle. There are also specific recommendations for pregnancy and child seating.

Important

Importance of proper seating

Safety features, such as seat belts and airbags, require that all occupants are properly seated for the best chance of effective protection in a collision. Failure to follow the seating instructions can endanger life or lead to serious injury.

Pregnancy

Take extra care to follow all seating recommendations if the occupant is pregnant. The following are either additions or of extra importance:

- Make sure that the seat belt does not cross the abdomen. The hip strap should be under the belly and the shoulder section should pass above it.
- In the driver's seat, avoid sitting closer to the steering wheel than necessary. Adjust the seat to create as much distance as possible between your abdomen and the steering wheel while still keeping all driver controls comfortably within reach.

Child seating needs

Always seat children with extra care and attention to their needs. Make sure you have the required child restraint, that it's installed correctly, and that the child remains safely seated throughout the entire trip. For children traveling facing forward, the same seating recommendations apply as for adults. Always make sure the seat belt is properly adjusted and that the headrest is at a height suitable for the child when possible.

Note

Physical limitations

Physical limitations can prevent an occupant from following the seating recommendations. The vehicle may need modifications to accommodate safe use. Contact an authorized Volvo workshop for information about Volvo-approved modifications.

Sitting posture

Both sitting posture and proper seat belt adjustment are important for safety. Avoid irregular sitting postures.

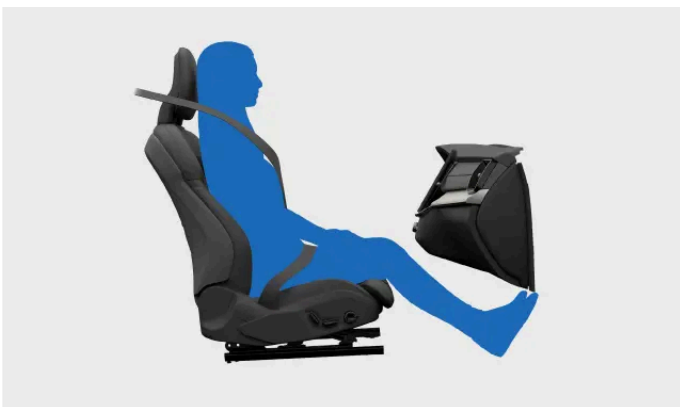

A correctly seated occupant. Do not adopt other postures when the vehicle is moving.



Do not slide forward in the seat. The lower back should have contact with the backrest.



Keep both feet planted on the floor.



Do not tilt the backrest to a lying position. The seat belt must remain tensioned against the shoulder.

Whiplash protection considerations

Proper headrest use is essential to reduce the risk of neck injuries in a collision. All of the vehicle's headrests are designed to help protect the head and neck when used correctly. As an added safety feature, the front seats' construction can reduce the risk of whiplash injuries in certain collisions. These seats are designed to shift in a way that lowers whiplash-associated forces.

- Keep the back of your head against the headrest.
- Make sure occupants have correctly adjusted headrests when possible.
- Avoid stowing luggage against the back of the front seats. This can prevent the seat from moving as intended in the event of a collision.

The content of this manual represents the status of the user manual at the time of printing and may not be completely valid in future instances. For more information refer to the first page for the complete disclaimer note.

5.4. Seat belts

When you use seat belts correctly, they can help prevent serious injury in situations ranging from sudden braking to severe collisions.

Seat belt features



The seat belt locks itself to act as a safety restraint under certain conditions, such as sudden and forceful pulling of the belt, if the vehicle is driven aggressively and if the vehicle is on a steep incline.

The seat belt can also adjust as a safety precaution in a high-risk situation.

Built-in seat belt pretensioners can tighten the seat belts extremely quickly in response to a collision.

When installing certain child restraints^[1], all of the vehicle's seat belts except the driver's seat belt can be set to only retract.

Seat belt reminder

The vehicle uses built-in sensors to detect if the driver or any of the passengers aren't using their seat belts. The system alerts the driver with a warning sound, and the seat belt reminder symbol appears in the overhead console.



Seat belt reminder symbol

 **Important**

Wearing seat belts

These are the essentials for wearing seat belts properly. There is also more detailed information in other sections of the manual covering proper seating and seat belt adjustments.

- Make sure that everyone in the vehicle wears their seat belt and that all belts are properly adjusted.
- Adjust the upper attachment point of the seat belt to fit the wearer's size.
- Wear the seat belt closely against the body.
- Minimize slack in all belt segments.
- Allow the belt to run as straight as possible between its three anchor points.^[2]
- Have the backrest in an upright position.
- Follow all seating and posture recommendations.^[3]
- Do not wear the seat belt in ways other than those described in this manual.
- Always use seat belts when driving.
- Never use the same seat belt for more than one individual at a time.

 **Warning**

Seat belt care and maintenance

- Never modify or repair seat belts or related parts, such as fittings and hooks, yourself. Any service or replacement must be done by a trained technician with access to type-approved parts.^[4]
- Contact an authorized Volvo workshop if the seat belt or a related part shows signs of damage or wear.
- Replace the seat belt if it has been subjected to a heavy load, such as in a collision. It may have lost protective properties even if there is no apparent damage.
- Clean the seat belt as soon as possible if anything is spilled onto it. The spilled substance can enter the mechanism and deteriorate the material.

^[1] Read everything about child safety before installing a child restraint.

^[2] For example, never wrap it around or attach it to other items or fittings in the vehicle.

^[3] There are general seating recommendations, as well as specific recommendations for children and pregnant occupants.

^[4] Volvo recommends an authorized Volvo workshop.

5.4.1. Fastening and adjusting seat belt

A correctly fastened and adjusted seat belt is important for your safety and comfort.



Correctly fastened and adjusted seat belt.

i Note

These instructions apply to adults and children who are seated normally or are using a booster seat or booster cushion. Read the separate section covering child safety for detailed information about child seating and different types of child restraints.

Fastening the seat belt

1. Pull the seat belt out by the latch plate. If you pull too fast, the locking mechanism will engage.
 2. While extended, check the belt for twists, knots or damage.
 3. Insert the latch plate into the buckle.
- > The latch plate clicks into place.

! Warning

Check when seat belt is fastened

- The seat belt should run directly and as straight as possible between its three anchor points. Any unnecessary slack increases the risk of injury.
- Make sure everyone in the vehicle is wearing their seat belt correctly.
- Use the correct buckle for each rear seat belt. Using the wrong buckle can lead to a seat belt malfunction or failure.

Adjusting the seat belt

4. For front seat occupants, adjust the height of the seat belt upper attachment point.



Seat belt top attachment point.

1. Hold the button on the upper attachment point down to allow it to slide up and down.
 2. Place it as high as possible without the belt touching the throat or neck.
5. Tension the hip strap to remove slack by pulling upwards on the diagonal chest strap. It should be as straight and low as possible, running below the abdomen.

 **Important**

Pregnancy

Take extra care to follow all seating recommendations if the occupant is pregnant. Make sure that the seat belt does not cross the abdomen. The hip strap should be under the belly and the shoulder section should pass above it.

Releasing the seat belt

6. Release the seat belt by pressing the buckle button.
7. Guide the seat belt back to its retracted position.

 **Important**

Make sure the seat belt retracts fully after using it. Closing a door with the seat belt caught in the gap can damage both the seat belt and the door.

5.4.2. Setting seat belt to only retract

By setting the seat belt to only retract, you can tighten the belt without it loosening when you let go. This allows you to install certain child restraints in your vehicle that are secured using the seat belt.

When set to only retract, the seat belt's locking mechanism will engage continuously. This allows you to tighten the belt manually to secure a seat belt-installed child restraint.

All seat belts in your vehicle, except for the driver's seat belt, can be set to only retract.

1. Pull the seat belt out fully.
- > When the full length is unfurled, the belt switches to only being able to retract.

Allow the seat belt to retract fully to return the seat belt's function to normal.

 **Important**

Seat belts can only be used to install child restraints specifically designed for seat belt installation. Always follow the instructions that come with the child restraint.

5.4.3. Seat belt reminder

The vehicle uses built-in sensors to detect if the driver or any of the passengers aren't using their seat belts.

If the vehicle detects any occupants that are not wearing their seat belts, the system alerts the driver with a warning sound, and the seat belt reminder symbol appears in the overhead console and in the instrument panel.



Seat belt reminder symbol

You can find information about which seat belts aren't fastened in the instrument panel.



Vehicle overview in the instrument panel

If the reminder appears, buckle the indicated seat belts as soon as possible in a safe manner. Stop the vehicle, if necessary, to avoid distracted driving.

In some cases, the sensors may mistake an object on the seat for a passenger and alert you if the seat belt hasn't been fastened. If you dismiss these reminders in the instrument panel, the large graphic will disappear, but the other warning indicators will remain active. Buckle the seat belt to remove them.

 **Warning**

Always make sure everyone in the vehicle wears their seat belt.

5.5. Airbags

There are several airbags that your vehicle can deploy in a collision. They can help reduce the impact forces experienced by occupants.



The image shows a selection of available airbags. Continue reading for details on the airbags in your vehicle.

The airbags are designed to work with the rest of the vehicle's safety features. Their effectiveness particularly relies on proper seating and seat belt use. An airbag deployment is a sudden, forceful but controlled event that can significantly lower the risk of serious injury for correctly seated occupants.

Warning

The airbags cannot work as intended in the event of a collision if an occupant is incorrectly seated. Always use seat belts.

Sensors throughout your vehicle allow it to deploy different airbags based on information about the collision itself, as well as the status of the vehicle and its occupants.

Airbag types

Your vehicle has the following airbag types:

- Front airbags** Frontal collision airbags for the front occupants.
- Side airbags** Seat-integrated side-on collision airbags for the front occupants.
- Inflatable curtains** Ceiling-mounted airbags for occupants seated by a window.

5.5.1. Airbag deployment

If an airbag has deployed, your vehicle needs to be recovered and serviced.

When the vehicle deploys an airbag, it inflates almost instantly with considerable force, accompanied by a loud noise. After that point, it behaves differently depending on the type of airbag. The front and side airbags deflate as they are compressed and provide controlled cushioning for a single severe impact. The inflatable curtains stay inflated longer to protect against repeated impacts.

 **Warning**

Airbag-related injuries

No safety feature can prevent all possible injuries in a collision. The airbags are designed to reduce the risk of severe injuries. Impacting an airbag often results in some form of injury, and several factors affect the type and severity of the injury. Reading the manual allows you to recognize and avoid practices known to increase the risk of injury.

To reduce the risk of airbag-related injuries in a collision:

- Follow the manual's instructions for proper seating and use of seat belts.
- Learn the placement of all airbags and how they affect the use of your vehicle.
- Properly stow loose objects when driving and do not place or mount any objects around the airbag deployment areas.
- Do not make any modifications to the interior or electrical systems of your vehicle that are not approved by Volvo.

 **Note**

Deployment conditions

Not all airbags may deploy in a collision. This is because different airbags require different conditions and forces to deploy. The severity of damage to the vehicle after a collision is not a reliable indicator of whether any airbags should have deployed.

Airbag gases and smoke

- The gas inside an airbag contains smoke that releases into the interior compartment when the airbag deflates.
- Always be attentive to signs of fire after a severe collision, but keep in mind that some smoke is normal if an airbag has deployed.

After airbag deployment

After a collision in which the airbags have deployed, prioritize the safety and medical needs of those involved in the accident. Before handling the vehicle, contact an authorized Volvo workshop. Follow the manual's instructions for safe handling and recovery of a vehicle that's immobilized or in safety mode.

 **Important**

Do not try to drive or move the vehicle if any of the airbags have deployed. If the vehicle poses an acute traffic hazard and is able to move, an exception can be made to move it a short distance out of immediate danger.

5.5.2. Front airbags

The front airbags are designed to deploy in certain frontal collisions. An occupant sensor controls whether the front passenger airbag is enabled or disabled.

The front airbags can help protect the driver and front passenger from severe injury if they are properly seated during a collision. The airbags on each side deploy independently of one another.



The driver side has two front airbags. The upper airbag is packed inside the steering wheel and the knee airbag is packed behind a panel below the steering wheel.

The passenger side has a single front airbag. The airbag is packed behind a panel above the glove compartment.

All front airbag locations are marked with the text AIRBAG or SRS AIRBAG.

Warning

Do not block the front airbags

- Do not place luggage, children or pets in the space between the seated occupant and the front airbags, including in the occupant's lap.
- Legs or feet must never be placed on the dashboard. This could endanger life or lead to serious injury.
- Do not place or mount any items on the dashboard. Even small objects can become dangerous projectiles in a collision and end up between inflating airbags and occupants.

Blocking airbags in general

Keep all airbag locations and expansion spaces free of obstructions. Obstructions can reduce airbag effectiveness and cause serious injury.

- Follow the instructions for a correct sitting posture.
- Properly stow luggage and other objects. The vehicle has several luggage compartments for safe stowing.
- Do not modify or mount accessories onto any panel covering an airbag or adjacent panels.

Passenger airbag status

The vehicle is equipped with an occupant sensor that controls whether the passenger airbag is enabled or disabled. Read its separate section for detailed information about sensor-controlled airbag status.

The content of this manual represents the status of the user manual at the time of printing and may not be completely valid in future instances. For more information refer to the first page for the complete disclaimer note.

If the occupant sensor has disabled the front passenger airbag, the status will be shown in the overhead console.



This icon indicates that the passenger airbag is disabled and cannot be deployed by the vehicle.

 **Warning**

Child restraints and front passenger seat

Never use a child restraint in the front passenger seat. Volvo follows NHTSA's and Transport Canada's recommendations and recommends that all children up to and including 12 years of age sit in the rear seat. This is a particularly strong recommendation for children in rearward-facing child restraints.

 **Tip**

Read everything about airbags

There is more information about airbags and safety in general. Make sure you have read everything about these topics so that you understand the capabilities and limitations of your vehicle's safety features.

5.5.2.1. Sensor-controlled passenger airbag status

The vehicle has a system for detecting the presence of a correctly seated occupant in the front passenger seat. The system disables the front passenger's airbags under certain conditions. When disabled, the airbags will not deploy in a collision.

The vehicle determines whether the front passenger airbags should be enabled or disabled. This requires that the seat be used as Volvo intended. Follow all available recommendations about proper seating and use.

 **Warning**

Always check the status if you are not sure whether the front passenger airbags are enabled or disabled. If the passenger airbag is disabled, this will be visible in the overhead console.

 **Note**

NHTSA child seating recommendations

Volvo follows NHTSA recommendations and recommends that ALL children up to and including 12 years of age sit in a rear seat and be restrained in a suitable manner appropriate to their height and weight. This is strongly recommended for children in rearward-facing child restraints.

Conditions for enabled airbags

The content of this manual represents the status of the user manual at the time of printing and may not be completely valid in future instances. For more information refer to the first page for the complete disclaimer note.

The front passenger airbag status depends on the sensor reading of the occupant's presence and classification. The airbag will be enabled under the following conditions and so will deploy in a collision.

- A heavy object is placed on the seat.
- The seat is occupied by a person, whether a child or adult, weighing more than the threshold for enabling the airbag.

Conditions for disabled airbags

The front passenger airbag status depends on the sensor reading of the occupant's presence and classification. The airbags will be disabled under the following conditions and thus will not deploy in a collision.

- The front passenger seat is unoccupied. Small and medium-sized objects placed on the seat are typically not heavy enough to affect airbag status.
- A child or small person is occupying the seat, with or without a booster seat.
- A rearward-facing infant seat is installed according to the manufacturer's instructions.
- A forward-facing child restraint is installed according to the manufacturer's instructions.

The airbags will be disabled regardless of whether or not there is a child sitting in the seat or child restraint.

A symbol in the overhead console indicates that the passenger airbags are disabled and will not be deployed by the vehicle. It is shown along with the words PASSENGER AIRBAG OFF.



Symbol indicating disabled airbags.

Safe and correct use

Warning

Pay attention to the sensor system indicator. Failure to follow these instructions could adversely affect the system's function, lead to incorrect airbag status and result in serious injury of an occupant.

- Do not place any objects that add to the total weight on the seat when it is occupied.
- Do not use the seat belt in a way that exerts more pressure on the passenger than normal.
- The full weight of the front-seat passenger should always be on the seat cushion. The passenger should never lift themselves off the seat cushion using the armrest in the door or the center console, by pressing their feet on the floor, by sitting on the edge of the seat cushion or by pressing against the backrest in a way that reduces pressure on the seat cushion.
- Never wrap the seat belt around an object on the front passenger's seat.
- Do not place any object around or under the front passenger's seat in such a way that jamming, pressing or squeezing occurs between the object and the front seat.

5.5.3. Side airbags

The content of this manual represents the status of the user manual at the time of printing and may not be completely valid in future instances. For more information refer to the first page for the complete disclaimer note.

The side airbags are designed to deploy in the event of a side-on collision.

The side airbags can help protect the driver and front passenger if they are properly seated. The side airbags will typically only deploy on the collision side of each front seat.



Side-collision airbags for the front occupants.

The side airbags are placed on the side of each front seat closest to the door. The airbags are packed into the seat's back frame.

Both front seats have markings with the text AIRBAG where the airbags are placed.

Warning

Do not block the side airbags

- Do not place any objects on the side of the front seats. Objects between the seats and the door panel can interfere with the side airbags.
- Do not use seat covers that have not been approved by Volvo.

Blocking airbags in general

Keep all airbag locations and expansion spaces free of obstructions. Obstructions can reduce airbag effectiveness and cause serious injury.

- Follow the instructions for a correct sitting posture.
- Properly stow luggage and other objects. The vehicle has several luggage compartments for safe stowing.
- Do not modify or mount accessories onto any panel covering an airbag or adjacent panels.

Tip

Read everything about airbags

There is more information about airbags and safety in general. Make sure you have read everything about these topics so that you understand the capabilities and limitations of your vehicle's safety features.

5.5.4. Inflatable curtains

Your vehicle's inflatable curtains help protect occupants seated by a window in certain collisions. They are placed above the doors on both sides of the vehicle.

The inflatable curtains are designed to help protect the head of a properly seated and secured occupant. Unlike conventional airbags, the inflatable curtains stay inflated for an extended time after deployment.



Inflatable curtain deployed on one side of the vehicle.

The inflatable curtains are packed behind panels along the ceiling's edges on both sides of the vehicle. The panels are marked IC AIRBAG.

Warning

Do not block the inflatable curtains

- Do not hang heavy items from the ceiling hooks or handles. The hooks are meant for light coats and jackets.
- Do not modify or mount accessories to the panels covering the inflatable curtains, the ceiling, pillars or adjacent panels.

Blocking airbags in general

Keep all airbag locations and expansion spaces free of obstructions. Obstructions can reduce airbag effectiveness and cause serious injury.

- Follow the instructions for a correct sitting posture.
- Properly stow luggage and other objects. The vehicle has several luggage compartments for safe stowing.
- Do not modify or mount accessories onto any panel covering an airbag or adjacent panels.

Tip

Read everything about airbags

There is more information about airbags and safety in general. Make sure you have read everything about these topics so that you understand the capabilities and limitations of your vehicle's safety features.

5.5.5. Airbag maintenance and servicing

Contact an authorized Volvo workshop if there is any indication of faults or damage to the airbags or other safety systems.

Any servicing or repairs of the airbags and related safety systems must be performed by authorized service technicians.^[1] Never attempt to alter or repair any part of the vehicle's safety systems yourself. Incorrectly performed repairs can lead to malfunctions and serious injury. Contact an authorized Volvo workshop when your vehicle needs servicing or repairs.



Warning

Vehicle modifications and airbags

Modifications to the vehicle risk affecting airbags and other safety systems. Carefully read the section about vehicle modifications, and contact Volvo^[2] if you are considering modifying your vehicle in any way^[3], such as when accommodating a disability.

Airbags and water damage

If the vehicle has been flooded or the interior has been exposed to excessive amounts of water, there may be water damage affecting the safety systems. This can lead to unintentional airbag deployment and cause injury.

- Do not use the vehicle if you suspect it has water damage.
- Contact Volvo Assistance for recovery support.



Note

A warning appears in the instrument panel if the vehicle detects any airbag faults. Immediately contact an authorized Volvo workshop if this happens.



Red SRS warning symbol

^[1] Volvo recommends an authorized Volvo workshop for any repairs or servicing.

^[2] You can find detailed contact information in a separate section in this manual or by contacting Volvo support.

^[3] This applies to all parts of the vehicle, but the front seats and all airbag locations are especially necessary to consider.

5.5.6. Airbag labels

The airbag labels in your vehicle provide essential information about the airbags or can act as airbag location markers.

Airbag location labels

The content of this manual represents the status of the user manual at the time of printing and may not be completely valid in future instances. For more information refer to the first page for the complete disclaimer note.

Places in your vehicle marked either AIRBAG, IC AIRBAG or SRS AIRBAG indicate that there is an airbag in that location.

 **Warning**

Airbag label locations

The airbag label locations tell you where your vehicle's airbags are located. Keep these locations and the space around them free of objects. Obstructions can interfere with airbag deployment, reduce their effectiveness and cause serious injury. The airbags section contains more detailed information about use and conditions that can affect the airbags.

Airbag information labels



This label is located on the front passenger seat sun visor.

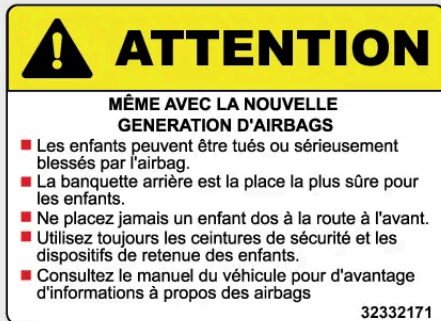

This label is located on the front passenger seat sun visor.

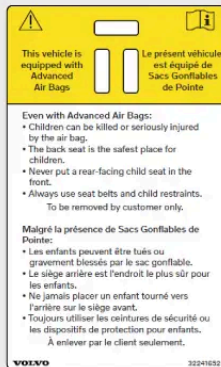

This label is located in front of the dashboard on the front passenger side.

 **Warning**

Child restraints and front passenger seat

Never use a child restraint in the front passenger seat. Volvo follows NHTSA's and Transport Canada's recommendations and recommends that all children up to and including 12 years of age sit in the rear seat. This is a particularly strong recommendation for children in rearward-facing child restraints.

5.6. Child safety

Several features in the vehicle aim to increase child safety, including anchor points for child restraint installation and child locks.



Children in the vehicle should always be securely seated and kept under adult supervision. Follow the recommendations in this manual, as well as local regulations and recommendations that apply to you.



Warning

Securely seated

- Children should be securely seated in a child restraint or with the vehicle's seat belt, depending on their age and size. Never let a child sit in the lap of another passenger or in a location not intended for passengers.
- Other occupants in the vehicle should be properly seated and use their seat belts correctly. This can help prevent serious injury to children in the vehicle in situations, ranging from sudden braking to severe collisions.

Under supervision

- Never leave children alone in the vehicle. Children may be exposed to potentially harmful temperatures on hot or cold days, or may lock themselves in.
- Do not allow children to play in the vehicle or play with any of the vehicle's controls. This reduces the risk of injury to the child or inadvertent activation or deactivation of the vehicle's features.

5.6.1. Child restraints

Children should always use suitable child restraints and be securely seated in the vehicle according to given recommendations.

Different types of child restraints are specifically designed for certain age and height ranges. Your vehicle is equipped with child restraint attachment points that suit different types of child restraints.

Volvo follows NHTSA's and Transport Canada's recommendations and recommends that all children up to and including 12 years of age sit in the rear seat. This is a particularly strong recommendation for children in rearward-facing child restraints.

Child restraints are classified into different approval levels:

Universal	A child restraint of this approval level can be installed on a seat in any vehicle model, as long as the vehicle seat position is suitable for universally approved child restraints according to the vehicle's manual.
Vehicle specific	A child restraint of this approval level can be installed on a seat in specific vehicle models, as long as the child restraint manufacturer has included the vehicle model in the type list for the specific restraint.

 **Warning**

Child restraints and front passenger seat

Never use a child restraint in the front passenger seat. Volvo follows NHTSA's and Transport Canada's recommendations and recommends that all children up to and including 12 years of age sit in the rear seat. This is a particularly strong recommendation for children in rearward-facing child restraints.

Damaged and old child restraints

Never use or reuse a child restraint:

- if the restraint has been involved in an accident or is damaged in any way
- if the expiration date or service life of the restraint has been exceeded
- if you don't know the full history of the restraint.

 **Important**

Loose child restraints

Never leave a loose child restraint in the passenger compartment. When not in use, keep it installed according to the manufacturer's instructions or store it securely in the trunk. A loose child restraint can cause damage in the event of a collision or sudden braking.

General safety recommendations

When applicable, follow the general safety recommendations regarding seat belt use, headrest adjustment and proper seating.

Local regulations

Regulations on where and how children should be seated and secured differ between regions. Make sure that you know what applies to the region you are in.

Child restraint registration and recalls

Child restraints could be recalled for safety reasons. You must register your child restraint to be reached in a recall. To stay informed about child safety seat recalls, be sure to fill out and return the registration card that comes with new child restraints.

Child restraint recall information is readily available in both the U.S. and Canada.

For recall information in the United States, call the U.S. government's Auto Safety Hotline at 1-800-424-9393 or visit <https://www-odi.nhtsa.dot.gov/owners/SearchSafetyIssues> [<https://www-odi.nhtsa.dot.gov/owners/SearchSafetyIssues>].

In Canada, visit Transport Canada's Child Safety website at <https://www.tc.gc.ca/en/services/road/child-vehicle-seat-safety.html> [<https://www.tc.gc.ca/en/services/road/child-car-seat-safety.html>].

Airbag information labels



This label is located on the front passenger seat sun visor.

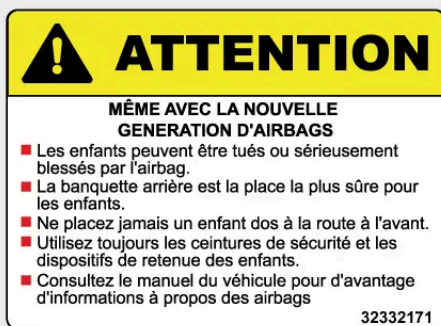

This label is located on the front passenger seat sun visor.



On new vehicles, this label is located in front of the dashboard on the front passenger side.

5.6.1.1. Installing child restraints

When installing and using a child restraint, there are several things to keep in mind, depending on the location of the child restraint in your vehicle.

 **Warning**

Follow the instructions

Take extra care to read all information about child safety in this manual and follow the instructions from the manufacturer of your child restraint. If you do not, the child could sustain serious injury in the event of an accident.

Child restraints and front passenger seat

Never use a child restraint in the front passenger seat. Volvo follows NHTSA's and Transport Canada's recommendations and recommends that all children up to and including 12 years of age sit in the rear seat. This is a particularly strong recommendation for children in rearward-facing child restraints.

 **Important**

Local regulations

Regulations on where and how children should be seated and secured differ between regions. Make sure that you know what applies to the region you are in.

Manufacturer's instructions

Always follow the instructions from the manufacturer of the child restraint.

5.6.1.1.1. Installing child restraints in the outer rear seat positions

To securely install a child restraint on either of the outer rear seats, there is important information to read and recommendations to follow.

ISOFIX^[1], top and lower tether attachment points can be used when installing a child restraint on the outer rear seats.

 **Tip**

Long-term use of a child restraint may cause wear and tear on the vehicle interior. Use a kick guard accessory to protect the vehicle interior.

Allowed child restraints

- Only use child restraints that are recommended by Volvo, universally approved or are vehicle-specific approved where the vehicle is included in the child restraint manufacturer's vehicle list.

Seat preparations

- Remove cushion extenders, leg supports and other accessories from the seat before installing a child restraint. If you use a kick guard accessory, this can remain on the seat.

- Child restraint support legs, if any, should always be mounted directly to the floor. Do not fit support legs to any raised or uneven floor surfaces, footrests or other objects.
- Loose objects should not be stored around any support legs of a child restraint.
- Any restraining straps for a child restraint should always be secured to designated attachment points. Do not secure restraining straps to seat rails, handles or other parts of the interior.
- When installing an adjustable, rearward-facing child restraint, adjust the child restraint according to the child's age. Older children should be seated in a more upright position than younger ones.

Seat belt use

- When installing a child restraint secured using the vehicle's seat belt, or when the vehicle's seat belt is used to secure a child, make sure that brackets or other parts of the restraint do not come into contact with the seat belt buckle release button.
- If you use the vehicle seat belt when installing a child restraint, you can set the seat belt to only retract. Read more about this in a separate section of the manual.

Warning

Follow the instructions

Take extra care to read all information about child safety in this manual and follow the instructions from the manufacturer of your child restraint. If you do not, the child could sustain serious injury in the event of an accident.

Important

Follow the general recommendations for any child restraint attachment points used to install a child restraint.

1. Follow the instructions from the manufacturer to install the child restraint.

Note

Installation questions

If you have installation questions, contact the manufacturer of the child restraint for more detailed instructions.

Protecting the vehicle interior

During installation, be careful to avoid damage to the vehicle interior caused by protruding parts or sharp edges on the child restraint.

- Fasten loose parts of child restraints, such as restraining straps, according to the manufacturer's instructions.

 **Important**

Raised headrest

The headrest must always be raised when a child restraint is installed.

General safety recommendations

When applicable, follow the general safety recommendations regarding seat belt use, headrest adjustment and proper seating.

Local regulations

Regulations on where and how children should be seated and secured differ between regions. Make sure that you know what applies to the region you are in.

[1] Also known as LATCH or LUAS

5.6.1.1.2. Installing child restraints in the center rear seat

To securely install a child restraint in the center rear seat, there is important information to read and recommendations to follow.

Top tether attachment points can be used when installing a child restraint on the center seat.

 **Tip**

Long-term use of a child restraint may cause wear and tear on the vehicle interior. Use a kick guard accessory to protect the vehicle interior.

Allowed child restraints

- Only use child restraints that are recommended by Volvo, universally approved or are vehicle-specific approved where the vehicle is included in the manufacturer's vehicle list.
- Child restraints that use support legs are not allowed on the center rear seat.

Seat preparations

- Remove cushion extenders, leg supports and other accessories from the seat before installing a child restraint. If you use a kick guard accessory, this can remain on the seat.
- When installing an adjustable, rearward-facing child restraint, adjust the child restraint according to the child's age. Older children should be seated in a more upright position than younger ones.
- When installing a forward-facing child restraint, make sure you adjust the headrest of the seat to the child's height. Even if the child restraint includes a head support, it might not have been built to withstand the forces involved in a collision.

Seat belt use

- When installing a child restraint secured using the vehicle's seat belt, or when the vehicle's seat belt is used to secure a child, make sure that brackets or other parts of the restraint do not come into contact with the seat belt buckle release button.
- If you use the vehicle seat belt when installing a child restraint, you can set the seat belt to only retract. Read more about this in a separate section of the manual.

Warning

Follow the instructions

Take extra care to read all information about child safety in this manual and follow the instructions from the manufacturer of your child restraint. If you do not, the child could sustain serious injury in the event of an accident.

Important

Follow the general recommendations for any child restraint attachment points used to install a child restraint.

1. Follow the instructions from the manufacturer to install the child restraint.

Note

Installation questions

If you have installation questions, contact the manufacturer of the child restraint for more detailed instructions.

Protecting the vehicle interior

During installation, be careful to avoid damage to the vehicle interior caused by protruding parts or sharp edges on the child restraint.

- Fasten loose parts of child restraints, such as restraining straps, according to the manufacturer's instructions.

Important

General safety recommendations

When applicable, follow the general safety recommendations regarding seat belt use, headrest adjustment and proper seating. Make sure you read these sections of the manual before installing a child restraint.

Local regulations

Regulations on where and how children should be seated and secured differ between regions. Make sure that you know what applies to the region you are in.

5.6.1.2. Child restraint attachment points

Your vehicle has different types of attachment points. Be sure to use the correct attachment points for your specific child restraint.



- ① Lower tether attachment points on the floor rails of the front seats
- ② ISOFIX^[1] attachment points between the backrests and seat cushions of the rear seats
- ③ Top tether attachment points on the backs of the second-row seats

Your vehicle's various attachment points can be used in combination with each other or together with other fastening methods to secure different types of child restraints.

ISOFIX, also known as LATCH or LUAS, is an international standard for child restraint attachment points that can be used in combination with the top tether attachment points or a support leg.

Some child restraints are secured using a vehicle seat belt, usually in combination with other fastening methods.

i Note

Manufacturer's instructions

When using attachment points, always follow the instructions from the manufacturer of the child restraint.

^[1] Also known as LATCH or LUAS

5.6.1.2.1. ISOFIX/LATCH attachment points

The content of this manual represents the status of the user manual at the time of printing and may not be completely valid in future instances. For more information refer to the first page for the complete disclaimer note.

Your vehicle is equipped with ISOFIX^[1] attachment points that can be used to secure child restraints on a rear seat.

The ISOFIX^[1] attachment points can be used in combination with other fastening methods to secure ISOFIX^[1] child restraints. These attachment points are part of an international standard for child restraints.

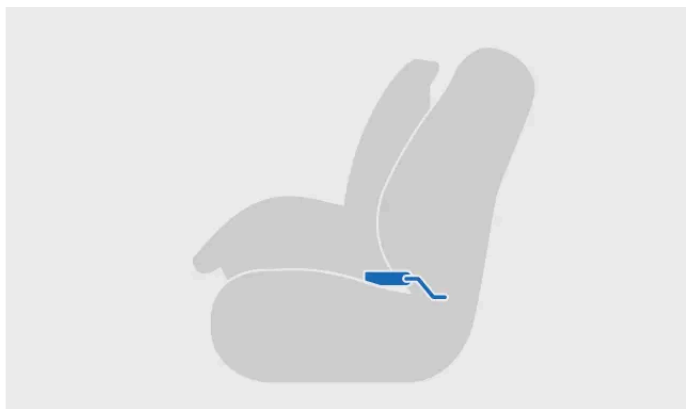

Child restraint installed using ISOFIX^[1]



Attaching to ISOFIX^[1] attachment point

Child restraints installed on either of the outer rear seats can use these attachment points.

Note

ISOFIX is an international standard for child restraint attachment points. It is also known by other regional names such as LATCH and LUAS.



Locations of ISOFIX^[1] anchor points for the outer rear seats

The ISOFIX^[1] attachment points for the rear seats are located behind covers in the lower part of the backrest on the outer rear seats. The covers need to be lifted to access the anchor points behind them.

The attachment locations are indicated by the ISOFIX^[1] symbol.



Note

Manufacturer's instructions

When using attachment points, always follow the instructions from the manufacturer of the child restraint.

^[1] Also known as LATCH or LUAS

5.6.1.2.2. Top tether attachment points

Your vehicle is equipped with top tether attachment points that can be used to secure child restraints in a rear seat.

The top tether attachment points can be used in combination with other fastening methods to secure different types of child restraints.

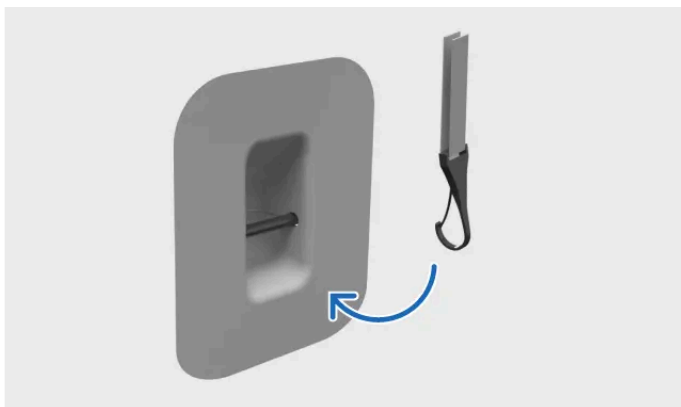

Fastening tether to top tether attachment point

Child restraints installed on any of the rear seats can use these attachment points.

Attachment point locations for the rear seats

The locations of the top tether attachment points are marked on the parcel shelf behind the rear seats.



The top tether attachment point locations for the outer rear seats are indicated by the top tether symbol.



 **Warning**

Headrest and top tether straps

The top tether straps of a child restraint installed on the outer rear seats should be routed through the hole in the vehicle seat headrest before they are secured to the attachment point. If this is not possible, follow the recommendations from the manufacturer of the child restraint.

 **Note**

Manufacturer's instructions

When using attachment points, always follow the instructions from the manufacturer of the child restraint.

5.6.1.2.3. Lower tether attachment points

The content of this manual represents the status of the user manual at the time of printing and may not be completely valid in future instances. For more information refer to the first page for the complete disclaimer note.

Your vehicle is equipped with lower tether attachment points that can be used to secure child restraints on a rear seat.

The lower tether attachment points are mainly used together with the vehicle seat belt to secure certain rearward-facing child restraints.

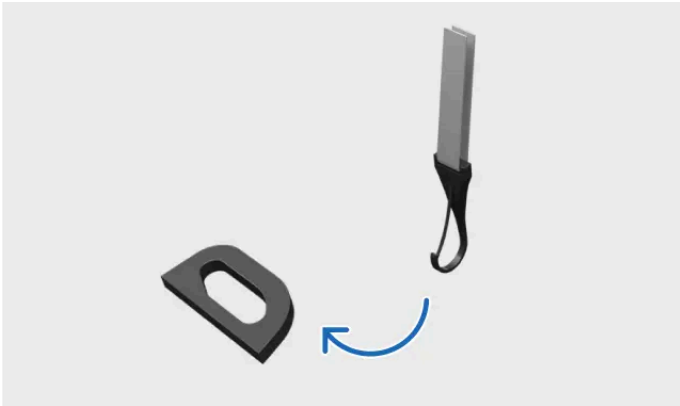

Fastening tether to lower tether attachment point

Child restraints installed on any outer rear seat can use these anchor points.



The lower tether attachment points can be found at the back of the floor rails of the front seats.

i Note

Manufacturer's instructions

When using attachment points, always follow the instructions from the manufacturer of the child restraint.

6. Entry and security

Learn about the various features associated with entering and exiting the vehicle, including how the keys and alarm work.



This section of the manual covers opening and closing the doors, locking and unlocking, and the alarm.

Learn more about how the different types of keys work and how you can customize the way your vehicle reacts when you lock and unlock it.

6.1. Keys

Your vehicle supports three types of keys. The keys are recognized automatically when you bring them with you inside the vehicle.



Your vehicle supports the following types of keys:

The content of this manual represents the status of the user manual at the time of printing and may not be completely valid in future instances. For more information refer to the first page for the complete disclaimer note.

- Standard key
- Care Key
- Key tag

The vehicle detects when there's a key in the passenger compartment and gives you driving access.

 **Important**

Using keys is fairly straightforward, but you should be aware of the limitations of each key type for safety and security reasons. Therefore, it is important to read the whole section about keys and how to use them.

Wireless key and vehicle technologies may cause disturbances in other devices. You can find more information about these systems in the specifications section of this manual.

For safety and security reasons, never leave unattended keys in an exposed place.

Standard key and Care Key

The standard key has four buttons:

- Lock button
- Unlock button
- Trunk hatch button
- Panic button

If you prefer, you can use keyless locking. This means you lock or unlock the vehicle using the door handles instead of using the key buttons.

The standard key also has a detachable key blade inside it. This lets you open the driver door even if the key's buttons aren't working or if its battery has gone dead.

The Care Key works just like a standard key, but it lets you set a speed limitation for the vehicle while the key is being used.

Key tag

The key tag is buttonless and lets you automatically lock and unlock the vehicle by touching the door handles when you are within the key detection range.

Key detection range

Your vehicle can detect your key from a short distance away, which allows you to use the keyless lock and unlocking function. This means that you can lock and unlock the vehicle by touching the door handle, without having to use the standard key's buttons or key blade.

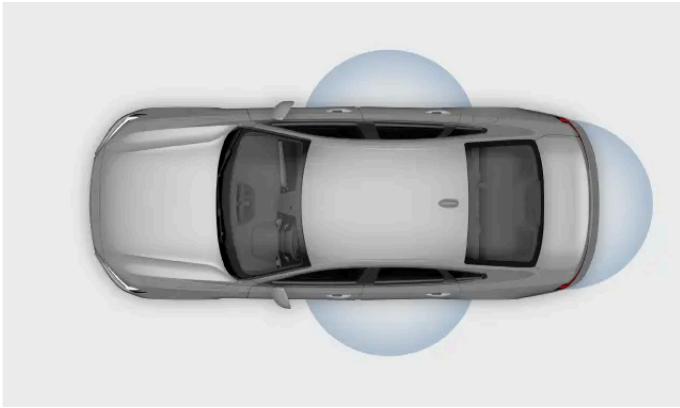

The standard key's buttons have a long range of detection. If your vehicle doesn't respond to a button being pressed, try moving closer.

Note

The key functions can be disrupted by external factors such as surrounding radio waves, buildings and topographical conditions. If this happens, you can still lock and unlock the vehicle using the standard key's detachable key blade.

Important

Avoid storing vehicle keys close to metal objects or electronics such as mobile phones, tablets, laptops or chargers.

User profiles and keys

You can assign keys to specific user profiles. This allows the vehicle to automatically identify who's unlocking it and apply their customizations. Read about profiles for more information.

Locking keys in

If you lock the vehicle while a key is still inside, that key is temporarily deactivated. It will be activated again when you unlock the vehicle with another valid key.

Note

Additional keys

Your vehicle comes with a limited number of keys. Contact a Volvo retailer or authorized Volvo workshop if you lose a key or simply require additional keys.

 **Warning**

The keys include a battery. Keep new and used batteries out of reach of children and pets. If batteries are ingested, they can cause serious health issues. If a battery or the key itself is damaged, the item should not be used. Keep defective key fobs out of reach of children and pets.

If you leave a person in the vehicle, make sure that you do not leave a key in the vehicle. This is especially important in the case of children.

Improper use of vehicle opening and starting systems can result in serious personal injury. Always take your keys with you when you leave the vehicle. The vehicle can be started, and systems such as the power windows can be operated, leading to serious personal injury. Never leave children, disabled persons or anyone who cannot help themselves in the vehicle. The doors can be locked, which could result in people being trapped in the vehicle in an emergency. For example, depending on the time of year, people trapped in the vehicle can be exposed to very high or low temperatures. Never remove the key while the vehicle is moving or while it is rolling to a stop.

6.1.1. Standard key

The standard key lets you lock and unlock the vehicle either from a distance or using the detachable key blade.



The standard key has four buttons:



Lock button



Unlock button



Trunk hatch button



Panic function

It also has a detachable key blade. This lets you open the driver door even if the standard key's buttons aren't working or if its battery is discharged.

Lock button

The content of this manual represents the status of the user manual at the time of printing and may not be completely valid in future instances. For more information refer to the first page for the complete disclaimer note.

The locking button can be used in the following ways:

- Press once to lock the vehicle and arm the alarm.
- Press and hold to close all of the windows as well as the panoramic roof.

Unlock button

The unlocking button can be used in the following ways:

- Press once to unlock the vehicle and disarm the alarm.
- Press and hold to open all of the windows.

Trunk hatch button

Press the button once to disarm the alarm and unlock the trunk hatch.

Panic function

Use the panic function button to attract attention in case of an emergency. When you press and hold the button, or press it twice in quick succession, the vehicle will activate the turn signals and the horn.

You can turn the panic function off manually by pressing the unlock button, or the vehicle will turn them off automatically after a few minutes.

Detachable key blade

Your standard key has a detachable key blade that can be used as a backup if the buttons aren't working. For example, the key's signals can be disrupted by electromagnetic fields. If this happens, or if your key runs out of battery, you can still unlock and lock the vehicle by using the detachable key blade.

6.1.1.1. Detachable key blade

You can use the detachable key blade as a backup if your key runs out of battery.

There's a detachable key blade inside the standard key.

If your standard key or key tag isn't working, you can use this key blade to:

- open the left-hand front door
- lock a door.

If you use the detachable key blade to unlock the vehicle, you can deactivate the alarm and start the vehicle by placing your key on the backup key reader.

The backup reader is located in the center console's cup holder.

6.1.2. Care Key

A Care Key can be used the same way as a standard key; the only difference is that you can have a specific speed limitation tied to it.

The Care Key works just like a standard key when it comes to locking and unlocking, starting your vehicle and most of the other standard actions. The big difference is that you can set a speed limitation for the vehicle when the Care Key is being used. This can be useful when you need to lend your vehicle to an inexperienced driver or give it to a valet or workshop.

When a Care Key with a connected speed limitation is being used, this will be indicated with a symbol in the instrument panel.



Care Key speed limitation symbol

The Care Key can also be used without connecting it to a speed limitation. In that case, it works just like a standard key.

Changing the speed limitation setting

The vehicle automatically detects when you unlock it using a Care Key and applies the speed limitation if you have set one.

When you've unlocked the vehicle using a Care Key, you can't change or remove the speed limitation. To access the speed limitation setting again, relock the vehicle and unlock it using a standard key or key tag and select the owner profile.

6.1.2.1. Setting a speed limitation for the Care Key

You can set a maximum permitted speed for a Care Key or turn the speed limitation off to use it like a standard key.

Make sure you unlock the vehicle using a standard key or key tag to be able to access the speed limitation settings.

1. Press the vehicle symbol  in the bottom bar and go to **Settings**.
 2. Go to **Profiles** → **Care key**.
 3. Turn the speed limitation on and select the desired maximum speed.
- > A speed limitation symbol appears in the instrument panel. A dotted line on the speedometer shows the current speed limitation.

6.1.3. Key tag

You can use your key tag to lock, unlock and drive the vehicle without using any buttons on the key.

The key tag lets you use the keyless locking and unlocking feature. It's smaller and lighter than the standard key, which makes it particularly useful when you have limited space for carrying items.

If you leave the key tag in the vehicle and lock the vehicle with your standard key, the tag will be disabled until the vehicle is unlocked again.

Key tag battery

The battery in the key tag isn't rechargeable and can't be replaced.

Note

A discharged key tag could still be used to start the vehicle via back-up start. For this reason, return any discharged key tag to an authorized Volvo workshop so that it can be deleted from the vehicle's system.

Warning

The key tag includes a non-replaceable battery that can be extremely hazardous. Keep batteries out of reach of children. If you suspect a battery has been ingested or in any way inserted into the body, seek immediate medical attention. Battery fluid is also hazardous, and physical contact with it should be avoided.

6.1.4. Replacing the standard key battery

You can replace the battery in your standard key when it gets discharged.

Your vehicle will let you know when the battery in your standard key is running low via a message in the instrument panel. Another sign that the battery level is low is if you notice a decreased range when locking or unlocking the vehicle.

You can replace the battery yourself. The key requires a flat 3 V CR2032 cell battery.

Important

- For safety reasons and to ensure optimal battery performance, use hand protection such as a medical glove when handling a new battery.
- Used batteries must be recycled in an environmentally sound manner.

Hold the key with the Volvo logo facing upward.

Detaching the front shell

1. Slide the small catch on the key ring bracket to the side, then slide the front shell away from the bracket.



> The front shell detaches.

2. Lift the front shell off and locate the other small catch underneath it.

Detaching the rear shell

3. Use the small catch to slide the rear shell away from the bracket.



> The rear shell detaches.

4. Lift the rear shell off to find the battery cover.

Removing the battery cover

- 5.



Using a suitable tool, such as a screwdriver or a coin, turn the battery cover counter-clockwise to release it.

Replacing the battery

6. Loosen the battery by pressing on its edge, then lift it out.

7. Place the new battery in the slot, making sure the positive side of the battery is facing upward. Position the edge of the battery under the two outer plastic catches, then press down on the battery so that it is held in place by the upper plastic catch.
8. Reassembly the battery cover, rear shell and front shell on the key.

 **Warning**

Check that the battery is installed correctly, with the correct polarity. If the key will not be used for a long time, remove the battery to avoid battery leakage and damage. Damaged or leaky batteries can cause corrosive injury on contact with the skin. Therefore, use protective gloves when handling old or damaged batteries.

- Keep batteries out of the reach of children.
- Do not leave batteries lying around, as they can be swallowed by children or pets.
- Batteries must not be dismantled, short-circuited or thrown into an open flame.
- Do not try to charge non-rechargeable batteries. They may explode.
- Check battery-operated products for signs of damage on a regular basis. The key should not be used if anything indicates that it or its battery has been damaged or has started to leak.
- Keep defective products out of the reach of children.

6.2. Opening and closing

Your vehicle has a few features and situation-specific behaviors you should be aware of when opening and closing the doors.

Opening the doors

You open the doors manually, but you can set how the doors open and under what conditions via the center display.

The rear doors are equipped with a double-pull feature to prevent passengers from accidentally opening them. To open the rear doors from the inside, you need to pull the door handle twice.

Opening the hood

The hood is opened using a lever near the driver's seat.

Opening the trunk

You open the trunk manually using the button on the trunk hatch.

Your vehicle also has a hands-free feature that lets you access the trunk by making a motion with your foot.

Open door warning

Regularly check that the hood, trunk hatch and doors are fully closed.

Open doors and hatches are highlighted in the instrument panel. If you see an open door warning, stop the vehicle in a safe place as soon as possible and make sure the door or hatch in question is properly closed.

6.2.1. Opening the hood

To open the hood, you need to pull two separate release levers. Be sure to close the hood again before driving the vehicle.

Locations of release levers



The first lever is below the dashboard on the driver's side, just in front of the door hinge.



The second lever is below the front edge of the hood, on the driver's side.

Releasing the hood

1. Find the first lever below the dashboard on the driver's side and pull it back.

- > The hood releases from its fully locked position. It opens slightly, which gives you access to the second lever.

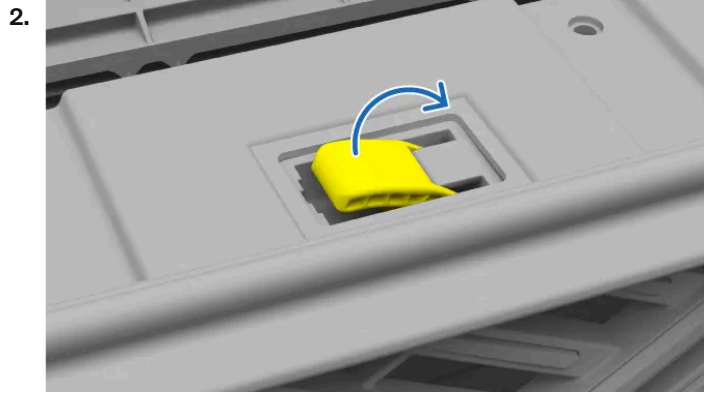

Locate the second lever below the front edge of the hood and pull it to the right.

- > The hood releases fully.
3. Lift the hood and open it to its fully extended height.
- > The hood will stay in position.

 **Warning**

Do not drive with the hood open

Stop the vehicle immediately if there is any indication that the hood is not completely closed.

 **Note**

Open hood warning

If you see an open hood warning in the instrument panel, open the hood and check for obstructions before closing it again. Contact Volvo support if the notification doesn't go away.

6.2.2. Closing the hood

Take extra care to ensure that you close the hood completely after opening it.

Make sure nothing gets in the way of the hood as it closes.

 **Warning**

Pinching and crushing hazard

Keep all hands away from the hood's closing path. Be extra cautious when children or pets are nearby.

1. From the fully-opened position, carefully lower the hood until it reaches the locking mechanism.
2. Press down with both hands on the sides of the hood lid's front edge.



Where to press the hood down to close it

***i* Note**

Make sure the hood fits into the latches at the same time. Keep the front edge flat as it closes.

You should hear the hood lock on both sides.

3. Make sure there are no significant gaps or any indication that the hood is not completely closed.

 Warning

Do not drive with the hood open

Stop the vehicle immediately if there is any indication that the hood is not completely closed.

***i* Note**

Open hood warning

If you see an open hood warning in the instrument panel, open the hood and check for obstructions before closing it again. Contact Volvo support if the notification doesn't go away.

6.2.3. Trunk access

You can access the trunk using the handle at the bottom of the trunk hatch.

 **Warning**

Be aware when the trunk is opening or closing. Make sure that no people are in the vicinity of the trunk when it is in motion. Always use the trunk access functions with caution.

Do not interfere with the trunk support arms; they are highly pressurized, and tampering with them can result in serious injury.

After use, make sure that the trunk is fully closed.

Never leave children alone in the vehicle. Children may be exposed to potentially harmful temperatures on hot or cold days, or may lock themselves in.

Do not allow children to play in the vehicle or play with any of the vehicle's controls. This reduces the risk of injury to the child or inadvertent activation or deactivation of the vehicle's features.

Never drive with the trunk hatch open.

Manual access

If you're carrying a key with you, you can unlock the trunk by gently pressing the rubberized button underneath the handle at the bottom of the trunk hatch. Once unlocked, you can open the trunk using the same handle.

 **Note**

Opening the trunk from the inside

There is a fluorescent handle on the inside of the trunk, near the lower edge of the trunk hatch, that lets you open it from the inside. Pull the handle downward to release the trunk hatch.

 **Important**

Handle the rubberized button with care to avoid damaging its electrical contact.

When opening trunk, use the handle to lift the trunk hatch rather than the rubberized button.

Using the standard key button

The standard key has a trunk hatch button that lets you lock and unlock the trunk from a distance.

Hands-free opening

The hands-free feature lets you open the trunk using a foot motion. You can learn more about this feature in a separate section of this manual.

Dashboard button

You can unlock the trunk from inside the vehicle using a button on the dashboard, next to the steering wheel.

Pinch protection

The vehicle can detect obstructions to the trunk hatch when opening or closing. When pinch protection activates, you will hear a warning sound.

If the trunk hatch tries to close with an obstruction in the way, the trunk will open fully. If pinch protection activates while the trunk hatch is opening, the hatch will stop moving.

Note

If you don't open the trunk hatch within a couple of minutes of unlocking it, it locks and arms the alarm automatically.

6.2.3.1. Opening the trunk hands-free

If your hands are full and you have your key with you, just pass your foot under the rear bumper once to open the trunk.

Make sure you have your key with you.

Opening the trunk

1. Make a single kicking motion under the rear bumper and move back.
- > A short sound response indicates that the trunk is about to open.

Closing the trunk

Close the trunk by pressing the hatch down manually.

If the function appears to be unresponsive, keep in mind that obstructions to the sensor such as mud can interfere with a proper response.

6.3. Locking and unlocking

The vehicle can be locked and unlocked in several different ways.

You can lock and unlock the vehicle in the following ways:

- with the buttons on the standard key or Care Key
- using the detachable key blade on the standard key
- using the keyless function ^[1]
- from the inside of the vehicle with the door handles and lock buttons

- with the Volvo Cars app.

 **Note**

Automatic locking while driving

The doors and trunk hatch lock automatically when you start driving, but the doors can still be opened from the inside. You can select which doors can be unlocked in settings.

You can also turn the automatic lock while driving setting on or off.

If you want to prevent the rear doors from being opened from the inside, activate the child lock.

When you use keyless locking, all of the doors need to be closed before the vehicle can lock.

If you lock the vehicle using your standard key, only the driver's door needs to be closed. Once you close the rest of the doors and hatches, your vehicle will indicate that it's locked.

Lock indications

Your vehicle has a number of ways it can indicate whether the doors are locked. These include:

- The hazard lights flashing twice when the vehicle locks. You can turn more locking feedback responses on or off in settings.
- Any locked doors being indicated with a small light next to the lock buttons in the door panels. The light turns off if that door is opened.
- The front door indication lights illuminate if all of the doors are locked. The lights turn off if any of the doors are opened.

 **Warning**

Volvo recommends that you do not leave people or pets in a locked vehicle. The driver is always fully responsible for the well-being and safety of anyone left inside. Some regions have laws prohibiting people or pets being left inside a locked vehicle.

^[1] The vehicle detects that a key is within range and lets you lock and unlock by touching the door handles or trunk hatch handle.

6.3.1. Keyless locking and unlocking

The vehicle's keyless locking and unlocking system allows you to lock and unlock the vehicle by interacting with touch-sensitive areas on the door handles.

To use the keyless function, you just need to carry your key with you. As long as the key is within your vehicle's detection range and it has a sufficient battery level, you can lock and unlock the vehicle by interacting with the different touch-sensitive areas on the door handles.

! Important

Keyless locking and unlocking can be triggered when you wash your vehicle if a key is in range.

Keyless locking

When carrying your key, you can lock the vehicle by touching the small indentation on the outer part of the door handle.



It's also possible to lock the doors while the trunk hatch is still open. Once you've locked the rest of the vehicle using the door handle, the trunk hatch will lock too once it's closed.

i Tip

Closing the windows with keyless locking

You can close all of the side windows and the panoramic roof at the same time by holding a finger against the indentation on the outside of the door handle.

Keyless unlocking

With keyless unlocking, your vehicle unlocks automatically when you pull the door handle while carrying your key.

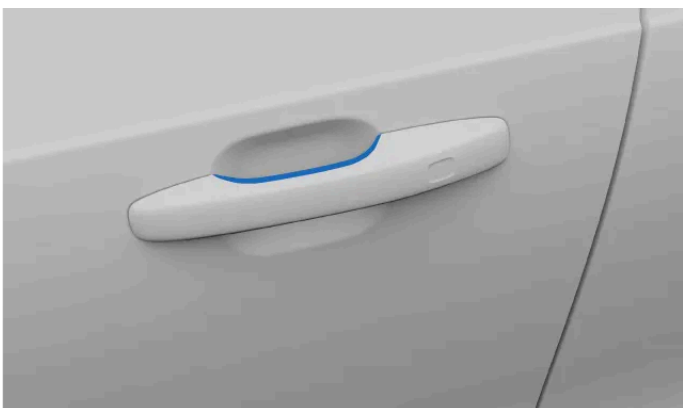

Door handle touchpoint

There is also a rubberized button under the trunk hatch handle that you can press to unlock the vehicle.

 **Note**

Make sure to only touch one of the touch-sensitive areas on the door handle at a time, either the one for locking or the one for unlocking. If you grip the handle while touching the lock surface, the keyless function might not work properly.

6.3.2. Locking and unlocking using the key buttons

You can use the buttons on the standard key and Care Key to lock or unlock the vehicle, including the fuel filler flap.

 **Tip**

Pressing the key buttons once controls the locking and unlocking behaviors. Pressing and holding the different buttons controls different features related to opening and closing, such as opening the trunk and automatic window closing. You can learn more about these features in the relevant section of the manual.

Locking the vehicle



Close the driver's door and press the lock button.

- > The vehicle locks. Any open doors or hatches will be locked once you close them.
The alarm is armed.

 **Note**

If you lock the vehicle while a key is still inside, that key is temporarily deactivated. It will be activated again when you unlock the vehicle with another valid key.

If you press the lock button with the trunk hatch still open, make sure you don't leave the key inside the vehicle when you close the hatch. If the vehicle detects that the key is still inside, the trunk will not lock.

Unlocking the vehicle



Press the unlock button once.

- > The vehicle unlocks.
- > The alarm is disarmed.

i Note

Automatic relocking

If you don't open any of the doors or the trunk hatch for a couple of minutes after unlocking, the vehicle relocks automatically so that you don't accidentally leave it unlocked.

Unlocking the trunk hatch



Press once on the trunk hatch button.

- > The trunk unlocks.
The alarm remains armed on the side doors.

If the key isn't working

If the vehicle doesn't respond to the key's buttons, try changing the key battery. As a backup, you can use the detachable key blade to lock or unlock the vehicle.

6.3.3. Locking and unlocking using the detachable key blade

There's a detachable key blade inside the standard key that you can use as a backup for locking and unlocking.

i Note

When you unlock and open the vehicle using the detachable key blade, the alarm will be triggered.

Finding the key blade

1. Hold the key with the Volvo logo facing upward.

Slide the small catch on the key ring bracket to the side and slide the front shell away from the bracket.



> The front shell detaches.

2. Lift the front shell off and locate the key blade underneath it.

Unlocking with the key blade

3. Go to the front door on the left-hand side of the vehicle. Pull out the door handle to its final position.

4. Turn the key clockwise 45 degrees clockwise so that it is pointing straight back.

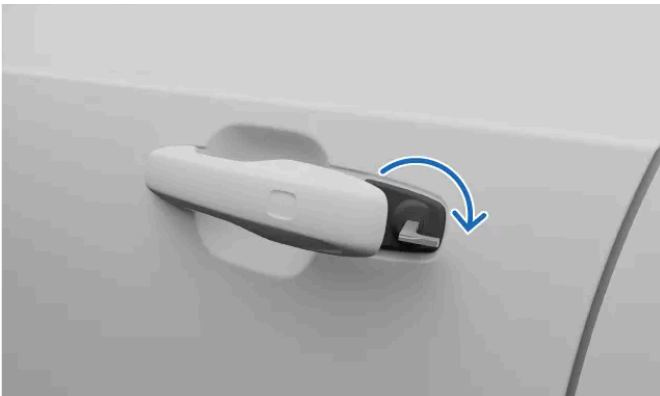

5. Turn the key back 45 degrees counter-clockwise back to its starting position and remove it.

> The door can be opened.
The alarm triggers.

Deactivating the alarm

6. Place the key on top of the key symbol in the backup reader.



i Note

When using the backup reader, make sure that the area is free of other vehicle keys, metal objects and electronics such as mobile phones, tablets, laptops or chargers. Such objects could disrupt the reader.

7. Turn the start knob clockwise and release it.

> The alarm deactivates.

Locking with the key blade

8.

i Note

You can lock the front door on the left-hand side the same way that you unlocked it.

Each of the other doors has a lock reset in their side that needs to be pressed in using the key blade.

Insert the key blade into the keyhole to reset the lock. Make sure it's fully inserted.

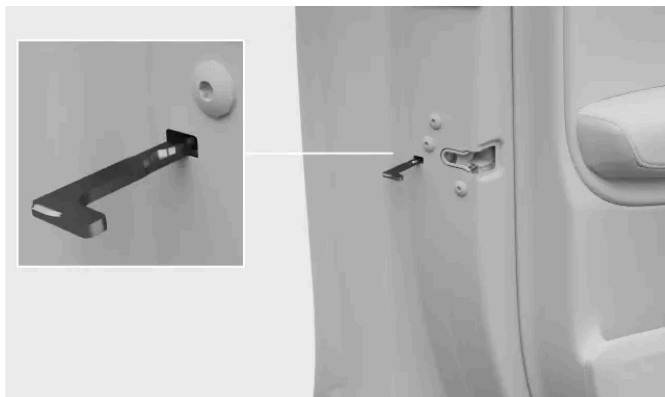

Location of the key reset

! Important

- A door lock reset only locks that particular door, not all doors.
- If the child lock is active when you lock a rear door with the key blade, that door can't be opened from the outside or the inside. To unlock it, you need to use the buttons on the key, the central locking button, the keyless locking system, or the Volvo Cars app.

6.3.4. Locking and unlocking from inside the vehicle

You have several options for locking or unlocking the vehicle from the passenger compartment.

The central lock can be controlled from the front seats using the buttons on each respective door.



There are also buttons on each of the rear doors, which only control that specific door.

Locking all locks

- Press the lock symbol  on the central lock button.
- > All of the doors, the trunk hatch and the fuel filler flap are locked.

Unlocking all locks

- Press the unlock symbol  on the central lock button.
- > Depending on your settings, only the selected door or all doors will unlock, as well as the trunk hatch and fuel filler flap.

Unlocking with the front door handles

- Pull on the front door handle.
- > Depending on your settings, only the selected door or all doors will unlock, as well as the trunk hatch and fuel filler flap.

Unlocking a rear door with the door handle



-  **Note**

The child lock needs to be deactivated to unlock the rear doors.

Pull the rear door handle twice.

- > The door unlocks and opens.

Locking using the button in the rear door

- Press the lock symbol  on the rear door.
- > The door is locked, and the small indicator light next to the lock symbol  lights up.

6.3.5. Activating child lock

You can activate and deactivate the child lock with a button in the driver's door.

Important

When driving with children in the rear seats, check that the rear doors are secured with an active child lock.

The child lock can increase passenger safety in the rear seats. When the child lock is active, passengers in the rear seats are unable to open the rear doors or operate the rear windows.

The driver maintains control over the windows, and the vehicle can be opened from the outside if it is unlocked.

Activating child lock

1.



Location of the child lock button in the door panel

With the ignition turned on, press the child lock button in the door panel.

- > The child lock is activated.
- > The indication light on the child lock button illuminates, and a message is shown in the instrument panel to confirm that the lock is on.

You can deactivate the child lock by following the same steps you took to activate it.

If the child lock is active when you turn the vehicle off, it will remain active the next time the vehicle is started.

6.3.6. Settings for locking and unlocking

You can customize how your vehicle reacts when locking or unlocking.

 **Note**

Different settings affect how and when your vehicle is locked. Make sure to familiarize yourself with the different options and how they affect the locking and unlocking behaviors.

You can customize many of your vehicle's general locking behaviors. For example, you can turn feedback responses on or off. You can also choose whether only one or all of the doors should unlock when you use the touch points on the door handles.

 **Tip**

Closing the sun blind automatically

You can turn on **Auto-close sunroof curtain** in settings to make the sun blind close automatically after 15 minutes if the vehicle is parked and locked in warm weather. This helps ensure a comfortable passenger compartment temperature and protects the vehicle's upholstery from fading in the sun.

6.3.6.1. Adjusting locking and unlocking settings

You can adjust several of your vehicle's locking and unlocking responses and behaviors in settings.

 **Important**

Changing locking and unlocking settings

Enabling or disabling certain features affects how and when your vehicle locks and unlocks. Make sure you familiarize yourself with the different key types, as well as the locking and unlocking features. Misunderstanding a feature might lead you to believe that your vehicle is locked when it isn't.

1. Press the vehicle symbol  in the bottom bar and go to **Settings**.
2. Go to **Controls** → **Locking**.
3. Adjust your locking and unlocking settings.

 **Warning**

Volvo recommends that you do not leave people or pets in a locked vehicle.

Some regions have laws prohibiting people or pets being left inside a locked vehicle.

6.4. Anti-theft

Your vehicle has systems and features that help keep your vehicle secure when it's locked.

When the vehicle is locked, some functions and systems are either shut down or activated to help protect the vehicle from theft.



Warning

Do not leave your keys unattended in your vehicle. They can be used to disable the security systems.

Alarm

The alarm is automatically armed when you lock the vehicle from the outside. It's also disarmed automatically when you unlock the vehicle using the standard key buttons or the key tag.

If you unlock the door using the detachable key blade, you need to deactivate the alarm manually.

Immobilizer

The immobilizer is an anti-theft system that prevents your vehicle from being driven until it's started using a valid key. If your vehicle can't find the key or fails to authenticate it, it will remain immobilized. If the key can't be found or has a low battery, a notification appears in the center display.

6.4.1. Alarm

The alarm helps deter unwanted interference with your vehicle when it's parked.

The alarm is automatically enabled when you lock the vehicle and disabled when you unlock the vehicle with the standard key or key tag.

If you unlock the vehicle using the detachable key blade, the alarm will sound until you put the key on the backup key reader in the center console's cup holder.

Alarm indicator



The alarm indicator is a light located in the center of the dashboard, just in front of the windshield. The indicator confirms when the alarm is enabled with a flashing red light.

Triggering the alarm

When armed, the alarm will trigger if:

- a door, the hood or the trunk is opened.
- the battery or siren is disconnected.

Once the alarm is triggered, the following happens:

- The alarm sound starts.
- The alarm indicator and the warning lights will flash for up to 5 minutes.
- The alarm cycle restarts several times over if whatever triggered the alarm isn't resolved.

Stopping the alarm

Unlocking the vehicle while the alarm is triggered will stop any alarm sounds and lights. The alarm indicator will continue to flash rapidly for some time to highlight that there was a recent potential security issue.

Important

Do not make any changes or additions to the alarm system, or it may not work properly.

6.4.1.1. Activating and deactivating the alarm

In most cases, you can use your key to turn the alarm on or off. If this isn't working, you can turn the alarm off manually.

Unlocking the vehicle to disarm it usually works. However, in certain situations, you need to disable it manually.

Note

Switching off a triggered alarm

If the alarm has been triggered, you can turn it off using the unlock button on your standard key or Care Key. If your key's buttons don't work, you have to disable the alarm manually.

Disabling the alarm manually

1. Place the key on top of the key symbol in the backup reader.



Location of the backup reader inside the center console cup holder

i Note

When using the backup reader, make sure that the area is free of other vehicle keys, metal objects and electronics such as mobile phones, tablets, laptops or chargers. Such objects could disrupt the reader.

2. Turn the start knob clockwise and release it.

> The alarm deactivates.

7. Refueling

Learn about fuel and how you refuel your vehicle.



In this section, you can find out more about fuel, different octane ratings and how you refuel your vehicle.

7.1. Refueling your vehicle

It is important to use the correct fuel for your vehicle and to avoid spilling it.

Important

Only use gasoline from well-known manufacturers. Never refuel your vehicle if you aren't sure about the quality.

Always use the correct gasoline. Even small amounts of the wrong type of fuel could damage the fuel system and engine.

Avoid spilling gasoline during refueling. In addition to causing damage to the environment, gasolines containing alcohol can cause damage to painted surfaces, which may not be covered under the New Vehicle Limited Warranty.

1. Turn off the vehicle and open the fuel filler flap with a gentle press on the rear of the flap ^[1].
2. Insert the pump nozzle into the fuel filler opening. The filler pipe has two opening caps. The pump nozzle must be pushed past both caps before refueling starts.



Tip

Refueling from a gas can

If you are refueling from a gas can, be sure to use the funnel located in the foam block in the trunk's cargo hold.

3. Refuel your vehicle. Only fill the tank until the pump nozzle cuts out the first time.



Note

Do not overfill the tank. An overfilled tank can overflow, especially in high temperatures and hot weather.

4. When you are done refueling your vehicle, gently press the flap to close it.

^[1] Your vehicle must be unlocked before the fuel filler flap can be opened.

7.2. Fuel/Gasoline information

It's important to use the correct fuel when refueling your vehicle. Gasoline is sold with different octane ratings that are adapted for different types of driving.



Warning

Never swallow fuel. Fuels such as gasoline, bioethanol, and mixtures of these are very toxic and can cause permanent injury or even death if they are swallowed. Seek medical attention immediately if you have swallowed fuel.

Always take precautions to avoid inhaling gasoline fumes or getting gasoline splashed in your eyes.

If you get gasoline in your eyes, remove contact lenses if applicable, rinse your eyes thoroughly with water for at least 15 minutes and seek medical attention.

Carbon monoxide is a toxic, colorless and odorless gas. It is present in all exhaust gases. If you ever notice the smell of exhaust inside the vehicle, make sure the passenger compartment is ventilated and contact an authorized Volvo workshop for any required repairs or servicing.

Avoid any fires, such as from cigarette lighters and lit cigarettes.

When refueling your vehicle, always follow your local restrictions.

 **Important**

Refueling your vehicle

Only use gasoline from well-known manufacturers. Never refuel your vehicle if you aren't sure about the fuel's quality.

Always use the correct gasoline. Look at the label on the inside of the fuel filler flap. Even small amounts of the wrong type of fuel could damage the fuel system and engine.

Always follow the warning signs posted at the gas station.

Close all doors and windows before you start refueling.

Additives and quality

To avoid damage to the engine, only use unleaded gasoline.

U.S. and Canadian regulations require pumps delivering unleaded gasoline to be labeled UNLEADED. Repeated use of gasoline with lead additives reduces the efficiency of the emissions control systems and may result in the invalidation of the emissions warranty.

Do not use fuel containing methanol.

Except for the use of antifreeze for fuel lines during the winter, do not use solvents, thickeners or other additives in the vehicle's fuel, cooling or lubrication systems. Overuse may damage your engine, and some of these additives contain volatile organic compounds. Do not needlessly expose yourself to these chemicals.

Some suppliers use gasoline with additives. If you are unsure whether the gasoline contains deposit-controlling additives, ask at the fueling station.

Emission controls

 **Important**

Three-way catalytic converter

- Keep your engine properly tuned. Certain engine malfunctions, particularly involving the electrical, fuel or distributor ignition systems, may cause unusually high three-way catalytic converter temperatures. Do not continue to operate your vehicle if you notice engine misfire, noticeable loss of power or other unusual operating conditions, such as engine overheating or backfiring. A properly tuned engine will help avoid malfunctions that could damage the three-way catalytic converter.
- Do not park your vehicle on top of combustible materials, such as grass or leaves. These materials can come into contact with the hot exhaust system and cause such materials to ignite under certain wind and weather conditions.
- Excessive starter cranking, for more than one minute, or an intermittently firing or flooded engine, can cause three-way catalytic converter or exhaust system overheating.
- Remember that tampering or unauthorized modifications to the engine, the Engine Control Module, or the vehicle may be illegal and could cause three-way catalytic converter or exhaust system overheating. This includes altering fuel injection settings or components, removing or altering emission system components and their location, and repeated use of leaded fuel.

Note

Unleaded fuel

Unleaded fuel is required for vehicles with three-way catalytic converters.

Heated oxygen sensors

Heated oxygen sensors measure the oxygen content of the exhaust gases. The readings help your vehicle monitor engine functions and control fuel injection. To help reduce harmful emissions, the ratio of fuel to air injected into the engine is continuously adjusted for efficient combustion.

The heated oxygen sensors monitor the oxygen content of the exhaust gases. Readings are fed into a control module that continuously monitors engine functions and controls fuel injection. The ratio of fuel to air into the engine is continuously adjusted for efficient combustion to help reduce harmful emissions.

Octane rating

Gasoline has different octane ratings that are suitable for different types of driving.

Volvo requires premium fuel, with an octane rating of 91 or higher according to AKI^[1] for all B4, B5, B6 and T8 engines, and it recommends AKI 93 for ideal performance and fuel economy. In demanding driving conditions, such as warm climates, driving with a trailer or driving for long periods at a higher altitude than normal, it's recommended to change to fuel with a higher octane rating.

If you change to fuel with a higher octane rating or another brand of gasoline, you may have to fill the tank more than once before you notice any difference in engine function.



The octane label is located on the fuel pump.

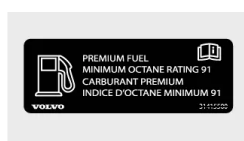

Premium fuel label is located on the inside of the fuel filler flap on vehicles that require premium fuel.

Note

TOP TIER Detergent Gasoline

Volvo recommends the use of TOP TIER detergent gasoline where available, to maintain engine performance and reliability. Information on TOP TIER detergent gasoline is available at [toptiergas.com](https://www.toptiergas.com/) [<https://www.toptiergas.com/>].

^[1] Anti Knock Index. AKI is an average value of RON (Research Octane Number) and MON (Motor Octane Number) - (RON)+(MON)/2

8. Driving

Your vehicle is designed for driving. This section covers the essential driver controls that allow you to start, stop, steer and change gears. You can also find information about driving characteristics and handling here.



Many of your vehicle's driving features can be customized for a personalized experience. While some features are more directed towards comfort, others are strictly safety related. It's important to check your driving position, maintain good visibility and to always stay attentive and focused while driving.

8.1. Trips app

The Trips app is a driving journal that automatically logs all trips made with your vehicle.

When this app is enabled, it automatically collects your vehicle's identification number^[1], location and other trip-related data, such as time, distance and battery consumption.

Note

The Trips app calculates battery consumption based on pure consumption during a trip. If your vehicle's trip meter shows a different value, it's because the trip meter also takes energy regeneration into account.

In the Volvo Cars app, you can:

- View, manage and delete all of your trips.
- Export your driving journal.
- Stay informed if a trip isn't uploaded due to an issue, such as network problems.

The content of this manual represents the status of the user manual at the time of printing and may not be completely valid in future instances. For more information refer to the first page for the complete disclaimer note.

When the Trips app is enabled, all users that have paired the Volvo Cars app with the vehicle can see the trips. If the Trips app is disabled, the vehicle stops sending information about new trips.

Note

Vehicle location sharing

You need to enable vehicle location sharing in the display and in the Volvo Cars app to start logging your trips.

Storage limits

When a trip is logged, it can be stored in the Trips app for up to 400 days. The app has the capacity to store approximately 500 trips. When this limit is reached, older trips are automatically deleted to free up space and make room for new trips.

Note

If the journal isn't logging trips, the reasons for this might include:

- Weak or no network connection.
- The app isn't receiving GPS coordinates.
- Location permissions are disabled so the Trips app can't access the vehicle's location.

^[1] VIN

8.2. Starting the vehicle

You start the vehicle by pressing the brake pedal and turning the start knob clockwise. Starting the vehicle also requires a present and correctly used key.



Turn the start knob clockwise to start your vehicle.

Before you start driving, make sure that:

- All doors are closed.
- All occupants are properly seated and wearing their seat belts correctly.

The content of this manual represents the status of the user manual at the time of printing and may not be completely valid in future instances. For more information refer to the first page for the complete disclaimer note.

- The driver seat, the steering wheel position and the mirrors are adjusted to your driving position.
- The driver area and the pedals are not obstructed.

 **Tip**

The vehicle can alert you to certain conditions you should address before driving. If something is preventing you from starting the vehicle, have a look in the instrument panel for guidance.

1. Make sure you have a key with you.
 2. Press and the brake pedal and hold it down.
 3. Turn the start knob all the way round clockwise and release it.
- > The engine starts and the start knob returns to its original position automatically.

 **Note**

If you want to turn the ignition on without starting the engine, turn the start knob clockwise without pressing the brake pedal. This lets you operate the windows or adjust the climate settings, for example. Keep in mind that having the ignition on drains the battery.

4. Select gear D or D using the gear selector.
- > The selected gear is indicated in the instrument panel. The ready symbol also appears, emphasizing the transition from parked to a driving gear.

 **Note**

The ready symbol disappears when the vehicle's speed exceeds a walking pace.

 **Warning**

Don't leave the vehicle running in an enclosed space. The fumes can cause serious harm to people or animals.

If the engine doesn't start after three attempts, try again after a few minutes. Waiting a while before trying again allows the 12 V battery to recover.

8.2.1. Startup checks

When you select a gear to start driving, the vehicle performs a number of self-checks of important systems and functions. This short test is indicated on the instrument panel.

The startup check is indicated by several warning and indicator symbols in the instrument panel. If any of the warning or indicator symbols remain visible after a few seconds, it tells you that there's a fault or condition you need to address before driving.

If a fault is indicated:

- Read any related information presented on the instrument panel.
- For additional information about warning and indicator symbols, consult that section of the manual.
- Resolve the indicated fault before driving.
- If you cannot resolve the issue yourself, do not hesitate to contact an authorized Volvo workshop.

After performing the startup check, the vehicle continues to actively monitor many of its systems and functions.

8.2.2. Alcohol lock

The alcohol lock is a safety measure to prevent driving under the influence of alcohol. If your vehicle is equipped with an alcohol lock, you must take and pass a breathalyzer test before you can start your vehicle.

If you have connected an alcohol lock, it will integrate with some of your vehicle's systems. This means that you may receive messages from the alcohol lock directly in the instrument panel. The alcohol lock should be calibrated in accordance with current local laws and regulations on the legal limit for driving.

For information about a specific alcohol lock, please refer to the relevant alcohol lock manufacturer.

Warning

The alcohol lock is an aid and does not exempt the driver from responsibility. It is always the responsibility of the driver to be sober and to drive the vehicle safely.

Using an alcohol lock

The alcohol lock automatically activates to be ready for use when the vehicle is unlocked. Follow the instructions included when the alcohol lock was installed, along with the messages presented on the instrument panel.

After completing a driving cycle, meaning that you have driven and then stopped, your vehicle can be restarted within 30 minutes without requiring a new breathalyzer test.

Tip

Accurate measurement

Avoid eating or drinking approximately five minutes before the breath test.

Avoid excessive windshield washing, as the alcohol in the washer fluid may affect the alcohol lock.

Emergency bypass of the alcohol lock

In the event of an emergency or if the alcohol lock is not working, it is possible to bypass the alcohol lock. To do so, see the instructions provided with the alcohol lock or contact the manufacturer.

8.3. Turning the vehicle off

You turn the vehicle off using the start knob in the center console.



Turn the start knob clockwise to turn your vehicle off.

1. To turn the vehicle off, turn the start knob clockwise and release it.

If the vehicle is moving, turn the start knob clockwise and hold it until the vehicle turns off. Then release the start knob.

The start knob returns to its original position automatically.

8.4. Driving characteristics

Explore the features that affect driving performance and dynamics. This allows you to customize your driving experience.



Your vehicle has several features that affect the driving dynamics and performance.

- Drive modes** Your vehicle has different drive modes to choose from, which are suited for different kinds of driving. Selecting a drive mode changes the driving dynamics and can sometimes affect what settings are available.
- Manual gear shifting** Even though your vehicle has an automatic transmission, you can enable manual gear shifting by selecting gear M.
- Start and stop** The start and stop feature reduces fuel consumption and emissions by letting you temporarily turn the engine off during brief stops while keeping the vehicle's systems active.
- Launch feature** Launch can be used when you need maximum acceleration from a standstill, such as when starting your vehicle on a steep incline.
- Steering feel** Adjusting the steering feel affects the steering wheel resistance and firmness.
- Electronic stability control^[1]** Your vehicle has automatic stability control systems in place that can help to prevent skidding.

^[1] ESC

8.4.1. Drive modes

The drive modes change the driving dynamics of your vehicle and which settings are available.

The different drive modes available in your vehicle are all suitable for different scenarios and types of driving. Depending on which drive mode you select, certain driving dynamics may be affected, such as steering, suspension, braking, and acceleration.

Different drive modes also allow for different adjustable settings, both related to both driving and climate.

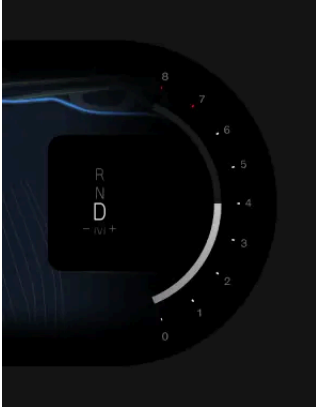

Your selected drive mode is shown above the selected gear in the instrument panel^[1].

Your vehicle has two drive modes:

Standard This is the default mode and is recommended for everyday use. It's also selected automatically every time you start the vehicle.

Off-road The off-road mode is suitable for when you're driving on roads with limited accessibility or rough terrain. You can also use off-road mode when you're driving on loose surfaces as deep snow or sand. It activates hill descent control, allowing your vehicle to brake in a more controlled and active way when driving downhill.

Note

Off-road

The off-road mode is only available at speeds below 40 km/h (25 mph). Driving at higher speeds automatically disables the off-road mode. If this happens while driving on a steep downhill gradient, the automatic braking effect from hill descent control will gradually decrease.

Your fuel consumption may increase when driving with the off-road mode selected.

Selecting the off-road mode disables the start and stop feature.

The off-road mode is not designed to be used on public roads.

^[1] The comfort mode is not indicated in the instrument panel, as it is in your standard mode.

8.4.1.1. Selecting a drive mode

You can select a drive mode in settings.

Your vehicle is equipped with different drive modes for different driving conditions and situations. Selecting a drive mode allows your vehicle to adjust the driving characteristics and dynamics for the intended use, which might disable certain settings. You can select a drive mode in settings.

Comfort drive mode is selected by default every time you start your vehicle.

1. Press the vehicle symbol  in the bottom bar and go to **Settings**.

The content of this manual represents the status of the user manual at the time of printing and may not be completely valid in future instances. For more information refer to the first page for the complete disclaimer note.

2. Go to **Driving** → **Drive modes**.

3. Select a drive mode.

> Your vehicle's driving characteristics and settings are adjusted based on your selected drive mode.

8.4.2. Using the launch feature

Launch can be used when you need maximum acceleration from a standstill, such as when starting your vehicle on a steep incline.

The launch feature can be helpful when you're starting the vehicle on a steep uphill incline, as it allows maximum acceleration from a standstill.

 **Note**

The launch feature should be used sparingly as it causes wear on the engine.

The launch feature is only available from a standstill and after selecting gear D.

1. Press the brake pedal all the way down.

2. Press the accelerator pedal all the way down.

3. Release the brake pedal within two seconds.

> The vehicle launches with maximum acceleration.

8.4.3. Activating start and stop

The start and stop feature reduces fuel consumption and emissions by letting you temporarily turn the engine off during brief stops while keeping the vehicle's systems active.

The start and stop feature lets you temporarily turn the engine off during brief stops, such as when you stop at a traffic light. It then turns the engine back on once you're ready to drive again. This helps you reduce your fuel consumption and vehicle emissions.

You can see the status of the start and stop feature in the instrument panel.



The start and stop feature is active, and the engine is temporarily turned off.



The start and stop feature is available but not active.



The start and stop feature is unavailable.

All of the vehicle's systems continue to work when the start and stop feature turns off the engine. However, some functions, such as speaker volume, might operate at a reduced capacity until the engine is turned back on.

Activating the start and stop feature

- Press and hold the brake pedal when you're at a standstill or driving at very low speeds.
- > The engine temporarily turns off.

Deactivating the start and stop feature

- Release the brake pedal or gently press the accelerator.
- > The engine turns back on.

8.4.4. Stability control

Your vehicle has stability control systems in place that can help to prevent skidding.

Electronic stability control

Electronic stability control^[1] consists of several sub-features that can apply your vehicle's brakes automatically to prevent skidding when the vehicle detects a loss of traction or steering control. To do so, ESC applies the brakes to each wheel individually. When this intervention happens, the symbol for ESC flashes in the instrument panel.



Your vehicle's stability control includes several other features, such as:

Anti-lock braking system ^[2]	The vehicle's anti-lock braking system prevents the brakes from locking up during hard braking. This improves braking performance and maneuverability and helps to stabilize the vehicle.
Spin control and traction control	These features act to prevent the wheels from slipping against the road surface when you accelerate.
Engine drag control ^[3]	Helps to prevent wheel locking during engine braking on slippery surfaces.
Off-road mode	The off-road mode is suitable for when you're driving on roads with limited accessibility or rough terrain. You can also use off-road mode when you're driving on loose surfaces as deep snow or sand. It activates hill descent control, allowing your vehicle to brake in a more controlled and active way when driving downhill.

Stability control malfunction

If your vehicle notices a stability control malfunction, it will notify you with a symbol and a message in the instrument panel. The message and symbol depend on the nature and severity of the detected fault. If the electronic stability control symbol is continuously shown instead of flashing, this could indicate a stability control malfunction.

Be sure to read and follow any instructions in the message. It is recommended to address any ESC malfunctions as soon as possible, although it is possible to drive the vehicle with disabled ESC.



Tip

Some ESC malfunctions may only be temporary. You can try turning your vehicle off and then turning it back on to see if the message persists. If the message disappears, the malfunction was only temporary.



Warning

Stability control features are supplements to safe driving practices. They do not reduce or replace the need for the driver to stay attentive and focused on driving safely. Drive the vehicle with the same attention to safety as you would need to in a vehicle without the ability to intervene.

[1] ESC

[2] ABS

[3] EDC

8.4.5. Suspension

Your vehicle's suspension is designed to create a pleasant driving experience.

Your vehicle's suspension affects the comfort and handling of your drive and is tuned to suit your vehicle. The suspension cannot be customized or adjusted in any way.



Warning

The shock absorbers are gas pressurized. Do not heat or open the shock absorbers.

Suspension-related faults

If your vehicle notices a suspension-related fault, it will notify you with a symbol and a message in one or more of the displays. The message and symbol depend on the nature and severity of the detected fault. Be sure to read and follow any instructions in the message.

8.5. Range

Your vehicle's expected range is shown in the instrument panel and depends on several factors.

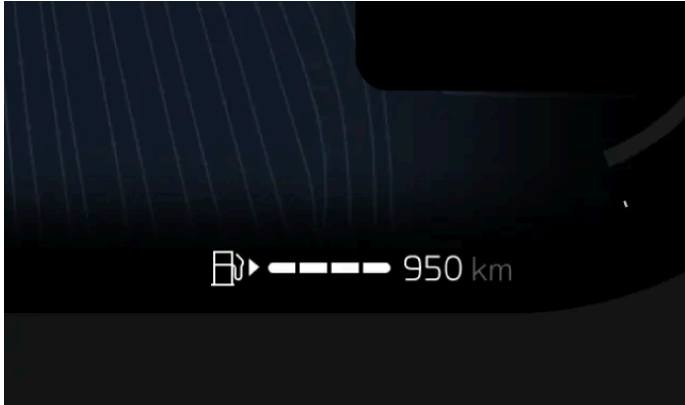

Your range is primarily related to the amount of fuel left in the tank and your driving practices, but external conditions can also be a factor. The fuel meter and expected range are displayed in the instrument panel.

The displayed range tells you how far you can drive with your current fuel level. Your fuel consumption depends on your driving style and your selected drive mode. The displayed range is an estimation and may differ accordingly.

Factors that affect your vehicle's range

How you drive your vehicle, which settings or features are active, driving conditions and traffic can all affect range in different ways.

Speed	Driving at higher speeds increases your fuel consumption.
Drive mode	Depending on your selected drive mode, your fuel consumption may be affected.
City driving and traffic situation	Varying your speed by frequently accelerating and braking will increase fuel consumption compared to keeping a constant speed.
Climate settings	Which climate features are active and how much they affect your fuel consumption.
Tires and tire pressure	Tire condition and tire pressure can affect your range.
Road condition and topography	Road conditions and hilliness can affect your range.
Towing	Towing a trailer demands more power from your vehicle and will adversely affect fuel consumption. This is relative to the type of trailer being towed.

8.5.1. Trip meter

The trip meter shows information on your vehicle's driving distance and average fuel consumption.

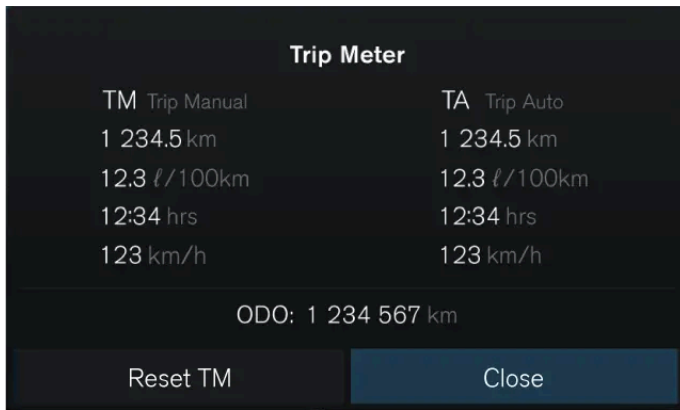

Your vehicle has a trip meter and an odometer. The trip meter can show information on the vehicle's driving distance and time, as well as your average fuel consumption and driving speed.

The trip meter is divided into two separate sections:

- Manual trip meter
- Automatic trip meter

The manual trip meter can be manually reset, while the automatic trip meter resets after four hours if the vehicle has not been driven.

The odometer shows the vehicle's total driving distance and cannot be reset.

Accessing the trip meter

You can open the trip meter by pressing the confirm button  on your steering wheel's right-side control panel. The odometer is shown in the bottom of the trip meter view.

If you want to adjust the trip meter settings, you can do so via **Controls** in the center display.

8.5.1.1. Resetting the trip meter

You can reset your vehicle's trip meter.

You can reset the trip meter using either the steering wheel buttons or the RESET button on the left-hand steering wheel stalk.

Note

You cannot reset the automatic trip meter.

Resetting the trip meter using the steering wheel buttons

1. Press the confirm button  on the steering wheel's right-hand control panel.

The content of this manual represents the status of the user manual at the time of printing and may not be completely valid in future instances. For more information refer to the first page for the complete disclaimer note.

> The trip meter view appears in the instrument panel.

2. Select **Reset**.

> The manual trip meter resets.

Resetting the trip meter using the steering wheel stalk button

3. Press and hold the **RESET** button on the left-side steering wheel stalk.

> The manual trip meter resets.

8.6. Steering

Get familiar with your vehicle's steering-related functions.



Your vehicle has been designed to provide a responsive and intuitive steering experience. Be sure to adjust your driving posture and select your preferred steering feel before driving.



Tip

Steering and driver support interactions

Several of your vehicle's driver support features can affect steering. Read the manual sections about these features for a more complete understanding of how they may interact with and affect your steering experience.

Speed-dependent steering response

The content of this manual represents the status of the user manual at the time of printing and may not be completely valid in future instances. For more information refer to the first page for the complete disclaimer note.

Steering resistance and firmness change with the speed of the vehicle. At low speeds, steering resistance is low for precision maneuvering. At high speeds, the steering adapts to be firmer.

Steering feel

You can adjust the steering feel via the settings in the center display. Steering feel affects the firmness of the steering wheel's turning.

Steering-related faults

If you notice that your steering wheel is abnormally stiff or if steering-related features ^[1] are not available or working properly, it may be due to a fault related to the steering system.

If your vehicle detects a steering-related fault, it will notify you with a symbol and a message in one or more of the displays. The message depends on the nature and severity of the detected fault. Be sure to read and follow any instructions in the message.



The symbol for steering-related faults will be shown in the instrument panel if your vehicle detects a fault with the steering system.

^[1] Such as lane keeping aid or Pilot Assist

8.6.1. Steering wheel

Get to know the steering wheel and some of its controls and features.

You can use your steering wheel for more than just steering the vehicle.



Heated steering wheel

The steering wheel has built-in heating. The function can be turned on manually or set to automatic activation.

Adjust the steering wheel position

The steering wheel can be adjusted to suit your driving posture.

Steering wheel control buttons

There are buttons on the steering wheel that can control certain features, settings and adjustments.

Horn

The horn button is located in the middle of the steering, indicated with the horn symbol .

8.6.1.1. Steering wheel controls

The steering wheel has several buttons and controls. They control specific functions, such as the horn, as well as certain settings, adjustments and what's shown in the instrument panel.









- Horn
- Control buttons
- Left-hand stalk
- Right-hand stalk







Control buttons



The buttons on your steering wheel's left-hand side control the driver support features.

-  Activate Pilot Assist
-  Increase set speed or resume
-  Decrease set speed
-  This button currently has no function
-  Switch between Pilot Assist and adaptive cruise control
-  Increase the time interval to vehicles ahead
-  Decrease the time interval to vehicles ahead

The buttons on your steering wheel's right-hand side control media and menu navigation in the instrument panel.

-  Confirm or select
-  Previous, rewind or left
-  Next, fast forward or right
-  Switch between instrument panel modes
-  Voice control
-  Increase volume or up
-  Decrease volume or down

The buttons' functions change depending on the context and they typically control what's currently shown in the displays.

8.6.1.2. Adjusting the steering wheel position

You can adjust the steering wheel position to suit your driving posture.

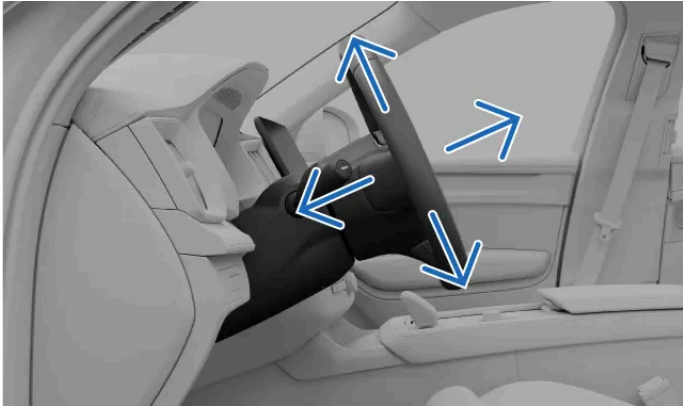

Adjusting the steering wheel position is fundamental to your driving posture, offering you better comfort and control of the vehicle.

 **Warning**

Make sure that you adjust your steering wheel position when you are parked, as this should not be done while driving.

 **Important**

Clear space around the instrument panel

Do not hang or place any objects on the steering column in front of or behind the instrument panel. You risk damaging the instrument panel if an object is placed there when the steering wheel position changes.

1. Push the steering wheel adjustment lever located on the steering wheel column.



2. Grasp the steering wheel and adjust its position.
Move it up or down and backwards or forwards to suit your driving posture.
3. Pull the steering wheel adjustment lever up to secure the position of the steering wheel.

 **Important**

Once you've finished adjusting the steering wheel position to your liking, it's important to make sure other parts of the vehicle are aligned correctly. Your driving posture is important and is affected by more than the steering wheel adjustments, such as the position of your seat and mirrors.

8.6.2. Adjusting steering feel

You can enable firmer steering feel in settings.

 **Note**

Your vehicle has speed-dependent steering wheel resistance, in addition to the manually adjusted steering feel. This means that your vehicle automatically adjusts the steering wheel resistance in line with your driving speed, giving you enhanced control and stability.

You can only access the steering feel settings when you're parked or driving slowly without turning the steering wheel.

1. Press the vehicle symbol  in the bottom bar and go to **Settings**.
2. Go to **Driving** → **Steering feel** → **Firm**.
3. Enable firmer steering feel.

8.7. Brakes

Your vehicle has several types of braking functions, both manual and automatic.



Your vehicle has several features and capabilities when it comes to braking.

Foot brake	Your main way of braking manually. Pressing the brake pedal may activate regenerative braking or engage the friction brakes, depending on the driving conditions.
Regenerative braking	Slows the vehicle down by using the vehicle's movement to charge the 48 V battery. ^[1]
Friction brakes	Slows the vehicle down by engaging the disc brakes.
Parking brake	Keeps the vehicle in place while parked.
Auto hold	Automatically applies the brake to hold the vehicle when coming to a stop.
Automatic braking	This is a general term for the vehicle's braking interventions. Several driver support and safety systems can intervene and perform braking maneuvers for safety reasons or convenience.
Post-impact braking	Automatic braking after severe collisions to avoid further hazards.
Electronic stability control^[2]	Helps prevent skidding and other stability-related issues by automatically applying the brakes individually.
Anti-lock braking system^[3]	Prevents the brakes from locking up during hard braking. This improves the braking performance stability and maneuverability of the vehicle.

i Note

Brake lights

Your vehicle's brake lights automatically light up during braking maneuvers. The lights respond to manual braking from brake pedal use, as well as automatic braking from any driver support system.

Emergency brake lights

During hard braking maneuvers, or if the ABS system is activated, the emergency brake lights will activate. This causes additional brake lights to light up to alert vehicles behind you.

^[1] Converts kinetic energy to electricity.

^[2] ESC

^[3] ABS

8.7.1. Foot brake

The foot brake engages different types of braking mechanisms, depending on the situation.

The foot brake engages either regenerative braking or the friction brakes, depending on how hard you press the pedal. Light braking activates regenerative braking, whereas harder braking engages the friction brakes.

Electronically controlled braking^[1]

The foot brake is electronically controlled. As the braking force is transmitted electronically rather than physically, there are no natural reaction forces traveling from the brakes to the pedal.

Anti-lock braking system^[2]

The vehicle's anti-lock braking system prevents the brakes from locking up during hard braking. This improves braking performance and maneuverability and helps to stabilize the vehicle.

Note

Parking brake

At high speeds, pulling and holding the parking brake switch will slow the vehicle down at a steady rate. This provides a backup alternative to braking normally. Only use the parking brake like this if you are unable to brake using the brake pedal.

Startup checks

Several brake systems are part of the vehicle's startup check. Make sure to resolve any indicated brake faults before driving.

Warning

Wet brakes

The vehicle's stopping distance may be longer if the brake discs are wet. If they have been exposed to water, safely perform a braking maneuver to remove water from the brakes. Engaging the disc brakes while driving heats up and dries them.

^[1] Also called brake-by-wire.

^[2] ABS

8.7.2. Parking brake

The parking brake keeps the vehicle stationary when you're at a standstill, such as after parking.

The parking brake locks the vehicle's rear wheels. When parked, the vehicle monitors and automatically tightens the grip if necessary.

By pulling the parking brake switch (P) in the center console when you're at a standstill, you engage the parking brake. Your vehicle can automatically engage the parking brake in several situations.

 **Important**

Parking gear

The parking gear and the parking brake are not the same thing. While the parking gear is capable of holding the vehicle stationary to a certain degree, it is not sufficient in all situations. Be sure to engage the parking brake after parking, as its applied braking force is much larger. This is particularly important when parking on an incline.

The instrument panel indicates when the vehicle is in park and the parking brake is engaged.

 **Warning**

Avoid parking on a slope in wintry conditions. The tires might lose traction, even if the parking brake is engaged. You are always responsible for safe parking. Check the parking brake warning symbol for the parking brake status.



Continuous illumination indicates that the parking brake is engaged. Flashing indicates a parking brake fault.

 **Note**

At high speeds, pulling and holding the parking brake switch will slow the vehicle down at a steady rate. This provides a backup alternative to braking normally. Only use the parking brake like this if you are unable to brake using the brake pedal.

8.7.2.1. Engaging the parking brake

Engage the parking brake by pulling the parking brake switch in the center console.



Manually engage the parking brake by pulling the parking brake switch.

Your vehicle can automatically engage the parking brake in several situations. These include when:

- you select the parking gear, P, when stationary on a steep incline.
- your vehicle has been stationary in auto hold for a longer period of time.
- you leave your vehicle or turn it off while auto hold is active.



Tip

Automatic parking brake release

The parking brake is automatically released when you press the accelerator after selecting gear D or R. You must also have your seat belt buckled or the driver door closed.

Manually engaging the parking brake

1. After coming to a stop, pull the parking brake switch (P) in the center console.
- > The parking brake is engaged. The P on the parking gear button lights up, and the parking brake symbol is shown in the instrument panel.



Manually releasing the parking brake

2. Press the brake pedal firmly.
 3. Push the parking brake switch (P).
- > The parking brake is released, and the parking brake symbol in the instrument panel disappears.

8.7.3. Auto hold

Auto hold helps to keep the vehicle stationary after coming to a full stop, allowing you to release the brake pedal.

When the vehicle comes to a full stop, auto hold will automatically activate if the feature is enabled.

Activation of auto hold is indicated by the auto hold symbol in the instrument panel.



To exit auto hold and continue driving in the selected gear, press the accelerator.

i Note

Automatically engaging the parking brake

If auto hold has been active for a longer period of time, the parking brake is automatically activated. This can also happen if you unbuckle your seat belt, open the driver's door or turn the vehicle off while auto hold is active.

You can enable or disable auto hold using the auto hold button (A) in the center console.

8.7.3.1. Enabling auto hold

You can enable or disable auto hold with the auto hold button in the center console.

Auto hold automatically applies braking after you've come to a stop. You can enable or disable auto hold by pressing the auto hold button in the center console.



1. Press the auto hold button in the center console.
- > Auto hold is enabled and the symbol (A) is illuminated on the auto hold button.

 **Note**

Disabling auto hold

You can disable auto hold the same way you enabled it. Just press the auto hold button in the center console. The auto hold symbol  on the button will no longer be illuminated after the feature is disabled.

If auto hold is active and currently holding your vehicle stationary, you must press the brake pedal and the auto hold button at the same time to be able to disable the feature.

After disabling auto hold, some brake assistance is still available at a standstill, such as roll-back prevention when starting the vehicle on an uphill incline.

8.7.4. Post-impact braking

The vehicle automatically applies the brakes when a severe collision is detected. This can reduce the risks associated with additional impacts.

In the moments after a collision, the vehicle may still be moving at high speed. There is also a major risk that the driver is not in full control of the vehicle, which could lead to additional impacts.

In the event of a severe collision^[1], automatic braking reduces your speed in a controlled manner, bringing the vehicle to a halt. Reducing your speed is especially important if there are pedestrians, vehicles or objects in the vehicle's path.

The brake lights and hazard warning lights activate during the maneuver. When the vehicle comes to a stop, the hazard warning lights stay on and the parking brake activates.

 **Note**

Manual override

Pressing down on the accelerator overrides the braking maneuver, allowing the driver to select a safe place to stop.

Post-impact braking requires that the brake system is intact after the collision.

^[1] The severity of the collision must exceed a certain threshold for post-impact braking to activate. For example, if airbags have deployed.

8.8. Transmission

Your vehicle has an automatic transmission, meaning that gears are selected automatically so that you can drive as efficiently as possible.



The available gears are:

- R Reverse
- N Neutral
- D Drive
- M Manual
- P Park

Having an automatic transmission means that you don't have to change gears manually while driving. When driving in gear D, the vehicle adjusts the gear depending on your driving speed and the power requirements.

Manual shifting

Manual shifting is available in gear M. Once selected, you can shift up or down by moving the gear selector to the left or right. If you drive too fast or slow relative to your selected gear, the vehicle will automatically shift to a higher or lower gear.

Note

Kick-down acceleration

By pressing the accelerator pedal all the way down, beyond the position normally regarded as full acceleration, you activate the kick-down feature. Your vehicle will shift down to a lower gear, enabling faster acceleration. This can be helpful if you are about to overtake another vehicle.

Once the accelerator pedal is released, the vehicle will shift up to the appropriate gear again.

Parking gear

The parking gear can be automatically selected in situations where your vehicle interprets your actions as if you're about to park and leave. These situations can include:

The content of this manual represents the status of the user manual at the time of printing and may not be completely valid in future instances. For more information refer to the first page for the complete disclaimer note.

- Turning your vehicle off when stationary in gear D or R.
- Unbuckling your seat belt and opening the driver's door while the vehicle is moving slowly without you using the brake or accelerator pedals.

You can also select the parking gear by pressing the P button next to the gear selector.



When P is selected, the transmission is mechanically blocked to avoid accidental gear shifts.

! Important

Parking brake

The parking gear and the parking brake are not the same thing. While the parking gear is capable of holding the vehicle stationary to a certain degree, it is not sufficient in all situations. Be sure to engage the parking brake after parking, as its applied braking force is much larger. This is particularly important when parking on an incline.

Transmission-related faults

If a fault is detected with the transmission, such as overheating, this is communicated with a message in the instrument panel. Make sure to follow any instructions in the message.

8.8.1. Selecting the gear

Select a gear by moving the gear selector backward or forward. The current gear is indicated on the instrument panel.



The available gears are:

- R Reverse
- N Neutral
- D Drive
- M Manual
- P Park

When moving the gear selector backward or forward, you can feel that it has two positions in both directions. Select R by moving the gear selector all the way forward. Move the selector all the way backward to select D.

You can select the neutral gear, N, by moving the gear selector to the first position in either direction and holding it there for a couple of seconds. The gear selector always returns to its middle position between gear selections.

Select M by moving the selector all the way backwards while driving in gear D. This enables manual gear shifting. Move the selector backward again to return to gear D.

Note

Selecting gears D, R, N or P is only possible when the vehicle is stationary or when you are driving at walking pace.

1. Press the brake pedal ^[1].
 2. • Move the gear selector forward or backward to select one of the driving gears or neutral.
 - Press the P button next to the gear selector to select the parking gear, P.
- > Your selection is indicated on the instrument panel.

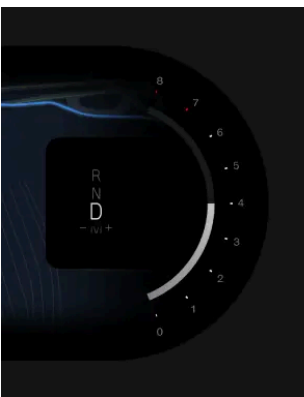

^[1] only necessary if your vehicle is stationary

8.8.2. Shifting gears manually

You can manually shift gears when driving in gear M.



After selecting gear M, you can manually shift gears by moving the gear selector to the left or right.

i Note

Gear shift indicator

The gear shift indicator in the instrument panel shows the current gear and tells you when to shift gears by flashing a plus or minus symbol.

To maintain good fuel economy, it's important to drive in the correct gear and change gears in time.

! Important

Manually shifting gears is only available after selecting gear M.

Shifting to a higher gear

- Move the gear stalk to the right to shift up a gear.

Shifting to a lower gear

- Move the gear stalk to the left to shift down a gear.

i Note

Driving too fast or slow relative to your selected gear may cause the vehicle to automatically shift to a higher or lower gear.

9. Visibility, mirrors, and exterior lights

Learn how to control your car's lights, mirrors, and wipers for better visibility when conditions call for it.



Front view of the vehicle showing exterior lights, mirrors and windshield wipers

Your vehicle is equipped with multiple features to assist you in your driving. Some are designed to improve safety, while others improve visibility. Some features are designed with both purposes in mind. Reading this section of the manual can assist in making your driving experience safer and more comfortable.

9.1. Exterior lights

Your vehicle has a range of lighting capabilities. You can select and control the different lighting options.

 **Warning**

Vehicle light systems that are dependent on ambient light detection do not relieve you from your responsibility to ensure that proper lighting is used for all situations according to local laws and traffic regulations.

Exterior lights refers to all of the exterior illumination functions and features that affect visibility.



Exterior light control locations

- ① You control certain driving lights, such as the lighting modes, fog lights and the turn signals with the left-hand steering wheel stalk.
- ② You select exterior convenience lights in the center display.
- ③ The hazard warning lights button is located below the center display.

Some lighting features rely on the vehicle's ability to sense poor light conditions outside. Make sure that the vehicle's cameras are kept clean and are well-maintained. If the cameras' views are affected by dirt, they can't do their job properly. They need to be able to obtain enough information so that they can properly direct the vehicle's responses.

i Note

Camera maintenance

There is a forward-facing camera located behind the windshield. Do not clean the camera or any area behind the windshield cover by yourself, it should only be carried out by an authorized Volvo workshop or similarly qualified service professional. If you are concerned that the camera's visibility is obscured by dirt, use the windshield wipers and washer fluid to clean the windshield in front of the camera. The camera will be cleaned during regular scheduled servicing. If in doubt, or if you suspect that the camera needs immediate cleaning, contact Volvo Support.

Condensation in the lights

Exterior lighting may temporarily contain water from condensation. This is normal and all exterior lights are designed to withstand this. Condensation is normally vented out of the light housing after a period of time.

9.1.1. Driving lights





Driving lights mix automatic behaviors and direct controls in a way that allows you to adapt to any situation or visibility condition.

 **Important**

The driver is always responsible for ensuring that the vehicle is driven while using a lighting mode that is suitable for the current driving conditions and local traffic regulations.

Exterior lighting

You can choose between several different exterior lighting modes by rotating the ring on the left-hand steering wheel stalk.

	Auto	Automatic lights mode ^[1] allows your vehicle to automatically detect and calculate which lighting mode is most suitable depending on the lighting conditions.
	Passing beam	You can manually select the passing beam to keep the front lights dipped.
	Parking lights	The position lights are points of illumination around the vehicle that make it more visible to other road users.
	Off	0 deactivates all lighting modes. ^[2]
	Automatic high beam	Automatic high beam allows the high beam to automatically react to traffic ahead. ^[3]

Additional lights

You can control the high beam and the turn signals with the left-hand steering wheel stalk.

The hazard warning flasher helps you to warn others of potential risks. You can turn them on or off by pressing the button below the center display.

There are additional lights that can be enabled or adjusted, such as:

Rear fog light The rear fog light warns traffic behind you of your presence in poor visibility conditions. You activate it via the button on the left-hand steering wheel stalk.

Front fog lights The front fog lights warn traffic of your presence in poor light conditions. You can activate them using the button on the left-hand steering wheel stalk.

^[1] AUTO

^[2] Some exterior lights may remain on when driving based on regulations in various market regions.

^[3] The rotating ring springs back to AUTO when the automatic high beam is selected.

9.1.1.1. Operating the driving lights

Familiarize yourself with operating the lights controls that are available via the left-hand steering wheel stalk.

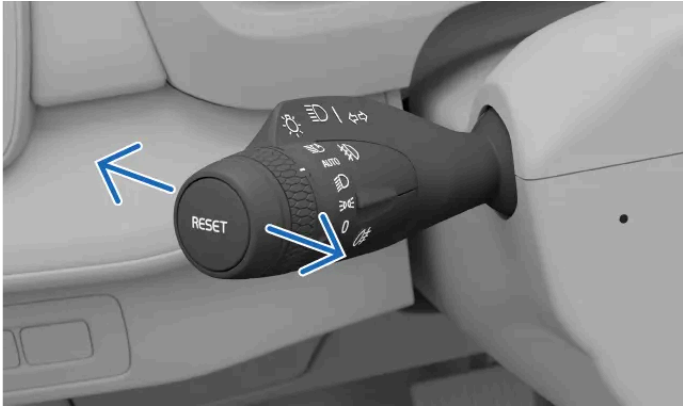

The horizontal stalk positions

You can move the left-hand stalk forwards or backwards to switch between different lighting selections.

The selections available are:

- High beam on
- High beam off
- High beam flash

Manual high beam

- When automatic lights mode^[1] or manual passing beam is selected on the rotating ring of the left-hand steering wheel stalk, push or pull the stalk to turn the manual high beam on or off.

Automatic high beam

- When automatic high beam is activated on the rotating ring of the left-hand steering wheel stalk, pull the stalk fully to deactivate automatic high beam.^[2]

High beam flash

- Pull the left-hand steering wheel stalk slightly to activate the high beam flash.

^[1] AUTO

^[2] The rotating ring always springs back to AUTO when selecting automatic high beam.

9.1.1.2. High beam

The high beam is important for your driving visibility. There are different states you can use to suit your needs.

 **Important**

Remember that your ability to see the road properly in low lighting conditions is important not just for your own safety, but for other road users and pedestrians too.

The high beam is more powerful and has a longer reach of illumination than the passing beam. To use the high beam, you must first activate automatic lights mode^[1] or the passing beam.

You can choose between either automatic high beam or manual high beam.

You activate automatic high beam by rotating the ring on the left-hand steering wheel stalk to the automatic high beam symbol . The ring always springs back to the automatic lights mode **AUTO**.

When automatic high beam is enabled, your vehicle automatically switches between the high beam and the passing beam to avoid causing glare to other road users.

 **Note**

When enabled, automatic high beam only activates at speeds over approximately 20 km/h (12 mph) in low light conditions.

There are symbols in the instrument panel that show which high beam setting is currently active. These include:



Manual high beam is active.



Automatic high beam is enabled.



Automatic high beam is active.

 **Important**

Make sure that the vehicle cameras are well-maintained and kept clean. If the cameras' views are obscured by dirt, they will not be able to obtain enough information to properly direct the vehicle's lighting responses.

^[1] AUTO

9.1.1.3. Passing beam

The passing beam reduces the risk of causing glare for other road users.

The passing beam is part of automatic lights mode. However, you can manually select the passing beam to keep the front lights dipped.

i Tip

Poor lighting and dark conditions

If you have automatic lights mode selected on the left-hand stalk rotating ring and your vehicle detects poor lighting or dark conditions, the vehicle automatically turns the passing beam on. When the vehicle detects better lighting conditions again, such as when you exit a tunnel, it automatically turns the passing beam off.

9.1.1.3.1. Activating the low beams

The passing beam can be manually selected on the rotating ring on the left-hand steering wheel stalk.

Manually selecting the passing beam keeps the front lights dipped.



The passing beam symbol on the rotating ring on the left-hand stalk

1. Rotate the ring on the left-hand steering wheel stalk to the passing beam  position.

Deactivate the passing beam by selecting a different lighting mode.

9.1.1.4. Active bending lights

Active bending lights work during turns to actively shift the area of illumination to the point you're steering towards.



Active bending lights

The bending lights operate to give you greater awareness in low lighting conditions when automatic lights mode is selected on the rotating ring on the left-hand stalk.

9.1.1.5. Activating the front fog lights

The front fog lights are designed to warn traffic of your presence in bad weather with poor lighting conditions.

You need to manually activate the front fog lights via the button on the left-hand steering wheel stalk.

1. Press the button marked with the front fog light symbol  on the left-hand steering wheel stalk to turn the lights on or off.
 - > The fog light symbol appears in the instrument panel showing the lights are active.

The front fog lights are switched off automatically if you move the rotating ring on the left-hand stalk to the 0 symbol.

9.1.1.6. Activating the rear fog light

The rear fog light is designed to warn traffic behind you of your presence in bad weather with poor light conditions.

You need to manually activate the rear fog light via the button on the left-hand steering wheel stalk.

Note

- The rear fog light can not be activated if the rotating ring on the left-hand stalk is in the 0 position.
- When the position lights are selected, the rear fog light only activates if the front fog lights are on.

1. Press the button marked with the rear fog light symbol  on the left-hand steering wheel stalk to turn it on or off.
- > The rear fog light symbol appears in the instrument panel, showing the light is active.

The rear fog light is turned off automatically if you move the rotating ring on the left-hand stalk to the 0 symbol.

Note

When you connect a trailer, the rear fog light may not illuminate, since the light's functionality is instead transferred to the trailer. Check whether the trailer is equipped with a rear fog light before activating the rear fog light to ensure safe operation.

9.1.1.7. Activating the position lights

The position lights help to alert other road users to the presence of your vehicle.

The position lights are useful when you need to make other road users aware of your position, such as when you intend to leave the vehicle stationary for a short period of time.



The position lights symbol on the rotating ring on the left-hand stalk

1. Rotate the ring on the left-hand steering wheel stalk to the position lights  position.

The position lights will remain on for a long time when your vehicle is parked. Deactivate the position lights by selecting a different primary lighting mode.

Note

Opening the trunk

If you open the trunk in low lighting conditions, the rear position lights automatically activate.

9.1.1.8. Hazard warning lights

If there is a potential risk to surrounding traffic, you should turn the hazard flashers on. This helps to alert other road users of the need for greater awareness.

Important

It is the driver's responsibility to use hazard lights according to local laws and traffic regulations.

The hazard warning lights button is located below the center display.

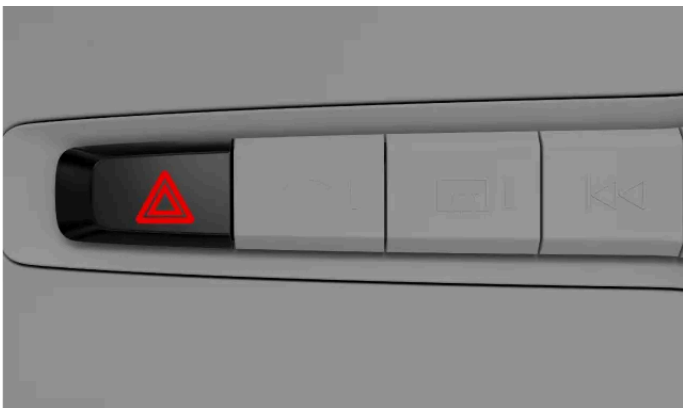

The location of the hazard warning lights button below the center display

The status and interaction point to control the hazard lights is indicated by the associated symbol.



In the event of a collision

Your hazard lights will automatically turn on in the event of a collision.^[1]

^[1] This is dependent on local regulations and regional standards.

9.1.1.8.1. Activating the hazard warning flashers

The hazard warning lights are essential for driving safety. Be sure that you know how to work them.



Hazard warning flasher symbol

When you get into the vehicle, the hazard warning lights button illuminates, showing that you can use it.

1. Press the hazard warning lights button below the center display.
- > Both of the turn signal symbols in the instrument panel and the hazard warning lights button will flash simultaneously in the same rhythm as the lights. You will also hear a ticking sound.

9.1.2. Operating the turn signals

Use turn signals to communicate how you intend to maneuver your vehicle. The controls are located on the left-hand steering wheel stalk.

The signals have two types of activation – quick and standard. While the turn signals are blinking, you will hear a clicking sound and see a turn signal symbol in the instrument panel.



The indicators on the left-hand stalk

Quick turn signal

1. Move the left-hand steering wheel stalk slightly up or down and allow it to spring back to the middle.
- > The turn signals blink three times before turning off.

The content of this manual represents the status of the user manual at the time of printing and may not be completely valid in future instances. For more information refer to the first page for the complete disclaimer note.

Standard turn signal

2. Move the left-hand steering wheel stalk up to turn the right turn signal on and down to turn the left turn signal on.
- > The turn signals blink continuously until you straighten the steering wheel out after turning.

Note

You can cancel the turn signals by moving the left-hand steering wheel stalk back to its original position.

Note

Turn signal malfunction

In the event of any malfunction or damage to the turn signals, the sound and the flashing turn signal symbol will be twice as fast as normal, and the malfunction symbol appears in the instrument panel.

9.1.3. Exterior convenience lights

There are lighting functions available that make it easier to see when you are outside and approaching your vehicle.

Welcome lights

Certain lights automatically activate for a short period of time when you approach and unlock your vehicle.

Guidance light

When you lock and leave your vehicle, it can provide extra lighting around the exterior for a short period of time.

9.1.3.1. Welcome lights

Your vehicle can indicate that it recognizes you coming with welcome lights.

Activate the feature in the center display.

Welcome lights

A brief light sequence triggers when you approach and unlock your vehicle.

9.1.3.1.1. Enabling the welcome lights

You can turn on the welcome lights sequence for when you unlock your vehicle.

The welcome lights display a short lighting sequence and give better visibility as you approach and unlock your vehicle.

1. Press the vehicle symbol  in the bottom bar and go to **Settings**.
2. Go to **Controls** → **Locking** → **Greeting lights**.
3. Turn the welcome lights on or off.

The welcome lights setting stays active until you disable them.

9.1.3.2. Guidance light

The guidance light helps you to see when you're outside of the vehicle and helps others to see you. This is useful when you are parked in a dark location.

The guidance light provides extra lighting around the exterior of your vehicle for a short period of time when you lock and leave it. You can activate the guidance light by using the left-hand steering wheel stalk.

9.1.3.2.1. Activating the guidance light

Find the activation controls for the guidance light.

 **Note**

Make sure that your vehicle is stationary and turned off before you activate the guidance light.

1. Move the left-hand steering wheel stalk forward and release.
 - > A notification will appear in the instrument panel to indicate that the guidance light is active. The outer lighting, such as the position lights, headlights and license plate lighting will turn on.
2. Get out of the vehicle and lock the door.

The guidance light is active for about one minute.

The content of this manual represents the status of the user manual at the time of printing and may not be completely valid in future instances. For more information refer to the first page for the complete disclaimer note.

9.2. Mirrors

The rearview mirror and the two door mirrors are important for your driving awareness. Make sure that you adjust the mirrors to your needs before driving.

Rearview mirror

You can adjust the interior rearview mirror by moving it manually.

The rearview mirror has three buttons on its underside and an indicator light in the lower part of the mirror for HomeLink.



Tip

Use the automatic dimming feature

Automatic dimming can reduce the glare from strong lights in the mirror. Auto dimming is triggered only when poor lighting conditions are detected outside the vehicle. Be sure to turn on the automatic dimming feature on to avoid glare in the mirrors.

Door mirrors

You can adjust and reset the door mirror positions, as well as fold the mirrors, using the controls in the driver's door button panel.



Controls for adjusting the door mirrors

If you want the door mirrors to automatically fold when you lock the vehicle, you can enable a setting for this in the locking settings via the center display.

The door mirrors are heated to prevent ice and frost from impeding visibility. The door mirror heaters start automatically when you activate the rear defroster.



Warning

The passenger side's door mirror is curved to improve visibility. Objects may appear to be further away than they actually are.

9.2.1. Enabling automatic dimming

Bright lights, such as other vehicle headlights, can reflect in the rearview mirror. This can cause glare, but your vehicle's automatic dimming counteracts this.

Enable automatic dimming to avoid being distracted by light from behind. For your comfort, make sure that you activate it before you start driving. You turn it off in the same way that you turn it on.

Note

If the light sensors for the rearview mirror are obstructed in a way that prevents light from reaching them, the automatic dimming effect will be reduced. For example, parking permits or sunshades could stop light from reaching the sensors.

1. Press the vehicle symbol  in the bottom bar and go to **Settings**.
2. Go to **Controls** → **Mirrors and wipers** → **Auto dim rearview mirror**.
3. Turn it on or off.

9.2.2. Adjusting door mirrors

Before you start driving, make sure that the door mirrors are in positions that give you good visibility.

You need to turn the ignition on to be able to adjust the door mirrors. To do this, just turn the start knob clockwise and release it.

1. Select the door mirror you want to adjust by pressing its corresponding button on the driver's door button panel.
 - Press the L button to adjust the left-hand mirror.
 - Press the R button to adjust the right-hand mirror.
- > The button lights up to indicate that you can adjust the selected door mirror.
2. Use the control stick in the button panel to adjust the mirror's position.
3. Press the L or R button again to finish adjusting the mirror.
 - > The button's light turns off to indicate that the mirror has been adjusted.



Tip

Manually tilting the door mirrors when in reverse

You can also tilt the door mirrors when your vehicle is in reverse. This can be helpful when parking so that you can see the curb more clearly. Just press the button twice for the door mirror you want to tilt and it will tilt downward. The mirrors return to their original positions when you change gear.

Automatically tilting door mirrors when in reverse

Enable **Exterior mirrors tilt at reverse** in the control settings so that the door mirrors automatically tilt downward when you put the vehicle in reverse. The mirrors return to their original positions when you change gear.

9.2.3. Folding door mirrors

You can fold and unfold the door mirrors using the buttons on the driver's door button panel.

Folding the door mirrors can be useful when you are parking or driving in narrow spaces.

1. Press and hold the L and R buttons on the driver's door button panel at the same time for a short period of time.
 - > The door mirrors start to fold when you release the buttons.



Tip

Unfolding the door mirrors

Unfold the door mirrors in the same way that you folded them. The mirrors unfold to the positions that they were in before they folded.

Automatic folding when you lock or unlock the vehicle

You can enable or disable automatic door mirror folding when you lock or unlock the vehicle. Just go to locking in the control settings via the center display and turn **Auto fold mirrors** on or off.

If you enable automatic folding but then fold the door mirrors yourself and lock the vehicle, the mirrors won't unfold automatically when you unlock the vehicle. You need to use the driver's door button panel again to unfold the mirrors.

9.2.4. Resetting door mirror positions

If you fold or unfold the door mirrors by hand, you need to reset the mirrors' positions so that the vehicle can fold them again.

You might need to fold or unfold the door mirrors by hand due to external factors, such as when folded mirrors are frozen in place. Moving the mirrors by hand stops the vehicle from being able to automatically fold or unfold them. You need to reset the door mirrors' positions by using the driver door button panel so that the vehicle can move the mirrors again.

1. Fold the door mirrors by pressing and holding the L and R buttons on the driver's door button panel at the same time for a short period of time.
 2. Unfold the door mirrors by pressing and holding the L and R buttons on the driver's door button panel at the same time for a short period of time again.
- > The mirror positions are reset, and the automatic folding will work again.

If the vehicle still can't fold the door mirrors, try resetting their positions again.

9.3. Wipers and washers

The wipers and washers work together to keep the windshield clean and clear.

Important

Before activating the wipers, ensure that the wiper blades are not frozen in place and that any snow or ice on the windshield is removed.

Wiper and washer controls



You control the wipers and washers using the right-hand steering wheel stalk.

Rain sensor

If your vehicle detects water on the front windshield when the rain sensor is active, the wipers will start automatically.

You can press the rain sensor button on the stalk to activate the sensor and turn the scroll wheel to adjust its sensitivity. The rain sensor will stay active until you press the button again or select another wiper mode. When the rain sensor is active, you can see a symbol in the instrument panel.



Active rain sensor symbol

Washers

The washer nozzles are integrated into the wiper arms for efficient washer fluid distribution. The wiper blades are automatically heated in cold conditions to prevent the washer fluid from freezing.

Your vehicle tells you when it's time to refill the washer fluid. When washer fluid is running low, a message appears in the center display.

! Important

Maintenance, refilling and replacing

- Clean the wiper blades regularly.
- Replace the wiper blades if they show signs of wear.
- Refill washer fluid when your vehicle tells you to.
- Avoid using the wipers without lubrication from either rain or washer fluid. It can cause wear or damage.

Car wash safety

Turn the rain sensor off when you enter a car wash. Otherwise, the rain sensor will cause the wipers to activate, which could lead to damage.



9.3.1. Controlling the front wipers

You can manually activate the windshield wipers or change the way they work.



Front wiper controls are on the right-hand steering wheel stalk.

There are different front wiper modes that you can activate by using the right-hand stalk. The modes are:

-  High speed
-  Normal speed
- INT** Interval wipe
- 0** Wipers are turned off
-  Single sweep

Single sweep

- Press the stalk downward and release.

Selecting wiper mode

- Press the stalk upward or downward.

Activating rain sensor

- Select mode 0 and press the rain sensor button .

Adjusting rain sensor sensitivity or interval wipe frequency

- Rotate the scroll wheel at the end of the stalk.

9.3.2. Activating washers

Activate the windshield washers with the right-hand steering wheel stalk.



Right-hand steering wheel stalk

Front washers

- Pull the stalk toward you and hold it there for a few seconds.
- > The front windshield washers activate. If the headlights' high beam or passing beam is active, the headlights are also washed.

When you let go of the right-hand stalk, the wipers make a few passes to wipe away excess fluid.

Note

Low washer fluid and washing headlights

If the washer fluid level is low, the headlights won't be washed. This is to prioritize the windshield washers to keep the windshield clean and clear.

10. Driver support and navigation

Driver support features are designed to improve safety, comfort and convenience when you are using your vehicle. They assist you with your driving, route-planning and decision-making on the road.



The collection of driver support features in this vehicle can assist you in driving, navigating and parking. Some are exclusively designed to improve safety, while others improve convenience. Some features are designed with both purposes in mind.

When used correctly, driver support features can reduce the effort of driving, help reduce distractions and improve safety for you and others. They often take advantage of the vehicle's ability to monitor and keep track of its surroundings. Some features deliver that information to you for increased driver awareness, while other features provide fast reactions to hazards that the vehicle identifies.

10.1. Navigation

Use the Google Maps navigation app to get directions and traffic information, as well as find the nearest service station.

When the vehicle is connected to the internet, it can continuously download map and traffic information to help you navigate to a destination. Navigation guidance can appear in the vehicle's displays.

The vehicle knows its location through GPS and shows it in the map views in the vehicle's displays.

Navigation app



Google Maps symbol

Note

Latest app version

Be sure to update the app whenever there's a new version available. Functionality and support for old versions may vary.

Tip

Changing map size

You can make the navigation map in the center display's home view bigger by pressing the home button — underneath the bottom bar. To return the map to its original size, just press the home button again.

Connected navigation features

Whenever your vehicle is connected to the internet, it can get the latest navigation information.

Real-time traffic information	You can get real-time traffic information if the vehicle is connected to the Internet. For example, you can see if traffic is moving slowly. Different colored lines that correspond to traffic situations will appear on your chosen map route. If the Internet connection is lost, the lines disappear after a while. You also get information about traffic conditions along the chosen route, such as roadworks or accidents.
Alternative routes and redirected traffic	When you set a destination in the navigation app, the fastest route is suggested while also taking your navigation settings into account. For example, you can choose to avoid tolls or ferries. The chosen route can be redirected while you are driving, such as when there is an accident or a traffic condition that affects your travel time.
Sharing information with other devices	Link your Google account to an active user profile to get the same Google Maps information in your vehicle as on your other devices. Destinations saved to your Google account using other devices, such as home, work, favorites and last searches, are then also available in your vehicle.

Offline maps

When you are connected to the internet, Google Maps automatically downloads map data based on your current position so that it is available even if your vehicle has poor reception or no internet connection. You can also choose to select and download a map area yourself. This feature is available in Google Maps' settings.

Displayed information

When a route is added, the following travel information about the trip is shown in the center display:

- Travel time
- Distance to the next destination on your route, such as an extra stop
- Estimated time of arrival
- The name of the next destination on your route

Depending on the selected display mode, the instrument panel shows different amounts of map and guidance information.

Navigation settings

You can change the navigation settings in the navigation app.

Warning

Avoid driver distraction

Avoid any interaction with the vehicle's systems or other devices that may distract you from driving safely. Any task that does not allow you to keep your attention on the road and surrounding traffic should be done when the vehicle is parked.

Note

Navigation limitations

- The navigation feature is from a third-party supplier. Availability, procedure and functionality may vary over time and depend on region.
- Navigation instructions can sometimes be less reliable than usual due to factors such as weather or road conditions.

Poor or no internet connection

The navigation app can have trouble finding a route or signal when you are in a location which can interfere with your internet connection, such as a tunnel or multi-story parking garage.

10.1.1. Finding and selecting a navigation destination

Find your destination using the search field or a voice command. The vehicle then suggests routes for you to choose from.

1. Press the app library symbol  in the bottom bar and open Google Maps.
2. Enter an address or destination in the search field.
 - > A route is suggested, together with alternative routes.
3. Select your preferred route.
4. Select start.
 - > Navigation instructions start.

10.2. Detection of surroundings and traffic

This section covers the essentials of how cameras, radar units and other sensors work, including their limitations. Understanding how your vehicle perceives its surroundings can help you use features that rely on this capability.

Your vehicle's ability to understand its surroundings is achieved through many systems and types of sensors. The vehicle's interpretation of the data it collects helps inform its behavior, especially for driver support features.

Cameras	Cameras work similarly to the human eye. What they capture is used for different purposes, which depends on the camera. For example, the upper front-facing camera helps the vehicle identify things such as traffic signs and road markings, while the rear parking camera captures images to display in the center display.
Radar units	The radar units use radio waves to collect information about the vehicle's surroundings. They can identify the distance to objects and certain aspects of their movement. This information is essential for many features in the vehicle.
Parking sensors	These sensors use sound waves to detect relatively close objects. They work by sending out ultrasound pulses that can bounce back to the sensors when they encounter an object.

How the systems work together

The different detection types complement each other. They are sometimes used on their own and sometimes together.

Important

Even when used together, these detection systems cannot handle all conditions and traffic situations. This is why it's important for the driver to never rely fully on driver support features. Always be attentive to conditions and situations where driver support feature performance is affected by the limitations of these features.

General detection and identification limitations

Each type of detection has its own set of limitations, but there are a few general things to consider as well.

- The vehicle can't always handle unpredictable or unusual situations. When the vehicle finds it difficult to correctly identify the environment or traffic situation, the accuracy of its response is affected.
- Damage to the vehicle can affect detection and features that use it. Many faults can be identified by the vehicle, but some may not be possible to self-identify. This is why it's important to make sure that the vehicle is in good condition and working order. Contact an authorized Volvo workshop if you suspect there is any fault or if you notice damage to the vehicle.
- Limiting factors and conditions can and often do coincide. They can compound and interact in ways that lead to an incorrect response from the vehicle.

Obstacle detection limitations

Obstacle detection helps the vehicle identify certain stationary and moving objects. These include other road users, such as pedestrians or other vehicles, as well as animals, barriers and other objects. If obstacles are in or close to the vehicle's driving path, they could pose a collision risk. Depending on the circumstances, the vehicle might be able to warn or intervene if the object is accurately identified. For every type of object the vehicle can identify, there are many factors that can prevent accurate identification. Examples of limiting factors, situations and events include:

- Closely spaced, overlapping or partially blocked objects and road users.
- Objects and road users that blend in with the background.

The content of this manual represents the status of the user manual at the time of printing and may not be completely valid in future instances. For more information refer to the first page for the complete disclaimer note.

- Objects and road users that move or accelerate particularly fast.
- Uncommon vehicles, such as recumbent bicycles, combine harvesters or trailers with oddly shaped loads.
- Bicycles of a different type or size compared to a regular adult bicycle.
- New modes of transportation.
- Pedestrians wearing clothing or carrying objects that alter their silhouette.
- Pedestrians shorter than 80 cm (32 inches).
- Obstacles angled in ways that create an unknown silhouette.
- Size and speed of animals. Cats and dogs are often too small to identify reliably.

Note

Traffic detection examples

Examples of different traffic scenarios can help you understand some of the limitations of your vehicle's detection systems. Real-world scenarios are often more complex than the example illustrations^[1] in this manual.

Out of view and late detection

The various detection zones around your vehicle are static, each with a limited range and field of view. If something enters a detection zone at an unusual angle, at high speed or very close to your vehicle, it can cause a rapid response. This reduces safety margins compared to a situation in which earlier detection is possible.

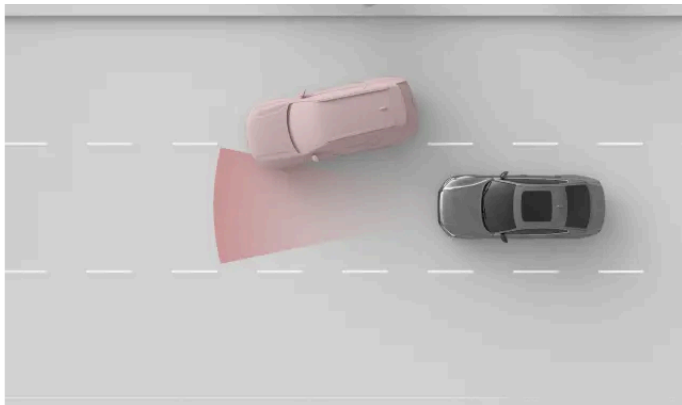

The front radar's detection zone has a limited width. If you get cut off by another vehicle, detection can occur relatively late, causing your vehicle to respond suddenly.

Important

Lane placement and small vehicles

Forward detection works better for objects in the middle of the lane than for those on the outer edges. Vehicles can go undetected if they don't occupy the middle of the lane. While this can happen for any vehicle, the risk is higher for small vehicles such as motorcycles. They take up less of the lane's width and can move about more within the lane. Always pay extra attention to any vehicle not driving in the middle of the lane.

Shape, size and number of objects

Detection can be less reliable depending on the shape, size and number of objects in a detection zone. These factors can make identification of the distance to the closest vehicle ahead less accurate, especially if several of these factors come into play.

- Small objects are harder to identify.
- The more objects in the detection field, the harder it is to identify individual ones.
- Objects close together that overlap are harder to identify.
- Objects with irregular shapes, such as overhanging or projecting parts, are harder to identify.

The presence of a large vehicle in front of you can make it difficult to identify a smaller one like a motorcycle between you and the large vehicle.

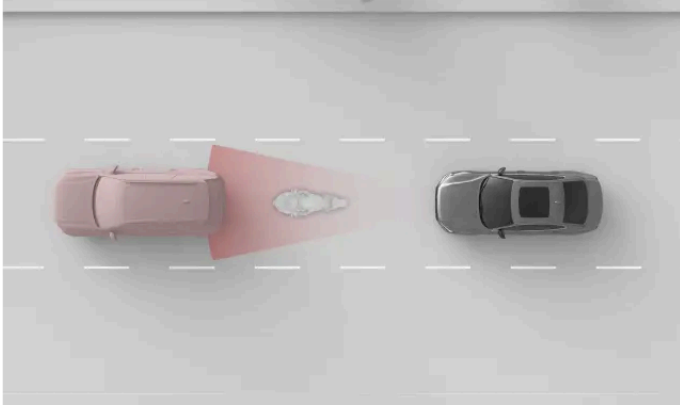

If the motorcycle and the larger vehicle are close to each other, they may appear to overlap to the detection systems, making detection of the motorcycle less accurate.

! Important

Trailer in front

Trailer detection is often less reliable than the detection of other vehicles due to their shape and height. This applies, in particular, to narrow trailers, flatbed trailers and trailers with high load beds. These types of trailers often don't have enough surface area at the height where forward detection systems focus.

Road and infrastructure

Curves in the road can cause the vehicle to misinterpret the traffic situation. For example, it can lose track of a vehicle or misidentify which lane a vehicle ahead is in.

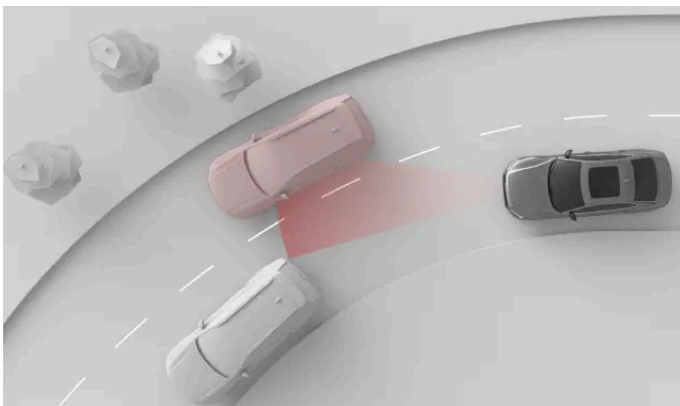

On a curve, the vehicle ahead may slip out of the detection zone. Vehicles in the adjacent lane may also enter the zone, affecting your vehicle's perception of the distance to traffic ahead.

 **Important**

Road condition and irregularities

Both common and uncommon road features can impact the effectiveness of the vehicle's detection systems.

- Sharp bends and bumps in the road can temporarily obscure important parts of the vehicle's surroundings, such as other vehicles or road markings.
- Non-standard or unusual road infrastructure might not be correctly identified by the vehicle. For example, road work or traffic diversions can result in conflicting or multiple sets of road markings.
- Worn road markings or signs might not be correctly identified.

^[1] The representations of detection systems and the vehicle's surroundings are not to scale.

10.2.1. Locations of cameras, sensors and radar units

Knowing the placement of different components the vehicle uses to map its surroundings helps you keep them free of dirt, obstructions and accidental damage.

Many of your vehicle's driver support features rely on data from components that scan and map your vehicle's surroundings, such as cameras, sensors and radar units. This section doesn't show all components and their precise locations, but it gives you a general idea of where they are. Areas pointed out in this section are particularly important to keep clean. Damage to these areas can also affect functions that rely on components located there.

 **Warning**

Clean regularly

Camera, sensor and radar locations on the vehicle must be cleaned on a regular basis and kept free from labels, objects, dirt and other potential obstructions. Otherwise, vehicle functions may respond incorrectly or become less responsive or deactivated.

Scraping the windshield

The windshield area in front of the front-facing camera has its own heating to defrost and remove any build-up of snow or ice. Do not use an ice scraper on this area, as it can scratch the glass surface. Scratches or damage to the glass can interfere with or limit the camera's detection capabilities.

Mounted accessories

Be mindful of the effects of mounted vehicle accessories, such as cargo racks or exterior light accessories. The items themselves or the load you add may obstruct cameras, sensors or radar units.



- ① The top center of the windshield houses a front-facing camera.
- ② The side-view parking assist cameras are located on the door mirrors.
- ③ There is a front-facing radar and a parking assist camera in the emblem area in the front of the vehicle.



- ① There is a parking assist camera in the rear center of the vehicle.
- ② The rear of the vehicle also has a radar in each corner.



Tip

Finding the parking sensors

There are multiple parking sensors along the lower edge of your vehicle. You can see their exact locations by looking for their button-like cover plates along the bumper panel.



Important

Cleaning in front of radar units

If you find dirt, snow or ice, or if the vehicle indicates that a radar unit is blocked, you should address it as soon as possible. Always clean and clear a large area around the radar units to so their full field of view is available.

10.2.2. Camera detection and limitations

The vehicle cameras capture the surroundings in a way similar to the human eye. This comparison is useful for understanding their capabilities and limitations.

Cameras help the vehicle identify certain objects and surfaces that visually stand out against their backgrounds. This includes things such as road markings, traffic signs, pedestrians and other vehicles.

Camera information in the parking view can provide you with an additional way to monitor the vehicle's surroundings.

Light conditions

Cameras need light to work and are affected by light conditions.

- Strong light sources, such as the sun, can cause glare and reflections that negatively affect camera detection.
- Low light can negatively affect certain types of camera detection.
- Some detection types require low-light conditions. When it's dark, the lights from other vehicles can be identified, as they stand out against the background.



Important

Camera detection in darkness

For the vehicle to be able to identify other vehicles when it's dark, the other vehicles must have their headlights and taillights turned on and be clearly visible. While the vehicle also uses other types of detection, such as radar, it may not have enough information to reliably identify vehicles that are not seen by the cameras. Several driver support features can be affected by this, such as safety interventions, collision warnings and features that provide distance-keeping.

Visibility

Poor visibility for the driver typically means poor visibility for the cameras. Objects that are hard to detect for the human eye can sometimes be hard to detect for the cameras as well. This can include well-camouflaged objects or objects where the outlines

The content of this manual represents the status of the user manual at the time of printing and may not be completely valid in future instances. For more information refer to the first page for the complete disclaimer note.

don't stand out against the background.

- Fog, heavy rain, snow or dust storms can severely limit visibility for the cameras.
- Beware of dust, water or snow on the ground that may be disturbed and kicked up into the air by your vehicle, other traffic or the wind.

Field of view and obstructions

Cameras see in the direction they're facing and only within their field of view. The field of view differs for each camera and depends on their intended purpose.

Obstructions limit what the camera sees. Each camera views the surroundings from its mounting position, and anything that enters its field of view blocks its view of what lies behind the obstruction. Objects close to a camera will block more of the camera's field of view than objects that are further away. If the vehicle detects that a camera is blocked, it can disable certain features that rely on that camera.

- Make sure that any mounted accessories, extra equipment or externally-stowed cargo don't block part of the cameras' fields of view. For example, far-extending roof loads may block part of the top view for front- and rear-facing cameras.
- Trailers, bike racks or other towbar-mounted equipment can block the rear camera view.
- Dirt, ice, snow, water droplets and condensation on camera lenses obstruct the cameras' view to some extent. In some cases, the vehicle may be able to identify that something is in the way and notify you. However, it is still recommended to regularly inspect the cameras and make sure that they are clean and unobstructed.

Warning

Clean regularly

Camera, sensor and radar locations on the vehicle must be cleaned on a regular basis and kept free from labels, objects, dirt and other potential obstructions. Otherwise, vehicle functions may respond incorrectly or become less responsive or deactivated.

Other limitations

If the cameras become too hot, they can be temporarily switched off to protect them from damage. This can happen when starting the vehicle after being parked in high temperatures in combination with direct sunlight hitting a camera. The camera will become available again once it has sufficiently cooled down.

Important

Windshield damage

Windshield damage in the camera area, including small chips, scratches or cracks, can negatively affect performance of the camera and features that use it. This may reduce functionality, cause unreliable vehicle responses, or disable features. If damage occurs, follow this manual's separate recommendations for handling windshield damage.

10.2.3. Radar detection and limitations

The radar units use radio waves to collect information about the vehicle's surroundings. They can identify the distance to objects and certain aspects of their movement. It's important not to block the radar units.

There are several radar units aimed in different directions to collect information about the vehicle's surroundings. This information is primarily used by the vehicle's driver support features. Radio waves are continuously sent out and bounce back if they encounter an object in their path. As the waves return, the vehicle can calculate the position and motion of the object, for example.

The radar units are not affected by lighting conditions and work equally well on sunny days and in complete darkness.

Important

Use responsibly

The radar units and the features that rely on them are supplements to safe driving practices. They do not reduce or replace the need for the driver to stay attentive and focused on driving safely.

Detection zone and field of view

Each radar unit in the vehicle has its own detection zone. The zone is limited by the radar's field of view and range.

Objects in the field of view block what's behind them. The closer something is to the radar, the more it blocks the radar's field of view.

- If a radar is blocked, certain features may become less effective or respond incorrectly.
- If the vehicle detects that a radar is blocked, it may disable certain features.
- Do not place or mount anything in front of or close to the vehicle's radar units. This includes stickers, vehicle body foil and adhesive tape.
- Paintwork damage in front of a radar can affect its performance. Contact a service point for repairs if there is any damage close to the radar units. ^[1]
- Make sure that any mounted accessories, extra equipment or externally-stowed cargo don't block the vehicle's radar units.
- Trailers, bike racks or other towbar-mounted equipment can block the radar, making it and certain features unavailable.
- The radar units are sensitive to the buildup of dirt, ice or snow in front of them. This affects the radio waves and can reduce the radar's ability to detect objects. Radar obstruction cannot always be identified by the vehicle. In situations where it is detected, the vehicle communicates this via notifications in the displays. However, it is still recommended to regularly inspect the radar units and make sure the areas around them are clean and free of obstructions.

Warning

Clean regularly

Camera, sensor and radar locations on the vehicle must be cleaned on a regular basis and kept free from labels, objects, dirt and other kinds of potential obstructions. Otherwise, vehicle functions may respond incorrectly or become less responsive or deactivated.

Other conditions and limitations

Other radar sources can cause interference and reduce the effectiveness of your vehicle's radar units.

[1] Volvo recommends authorized Volvo workshops for all servicing and repairs.

10.2.4. Parking sensor detection and limitations

The parking sensors allow the vehicle to detect objects and their distance from the vehicle. They operate at relatively close range during slow and tight maneuvering, such as when parking.

The parking sensors use sound waves to detect obstacles close to the vehicle. They work by sending out ultrasound pulses that can bounce back to the sensor when they encounter an object or barrier. This allows the vehicle to identify the distance to obstacles in the direction of detection.

Information from these sensors is only available at low speeds. They provide distance information when the parking view is shown in the display.

Important

Use responsibly

Parking sensors and features that rely on them are supplements to safe driving practices. They do not reduce or replace the need for the driver to stay aware of the vehicle's surroundings and focused on driving safely.

Detection range

The parking sensors are typically located relatively low down on the bumper.

- Obstacles whose supports are outside of the detection zone can go undetected. Such obstacles include objects that are suspended from above or objects that extend far from their ground support, such as certain barriers and gates.

Blocked sensors

The parking sensors can get blocked, either reducing distance and obstacle detection or making it unavailable. To avoid blocked sensors or to better understand when they may be unavailable, consider the following:

- If a sensor is blocked, certain features may become less effective or not respond correctly.
- Heavy rain or snowfall can lead to unreliable detection and can cause features relying on the parking sensors to become unavailable.
- If the vehicle detects that a sensor is blocked, it may disable certain features.
- Do not place or mount anything in front of or close to the vehicle's sensors. This includes stickers, vehicle body foil and adhesive tape.
- Bodywork damage where the sensors are located can affect their performance. Contact a service point for repairs if there is any damage near the sensors. [1]
- Make sure that any mounted accessories, extra equipment or externally stowed cargo don't block the sensors.
- Trailers, bike racks or other towbar-mounted equipment can block sensors, making detection and certain features unavailable.

- Parking sensors are sensitive to the buildup of dirt, ice or snow in front of them. This can reduce their ability to detect objects. The vehicle cannot always identify parking sensor obstruction. In situations where it is detected, the vehicle communicates this via notifications in the display. However, it is still recommended to regularly inspect the sensor locations and make sure the areas around them are clean and free of obstructions.

 **Warning**

Clean regularly

Camera, sensor and radar locations on the vehicle must be cleaned on a regular basis and kept free from labels, objects, dirt and other kinds of potential obstructions. Otherwise, vehicle functions may respond incorrectly or become less responsive or deactivated.

^[1] Volvo recommends authorized Volvo workshops for all servicing and repairs.

10.3. Driver behavior detection

The vehicle continuously monitors certain aspects of driver behavior. This is important for several driver support features.

Driver behavior detection is used to verify that specific conditions are met when driving and using certain features. A camera located in the rear-view mirror continuously tracks the driver's behavior without recording it. The information from this system is used by several driver support features.

Several aspects of driver behavior are monitored, including:

- Head and body posture
- Eye movement and focus
- Signs of tiredness or fatigue

An important part of the monitoring system is checking that the driver's hands are on the steering wheel when driving.

 **Note**

System for understanding the driver

In addition to tracking the driver's attention, the vehicle monitors some other parts of driving. This includes keeping the doors closed and seat belts buckled while driving. The individual detection points are combined to form a better understanding of the driver's focus, attention and behavior.

Information from the behavior detection system is combined to identify whether the driver's attention is focused on driving. This includes keeping track of traffic and surroundings, as well as being attentive and alert. The detection system can give you notifications in the instrument panel.

Reliant features and functions

The content of this manual represents the status of the user manual at the time of printing and may not be completely valid in future instances. For more information refer to the first page for the complete disclaimer note.

The driver behavior detection system keeps track of the driver's behavior to decide if the vehicle is being handled safely. If the system is blocked or detects driver misuse, it can trigger a response from several other features or functions of the vehicle.

Features that are affected by the driver behavior detection system include:

Driver and distraction alert notifications	You vehicle can notify you if you seem tired, distracted or unfocused.
Emergency stop assist	In situations where the driver is unable to continue driving, the vehicle can perform a controlled stop to reduce the risk of a collision.
Pilot Assist	Pilot Assist's steering assistance can be deactivated if you seem unfocused or don't respond to requests to keep your hands on the steering wheel.

Conditions and limitations

The driver behavior detection system relies on camera detection and tracking. While the system is advanced, cameras have limitations related to visibility that can affect the system's detection capabilities. Read the separate section about the conditions and limitations of your vehicle's cameras to understand how features relying on camera detection are affected.

- Attention tracking requires an unobscured view of the driver's face.
 - Improperly stowed items can obscure the view of the driver, as can dust and dirt on the camera lens. Keep the driver's space clean and clutter-free.
 - Wearing certain clothing and accessories can obstruct parts of the driver's face that need to be visible for attention tracking, such as the eyes.
- Dirt in front of the camera can negatively affect its detection capabilities.
- Certain conditions can affect how well your vehicle can assess your driving and maneuvering. This, in turn, affects how well it can distinguish signs of an unfocused or tired driver.
 - Features that help with lane placement can sometimes compensate for maneuvering that would otherwise indicate a lack of driver focus. This makes it harder to identify signs of poor focus compared to unassisted driving.
 - Conditions such as strong winds or uneven road surfaces can affect your driving in ways similar to being unfocused. This can potentially cause warnings despite having a fully focused driver behind the wheel.

Important

Affecting the system

Do not cover the camera. The camera can be fully or partially obscured by objects hung or placed on the rear-view mirror. If the camera is obscured or covered, your vehicle can notify you with a message in the driver display.

Do not intentionally try to trick the driver behavior detection system. The system is there to keep driving as safe as possible. By limiting the system's ability to detect a dangerous situation, you also limit its ability to perform a safety intervention.

10.4. Safety interventions and warnings

Your vehicle has features that directly or indirectly help prevent collisions. If your vehicle detects a dangerous traffic situation, it can intervene by warning the driver or performing an evasive driving maneuver.

Safe driving begins with good user practices. As an additional level of protection against incidents, your vehicle can warn you if it detects a situation that requires your immediate attention or action. In addition to making the driver aware through warnings,

The content of this manual represents the status of the user manual at the time of printing and may not be completely valid in future instances. For more information refer to the first page for the complete disclaimer note.

the vehicle can intervene by steering or braking to avoid or mitigate a collision.

Features that are designed to provide warnings or perform interventions in different ways include:

- Collision warnings and mitigation
- Lane keeping aid
- Blind spot information
- Driver focus and alertness notifications^[1]
- Alerts about traffic crossing behind the vehicle when reversing^[2]
- Automatic braking when reversing^[3]
- Connected Safety



Tip

What are safety interventions?

Safety interventions are responses from the vehicle in situations in which it identifies a high or imminent risk of collision. Warnings can be provided to alert you to hazards so that you can take action, but the vehicle is also capable of performing emergency steering or braking maneuvers depending on the situation. Some types of warnings and interventions are always enabled, while others are part of features that you may be able to customize or choose to turn on or off.

Safety interventions to avoid collisions

When the vehicle identifies a risk of collision, it reacts according to the level of urgency. It can identify objects such as pedestrians, cyclists and vehicles that are approaching or are in your driving path. Many factors can affect how early and effectively the vehicle can detect the risk of an incident. There are situations that are beyond the vehicle's capabilities, which is why safe driving practices are essential.

If the vehicle identifies an increasing risk of collision, alerts can quickly escalate to evasive maneuvers by the vehicle. If a threat appears suddenly, the vehicle can immediately perform evasive maneuvers.

Collision warnings	When the vehicle identifies that there's a risk of collision, the first step is to get the driver's attention. The vehicle can warn you visually, with sound or with brake pulses.
Braking maneuvers	If the vehicle determines that immediate action is required, it can brake independently of the driver's actions. This can occur at the same time as a steering maneuver. The amount the vehicle brakes when intervening depends on the situation. An obstacle that suddenly appears just in front of the vehicle may cause the brakes to be fully applied, whereas another situation might require less braking to avoid a potential collision.
Steering maneuvers	If the vehicle determines that immediate action is required, it can steer independently of the driver's actions. This can occur at the same time as a braking maneuver.

Messages about performed safety interventions are shown in the instrument panel.



Note

Overriding steering and braking interventions

- You can always override the vehicle's steering by intentionally steering the vehicle yourself.
- To override a braking intervention, you must firmly press down on the accelerator pedal. Past a certain threshold, you override the braking action.

Increase responsiveness during evasive maneuvers

In certain conditions, the vehicle can briefly increase its steering responsiveness^[4] if it detects that you are swerving to avoid a collision with an obstacle ahead. You may perceive this as temporarily increased responsiveness and agility. When this happens, a notification also appears in the instrument panel.

Knowing your vehicle's capabilities

Safety interventions by the vehicle can occur suddenly and catch you by surprise. This can cause concern, despite the benefit they provide. The more you know about your vehicle, the less unsettling these safety interventions will feel when they are activated. Be sure to read any notifications following an intervention to better understand why the vehicle intervened.

Reducing the amount of interventions and warnings

The amount of safety interventions and warnings you experience depends on the driving conditions and your driving style. Certain combinations of factors might result in responses you perceive to be unnecessary or too sensitive. In general, the most effective way to reduce the amount of warnings and interventions is to drive responsibly. Adapt your speed to the driving conditions and keep a safe distance to other vehicles. You can also adjust or turn off certain features in settings.

Balancing the need for responses

When the vehicle suggests, guides or performs a driving action, it is considered a response. Most driver support features have some set of possible responses. For instance, automatic braking to prevent a collision with a vehicle that suddenly brakes in front of you is a response. Features that can provide you with warnings and safety interventions are designed to limit unnecessary responses.

Your vehicle's responses each have their own set of conditions. These conditions may be related to the traffic situation, the state of the vehicle and driver, and information collected using the vehicle's detection systems. For a response to occur, all of the required conditions must be met, and the vehicle must have a high certainty that the response is needed. As a situation develops, the vehicle continuously evaluates the conditions and the need for a response. If the response need or conditions are uncertain, then the vehicle won't respond.

If you are able to address a potentially hazardous situation yourself, it is better for you to respond than to depend on a response from the vehicle. The vehicle can delay or avoid providing a response in situations where you have the opportunity to address it using non-emergency maneuvering. This helps reduce unnecessary warnings and safety interventions. You can address most potential hazards that the vehicle identifies through minor adjustments well ahead of the need for emergency evasive maneuvering. In most instances, you will perceive these as routine actions that are part of normal driving.

 **Important**

Always address driving hazards

The vehicle can and will compensate for some instances where you are unable to or fail to respond to a driving hazard, but it will not be able to handle every situation. There are situations where an effective response is beyond the capabilities of the vehicle, as well as situations where the vehicle does not respond because it expects the driver to address the potential hazard. When driving, you must stay alert and attentive so that you can respond to hazards just like you would driving a vehicle without driver support features.

Conditions and limitations

 **Warning**

Never rely on the vehicle's safety interventions as a replacement for safe driving practices. Drive the vehicle with the same attention to safety as you would need to in a vehicle without these features.

Warnings and interventions cannot be guaranteed in any situation. The vehicle cannot handle all driving, traffic, weather and road conditions. Failure of the vehicle to detect or respond to a hazard can happen for reasons that you may not be able to identify or predict.

The vehicle's ability to respond to hazards varies depending on many factors. Many of them fall into the following categories:

- Your vehicle's speed and movement.
- Size, shape, speed and movement of objects or road users around the vehicle.
- Environmental conditions.
- The condition of the driving infrastructure.
- The complexity of the traffic situation.

Notable examples:

- Sharp turns can cause detection to become less consistent. The vehicle might be unable to identify hazards that appear suddenly as a result of turning sharply.
- Low traction, such as when the road is wet or icy, can reduce the effectiveness of interventions.
- Conditions and limitations affecting obstacle detection can prevent the vehicle from accurately identifying potential hazards. Obstacle detection limitations are described in detail in the separate manual section about how the vehicle detects the surroundings and traffic.
- The vehicle won't perform automatic braking interventions if you are driving forwards at or below walking pace. This is to avoid unwanted braking interventions when you are maneuvering in tight spaces.

Important

General limitations

You have good reason to feel safe in a vehicle capable of intervening in dangerous situations, but it's important to still do your best to drive safely and responsibly. The vehicle's capabilities are always limited by technological factors and constraints, vehicle condition and the driving environment.

Detection capabilities

The vehicle's ability to monitor its surroundings is used by features that can provide warnings and interventions. To better understand the limitations of such features, read the separate section about detection of traffic and surroundings. It provides an overview of how important components work, such as cameras and radar units, detailing both capabilities and limitations.

Reaction times

In favorable conditions, the vehicle can perceive and react to certain hazards: in some cases, faster than a human driver can. However, this capability is not a guarantee of intervention, as the vehicle cannot detect all potential hazards that may require a response.

Availability of responses

All of the vehicle's response types have their own set of conditions that define when they are available. This means that the available responses change continually as you drive. Certain conditions are strictly defined, such as an exact speed range, a setting being enabled or the driver wearing their seat belt. Other conditions have more imprecise thresholds that can depend on a combination of factors. This means that you cannot know for certain whether the vehicle will respond in a given situation, or how, but you can develop a sense of what responses are likely or not.

Read everything about the features you use

It is recommended that you read all information about driver support features before using them. It's essential to understand both their capabilities and limitations.

Wear your seat belt

Emergency braking interventions can occur even if the driver is not wearing their seat belt. The risk of injury from hard braking rises significantly for unrestrained occupants. Always wear your seat belt and make sure that any passengers also wear theirs.

Driver responsibility

Features that provide interventions and warnings are supplements to safe driving practices. They do not reduce or replace the need for the driver to stay attentive and focused on driving safely. The section covering driver responsibility is essential reading to understand the limitations of safety interventions and warnings. If you find anything unclear or have further questions, do not hesitate to contact your Volvo retailer.

^[1] Driver Alert

^[2] Cross Traffic Alert

^[3] Rear Auto Brake

^[4] Steering responsiveness is increased by making the steering wheel easier to turn and applying differential braking.

10.4.1. Collision warnings and mitigation

Your vehicle has warning features designed to reduce the risk of a collision. If a collision cannot be avoided, early warning and response can help reduce its effects.

Collision warning features include:

- Forward collision warnings
- Warnings about vehicles cutting across your lane

Note

Safety interventions

If a sufficiently urgent risk of collision is identified, the vehicle can intervene to avoid or mitigate the collision without any preceding collision warnings. In this case, the warnings will be shown at the same time as the intervention.

Warning

Never rely on collision warnings or safety interventions by the vehicle as a replacement for safe driving practices. Drive the vehicle with the same attention to safety as you would need to in a vehicle without these features.

Forward collision warnings

Forward collision warnings can occur if you are getting too close to a vehicle in front of you. The vehicle warns you if it identifies a collision risk that requires your immediate attention.

Warnings about vehicles cutting across your lane

Your vehicle can warn you if you are about to be cut off, such as when a vehicle changes lanes just in front of you. Vehicles that swerve or move unpredictably in adjacent lanes can trigger these warnings as well. Your vehicle uses messages in the instrument panel to warn you in these situations.

Note

Collision response

If a collision cannot be avoided, the vehicle can respond in other ways to protect occupants and reduce the danger to surrounding traffic. Read more about these features in the safety section of this manual.

10.4.2. Interventions and warnings when reversing

Your vehicle has specialized features that can intervene and help prevent collisions when you are reversing at low speeds, such as when parking.

Forms of detection

The vehicle has several ways to identify objects that are in or approaching your reversing path. If it detects an object, the vehicle can provide warnings or intervene by braking.

Parking sensors These sensors can identify certain obstacles immediately behind the vehicle when reversing at low speeds.

Rear-facing radar The vehicle's rear radar can detect traffic approaching your reversing path from the sides.

Camera detection Certain features may use camera detection to help identify obstacles when reversing.

Important

These types of detection have limitations and cannot detect all obstacles in every situation. Be sure to read the separate manual sections about their conditions and limitations.

When you are reversing, some information from the detection systems can be communicated in the parking view.

Warning and intervention features

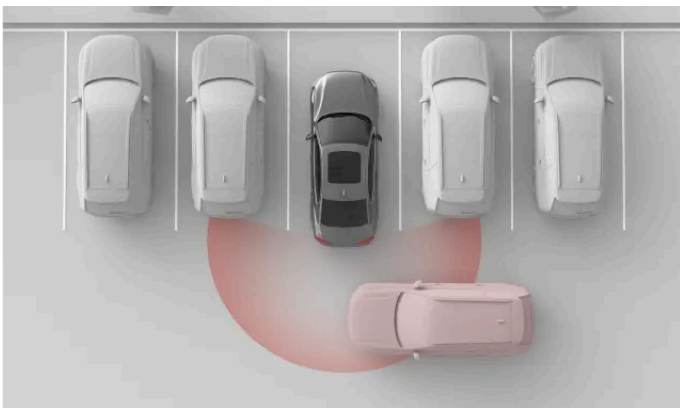

The following features are designed to react when the vehicle identifies a risk of collision when reversing.

Alerts about traffic crossing behind the vehicle^[1] Your vehicle can provide visual and audible alerts if it detects traffic about to cross your reversing path.

Automatic braking when reversing^[2] The vehicle can automatically brake to prevent a collision when reversing. This can happen if it detects an obstacle or crossing traffic behind the vehicle.

Assisted parking audible alerts Your vehicle can provide visual and audible alerts if it detects objects in, or close by, your reversing path.

Tip

Temporary deactivation

Assisted parking audible alerts and rear auto brake can be temporarily turned off if the interventions are too frequent or distracting. For example, reversing in tall grass or maneuvering in very tight spaces can cause unwanted warnings or braking interventions.

 **Important**

Use responsibly

Warnings and interventions when reversing are supplements to safe driving practices. They do not reduce or replace the need for the driver to stay attentive and focused on driving safely.

Pay attention to surroundings

The driver is always responsible for paying attention to the vehicle's surroundings and ensuring that it is safe to maneuver the vehicle.

Speed conditions

Rear auto brake is available when you are reversing at speeds below 10 km/h (6 mph), while cross traffic alerts are available when you are reversing at speeds below 15 km/h (9 mph).

Detection conditions

Detection of traffic or obstacles behind the vehicle relies on detection by the rear radars and the parking sensors. Be sure to read the separate section about the limitations of radar detection.

If the vehicle deactivates the rear radars or the parking sensors, the Cross Traffic Alert and rear auto brake features are automatically disabled. This happens if a trailer is connected. Towbar-mounted accessories that are not connected electrically to the vehicle does not disable the rear radar units but can obstruct them.

^[1] Cross Traffic Alert (CTA)

^[2] Rear Auto Brake (RAB)

10.4.2.1. Alerts about traffic crossing behind the vehicle

When you're reversing at low speed, the vehicle can warn you if it detects traffic about to pass behind you. This feature is called Cross Traffic Alert.

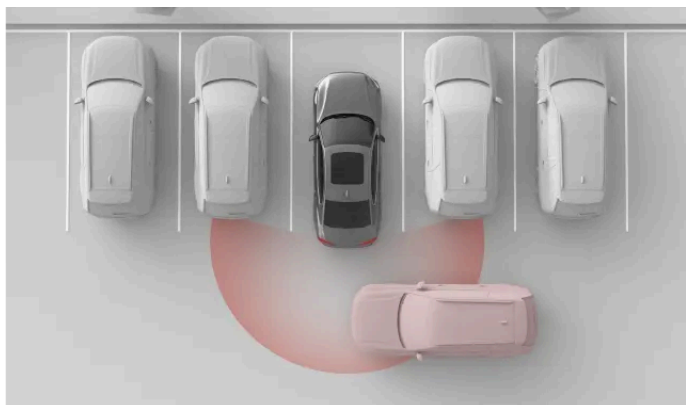

Your vehicle can detect a vehicle crossing behind you: for example, when reversing out of a parking spot. This allows it to warn you so that you can slow down or brake.

Alerts about traffic crossing behind the vehicle are only available when the vehicle is in reverse (R) or rolling backwards in neutral (N). This feature uses the rear radar to detect traffic. When it detects a moving vehicle, an alert appears in the center display along with a warning sound.

This feature is primarily designed for detecting larger vehicles in motion, such as cars. In favorable conditions it may also be able to warn you of smaller moving objects, such as cyclists and pedestrians.

! Important

Driver responsibility

Alerts about traffic crossing behind are a supplement to safe driving practices. They do not reduce or replace the need for the driver to stay attentive and focused on driving safely.

i Note

Automatic braking for crossing traffic

If automatic braking^[1] is enabled, the vehicle may also intervene by braking to prevent or mitigate an imminent collision with traffic detected behind you. Automatic braking can be enabled or disabled in the center display.

Detection zones

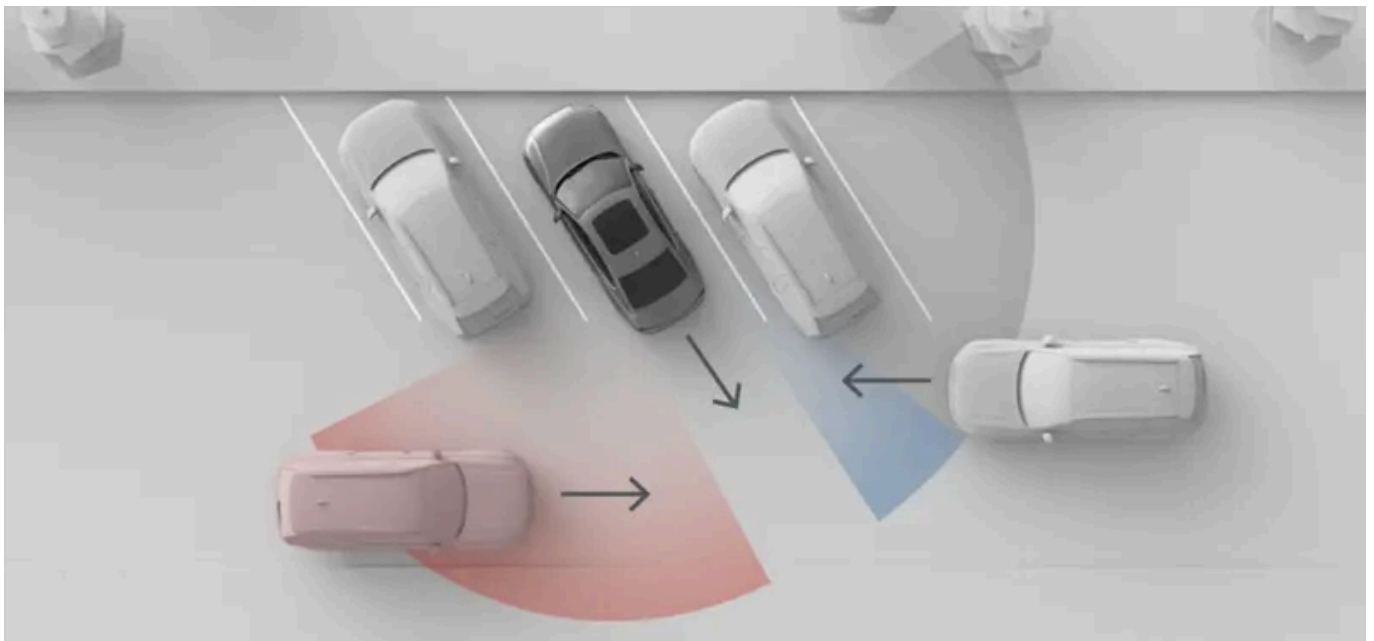

The situation in this image illustrates how surrounding objects such as parked vehicles can limit the vehicle's ability to detect other vehicles and traffic situations. In a situation without obstacles, the effective detection zones are the same on both sides.

 **Note**

Backing out of a parking space

When parked, your rear corner radars' side views might be obstructed, which affects detection of crossing traffic. This happens when you are parked with the back corners of your vehicle further forward in the space than adjacent vehicles or other objects. This effect is particularly noticeable in angled parking spaces. However, as you back out of a parking space, the radar units gradually increase their view, making detection possible. To minimize the risk of delayed or no detection when backing out of a parking space, go slowly.

Conditions and limitations

- The alerts are only available when reversing at speeds below 15 km/h (9 mph).
- If the vehicle deactivates the rear radar units, this feature is automatically disabled. This happens if a trailer is connected. Towbar-mounted accessories that are not connected electrically to the vehicle does not disable the rear radar units but can obstruct them.
- Detection of traffic behind the vehicle relies on detection by the rear radar. Be sure to read the separate section about the limitations of radar detection.

^[1] Rear Auto Brake (RAB)

10.4.2.2. Disabling automatic braking when reversing

The rear auto brake can be temporarily disabled in the parking view.

When you disable the rear auto brake you cancel your vehicle's ability to perform braking interventions when you are reversing. Disabling the rear auto brake is only temporary. By default, the feature will reset to enabled between drives.

 **Important**

Changing driver support settings

Make sure that you understand how changing your vehicle's settings affects its behavior. It is particularly important when it comes to features that affect the level of assistance the vehicle can provide.

1. In the parking view, press the rear auto brake button.



- > Automatic braking when reversing is temporarily disabled.

10.4.3. Lane keeping aid

The lane keeping aid helps prevent accidental high-speed lane departures by providing warnings and steering interventions.

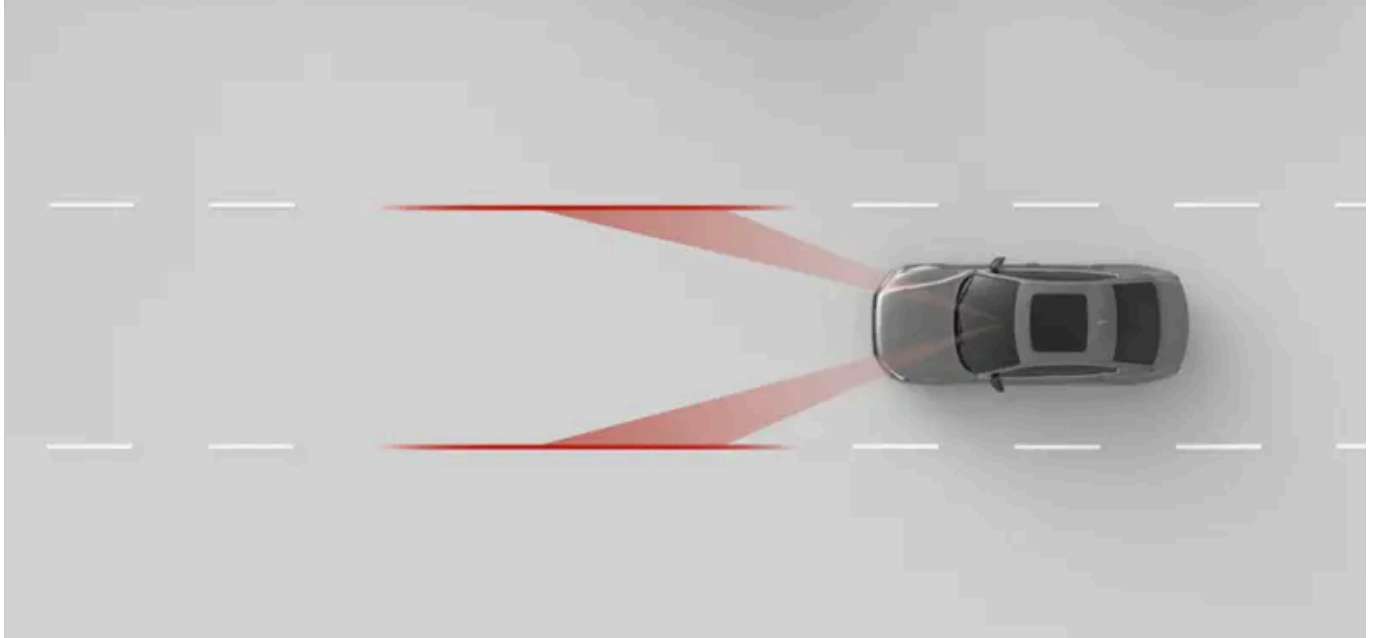

When lane keeping aid is enabled, the vehicle can alert you if you are about to drift out of your lane, and it can ask you to steer the vehicle with attention. It can also perform steering interventions. The lane keeping aid relies on the vehicle's forward-facing camera to identify road markings and your position in the lane.

Warning

Lane keeping aid warnings and interventions are supplements to safe driving practices. They do not reduce or replace the need for the driver to stay attentive and focused on driving safely. Drive the vehicle with the same attention to safety as you would need to in a vehicle without the ability to intervene.

Main conditions for lane keeping aid

For lane keeping aid to work, several conditions need to be met. The following are the most essential:

- Your speed must be between 65 and 200 km/h (40-125 mph).
- The lane markings must be clearly visible for the vehicle's camera to see.
- The lane must be wide enough. A very narrow lane does not provide enough margin between the vehicle and the road markings.
- You must keep your hands on the steering wheel and actively steer the vehicle.

 **Important**

Steering actively

Never let go of the steering wheel when driving. Do not dismiss the vehicle's requests for you to steer actively and keep your attention on the road.

Lane keeping aid intervention types

If you are about to cross your lane's road markings, your vehicle can warn you or intervene in either or both of the following ways:

Steering intervention The vehicle tries to steer back into the lane.

Lane departure warning The vehicle alerts you using steering wheel vibrations.

 **Note**

Signaling a turn or lane change

As long as you use the turn signals when changing lanes, the vehicle assumes you are making an intentional maneuver.

Cutting a corner

The lane keeping aid may allow you to briefly cut across the lane marker while navigating a sharp corner.

Hands on the wheel

Lane keeping aid requires you to keep your hands on the steering wheel. This is continuously monitored by the vehicle. If the vehicle detects that your hands are not on the steering wheel for a prolonged period of time, it may notify you with a sound, along with a message in the instrument panel.

Safety interventions are always enabled

Some situations can cause a steering intervention to prevent a dangerous lane departure even if lane keeping aid is turned off in settings.

Display symbols and communication

Lane keeping aid warnings and interventions are communicated in the instrument panel.



This symbol appears if you are coming too close to the lane markings.



Lane keeping aid is active and the lane markings are visible to the vehicle.



Lane keeping aid is enabled in settings but temporarily unavailable because the vehicle cannot detect any lane markings.

Road marking conditions and limitations

For lane keeping aid to work, road markings must be present and visible. The vehicle identifies them using a forward-facing camera. This form of detection requires the camera view to be unobstructed and the conditions for visual detection to be present. Read the separate section about the conditions and limitations of your vehicle's cameras to understand how features relying on camera detection are affected.

The appearance, condition and layout of road markings can affect their detection in the following ways:

- Lane splits and merges can cause temporary misidentification of the lane.
 - Non-standard or unusual road marking layouts might not be identified correctly by the vehicle. For example, road work or traffic diversions can result in conflicting or multiple sets of road markings.
 - The vehicle may be unable to detect deteriorated road markings: for example, if they are worn, misshapen or discolored.
 - Other edges or lines can be misidentified as road markings, such as curbs, road surface repair edges, barriers or well-defined shadows.
 - Road markings must be sufficiently illuminated to be detected. In low-light conditions, they need to be illuminated by the vehicle or street lights.
-

10.4.3.1. Adjusting lane keeping aid

You can enable, adjust or disable lane keeping aid in settings.

When lane keeping aid is enabled, the vehicle can alert you or intervene by steering if you are about to drift out of your lane. You can also adjust the vehicle's response to lane departures.

The available settings are:

Vibration The steering wheel vibrates if you drive too close to or over the lane markings.

Steering and vibration In combination with steering wheel vibrations, your vehicle will try to steer you back into your lane if you drive too close to or over the lane markings.

You can temporarily disable lane keeping aid if it interferes too much with your driving. This can be useful if the road markings are partially obscured or faded, which can cause unwanted warnings.

Disabling lane keeping aid is only temporary, as this setting automatically resets to enabled between drives.

Important

Changing driver support settings

Make sure that you understand how changing the vehicle's settings affects its behavior. It is particularly important when it comes to features that affect the level of assistance the vehicle can provide.

1. Press the vehicle symbol  in the bottom bar and go to **Settings**.
2. Go to **Driving** → **Safety assistance** → **Lane keeping aid**.
3. Enable or disable lane keeping aid.
4. After enabling lane keeping aid, you can adjust the vehicle's response to lane departures.

10.4.4. Blind spot information

The blind spot information feature helps increase your awareness of vehicles in or approaching your blind spots. A light appears in the door mirror when a vehicle is detected.

Blind spot alerts can increase your awareness of vehicles to the side of your vehicle, which can help you avoid making dangerous lane changes. The alerts primarily appear as a light in the door mirror on the side of detection. They rely on your vehicle's rear radar units for detection of vehicles in adjacent lanes.

Traffic situations in which blind spot alerts appear include:

- When you are being overtaken by another vehicle.
 - In some cases, they can appear before the passing vehicle reaches your blind spot. This happens if a vehicle is approaching quickly from behind in an adjacent lane.

The content of this manual represents the status of the user manual at the time of printing and may not be completely valid in future instances. For more information refer to the first page for the complete disclaimer note.

- When you are overtaking another vehicle.

Regardless of the situation, the alert remains as long as the other vehicle is detected to your side.

If you start signaling a lane change while an alert is being shown, the alert will intensify.

Alerts in the door mirrors



When a vehicle is detected in or approaching your blind spot, a light appears in the door mirror.

Detection areas

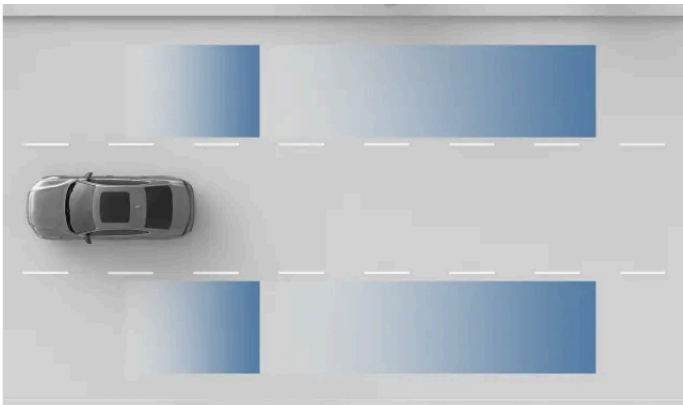

Radar detection areas.

Important

The detection areas may not perfectly cover your own blind spots. Be sure to adjust your driving posture to allow for a good overview of surrounding traffic.

Conditions and limitations

- Blind spot information is active at speeds above 12 km/h (7 mph). It is not available when reversing.
- When passing other vehicles, the speed difference between your vehicle and the other vehicles must be below 15 km/h (9 mph) for the alerts to appear.
- Blind spot information relies on detection by the rear radar units. Be sure to read the separate section of this manual about the limitations of radar detection.

The content of this manual represents the status of the user manual at the time of printing and may not be completely valid in future instances. For more information refer to the first page for the complete disclaimer note.

- If the rear radar units are obstructed, such as by an attached trailer or mounted bike rack, blind spot alerts are automatically disabled.

 **Important**

Driver responsibility

Alerts about vehicles in the blind spots are a supplement to safe driving practices. They do not reduce or replace the need for the driver to stay attentive and focused on driving safely.

The lack of a blind spot indication is not a confirmation that it is safe to change lanes. It is one of several pieces of information that inform your assessment of whether it is safe to proceed.

10.4.5. Driver alert

The vehicle continuously assesses your behavior while driving and can notify you if you seem unfocused. A lack of focus can be caused by distractions or being tired.

If the vehicle identifies signs of reduced driver focus, it will notify you with a sound and a message.

The vehicle uses different methods to assess your focus when driving.

Attention tracking Camera tracking of your face and eye movements allows the vehicle to determine where you are directing your attention.

Maneuvering Analyzing the way you maneuver the vehicle can provide an indication of lacking focus. One example of this is excessive lane drifting.

Distraction alert

Your level of attentiveness while driving is continuously monitored by your vehicle's internal camera. If you seem inattentive or distracted, the vehicle can alert you of this via sound and messages in the driver display.



Distraction alert notifications are on by default for each new driving cycle and can be temporarily disabled in settings or quick controls.

Alerts about a tired or drowsy driver

Your vehicle monitors certain aspects of your driving as well. Certain driving patterns, such as excessive lane drifting, may provide indications that the driver is tired or drowsy.

If the vehicle identifies signs of tiredness or drowsiness, it will notify you with a sound and a message in the instrument panel. If you ignore the message and continue to behave similarly, the warnings will escalate. These alerts cannot be disabled.





Warning

The importance of a well-rested driver

Take any notifications about signs of driver tiredness seriously, as a tired driver is often unaware of their condition. If you feel tired or get an alert about it from the vehicle, stop as soon as possible in a suitable location for a rest. Always plan for regular breaks and start all trips with a well-rested driver.

Driving while tired is comparable to driving under the influence of alcohol.

Conditions and limitations

Distraction alert is activated when your driving speed exceeds 20 km/h (12 mph).

Alerts about a tired or drowsy driver are first activated when your driving speed exceeds 65 km/h (40 mph) but will remain active as long as your speed remains above 60 km/h (37 mph).

- Attention tracking requires an unobscured view of the driver's face.
 - Improperly stowed items can obscure the view of the driver, as can dust and dirt on the camera lens. Keep the driver's space clean and clutter-free.
 - Wearing certain clothing and accessories can obstruct parts of the driver's face that need to be visible for attention tracking, such as the eyes.
- Certain conditions can affect how well your vehicle can assess your driving and maneuvering. This, in turn, affects how well it can distinguish signs of an unfocused or tired driver.
 - Features that help with lane placement can sometimes compensate for maneuvering that would otherwise indicate a lack of driver focus. This makes it harder to identify signs of poor focus compared to unassisted driving.
 - Conditions such as strong winds or uneven road surfaces can affect your driving in ways similar to being unfocused. This can potentially cause warnings despite having a fully focused driver behind the wheel.

Read the separate section about conditions and limitations of your vehicle's driver behavior detection system and cameras to understand how features relying on these systems are affected.



Important

Driver responsibility

Alerts about poor focus when driving are a supplement to safe driving practices. The driver is fully responsible for making sure they are able to stay alert and maintain focus when driving.

10.4.5.1. Disabling distraction alert notifications

You can enable or temporarily disable distraction alert notifications in settings and quick controls.

Disabling distraction alert notifications is only temporary as this setting automatically resets to enabled between drives.

You cannot disable alerts concerning driver tiredness or drowsiness.

 **Warning**

The importance of a well-rested driver

Take any notifications about signs of driver tiredness seriously, as a tired driver is often unaware of their condition. If you feel tired or get an alert about it from the vehicle, stop as soon as possible in a suitable location for a rest. Always plan for regular breaks and start all trips with a well-rested driver.

Driving while tired is comparable to driving under the influence of alcohol.

 **Note**

Driver responsibility

Alerts about poor focus when driving are a supplement to safe driving practices. They do not reduce the driver's responsibility to continuously assess whether they are too tired or unfocused to drive safely.

 **Tip**

Quick access

A button for turning distraction alert notifications on or off is also available in quick controls in the center display. This allows you to quickly manage distraction alert notifications without going into settings.

1. Press the vehicle symbol  in the bottom bar and go to **Settings**.
2. Go to **Driving** → **Safety assistance** → **Distraction alert**.
3. Turn distraction alert notifications on or off.

10.4.6. Connected safety

Your vehicle can communicate information with other vehicles on the road, which can help you to be aware of or avoid accidents or traffic jams further up the road. This feature is called connected safety.

Through an internet connection, your vehicle and other vehicles on the same road can share information about accidents, slippery road conditions and other situations that may cause the hazard warning lights to activate.

Connected safety can be enabled or disabled in privacy settings.

 **Warning**

Never rely on the vehicle's connected safety warnings as a replacement for safe driving practices. Drive with the same attention to safety that you would need in a vehicle without this feature.

Connected safety warnings

Depending on the nature of the information your vehicle receives from other road users, one of these two symbols may be shown in the instrument panel:



A vehicle's hazard warning lights have been activated further up the road.



Slippery road conditions are detected further up the road.

Conditions and limitations

Connected safety relies on communication between your vehicle and other vehicles on the road. This communication relies on a number of conditions, such as:

- The connected safety feature must be enabled in settings.
- Connected safety must be available to the other road users.
- The vehicles involved must be connected to the internet. If the internet connection is weak or unavailable, the feature is disabled until the connection improves.
- The road you're on is in the Volvo Cars database.

 **Note**

A slippery road may not always result in a warning from connected safety, as your vehicle or other connected road users may not experience problems with slippage despite these conditions. Low-friction situations between the tires and road surface are often used as markers to identify slippery roads. Low-traction maneuvers, such as slight steering, braking or acceleration, rarely cause low-friction situations. Therefore, it might prove difficult to identify the road as slippery during such maneuvers.

10.4.6.1. Enabling connected safety

You can enable or disable connected safety in settings.

Connected safety can warn you of upcoming situations on the road you're on, such as another vehicle with their hazard warning lights activated or slippery road conditions. The feature relies on communication with other road users via internet connection.

 **Important**

Changing driver support settings

Make sure that you understand how changing your vehicle's settings affects its behavior. It is particularly important when it comes to features that affect the level of assistance the vehicle can provide.

If you are logged in to a guest profile, you first need to switch to an owner or co-driver profile. Press the vehicle symbol  in the bottom bar and go to **Settings**. Go to **Profiles** and select your profile.

1. Press the vehicle symbol  in the bottom bar and go to **Settings**.
2. Go to **Privacy** → **Volvo privacy settings** → **Connected safety**.
3. Enable or disable connected safety.

10.4.7. Ready to drive notification

When traffic is at a standstill, your vehicle can notify you if the vehicle in front has started moving. This feature can be enabled or disabled in settings.

When the vehicle notices that traffic in front of you has started moving, it notifies you with a sound and a message in the instrument panel.

If the vehicle detects pedestrians or cyclists close to the vehicle, the ready to drive notification might not be given.

 **Warning**

The notification does not indicate that it is safe to drive, only that traffic has started moving. The driver is always responsible for determining if it is safe to start driving.

Conditions and limitations

The ready to drive notifications system relies on camera and radar detection. The cameras and radars used by the notification system have limitations that can affect the system's detection capabilities. Read the separate sections about the conditions and limitations of camera and radar detection to understand how features relying on these kinds of detection are affected.

10.4.7.1. Enabling ready to drive notification

You can enable or disable ready to drive notifications in settings.

When traffic is at a standstill, your vehicle can notify you if the vehicle in front has started moving. You can enable or disable this feature in settings.

 **Warning**

The notification does not indicate that it is safe to drive, only that traffic has started moving. The driver is always responsible for determining if it is safe to start driving.

1. Press the vehicle symbol  in the bottom bar and go to **Settings**.
2. Go to **Driving** → **Safety assistance** → **Ready to drive notification**.
3. Enable or disable the notifications.

10.5. Assisted driving

Assisted driving features use the vehicle's ability to monitor its surroundings to make driving safer and less demanding.

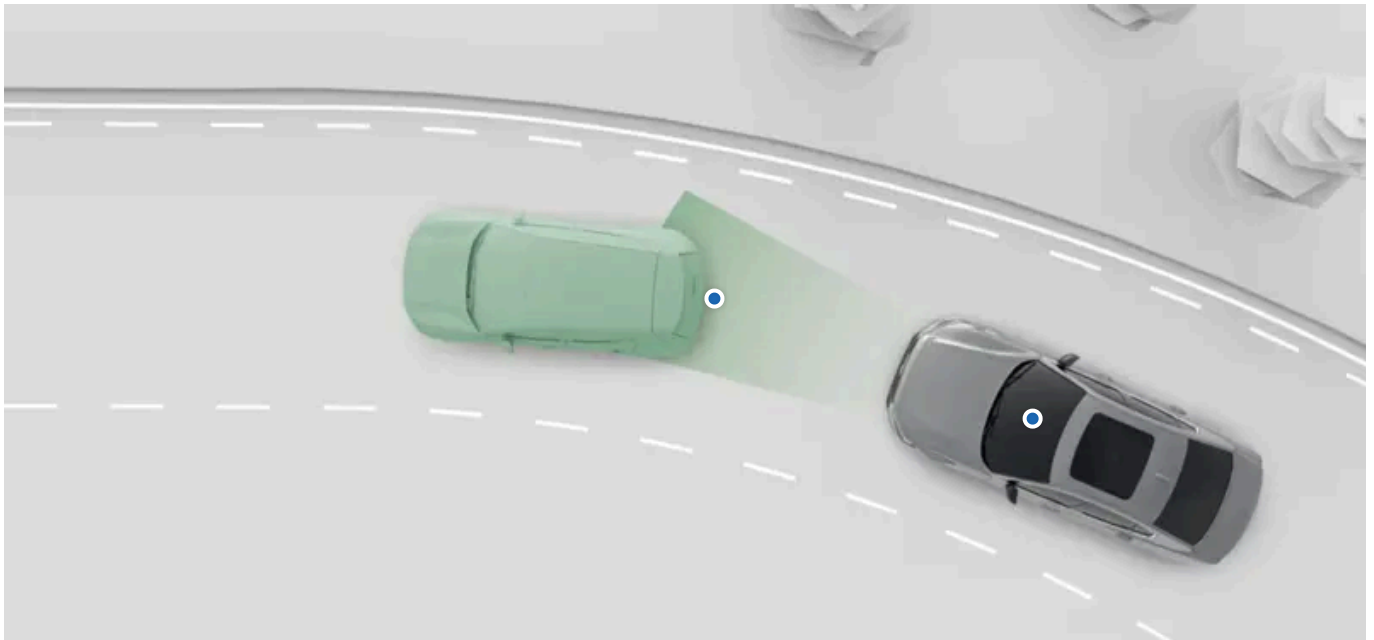

There are several forms and levels of assistance. They can actively assist you with a number of driving tasks and provide informational support for better driver decision-making.

You can enable, disable or customize many of your vehicle's assisted driving features in settings.

Pilot Assist This feature can assist you in several driving tasks, such as steering and managing speed. Pilot Assist can be customized in settings.

Road signs and speeding response Several features can assist you with keeping track of the speed limit and preventing unintentional speeding. They include road sign information, which makes you aware of the speed limit, and different responses from the vehicle designed to prevent you from exceeding the speed limit. These features can be customized in settings.



Tip

Safety interventions and warnings

Many of the driver support features are designed to improve both convenience and safety. Features that primarily provide safety interventions and warnings have their own, separate section in this manual.

Assisted parking

There is a separate section of this manual covering assisted parking features.



Important

Required knowledge and driver responsibility

Assisted driving features are designed to make driving safer and less demanding, but they do not reduce the driver's responsibility to operate the vehicle as safely as possible. Be sure to read all related information about a feature before using it. The section covering driver responsibility is essential reading to understand the capabilities and limitations of your vehicle's assisted driving features.

If you find anything unclear or have further questions, do not hesitate to contact an authorized Volvo workshop.

Detection capabilities

The vehicle's ability to monitor its surroundings is used by assisted driving features. To better understand the limitations of such features, read the separate section about detection of traffic and surroundings. It provides an overview of how important components work, such as cameras and radar units, by detailing both capabilities and limitations.

10.5.1. Road signs and speeding response

Several features can assist you with keeping track of the speed limit and preventing unintentional speeding.

To help you maintain a legal speed, your vehicle is designed to make you aware of the current speed limit by showing it in the instrument panel. It can also respond with warnings if you exceed the speed limit.

Road sign information The vehicle can detect and display information from road signs, such as the speed limit.

Speed limit warnings This feature will warn you visually in the instrument panel if you exceed the speed limit.

Sound alerts for upcoming speed cameras. An audible alert indicates when the vehicle detects that the speed limit has changed.



Important

Speed-related information and warning features are supplements to safe driving practices. They do not reduce or replace the need for the driver to stay attentive and focused on driving safely. It is the driver's responsibility to observe and maintain a legal and safe speed.

The content of this manual represents the status of the user manual at the time of printing and may not be completely valid in future instances. For more information refer to the first page for the complete disclaimer note.

10.5.1.1. Speed limit warnings

Speed limit warnings can be provided to help prevent unintentional speeding.

Your vehicle can give you speed limit warnings when you exceed the speed limit. The warnings appear visually in the instrument panel and consists of a flashing road sign symbol showing the current speed limit.

You can disable these warnings by turning road sign information off in settings.

Conditions and limitations

Speed limit warnings use road sign information to keep track of the speed limit. If information about the speed limit is unavailable for some reason, no warning can be provided.

Important

Driver responsibility

Speed limit warnings are supplements to safe driving practices. They do not reduce or replace the need for the driver to stay attentive and focused on driving safely. It is the driver's responsibility to observe and maintain a legal and safe speed.

10.5.1.1.1. Disabling speed limit warnings

Speed limit warnings can be enabled, disabled and customized in settings.

You can disable the speeding responses from ISA for exceeding the speed limit.

1. Press the vehicle symbol  in the bottom bar and go to **Settings**.
 2. Go to **Driving** → **Safety assistance** → **Road sign information**.
 3. Disable road sign information.
- > Speed limit warnings will not occur for the rest of your drive.

Note

Disabling road sign information also means that road signs will not be displayed in the instrument panel.

10.5.1.2. Enabling sound alerts for speed cameras

Your vehicle can alert you of upcoming speed cameras.

Alerts for upcoming speed cameras can be shown in the instrument panel along with a sound.

1. Press the vehicle symbol  in the bottom bar and go to **Settings**.
2. Go to **Driving** → **Safety assistance** → **Speed camera audio warning**.

 **Note**

Road sign information must be enabled to access the settings for speed camera alerts.

3. Enable or disable the sound alerts for upcoming speed cameras.

 **Note**

The availability of this feature may differ between regions.

10.5.1.3. Road sign information

The vehicle can identify and display road signs as you pass them, allowing you to keep track of the speed limit. This feature combines direct detection of signs with sign information from map data.

The signage symbols shown in the instrument panel come from two different sources: real-world signs identified by the camera and map data. The vehicle automatically prioritizes which source to use depending on the situation.

The vehicle can only show signs that are part of the vehicle's sign library.

You can enable or disable road sign information in settings.

How signs are shown

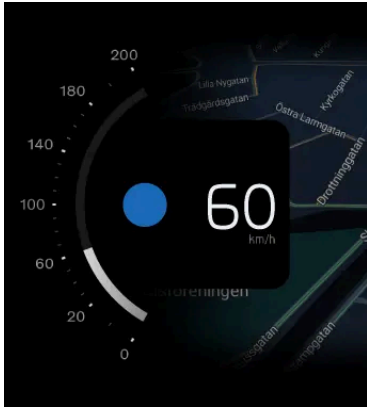



How the road sign symbols appear may depend on the current instrument panel mode.

The vehicle can simultaneously display several sign types. This can include the current speed limit and an upcoming speed limit, as well as a warning sign or an additional traffic information sign.

Displayed road signs

This list contains examples of road sign types that can be shown in the vehicle.

-  Speed limit
-  No entry
-  Upcoming speed camera

Note

Symbol availability

Road signs available to display in your vehicle can change over time and vary between regions. The selection presented in this manual may not include every sign that can appear in your vehicle's display.

Symbol design

Road sign styles vary between regions. The symbol style displayed by the vehicle will not exactly match the symbol style on signs you encounter. If you have any issues interpreting a displayed sign despite the information provided in this manual, contact Volvo support.

Road sign display times

The sign display time typically depends on the type of sign and whether you pass additional signs. Road signs can be shown in the following ways:

- Briefly as one-time alerts after passing a sign.
- Until the sign no longer applies.
- Until you pass another sign with higher display priority.

The content of this manual represents the status of the user manual at the time of printing and may not be completely valid in future instances. For more information refer to the first page for the complete disclaimer note.

 **Note**

Lingering signs

The vehicle might fail to identify a sign indicating the end of a traffic limitation. If this happens, a symbol for the previous limitation can linger in the instrument panel. It will eventually be replaced or canceled. In the meantime, drive according to the applicable rules of the road.

Conditions and limitations

 **Important**

Driver responsibility and road signs

Road sign information is designed to help manage information while driving. It is a supplement to safe driving practices. The driver is fully responsible for remaining attentive, keeping track of road signs and following local regulations. Do not prioritize the vehicle's road sign detection over your own observations if they conflict.

Why all signs are not shown

The vehicle cannot detect and show every sign that is relevant to the driver.

- The system does not support all types of signs.
- Signs may go undetected in certain conditions and traffic situations.

Conditions affecting road sign detection or identification:

- Road sign information must be enabled in settings.
- The vehicle's forward-facing camera must be clean and free of obstructions.
- The road sign must be clearly visible and properly illuminated.
- The road sign must be within a certain distance and within the camera's field of view.
- The vehicle may not be able to identify misaligned road signs, such as signs placed too high or at an angle.
- The vehicle may not be able to identify damaged or worn road signs.

Conditions affecting sign information from map data:

- An internet connection is required to download map data that contains information about road signs.
- The coverage of road sign information from map data varies between regions.

 **Note**

For consistent and up-to-date road sign information in your vehicle, be sure to accept Google's Terms of service. Contact an authorized Volvo workshop if you experience any issues with the road sign information feature.

10.5.1.3.1. Enabling road sign information

1. Press the vehicle symbol  in the bottom bar and go to **Settings**.
2. Go to **Driving** → **Safety assistance** → **Road sign information**.
3. Enable road sign information.

10.5.2. Pilot Assist

Pilot Assist combines several support capabilities to make driving more convenient and less demanding. It can assist you with speed management and steering guidance in a wide variety of situations.

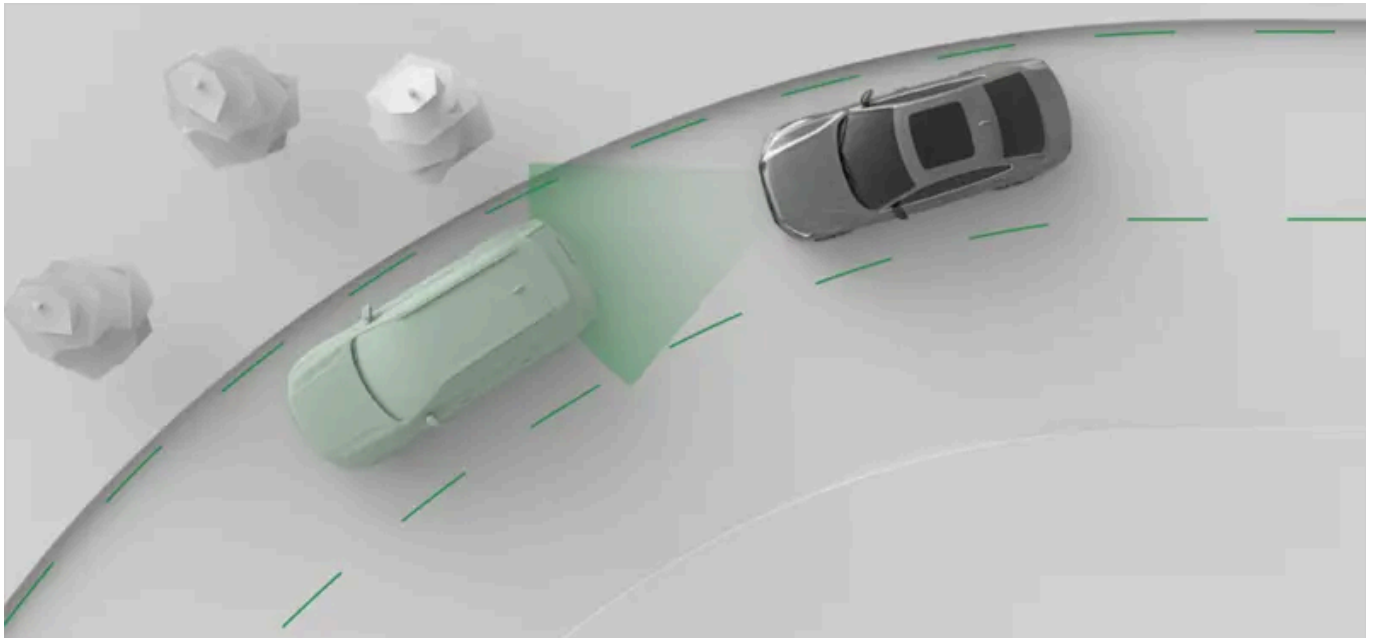

Pilot Assist actively guides your driving in a number of ways. When driving with Pilot Assist, you select the target speed. The vehicle then manages acceleration and braking to meet that target while also adapting to surrounding traffic.

It's also capable of steering assistance. When available, steering assistance helps with road positioning by guiding your steering wheel movement.

 **Important**

Before using Pilot Assist

Take the time to read everything the manual has to say about Pilot Assist before using it. Understanding its capabilities and limitations is necessary for safe use.

The driver is in control

When using Pilot Assist, you are still in control of the vehicle. It's your responsibility to continuously assess Pilot Assist's performance. As long as you judge its input to be correct, you can let it guide your driving.

 **Tip**

Customize Pilot Assist

Some of Pilot Assist's capabilities can be customized either in the Pilot Assist settings or by using the steering wheel buttons. This allows you to set it up for the level of support you want.

Pilot Assist and adaptive cruise control

While your vehicle is equipped with Pilot Assist, you also have access to adaptive cruise control. Adaptive cruise control can be considered a sub-feature of Pilot Assist, providing speed- and distance-keeping but no steering assistance. You can activate and switch between the features using your steering wheel control buttons. The instrument panel typically shows your level of support using symbols ^[1].

 **Important**

Pilot Assist shares most of its conditions and limitations with adaptive cruise control, except the ones connected to steering assistance. When reading the manual and understanding your vehicle's capabilities, you should think about Pilot Assist and adaptive cruise control as similar features.

Managing speed and time interval to vehicles ahead

When you activate Pilot Assist, a set speed value appears next to the speedometer. This represents the target speed that Pilot Assist tries to maintain. You can adjust the target speed with the steering wheel buttons.

If your vehicle detects a vehicle ahead that's either slower than you or a bit too close, Pilot Assist will slow down to maintain a certain distance to the vehicle in front. Once the road ahead becomes clear again, your vehicle returns to the target speed. You can adjust the target time interval to vehicles ahead using the steering wheel buttons.

Steering assistance

The availability of active steering assistance depends on the conditions you are experiencing. For example, if you encounter a stretch of road with worn-out markings, the vehicle may temporarily turn steering assistance off and you must steer the vehicle without assistance from by Pilot Assist. As soon as the necessary conditions are met again, steering assistance reactivates.

Steering assistance is unavailable during lane changes and will temporarily deactivate when you use the turn signals.

 **Note**

Adaptive cruise control

When using adaptive cruise control, your vehicle will not provide any steering assistance^[2].

Pilot Assist features and settings

There are a number of Pilot Assist capabilities and settings to read about in this manual.

Steering assistance	When driving with steering assistance, your steering is actively guided. This can help you maintain correct lane positioning.
Adaptive cruise control	When adaptive cruise control is active, your vehicle manages acceleration and braking to meet your set target speed while also adapting to surrounding traffic. In essence, you can think of adaptive cruise control as being like Pilot Assist without steering assistance.
Target speed	You can adjust the target speed for Pilot Assist using the steering wheel buttons.
Distance keeping	You can adjust your vehicle's general distance-keeping by adjusting the time interval to vehicles ahead using the steering wheel buttons.
Pilot Assist as default	Allows you to activate Pilot Assist as your default assisted driving feature. You can enable or disable this in settings. While driving, you can switch between Pilot Assist and adaptive cruise control using the steering wheel controls.

Status and availability

Pilot Assist's availability depends on the current driving conditions and is indicated in the instrument panel. You can always see the current level of support you're getting from Pilot Assist in the instrument panel.

 **Note**

Pause

In some situations, Pilot Assist can be temporarily paused. This can happen when a driver decision is needed to resume driving with Pilot Assist, such as after coming to a stop. When Pilot Assist is paused, this is communicated in the instrument panel.

^[1] Warnings and messages in the displays may differ depending on the active feature.

^[2] This does not affect the steering capabilities from safety interventions and lane keeping aid.

10.5.2.1. Pilot Assist communication and status

Learn how Pilot Assist's status and actions are communicated in the vehicle.

The instrument panel shows the status of Pilot Assist using graphics and symbols. Important information can also appear as notifications.

Communication with symbols

Pilot Assist's status is communicated using symbols. The symbols show what level of support Pilot Assist is currently providing based on your Pilot Assist settings.



Pilot Assist is active and providing steering assistance.



Pilot Assist is active but steering assistance is temporarily unavailable.



Pilot Assist is active and adapting the driving speed to a vehicle ahead.



Pilot Assist is paused.

When adaptive cruise control ^[1] is active, the symbol communication differs slightly:



Adaptive cruise control is active.



Adaptive cruise control is active and adapting your driving speed to a vehicle ahead.

The target speed appears in yellow above the speedometer.



Notifications and messages

When using Pilot Assist, notifications may appear in the instrument panel. They may contain important information about the status of Pilot Assist features, as well as instructions for you to follow, such as not letting go of the steering wheel.

^[1] a sub-feature of Pilot Assist

10.5.2.2. Activating Pilot Assist

Activate Pilot Assist by pressing the Pilot Assist steering wheel button while driving. It's important to assess whether the current driving conditions allow you to use Pilot Assist safely.

You can activate Pilot Assist either with or without steering assistance. The activation symbol the instrument panel reflects whether your vehicle is assisting your steering or not.

By selecting **Pilot Assist as default** in settings, you ensure that Pilot Assist with steering assistance is your default assisted driving feature and not adaptive cruise control. You can then switch between Pilot Assist and adaptive cruise control using the steering wheel buttons while driving.

! Important

Before using Pilot Assist

Take the time to read everything about Pilot Assist in this manual before using it for the first time. Understanding its capabilities and limitations is important for safe use.

Assess the situation

Make sure the traffic situation and conditions are suitable for activation. Wait until you complete any ongoing maneuvers, such as a lane change, before activating Pilot Assist.

Activating Pilot Assist when driving



When it's safe to do so, press the Pilot Assist button  on the steering wheel.

> Activation is confirmed in the instrument panel.

The first time you activate Pilot Assist during a drive, your speed at the time of activation becomes the target speed.

i Tip

If you recently used Pilot Assist and you want to use your previous target speed, press the resume button  on the steering wheel.

When Pilot Assist is active, you can adjust the target speed and the time interval to vehicles ahead with the steering wheel buttons.

10.5.2.3. Deactivating Pilot Assist

When you want to stop driving with Pilot Assist, you can deactivate it manually. There are also situations in which Pilot Assist deactivates automatically.

Deactivating and activating Pilot Assist is done in the same way. You simply press the Pilot Assist button on the steering wheel. You can also deactivate Pilot Assist by braking.

When you deactivate Pilot Assist, all of its assistance is turned off. This includes speed- and distance-keeping, as well as steering assistance.

Deactivating Pilot Assist using the steering wheel button

- Press the Pilot Assist button  on the steering wheel.
- > Deactivation is confirmed in the instrument panel.

Deactivating by braking

- Press down on the brake pedal.
- > Deactivation is confirmed in the instrument panel.

Note

Automatic deactivation

Pilot Assist has several limitations and only works if all the necessary conditions are met. If the driving conditions change during your drive, Pilot Assist can deactivate automatically.

Examples of scenarios where Pilot Assist may automatically deactivate include instances where:

- You are not driving actively. You must stay attentive and keep both your hands on the steering wheel, even when driving with steering assistance.
- You open a door or unbuckle your seat belt.
- You change gears. Pilot Assist cannot support you in gears N or R.
- You leave the turn signal on for a long time when driving with steering assistance. This can indicate that you are not fully focused.
- You manually speed up and maintain a higher driving speed than the target speed. This indicates that you want to return to full manual control of your vehicle.
- Camera or radar conditions for Pilot Assist are not met.

10.5.2.4. Adaptive cruise control

Adaptive cruise control is a sub-feature of Pilot Assist, sharing the same distance- and speed-keeping capabilities. It cannot provide steering assistance, however.

When using adaptive cruise control, your vehicle will try to maintain your set target speed, as well as your set distance to other vehicles. You can adjust both your target speed and general distance to vehicles ahead using the steering wheel controls.

You can set adaptive cruise control as your default assisted driving feature in settings. This allows you to activate it with the Pilot Assist button  on the steering wheel.

While driving, you can switch between Pilot Assist and adaptive cruise control using the switch button  on the control panel on the left side of the steering wheel.

The status of adaptive cruise control can be communicated with one of these two symbols in the instrument panel:



Adaptive cruise control is active.



Adaptive cruise control is active and adapting your driving speed to a vehicle ahead.

Conditions and limitations

While Pilot Assist can also provide steering assistance, adaptive cruise control cannot. However, you can still get steering interventions from features such as lane keeping aid or in situations causing steering interventions. Conditions and limitations relating to detection capabilities, distance keeping and speed keeping are shared between Pilot Assist and adaptive cruise control. The Pilot Assist conditions and limitations related to steering assistance do not apply to adaptive cruise control because the sub-feature does not provide any steering assistance.

10.5.2.5. Switching between Pilot Assist and adaptive cruise control while driving

You can switch between Pilot Assist and adaptive cruise control while driving.

When switching between Pilot Assist and adaptive cruise control, you enable or disable steering assistance. While adaptive cruise control is considered a sub-feature of Pilot Assist, the main difference is that Pilot Assist can provide steering assistance, while adaptive cruise control cannot. Therefore, switching between the features can be viewed as enabling or disabling Pilot Assist's steering assistance.

 **Important**

While the conditions and limitations are similar between Pilot Assist and adaptive cruise control, it is important to know the differences. Make sure that you understand how switching between assisted driving features affects your driving and the vehicle's behavior.



Press the switch button  on the steering wheel.

> Your selected level of support is shown in the instrument panel.

10.5.2.6. Adjusting the target speed for Pilot Assist

Pilot Assist can support you in maintaining a set target speed. You can adjust the target speed with the steering wheel control buttons.

When you are driving with Pilot Assist active, you can select a target speed. The vehicle then manages acceleration and braking to meet that target while also adapting to surrounding traffic.

You can adjust your target speed by pressing the speed adjustment buttons on your steering wheel's control panel on the left-hand side.

Press once Adjust the target speed by 5 units by pressing the button once.



Press and hold Adjust the target speed by 1 unit continuously by pressing and holding the button.

When you adjust by 5 units at a time, the target speed will default to speed increments that are divisible by five, such as 25, 30, or 35.

1.



Adjust the target speed using the buttons on the steering wheel.

- Press the increase speed button  to increase the target speed.
- Press the decrease speed button  to decrease the target speed.

> Your new target speed is shown in yellow above the speedometer.

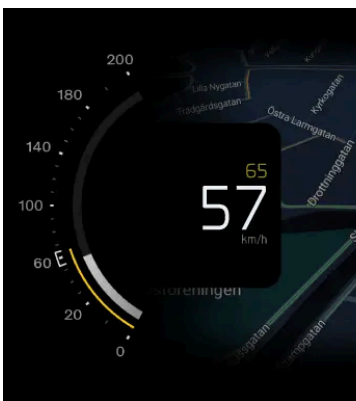



10.5.2.7. Adjusting the time interval to vehicles ahead

Pilot Assist can support you in keeping a set time interval to vehicles ahead. You can adjust the time interval to vehicles ahead, and by doing so the general distance, using the steering wheel control buttons.

When you are driving with Pilot Assist active, your vehicle will try to adapt its driving speed to that of other vehicles. You can adjust your vehicle's general distance-keeping by adjusting the time interval to vehicles ahead using the steering wheel buttons. The vehicle then manages acceleration and braking to maintain that time interval.

Adjust the time interval by pressing the time interval adjustments buttons on the control panel on the left side of the steering wheel.

-  Decrease the target time interval to vehicles ahead.
-  Increase the target time interval to vehicles ahead.

The selected time interval is shown in the time interval indicator in the instrument panel. The time interval indicator is incorporated in the assisted driving symbol and differs depending on your current level of support.



The yellow horizontal lines are what make up the time interval indicator.

When adjusting the time interval to vehicles ahead, the number of lines will either increase or decrease depending on your adjustment. More lines indicate a longer time interval and greater general distance kept to vehicles ahead, while fewer lines indicate a shorter time interval and general distance.



! Important

Changing driver support settings

Make sure that you understand how changing the vehicle's settings affects its behavior. It is particularly important when it comes to features that affect the level of assistance the vehicle can provide.



Adjust the time interval to vehicles ahead using the buttons on the steering wheel.

- Press the decrease time interval button  to decrease the general distance to vehicles ahead.
 - Press the increase time interval button  to increase the general distance to vehicles ahead.
- > Your new target time interval is shown in the time interval indicator in the instrument panel.

i Note

When driving at higher speeds, the general distance to a vehicle ahead will be longer than when driving at lower speeds, even if the target time interval is the same. This is because the calculated distance becomes longer for the given time interval.

10.5.2.8. Selecting Pilot Assist as default driver support

The content of this manual represents the status of the user manual at the time of printing and may not be completely valid in future instances. For more information refer to the first page for the complete disclaimer note.

You can select Pilot Assist as your default assisted driving feature in settings.

1. Press the vehicle symbol  in the bottom bar and go to **Settings**.
2. Go to **Driving** → **Pilot Assist** → **Pilot Assist as default**.
3. Select Pilot Assist as your default.

 **Tip**

After selecting Pilot Assist as your default assisted driving feature, you can activate it with the Pilot Assist button  on the steering wheel while driving.

10.5.2.9. Pilot Assist conditions and limitations

To use Pilot Assist safely, it's important to be aware of its limitations. Although it is an advanced function, there are conditions and situations that it cannot handle.

Driver responsibility when using Pilot Assist

One main limitation of Pilot Assist that you need to be aware of concerns driver responsibility. When using the function, you are still required to actively and attentively drive the vehicle. You are responsible for all decision-making, actions and responses that are part of driving.

Pilot Assist does not know your intentions or the intentions of other drivers. It cannot predict or identify every potentially hazardous situation that an attentive driver can. It's your responsibility to continuously assess Pilot Assist's performance and act if necessary. As long as you judge its input to be correct, you can let it guide your driving.

 **Note**

Adaptive cruise control conditions and limitations

Conditions and limitations relating to detection capabilities, distance keeping and speed keeping are shared between Pilot Assist and adaptive cruise control. The Pilot Assist conditions and limitations related to steering assistance do not apply to adaptive cruise control, as the sub-feature does not provide any steering assistance.

Important

Driving conditions

Assessing Pilot Assist's performance requires that you take all driving, traffic, weather or road conditions into consideration. For example, if visibility is poor, you may need to increase the distance to vehicles ahead compared to the distance kept by Pilot Assist. The same applies to maintaining a speed that is safe for the current road and traffic conditions.

Improved convenience

When used correctly, Pilot Assist can reduce the effort of driving. In some cases, it can compensate for driver errors, such as mistakes caused by lapses of attention or distractions. This potential benefit is a supplement to safe driving practices. It does not reduce or replace the need for the driver to stay attentive and focused on driving safely.

Driver readiness

Using speed- and distance-keeping features can mean you may not use the pedals for long periods of time. However, you must remain prepared and ready to brake or accelerate manually if necessary. Avoid changing your driving posture in ways that can delay your response time.

Eyes on the road

When using Pilot Assist, you must still remain attentive as a driver. This includes keeping track of your surroundings and the traffic around you, just like when driving unassisted.

Hands on the wheel

Pilot Assist can guide your steering, but you are still required to keep your hands on the steering wheel, just like when driving unassisted. As long as you believe the steering input is correct, you can let Pilot Assist guide your steering.

Emergency stop with Pilot Assist

The vehicle can initiate a controlled stop if the driver doesn't respond to requests to actively drive the vehicle and keep their hands on the steering wheel. During the stopping maneuver, the vehicle utilizes all of the information it continuously collects about its surroundings to come to a controlled stop in the lane of the road you're on. It also activates the hazard lights to warn other drivers.

You can always override the stop maneuver by actively steering, braking or accelerating. This indicates that you are attentive again and available to continue the drive.

Speed range for Pilot Assist

Pilot Assist is available at different speeds depending on the context of activation and use.

- When using Pilot Assist, you can set target speeds between 30-180 km/h (20-110 mph).
- Steering assistance is unavailable at speeds above 140 km/h (87 mph).
- Pilot Assist can be activated above 15 km/h (9 mph) but will then try to accelerate up to the minimum set speed.
- When following another vehicle, Pilot Assist can stay active below 15 km/h (9 mph).
 - In situations where you are driving slowly behind other vehicles, such as in a traffic queue, you may be able to use Pilot Assist despite driving slower than 15 km/h (9 mph). This requires a vehicle ahead whose speed your vehicle can match.^[1]

Activation and availability

The content of this manual represents the status of the user manual at the time of printing and may not be completely valid in future instances. For more information refer to the first page for the complete disclaimer note.

Several conditions must be met to activate Pilot Assist. They are related to current traffic and road conditions and the vehicle's system status. Some are related to the vehicle being driving-ready, such as the driver wearing their seat belt, keeping their hands on the steering wheel^[2] and all doors being closed. Others relate to your current driving situation, such as driving at a speed within the speed range for Pilot Assist. If activation is prevented, the specific reason is typically communicated in the instrument panel.

Keeping track of vehicles ahead

One of Pilot Assist's capabilities is adapting the vehicle's speed to a vehicle ahead and maintaining a certain distance to it. Pilot Assist's behavior and ability to track traffic ahead depends on several factors, such as your speed and the speed of the vehicle in front.

Very slow or stationary vehicles in front of you can make Pilot Assist behave differently, depending on the situation and your speed:

- If Pilot Assist follows a vehicle that comes to a stop, Pilot Assist slows your vehicle down to a stop behind the other vehicle.
- If you are driving **below** 70 km/h (44 mph), a stopped vehicle detected ahead of you causes Pilot Assist to slow your vehicle down to a stop behind the other vehicle.
- However, when driving **above** 70 km/h (44 mph), a stopped vehicle detected ahead of you is not treated as a vehicle to follow. Pilot Assist will not slow your vehicle down and will instead try to maintain your set target speed.



Warning

Stopped or slow vehicles ahead

A stopped vehicle in your lane is a collision risk that requires you to act by braking or steering.^[3]

- At speeds below 5 km/h (3 mph) Pilot Assist may pause when following another vehicle:
 - if there is uncertainty whether what's detected in front is a stopped vehicle or another object^[4].
 - if the vehicle ahead makes a turn and leaves your driving path.

Vehicle status and systems

Pilot Assist relies on the accurate detection and identification of surrounding traffic and road conditions. This includes using information from the cameras, radars and other sensors. The detection system cannot handle all driving, traffic, weather or road conditions. Read the separate manual sections about detection types, how they work and their limitations to better understand how Pilot Assist's performance can be affected.

Several of Pilot Assist's features depend on other systems in the vehicle.

- To adapt the speed to vehicles ahead, the vehicle uses a combination of radar and camera detection. Consequently, conditions and limitations of these systems can affect the availability and performance of this feature.
- Steering assistance is only available when the vehicle can identify its position on the road through camera detection of lane markings.
 - This requires the road to conform to certain standards.
 - Conditions and limitations of the vehicle's camera detection can affect the availability and performance of steering assistance.

 **Important**

Vehicle faults

Certain vehicle faults can affect the availability of driver support features. If Pilot Assist is unavailable, check the vehicle status view to see if there are any indicated issues.

Vehicle alterations

Modifications, repairs and accessory installations can negatively affect or limit driver support features. There is a separate manual section with detailed information on this topic.

Other conditions and limitations

- Pilot Assist is primarily intended for use when driving on level road surfaces. It may have difficulty keeping the correct distance to vehicles ahead on steep downhill slopes.
- Pilot Assist with steering assistance is unavailable when driving with a trailer. Heavy or uneven loads may also affect the capabilities and performance of Pilot Assist's steering assistance.
- Driving with a trailer or a heavy load can also affect the performance and capabilities of adaptive cruise control.

^[1] Pilot Assist's lowest target speed is 30 km/h (20 mph), even if your speed at activation is lower than that.

^[2] Wearing gloves can sometimes interfere with the hand-detection sensors on the steering wheel.

^[3] Your vehicle can still warn you of the collision risk and perform a safety intervention if you fail to react in time. This can happen separately from Pilot Assist's capabilities.

^[4] For example, obstacles designed to encourage slow driving.

10.6. Assisted parking

Your vehicle has several features that can help you during parking, such as guidance through camera and sensor views. Learn how to use the different types of assistance.

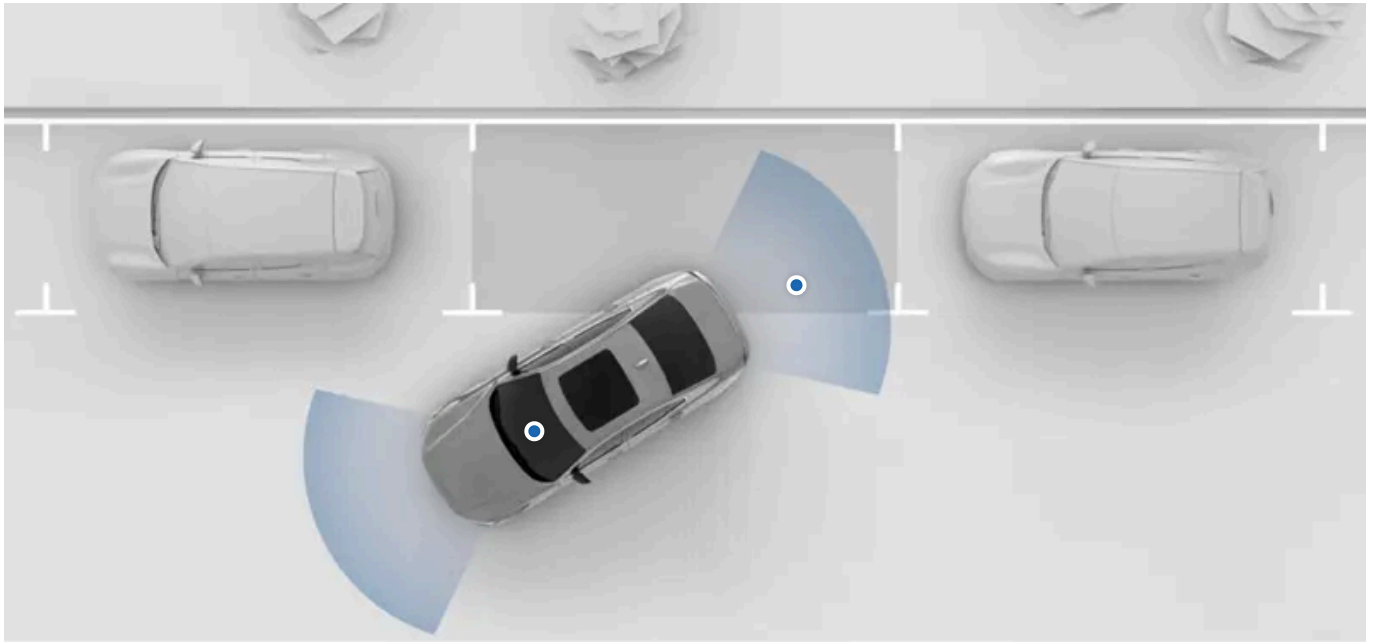

Your vehicle's parking assistance features are available in the center display parking view. In most cases, parking view opens automatically when you need it, but you can also open it manually.

The following parking assistance features are available in the parking view:

Distance and obstacle detection	The vehicle senses the surroundings using many different sensors. It uses this information to guide you with sound, graphics and warnings when driving at low speeds.
Parking camera views	The vehicle shows your surroundings using cameras located around the vehicle.
Automatic braking when reversing^[1]	The vehicle can automatically brake to prevent a collision when reversing. This can happen if it detects an obstacle or crossing traffic behind the vehicle.

 **Important**

Required knowledge and driver responsibility

Assisted parking features are designed to make driving more comfortable and safer, but they do not reduce the need or responsibility of the driver to operate the vehicle as safely as possible. Be sure to read all related information about a feature before using it. The section covering driver responsibility is essential reading for understanding the capabilities and limitations of your vehicle's assisted driving features.

If you find anything unclear or have further questions, do not hesitate to contact Volvo Support.

^[1] Rear Auto Brake (RAB)

10.6.1. Parking view

The parking view contains both camera and parking sensor information to help improve your awareness of the vehicle's surroundings. This can be useful when maneuvering at low speeds, such as when parking.

Accessing the parking view

In most cases, the parking view opens automatically when you need it. You can also access it by opening the camera app in the contextual bar.



When the parking view is open, you can adjust some of the assisted parking settings by pressing the settings symbol  in the top-right corner of the parking view.

The parking view closes automatically when you are driving above a certain speed. After parking, the parking view closes when you turn your vehicle off.

Obstacle and distance detection

The parking view can provide both visual alerts and sound alerts if your vehicle detects any obstacles in your close surroundings.

These alerts change if you go beyond a recommended stopping point. The color of the visual indication shifts toward red, and the sound changes when you get closer to the obstacle.

Important

Driver responsibility

Obstacle and distance detection is a supplement to safe driving practices. It does not reduce the need or responsibility of the driver to operate the vehicle as safely as possible.

The driver is always responsible for paying attention to the vehicle's surroundings and ensuring that it is safe to maneuver the vehicle.

Detection limitations

The vehicle's obstacle and distance detection capabilities have limitations. Read the separate section covering detection of vehicle surroundings and traffic before using features that rely on these capabilities.

Assisted parking faults

If your vehicle detects a fault with the assisted parking system, it will show a message in the instrument panel, the center display or in both locations. Camera malfunctions may also be communicated with messages or symbols in the parking view.

Contact an authorized Volvo workshop if you cannot address the issue yourself.

 **Note**

Camera calibration

After your vehicle's parking cameras have been serviced, they can sometimes take a while to re-calibrate themselves. This can lead to certain features, such as parking view, being unavailable for a short time after servicing.

10.6.1.1. Disabling assisted parking sound alerts

The sound alerts from the parking sensors can be temporarily disabled in the parking view.

When you disable assisted parking sound alerts, the vehicle won't provide sound alerts when you get too close to an obstacle while driving slowly or reversing. Disabling these sound alerts is only temporary. By default, the feature will reset to enabled between drives.

 **Important**

Changing driver support settings

Make sure that you understand how changing your vehicle's settings affects its behavior. It is particularly important when it comes to features that affect the level of assistance the vehicle can provide.

1. In the parking view, press the parking sensors button.



- > Assisted parking sound alerts are temporarily disabled.

11. Scenarios and driving recommendations

The conditions you're experiencing sometimes affect how you can and should use your vehicle. Knowing its capabilities and how you can adapt to the situation can have a significant impact on the outcome. The benefits range from avoiding outright hazards to getting the most out of your vehicle's performance.



This section of the manual will cover specific driving scenarios. These include wading through water and driving on icy roads. Exploring this section gives you a good idea of what features and practices can support you in demanding conditions.

11.1. Cold conditions

Driving in cold conditions can be tricky. It requires different preparations and a different way of driving than driving in a warmer climate does.

When driving in cold conditions, there are many things to take into consideration. From energy consumption and battery health to a comfortable climate and different safety aspects. Be sure to familiarize yourself with what this way of driving entails, as well as which laws and regulations may apply.

Visibility

In cold conditions, ice and condensation can obstruct visibility. Your vehicle is equipped with defrosters, a heated rear windshield and heated door mirrors to prevent this from happening.

 **Warning**

Scraping the windshield

The windshield area in front of the front-facing camera has its own heating to defrost and remove any build-up of snow or ice. Do not use an ice scraper on this area, as it can scratch the glass surface. Scratches or damage to the glass can interfere with or limit the camera's detection capabilities.

Maintenance

 **Note**

Tire pressure

As the temperature drops, the tire pressure drops. Remember to check the tire pressure regularly and adjust it as needed.

 **Important**

Cleaning in front of radar units

If you find dirt, snow or ice, or if the vehicle indicates that a radar unit is blocked, you should address it as soon as possible. Always clean and clear a large area around the radar units to so their full field of view is available.

11.1.1. Winter driving recommendations

There are some things to keep in mind when driving in snow and on ice. Here are some tips and recommendations for safer driving and improved effectiveness of your vehicle's systems.

Preparations for driving in winter conditions

- Use washer fluid with antifreeze to avoid ice forming in the washer fluid reservoir.
- Ensure that the wiper blades are not frozen in place.
- Use engine coolant that contains 50% glycol. This protects the engine against frost down to approximately -35°C (-31°F). To avoid health risks, do not mix different types of glycol.
- Keep the fuel tank filled to prevent condensation.
- Only use engine oil of the prescribed quality. Thinner oils make it easier to start the vehicle in cold weather and reduce fuel consumption while the engine is cold.
- Volvo recommends that winter tires be used when there's a risk of snow or ice.

 **Note**

In some regions, winter tires are required by law. However, keep in mind that not all locations allow studded tires.

Recommendations for driving in winter conditions

Snowy and icy roads require careful driving practices that are different from driving on dry roads. There are a number of precautions to take that will help you drive more safely. For example:

- Remove all snow from your vehicle before you start driving, both for your own sake and for your fellow road users. Pay special attention to the sensor areas, lights, roof and hood.
- Avoid any sudden steering maneuvers, fast acceleration or hard braking, as such maneuvers can cause the vehicle to lose grip.
- Keep a safe distance from the vehicle in front of you, as you are likely to require a longer braking distance.
- Keep in mind that even if the sun melts the snow and ice, it can still be slippery.
- Even when other parts of the road aren't icy, bridges can still be dangerous.
- Snow and ice can accumulate inside the mudguards, which can affect steering. Check regularly and remove any snow, ice, and debris.
- Snow and ice can collect in the braking system and reduce braking performance. Check that the brakes work properly on a regular basis. However, only do so in a safe and careful manner.
- Sometimes, using snow chains can be a good idea. However, be sure to read the instructions on how to use them safely and effectively.

Warning

Avoid parking on inclines during winter conditions. The tires might lose traction, even if the parking brake is engaged. You are always responsible for safe parking.

Tip

It's a good idea to practice driving on slippery surfaces under controlled conditions to learn how the vehicle reacts. Visit a skidpan if you have access to one.

11.2. Recommendations for driving through water

When driving through water, there are important limitations to consider regarding the water's depth and the driving speed.

 **Important**

Avoid wading when possible

Volvo recommends that wading be done with great caution and that you avoid it when possible. It can be difficult to accurately assess the water's depth and the strength of the current. The driver is always responsible for driving in a safe manner and in compliance with all applicable rules of the road.

Warranty not applicable

Any damage caused by flooding is not covered by the warranty.

If the engine stalls

Do not attempt to restart the engine if it stalls while wading. Have the vehicle towed to a workshop^[1].

- If possible, determine how deep the water is before you start driving. Only attempt to drive through if you are confident it's shallow enough to safely wade through.
- The recommended deepest water level when wading is 25 cm (9 inches).
- Limit your speed to walking pace.
- Avoid wading in strong currents, especially if the water is deep enough to risk flowing over the vehicle.
- Oncoming traffic can cause waves that increase how high the water reaches.
- If possible, avoid stopping when you're in the water. Carefully keep driving forward or reverse out of it.
- Avoid driving through saltwater, as it can cause corrosion.

 **Warning**

Wet brakes

The vehicle's stopping distance is longer if the brake discs are wet. Driving through water exposes the brake discs to water, and possibly mud or other sediment. After wading, safely perform a hard braking maneuver to remove dirt and water from the brakes. By engaging the brake discs while driving, they heat up and dry.

^[1] Volvo recommends an authorized Volvo workshop.

11.3. Preparations for a long trip

Before you head out on a long road trip, it's a good idea to check a few things.

- Make sure that the brakes work as intended.
- Check the tire tread depth and pressure. If there is a risk of snowy or icy roads, change to winter tires.
- Ensure that the wipers are in good shape and replace them if needed.
- Fill up the washer fluid.

- Check that no fluids are leaking from the vehicle.
 - Ensure that the engine is running properly and fuel consumption is normal.
 - Check that the 12 V battery is sufficiently charged.
 - Make sure that useful equipment is in place, such as a puncture repair kit, first aid kit, a warning triangle and a reflective vest.
 - If you plan to visit a region that uses different units of measurement, such as miles or kilometers per hour, you can change the vehicle's unit settings.
 - If driving in a region with different traffic laws, make sure the vehicle is equipped as required, and read up on how the rules of the road differ from what you're used to.
 - Remote areas may have poor or no internet connection. If you plan to drive in these areas, download the maps you need in the navigation app so you can use them when your vehicle is offline.
-

12. Storage, stowing and towing

Your vehicle is designed to transport people as well as luggage and other cargo. Learn about the vehicle's stowing and towing capabilities.



Your vehicle's passenger compartment and trunk have several areas for safely stowing items of different shapes and sizes.

The trunk can be expanded to create more space for larger cargo.

You can also use the roof for transporting heavy cargo, and with a towbar, you can attach a trailer.

Warning

It is important to properly store objects, even small items. Objects that are not stowed securely can be dangerous in the event of sudden braking or a collision.

Adding cargo to the vehicle changes the vehicle's weight and driving control properties. Always refer to the vehicle's permitted weight regulations and guidelines.

Before towing a trailer, make sure that all connectors and safety attachments are secured. Also be sure to follow local regulations regarding towing.

Important

Large and heavy loads on the roof may interfere with vehicle sensors.

12.1. Passenger compartment storage

The content of this manual represents the status of the user manual at the time of printing and may not be completely valid in future instances. For more information refer to the first page for the complete disclaimer note.

Find where the storage locations are in the passenger compartment.



- ① Door panel storage compartments
- ② Pockets on the front seat backs
- ③ Center console
- ④ Glove compartment

There are other smaller features that can be useful for storing specific items.

- You can fold out the center seat backrest to access cup holders.

12.1.1. Glove compartment

You can store items that you don't immediately need in the glove compartment.

In the event of sudden braking or a collision, loose items can be hazardous. The glove compartment is useful for storing small items safely and securely.

The glove compartment is located in the dashboard in front of the passenger seat.

12.2. Trunk space and storage

The trunk can be configured to accommodate cargo of different shapes and sizes.

You can adapt the trunk in different ways and expand it to create a larger cargo space. This can be useful for storing larger items.

Folding down the rear seats is ideal for loading large objects. Install a safety net when doing so to prevent objects moving into the front passenger compartment.

The cargo hold is accessed via the underfloor hatch. It's useful for protecting items and storing tools and equipment.

 **Tip**

Adjust trunk opening height

You can adjust how much the trunk hatch opens. This can be useful when you're parked in places with a low ceiling, such as a garage, and you want to reduce the trunk opening height. You can also raise the trunk opening height to create more room for accessing the trunk.

Stowing cargo securely

You can also find options for stowing cargo securely to ensure that it doesn't move around the trunk while you are driving.

12.2.1. Installing the safety net

 **Warning**

There should be no occupants in the vehicle to the rear of a safety net. A safety net can interfere with safety features such as airbags.

 **Important**

Do not use the safety net to secure large or heavy objects. Secure any large or heavy cargo with straps using the load retaining eyelets located around the rear interior of the vehicle.

When a safety net is in place behind a retractable seat, be careful not to recline or reposition the seat too far back.

When installing the safety net, make sure it is the right way round. The tightening straps should always be on the side facing you.

Installing behind front seats

1. Remove the coat hooks from their sockets by twisting the hooks. Store them in a safe place for when you need the hooks again.

2. Fasten the lower corners of the net to the outer tether points behind the seats.

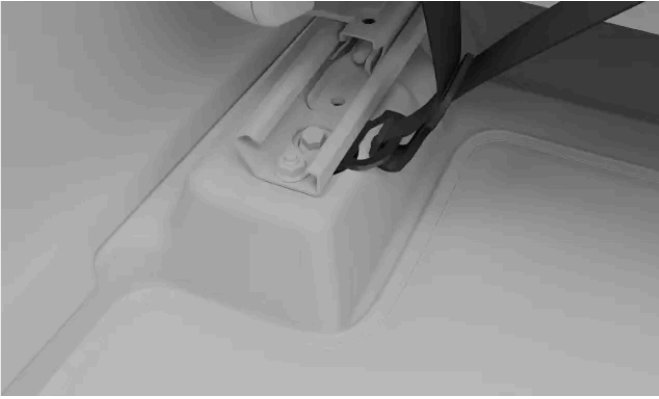

3. Tighten the straps to make the safety net tight and more secure.

 **Tip**

Removing the safety net

To remove the safety net, follow the installation steps in reverse order.

12.2.2. Opening the ski hatch

You can use the ski hatch to stow long, thin objects in the vehicle, such as lumber or skis. This way, you don't need to fold the seats down.

The ski hatch is located in the middle of the rear seats. You can access it via the trunk or the passenger compartment.

 **Warning**

Any objects placed in the back of the vehicle must not be in contact with the front seats. This can impede the safety of other occupants.

1. Open the trunk and grasp the handle located in the middle of the rear seats.
2. Pull the handle and fold the hatch down.
3. Go to the back of the passenger compartment and fold the rear seat armrest forward.

Make sure nothing is obstructing the hatch opening.

12.2.3. Stowing cargo in the trunk

The trunk has a number of options for storage.

The trunk has several useful features to help you stow things away and secure items.

The trunk has several features to help stow items. These include:

- Bag hooks for preventing shopping bags from falling over. They are located on the side panels and under the parcel shelf.
- Storage pocket in the side panel.
- Net pocket for storing smaller items on the side panel.

There is also a cargo hold under the trunk floor where you can store tools and equipment. To access it, open the hatch in the trunk floor.



Tip

There is a 12 V socket in your trunk. This can be useful for powering various electrical devices, such as an electric cooler.

12.3. Towing a trailer

The towbar allows you to tow a trailer with your vehicle. Be sure to familiarize yourself with towing features and any relevant safety issues.

Before towing a trailer, consider how this will affect your journey. Make a thorough assessment based on your vehicle's capabilities.

- Keep in mind that the vehicle performs differently with added weight at the rear. This affects both handling and power usage. Expect a notable reduction in range when towing a trailer.
- Only use trailers in good working condition that comply with local regulations.
- Make sure you have read the separate section covering loading recommendations.



Note

Maximum permitted trailer weights

The stated maximum permitted trailer weights are those permitted by Volvo. National vehicle regulations can further limit permissible trailer weights and speeds. Your towbar may be certified for a higher towing weight than the vehicle can actually tow.

Towing preparations

1. Increase the tire pressure to the recommended pressure for a full load. This applies regardless of the trailer weight.

2. Deploy the towbar and attach the trailer.
3. It's advisable to check that the trailer lights are in good working order.

Driving with a trailer

4. Read the recommendations for driving with a trailer thoroughly before you start driving.

Important

While driving

- Maintain a low speed when driving with a trailer up long, steep ascents.
- Avoid driving with a trailer on inclines of more than 12%.
- The additional load increases the risk of overheating, which will be indicated in the instrument panel. Follow any instructions shown.
- Avoid parking on an incline if possible. The extra weight of the trailer can affect the parking brake's ability to securely hold the vehicle. If you cannot avoid parking on an incline, be sure to block the wheels^[1] as a precaution.

Interventions and warnings when reversing

The vehicle can automatically brake to prevent a collision when reversing if it detects an obstacle or crossing traffic behind the vehicle. Interventions and warnings when reversing are disabled when towing a trailer.

Note

If you've had the towbar installed after purchasing your vehicle, a system update may be needed for the towing features to work. Contact a Volvo retailer to update the software.

^[1] If you do not have wheel chocks, you can use large stones or wooden blocks instead.

12.4. Determining the permitted gross vehicle weight

Make sure to never exceed your vehicle's maximum gross vehicle weight. Calculate your load limits for transportation using the following information.

 **Warning**

- If the permitted axle weight, gross vehicle weight or another specified weight is exceeded then the tires may overheat. This could lead to serious tire damage and safety risks.
- Do not use replacement tires with a lower load capacity than the tires the vehicle was originally equipped with, as this lowers the vehicle's gross vehicle weight classification. Only use tires with the correct load capacity. For more information, contact Volvo Support.

Before you load the vehicle, you should familiarize yourself with the following weight terminology that can be found on the FMVSS/CMVSS label (Federal/Canadian Motor Vehicle Safety Standards) and the vehicle's tire information plate:

Terminology:

Curb weight	Weight of the vehicle, including all oil, fluids and all standard equipment. This does not include passengers, cargo or optional equipment.
Weight capacity	All weight added to the curb weight, including cargo and optional equipment. When towing, trailer hitch tongue load is also part of cargo weight.
Gross vehicle weight	The vehicle's curb weight + cargo + passengers.
Permissible axle weight	The maximum allowed weight that can be carried by an individual axle (front or rear). These figures are specified on the FMVSS/CMVSS label (Federal/Canadian Motor Vehicle Safety Standards). The total load on each axle must never exceed its maximum permitted weight.

Steps for determining correct load limit

1. Locate the statement "The combined weight of occupants and cargo should never exceed XXX kg or XXX lbs." on your vehicle's placard.
2. Determine the combined weight of the driver and passengers that will be riding in your vehicle.
3. Subtract the combined weight of the driver and passengers from XXX kg or XXX lbs.
4. The resulting figure equals the available amount of cargo and luggage load capacity. For example, if the "XXX" amount equals 1400 lbs. and there will be five 150 lb passengers in your vehicle, the amount of available cargo and luggage load capacity is 650 lbs. (1400 - 750 (5 × 150) = 650 lbs.)
5. Determine the combined weight of luggage and cargo being loaded on the vehicle. That weight may not safely exceed the available cargo and luggage load capacity calculated in Step 4.
6. If your vehicle will be towing a trailer, load from your trailer will be transferred to your vehicle. Consult this manual to determine how this reduces the available cargo and luggage load capacity of your vehicle.

12.5. Recommendations for loading

Proper loading is important for safety and vehicle performance on the road.

Loading in general

Load weight and placement affect the vehicle's center of gravity, handling and performance.

 **Warning**

Unsecured cargo

A loose object weighing 20 kg (44 pounds) can, in a frontal collision at a speed of 50 km/h (30 mph), carry the impact of an object weighing 1,000 kg (2,200 pounds). Always follow the loading recommendations to reduce the risk of material damage or personal injury.

- Position heavy cargo as low as possible.
- Do not stow cargo where it may obstruct airbag deployment. If stacked cargo reaches above the upper edge of the windows, be sure to have at least 10 cm (4 inches) of clear space between the window and the cargo. Otherwise, the intended protection of the inflatable curtain, which is concealed behind the panels above the windows, may be compromised.
- Always comply with the vehicle's specifications regarding weight and maximum permitted load.
- When loading the trunk, position cargo firmly against the rear seat backrests.
- Large objects placed in the trunk can obscure the driver's view through the rear windshield.
- Avoid placing cargo against the back of the front seats. This may compromise the effectiveness of the front-seat whiplash protection.
- Cover any sharp edges, corners and protrusions.
- Make sure that all cargo is secure for the duration of travel. You need to regularly check and re-tighten the straps because cargo can move during transit.
- Remove cargo you no longer need from the vehicle. Reducing the vehicle's overall weight improves both performance and range.

Roof loading

 **Important**

Any loads on the roof should not extend above the windshield. This can interfere with vehicle sensors.

Use a load carrier recommended by Volvo when carrying loads on the vehicle's roof. This reduces the risk of damage to the vehicle and helps ensure safety while traveling. Carefully follow the mounting instructions supplied with the load carriers.

Exterior loads affect the vehicle's aerodynamics, handling and sensitivity to crosswinds. Increased drag affects energy consumption and range.

- Position heavy cargo as low as possible.
- Distribute the load evenly across the load carriers.
- For long loads that extend over the hood, install the towing eye at the front of the vehicle and use it to secure the load.
- Drive gently. Avoid rapid acceleration, hard braking and sharp cornering.
- Remove the load carriers when you are not using them. This improves both performance and range.

13. Care and maintenance

Keep the interior and exterior of your vehicle in good condition with regular care and maintenance.



This section of the manual covers regular care and cleaning you can do yourself, information about some of your vehicle's components that have specific maintenance needs and service maintenance information.

Note

Volvo's service program

Adhering to your vehicle's service program is highly recommended. A vehicle in good condition contributes to traffic safety and operational reliability.

13.1. Vehicle status

The vehicle status view in the center display is a useful aid for keeping track of your vehicle's health. This is where the vehicle shows you information about any detected issues.

The vehicle status view shows a visual overview of your vehicle and lists any detected issues. The issues are classified depending on severity. A minor issue may be something you can sort out on your own, such as refilling washer fluid. A critical issue may require a workshop visit before you can safely drive the vehicle again. It's recommended to address issues as soon as they appear, especially if they're not minor.

 **Important**

The vehicle is unable to detect and identify all types of issues that can occur. It is therefore important to regularly inspect the vehicle's condition and address any service or maintenance needs you identify. Contact an authorized Volvo workshop for guidance if you are unsure of an issue's severity, regardless of whether it is indicated by the vehicle or not.

To open the vehicle status view, press the vehicle symbol  in the bottom bar and go to **Status**.

13.2. Exterior cleaning and care

Keep your vehicle's exterior in good condition by getting rid of dirt and taking care of any paintwork scratches as soon as you notice them. Ensure good visibility by keeping wiper blades in good condition.



Wash your vehicle regularly, top up the washer fluid when needed and replace the wiper blades when they get worn. Taking care of your vehicle's exterior doesn't just make it look nice; it also keeps your vehicle in good condition.

13.2.1. Washing the exterior by hand

To avoid problems with cleaning ingrained dirt, wash the vehicle regularly and as soon as it starts getting dirty. This reduces the risk of scratches and, of course, keeps your vehicle looking good.

 **Important**

When and where to clean the exterior

- Clean your vehicle as soon as it has attracted dust or dirt. This prevents the build-up of ingrained dirt, which often contains larger particles and debris that cause wear and damage, especially during cleaning.
- Remove bird droppings and tree sap or resin as soon as possible. These contain substances that can quickly damage and discolor the paintwork.
- Avoid washing your vehicle in direct sunlight. This can cause cleaning agents or wax to dry out and act as abrasives.
- If the vehicle has been exposed to corrosive substances, such as acid rain, salt, chemicals, iron powder, soot or ash, it needs to be cleaned as soon as possible to prevent damage. In areas with a lot of industrial emissions, more frequent washing is recommended.
- Clean the vehicle in a dedicated cleaning area that collects the wastewater and make sure the water is treated according to environmental regulations. Make sure that there is an oil separator in the cleaning area.

High-pressure washing

- Make sure that doors, windows, hatches and the panoramic roof are closed.
- Use a circular motion and keep the nozzle at least 30 cm (1 foot) from the vehicle's surface.
- Do not spray directly onto openings or sensitive areas such as locks, cameras, trim, air intakes or the fuel filler flap.

 **Note**

- Be gentle and use the right cleaning equipment for the type of surface you are washing.
- Only use cleaning agents and vehicle care products recommended by Volvo, and follow each product's accompanying instructions.

Full exterior washing

1. Start by rinsing the underbody, including the wheel housings and bumpers.
2. Rinse the entire vehicle to dissolve and wash away dirt. For particularly dirty surfaces, you can use a cold degreasing agent.
3. Then use a sponge, car shampoo, and plenty of lukewarm water to wash the entire vehicle.
4. Dry the vehicle with a clean, soft chamois cloth or a gentle squeegee. This reduces the risk of stains from dried water droplets, which require additional polishing.
5. Remove dirt from the drainage holes in the doors and clean out the door sills after washing the vehicle.
6. If any tar stains from the road-surface asphalt remain, use a tar remover to get rid of them.

If there are particularly stubborn dirt patches or if you don't get the desired result when cleaning your vehicle, contact Volvo support for advice.

13.2.2. Washing the vehicle in an automatic car wash

Volvo recommends that you wash the vehicle by hand so that you can properly reach all parts of the vehicle. However, an automatic car wash is a simple way to quickly clean your vehicle as soon as it gets dirty.

Note

Volvo recommends that you do not use an automatic car wash during the first few months when the vehicle is still new. This allows the paintwork to harden properly.

Important

Before using an automatic car wash

- Make sure that doors, windows, hatches and the panoramic roof are closed.
- Change wiper mode to off.
- Secure any auxiliary lights.
- Activate air recirculation.
- Disable auto hold so that the vehicle does not automatically brake or give unnecessary warnings.
- Open the parking view.

1. Follow the instructions to drive into the automatic car wash and stop at the designated location.
2. If you are using a tunnel car wash:
 - Put the gear in N and take your foot off the brake. Turn the vehicle off but do not apply the parking brake.If you are using a rollover car wash:
 - Put the gear in P to engage the parking brake.
3. After the wash cycle is complete, follow the instructions and drive out.
4. Be sure to reset any functions you changed before you drove in.

Warning

Always test the brakes after washing, including the parking brake. This helps prevent moisture from causing corrosion, which could reduce brake performance.

If there are particularly stubborn dirt patches or if you don't get the desired result when cleaning your vehicle, contact Volvo support for advice.

13.2.3. Polishing and waxing

If your vehicle loses its luster, it's time for a new coat of polish and wax. This gives the paintwork extra protection.

Feel free to wax your vehicle whenever necessary, but you shouldn't need to polish it during its first year.

Important

Be careful

- Do not polish or use products intended for high-gloss paintwork on surfaces that have matte paintwork. This may create a permanent gloss on the surface.
- Polishing glossy trim moldings could wear away or damage the glossy surface layer.
- Avoid using polish or wax on rubber and unpainted plastic components.

Contact Volvo support for information on recommended cleaning agents and car care products.

1. Make sure the vehicle is protected from direct sunlight. The surface should be no more than 45 °C (113 °F) when applying polish or wax.
2. Wash and dry the vehicle thoroughly.
3. First polish the vehicle, then wax it. Follow the instructions on the packaging carefully. Many products contain both polish and wax.

13.2.4. Touching up paintwork damage

Taking care of your vehicle's paintwork helps to maintain the exterior. Inspect it regularly and repair damage right away to avoid further problems.

Common damage that may occur includes stone chips, scratches and marks along the edges of doors or bumpers.

Important

Paintwork damage in front of a radar can affect the radar's detection capabilities. Contact a service point for repairs if you find any damage near the radars.^[1] If you're unsure about where your vehicle's radars are, you can find an overview of their locations in a separate section of this manual.

 **Note**

Paint batches and brands may differ slightly in color even if the color code is the same. Therefore, even though you can touch up paintwork damage on your own, Volvo recommends that you always contact an authorized Volvo workshop to get help with any paintwork damage.

- Contact a Volvo retailer for recommendations on touch-up pens and spray paints.
 - The surface must be clean and dry before doing any touch-ups.
 - The temperature of the surface should be at least 15 °C (59 °F).
 - Follow the instructions for the touch-up pen or paint you're using.
1. Apply masking tape over the damaged area. Then peel it off to remove all loose paint.
 2. If there are uneven edges, you may need to gently polish around the damaged area using a very fine abrasive cloth. Clean the area thoroughly afterwards and let it dry.
 3. If the damage:
 - has not reached the metal and an undamaged layer of paint remains, you can apply touch-up paint directly to the cleaned surface.
 - has reached the metal, first use a primer.
 - is on a plastic surface, first use an adhesive primer for better results. Spray into the lid of the spray can and brush on a thin layer.
 - is a long scratch, use masking tape around the damaged area to protect the undamaged paintwork.
 4. Stir the primer thoroughly and apply with a fine brush, matchstick or something similar. Let it dry.
 5. Finish with a base coat and clear coat.

^[1] Volvo recommends authorized Volvo workshops for all servicing and repairs.

13.2.4.1. Finding the paint color code

You can find the vehicle body paint color code on the product label located on a pillar between the front and rear doors.

If there is damage to your vehicle's paintwork or it needs repairing or repainting, you need to know the exact color of the paint.

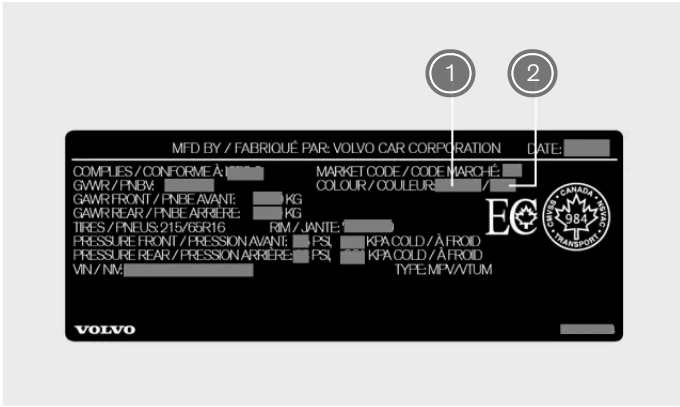

- ① Paint color code
- ② Secondary paint color code

1. Go to the left-hand side of the vehicle.
 2. Open the front and rear doors.
 3. Find the door pillar located between the front and rear doors.
- > The product label containing the color code is located on the outer side of the door pillar, near the bottom.

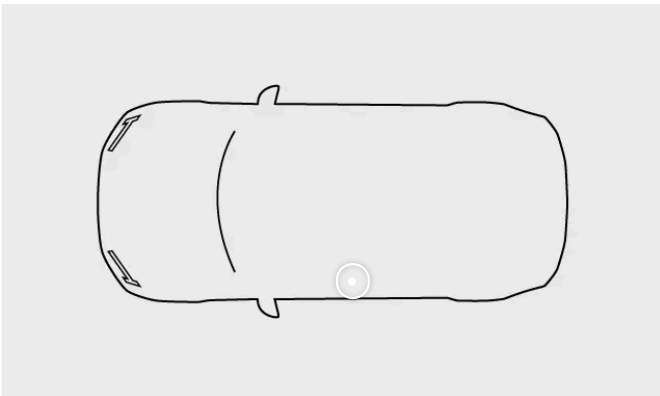

13.2.5. Windshield damage

It's important to repair a damaged windshield as soon as possible. If you take immediate action, minor chips and cracks can often be repaired without replacing the entire windshield.

Small cracks or chips

Small windshield cracks or chips can quickly spread, turning it from minor to severe damage. Contact an authorized Volvo workshop if you notice glass damage. Repair the windshield as soon as possible.

 **Important**

Camera and sensor area

Any windshield damage in the camera and sensor area, including small chips, scratches or cracks, can negatively affect forward detection and features that use it.

- Any windshield damage in this area requires inspection by a service technician.
- Volvo recommends not repairing small damage in the camera and sensor area. Instead, the entire windshield should be replaced.

Severe glass damage

If the windshield suffers severe damage, the entire glass panel needs to be replaced.

 **Warning**

Compromised safety

Do not drive the vehicle if there is structural damage to the windshield. Weakened glass can degrade very quickly, impair visibility and seriously compromise safety.

 **Note**

Compatibility of new windshield

It's important that the new windshield and its installation meet Volvo's specifications for safety and compatibility with the vehicle's features.

Calibration

When a windshield is installed, the forward-facing camera behind the glass requires function checks and calibration by a service technician to ensure that it works correctly.

13.2.6. Refilling washer fluid

The washer fluid reservoir cap is located under the hood. Be sure to use high-quality washer fluid.

The vehicle notifies you when the washer fluid level is getting low.^[1]

 **Note**

Reservoir capacity

Your vehicle can hold 10.2 liters (approximately 10.8 U.S. quarts) of washer fluid.

 **Important**

Washer fluid quality

- Use washer fluid with a pH between 6 and 8.
- If you use concentrated washer fluid, dilute it as instructed on the packaging and use clean pH-neutral water.
- Volvo recommends washer fluid with antifreeze in cold conditions, especially in temperatures below freezing. This is to prevent damage caused by the fluid freezing inside the pump, reservoir and hoses.

1. Open your vehicle's hood.

2.

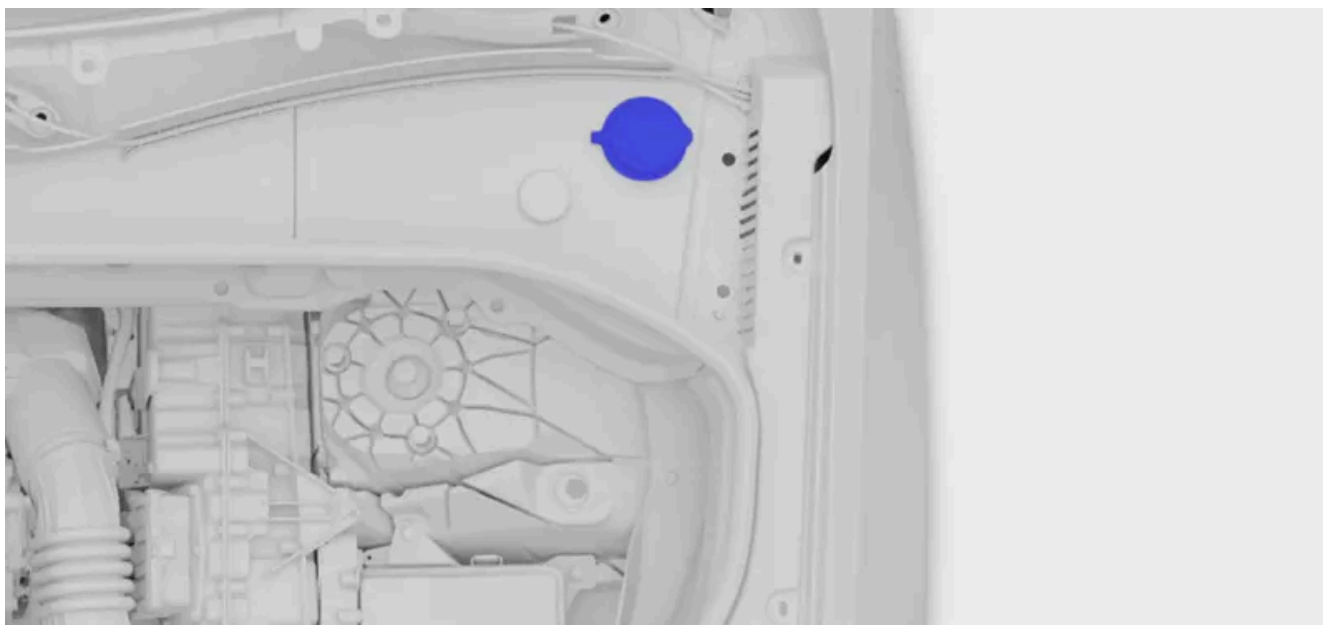

Locate the blue cap with the washer fluid symbol and open it.

3. Pour the washer fluid into the reservoir. Avoid spillage if possible.

4. Close the cap and hood.

^[1] When there is about 1 liter (1 quart) left.

13.2.7. Cleaning wipers

Dirt, dust, sand, insects and different weather conditions are just a few of the things your wipers take care of. It's important to clean your wipers regularly to maintain good visibility and prolong the blades' service life.

1. Activate the wiper service position via settings in the center display. This gives you better access to the front wiper blades.

The content of this manual represents the status of the user manual at the time of printing and may not be completely valid in future instances. For more information refer to the first page for the complete disclaimer note.

2. Rinse the area with water to get rid of any loose dust and dirt.
3. Use a soft sponge with a lukewarm soap solution or car shampoo to clean the area. Lift the wiper arms from the windshield for better access.
4. Use a clean, soft cloth to dry the wipers.
5. Make sure the wiper arms are folded back down against the windshield, and then deactivate the wiper service position.

! Important

Test the wipers before driving. Use plenty of washer fluid when the wipers are in motion. The windshield must be wet for the wipers to work properly.

13.2.8. Replacing front wiper blades

Your front wiper blades' service life is affected by the water, dirt and debris that they sweep off your windshield. The wiper blades need to be replaced when they show signs of wear.

1. Activate the wiper service position via settings in the center display.

2.



Fold the wipers up and away from the windshield.

3. Pull the lower part of the blade away from the arm until you hear a click.

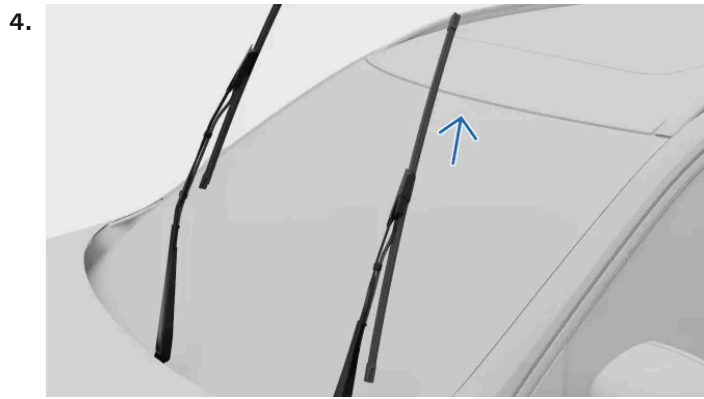

Press the button on the wiper arm and remove the wiper blade by pulling it upward.



Make sure that the blade for the driver side is longer than the blade for the passenger side. Slide the wiper blade onto the wiper arm. Ensure that the pin on the wiper arm goes into the hole on the wiper blade. Push the blade into the wiper arm until you hear a click.

6. Push the lower part of the blade toward the arm again until you hear a click.

7. Check that the blade is firmly attached.

8. Fold the wiper arms back down against the windshield.

9. Deactivate the wiper service position.

13.2.9. Activating the wiper service position

The wiper service position allows you to clean or replace the front wiper blades. When activated, the wipers move to a more accessible position on the windshield.

1. Press the vehicle symbol  in the bottom bar and go to **Settings**.

2. Go to **Controls** → **Mirrors and wipers** → **Wipers** → **Wiper service position**.

3. Activate the service position.

> The wipers move to a more accessible position and can be lifted up from the windshield for servicing.

 **Important**

Fold the wipers down

Be sure to fold the wipers back down against the windshield after servicing them. Activating the wipers when they are in a raised position can damage the vehicle.

Once you have folded the wipers back down, deactivate the service position. This can be done by either of these options:

- The setting in the center display.
- Start driving.
- Start using the wipers or washers.

13.2.10. Corrosion protection

A good way to reduce the risk of corrosion is to keep your vehicle clean. Your vehicle also has durable corrosion protection.

Normally, the corrosion protection doesn't require maintenance apart from regular cleaning and washing, which removes corrosive substances. Avoid using strong alkaline or acidic cleaning solutions on glossy trim components because they can cause corrosion. Road surfaces with gravel or small stones can lead to paint chips that can act as entry points for corrosion. Deal with such damage as soon as you notice it.

The vehicle body's corrosion and abrasion protection consists of:

- protective coatings, both on the sheet metal and applied in a high-quality painting process
- shielding with plastic components
- corrosion-resistant cast aluminum used for exposed components of the wheel suspension.

13.3. Interior cleaning and care

Keep the interior of your vehicle in good condition by taking care of its materials and keeping them clean.



Use the passenger compartment storage areas and cup holders to keep your vehicle tidy. Always take care of stains and dirt as soon as you notice them to avoid permanent staining.

If there are particularly stubborn dirt patches, or if you don't get the desired result when cleaning your vehicle, contact Volvo Support for advice.

13.3.1. Cleaning fabrics and textiles

If you get a stain on the vehicle's interior, such as on the headlining or seat upholstery, clean it as soon as possible.

These recommendations apply to various interior fabrics, including Tailored knit.

 **Important**

When cleaning textiles

- Never scrape or rub dirty surfaces. Instead, use gentle circular motions. Remember that sharp objects or abrasive materials can damage the vehicle.
- Always clean the entire upholstery. Cleaning only isolated spots on the upholstery can leave water rings or other marks.
- Do not remove surface upholstery during cleaning.
- Certain clothes, such as jeans or suede, can discolor the textile upholstery.
- Be careful when cleaning the headliner as harsh treatment may damage it.
- Only use cleaning agents and vehicle care products recommended for cleaning textiles, and follow each product's accompanying instructions.

 **Warning**

Seats with side airbags

Never spray a cleaning agent directly on the sides of seats with side airbags. Instead, wipe them clean with a cloth lightly dampened with a suitable cleaning agent.

1. Vacuum or dust the area to remove loose dust and dirt.
2. Clean the area with a neutral-colored, clean and lint-free microfiber cloth that is lightly dampened with water or a colorless, mild cleaning agent. Use gentle circular motions.

 **Tip**

To wash the textile upholstery, an upholstery cleaning machine is recommended for extracting the cleaning solution and performing a water rinse.

3. Let the material dry fully before use.

 **Important**

Cleaning seat belts

When cleaning a seat belt, keep it extended until fully dry.

13.3.2. Cleaning leather or vinyl

The leather and vinyl in your vehicle can be impacted by dirt and colored garments over time. You need to clean and treat the surface to make it more resistant to damage.

These leather cleaning recommendations only apply to real leather details.

 **Important**

When cleaning upholstery

- Never scrape or rub dirty surfaces. Instead, use gentle circular motions. Remember that sharp objects or abrasive materials can damage the vehicle.
- Do not use a steam cleaner on leather.
- Do not remove surface upholstery during cleaning.
- Do not use leather and vinyl cleaner on textile surfaces.
- Only use cleaning agents and vehicle care products recommended by Volvo, and follow each product's accompanying instructions. Contact Volvo Support for more information.

 **Warning**

Seats with side airbags

Never spray a cleaning agent directly on the sides of seats with side airbags. Instead, wipe them clean with a cloth lightly dampened with a suitable cleaning agent.

1. Vacuum or dust the area to remove loose dust and dirt.
2. Use a neutral-colored, clean microfiber cloth lightly dampened with cleaning agent and clean the area using gentle circular motions.
3. Let the upholstery dry fully before further use or applying any treatments.

13.3.3. Cleaning glass and glossy surfaces

Clean surfaces such as displays, mirrors and touch buttons regularly and gently.

 **Important**

When cleaning glass and glossy surfaces

- Do not scrape or use any abrasive cleaning agent on displays, mirrors and touch buttons. This can damage the reflective surface.

1. Vacuum or dust the area to remove loose dust and dirt.
2. Use a clean microfiber cloth lightly dampened with water and clean the area with a gentle circular motion.
3. Let the surface dry fully before use.

13.3.4. Cleaning interior plastic, metal, and wood components

Clean panels and controls regularly, and deal with stains straightaway.

 **Important**

Be gentle

Never scrape or rub dirty surfaces. Instead, use gentle circular motions. Remember that sharp objects or abrasive materials can damage the vehicle.

1. Vacuum or dust the area to remove loose dust and dirt.
2. Use a clean microfiber cloth lightly dampened with water and clean the area with a gentle circular motion.

 **Important**

Never spray fluids directly on electrical components such as buttons or controls.

3. Let the material dry fully before use.

13.3.5. Cleaning mats

Clean the mats regularly and always make sure they are properly in place.

 **Important**

Be gentle

Never scrape or rub dirty surfaces. Instead, use gentle circular motions. Remember that sharp objects or abrasive materials can damage the vehicle.

1. Remove the mats for separate cleaning and access to the floor. Grasp the mat by the fastening pins and lift it straight up.
2. Vacuum the mats and floor to remove loose dust and dirt. Do not shake or beat the mats to remove dust and dirt, as they can crack.
3. Clean the area with a neutral-colored, clean microfiber cloth that is lightly dampened with water or a colorless, mild cleaning agent. Use gentle circular motions.
4. Let the mat dry fully before putting it back. Secure it in place by pressing down near each pin.

 **Warning**

Only use one mat for each seat and make sure the mats are properly fastened using all pins. If the driver's mat is not properly attached, it can move around and hinder driving by getting caught near or under the pedals.

13.4. Wheels and tires

The purpose of the tires is to carry your vehicle's load, ensure a good grip on the road surface, reduce vibration and protect the wheel rim from wear. Familiarize yourself with the recommendations to get the most out of your wheels and tires.



Familiarize yourself with tasks such as how to maintain the correct tire pressure and how to change tires so you are comfortable in these situations.

13.4.1. Wheel and tire recommendations

Volvo recommends that you only use wheel rims and tires that have been tested and approved by Volvo and are genuine Volvo accessories. A complete wheel refers to a tire mounted onto a wheel rim.

Recommended tires

On delivery, the vehicle is equipped with Volvo original tires that have the VOL marking on their sides ^[1]. These tires are carefully adapted to the vehicle. It is therefore important to use new tires with this marking when you change tires, in order to maintain the vehicle's driving characteristics, comfort and electricity consumption.

Original tires

Your vehicle is originally equipped with tires that match the data on the label found on the pillar by the driver door.

The tires have good road-holding properties and provide good driving characteristics on dry and wet road surfaces. Remember, however, that the tires have been developed to provide these properties on roads that are free from ice and snow. Even if the vehicle is equipped with stability systems or all-wheel drive, these tires are not designed for winter driving. Change to winter tires when the weather requires you to.

Some vehicles are equipped with tire and rim combinations that offer with extra-high performance. They are designed to be capable on dry road surfaces and with resistance against aquaplaning. These may be more sensitive to damage on the road surface and, depending on conditions, may have a shorter service life.

All-season tires provide slightly better roadholding on slippery road surfaces than tires without the "all-season" classification. However, for good road-holding on icy or snow-covered roads, Volvo recommends winter tires on all four wheels.

Tire age

Volvo recommends that tires should be changed after 6 years from the date when they are first used. If you are unable to determine the date, use the DOT^[2] marking on the tire sidewall. Tires age and deteriorate over time, even if they are rarely used. The function can therefore be affected. Heat caused by hot climates, frequently carrying heavy loads or exposure to ultraviolet (UV) radiation may accelerate the aging process. Cracks or discoloration are examples of external signs indicating that the tire is unsuitable for use. A tire that has visible signs of deterioration should be changed immediately.

Replacing tires

Note that the front and rear wheel pairs have different dimensions. Never swap the originally mounted wheels between the front and rear axles.

When you replace your tires, you must make sure that all four tires have the right size designation for their corresponding axle, are of the same type (radial), and are preferably from the same manufacturer as the original tires. Volvo recommends that you use VOL-marked tires. Otherwise there is a risk of changing the vehicle's roadholding properties and driving characteristics.

If the wheels are mounted incorrectly, the vehicle's braking characteristics and capacity to deflect rain and slush are adversely affected.

Wheel rims and tire sizes

Warning

- Your Volvo's wheel rim and tire sizes are specified to meet stringent requirements for stability and driving characteristics. Unapproved combinations of wheel rim size and tire size may have a negative effect on vehicle stability and driving characteristics.
- Any damage caused by the mounting of unapproved combinations of wheel rim size and tire size are not covered by the new vehicle warranty. Volvo accepts no liability for death, personal injury or any costs caused by such installations.
- Do not use steel or aluminum wheel rims that are damaged, cracked or deformed, that have extensive corrosion damage, or that have been welded or repaired.

^[1] There may be deviations for certain tire dimensions.

^[2] Department of Transportation

13.4.1.1. Tires and wheel storage

To keep them in good condition, you should always store wheels that are not in use in a cool, dry, dark place. It is important to position them correctly and avoid exposure to chemicals.

When not in use, It is important to store wheels away from direct sunlight, rain, water, heat sources or sparks. They should never be stored near solvents, gasoline, motor oil, or similar substances, especially not flammable ones.

Store wheels^[1] hung up or lying on their sides on the floor.

Never hang up tires not installed on rims for storage. Store them standing upright or lying on their sides instead. If you hang up rimless tires, they may become deformed.

^[1] Tires installed on rims

13.4.1.2. Tire economy

To preserve your tires as much as possible, there are some things you should keep in mind.

- Correct tire pressure reduces uneven wear. It's important to check the pressure regularly.
- Hard acceleration, heavy braking and driving in a way which causes screeching tires lead to increased tire wear.
- Tire wear increases with speed.
- Unbalanced wheels cause uneven and excessive tire wear, as well as reduced ride comfort.
- Wheels must have the same direction of rotation during their entire service life.
- The rear tire grip should always be equal to or better than the front tire grip to reduce the risk of oversteering in case of heavy braking.
- Tires or wheel rims may be damaged permanently if you hit curbs or drive into deep holes.
- Driving style, road conditions and climate affect the tire wear.

13.4.2. Designations on tire sidewall

There are many digits, numbers and symbols that may be found on a tire's sidewall. Here are some examples and explanations of what they indicate.

Note

Be aware that the following tire designations are only examples. Not all of these designations may be available for your tires, and there may be designations on your tires which are not included here.

Tire dimensions

All tires have a designation of dimensions, such as: 235/60 R18 103H.

235

Tire width (mm).

60

Ratio between tire wall height and tire width (%).

R	Radial ply. The designation RF and symbol specify that the vehicle is equipped with puncture-resistant tires.
18	Rim diameter (inches).
103	Codes for the maximum permitted tire load, Load Index.
It looks like your message was cut off. Could you please provide the full text you'd like me to convert to US English?	Speed rating for maximum permitted speed, Speed Symbol.

Wheel rim dimensions

All wheel rims have a designation of dimensions, such as: 8J x 19 x 50.

8	Rim width (inches).
J	Rim flange profile.
19	Rim diameter (inches).
50	Offset in mm (distance from wheel center to wheel contact surface against the hub).

Weather condition classification

Here are some classification examples. Weather capabilities can also be defined with certain symbols.

M+S or M/S	Mud and Snow.
AT	All Terrain.
AS	All Season.

Tire age

DOT YLX2 0819 Tire Identification Number or TIN. This information helps the tire manufacturer identify tires in the event of safety recalls.

1. DOT^[1]
2. The first two or three characters are the code for the plant where the tire was manufactured.
3. The next two characters are the tire's size code.
4. The last four digits specify the week and year the tire was manufactured. For example, 0819 means that the tire was manufactured during week 08, year 2019.

Any numbers or letters shown in between are market codes chosen by the manufacturer.

Max load and pressure

Max load 685 kg (1610 lbs). Specifies the maximum load that the tire can carry.

Max pressure 240 kPa (35 psi). The maximum tire pressure that the tire should ever be subjected to. This limit is specified by the tire manufacturer.

Minimum permitted load index and speed rating

The tire load index and speed rating might not be shown on the sidewall as this is not a legal requirement.

Type, materials and tire rotation

P	Indicates that the tire is for passenger vehicles.
----------	--

The content of this manual represents the status of the user manual at the time of printing and may not be completely valid in future instances. For more information refer to the first page for the complete disclaimer note.

VOL	Volvo original tires.
Plies: Tread 2 polyester, 2 steel, 1 polyamide. Sidewall 2 polyester.	States the number of cord layers or number of layers with rubber-coated fabric in the tire's tread and sidewall. The tire manufacturers must also state the layer materials used in the tire and sidewall, which may be steel, nylon, polyester and certain other materials.
Arrow symbol	Tires with a tread pattern designed to only turn in one direction have the direction of rotation marked with an arrow.

Classification of uniform tire quality

Tread wear grade 200	The tread wear grade is a comparative rating based on the wear rate of the tire in a standardized test. A higher value is better.
Traction grade AA	The traction grade is based on standardized straight-ahead braking traction tests. The traction grades, from highest to lowest, are AA, A, B and C.
Temperature grade A	The temperature grade reflects the thermal performance of a tire that is properly inflated and not overloaded. The temperature grades, from highest to lowest, are A, B and C.

From the Consumer Guide to Uniform Tire Quality Grading

The purpose of this section is to aid the consumer in making an informed choice in the purchase of passenger vehicle tires.

All passenger vehicle tires must meet federal safety requirements apart from this classification.

Tread wear

The tread wear grade is a comparative rating based on the wear rate of the tire when tested under controlled conditions on a specified government test course. For example, a tire graded 150 would wear one and one-half (1 1/2) times as well on the government course as a tire graded 100. The relative performance of tires depends upon the actual conditions of their use, however, and may depart significantly from the norm due to variations in driving habits, service practices and differences in road characteristics and climate.

Traction

The traction grades, from highest to lowest, are AA, A, B, and C. Those grades represent the tire's ability to stop on wet sidewalk as measured under controlled conditions on specified government asphalt and concrete test surfaces. A tire marked C may have poor traction performance. Warning: The traction grade assigned to this tire is based on straight-ahead braking traction tests, and does not include acceleration, cornering, hydroplaning, or peak traction characteristics.

Temperature

The temperature grades are A (the highest), B, and C, representing the tire's resistance to the generation of heat and its ability to dissipate heat when tested under controlled conditions on a specified indoor laboratory test wheel. Sustained high temperature can cause the material of the tire to degenerate and reduce tire life, and excessive temperature can lead to sudden tire failure. The grade C corresponds to a level of performance that all passenger vehicle tires must meet under the Federal Motor Safety Standard No. 109. Grades B and A represent higher levels of performance on the laboratory test wheel than the minimum required by law. Warning: The temperature grade for this tire is established for a tire that is properly inflated and not overloaded. Excessive speed, underinflation, or excessive loading, either separately or in combination, can cause heat buildup and possible tire failure.

[1] Department of Transportation

13.4.2.1. Tire tread wear indicators

There are tread wear indicators to show the status of the tire's tread depth.



The narrow grooves that run lengthwise across the tire's tread pattern are tread wear indicators. On the side of the tire are the letters TWI^[1].

! Important

- Tires should be changed before wearing them down to the tread wear indicators to avoid poor traction in rain and snow.
- Volvo recommends that winter tires have a greater tread depth than 4 millimeters (1/8 inch) and summer tires 1.6 millimetres (1/16 inch).

^[1] Tread Wear Indicator

13.4.3. Changing wheels

If you need to change a wheel, it's important to follow the recommended procedure.

! Warning

Raising the vehicle to change a wheel

Changing a wheel requires that you raise the wheel off the ground. Carefully follow the separate instructions for raising the vehicle safely.

- If you are changing a wheel in or close to traffic, make sure you and the vehicle are clearly visible to others. Activate the hazard warning flasher, put out a warning triangle in a visible but safe place and wear a reflective vest.
- Designate a safe space for passengers to wait, away from both the vehicle and traffic.
- You are responsible for safety around the vehicle while it is raised. Do not allow people inside or close to the vehicle.
- Never get under the vehicle or let anyone reach under it with any part of their body while it is raised with a jack.

i Note

You must activate jack mode before raising the vehicle off the ground.

Before removing the wheel

The wheels on your vehicle are fastened with wheel bolts. For extra security, you can use lockable bolts.

Put the gear in P and engage the parking brake before starting.

! Important

- Make sure that the dimensions of the replacement wheel are approved for your vehicle.^[1]
- Make sure you read through all the instructions before you start. Get all the tools you need before the vehicle is raised.^[2]
- Use the towing eye as an extended handle for the wheel wrench. The towing eye must be screwed into the wrench as far as it will go.

Removing the wheel

1. Remove the plastic caps from the wheel fasteners using a suitable tool, or pull the wheel cap off.



Tool for removing the wheel fastener caps

2. While your vehicle is still on the ground, use the wheel wrench to loosen the wheel fasteners approximately 0.5-1 turn. Press the wrench downwards while the wrench is extended to the left to avoid personal injury. The counterclockwise rotation loosens the fastener. If you are using lockable bolts, start with them.
3. Follow the instructions on how to safely raise the vehicle.
4. Raise the vehicle high enough so that the wheel you want to remove is off the ground. Remove the wheel fasteners and lift off the wheel.

i Tip

When switching wheels between winter and summer, mark which side they were mounted on, for example L for left and R for right.

Mounting the wheel

The content of this manual represents the status of the user manual at the time of printing and may not be completely valid in future instances. For more information refer to the first page for the complete disclaimer note.

- Clean the surfaces between the wheel and hub.
- Mount the wheel. Make sure you tighten the fasteners. However, the final tightening to the specified torque is done when the wheel is back on the ground and unable to rotate while you do it.

 **Warning**

- Make sure that you put the wheels on the correct axle. Incorrectly mounted wheels can affect the vehicle's handling.
- Never use lubricant on the wheel fastener threads. This could cause the wheel fasteners to loosen after tightening.

- Lower the vehicle back to the ground.
- Fasten the fasteners crosswise. If you are using lockable bolts, finish with those.

It's very important that the fasteners are properly secured. Tighten to 140 Nm (103 lb-ft). Check the tightening torque with a torque wrench. Over-tightened or loosely tightened fasteners may damage the fastening threads or the wheel itself.

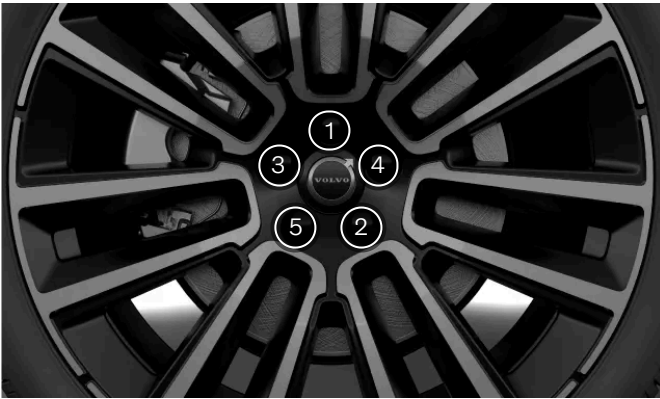

Tighten the wheel fasteners crosswise.

- Place the wheel fastener cover back over the fasteners, using the guide markers to position it correctly, then press it into place. Ensure that it's securely fastened.
- Check the tire pressure and store a new reference value in the tire pressure monitoring system.

 **Warning**

Check the wheel fasteners

The wheel fasteners may need to be re-tightened a few days after the wheel has been changed. Temperature differences and vibrations may cause them to loosen.

Wheel properties after a wheel change

Be attentive to signs of incorrectly mounted wheels. This could affect the vehicle's braking characteristics and the ability to deflect rain and slush.

When you have changed the type or size of the wheels, you should drive carefully at first. The dynamics and driving characteristics of the wheels may have changed.

^[1] Some spare wheels have different dimensions. If your vehicle is approved for the spare wheel you intend to use, the difference in dimensions is okay.

^[2] Use tools that are designed for your vehicle model.

13.4.3.1. Spare wheel

If you get a flat tire, a spare wheel^[1] can be temporarily used until the original wheel can be replaced or repaired.

The spare wheel is only designed for temporary use. You should replace the spare wheel with an ordinary wheel as soon as possible.

Your spare tire can be stored in the spare tire well under the trunk floor.

Important

Do not attempt to unscrew the lower part of the retaining screw that is attached to the vehicle body. There is a risk it may break.

If the lower attachment of the screw does loosen from the body underneath the spare tire, refit it in the hole and turn the screw clockwise to reattach it.

 **Warning**

Removing the spare tire

The spare tire is secured in the spare tire well using a retaining screw. When you take the spare tire out, remove the screw to help prevent injury when the flat tire is replaced.

Before driving with a spare wheel

- Only use a spare wheel that is approved for your vehicle.
- Never drive your vehicle with more than one spare wheel mounted.
- Snow chains cannot be used if the spare wheel is mounted on the front axle.
- The spare wheel should never be repaired.
- On all-wheel drive cars, you can disengage drive on the rear axle.
- Make sure to follow the spare wheel manufacturer's recommendations regarding tire pressure.

Driving with a spare wheel

- Never drive faster than 80 km/h (50 mph) when a spare wheel is mounted on your vehicle.
- Current laws prevents the use of the temporary spare wheel for anything other than as a temporary replacement for a punctured tire.
- Your vehicle's driving characteristics may be affected by using a spare wheel. It is important to replace the spare wheel with an original wheel as soon as possible.

 **Important**

The spare wheel is smaller than your vehicle's original wheels. This will affect the vehicle's ground clearance. Pay attention to high curbs, and don't wash your vehicle in an automatic car wash.

 **Note**

While a spare wheel is used, the tire pressure monitoring system might not work correctly.

^[1] The spare wheel must be of the Temporary Spare type.

13.4.3.2. Winter tires

Winter tires are designed for driving in road conditions with ice and snow. Winter tire tread depth should be deeper than that of regular tires.

Dimensions

When driving with winter tires, it's important that all four tires are of the correct type. Contact a Volvo retailer for advice.

Studded tires

Studded winter tires should be run-in gently for 500-1,000 km (300-600 miles) so that the studs settle properly into the tires. This gives the tire, and especially the studs, a longer service life.

Note

Legal regulations regarding the use of studded tires may vary. Make sure the tires you have mounted are in full compliance with local regulations and laws.

Tread depth

Road conditions with ice, slush, snow and low temperatures put higher demands on your tires than summer conditions. Volvo recommends that winter tires have a tread depth of at least 4 millimeters (0.15 inch).

Note

Speed rating

Winter tires^[1] are allowed to have a lower speed rating than your vehicle's top speed. However, if your winter tires do have a lower speed rating than your vehicle's top speed, you are not allowed to drive faster than tire speed rating.

^[1] Both studded and stud-free tires

13.4.3.3. Using snow chains

Using snow chains can help to improve traction in winter conditions. However, there are some restrictions you have to keep in mind.

Warning

You can use snow chains on your vehicle, with the following restrictions:

- Use genuine Volvo snow chains or equivalent chains designed for the vehicle model, tire and wheel rim dimensions.
- Only single-sided snow chains are permitted.
- The wrong snow chains may cause serious damage to the vehicle and lead to an incident.

Note

Using snow chains may result in malfunction of the tire pressure monitoring system.

Mounting snow chains

- Make sure you are in a safe place when mounting or removing the snow chains.
- Always comply with local regulations and laws regarding the use of snow chains.
- Always carefully follow the mounting instructions from the manufacturer.
- Always use the same type of chain on the left- and right-hand tires.
- Volvo recommends that snow chains are only used on wheels with the following dimensions:
 - 7x16 ET 37 215/60
 - 7x17 ET 40.5 225/50
 - 8x18 ET 42 235/45
- Make sure you use the correct size in relation to the wheels.
- Snow chains must only be used on the front wheels.^[1]
- If wheels of a different size than the original wheels are mounted, certain snow chains must not be used.
- There needs to be sufficient distance between the chains and the vehicle's brakes, suspension and body components. Chains that risk interfering with brake components must not be used.
- If you need to move your vehicle while installing or removing chains, do not let the wheels run over the chain attachments.
- Amount the chains tensioned as tightly as possible and on them at regular intervals.



Practice mounting the snow chains before winter comes.

Driving with snow chains

- Once the snow chains are mounted, drive about 200 meters (650 feet). Then stop the vehicle and check again that the chains are firmly attached.
- Never exceed the chain manufacturer's specified speed limit. You must never exceed 50 km/h (30 mph) under any circumstances.
- While snow chains improve grip in certain conditions, they negatively affect other driving characteristics. If possible, avoid driving over uneven ground, such as bumps or holes. Also avoid fast or sharp turns and hard braking.
- Avoid driving on ground not covered in snow or ice, as this wears out both the snow chains and the wheels.

Contact a Volvo retailer for more information.

^[1] This also applies to all-wheel drive vehicles.

13.4.4. Punctures

If you experience a punctured tire, there are several actions you can take to recover safely, especially if it happens while you are driving.

If the puncture occurs while you are driving, it's important to think about safety first. Activate the hazard warning flashers and, if possible, move the vehicle away from immediate danger. If necessary, call roadside assistance.

Warning

- Do not drive the vehicle if it has a flat tire. It is not safe and will damage the vehicle.
- If possible, exit your vehicle from the side with the least traffic to avoid causing an accident.
- Place a warning triangle so that others are warned of your vehicle well in advance of passing. Remember to first put on a reflective vest if you have one.

Tip

If you need to use a temporary puncture repair kit, be sure to read its instructions before you start to use it.

13.4.5. Tire pressure

Correct tire pressure helps to improve driving stability, lower energy consumption and extend the lifespan of the tire.

Over time, tire pressure decreases. Pressure also varies depending on environmental conditions. All of this is normal. However, if you drive with the wrong tire pressure, the tires may overheat and become damaged. Tire pressure affects ride comfort, noise levels and handling characteristics.

Make it a habit to check the tire pressure monthly and before longer trips. Always make sure you use a reliable pressure gauge. To keep the tires in good shape, use the recommended tire pressure for cold tires.

Warning

If the tire pressure is too high or too low, the tires can sustain severe damage. The tires can explode while you are driving, causing you to lose control of the vehicle.

Tip

Maintaining the correct tire pressure will help you take advantage of your vehicle's full load capacity.

13.4.5.1. Tire pressure monitoring

Your vehicle can detect and indicate when the tire pressure is low. Tire pressure monitoring cannot be disabled. If the system is unable to detect any tire pressure, it will indicate that there's a malfunction.

For the tire pressure monitoring system to provide updated information, you need to drive the vehicle above 35 km/h (22 mph) for several minutes.



An indicator symbol lights up if a low tire pressure is detected in any of the tires. It will stay illuminated until the problem is resolved and a new reference value for the tire pressure has been stored.

In addition to messages in the instrument panel, you can also find information about the tire pressure monitoring in the vehicle status view.

Warning

No advance warning possible

The system cannot give you any advance warning of potential tire damage.

Ensure correct tire pressure immediately

When the low tire pressure symbol is lit, stop and check the tire pressures as soon as possible. Driving with under-inflated tires can cause tire failure.

If the tire pressure monitoring system is not working correctly, the indicator symbol on the instrument panel will first flash for approximately one minute and then remain lit. A message also appears on the instrument panel. If the fault is permanent, service is required.^[1]

Remember:

- The system does not replace the need for regular tire inspection and maintenance.
- The indication symbol for low tire pressure won't disappear until the low tire pressure has been corrected and a new reference value has been saved.
- Whenever the tire pressure is adjusted, such as when changing tires or loads, you need to save a new tire pressure reference value.

Status

You will find information about any issues detected by the tire pressure monitoring system in the center display's vehicle status view.

System description

 **Note**

Your vehicle uses an indirect tire pressure monitoring system. This means you don't need to use wheels mounted with TPMS^[2] sensors.

The following information is phrased according to external legal requirements.

Each tire, including the spare (if provided), should be checked monthly when cold and inflated to the inflation pressure recommended by the vehicle manufacturer on the vehicle placard or tire inflation pressure label. (If your vehicle has tires of a different size than the size indicated on the vehicle placard or tire inflation pressure label, you should determine the proper tire inflation pressure for those tires.)

As an added safety feature, your vehicle has been equipped with a tire pressure monitoring system (TPMS) that illuminates a low tire pressure telltale when one or more of your tires is significantly under-inflated. Accordingly, when the low tire pressure telltale illuminates, you should stop and check your tires as soon as possible, and inflate them to the proper pressure. Driving on a significantly under-inflated tire causes the tire to overheat and can lead to tire failure. Under-inflation also reduces fuel efficiency and tire tread life, and may affect the vehicle's handling and stopping ability.

Please note that the TPMS is not a substitute for proper tire maintenance, and it is the driver's responsibility to maintain correct tire pressure, even if under-inflation has not reached the level to trigger illumination of the TPMS low tire pressure telltale.

Your vehicle has also been equipped with a TPMS malfunction indicator to indicate when the system is not operating properly. The TPMS malfunction indicator is combined with the low tire pressure telltale. When the system detects a malfunction, the telltale will flash for approximately one minute and then remain continuously illuminated. This sequence will continue upon subsequent vehicle start-ups as long as the malfunction exists. When the malfunction indicator is illuminated, the system may not be able to detect or signal low tire pressure as intended. TPMS malfunctions may occur for a variety of reasons, including the installation of replacement or alternate tires or wheels on the vehicle that prevent the TPMS from functioning properly. Always check the TPMS malfunction telltale after replacing one or more tires or wheels on your vehicle to ensure that the replacement or alternate tires and wheels allow the TPMS to continue to function properly.

 **Note**

Certain TPMS malfunctions may require the driver to turn the vehicle off and lock it for 6 minutes for the control module to reset.

If the system still does not work correctly, contact a workshop.^[3]

^[1] Volvo recommends that you visit an authorized Volvo workshop for any repair or service needs.

^[2] Tire Pressure Monitoring System

^[3] Volvo recommends an authorized Volvo workshop.

13.4.5.1.1. Saving a new reference value for tire pressure monitoring

The tire pressure monitoring system needs a reference value to work from. This means that the value needs to be reset in certain circumstances for the system to work properly.

A new reference value needs to be stored when certain changes have been made, such as every time you adjust the tire pressure or change the tires. The reference value may also need to be updated when there is a significant change in the vehicle's weight due to loading or unloading.

 **Warning**

The exhaust gases contain carbon monoxide, which is invisible and odorless, but highly toxic. The procedure to store a new tire pressure must therefore always be performed outdoors or in a workshop with exhaust extraction.

1. Turn the vehicle off.
2. Inflate the tires to the correct tire pressure.^[1]
3. Start the vehicle.
4. Press the vehicle symbol  in the bottom bar and go to **Status** → **Tire pressure**.
5. Select **Update reference pressure**.

 **Note**

The **Update reference pressure** button is used to store a new reference value for the tire pressure monitoring system. For safety reasons, you can only make updates when the vehicle is turned on and stationary.

6. Confirm that you want to store a new value. The confirmation step helps prevent changing the new reference value by mistake.
 - > This overwrites the previous tire pressure and enters a new reference value.
7. Start driving the vehicle. The new value will be stored after driving for several minutes at a speed above 35 km/h (22 mph).
 - >
 - Once a new reference value is stored, the animation showing the saving progress disappears from the center display.
 - If storing fails, an error message is shown.

^[1] See the tire pressure label on the driver's side door pillar or the relevant section in the manual for information on recommended tire pressure for your vehicle.

13.4.5.2. Adjusting tire pressure

The tire pressure needs to be adjusted if you're changing wheels or planning to drive with a different load. It's normal for tire pressure to decrease over time. Adjusting it so that you have the correct pressure for the current situation helps ensure even tire wear and high performance.

The tires need to be at ambient temperature when the pressure is checked and adjusted. This is referred to as having cold tires. Never release air from a warm tire. When it cools down, the internal air pressure drops, which can lead to underinflated or even entirely deflated tires.

The tires can warm up very quickly and should be considered warm if driven for more than approximately 1.5 km (1 mile). They often need about 3 hours of cooling down before reaching ambient temperature again.

1. Remove the tire valve's valve cap and then press the tire pressure gauge firmly onto the valve.
2. Check the gauge to see the current tire pressure.
3. If the pressure is low, inflate the tire to the correct pressure. The recommended pressure for factory-mounted tires is shown on the door pillar on the driver's side.
4. Refit the valve cap^[1] to avoid damage to the valve.
5. Inspect the tire for stuck debris, such as nails or other objects, that could puncture the tire.
6. Check the sidewalls for any cavities, cuts, bumps or other irregularities.
7. Save the tire pressure reference value in the center display once you've adjusted the pressure.

If you accidentally over-inflate the tire, press the metal pin in the middle of the valve to let out the excess air. Then check the pressure again.

After adjusting the tire pressure, remember to store a new reference value in the tire pressure monitoring system.

Note

Spare wheels may have recommended pressures that are different from those of the original tires. Always use the pressure recommended by the spare wheel manufacturer.

^[1] Only use original Volvo dust caps or plastic ones, as metal dust caps may corrode and stick to the valve.

13.4.6. Tire terminology

The following is a list of tire-related terminology.

Tire information placard	A plate that specifies OE ^[1] tire size, recommended tire pressure and the maximum weight the vehicle can carry.
Tire identification number (TIN)	A number on the sidewall of each tire with information about tire brand and manufacturing plant, tire size and date of manufacture.
Inflation pressure	A measurement of how much air is in the tire.
Standard load	A class of P-metric or metric tires designed for a maximum load at 35 psi ^[2] . The load-bearing capacity of the tires does not increase if the tire pressure is increased above this pressure.
Extra load	A class of P-metric or metric tires designed for a heavier maximum load at 41 psi ^[3] . The load-bearing capacity of the tires does not increase if the tire pressure is increased above this pressure.

kPa	Kilopascal, a metric unit for air pressure.
psi	Pounds per square inch, a standard unit for air pressure.
B-pillar	The beam on the side of the vehicle behind the driver's door.
Bead area of the tire	The tire's surface area next to the wheel rim.
Sidewall of the tire	The surface between the base of the tire and the tread.
Tread area of the tire	The surface around the tire in contact with the road when the tire is installed on the vehicle.
Rim	Metal support (wheel) for a tire or tire and inner tube unit against which the base of the tire seals.
Maximum load rating	A figure that specifies the maximum load in pounds and kilograms that the tire can carry. This classification is made by the tire manufacturer.
Maximum permissible inflation pressure	The maximum tire pressure that the tire should ever be subjected to. This limit is specified by the tire manufacturer.
Recommended tire inflation pressure	Tire pressure, specified by Volvo, based on the type of tires installed on a vehicle on delivery. This information is available on the tire plate on the B-pillar on the driver's side and in the tire pressure table.
Cold tires	Tires are considered cold when they have the same temperature as the surrounding air. This temperature is normally reached when the vehicle has been parked for at least three hours.

^[1] Original Equipment

^[2] 37 psi or 2.5 bar for metric tires

^[3] 43 psi or 2.9 bar for metric tires

13.5. Engine compartment

Get familiar with some parts in the engine compartment.

Warning

Always let a workshop perform an engine wash. If the engine is hot, there is a risk of fire.

In this section of the manual, you will find information regarding:

- Coolant fluid
- Engine oil

13.5.1. Engine cooling system

Your vehicle has an advanced temperature regulation system.

The cooling system's purpose is to maintain the correct operating temperature for the engine. The surplus heat can be used to heat the passenger compartment.

It is normal for the engine's cooling fan to keep running for a while after turning the vehicle off.

 **Important**

Check coolant level

The vehicle must only be used when the coolant level is at the correct level. If the level is too low, the engine might overheat and become damaged.

Signs of leakage

Avoid starting the vehicle if there are signs of leakage. This could damage the engine.

Signs of leakage include coolant under your vehicle, steaming coolant or needing to top off the coolant by more than 2 liters (approx. 2 U.S. quarts).

Engine overheating

Under certain conditions, your vehicle may overheat, such as driving in rocky terrain, hot weather or while towing a heavy load. This can limit the engine's power and impact other vehicle features temporarily. For example, the air conditioning may be disabled for a while.

If you see a message in the instrument panel regarding high temperature in the engine or transmission, or a low coolant level, follow the instructions in the message. You may need to refill the coolant or stop the vehicle to let it cool down.

After driving in demanding conditions for a longer period of time, do not turn the engine off immediately after stopping. Leave the engine idling for a few minutes to let it cool.

 **Tip**

When driving in hot weather, remove any auxiliary lights that are mounted in front of the grille can reduce the risk of overheating.

13.5.1.1. Refilling engine coolant

Check your vehicle's coolant level and refill when necessary to prevent engine damage.

 **Warning**

Do not swallow coolant fluid

Never ingest coolant fluid; it can damage your organs. The fluid contains ethylene glycol, inhibitor, water, and other substances.

Heat and pressure

The coolant may be hot after the engine has been running. Let it cool down before unscrewing the lid on the coolant container. Unscrew the lid slowly to release any pressure.

 **Important**

Signs of leakage

Avoid starting the vehicle if there are signs of coolant leakage. This could damage the engine.

Signs of leakage include coolant under your vehicle, steaming coolant or needing to top off the coolant by more than 2 liters (approx. 2 U.S. quarts).

Prescribed quality

- To prevent deterioration of the cooling system, only use coolant approved by Volvo.
- Volvo recommends using ready-mixed coolant.
- If you use concentrated coolant, mix it with pure water at a one-to-one ratio. The purity must meet Volvo's requirements or it could damage the cooling system. Contact Volvo support if you are uncertain.
- Follow the instructions on the coolant's packaging.
- Do not mix different coolants.
- Never refill with water only. Risk of freezing increases with both low and high levels of coolant concentration.

1. Open the hood.



Open the panel hatch in the upper-left corner of the engine compartment to access the coolant container.

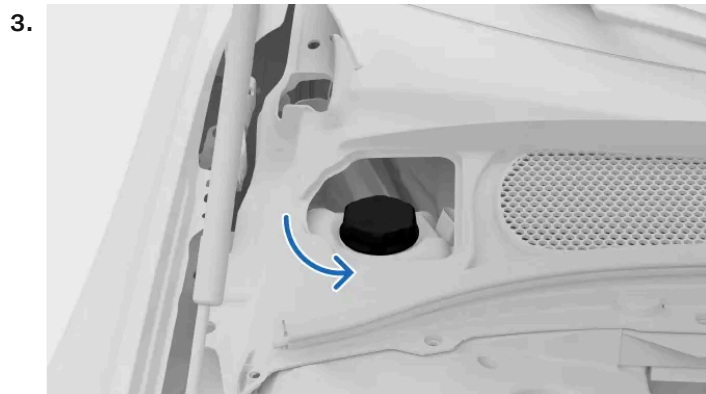

Unscrew the coolant reservoir cap.

4. Check the coolant level and refill if needed. The coolant level must be between the MIN and MAX markings.

When you've finished refilling the coolant, put the parts back in the reverse order. Make sure that everything is properly secured.

13.5.2. Engine oil

Engine oil is used to lubricate, cool and protect different parts of the engine. It can also reduce vibrations and engine noise.

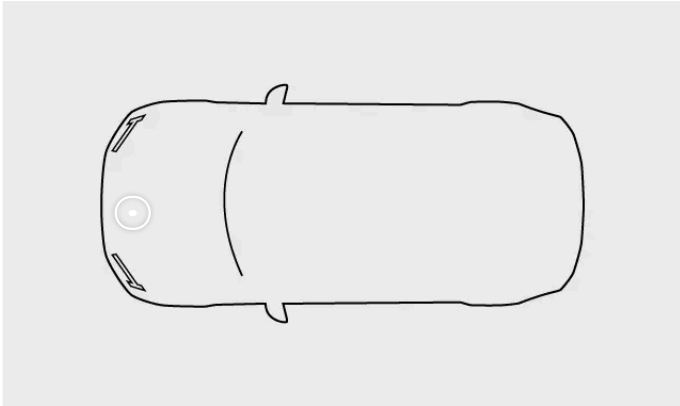

The engine oil label is located in the engine compartment.

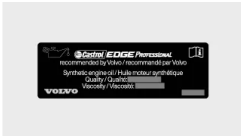

Example of the engine oil label.

! Important

Warranty not applicable

Using engine oil that is not of the prescribed grade and viscosity can damage engine-related components. Volvo does not accept any liability for such damage.

Check engine oil level

The vehicle must only be used when the engine oil level is at the correct level. Driving with low oil can damage the engine.

You must only use engine oil of the prescribed quality, otherwise the recommended service intervals and warranty will not apply. Using engine oil with a different quality can also have a negative effect on your vehicle's service life, starting characteristics, fuel consumption and environmental impact.

Volvo recommends:



The content of this manual represents the status of the user manual at the time of printing and may not be completely valid in future instances. For more information refer to the first page for the complete disclaimer note.

All engines are filled at the factory with a specially-adapted synthetic engine oil that has been carefully selected. This is done to fulfill the requirements for the engine's service intervals.

Volvo recommends that oil changes be done by an authorized Volvo workshop.

Low oil pressure



If you see this symbol in the instrument panel, the engine oil pressure might be low. Stop driving and recover the vehicle to a workshop^[1].

^[1] Volvo recommends an authorized Volvo workshop.

13.5.2.1. Refilling engine oil

You may need to top up the engine oil between service intervals. You only need to do this if a message appears in the instrument panel.



Low oil pressure symbol

Your vehicle has electronic oil level sensors and will warn you if the engine oil level is low. There is no oil dipstick on your vehicle.

You can check the engine oil level in the center display when the vehicle is started. Check the oil level regularly.

You must only use engine oil of the prescribed quality, otherwise the recommended service intervals and warranty will not apply.

1. Turn off the engine.
2. Open the hood.

3. Locate the engine oil lid, placed almost in the center of the engine.



Unscrew the lid slowly to release any pressure.

5. Carefully refill the amount specified in the message. If the level is too high, it can cause the engine to not work properly.



Be careful not to spill any engine oil in the engine compartment. If the oil contacts hot parts, it may cause a fire.

6. Fasten the lid properly again.

No value available

The new oil level will not be detected instantly. To get the correct oil level reading, first drive your vehicle for approximately 30 km (20 miles), then park the vehicle on a level surface for 5 minutes with the engine turned off.

13.6. Vehicle electrical system and batteries

Your vehicle has a specialized electrical system that delivers electricity to and from the batteries.

This section of the manual presents information about several of its electrical components. These include:

- 12 V battery
- 48 V battery
- Fuses



Convenience features

Power-related features, such as USB ports and wireless device charging, are covered in other sections of the manual.



Warning

If not described in the user manual

- Contact an authorized Volvo workshop for any required repairs or servicing that is not clearly described in the user manual.
- Do not modify the vehicle's electrical components.

13.6.1. 12 V battery

The 12 V battery powers the main electric functions in your vehicle.

Keeping the 12 V battery charged

The 12 V battery is charged whenever the engine is running. However, it charges better when the vehicle is being driven. Using a lot of energy without allowing the 12 V battery to charge can lower the battery level, and electrical features may be reduced or disabled.

When you aren't driving the vehicle, avoid using electrical functions such as:

- air conditioning
- headlights
- wipers
- radio
- center display
- or the 12 V outlet and USB ports.

If you still need to use certain features while the vehicle is stationary, turn the engine off to use less power.

If the battery level is below a certain point, you will need to charge it with an external charger or jump-start the vehicle with an external battery.

Servicing and replacement

The service life of the 12 V battery depends on several factors, such as driving conditions and climate conditions. The capacity will decrease over time.

Maintain the battery by driving for at least 15 minutes every week, or connect a battery charger with automatic maintenance charging. Keep the battery fully charged to ensure the longest possible service life.

It is recommended that you contact an authorized Volvo workshop if the 12 V battery needs to be replaced. A replacement battery must have the correct specifications, such as type and capacity.

 **Warning**

- If the 12 V battery has been disconnected, window pinch protection will need to be reset.
- The battery can generate oxyhydrogen gas, which is highly explosive.
- The battery contains sulfuric acid, which can cause serious burns and corrosion. If the sulfuric acid comes into contact with skin or clothes, rinse them with plenty of water. If the acid gets into eyes, seek medical attention immediately.
- Never smoke near the battery.

 **Important**

- Do not disconnect the battery while the engine is running.
- Ensure that all cables are correctly connected to the battery.
- If there is a strap holding the battery in place, make sure it is pulled tight.

12 V battery specifications

Battery type	Voltage	Capacity	Cold start capacity ^[1]	Length	Width	Height
H7 AGM	12 V	80 Ah	800 A	315 mm (12.5 in)	175 mm (6.9 in)	190 mm (7.5 in)

^[1] CCA

13.6.1.1. Battery labels

Low-voltage vehicle batteries have labels containing information for safe handling.

Symbols



Avoid sparks and naked flames.



Use protective goggles.



Store the battery out of reach of children.



The battery contains corrosive acid.



More information in the vehicle's user manual.



Risk of explosion.



If eyes are exposed to battery fluid, immediately flush with water. Seek medical attention as soon as possible.



The battery must be disposed of properly to be recycled.

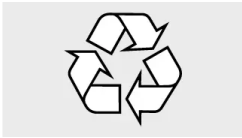

Recycle properly.

i Note

Depicted labels

Labels depicted in this manual are generic representations of those found around your vehicle. The manual only contains their location and what kind of information they contain. Find the actual label for specific information about your vehicle.

13.6.2. 48 V battery

The 48 V battery supports engine starting and can regenerate energy during braking.

Servicing and replacement

The 48 V battery and the box around it must only be handled by authorized technicians. It is recommended that you contact an authorized Volvo workshop if there are any questions or issues. A replacement battery must have the correct specifications, such as type and capacity.

Warning

- Do not touch components which are not clearly described in the user manual. Components with 48 V can be dangerous if handled incorrectly.
- Never use the 48 V battery to jump-start another vehicle.
- Never connect any external equipment to the 48 V battery.

Regenerating power

Your vehicle can recover kinetic energy when braking to reduce fuel consumption and emissions. When you brake while the gear is in D or M, the vehicle will regenerate energy.



A symbol in the instrument panel indicates when your vehicle is regenerating power, such as by braking.

48 V battery specifications

Battery type	Voltage	Capacity	Cold start capacity ^[1]	Length	Width	Height
AGM	12 V	10 Ah	170 A	150 mm (5.9 in)	90 mm (3.5 in)	130 mm (5.1 in)

^[1] CCA

13.6.3. Battery recycling

Used batteries must be recycled in an environmentally sound manner.

Consult Volvo Support if you're unsure of how to dispose of batteries.

The 48 V battery must only be handled by authorized technicians.

13.6.4. Fuses

Electrical fuses protect different parts of the vehicle's electrical system by cutting the power if the current exceeds the fuses' threshold. You need to replace a blown fuse to restore full functionality to the vehicle's electrical system.

You can find the fuse boxes:

- on the right-hand side of the engine compartment, if you are standing in front of the vehicle
- underneath the floor mat under the glove compartment
- On the right-hand side of the trunk, if you are standing behind the vehicle.

Important

Fuse replacement

- Incorrect fuse replacement can cause severe damage to the electrical system.
- A replacement fuse must have the correct specifications, such as type and ampere value.
- A blown fuse may be an indicator of an underlying electrical fault. Volvo recommends an authorized Volvo workshop for all fuse replacements which are not clearly described in the user manual.

13.6.4.1. Replacing a fuse

You need to replace a blown fuse to restore full functionality to the vehicle's electrical system. Contact Volvo support if you are not sure how to do this.

Warning

Risk of damaging electrical components

- Never insert a foreign object instead of a fuse.
- Always use the same type and amperage when replacing a fuse.
- Volvo recommends an authorized Volvo workshop for all fuse replacements which are not clearly described in the user manual.

Tip

Some fuse boxes have spare fuses and special pliers to help. There might also be a diagram of the fuse positions on the fuse box lid.

1. Find the position of the fuse you need to change. Check the fuse box information in this user manual to see which fuse is connected to the feature that is not working.
2. Locate the fuse in your vehicle with the help of the diagram and the number of the relevant fuse.
3. Replace the blown fuse with a new one of the same type and amperage.

13.6.4.2. Fuse box in the trunk

Here you can find fuse positions if you need to change a fuse. The fuses in this box help protect the electronics: for example, in the doors and the seat belt pretensioners. There are several fuse boxes in your vehicle.



Fuse box location

To access the fuse box you need to lift the panel on the right hand side of the trunk.

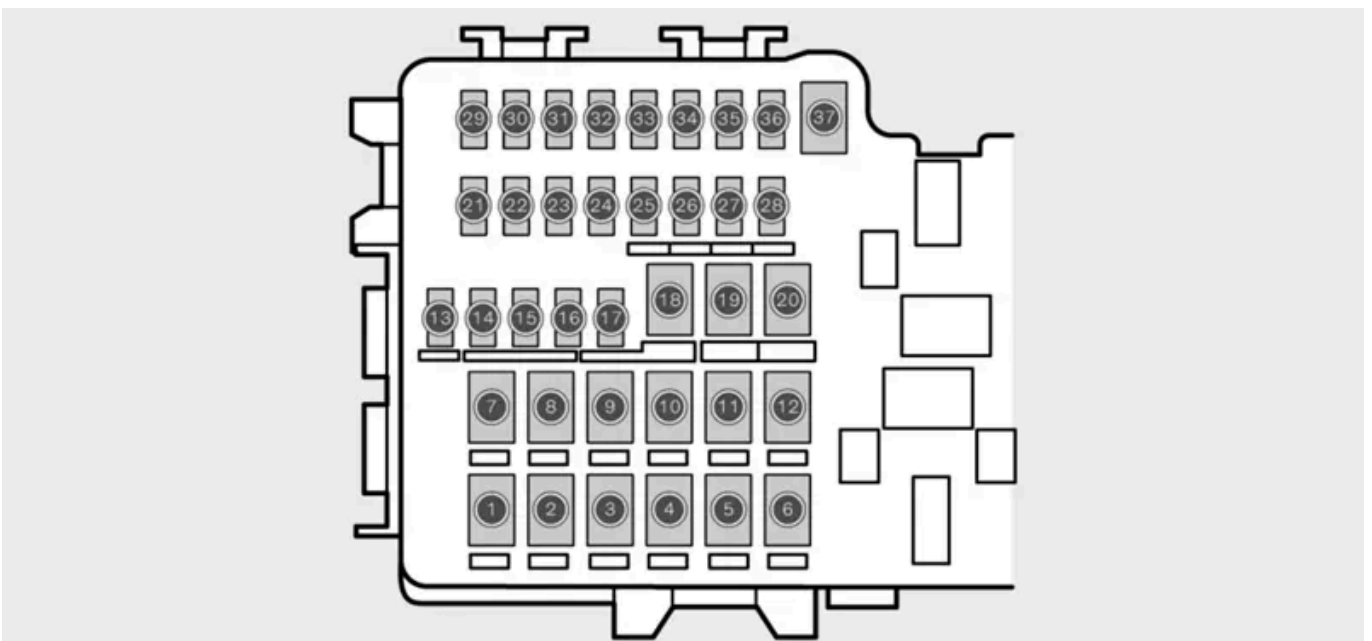

Diagram showing the fuse positions

To access the fuses you need to unclip the box lid.

Number	Feature	Amperage	Type
1	Rear windshield defroster	30	MCase ^[1]
2	Central Electronic Module (CEM)	30	MCase ^[1]
3	–	–	MCase ^[1]
4	Seat locking motor rear right	15	MCase ^[1]
5	–	–	MCase ^[1]
6	Seat locking motor rear left	15	MCase ^[1]
7	Right rear door	20	MCase ^[1]
8	–	–	MCase ^[1]
9	–	–	MCase ^[1]
10	Right front door	20	MCase ^[1]
11	–	–	MCase ^[1]
12	Right seat belt tensioner	40	MCase ^[1]
13	Internal relay coils	5	Micro
14	–	–	Micro
15	Left rear door	20	Micro
16	–	–	Micro
17	–	–	Micro
18	–	–	Micro
19	Left front door	20	MCase ^[1]
20	Left seat belt pretensioner	40	MCase ^[1]
21	–	–	Micro
22	–	–	Micro
23	–	–	Micro
24	–	–	Micro
25	Ignition extended busbar 1	10	Micro
26	–	–	Micro
27	–	–	Micro
28	Left rear seat heating and ventilation	15	Micro
29	Exhaust system actuator	5	Micro
30	Blind spot information	5	Micro
31	–	–	Micro
32	–	–	Micro
33	–	–	Micro
34	–	–	Micro
35	Control unit for four-wheel drive	15	Micro
36	Right rear seat heating and ventilation	15	Micro
37	–	–	MCase ^[1]

^[1] Volvo recommends an authorized Volvo workshop for all fuse replacements of this type.

13.6.4.3. Fuse box in the engine compartment

Here you can find fuse positions if you need to change a fuse. The fuses in this box helps protect the electronics: for example, for the engine and brake features. There are several fuse boxes in your vehicle.



Fuse box location

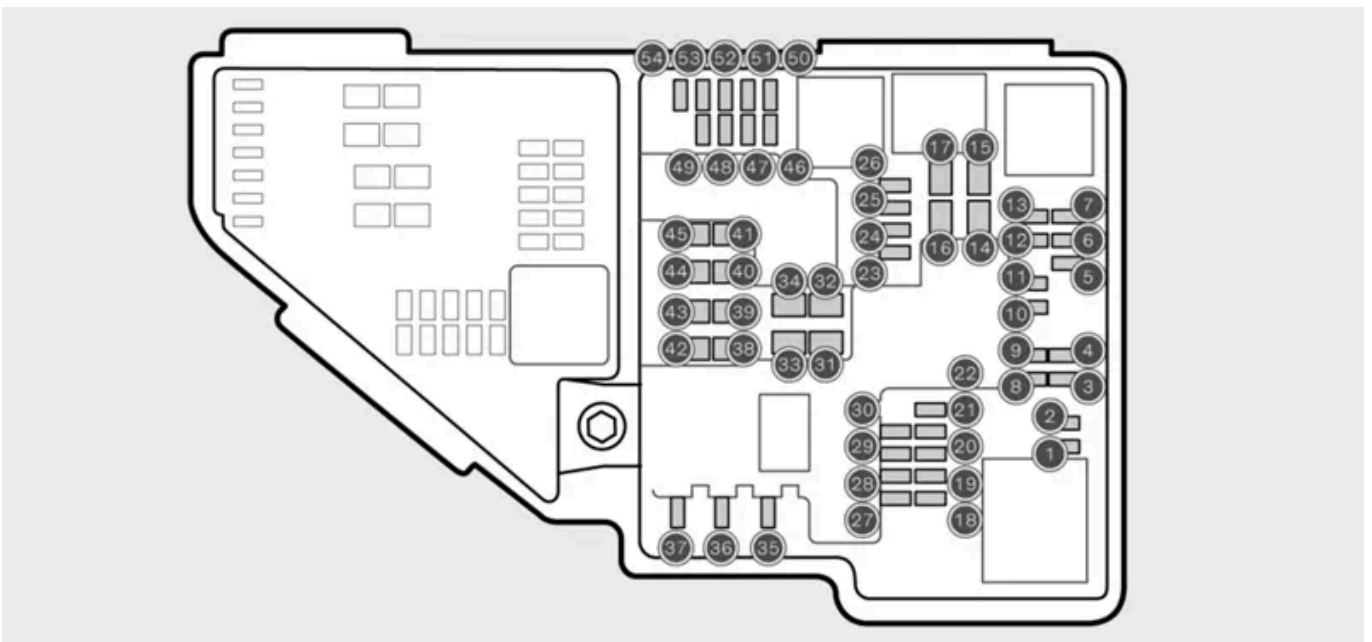

Diagram showing the fuse positions

To access the fuses you need to unclip the box lid.

Number	Feature	Amperage	Type
1	-	-	Micro
2	-	-	Micro
3	Charge pressure (turbo), Lambda sensor	15	Micro
4	Spark plugs	15	Micro
5	Solenoid engine oil pump, Lambda sensor, Solenoid air conditioning compressor	15	Micro
6	Oil level and temperature sensors, Engine component group 1, Glow plug	7.5	Micro
7	Engine Control Module (ECM), Throttle, Engine component group 2	20	Micro
8	Engine Control Module (ECM)	5	Micro
10	Engine component group 3, Glow plug	10	Micro
11	Spoiler damper, Radiator damper, Switching valve for coolant, Fuel leakage inspection pump	5	Micro
12	Coolant pump	15	Micro
13	Engine Control Module (ECM)	20	Micro
14	-	-	MCase ^[1]

The content of this manual represents the status of the user manual at the time of printing and may not be completely valid in future instances. For more information refer to the first page for the complete disclaimer note.

Number	Feature	Amperage	Type
15	–	–	MCase ^[1]
16	Oil pump, Transmission, Turbo configuration medium performance	30	MCase ^[1]
17	–	–	MCase ^[1]
18	Calculation unit	5	Micro
19	–	–	Micro
20	–	–	Micro
21	–	–	Micro
22	–	–	Micro
23	USB port in the rear of center console	7,5	Micro
24	Front 12 V outlet in center console	15	Micro
25	–	–	Micro
26	12 V outlet in the trunk	15	Micro
27	–	–	Micro
28	Left headlight	15	Micro
29	Right headlight	15	Micro
30	–	–	Micro
31	–	–	MCase ^[1]
32	–	–	MCase ^[1]
33	Headlight washers	25	MCase ^[1]
34	Front washer fluid pump	25	MCase ^[1]
35	–	–	Micro
36	Horn	20	Micro
37	Alarm siren	5	Micro
38	Brake system	30	MCase ^[1]
39	Windshield wipers	30	MCase ^[1]
40	–	–	MCase ^[1]
41	–	–	MCase ^[1]
42	–	–	MCase ^[1]
43	Central Electronic Module (CEM)	30	MCase ^[1]
44	–	–	MCase ^[1]
45	–	–	MCase ^[1]
46	Electronic supply	5	Micro
47	Front radar units	5	Micro
48	Right headlight	15	Micro
49	–	–	Micro
50	Transmission	10	Micro
51	–	–	Micro
52	Collision module (SRS), Occupant weight sensor (OWS)	5	Micro
53	Left headlight	15	Micro
54	Accelerator pedal sensor	5	Micro

^[1] Volvo recommends an authorized Volvo workshop for all fuse replacements of this type.

13.6.4.4. Fuse box underneath the glove compartment

Here you can find fuse positions if you need to change a fuse. The fuses in this box helps protect the electronics: for example, in the power outlets, displays and steering wheel. There are several fuse boxes in your vehicle.

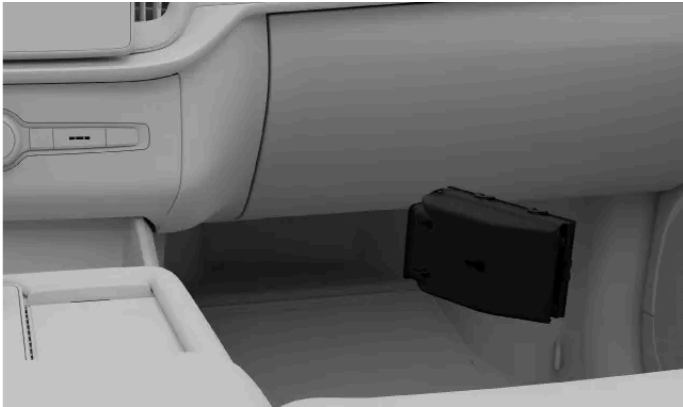

Fuse box location

To access the fuse box, you need to pull the floor mat underneath the glove compartment back.

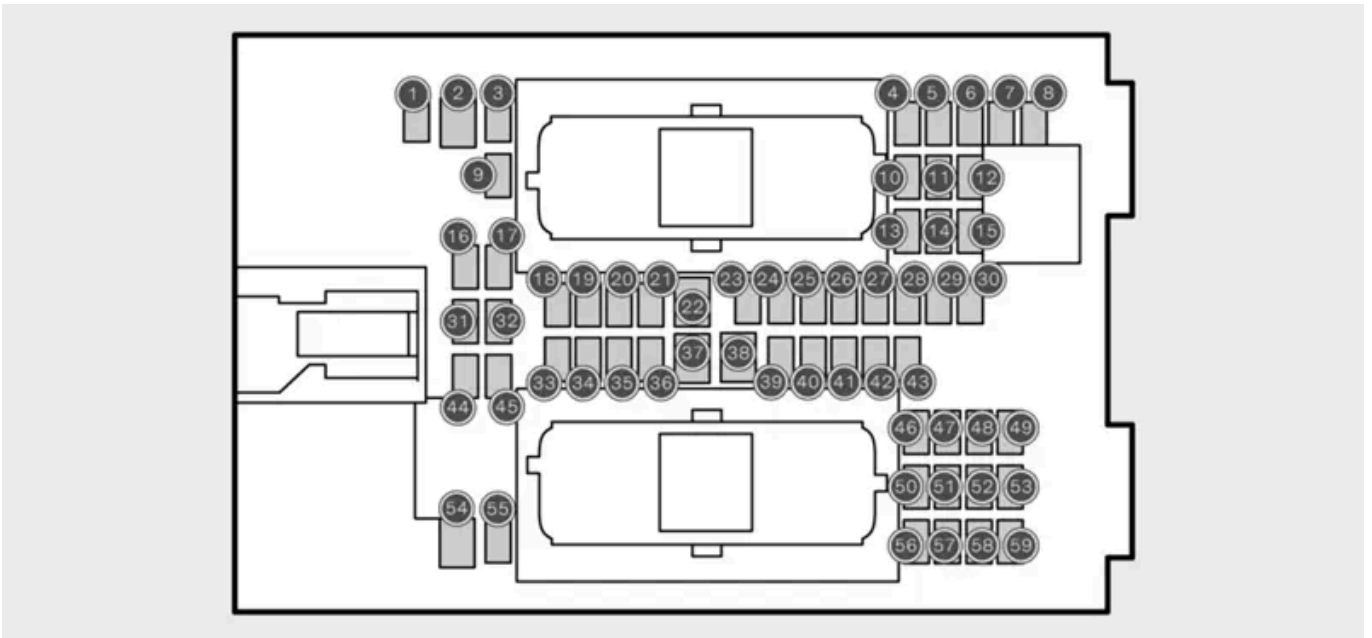

Diagram showing the fuse positions

To access the fuses you need to unclip the box lid.

Number	Feature	Amperage	Type
1	48 V battery	10	Micro
2	-	-	MCase ^[1]
3	-	-	Micro
4	Interior motion sensor	5	Micro
5	-	-	Micro
6	Instrument panel	5	Micro
7	Center console keypad	5	Micro
8	Sun sensor, Toll collection transponder	5	Micro
9	-	-	Micro
10	Infotainment system	15	Micro

Number	Feature	Amperage	Type
11	Steering wheel	5	Micro
12	Start knob and parking brake	5	Micro
13	Heated steering wheel	15	Micro
15	–	–	Micro
16	–	–	Micro
17	–	–	Micro
18	Climate control	10	Micro
19	–	–	Micro
20	On-board diagnostic port OBDII	10	Micro
21	Center display	5	Micro
22	Front fan for climate control	40	MCase ^[1]
23	USB hub	5	Micro
24	Lighting, Doors, Climate control, Seats	7.5	Micro
25	Forward-looking camera	5	Micro
26	Roof console	20	Micro
27	Head-up display	5	Micro
28	Interior lighting	5	Micro
29	–	–	Micro
30	Display roof console, Camera wide-angle	5	Micro
31	–	–	Micro
32	–	–	Micro
33	–	–	Micro
34	Fuse box in trunk	10	Micro
35	Connected services	5	Micro
36	–	–	Micro
37	Audio control device amplifier	40	MCase ^[1]
38	–	–	MCase ^[1]
39	TCAM antenna	5	Micro
40	Front seat comfort control	5	Micro
41	–	–	Micro
42	–	–	Micro
43	Fuel pump	15	Micro
44	Engine start, 48 V converter	5	Micro
45	Driver support features	5	Micro
46	Heated driver's seat	15	Micro
47	Heated passenger seat	15	Micro
48	Coolant pump	7.5	Micro
49	Air cleaner	5	Micro
50	Driver's seat	20	Micro
51	–	–	Micro
52	Foot movement opening of the trunk	5	Micro
53	Infotainment	10	Micro
54	–	–	Micro
55	–	–	Micro
56	Passenger seat	20	Micro
57	–	–	Micro
58	–	–	Micro
59	–	–	Micro

^[1] Volvo recommends an authorized Volvo workshop for all fuse replacements of this type.

13.7. Tools and equipment

Your vehicle is equipped with some tools that may be useful in certain situations. For example, if you need to change a tire.

The tools and equipment in your vehicle are stored in different places, such as in the glove compartment and in the trunk. Be sure to familiarize yourself with where everything is stored so you don't have to search for something when you need it.

 **Warning**

Store tools appropriately

Always store loose tools and equipment in their designated storage areas when not in use. Otherwise, they can cause damage or injury in the event of a collision.

Read all instructions before using tools

Before use, make sure you read and understand any available instructions for tools and equipment.

Contact Volvo support for recommendations concerning tools and equipment for your vehicle.

Towing eye

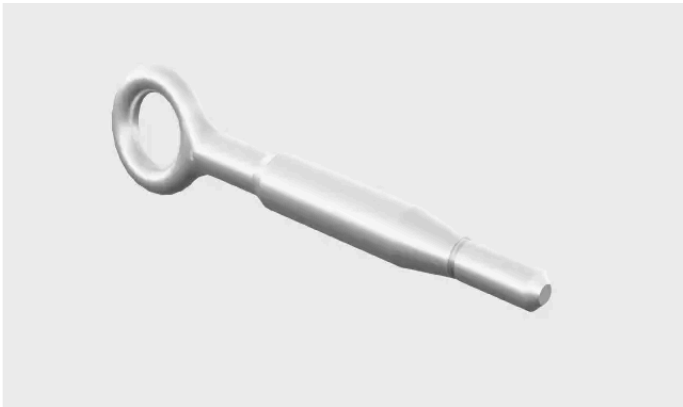

The towing eye can be attached to the vehicle's bumper to enable towing. It can also be used to secure objects carried on the roof that are longer than the roof.

Lug wrench



When changing a tire, you need the wrench to loosen or tighten the lug nuts. The towing eye can be screwed onto the wheel wrench to make an extended handle.

Tool for wheel fastener caps



This tool is for removing the wheel fastener caps when changing the wheels.

Jack



If you need to lift your vehicle—for example to change a tire—you can use the jack.

Funnel for refilling fluids



Use the funnel when refilling fluids, such as engine oil or coolant, to avoid spilling them. Make sure you clean it properly between uses.

13.7.1. Using a warning triangle

Assemble and set out a warning triangle if your vehicle is immobilized in an area where there might be other vehicles. The purpose of the warning triangle is to give other drivers advance notice of your vehicle or other stationary hazards.

Note

Local rules and regulations

Rules and regulations about how and when to put out a warning triangle vary between regions. You are responsible for knowing and following the rules that apply in your location.

Tip

- If it's dark when you set out the warning triangle, wear a reflective vest if you have one. If you don't have one, you can hold the warning triangle so that its reflective parts are visible as you carry it.
- You can place the case on the driver's seat as a reminder to retrieve the warning triangle when you leave.

1. Activate the hazard warning lights.
2. Position the warning triangle in a suitable place with respect to traffic, at a distance that ensures that other drivers are alerted far enough in advance before they reach your vehicle.

Remember to retrieve the warning triangle before you drive off again.

13.7.2. Attaching the towing eye

Use the towing eye to attach a winch wire when towing.

On the right-hand side of the vehicle, the towing eye is screwed into a threaded socket behind a cover located on the front and rear bumpers.

! Important

Be sure to read about towing and its limitations before you start.

Fetch the towing eye so you have it at hand.

Attach in the front

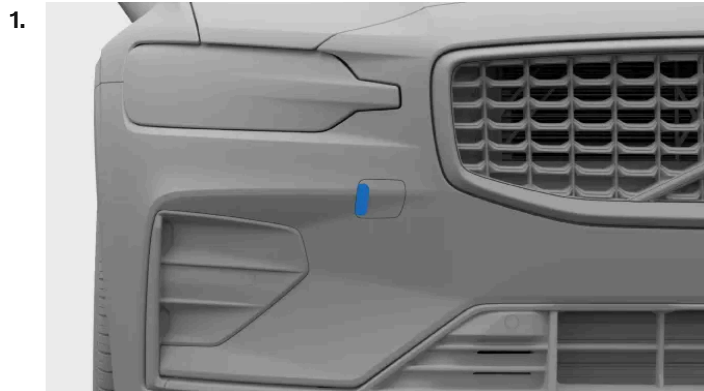

Front towing eye fastening cover

Push on the side of the cover to make it pivot. The cover can then be removed.

Attach in the rear



Rear towing eye fastening cover

To attach in the rear: remove the cover by pushing in the center of its right side. The cover loosens and can then be removed.

3. Screw the towing eye all the way into the socket.

 **Important**

It is important to screw the towing eye firmly into place. Putting something through the towing eye, such as a lug wrench, can provide extra leverage.

After you're done, remember to remove the towing eye and return it to its storage location. Make sure to put the cover back in place to protect the outlet.

13.8. Raising the vehicle

You can raise one wheel off the ground at a time using a jack. Be sure to read all instructions before raising the vehicle.

 **Important**

Recommended or supplied equipment

- The instructions for raising the vehicle presume use of a jack recommended or supplied^[1] by Volvo.
- Only use tools and equipment designed for your vehicle model. Contact a Volvo retailer for tool recommendations.
- Volvo recommends an authorized Volvo workshop for tasks not described in this manual.
- A portable jack designed for occasional and limited use is only suitable for short and urgent tasks, such as handling a flat tire. A workshop jack is recommended for frequent or extended use.

Other lifting equipment

- If using lifting equipment not supplied by Volvo^[2], carefully read the instructions before raising the vehicle. Ensure that the equipment is compatible with the vehicle.
- Use additional safety equipment such as axle stands and wheel blocks when applicable.
- When using workshop jacks or other lifting equipment designed for frequent and extended use, you should use separate lifting areas instead of the ones described in this instruction.

 **Warning**

Safety around the vehicle

- If you are changing a wheel in or close to traffic, make sure you and the vehicle are clearly visible to others. Activate the hazard warning flasher, put out a warning triangle in a visible but safe place and wear a reflective vest.
- Designate a safe area for passengers to wait, away from both the vehicle and traffic.
- You are responsible for safety around the vehicle while it is raised. Do not allow people to stay inside of or close to the vehicle.

Raising the vehicle

- Never get under the vehicle, or let anyone reach under it with any part of their body, while it is raised.
- Do not place any object between the ground and the jack or between the jack and the vehicle's jacking point.
- Do not use lifting equipment that shows any sign of damage.

Before raising the vehicle:

- Gather the tools and parts needed for your planned work.
 - Make sure that the jack is in good condition and that its threads are properly lubricated and free of dirt.
1. Activate the parking brake.
 2. Put the vehicle into P using the gear selector.
 3. Place wheel blocks to reduce the risk of vehicle movement while raised. Large stones or wooden blocks work well. Place them both in front of and behind each wheel that will remain on the ground.
 4. Locate the intended jacking point on the vehicle's underbody.

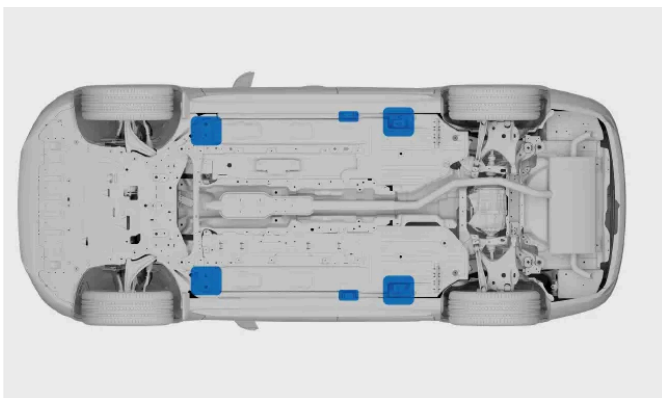

There are two jacking points on each side of the vehicle.

5. Place the jack under the vehicle's jacking point. The surface it stands on must be firm, non-slippery and level. Position the jack with the crank handle pointing away from the vehicle.
6. Crank the jack up until its head slots into the vehicle's jacking point. Ensure that the protruding piece on the jack head fits

into the jacking point slot.

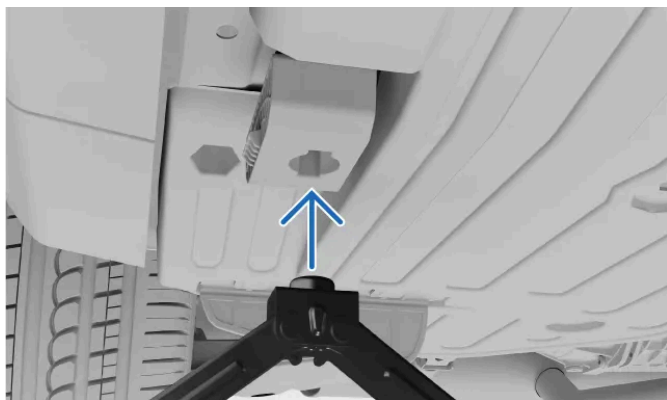

7. Make a final alignment. Make sure that:

- the jack is not leaning in any direction
- the base of the jack is centered under the jacking point
- the jack head meets the jacking point correctly.



8. Raise the vehicle to an appropriate height. Do not raise it higher than necessary for the work you're doing.



Warning

Do not leave the vehicle unsupervised when raised.

Carefully lower the vehicle when you have finished your work. Remember to test important vehicle features that may have been affected by the work you performed.

Put the jack back into its storage place.

Jack mode will deactivate as soon as you start to drive.

[1] Depending on market, a jack for occasional and limited use may be included with your vehicle.

[2] This includes workshop jacks or other lifting equipment designed for frequent and extended use.

13.8.1. Workshop lifting areas

You can use a workshop jack or lifting device designed for frequent and extended use when you raise the vehicle off the ground. However, when you do, you need to ensure that it's placed on the vehicle's lifting areas.

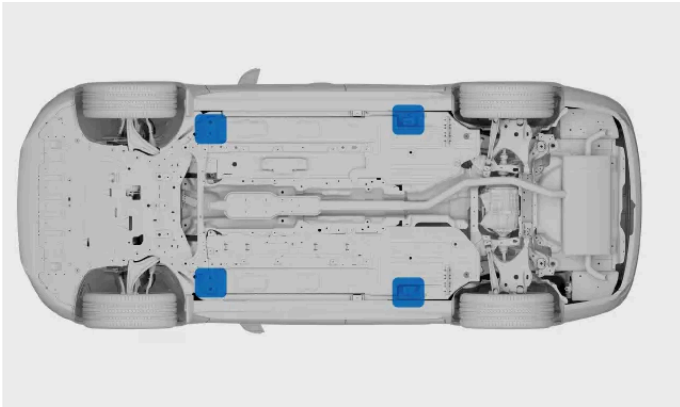

Lifting areas used for workshop equipment.

The lifting areas to use with workshop equipment are positioned at the outer corners of the battery tray. They are just behind the common jacking points, close to the ribbed area.

Important

It is very important to place the workshop jack on the vehicle's lifting areas, or the battery may get damaged.

If you're using a workshop jack, make sure that the jack plate is fitted with a rubber guard to protect the vehicle as well as to ensure that the vehicle remains stable.

If using lifting equipment not supplied by Volvo, carefully read the instructions before raising the vehicle. Ensure that the equipment is compatible with the vehicle.

Note

You must activate jack mode before raising the vehicle off the ground.

13.9. Servicing and repairs

Properly performed maintenance, servicing and repairs are essential for keeping your vehicle in good working condition.

Your vehicle keeps track of when it was last serviced and tells you when it's time to make a new appointment. It can self-diagnose many types of faults and notify you if you need to take action.

If you notice any service or repair needs that have not been detected by the vehicle, contact Volvo support.

Volvo recommends an authorized Volvo workshop for all servicing and repair needs.

 **Important**

Faults and notifications

If a notification in the vehicle calls for a service, make a service appointment as soon as you can. The vehicle status view in the center display also contains information about detected issues.

 **Warning**

- Do not handle or modify the vehicle's electrical components. Only perform actions that are clearly described in the user manual.
- High-voltage components can produce or conduct lethal currents and must only be handled by authorized technicians.
- Do not perform repairs on the vehicle's electrical system or components. Contact an authorized Volvo workshop for any required repairs or servicing.

Volvo's recommended service program

Volvo recommends using authorized Volvo workshops to perform any service and maintenance work. Volvo workshops have the personnel, special tools and service literature required to provide high-quality servicing. Volvo's recommended service program has been developed to give your vehicle a long service life. Servicing your vehicle according to its customized service program may be a prerequisite for coverage under Volvo's warranties. Your vehicle's service and warranty information^[1] contains more details about maintenance service and warranty terms and conditions.

^[1] This is a separate publication included with your vehicle.

13.9.1. Booking service or repairs

Volvo support handles bookings when you need a service or repair appointment. Authorized Volvo workshops have specialized training and equipment to take care of your vehicle.

Your vehicle notifies you when it's time for servicing.

1. Contact Volvo support to book an appointment. They can locate your closest service point.

If you are unable to reach Volvo support and urgently need servicing or repairs, contact a roadside assistance service available in your location.

Make sure to bring your vehicle's standard key to the service appointment.

13.9.2. On-board diagnostic port

Your vehicle has a diagnostic port that allows a workshop to connect to the vehicle and communicate with its systems. Do not connect equipment that has not been authorized by Volvo.

The diagnostic port is type OBDII.

The diagnostic port is located on the underside of the dashboard, close to the hood release lever.

Improper use of the diagnostic port can negatively affect the vehicle's systems and software. This includes connecting unauthorized equipment^[1] and the installation of software or diagnostic tools.



Unauthorized equipment

Volvo accepts no liability if unauthorized equipment is connected to the on-board diagnostic port. Contact an authorized Volvo workshop for more information.

^[1] Equipment not approved by Volvo.

14. Immobilized vehicle and recovery

If you can't drive your vehicle, it's considered immobilized. You can always contact an authorized Volvo workshop if you're unable to find a solution in the manual or if you are uncertain about how to proceed.

Depending on the nature of the problem, you may be able to solve it on your own or with assistance from an authorized Volvo workshop or other services. In this part of the manual, you will find a number of scenarios and how to handle them safely.

In a situation where there are injuries or risk of injury, prioritize safety and medical needs over vehicle recovery. Don't hesitate to contact emergency services if necessary.

The following scenarios have their own manual sections that can help you identify the underlying issue and what the necessary steps for recovery are.

- The vehicle malfunctions and the vehicle can't be used as intended.
- The battery is dead and the vehicle is unresponsive.
- There is physical damage to the vehicle. The damage can make the vehicle unsuitable to drive or cause immobilization. Even superficial damage needs to be evaluated to ensure that you can safely use the vehicle.

14.1. Damaged vehicle

If your vehicle is damaged, it is important to identify the extent and severity of the damage to determine how to handle the vehicle safely.

Damage can immobilize your vehicle or make it unsafe to drive.

Contact an authorized Volvo workshop if your vehicle has been damaged or if it shows signs of damage sustained while parked. If the damage immobilizes or severely impairs the vehicle's performance, you will need to recover it using a roadside assistance and recovery service.

Important

Minor damage

Your vehicle can self-diagnose many defects, but it can't detect all types of damage or predict their consequences. A small impact resulting in superficial damage can harm components behind the affected area, such as misaligning a parking sensor behind a bumper. That's why it's important to have seemingly minor or superficial damage examined by a trained technician to determine the full extent of the damage.

Immobilizing damage

There are several types of damage that can immobilize the vehicle. They include but are not limited to:

- Collision damage
- Flat tire
- Windshield damage

The content of this manual represents the status of the user manual at the time of printing and may not be completely valid in future instances. For more information refer to the first page for the complete disclaimer note.

- Water damage
- Mechanical failure

Collision damage

After a severe-enough collision, your vehicle enters safety mode and needs to be recovered.

Important

If possible, do not try to drive or move the vehicle after a severe collision. The only exception is if the vehicle is a serious hazard to other vehicles on the road, in which case you should move it a short distance so it is out of immediate danger if the vehicle's condition allows you to do so.

Water damage

Water damage can cause permanent damage to your vehicle and severely affect how well it works.

Important

Simply drying the vehicle out or allowing it to dry will often be insufficient to resolve significant water damage. A trained technician should examine any water damage to determine its full extent and severity.

Mechanical damage

The best way to avoid mechanical failures is to follow the intended use and to regularly maintain your vehicle. It is important to continuously perform check-ups of your vehicle.

14.2. Malfunction

When part of your vehicle or one of its features is not working as designed, that is considered a malfunction.

^[1] It may not be safe to use your vehicle at all, depending on what type of malfunction the vehicle is experiencing.

Note

Immobilized vehicle

You should consider the vehicle to be immobilized if a malfunction prevents you from driving safely.

Unresponsive vehicle

There is a separate section in this manual for power-related issues.

General advice for malfunctions

If a function doesn't work properly, try the following actions:

- Read what the manual has to say about the function. Make sure that you are aware of what's required for it to work properly. The problem might mean that you are unaware of a limitation to a specific function.
- Restart all related devices and systems. This applies to the vehicle itself but can also include your phone or an app.
- If there is more than one way to use a function or perform a task, try the alternatives.

 **Note**

Changes after software updates

Software updates can make changes to functions that affect how they work. Be sure to read the information provided with each update so that you understand why the vehicle may behave differently.

Possible causes

When a function isn't working the way you expect it to, there are several possible causes:

- The vehicle's settings have been changed.
- Environmental conditions are affecting the vehicle and its systems.
- Signal interference is affecting connectivity and wireless systems.
- A fuse has blown and needs to be replaced.
- Software error.
- Mechanical failure.

Contact an authorized Volvo workshop if needed

If you can't solve the problem using the information in the manual, contact an authorized Volvo workshop.

Take note of what happened around the time the problem appeared. It may help identify the cause. Examples of key events include:

- Damage to the vehicle.
- Exposure to extreme conditions.
- Recently performed servicing, maintenance or replacement of a component.
- Recently updated software.
- Any other faults or malfunctions.

^[1] In some cases, a suspected fault or failure may instead be an intentional limitation under the conditions experienced by the vehicle.

14.3. Vehicle has no power or is not responding

If your vehicle is not responding or appears to have no power, the cause could be a discharged battery or something affecting its electrical systems.

If the vehicle's battery is discharged, it won't respond to some of your actions. This can include trying to unlock or start it.

Recovery from a discharged 12 V battery

If the 12 V battery is drained, the vehicle will be completely unresponsive. This can happen if something prevents the 12 V battery from being charged while driving.

Suggested recovery actions are:

- Try charging the 12 V battery using an external charger or jump-start the vehicle with an external battery.
- Contact an authorized Volvo workshop or a recovery and roadside assistance service.

Other no-power scenarios

There may be cases where you are fairly sure that the battery level is not low. In these cases, a lack of power indicates that the 12 V battery can't deliver power to the vehicle.

Possible scenarios that affect the 12 V battery's power delivery are:

- A fuse has blown and needs to be replaced.
- The 12 V battery is defective.
- There is an electrical, hardware or software fault preventing the vehicle from turning on.

If you can't identify the cause of the problem or solve it by referring to the manual, contact an authorized Volvo workshop.

14.3.1. Jump-starting your vehicle

If the 12 V battery level is below a certain point, you will need to jump-start your vehicle from an external source. Read through the information before you start and perform each step carefully.

Warning

- If the 12 V battery has been disconnected, window pinch protection will need to be reset.
- The battery can generate oxyhydrogen gas, which is highly explosive.
- The battery contains sulfuric acid, which can cause serious burns and corrosion. If the sulfuric acid comes into contact with skin or clothes, rinse them with plenty of water. If the acid gets into eyes, seek medical attention immediately.
- Never smoke near the battery.

Do not use 48 V components

- Do not touch components which are not clearly described in the user manual. Components with 48 V can be dangerous if handled incorrectly.
- Never use the 48 V battery to jump-start another vehicle.
- Never connect any external equipment to the 48 V battery.

Important

Do not charge another vehicle

The charging points on your vehicle's 12 V battery are only meant for charging your own vehicle. Do not attempt to charge another vehicle.

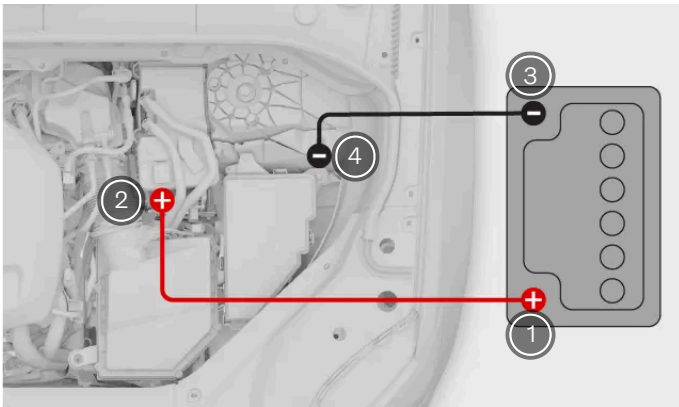

Jumper cable connection

- 1 External battery's positive terminal.
- 2 Positive terminal on your vehicle's 12 V battery.
- 3 External battery's negative terminal.
- 4 Negative terminal on your vehicle.

There are some tasks you need to do before jump starting your vehicle.

- You need access to an external charger or 12 V battery, such as in another vehicle, and a pair of jumper cables.
- Make sure your vehicle is turned off.
- If using another vehicle's 12 V battery, make sure its engine is off and that the vehicles are not in contact with each other.

Connecting the cables

1. Attach the red jumper cable clamp to the external battery's positive terminal.

 **Warning**

Make sure that the jumper cables only come into contact with the charging terminals in the engine compartment. Carefully avoid allowing the jumper cables to contact other components.

2. Remove the cover for the positive terminal on your vehicle's 12 V battery and attach the other end of the red lead to the terminal.
3. Attach the black cable clamp to the external battery's negative terminal.
4. Attach the other end of the black lead to the negative terminal on your vehicle.
5. Check that the clamps are properly attached. Poor contact can cause sparks or loosening of the clamps during the start attempt.

Start attempt

6. Activate the external battery and charge your vehicle's battery for a few minutes. If you are using the battery on another vehicle, let its engine run at a slightly higher idling speed than normal, approx. 1500 rpm.

 **Warning**

Do not touch the cables or clamps while either battery is active. There is a risk of creating sparks.

7. Start your vehicle.
 - > If the start attempt fails, keep charging for 10 minutes and then try again.
8. While your vehicle is still running, remove the leads in the opposite order to how you installed them. First remove the black lead from your vehicle and then the black lead from the external battery. Next, remove the red lead from your 12 V battery and then the red lead from the external battery. Make sure that the black cable does not touch any of the positive terminals or the red cable.

Keep your vehicle running for a while to charge the 12 V battery. It charges better while you drive.

 **Note**

Make sure the start and stop feature is disabled until the battery has had enough time to recharge. Otherwise, there is a risk that the auto-start will fail.

14.4. Recovery

The content of this manual represents the status of the user manual at the time of printing and may not be completely valid in future instances. For more information refer to the first page for the complete disclaimer note.

Vehicle recovery typically requires transporting your vehicle with a recovery vehicle. This is necessary if the vehicle is immobilized and its functions cannot be restored where it is.

Contact an authorized Volvo workshop if you need to recover your vehicle.^[1]

The recommended recovery procedure depends on the conditions and state of the vehicle. If your vehicle is damaged and is in safety mode, it must not be towed and should be lifted onto the recovery vehicle's platform.

 **Important**

Wheels off the ground

Regardless of your vehicle's condition, it must be transported with all wheels off the ground when recovered. Forced wheel rotation during transportation can severely damage the vehicle.

Keep a safe distance

Do not allow anyone to stand directly behind your vehicle if it is pulled onto the recovery vehicle.

^[1] For urgent recovery needs, you can also directly contact a recovery and roadside assistance service.

14.5. Safety mode

If your vehicle detects damage that compromises safety, it can enter safety mode.

Safety mode limits the available functions when your vehicle has sustained damage. The vehicle must undergo damage assessment and repairs^[1] if safety mode has been activated. Contact an authorized Volvo workshop if safety mode has been activated for any reason.

The displays clearly indicate when the vehicle is in safety mode, if they are still functioning.

When safety mode is active, you cannot drive the vehicle. However, if you need to move your vehicle out of immediate danger, you can try to exit safety mode by restarting your vehicle. You should drive with caution after you deactivate safety mode, and only for very short distances, such as to the side of the road.

 **Important**

When you exit safety mode, the vehicle performs a safety check-up. This is communicated in the instrument panel. If the check-up fails, you will not be allowed to deactivate safety mode to move the vehicle.

 **Warning**

Only attempt to exit safety mode if the damage to the vehicle is minor and there is no fuel leakage. Never attempt to restart your vehicle under any circumstance if it smells of fuel when the safety mode message is shown. Leave the vehicle at once.

Resetting your vehicle's status without performing damage assessment and repairs can result in further damage to the vehicle, as well as personal injury.

^[1] Volvo recommends an authorized Volvo workshop

14.6. Having your vehicle towed

Your vehicle can be towed short distances, such as onto a recovery vehicle, if necessary.

 **Important**

The towing eye can be used to pull your vehicle up onto a flatbed recovery vehicle.

 **Important**

Your vehicle should not be towed if it's in safety mode.

Location and ground clearance should also be considered when determining if it can be towed onto a tow truck.

1. Tow your vehicle onto a recovery vehicle or to a safe place, such as the side of the road.
2. When the vehicle is in the necessary place, engage the parking brake.
3. If necessary, remove the towing eye and winch wire.

 **Important**

Always use a recovery vehicle to transport the vehicle whenever it cannot be driven. Forced wheel rotation during transportation can severely damage your vehicle. Make sure the vehicle is only transported by a recovery vehicle such as a flatbed, so that the vehicle's wheels do not touch the ground while being transported.

15. Specifications

These specifications describe your vehicle in technical terms and figures. You might need to find some of these details, such as when buying new tires.

This information is divided up in the following sections, with some examples of their content to help guide you.

- General vehicle characteristics – dimensions, weights, and type designations.
- Powertrain specifications – performance, engine, fuel tank volume and fuel consumption.
- Wheel and tire specifications – approved tire pressures and tire sizes.
- Fluid specifications – engine oil, brake fluid and air conditioning refrigerant.
- Certificates and type approvals

15.1. General vehicle characteristics

These are the basic facts about your vehicle. This information will help you determine your vehicle's specific setup.

You may need to know these things about your vehicle for a number of reasons. For example, to be able to order the right spare parts or accessories.

15.1.1. Vehicle dimensions

Here you can find your vehicle's measurements, such as length and height.

Locate the measurement you're looking for in the images first, then check the corresponding letter in the table below.

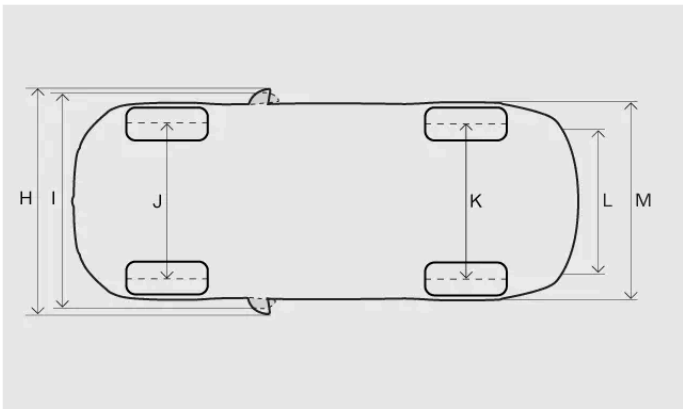
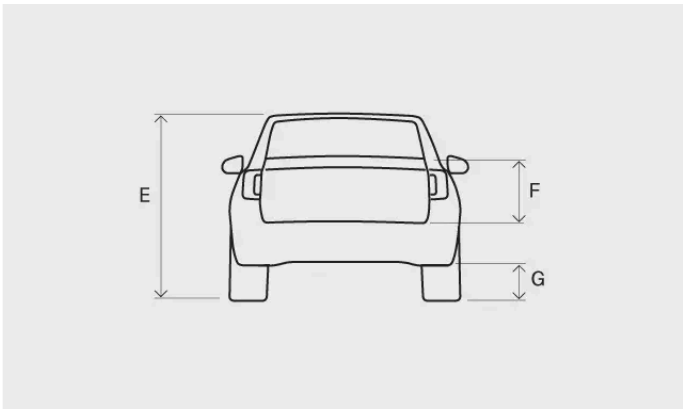
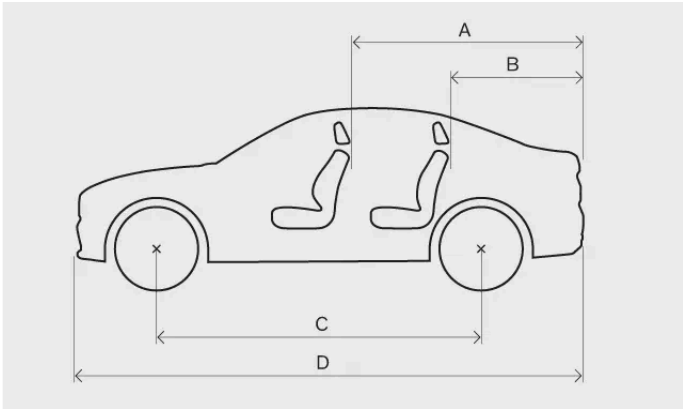

Measurement	Millimeters	Inches
A	1797	70.7
B	1005	39.6
C	2872	113.1
D	4778	188.1
E	1431	56.3
F	485	19.1
G	142	5.6
H	2040	80.3
I	1916	75.4

Measurement		Millimeters	Inches
J	Front wheel track	1610 ^[2] 1603 ^[3] 1600 ^[4] 1593 ^[5]	63.4 ^[2] 63.1 ^[3] 63.0 ^[4] 62.7 ^[5]
K	Rear track	1610 ^[2] 1603 ^[3] 1600 ^[4] 1593 ^[5]	63.4 ^[2] 63.1 ^[3] 63.0 ^[4] 62.7 ^[5]
L	Load width, floor	867	34.1
M	Width	1850	72.8

^[1] At curb weight plus one person.

^[2] Applies to vehicles with 16-inch wheels.

^[3] Applies to vehicles with 17-inch wheels.

^[4] Applies to vehicles with 18- and 19-inch wheels.

^[5] Applies to vehicles with 20-inch wheels.

15.1.2. Weights

You can find your vehicle's maximum gross vehicle weight and other weights below.

	USA (lbs)	Canada (kg)
Gross vehicle weight	5070	2300
Load capacity	890	405
Maximum front axle weight	2580	1170
Maximum rear axle weight	2600	1180
Maximum roof load	165	75
Curb weight	3730–4470	1690–2030

Important

When the vehicle is loaded, it must not exceed the maximum gross vehicle weight and axle weights.

15.1.3. Towing specifications and capabilities

Towing weights and towball loads for driving with a trailer can be viewed below.

! Important

Always follow local rules and regulations when driving with a trailer, such as speed for the vehicle combination.

Braked trailer

Max. gross trailer weight 900 kg

Max. towball load 90 kg

Unbraked trailer

Max. gross trailer weight 750 kg

15.1.4. Towbar specifications

Here you can find measurements related to your towbar.

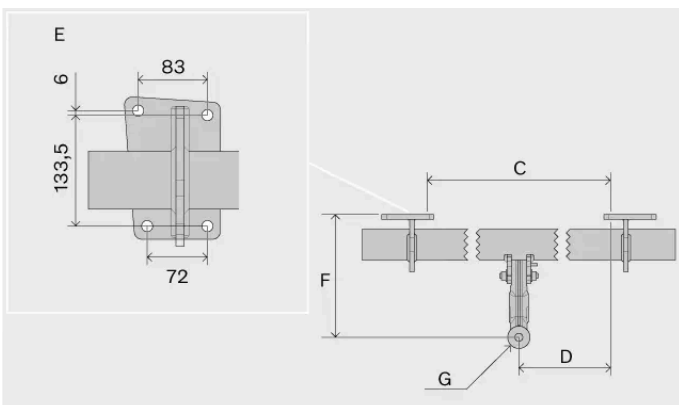
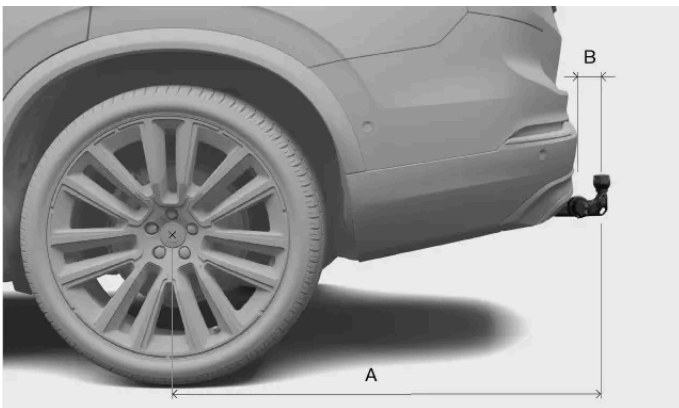

Dimensions, mounting points in mm (inches)

A 1121.9 (44.2)

B 81.5 (3.2)

C 875 (34.4)

D 437.5 (17.2)

The content of this manual represents the status of the user manual at the time of printing and may not be completely valid in future instances. For more information refer to the first page for the complete disclaimer note.

E See above image

F 273.7 (10.8)

G Ball center

15.1.5. Type designations

Knowing the vehicle's detailed information can help facilitate contact with a Volvo retailer and when ordering spare parts and accessories.

Labels

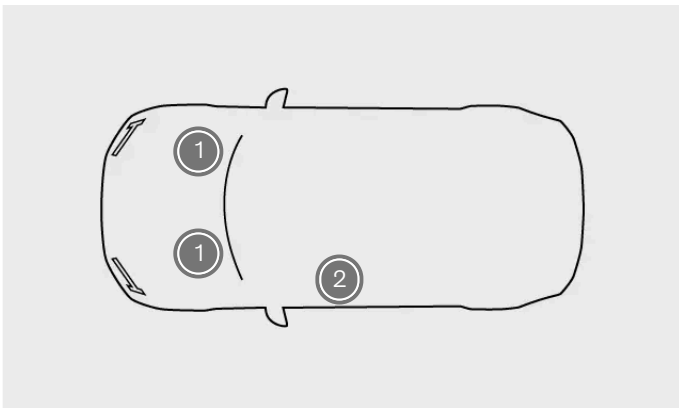

Label locations

- ① Label Vehicle Emission Control Information
- ② Certification label

Your Volvo is designed to meet all applicable emission standards, as evidenced by the label. The label is located on the right and left side of the hood's inner panel and will be visible when the hood is opened.

The certification label is located on the left-hand door pillar and will be visible when the door is open.



Label Vehicle Emission Control Information



Certification label

Examples of information you can find on the certification label:

- Build date
- Vehicle identification number

- Weight information
- Code designation for exterior color

 **Note**

Labels depicted in this manual are generic representations of those found around your vehicle. The manual only contains their location and what kind of information they contain. Find the actual label for specific information about your vehicle.

 **Tip**

For many markets, more information can also be found in the vehicle's registration document.

15.2. Powertrain specifications

Find the specifications regarding your vehicle's propulsion.

These specifications provide details about what your vehicle is capable of and certified for.

15.2.1. Engine specifications

The vehicle is driven by an internal combustion engine, and you can find the specifications here.

 **Note**

If data is missing, it will be updated at a later stage.

15.2.2. Fuel consumption

Fuel consumption may be negatively impacted by several factors.

When driving, the vehicle's fuel consumption can differ. Some reasons for this may be:

- Driving style.
- Extra equipment and cargo affect the vehicle's weight and air resistance.
- Non-standard wheels can increase rolling resistance and air resistance.
- High speed causes increased air resistance.
- Road, traffic and weather conditions.

- The general condition of the vehicle.
- Fuel grade.

15.2.3. Fuel tank volume

The fuel tank's filling capacity can be read below.

Volume Approx. 60 liters (15.9 US gallons) (13.2 UK gallons)

15.3. Wheel and tire specifications

Here you can find specific wheel and tire information applicable to your vehicle.

 **Note**

There are more recommendations regarding wheels and tires that are important to be aware of.

15.3.1. Approved tire pressure

You can find the approved tire pressures for your vehicle in the table below.

The recommended pressure for approved tires can be found on the tire pressure label. It's located on the door pillar on the driver's side and is visible when the door is opened.

Tire size	Cold tire pressure for up to five people	
	Front psi (kPa)	Rear psi (kPa)
225/50 R17 235/45 R18 235/40 R19	36 (250)	36 (250)
Temporary spare tire T125/60 R19	60 (420)	60 (420)

15.4. Fluid specifications

Your vehicle has fluids to help its different systems function properly. When it is time to refill or perform maintenance, you may need to know the specifics of these fluids.

The content of this manual represents the status of the user manual at the time of printing and may not be completely valid in future instances. For more information refer to the first page for the complete disclaimer note.

It is recommended that you get some fluids changed or filled by an authorized Volvo workshop. Check this section for the fluid you need information on and, if necessary, contact an authorized Volvo workshop to schedule an appointment.

15.4.1. Engine oil specifications

The prescribed engine oil grade and volume can be read below.

Volvo recommends Castrol Edge Professional engine oil.

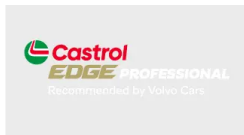

See the Service and warranty booklet for information about oil change intervals.

Oil additives must not be used.

i Note

This vehicle comes from the factory with synthetic oil.

Prescribed grade Fully synthetic engine oil, at least 0W-20 C6 (API SP), must be used. Lower oil grades do not offer the same fuel economy, engine performance and engine protection. Volvo recommends: VCC C6SP SAE 0W-20.

Volume (incl. oil filter) approx. 6.1 liter (6.45 US qt)

15.4.2. Transmission fluid specifications

Under normal driving conditions, the transmission fluid does not need to be changed during the service life of the transmission. However, it may be necessary in adverse driving conditions.

Prescribed transmission fluid AW-2

15.4.3. Brake fluid specifications

The medium in your vehicle's brake system is called brake fluid.

Prescribed grade Volvo Original or equivalent brake fluid that fulfills a combination of the DOT 4, 5.1 and ISO 4925 class 6 classifications.

 **Important**

It is recommended that brake fluid be changed or filled by an authorized Volvo workshop.

15.4.4. Climate system specifications

Here you will find information about the refrigerant quantity and the prescribed quality and volume for compressor oil.

Climate system label



The label with information on climate system fluids is located on the underside of the hood.

On this label you can find:

- Refrigerant type
- Refrigerant quantity

Label symbols



Caution



A trained and certified technician is required to service the mobile air conditioning system^[1]



Flammable refrigerants



Mobile air conditioning system^[1]



Lubricant type

Compressor oil

Volume 130 ml (4.40 US fl oz) (4.58 UK fl oz)

Prescribed grade PAG SP-A2

Servicing and repair of the climate system

The content of this manual represents the status of the user manual at the time of printing and may not be completely valid in future instances. For more information refer to the first page for the complete disclaimer note.

 **Warning**

Servicing and repair

The climate system contains pressurized refrigerant. The climate system must only be serviced and repaired by trained and certified technicians in order to ensure the safety of the system ^[2]. Volvo recommends that you visit an authorized Volvo workshop for any repair or service needs.

 **Important**

Repairing the evaporator

The climate system's evaporator must never be repaired or replaced with a previously used evaporator. A new evaporator must be certified and labeled in accordance with SAE J2842.

^[1] MAC

^[2] In accordance with SAE J2845 (Technician Training for Safe Service and Containment of Refrigerants Used in Mobile A/C System).

15.5. Certificates and type approvals

This documentation shows that your vehicle meets certain standards and specifications.

User manuals are required by law to provide documentation of certain certificates and type approvals.

For more information, contact Volvo Support.

15.5.1. Procedure to temporarily change the automatic high beam sensitivity

You can set an alternative automatic high beam sensitivity in accordance with FMVSS108 requirements.

 **Note**

The vehicle must be stationary to change the sensitivity. Keep the brake pedal pressed down throughout the procedure.

1. Put the vehicle in drive by selecting D with the right-hand steering wheel stalk.
2. Make sure that automatic lights mode **AUTO** is selected with the rotating ring on the left-hand steering wheel stalk.

The following steps must be completed within 20 seconds:

3. Select auto high beam  with the rotating ring on the left-hand steering wheel stalk.
 - > The rotating ring springs back to automatic lights mode AUTO.
4. Repeat the previous step 20 times.





 **Note**







The sensitivity returns to the default setting when you start a new drive cycle.

15.5.2. Type approvals for radar

Find the radar type approval you're looking for among the ones listed here.

Front center radar

Regions	Labels and symbols	Specification
Botswana		BOCRA/TA2019/4981
Brazil		Este equipamento não tem direito à proteção contra interferência prejudicial e não pode causar interferência em sistemas devidamente autorizados.
Canada	IC: 8436B-77V12FLR	This device contains license-exempt transmitter(s)/receiver(s) that comply with Innovation, Science and Economic Development Canada's license exempt RSS(s). Operation is subject to the following two conditions: (1) This device may not cause interference. (2) This device must accept any interference, including interference that may cause undesired operation of the device. L'émetteur/recepteur exempt de licence contenu dans le présent appareil est conforme aux CNR d'Innovation, Sciences et Développement économique Canada applicables aux appareils radio exempts de licence. L'exploitation est autorisée aux deux conditions suivantes : 1) L'appareil ne doit pas produire de brouillage; 2) L'appareil doit accepter tout brouillage radioélectrique subi, même si le brouillage est susceptible d'en compromettre le fonctionnement.
Chile		
European Union & EFTA		Hereby, Veoneer US, Inc. declares that the radio equipment type 77V12FLR is in compliance with Directive 2014/53/EU. Operational frequency band: 76-77 GHz Maximum Output Power: <55dBm EIRP The full text of the EU declaration of conformity is available at the following internet address: https://www.veoneer.com/en/regulatory Manufacturer: Veoneer US, Inc. 26360 American Drive Southfield, MI 48034 USA Phone: +1-248-223-0600

Regions	Labels and symbols	Specification
China		<p>RS4 H 24.05-24.25GHz: 20mW</p> <p>Technical information: Frequency range: 24.05 ... 24.25 GHz Transmission power: 20 dBm (maximum) EIRP</p> <p>Manufacturer and Address: Manufacturer: Hella KGaA Hueck & Co. Address: Rixbecker Straße 75, 59552 Lippstadt, Germany</p>
European Union & EFTA		<p>Hereby, Hella KGaA Hueck & Co. Declares that the radio equipment type RS4 is in compliance with Directive 2014/53/EU.</p> <p>The full text of the EU declaration of conformity is available at the following internet address: www.hella.com/vcc.</p> <p>Technical information: Frequency range: 24.05 ... 24.25 GHz Transmission power: 20 dBm (maximum) EIRP</p> <p>Manufacturer and Address: Manufacturer: Hella KGaA Hueck & Co. Address: Rixbecker Straße 75, 59552 Lippstadt, Germany</p>
Ghana		NCA Approved: 1R3-1M-7E1-0B7
Indonesia	 <p>Dilarang melakukan perubahan spesifikasi yang dapat menimbulkan gangguan fisik dan/atau elektromagnetik terhadap lingkungan sekitarnya</p> <p>For products manufactured in Germany:</p>  <p>For products manufactured in China:</p> 	<p>For products manufactured in Germany:</p> <ul style="list-style-type: none"> Certificate number: 108988/DJID/2025 13809 <p>For products manufactured in China:</p> <ul style="list-style-type: none"> Certificate number: 111350/DJID/2025 13809
Israel		<p>51-8359</p> <p>מספר אישור התאמה מטעם משרד התקשורת: חל איסור לבצע פעולות במכשיר שיש בהן כדי לשנות את תכונותיו האלחוטיות של המכשיר, ובכלל זה שינוי תוכנה, החלפת אנטנה מקורית או הוספת אפשרות לחיבור לאנטנה חיצונית, בלא קבלת אישור משרד התקשורת, בשל החשש להפרעות אלחוטיות.</p>
Japan		<p>This device is granted pursuant to the Japanese Radio Law under the grant ID n° : R 204-750001 This device should not be modified (otherwise the granted designation number will become invalid).</p> <p>R 204-750001</p>
Malaysia		CID F 15000578
Mexico		<p>Radar de corto alcance RS4 Hella KGaA Hueck & Co IFETEL: RLVHERS17-0286</p> <p>La operación de este equipo esta sujeta a las siguientes dos condiciones: (1) es posible que este equipo o dispositivo no cause interferencia perjudicial y (2) este equipo o dispositivo debe aceptar cualquier interferencia, incluyendo la que pueda causar su operación no deseada.</p>
Moldova		
Morocco		<p>AGREE PAR L'ANRT MAROC Numéro d'agrément: MR_20098_ANRT_2019 Date d'agrément: 2019_06_14</p>

Regions	Labels and symbols	Specification
Nigeria		Connection and use of this communications equipment is permitted by the Nigerian Communications Commission.
Oman		Registered No: R/3957/17 Dealer No: D080134
Serbia		И011 17
Singapore		DA 103238
South Africa		TA-2016/3407 APPROVED
South Korea		R-CMM-HLA-RS4 [Placeholder text]
Taiwan		CCAB17LP 0470T5 [Placeholder text]
Thailand		1) [Placeholder text] 2) [Placeholder text]
Ukraine		Цим HELLA GmbH & Co. KGaA заявляє, що радіотехнічне обладнання типу RS4 відповідає Технічному регламенту радіотехнічного обладнання та Директиві 2014/53/ЄС. Повний текст декларації про відповідність доступний за адресою: www.hella.com/vcc Частотний діапазон: 24,05 – 24,25 ГГц Потужність передачі: 20 дБм (макс.) EIRP
United Arab Emirates		Registered No: ER53878/17 Dealer No: DA44932/15
United Kingdom		Hereby, Hella GmbH & Co. KGaA declares that the radio equipment type RS4 is in compliance with Radio Equipment Regulations of the United Kingdom. The full text of the United Kingdom declaration of conformity is available at the following internet address: www.hella.com/vcc [https://www.hella.com/vcc] Technical information: Frequency band: 24.05 ... 24.25 GHz Transmission power: 20 dBm (max.) EIRP Manufacturer and Address: Hella GmbH & Co. KGaA Rixbecker Straße 75, 59552 Lippstadt, Germany
United States	FCC ID: NBG01RS4	This device complies with Part 15 of the FCC Rules. Operation is subject to the following two conditions: (1) this device may not cause harmful interference, and (2) this device must accept any interference received, including interference that may cause undesired operation. CAUTION TO USERS Changes or modifications not expressly approved by the party responsible for compliance could void the user's authority to operate the equipment.
Vietnam		C0173191017AF04A2

Regions	Labels and symbols	Specification
Zambia		ZMB/ZICTA/TA/2017/6/7

15.5.3. Type approval for antenna

You can find the type approval for your vehicle's antenna here.

ID	Description
Continent al Model: TCAM1NA 0 FCC ID:KR5TC AM1NA0 IC:7812D – TCAM1NA 0	<p>This device complies with Part 15 of the FCC Rules and Industry Canada licence-exempt RSS standard(s). Operation is subject to the following two conditions: (1) this device may not cause interference, and (2) this device must accept any interference, including interference that may cause undesired operation of the device.</p> <p>Le présent appareil est conforme aux CNR d'Industrie Canada applicables aux appareils radio exempts de licence. L'exploitation est autorisée aux deux conditions suivantes : (1) l'appareil ne doit pas produire de brouillage, et (2) l'utilisateur de l'appareil doit accepter tout brouillage radioélectrique subi, même si le brouillage est susceptible d'en compromettre le fonctionnement.</p> <p>This device complies with FCC/ISED radiation exposure limits set forth for an uncontrolled environment and meets the FCC radio frequency (RF) Exposure Guidelines and RSS-102 of the ISED radio frequency (RF) Exposure rules. This transmitter must not be co-located or operating in conjunction with any other antenna or transmitter. The antenna should be installed and operated with minimum distance of 2.4 cm between the radiator and your body.</p> <p>Le présent appareil est conforme à l'exposition aux radiations FCC / ISED définies pour un environnement non contrôlé et répond aux directives d'exposition de la fréquence de la FCC radiofréquence (RF) et RSS-102 de la fréquence radio (RF) ISED règles d'exposition. L'émetteur ne doit pas être colocalisé ni fonctionner conjointement avec à autre antenne ou autre émetteur.L'antenne doit être installée de façon à garder une distance minimale de 2.4 centimètres entre la source de rayonnements et votre corps.</p>
FCC Class B digital device notice	<p>This equipment has been tested and found to comply with the limits for a Class B digital device, pursuant to part 15 of the FCC Rules. These limits are designed to provide reasonable protection against harmful interference in a residential installation. This equipment generates, uses and can radiate radio frequency energy and, if not installed and used in accordance with the instructions, may cause harmful interference to radio communications. However, there is no guarantee that interference will not occur in a particular installation. If this equipment does cause harmful interference to radio or television reception, which can be determined by turning the equipment off and on, the user is encouraged to try to correct the interference by one or more of the following measures:</p> <ul style="list-style-type: none"> • Reorient or relocate the receiving antenna. • Increase the separation between the equipment and receiver. • Connect the equipment into an outlet on a circuit different from that to which the receiver is connected. • Consult the dealer or an experienced radio/TV technician for help. <p>Continental Automotive GmbH has not approved any changes or modifications to this device by the user. Any changes or modifications could void the user's authority to operate the equipment.</p> <p>Continental Automotive GmbH n'approuve aucune modification apportée à l'appareil par l'utilisateur, quelle qu'en soit la nature. Tout changement ou modification peuvent annuler le droit d'utilisation de l'appareil par l'utilisateur.</p>
CAN ICES-3 (B) / NMB-3 (B)	<p>This Class B digital apparatus complies with Canadian ICES-003.</p> <p>Cet appareil numérique de classe B est conforme à la norme canadienne ICES-003.</p>

15.5.4. Type approvals for HomeLink

The type approvals for HomeLink[®] ^[1] can be read below.

Country/area	Type approval
USA and Canada	This device complies with FCC rules part 15 and Industry Canada RSS-210. Operation is subject to the following two conditions: (1) This device may not cause harmful interference, and (2) This device must accept any interference that may be received including interference that may cause undesired operation.

Europe	<p>Gentex Corporation hereby declares that HomeLink® Model UAHL5 complies with the Radio equipment directive 2014/53/EU.</p> <p>Wavelength within which the radio equipment functions:</p> <ul style="list-style-type: none"> • 433.05 MHz-434.79 MHz<10mW E.R.P. • 868.00MHz-868.60MHz<25mW E.R.P. • 868.70MHz-868.20MHz<25mW E.R.P. • 869.40MHz-869.65MHz<25mW E.R.P. • 869.70MHz-870.00MHz<25mW E.R.P. <p>Certificate holder address: Gentex Corporation 600 North Centennial Street Zeeland MI 49464, USA</p>
--------	---

Contact Volvo's support for more information.

[1] Option or accessory

15.5.5. Type approval for on-board diagnostics port

Here you can find the type approval for the on-board diagnostics port.

Region	Specification
Canada	<p>IC: 20839-ACU1106</p> <p>This unit corresponds with Industry Canada licensed RSS-standards. Use is permitted under the following two conditions: (1) This unit must not cause Interference and (2) this unit must be able to withstand any received Interference, including interference that can cause unwanted functions.</p>
United States of America	<p>FCC ID: 2AGKKACU11-06</p> <p>This unit corresponds with section 15 of the FCC regulations. Use is permitted under the following two conditions: (1) This unit must not cause dangerous Interference and (2) this unit must be able to withstand any received Interference, including interference that can cause unwanted functions.</p>

15.5.6. Type approval for anti-theft systems

The following information contains type approvals for the anti-theft systems.

Alarm system

Country	Specification
Canada	<p>Canada IC: 4405A-DA 5823(3)</p> <p>This device is subject to the following conditions:</p> <ol style="list-style-type: none"> 1. This device may not cause harmful interference, and 2. this device must accept any interference received, including interference that may cause undesired operation.
United States	<p>USA FCC ID: MAYDA 5823(3)</p> <p>This device complies with part 15 of the FCC rules.</p> <p>Operation is subject to the following conditions:</p> <ol style="list-style-type: none"> 1. This device may not cause harmful interference, and 2. this device must accept any interference received, including interference that may cause undesired operation.

The content of this manual represents the status of the user manual at the time of printing and may not be completely valid in future instances. For more information refer to the first page for the complete disclaimer note.

Immobilizer and Passive Entry/Passive Start systems



Country	Specification
Canada	<p>Canada-IC: 3659A-VO3134</p> <p>This device complies with Industry Canada license-exempt RSS standards. Operation is subject to the following two conditions:</p> <p>Operation is subject to the following two conditions:</p> <ol style="list-style-type: none"> 1. This device may not cause harmful interference, and 2. this device must accept any interference received, including interference that may cause undesired operation. <p>Le présent appareil est conforme aux CNR d'Industrie Canada applicables aux appareils radio exempts de licence.</p> <p>L'exploitation est autorisée aux deux conditions suivantes:</p> <ol style="list-style-type: none"> 1. l'appareil ne doit pas produire de brouillage, et 2. l'utilisateur de l'appareil doit accepter tout brouillage radioélectrique subi, même si le brouillage est susceptible d'en compromettre le fonctionnement.
United States	<p>USA-FCC ID: LTQVO3134</p> <p>This device complies with part 15 of the FCC rules.</p> <p>Operation is subject to the following two conditions:</p> <ol style="list-style-type: none"> 1. This device may not cause harmful interference, and 2. this device must accept any interference received, including interference that may cause undesired operation. <p>Any changes or modification not expressly approved by the party responsible for compliance could void the user's authority to operate this equipment.</p>

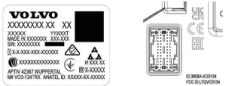

15.5.7. Key systems certification

Here you can find standards compliance certifications for the keys.

















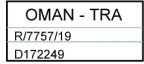

CEM marking for the remote control key system. For supplementary type approval numbers, see the following tables.

Lock system keyless start (Passive Start) and keyless locking/unlocking		
Country/Region	Compliance	Label
Argentina		 H-25867
Brazil	MT-3245/2015	 MT-3245/2015









Country/Region	Compliance	Label
Canada	<p>Volvo Standard Key IC: 4008C-HUF8423MS Volvo Tag ID IC: 4008C-HUF8432MS This device complies with part 15 of the FCC Rules and Industry Canada license-exempt RSS standard(s). Operation is subject to the following two conditions:</p> <ol style="list-style-type: none"> 1. This device may not cause harmful interference, and 2. this device must accept any interference received, including interference that may cause undesired operation. <p>Le présent appareil est conforme aux CNR d'Industrie Canada applicables aux appareils radio exempts de licence. L'exploitation est autorisée aux deux conditions suivantes :</p> <ol style="list-style-type: none"> 1. l'appareil ne doit pas produire de brouillage, et 2. l'utilisateur de l'appareil doit accepter tout brouillage radioélectrique subi, même si le brouillage est susceptible d'en compromettre le fonctionnement. 	
Europe	<p>Hereby, Delphi Deutschland GmbH, 42367 Wuppertal declares that this VO3-134TRX is in compliance with the essential requirements and other relevant provisions of VO3-134TRX The original declaration of conformity can be accessed at the following link www.delphi.com/automotive-homologation [https://www.delphi.com/automotive-homologation]</p>	
Indonesia	Nomor: 38301/SDPPI/2015	
Jordan	TRC/LPD/2014/250	
Malaysia	RAAT/37A/1215/S(15-5198)	
Mexico	IFETEL: RLVDEVO15-0396	
Namibia	TA-2016-02	
Russia		
Serbia	P 1614120100	
South Africa	TA-2014-1868	
United Arab Emirates	ER37847/15 DA0062437/11	
United States	<p>Volvo Standard Key FCC ID: YGOHUF8423MS Volvo Tag ID FCC ID: YGOHUF8432MS This device complies with part 15 of the FCC Rules. Operation is subject to the following conditions:</p> <ol style="list-style-type: none"> 1. This device may not cause harmful interference, and 2. this device must accept any interference received, including interference that may cause undesired operation. <p>CAUTION: Changes or modifications not expressly approved by the party responsible for compliance could void the user's authority to operate the equipment.</p>	







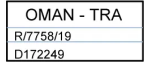

Remote control key

Country/Region	Compliance	Label
Argentina		 H-23694
Belarus		
Brazil	Anatel: 06768-19-06643 Modelo: HUF8423MS Este equipamento opera em caráter secundário isto é não tem direito a proteção contra interferência prejudicial, mesmo de estações do mesmo tipo, e não pode causar interferência a sistemas operando em caráter primário.	 06768-19-06643
Chile		 HUF8423MS
Europe	Hereby, Huf Hülsbeck & Fürst GmbH & Co. KG declares that the radio equipment type HUF8432 is in compliance with Directive 2014/53/EU. The full text of the EU declaration of conformity is available at the following URL: http://www.huf-group.com/eudoc . Frequency band: 433,92 MHz Maximum Transmission Power: 10 mW Manufacturer: Huf Hülsbeck & Fürst GmbH & Co. KG Steeger Str. 17 42551 Velbert Germany	
Ghana	NCA Approved: ZRO-M8-7E3-138	
Indonesia	Sertifikat Nomor: 118151/DJID/2026 PLG ID: 13809	 
Customs Union Kazakhstan, Russia		
Moldova		
Morocco	AGREE PAR L'ANRT MAROC Numéro d'agrément: MR 20402 ANRT 2019 Date d'agrément: 10/07/2019	

Country/Region	Compliance	Label
Nigeria	Connection and use of this communication equipment is permitted by the Nigerian Communications Commission	
Oman		
Philippines	ESD-1919938C	
Paraguay	HUF8423MS	
Serbia		
Singapore	Complies with IMDA Standards DA103787	
South Africa	TA-2019/772	
Taiwan	<p>????????????????????</p> <p>????????????????</p> <p>1.</p> <p>????????????????????</p> <ul style="list-style-type: none"> ???????????????? <p>2.</p> <p>????????????????</p> <ul style="list-style-type: none"> ???????????????? ???????????????? <p>????????????????</p> <p>?????</p>	
United Arab Emirates		
Ukraine	Справжнім Huf Hülsbeck & Fürst GmbH & Co KG заявляє, що тип радіообладнання відповідає Технічному [HUF8423MS] регламенту радіообладнання; повний текст -декларації про відповідність доступний на веб сайті за такою адресою: http:// www.huf-group.com/eudoc Робоча частота: 433,92 ГГц	
Vietnam		
Zambia		

Key tag

Country/Region	Compliance	Label
Argentina		 H-23695
Belarus		
Brazil	Anatel: 04362-16-06643 Modelo: HUF8432MS Este equipo opera em caráter secundário isto é não tem direito a proteção contra interferência prejudicial, mesmo de estações do mesmo tipo, e não pode causar interferência a sistemas operando em caráter primário.	 04362-16-06643
Chile		 HUF8432MS
Europe	Hereby, Huf Hülsbeck & Fürst GmbH & Co. KG declares that the radio equipment type HUF8432MS is in compliance with Directive 2014/53/EU. The full text of the EU declaration of conformity is available at the following URL: http://www.huf-group.com/eudoc . Frequency band: 433,92 MHz Maximum Transmission Power: 10 mW Manufacturer: Huf Hülsbeck & Fürst GmbH & Co. KG Steeger Str. 17 42551 Velbert Germany	
Ghana	NCA Approved: ZRO-M8-7E3-139	
Indonesia	Sertifikat Nomor: 119085/DJID/2026 PLG ID: 13809	 <small>Peringatan: peralatan elektronik yang tidak memenuhi persyaratan dapat menimbulkan gangguan pada peralatan elektronik lainnya yang terhubung dengannya.</small> 
Philippines	ESD-1919939C	 NTC Type Approved No.: ESD-1919939C
Moldova		
Morocco	AGREE PAR L'ANRT MAROC Numéro d'agrément: MR 20403 ANRT 2019 Date d'agrément: 10/07/2019	

Country/Region	Compliance	Label
Nigeria	Connection and use of this communications equipment is permitted by the Nigerian Communications Commission	
Oman		
Paraguay	HUF8432MS	
South Africa	TA-2019-773	
Serbia		
Singapore	Complies with IMDA Standards DA103787	
Taiwan	<p>????????????????????</p> <p>????????????????</p> <p>1.</p> <p>????????????????????</p> <ul style="list-style-type: none"> ???????????????? <p>2.</p> <p>????????????????</p> <ul style="list-style-type: none"> ???????????????? ???????????????? <p>????????????????</p> <p>??????</p>	
United Arab Emirates		
Ukraine	Справжнім Huf Hüsbeck & Fürst GmbH & Co KG заявляє, що тип радіобладнання відповідає Технічному [HUF8423MS] регламенту радіобладнання; повний текст -декларації про відповідність доступний на веб сайті за такою адресою: http:// www.huf-group.com/eudoc Робоча частота: 433,92 ГГц	
Vietnam		
Zambia		

Central Electronic Module

Country/Region	Compliance	Label
Indonesia	Sertifikat Nomor: 85998/SDPPI/2022 PLG ID: 13809	

15.5.8. Advanced air cleaning certification

Here you find the certification for the advanced air cleaning.

The Advanced air cleaner (Part numbers 31497530, 31497531) has been certified by the California air resource board (CARB). The product has been tested according to the following standards: Electrostatic Air Cleaners [UL 867:2011 Ed.5+R:16Aug2021] Electrostatic Air Cleaners [CSA C22.2#187:2020 Ed.5] This product complies with the maximum allowable concentration of ozone of 0.050 parts per million by volume (ppmv) in a 24-h period.



15.5.9. Instrument panel license agreements

You can find the instrument panel license agreements between Volvo and the manufacturer or developer listed here.

The table contains the open source software (OSS) components used within the product under the terms of the respective licenses. The source code corresponding to the open source components is also provided, along with the product wherever mandated by the respective OSS license.

Table of open source components used					
SI number	Name of OSS component	Version of OSS component	Name and version of license text	Website	More information
1	BidiReferenceCpp	26	Unicode Terms of Use	http://www.unicode.org/Public/PROGRAMS/BidiReferenceCpp/	(C) Socionext Embedded Software Austria GmbH (SESA) Copyright (C) 1999-2009, ASMUS, Inc
2	FASTCRC32	1.2.8	License of Stephan brumme/ Zlib style License	http://stephan-brumme.com/	Copyright © 2011-2013 Stephan Brumme. All rights reserved, Copyright (C) 1995-2006, 2010, 2011, 2012 Mark Adler
3	Freescale IMX6 HDMI	5.0.11	BSD 3-clause "New" or "Revised" License	https://www.nxp.com/ [https://www.nxp.com/]	Copyright © 2009-2012, Freescale Semiconductor, Inc, Copyright © 2010-2012, Freescale Semiconductor, Inc.
4	FreeType Hashing	2.6.3	MIT License	https://sourceforge.net/p/canvasdraw/cd/642/tree/trunk/freetype/include/freetype/internal/fthash.h [https://sourceforge.net/p/canvasdraw/cd/642/tree/trunk/freetype/include/freetype/internal/fthash.h]	Copyright 2000 Computing Research Labs, New Mexico State University Copyright 2001-2015 Francesco Zappa Nardelli

SI number	Name of OSS component	Version of OSS component	Name and version of license text	Website	More information
5	Freetype Project - BDF	2.6.3	MIT License	https://sourceforge.net/projects/freetype/files/freetype2/2.6.3/ [https://sourceforge.net/projects/freetype/files/freetype2/2.6.3/]	Copyright (C) 2001-2014 by Francesco Zappa Nardelli. Copyright 2000 Computing Research Labs, New Mexico State University
6	Freetype Project -PCF	2.6.3	MIT License	https://sourceforge.net/projects/freetype/files/freetype2/2.6.3/ [https://sourceforge.net/projects/freetype/files/freetype2/2.6.3/]	Copyright 2000-2001, 2003 by Francesco Zappa Nardelli Copyright (C) 2000, 2001, 2002, 2003, 2006, 2010 by Francesco Zappa Nardelli Copyright (C) 2000-2004, 2006-2011, 2013, 2014 by Francesco Zappa Nardelli Copyright 2000-2010, 2012-2014 by Francesco Zappa Nardelli Copyright 2003 by Francesco Zappa Nardelli
7	Freetype Project - Pcfutil	2.6.3	Open Group License	https://sourceforge.net/projects/freetype/files/freetype2/2.6.3/ [https://sourceforge.net/projects/freetype/files/freetype2/2.6.3/]	Copyright 1990, 1994, 1998 The Open Group
8	HarfBuzz	1.3.1	MIT License	http://freedesktop.org/wiki/Software/HarfBuzz	Copyright © 2007 Chris Wilson Copyright © 2009,2010 Red Hat, Inc. Copyright © 2011,2012 Google, Inc.
9	Integrity Libnet	1.16	Internet Software Consortium-IBM License ISC License	https://github.com/lattera/glibc/blob/master/resolv/inetpton.c [https://github.com/lattera/glibc/blob/master/resolv/inetpton.c]	Copyright © 1996 by Internet Software Consortium. Consortium, Copyright © 1995 by International Business Machines, Inc.
10	Khronos EGL Headers	1.3	MIT License	http://www.khronos.org/registry/egl/	Copyright © 2007-2013 The Khronos Group Inc. Copyright 2008 VMware, Inc. Copyright © 2013-2014 The Khronos Group Inc.
11	Khronos Group - OpenGL ES	1.4	SGI Free Software License B v2.0	http://www.khronos.org/opengles/	
12	libjpeg	6b	Independent JPEG Group License	http://www.ijg.org/	Copyright (C) 1991-1998, Thomas G. Lane.
13	libpng	1.4.22	libpng License	http://github.com/cvlibs/packages/libpng/	Copyright © 1998-2010 Glenn Randers-Pehrson Copyright © 2007, 2009 Glenn Randers-Pehrson Version 0.96 Copyright © 1996, 1997 Andreas Dilger Version 0.88 Copyright © 1995, 1996 Guy Eric Schalnat, Group 42, Inc.
14	Libunibreak	1.2.8	zlib License	https://github.com/adah1972/libunibreak [https://github.com/adah1972/libunibreak]	Copyright (C) 2008-2011 Wu Yongwei Copyright (C) 2012 Tom Hacothen tom@stosb.com
15	Iz4 Compression algorithm	1.4.0	BSD 2-clause "Simplified" License	http://github.com/Cyan4973/iz4/	Copyright (C) 2011-2014, Yann Collet

SI number	Name of OSS component	Version of OSS component	Name and version of license text	Website	More information
16	md5	1.6	Public Domain	https://doxygen.reactos.org/d7/d04/sdk_2lib_23rdparty_2freetype_2src_2base_2md5_8c_source.html [https://doxygen.reactos.org/d7/d04/sdk_2lib_23rdparty_2freetype_2src_2base_2md5_8c_source.html]	
17	NetBSD	1.9	BSD-4-Clause (University of California-Specific), BSD3, IBM License, HPND like license, BSD 2-clause "Simplified" License, BSD One Clause License	http://www.netbsd.org/	Copyright © 1998 Manuel Bouyer Copyright © 1996 Matt Thomas., Copyright 1997 Marshall Kirk McKusick. All Rights Reserved, Copyright © 1985, 1988, 1989, 1991, 1993, 1995 The Regents of the University of California Copyright © 1989, 1993 The Regents of the University of California Copyright © 1983, 1993 The Regents of the University of California Copyright 2000-2011 Green Hills Software Copyright (c) 1996 by Internet Software Consortium. Copyright (C) 1998 WIDE Project, Portions Copyright © 1995 by International Business Machines, Inc, Copyright (C) 1994, 1995, 1997 Tool Labs GmbH Copyright (C) 1994, 1995, 1997 Wolfgang Solfrank Copyright © 1995, 1999 Berkeley Software Design, Inc Portions Copyright © 1993 by Digital Equipment Corporation Copyright © 1992 Henry Spencer Copyright © 1997, 1998, 1999 The NetBSD Foundation, Inc Copyright © 1996 by Internet Software Consortium. Copyright (c) 1994 James A. Jegers(c) © UNIX System Laboratories, Inc.
18	NetBSD_BSD4	1.9	BSD 4-clause "Original" or "Old" License	http://www.netbsd.org/	Copyright 2000-2011 Green Hills Software Copyright © 1994, 1998 Christopher G. Demetriou, Copyright © 1982, 1986, 1990, 1993, 1994 The Regents of the University of California. All rights reserved. © UNIX System Laboratories, Inc.
19	The FreeType Project - freetype2	2.6.3	Freetype Project License	http://sourceforge.net/projects/freetype/	Copyright 1996-2016 by David Turner, Robert Wilhelm, and Werner Lemberg, Copyright 2007-2016 by Rahul Bhalariao, Copyright 2009-2016 by Oran Agra and Mickey Gabel, Copyright 2008-2016 by David Turner, Robert Wilhelm, Werner Lemberg, and Suzuki Toshiya, Copyright 2000 Computing Research Labs, New Mexico State University, Copyright 2001-2015 Francesco Zappa Nardelli, Copyright 2004-2016 by Masatake YAMATO and Redhat K.K, Copyright 2007-2016 by Derek Clegg and Michael Toftdal, Copyright 2010-2016 by Joel Klinghed, Copyright 2007-2013 Adobe Systems Incorporated, Copyright 2007-2014 Adobe Systems Incorporated, Copyright 2004-2016 by Albert Chin-A-Young, Copyright 2013-2016 by Google, Inc, Copyright 2002-2016 by Roberto Alameda, Copyright 2003 Huw D M Davies for Codeweavers, Copyright 2007 Dmitry Timoshkov for Codeweavers
20	Vivante Driver software	viv5.0.11 p7.4.i3	MIT License	http://www.vivantecorp.com/	Copyright 2012 - 2016 Vivante Corporation, Santa Clara, California Copyright © 2007 The Khronos Group Inc Copyright © 2014 - 2016 Vivante Corporation Copyright 2012 Vivante Corporation, Sunnyvale, California Copyright © 2011 Intel Corporation Copyright (C) 1999-2001 Brian Paul
21	zlib	1.2.8	zlib License	http://www.zlib.net/	Copyright (C) 1995-2007 Mark Adler Copyright (C) 1995-2005 Jean-loup Gailly Copyright (C) 1995-2012 Mark Adler Copyright (C) 2003 Chris Anderson Copyright (C) 1998 Brian Raiter
22	RBTree.cpp	3.4.2	Public Domain	https://www.eu.socionext.com/ [https://www.eu.socionext.com/]	(C) Socionext Embedded Software Austria GmbH (SESA)

License text

License name License text

License name	License text
HPND Like license	<p>Portions Copyright (c) 1993 by Digital Equipment Corporation.</p> <p>Permission to use, copy, modify, and distribute this software for any purpose with or without fee is hereby granted, provided that the above copyright notice and this permission notice appear in all copies, and that the name of Digital Equipment Corporation not be used in advertising or publicity pertaining to distribution of the document or software without specific, written prior permission.</p> <p>THE SOFTWARE IS PROVIDED "AS IS" AND DIGITAL EQUIPMENT CORP. DISCLAIMS ALL WARRANTIES WITH REGARD TO THIS SOFTWARE, INCLUDING ALL IMPLIED WARRANTIES OF MERCHANTABILITY AND FITNESS. IN NO EVENT SHALL DIGITAL EQUIPMENT CORPORATION BE LIABLE FOR ANY SPECIAL, DIRECT, INDIRECT, OR CONSEQUENTIAL DAMAGES OR ANY DAMAGES WHATSOEVER RESULTING FROM LOSS OF USE, DATA OR PROFITS, WHETHER IN AN ACTION OF CONTRACT, NEGLIGENCE OR OTHER TORTIOUS ACTION, ARISING OUT OF OR IN CONNECTION WITH THE USE OR PERFORMANCE OF THIS SOFTWARE.</p>
BSD 2-clause "Simplified" License	<p>BSD Two Clause License</p> <p>Redistribution and use in source and binary forms, with or without modification, are permitted provided that the following conditions are met: Redistributions of source code must retain the above copyright notice, this list of conditions and the following disclaimer. Redistributions in binary form must reproduce the above copyright notice, this list of conditions and the following disclaimer in the documentation and/or other materials provided with the distribution.</p> <p>THIS SOFTWARE IS PROVIDED BY THE AUTHOR "AS IS" AND ANY EXPRESS OR IMPLIED WARRANTIES, INCLUDING, BUT NOT LIMITED TO, THE IMPLIED WARRANTIES OF MERCHANTABILITY AND FITNESS FOR A PARTICULAR PURPOSE ARE DISCLAIMED. IN NO EVENT SHALL THE AUTHOR BE LIABLE FOR ANY DIRECT, INDIRECT, INCIDENTAL, SPECIAL, EXEMPLARY, OR CONSEQUENTIAL DAMAGES (INCLUDING, BUT NOT LIMITED TO, PROCUREMENT OF SUBSTITUTE GOODS OR SERVICES; LOSS OF USE, DATA, OR PROFITS; OR BUSINESS INTERRUPTION) HOWEVER CAUSED AND ON ANY THEORY OF LIABILITY, WHETHER IN CONTRACT, STRICT LIABILITY, OR TORT (INCLUDING NEGLIGENCE OR OTHERWISE) ARISING IN ANY WAY OUT OF THE USE OF THIS SOFTWARE, EVEN IF ADVISED OF THE POSSIBILITY OF SUCH DAMAGE.</p>
IBM license	<p>Portions Copyright (c) 1995 by International Business Machines, Inc.</p> <p>International Business Machines, Inc. (hereinafter called IBM) grants permission under its copyrights to use, copy, modify, and distribute this Software with or without fee, provided that the above copyright notice and all paragraphs of this notice appear in all copies, and that the name of IBM not be used in connection with the marketing of any product incorporating the Software or modifications thereof, without specific, written prior permission. To the extent it has a right to do so, IBM grants an immunity from suit under its patents, if any, for the use, sale or manufacture of products to the extent that such products are used for performing Domain Name System dynamic updates in TCP/IP networks by means of the Software. No immunity is granted for any product per se or for any other function of any product.</p> <p>THE SOFTWARE IS PROVIDED "AS IS", AND IBM DISCLAIMS ALL WARRANTIES, INCLUDING ALL IMPLIED WARRANTIES OF MERCHANTABILITY AND FITNESS FOR A PARTICULAR PURPOSE. IN NO EVENT SHALL IBM BE LIABLE FOR ANY SPECIAL, DIRECT, INDIRECT, OR CONSEQUENTIAL DAMAGES OR ANY DAMAGES WHATSOEVER ARISING OUT OF OR IN CONNECTION WITH THE USE OR PERFORMANCE OF THIS SOFTWARE, EVEN IF IBM IS APPRISED OF THE POSSIBILITY OF SUCH DAMAGES.</p>
BSD 3-clause "New" or "Revised" License	<p>Copyright (c) [YEAR], [OWNER]</p> <p>All rights reserved.</p> <p>Redistribution and use in source and binary forms, with or without modification, are permitted provided that the following conditions are met: Redistributions of source code must retain the above copyright notice, this list of conditions and the following disclaimer. Redistributions in binary form must reproduce the above copyright notice, this list of conditions and the following disclaimer in the documentation and/or other materials provided with the distribution. Neither the name of the [ORGANIZATION] nor the names of its contributors may be used to endorse or promote products derived from this software without specific prior written permission.</p> <p>THIS SOFTWARE IS PROVIDED BY THE COPYRIGHT HOLDERS AND CONTRIBUTORS "AS IS" AND ANY EXPRESS OR IMPLIED WARRANTIES, INCLUDING, BUT NOT LIMITED TO, THE IMPLIED WARRANTIES OF MERCHANTABILITY AND FITNESS FOR A PARTICULAR PURPOSE ARE DISCLAIMED. IN NO EVENT SHALL THE COPYRIGHT OWNER OR CONTRIBUTORS BE LIABLE FOR ANY DIRECT, INDIRECT, INCIDENTAL, SPECIAL, EXEMPLARY, OR CONSEQUENTIAL DAMAGES (INCLUDING, BUT NOT LIMITED TO, PROCUREMENT OF SUBSTITUTE GOODS OR SERVICES; LOSS OF USE, DATA, OR PROFITS; OR BUSINESS INTERRUPTION) HOWEVER CAUSED AND ON ANY THEORY OF LIABILITY, WHETHER IN CONTRACT, STRICT LIABILITY, OR TORT (INCLUDING NEGLIGENCE OR OTHERWISE) ARISING IN ANY WAY OUT OF THE USE OF THIS SOFTWARE, EVEN IF ADVISED OF THE POSSIBILITY OF SUCH DAMAGE.</p>
BSD 4-clause "Original" or "Old" License	<p>Copyright (c) [year], [copyright holder]</p> <p>All rights reserved.</p> <p>Redistribution and use in source and binary forms, with or without modification, are permitted provided that the following conditions are met:</p> <ol style="list-style-type: none"> 1. Redistributions of source code must retain the above copyright notice, this list of conditions and the following disclaimer. 2. Redistributions in binary form must reproduce the above copyright notice, this list of conditions and the following disclaimer in the documentation and/or other materials provided with the distribution. 3. All advertising materials mentioning features or use of this software must display the following acknowledgement: This product includes software developed by the organization. 4. Neither the name of the organization nor the names of its contributors may be used to endorse or promote products derived from this software without specific prior written permission. <p>THIS SOFTWARE IS PROVIDED BY COPYRIGHT HOLDER "AS IS" AND ANY EXPRESS OR IMPLIED WARRANTIES, INCLUDING, BUT NOT LIMITED TO, THE IMPLIED WARRANTIES OF MERCHANTABILITY AND FITNESS FOR A PARTICULAR PURPOSE ARE DISCLAIMED. IN NO EVENT SHALL {{COPYRIGHT HOLDER}} BE LIABLE FOR ANY DIRECT, INDIRECT, INCIDENTAL, SPECIAL, EXEMPLARY, OR CONSEQUENTIAL DAMAGES (INCLUDING, BUT NOT LIMITED TO, PROCUREMENT OF SUBSTITUTE GOODS OR SERVICES; LOSS OF USE, DATA, OR PROFITS; OR BUSINESS INTERRUPTION) HOWEVER CAUSED AND ON ANY THEORY OF LIABILITY, WHETHER IN CONTRACT, STRICT LIABILITY, OR TORT (INCLUDING NEGLIGENCE OR OTHERWISE) ARISING IN ANY WAY OUT OF THE USE OF THIS SOFTWARE, EVEN IF ADVISED OF THE POSSIBILITY OF SUCH DAMAGE.</p>

License name	License text
BSD-4-Clause (University of California-Specific)	<p>BSD-4-Clause (University of California-Specific)</p> <p>Copyright [various years] The Regents of the University of California. All rights reserved.</p> <p>Redistribution and use in source and binary forms, with or without modification, are permitted provided that the following conditions are met:</p> <ol style="list-style-type: none"> 1. Redistributions of source code must retain the above copyright notice, this list of conditions and the following disclaimer. 2. Redistributions in binary form must reproduce the above copyright notice, this list of conditions and the following disclaimer in the documentation and/or other materials provided with the distribution. 3. All advertising materials mentioning features or use of this software must display the following acknowledgement: This product includes software developed by the University of California, Berkeley and its contributors. 4. Neither the name of the University nor the names of its contributors may be used to endorse or promote products derived from this software without specific prior written permission. <p>THIS SOFTWARE IS PROVIDED BY THE REGENTS AND CONTRIBUTORS "AS IS" AND ANY EXPRESS OR IMPLIED WARRANTIES, INCLUDING, BUT NOT LIMITED TO, THE IMPLIED WARRANTIES OF MERCHANTABILITY AND FITNESS FOR A PARTICULAR PURPOSE ARE DISCLAIMED. IN NO EVENT SHALL THE REGENTS OR CONTRIBUTORS BE LIABLE FOR ANY DIRECT, INDIRECT, INCIDENTAL, SPECIAL, EXEMPLARY, OR CONSEQUENTIAL DAMAGES (INCLUDING, BUT NOT LIMITED TO, PROCUREMENT OF SUBSTITUTE GOODS OR SERVICES; LOSS OF USE, DATA, OR PROFITS; OR BUSINESS INTERRUPTION) HOWEVER CAUSED AND ON ANY THEORY OF LIABILITY, WHETHER IN CONTRACT, STRICT LIABILITY, OR TORT (INCLUDING NEGLIGENCE OR OTHERWISE) ARISING IN ANY WAY OUT OF THE USE OF THIS SOFTWARE, EVEN IF ADVISED OF THE POSSIBILITY OF SUCH DAMAGE.</p>

License name	License text
Freetype Project License	<p>The FreeType Project LICENSE 2006-Jan-27 Copyright 1996-2002, 2006 by David Turner, Robert Wilhelm, and Werner Lemberg</p> <p>Introduction</p> <p>The FreeType Project is distributed in several archive packages; some of them may contain, in addition to the FreeType font engine, various tools and contributions which rely on, or relate to, the FreeType Project. This license applies to all files found in such packages, and which do not fall under their own explicit license. The license affects thus the FreeType font engine, the test programs, documentation and makefiles, at the very least. This license was inspired by the BSD, Artistic, and IJG (Independent JPEG Group) licenses, which all encourage inclusion and use of free software in commercial and freeware products alike. As a consequence, its main points are that:</p> <p>We don't promise that this software works. However, we will be interested in any kind of bug reports. ('as is' distribution)</p> <p>You can use this software for whatever you want, in parts or full form, without having to pay us. ('royalty-free' usage)</p> <p>You may not pretend that you wrote this software. If you use it, or only parts of it, in a program, you must acknowledge somewhere in your documentation that you have used the FreeType code. ('credits')</p> <p>We specifically permit and encourage the inclusion of this software, with or without modifications, in commercial products. We disclaim all warranties covering The FreeType Project and assume no liability related to The FreeType Project. Finally, many people asked us for a preferred form for a credit/disclaimer to use in compliance with this license. We thus encourage you to use the following text:</p> <p>"Portions of this software are copyright © 1996-2002, 2006 The FreeType Project (www.freetype.org). All rights reserved."</p> <p>Legal Terms</p> <p>Definitions</p> <p>Throughout this license, the terms 'package', 'FreeType Project', and 'FreeType archive' refer to the set of files originally distributed by the authors (David Turner, Robert Wilhelm, and Werner Lemberg) as the 'FreeType Project', be they named as alpha, beta or final release. 'You' refers to the licensee, or person using the project, where 'using' is a generic term including compiling the project's source code as well as linking it to form a 'program' or 'executable'. This program is referred to as 'a program using the FreeType engine'. This license applies to all files distributed in the original FreeType Project, including all source code, binaries and documentation, unless otherwise stated in the file in its original, unmodified form as distributed in the original archive. If you are unsure whether or not a particular file is covered by this license, you must contact us to verify this.</p> <p>The FreeType Project is copyright (C) 1996-2000, 2006 by David Turner, Robert Wilhelm, and Werner Lemberg. All rights reserved except as specified below.</p> <p>No Warranty</p> <p>THE FREETYPE PROJECT IS PROVIDED 'AS IS' WITHOUT WARRANTY OF ANY KIND, EITHER EXPRESS OR IMPLIED, INCLUDING, BUT NOT LIMITED TO, WARRANTIES OF MERCHANTABILITY AND FITNESS FOR A PARTICULAR PURPOSE. IN NO EVENT WILL ANY OF THE AUTHORS OR COPYRIGHT HOLDERS BE LIABLE FOR ANY DAMAGES CAUSED BY THE USE OR THE INABILITY TO USE, OF THE FREETYPE PROJECT.</p> <p>Redistribution</p> <p>This license grants a worldwide, royalty-free, perpetual and irrevocable right and license to use, execute, perform, compile, display, copy, create derivative works of, distribute and sublicense the FreeType Project (in both source and object code forms) and derivative works thereof for any purpose; and to authorize others to exercise some or all of the rights granted herein, subject to the following conditions:</p> <p>Redistribution of source code must retain this license file ('FTL.TXT') unaltered; any additions, deletions or changes to the original files must be clearly indicated in accompanying documentation. The copyright notices of the unaltered, original files must be preserved in all copies of source files.</p> <p>Redistribution in binary form must provide a disclaimer that states that the software is based in part of the work of the FreeType Team, in the distribution documentation. We also encourage you to put an URL to the FreeType web page in your documentation, though this isn't mandatory. These conditions apply to any software derived from or based on the FreeType Project, not just the unmodified files. If you use our work, you must acknowledge us. However, no fee need be paid to us.</p> <p>Advertising</p> <p>Neither the FreeType authors and contributors nor you shall use the name of the other for commercial, advertising, or promotional purposes without specific prior written permission. We suggest, but do not require, that you use one or more of the following phrases to refer to this software in your documentation or advertising materials: 'FreeType Project', 'FreeType Engine', 'FreeType library', or 'FreeType Distribution'. As you have not signed this license, you are not required to accept it. However, as the FreeType Project is copyrighted material, only this license, or another one contracted with the authors, grants you the right to use, distribute, and modify it. Therefore, by using, distributing, or modifying the FreeType Project, you indicate that you understand and accept all the terms of this license.</p> <p>Contacts</p> <p>There are two mailing lists related to FreeType:</p> <p>freetype@nongnu.org Discusses general use and applications of FreeType, as well as future and wanted additions to the library and distribution. If you are looking for support, start in this list if you haven't found anything to help you in the documentation.</p> <p>devel@nongnu.org Discusses bugs, as well as engine internals, design issues, specific licenses, porting, etc.</p> <p>Our home page can be found at: http://www.freetype.org</p>

License name	License text
<p>Independent JPEG Group License</p>	<p>The Independent JPEG Group's JPEG software README for release 6b of 27-Mar-1998</p> <p>This distribution contains the sixth public release of the Independent JPEG Group's free JPEG software. You are welcome to redistribute this software and to use it for any purpose, subject to the conditions under LEGAL ISSUES, below. Serious users of this software (particularly those incorporating it into larger programs) should contact IJG at jpeg-info@uunet.uu.net to be added to our electronic mailing list. Mailing list members are notified of updates and have a chance to participate in technical discussions, etc. This software is the work of Tom Lane, Philip Gladstone, Jim Boucher, Lee Crocker, Julian Minguillon, Luis Ortiz, George Phillips, Davide Rossi, Guido Vollbeding, Ge' Weijers, and other members of the Independent JPEG Group. IJG is not affiliated with the official ISO JPEG standards committee.</p> <p>LEGAL ISSUES</p> <p>In plain English:</p> <p>We don't promise that this software works. (But if you find any bugs, please let us know!) You can use this software for whatever you want. You don't have to pay us. You may not pretend that you wrote this software. If you use it in a program, you must acknowledge somewhere in your documentation that you've used the IJG code.</p> <p>In legalese:</p> <p>The authors make NO WARRANTY or representation, either express or implied, with respect to this software, its quality, accuracy, merchantability, or fitness for a particular purpose. This software is provided "AS IS", and you, its user, assume the entire risk as to its quality and accuracy. This software is copyright (C) 1991-1998, Thomas G. Lane. All Rights Reserved except as specified below.</p> <p>Permission is hereby granted to use, copy, modify, and distribute this software (or portions thereof) for any purpose, without fee, subject to these conditions:</p> <ol style="list-style-type: none"> 1. If any part of the source code for this software is distributed, then this README file must be included, with this copyright and no-warranty notice unaltered; and any additions, deletions, or changes to the original files must be clearly indicated in accompanying documentation. 2. If only executable code is distributed, then the accompanying documentation must state that "this software is based in part on the work of the Independent JPEG Group". 3. Permission for use of this software is granted only if the user accepts full responsibility for any undesirable consequences; the authors accept NO LIABILITY for damages of any kind. <p>These conditions apply to any software derived from or based on the IJG code, not just to the unmodified library. If you use our work, you ought to acknowledge us.</p> <p>Permission is NOT granted for the use of any IJG author's name or company name in advertising or publicity relating to this software or products derived from it. This software may be referred to only as "the Independent JPEG Group's software".</p> <p>We specifically permit and encourage the use of this software as the basis of commercial products, provided that all warranty or liability claims are assumed by the product vendor. ansi2knrc is included in this distribution by permission of L. Peter Deutsch, sole proprietor of its copyright holder, Aladdin Enterprises of Menlo Park, CA. ansi2knrc is NOT covered by the above copyright and conditions, but instead by the usual distribution terms of the Free Software Foundation; principally, that you must include source code if you redistribute it. (See the file ansi2knrc for full details.)</p> <p>However, since ansi2knrc is not needed as part of any program generated from the IJG code, this does not limit you more than the foregoing paragraphs do. The Unix configuration script "configure" was produced with GNU Autoconf. It is copyright by the Free Software Foundation but is freely distributable. The same holds for its supporting scripts (config.guess, config.sub, ltconfig, ltmain.sh). Another support script, install-sh, is copyright by M.I.T. but is also freely distributable.</p> <p>It appears that the arithmetic coding option of the JPEG spec is covered by patents owned by IBM, AT & T, and Mitsubishi. Hence arithmetic coding cannot legally be used without obtaining one or more licenses. For this reason, support for arithmetic coding has been removed from the free JPEG software. (Since arithmetic coding provides only a marginal gain over the unpatented Huffman mode, it is unlikely that very many implementations will support it.) So far as we are aware, there are no patent restrictions on the remaining code.</p> <p>The IJG distribution formerly included code to read and write GIF files. To avoid entanglement with the Unisys LZW patent, GIF reading support has been removed altogether, and the GIF writer has been simplified to produce "uncompressed GIFs". This technique does not use the LZW algorithm; the resulting GIF files are larger than usual, but are readable by all standard GIF decoders. We are required to state that</p> <p>"The Graphics Interchange Format(c) is the Copyright property of CompuServe Incorporated. GIF(sm) is a Service Mark property of CompuServe Incorporated."</p>
<p>Internet Software Consortium-IBM License</p>	<p>Copyright (c) 1996 by Internet Software Consortium.</p> <p>Permission to use, copy, modify, and distribute this software for any purpose with or without fee is hereby granted, provided that the above copyright notice and this permission notice appear in all copies.</p> <p>THE SOFTWARE IS PROVIDED "AS IS" AND INTERNET SOFTWARE CONSORTIUM DISCLAIMS ALL WARRANTIES WITH REGARD TO THIS SOFTWARE INCLUDING ALL IMPLIED WARRANTIES OF MERCHANTABILITY AND FITNESS. IN NO EVENT SHALL INTERNET SOFTWARE CONSORTIUM BE LIABLE FOR ANY SPECIAL, DIRECT, INDIRECT, OR CONSEQUENTIAL DAMAGES OR ANY DAMAGES WHATSOEVER RESULTING FROM LOSS OF USE, DATA OR PROFITS, WHETHER IN AN ACTION OF CONTRACT, NEGLIGENCE OR OTHER TORTIOUS ACTION, ARISING OUT OF OR IN CONNECTION WITH THE USE OR PERFORMANCE OF THIS SOFTWARE.</p> <p>Portions Copyright (c) 1995 by International Business Machines, Inc.</p> <p>International Business Machines, Inc. (hereinafter called IBM) grants permission under its copyrights to use, copy, modify, and distribute this Software with or without fee, provided that the above copyright notice and all paragraphs of this notice appear in all copies, and that the name of IBM not be used in connection with the marketing of any product incorporating the Software or modifications thereof, without specific, written prior permission.</p> <p>To the extent it has a right to do so, IBM grants an immunity from suit under its patents, if any, for the use, sale or manufacture of products to the extent that such products are used for performing Domain Name System dynamic updates in TCP/IP networks by means of the Software. No immunity is granted for any product per se or for any other function of any product.</p> <p>THE SOFTWARE IS PROVIDED "AS IS", AND IBM DISCLAIMS ALL WARRANTIES, INCLUDING ALL IMPLIED WARRANTIES OF MERCHANTABILITY AND FITNESS FOR A PARTICULAR PURPOSE. IN NO EVENT SHALL IBM BE LIABLE FOR ANY SPECIAL, DIRECT, INDIRECT, OR CONSEQUENTIAL DAMAGES OR ANY DAMAGES WHATSOEVER ARISING OUT OF OR IN CONNECTION WITH THE USE OR PERFORMANCE OF THIS SOFTWARE, EVEN IF IBM IS APPRISED OF THE POSSIBILITY OF SUCH DAMAGES.</p>

License name	License text
Khronos License	<p>Copyright (c) 2013 The Khronos Group Inc.</p> <p>** ** Permission is hereby granted, free of charge, to any person obtaining a ** copy of this software and/or associated documentation files (the ** "Materials"), to deal in the Materials without restriction, including ** without limitation the rights to use, copy, modify, merge, publish, ** distribute, sublicense, and/or sell copies of the Materials, and to ** permit persons to whom the Materials are furnished to do so, subject to ** the following conditions: ** ** The above copyright notice and this permission notice shall be included ** in all copies or substantial portions of the Materials. ** ** THE MATERIALS ARE PROVIDED "AS IS", WITHOUT WARRANTY OF ANY KIND, ** EXPRESS OR IMPLIED, INCLUDING BUT NOT LIMITED TO THE WARRANTIES OF ** MERCHANTABILITY, FITNESS FOR A PARTICULAR PURPOSE AND NONINFRINGEMENT. ** IN NO EVENT SHALL THE AUTHORS OR COPYRIGHT HOLDERS BE LIABLE FOR ANY ** CLAIM, DAMAGES OR OTHER LIABILITY, WHETHER IN AN ACTION OF CONTRACT, ** TORT OR OTHERWISE, ARISING FROM, OUT OF OR IN CONNECTION WITH THE ** MATERIALS OR THE USE OR OTHER DEALINGS IN THE MATERIALS.</p>
License of Stephan Brumme/ Zlib style License	<p>This software is provided 'as-is', without any express or implied warranty. In no event will the author be held liable for any damages arising from the use of this software. Permission is granted to anyone to use this software for any purpose, including commercial applications, and to alter it and redistribute it freely, subject to the following restrictions: The origin of this software must not be misrepresented; you must not claim that you wrote the original software. If you use this software in a product, an acknowledgment in the product documentation would be appreciated but is not required. Altered source versions must be plainly marked as such, and must not be misrepresented as being the original software.</p>
MIT License	<p>The MIT License</p> <p>Copyright (c) [year] [copyright holders]</p> <p>Permission is hereby granted, free of charge, to any person obtaining a copy of this software and associated documentation files (the "Software"), to deal in the Software without restriction, including without limitation the rights to use, copy, modify, merge, publish, distribute, sublicense, and/or sell copies of the Software, and to permit persons to whom the Software is furnished to do so, subject to the following conditions:</p> <p>The above copyright notice and this permission notice shall be included in all copies or substantial portions of the Software.</p> <p>THE SOFTWARE IS PROVIDED "AS IS", WITHOUT WARRANTY OF ANY KIND, EXPRESS OR IMPLIED, INCLUDING BUT NOT LIMITED TO THE WARRANTIES OF MERCHANTABILITY, FITNESS FOR A PARTICULAR PURPOSE AND NONINFRINGEMENT. IN NO EVENT SHALL THE AUTHORS OR COPYRIGHT HOLDERS BE LIABLE FOR ANY CLAIM, DAMAGES OR OTHER LIABILITY, WHETHER IN AN ACTION OF CONTRACT, TORT OR OTHERWISE, ARISING FROM, OUT OF OR IN CONNECTION WITH THE SOFTWARE OR THE USE OR OTHER DEALINGS IN THE SOFTWARE.</p>
Open Group License	<p>Open Group License</p> <p>Copyright 1996, 1998 The Open Group</p> <p>Permission to use, copy, modify, distribute, and sell this software and its documentation for any purpose is hereby granted without fee, provided that the above copyright notice appear in all copies and that both that copyright notice and this permission notice appear in supporting documentation. The above copyright notice and this permission notice shall be included in all copies or substantial portions of the Software.</p> <p>THE SOFTWARE IS PROVIDED "AS IS", WITHOUT WARRANTY OF ANY KIND, EXPRESS OR IMPLIED, INCLUDING BUT NOT LIMITED TO THE WARRANTIES OF MERCHANTABILITY, FITNESS FOR A PARTICULAR PURPOSE AND NONINFRINGEMENT. IN NO EVENT SHALL THE OPEN GROUP BE LIABLE FOR ANY CLAIM, DAMAGES OR OTHER LIABILITY, WHETHER IN AN ACTION OF CONTRACT, TORT OR OTHERWISE, ARISING FROM, OUT OF OR IN CONNECTION WITH THE SOFTWARE OR THE USE OR OTHER DEALINGS IN THE SOFTWARE.</p> <p>Except as contained in this notice, the name of The Open Group shall not be used in advertising or otherwise to promote the sale, use or other dealings in this Software without prior written authorization from The Open Group.</p>
Public Domain	<p>Public domain code is not subject to any license.</p>
BSD One Clause License	<p>BSD One Clause License</p> <p>Copyright (c) [YEAR], [OWNER]</p> <p>All rights reserved.</p> <p>Redistribution and use in source and binary forms, with or without modification, are permitted provided that the following conditions are met:</p> <p>* Redistributions of source code must retain the above copyright notice, this list of conditions and the following disclaimer.</p> <p>THIS SOFTWARE IS PROVIDED BY THE COPYRIGHT HOLDERS AND CONTRIBUTORS "AS IS" AND ANY EXPRESS OR IMPLIED WARRANTIES, INCLUDING, BUT NOT LIMITED TO, THE IMPLIED WARRANTIES OF MERCHANTABILITY AND FITNESS FOR A PARTICULAR PURPOSE ARE DISCLAIMED. IN NO EVENT SHALL THE COPYRIGHT OWNER OR CONTRIBUTORS BE LIABLE FOR ANY DIRECT, INDIRECT, INCIDENTAL, SPECIAL, EXEMPLARY, OR CONSEQUENTIAL DAMAGES (INCLUDING, BUT NOT LIMITED TO, PROCUREMENT OF SUBSTITUTE GOODS OR SERVICES; LOSS OF USE, DATA, OR PROFITS; OR BUSINESS INTERRUPTION) HOWEVER CAUSED AND ON ANY THEORY OF LIABILITY, WHETHER IN CONTRACT, STRICT LIABILITY, OR TORT (INCLUDING NEGLIGENCE OR OTHERWISE) ARISING IN ANY WAY OUT OF THE USE OF THIS SOFTWARE, EVEN IF ADVISED OF THE POSSIBILITY OF SUCH DAMAGE.</p>
ISC License	<p>ISC License (ISCL)</p> <p>Copyright (c) 4-digit year, Company or Person's Name</p> <p>Permission to use, copy, modify, and/or distribute this software for any purpose with or without fee is hereby granted, provided that the above copyright notice and this permission notice appear in all copies.</p> <p>THE SOFTWARE IS PROVIDED "AS IS" AND THE AUTHOR DISCLAIMS ALL WARRANTIES WITH REGARD TO THIS SOFTWARE INCLUDING ALL IMPLIED WARRANTIES OF MERCHANTABILITY AND FITNESS. IN NO EVENT SHALL THE AUTHOR BE LIABLE FOR ANY SPECIAL, DIRECT, INDIRECT, OR CONSEQUENTIAL DAMAGES OR ANY DAMAGES WHATSOEVER RESULTING FROM LOSS OF USE, DATA OR PROFITS, WHETHER IN AN ACTION OF CONTRACT, NEGLIGENCE OR OTHER TORTIOUS ACTION, ARISING OUT OF OR IN CONNECTION WITH THE USE OR PERFORMANCE OF THIS SOFTWARE.</p>

License name	License text
SGI Free Software License B v2.0	<p>SGI FREE SOFTWARE LICENSE B (Version 2.0, Sept. 18, 2008) Copyright (C) [dates of first publication] Silicon Graphics, Inc. All Rights Reserved.</p> <p>Permission is hereby granted, free of charge, to any person obtaining a copy of this software and associated documentation files (the "Software"), to deal in the Software without restriction, including without limitation the rights to use, copy, modify, merge, publish, distribute, sublicense, and/or sell copies of the Software, and to permit persons to whom the Software is furnished to do so, subject to the following conditions:</p> <p>The above copyright notice including the dates of first publication and either this permission notice or a reference to http://oss.sgi.com/projects/FreeB/ shall be included in all copies or substantial portions of the Software.</p> <p>THE SOFTWARE IS PROVIDED "AS IS", WITHOUT WARRANTY OF ANY KIND, EXPRESS OR IMPLIED, INCLUDING BUT NOT LIMITED TO THE WARRANTIES OF MERCHANTABILITY, FITNESS FOR A PARTICULAR PURPOSE AND NONINFRINGEMENT. IN NO EVENT SHALL SILICON GRAPHICS, INC. BE LIABLE FOR ANY CLAIM, DAMAGES OR OTHER LIABILITY, WHETHER IN AN ACTION OF CONTRACT, TORT OR OTHERWISE, ARISING FROM, OUT OF OR IN CONNECTION WITH THE SOFTWARE OR THE USE OR OTHER DEALINGS IN THE SOFTWARE.</p> <p>Except as contained in this notice, the name of Silicon Graphics, Inc. shall not be used in advertising or otherwise to promote the sale, use or other dealings in this Software without prior written authorization from Silicon Graphics, Inc.</p>

License name	License text
Unicode Terms of Use	<p data-bbox="284 174 459 197">Unicode Terms of Use</p> <p data-bbox="284 203 1417 255">For the general privacy policy governing access to this site, see the Unicode Privacy Policy. For trademark usage, see the Unicode® Consortium Name and Trademark Usage Policy.</p> <p data-bbox="284 262 459 284">A. Unicode Copyright.</p> <ol data-bbox="292 297 1461 719" style="list-style-type: none"> <li data-bbox="292 297 770 320">1. Copyright © 1991-2014 Unicode, Inc. All rights reserved. <li data-bbox="292 338 1461 416">2. Certain documents and files on this website contain a legend indicating that "Modification is permitted." Any person is hereby authorized, without fee, to modify such documents and files to create derivative works conforming to the Unicode® Standard, subject to Terms and Conditions herein. <li data-bbox="292 434 1442 486">3. Any person is hereby authorized, without fee, to view, use, reproduce, and distribute all documents and files solely for informational purposes in the creation of products supporting the Unicode Standard, subject to the Terms and Conditions herein. <li data-bbox="292 504 1385 555">4. Further specifications of rights and restrictions pertaining to the use of the particular set of data files known as the "Unicode Character Database" can be found in Exhibit 1. <li data-bbox="292 573 1461 647">5. Each version of the Unicode Standard has further specifications of rights and restrictions of use. For the book editions (Unicode 5.0 and earlier), these are found on the back of the title page. The online code charts carry specific restrictions. All other files, including online documentation of the core specification for Unicode 6.0 and later, are covered under these general Terms of Use. <li data-bbox="292 665 1169 687">6. No license is granted to "mirror" the Unicode website where a fee is charged for access to the "mirror" site. <li data-bbox="292 705 1161 728">7. Modification is not permitted with respect to this document. All copies of this document must be verbatim. <p data-bbox="284 739 512 761">B. Restricted Rights Legend.</p> <p data-bbox="284 768 1461 902">Any technical data or software which is licensed to the United States of America, its agencies and/or instrumentalities under this Agreement is commercial technical data or commercial computer software developed exclusively at private expense as defined in FAR 2.101, or DFARS 252.227-7014 (June 1995), as applicable. For technical data, use, duplication, or disclosure by the Government is subject to restrictions as set forth in DFARS 202.227-7015 Technical Data, Commercial and Items (Nov 1995) and this Agreement. For Software, in accordance with FAR 12-212 or DFARS 227-7202, as applicable, use, duplication or disclosure by the Government is subject to the restrictions set forth in this Agreement.</p> <p data-bbox="284 909 531 931">C. Warranties and Disclaimers.</p> <ol data-bbox="292 945 1461 1240" style="list-style-type: none"> <li data-bbox="292 945 1461 1023">1. This publication and/or website may include technical or typographical errors or other inaccuracies . Changes are periodically added to the information herein; these changes will be incorporated in new editions of the publication and/or website. Unicode may make improvements and/or changes in the product(s) and/or program(s) described in this publication and/or website at any time. <li data-bbox="292 1041 1461 1093">2. If this file has been purchased on magnetic or optical media from Unicode, Inc. the sole and exclusive remedy for any claim will be exchange of the defective media within ninety (90) days of original purchase. <li data-bbox="292 1111 1461 1240">3. EXCEPT AS PROVIDED IN SECTION C.2, THIS PUBLICATION AND/OR SOFTWARE IS PROVIDED "AS IS" WITHOUT WARRANTY OF ANY KIND EITHER EXPRESS, IMPLIED, OR STATUTORY, INCLUDING, BUT NOT LIMITED TO, ANY WARRANTIES OF MERCHANTABILITY, FITNESS FOR A PARTICULAR PURPOSE, OR NON-INFRINGEMENT. UNICODE AND ITS LICENSORS ASSUME NO RESPONSIBILITY FOR ERRORS OR OMISSIONS IN THIS PUBLICATION AND/OR SOFTWARE OR OTHER DOCUMENTS WHICH ARE REFERENCED BY OR LINKED TO THIS PUBLICATION OR THE UNICODE WEBSITE. <p data-bbox="284 1258 469 1281">D. Waiver of Damages.</p> <p data-bbox="284 1288 1461 1361">In no event shall Unicode or its licensors be liable for any special, incidental, indirect or consequential damages of any kind, or any damages whatsoever, whether or not Unicode was advised of the possibility of the damage, including, without limitation, those resulting from the following: loss of use, data or profits, in connection with the use, modification or distribution of this information or its derivatives.</p> <p data-bbox="284 1368 474 1391">E. Trademarks & Logos.</p> <ol data-bbox="292 1404 1461 1592" style="list-style-type: none"> <li data-bbox="292 1404 1461 1482">1. The Unicode Word Mark and the Unicode Logo are trademarks of Unicode, Inc. "The Unicode Consortium" and "Unicode, Inc." are trade names of Unicode, Inc. Use of the information and materials found on this website indicates your acknowledgement of Unicode, Inc.'s exclusive worldwide rights in the Unicode Word Mark, the Unicode Logo, and the Unicode trade names. <li data-bbox="292 1500 1461 1552">2. The Unicode Consortium Name and Trademark Usage Policy ("Trademark Policy") are incorporated herein by reference and you agree to abide by the provisions of the Trademark Policy, which may be changed from time to time in the sole discretion of Unicode, Inc. <li data-bbox="292 1570 1011 1592">3. All third party trademarks referenced herein are the property of their respective owners. <p data-bbox="284 1608 419 1630">F. Miscellaneous.</p> <ol data-bbox="292 1644 1461 2042" style="list-style-type: none"> <li data-bbox="292 1644 1461 1809">1. Jurisdiction and Venue. This server is operated from a location in the State of California, United States of America. Unicode makes no representation that the materials are appropriate for use in other locations. If you access this server from other locations, you are responsible for compliance with local laws. This Agreement, all use of this site and any claims and damages resulting from use of this site are governed solely by the laws of the State of California without regard to any principles which would apply the laws of a different jurisdiction. The user agrees that any disputes regarding this site shall be resolved solely in the courts located in Santa Clara County, California. The user agrees said courts have personal jurisdiction and agree to waive any right to transfer the dispute to any other forum. <li data-bbox="292 1827 1461 1879">2. Modification by Unicode. Unicode shall have the right to modify this Agreement at any time by posting it to this site. The user may not assign any part of this Agreement without Unicode's prior written consent. <li data-bbox="292 1897 1461 1948">3. Taxes. The user agrees to pay any taxes arising from access to this website or use of the information herein, except for those based on Unicode's net income. <li data-bbox="292 1966 1461 2018">4. Severability. If any provision of this Agreement is declared invalid or unenforceable, the remaining provisions of this Agreement shall remain in effect. <li data-bbox="292 2036 1031 2058">5. Entire Agreement. This Agreement constitutes the entire agreement between the parties.

License name	License text
libpng License	<p>Libpng License</p> <p>This copy of the libpng notices is provided for your convenience. In case of any discrepancy between this copy and the notices in the file png.h that is included in the libpng distribution, the latter shall prevail.</p> <p>COPYRIGHT NOTICE, DISCLAIMER, and LICENSE:</p> <p>If you modify libpng you may insert additional notices immediately following this sentence. libpng versions 1.0.7, July 1, 2000, through 1.0.13, April 15, 2002, are Copyright (c) 2000-2002 Glenn Randers-Pehrson and are distributed according to the same disclaimer and license as libpng-1.0.6 with the following individuals added to the list of Contributing Authors:</p> <p>Simon-Pierre Cadieux, Eric S. Raymond, Gilles Vollant</p> <p>and with the following additions to the disclaimer:</p> <p>There is no warranty against interference with your enjoyment of the library or against infringement. There is no warranty that our efforts or the library will fulfill any of your particular purposes or needs. This library is provided with all faults, and the entire risk of satisfactory quality, performance, accuracy, and effort is with the user.</p> <p>libpng versions 0.97, January 1998, through 1.0.6, March 20, 2000, are Copyright (c) 1998, 1999 Glenn Randers-Pehrson, and are distributed according to the same disclaimer and license as libpng-0.96, with the following individuals added to the list of Contributing Authors:</p> <p>Tom Lane, Glenn Randers-Pehrson, Willem van Schaik.</p> <p>libpng versions 0.89, June 1996, through 0.96, May 1997, are Copyright (c) 1996, 1997 Andreas Dilger Distributed according to the same disclaimer and license as libpng-0.88, with the following individuals added to the list of Contributing Authors:</p> <p>John Bowler, Kevin Bracey, Sam Bushell, Magnus Holmgren, Greg Roelofs, Tom Tanner.</p> <p>libpng versions 0.5, May 1995, through 0.88, January 1996, are Copyright (c) 1995, 1996 Guy Eric Schalnat, Group 42, Inc. For the purposes of this copyright and license, "Contributing Authors" is defined as the following set of individuals:</p> <p>Andreas Dilger, Dave Martindale, Guy Eric Schalnat, Paul Schmidt, Tim Wegner.</p> <p>The PNG Reference Library is supplied "AS IS". The Contributing Authors and Group 42, Inc. disclaim all warranties, expressed or implied, including, without limitation, the warranties of merchantability and of fitness for any purpose. The Contributing Authors and Group 42, Inc. assume no liability for direct, indirect, incidental, special, exemplary, or consequential damages, which may result from the use of the PNG Reference Library, even if advised of the possibility of such damage. Permission is hereby granted to use, copy, modify, and distribute this source code, or portions hereof, for any purpose, without fee, subject to the following restrictions:</p> <ol style="list-style-type: none"> 1. The origin of this source code must not be misrepresented. 2. Altered versions must be plainly marked as such and must not be misrepresented as being the original source. 3. This Copyright notice may not be removed or altered from any source or altered source distribution. <p>The Contributing Authors and Group 42, Inc. specifically permit, without fee, and encourage the use of this source code as a component to supporting the PNG file format in commercial products. If you use this source code in a product, acknowledgment is not required but would be appreciated. A "png_get_copyright" function is available, for convenient use in "about" boxes and the like:</p> <pre>printf("%s",png_get_copyright(NULL));</pre> <p>Also, the PNG logo (in PNG format, of course) is supplied in the files "pngbar.png" and "pngbar.jpg (88x31) and "pngnow.png" (98x31).</p> <p>Libpng is OSI Certified Open Source Software. OSI Certified Open Source is a certification mark of the Open Source Initiative.</p> <p>Glenn Randers-Pehrson randeg@alum.rpi.edu April 15, 2002</p>
zlib License	<p>The zlib/libpng License</p> <p>Copyright (c) [year] [copyright holders]</p> <p>This software is provided 'as-is', without any express or implied warranty. In no event will the authors be held liable for any damages arising from the use of this software.</p> <p>Permission is granted to anyone to use this software for any purpose, including commercial applications, and to alter it and redistribute it freely, subject to the following restrictions:</p> <ol style="list-style-type: none"> 1. The origin of this software must not be misrepresented; you must not claim that you wrote the original software. If you use this software in a product, an acknowledgment in the product documentation would be appreciated but is not required. 2. Altered source versions must be plainly marked as such, and must not be misrepresented as being the original software. 3. This notice may not be removed or altered from any source distribution.

15.6. Labels

Your vehicle has a number of labels that provide information about the vehicle and its use, such as specifications and warnings.

Warning label

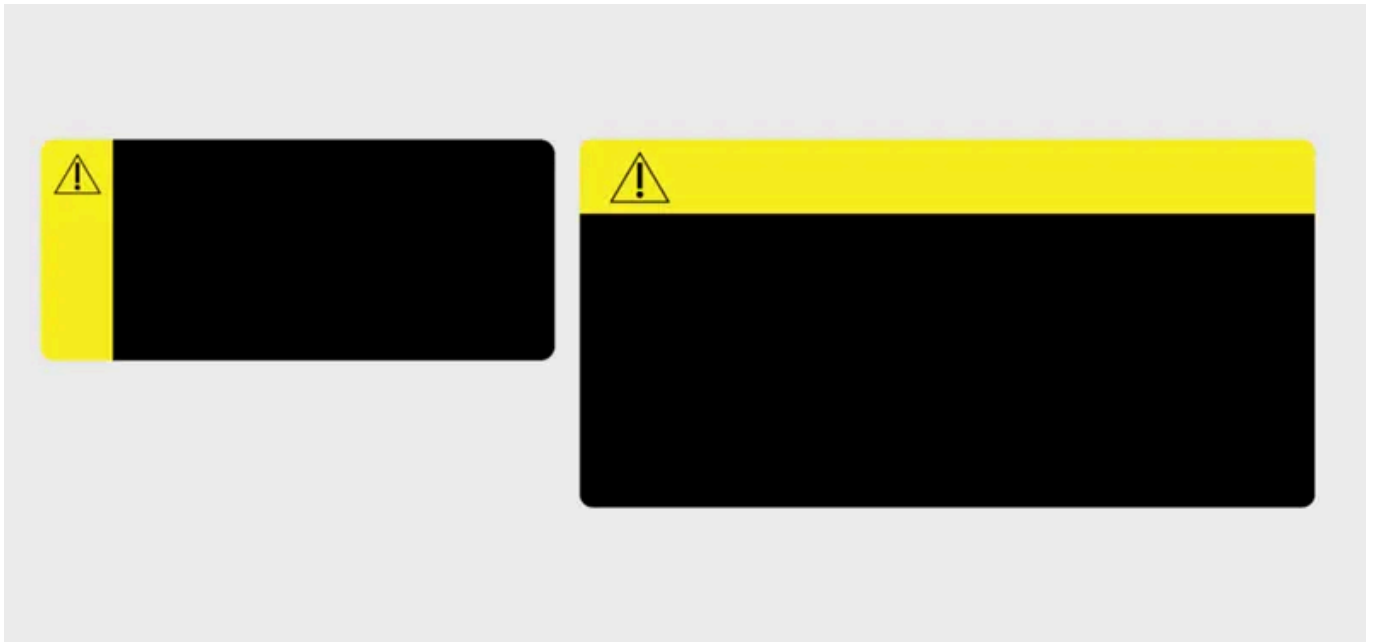

Yellow signal panel with warning symbol.

Indicates a potentially hazardous situation which, if not avoided, could result in death or serious injury.

Notice label



Notice symbol in signal panel.

Indicates a hazardous situation which, if not avoided, could result in minor or moderate damage to property.

Information label



Label with no signal panel.

Indicates important information but no risk for personal injury or damage to property.

Note

Depicted labels

Labels depicted in this manual are generic representations of those found around your vehicle. The manual only contains their location and what kind of information they contain. Find the actual label for specific information about your vehicle.