

# XC40 Mild Hybrid 2023 (22w22) User Manual

Version 2025-11-19

## Disclaimer

Due to the dynamic nature of our software-based product, the content of this PDF represents the most up-to-date version of the user manual as of the time of printing. As we continuously update and improve our product, certain content may not reflect the most up-to-date information in a future instance. Therefore, we strongly recommend utilizing the digital user manual app in your car's center display for the most accurate and up-to-date information. You can also access information in the Volvo Cars mobile app.

Please note that if you choose to print the manual, we cannot guarantee the validity of the information in future instances, as updates may have occurred since the time of printing. To ensure the highest level of safety and optimal product usage, we strongly advise relying on the digital user manual, which can be easily accessed through your car's center display.

This printable version is generic and does not correspond to your car. If there are discrepancies between this printable manual and the manual you see in your car's center display, the latter takes precedence.

## Contents

1. [Owner's information](#)
  - 1.1 [Owner's information](#)
  - 1.2 [Using the Owner's Manual](#)
  - 1.3 [Complete Owner's Manual in the center display](#)
  - 1.4 [Navigate in the Owner's Manual in the center display](#)
2. [Your Volvo](#)
  - 2.1 [Volvo's innovation areas](#)
    - 2.1.1 [Eco-efficiency](#)
    - 2.1.2 [Connection and entertainment](#)
  - 2.2 [Volvo ID](#)
    - 2.2.1 [Volvo ID](#)
    - 2.2.2 [Creating a Volvo ID](#)
    - 2.2.3 [Problems logging in with Volvo ID](#)
  - 2.3 [Type approval and licenses](#)
    - 2.3.1 [Antenna type approval](#)
    - 2.3.2 [License agreement for instrument panel](#)
    - 2.3.3 [Type approval for HomeLink®](#)
    - 2.3.4 [Type approval Radio Equipment Directive](#)
    - 2.3.5 [Certificate for wireless phone charger](#)
    - 2.3.6 [Start and lock system type designations](#)
    - 2.3.7 [Approval of terms and conditions and data collection](#)
  - 2.4 [Displays and controls by the driver in a left-hand drive vehicle](#)
  - 2.5 [Technician certification](#)
  - 2.6 [Connecting equipment to the vehicle's data link connector](#)
  - 2.7 [Driver distraction](#)
  - 2.8 [Getting started with Google services](#)
  - 2.9 [Change of market when importing or relocating](#)
  - 2.10 [Viewing the Vehicle Identification Number \(VIN\)](#)
  - 2.11 [Data recording](#)
  - 2.12 [Accessory installation](#)
  - 2.13 [Volvo Structural Parts Statement](#)

The content of this manual represents the status of the user manual at the time of printing and may not be completely valid in future instances. For more information refer to the first page for the complete disclaimer note.

- 2.14 Contacting Volvo
- 2.15 Important information on accessories and extra equipment
- 3. Safety
  - 3.1 Seat belts
    - 3.1.1 Seat belts
    - 3.1.2 Buckling and unbuckling seat belts
    - 3.1.3 Seat belt tensioners
    - 3.1.4 Resetting the electric seat belt tensioners
    - 3.1.5 Door and seat belt reminders
  - 3.2 Airbags
    - 3.2.1 Airbags
    - 3.2.2 Driver/passenger side front airbags
    - 3.2.3 Occupant Classification System
    - 3.2.4 Inflatable curtain
    - 3.2.5 Near-side airbags
  - 3.3 Child safety
    - 3.3.1 Attachment points for child seats
      - 3.3.1.1 Lower child seat attachment points
      - 3.3.1.2 ISOFIX/LATCH lower anchors
      - 3.3.1.3 Top tether anchors
    - 3.3.2 Activating and deactivating child locks
    - 3.3.3 Child safety
    - 3.3.4 Child restraints
    - 3.3.5 Infant seats
    - 3.3.6 Booster cushions
    - 3.3.7 Convertible seats
    - 3.3.8 Occupant Classification System
  - 3.4 Safety mode
    - 3.4.1 Safety mode
    - 3.4.2 Starting and moving the vehicle when it is in safety mode
  - 3.5 Safety
  - 3.6 Recall information
  - 3.7 Occupant safety
  - 3.8 Safety during pregnancy
  - 3.9 Reporting safety defects
  - 3.10 Whiplash Protection System
- 4. Displays and voice control
  - 4.1 Instrument panel
    - 4.1.1 Gauges and indicators in the instrument panel
      - 4.1.1.1 Fuel gauge
      - 4.1.1.2 Ambient temperature sensor
    - 4.1.2 Trip computer
      - 4.1.2.1 Trip computer
      - 4.1.2.2 Resetting the trip odometer
    - 4.1.3 Instrument panel
    - 4.1.4 Instrument panel settings
    - 4.1.5 License agreement for instrument panel
    - 4.1.6 Messages in the instrument panel
  - 4.2 Center display
    - 4.2.1 Settings
      - 4.2.1.1 Resetting user data
      - 4.2.1.2 Changing system units of measurement

- 4.2.1.3 Changing system language
- 4.2.1.4 Unlock settings
- 4.2.1.5 Setting speed limitation for Care Key
- 4.2.1.6 Lock confirmation settings
- 4.2.1.7 Keyless unlock settings
- 4.2.2 User profiles
  - 4.2.2.1 User profiles
  - 4.2.2.2 Connect key to user profile
  - 4.2.2.3 Managing user profiles
  - 4.2.2.4 Profile settings
  - 4.2.2.5 Connecting an account to a user profile
- 4.2.3 Center display overview
- 4.2.4 Handling the center display
- 4.2.5 Center display views
- 4.2.6 Handling tiles in the center display
- 4.2.7 Symbols in the center display status bar
- 4.2.8 Moving apps in the center display
- 4.2.9 Message in the center display
- 4.2.10 Keyboard in the center display
- 4.2.11 Entering characters, letters and words by hand in the center display
- 4.2.12 Changing keyboard language in the center display
- 4.2.13 Date and time
- 4.2.14 Navigate in the Owner's Manual in the center display
- 4.3 Symbols and messages
  - 4.3.1 BLIS messages
  - 4.3.2 Electronic Stability Control symbols and messages
  - 4.3.3 Pilot Assist symbols and messages
  - 4.3.4 Lane Keeping Aid symbols and messages
  - 4.3.5 Lane Keeping Aid display
  - 4.3.6 Park Assist and Park Assist Camera symbols and messages
  - 4.3.7 Symbols in the center display status bar
  - 4.3.8 Indicator and warning symbols
  - 4.3.9 Parking climate symbols and messages
  - 4.3.10 Overheating of engine and transmission
  - 4.3.11 Transmission symbols and messages
- 4.4 Voice control
  - 4.4.1 Voice control with the Google Assistant
  - 4.4.2 Using voice control
- 4.5 Displays and controls by the driver in a left-hand drive vehicle
- 5. Lighting
  - 5.1 Exterior lighting
    - 5.1.1 Active Bending Lights
    - 5.1.2 Active high beam
    - 5.1.3 Using turn signals
    - 5.1.4 Brake lights
    - 5.1.5 Rear fog light
    - 5.1.6 Front fog lights/corner illumination
    - 5.1.7 Low beams
    - 5.1.8 Using high beam
    - 5.1.9 Using Guidance Light
    - 5.1.10 Emergency brake lights
    - 5.1.11 Parking lights

- 5.1.12 Welcome Light
- 5.1.13 Hazard warning flashers
- 5.1.14 Daytime running lights
- 5.1.15 Location of exterior lights
- 5.1.16 Bulb specifications
- 5.1.17 Checking trailer lights
- 5.2 Interior lighting
  - 5.2.1 Interior Lighting
  - 5.2.2 Adjusting interior lighting
- 5.3 Adjusting light functions via the center display
- 5.4 Lighting control and panel
- 6. Windows, glass and mirrors
  - 6.1 Rearview and door mirrors
    - 6.1.1 HomeLink®
    - 6.1.2 Rearview/door mirrors
    - 6.1.3 Adjusting the door mirrors
    - 6.1.4 Adjusting the rearview mirror dimming function
    - 6.1.5 Using stored positions for seats and mirrors
    - 6.1.6 Storing positions for seats and mirrors
    - 6.1.7 Activating and deactivating the heated rear window and door mirrors
    - 6.1.8 Automatically activating and deactivating the heated rear window and door mirrors
  - 6.2 Windshield and rear window
    - 6.2.1 Damaged windshield
    - 6.2.2 Wiper blades and washer fluid
    - 6.2.3 Using the rain sensor
    - 6.2.4 Using the windshield and headlight washers
    - 6.2.5 Using the windshield wipers
    - 6.2.6 Activating and deactivating the heated rear window and door mirrors
    - 6.2.7 Automatically activating and deactivating the heated rear window and door mirrors
    - 6.2.8 Activating and deactivating the heated windshield
    - 6.2.9 Activating and deactivating automatic windshield heating
  - 6.3 Door windows and panoramic roof
    - 6.3.1 Power windows
    - 6.3.2 Operating the power windows
    - 6.3.3 Panoramic roof
    - 6.3.4 Operating the panoramic roof
    - 6.3.5 Auto closing the panoramic roof sun curtain
  - 6.4 Windows, glass and mirrors
  - 6.5 Pinch protection for windows and sun curtains
  - 6.6 Reset procedure for pinch protection
  - 6.7 Activating and deactivating max defroster
- 7. Seats and steering wheel
  - 7.1 Front seat
    - 7.1.1 Climate controls for front seat
      - 7.1.1.1 Activating and deactivating power front seats
      - 7.1.1.2 Activating and deactivating the heated front seat
      - 7.1.1.3 Setting the blower speed for the front seats
      - 7.1.1.4 Setting the temperature for the front seats
      - 7.1.1.5 Synchronize temperature
    - 7.1.2 Memory function for front seat
      - 7.1.2.1 Using stored positions for seats and mirrors
      - 7.1.2.2 Storing positions for seats and mirrors

- 7.1.3 Front seats
- 7.1.4 Power front seats
- 7.1.5 Adjusting the power front seats
- 7.1.6 Manual front seats
- 7.1.7 Adjusting front seat cushion length
- 7.1.8 Adjusting front seat lumbar support
- 7.2 Rear seat
  - 7.2.1 Climate controls for rear seat
    - 7.2.1.1 Activating and deactivating the heated rear seats
  - 7.2.2 Rear seat
  - 7.2.3 Adjusting the rear seat head restraints
  - 7.2.4 Folding down the rear seat backrests
  - 7.2.5 Rear seat ski hatch
- 7.3 Steering wheel
  - 7.3.1 Speed-dependent steering wheel resistance
  - 7.3.2 Steering wheel controls and horn
  - 7.3.3 Adjusting the steering wheel
  - 7.3.4 Activating and deactivating the heated steering wheel
  - 7.3.5 Activating and deactivating automatic steering wheel heating
- 8. Climate control
  - 8.1 Climate controls
    - 8.1.1 Climate controls for passenger compartment
      - 8.1.1.1 Activating auto climate control
      - 8.1.1.2 Setting the blower speed for the front seats
      - 8.1.1.3 Activating and deactivating air conditioning
      - 8.1.1.4 Activating and deactivating recirculation
      - 8.1.1.5 Activating and deactivating the recirculation timer setting
      - 8.1.1.6 Setting the temperature for the front seats
      - 8.1.1.7 Synchronize temperature
      - 8.1.1.8 Adjusting air distribution
    - 8.1.2 Climate controls for seats and steering wheel
      - 8.1.2.1 Activating and deactivating the heated steering wheel
      - 8.1.2.2 Activating and deactivating automatic steering wheel heating
      - 8.1.2.3 Activating and deactivating the heated rear seats
      - 8.1.2.4 Activating and deactivating power front seats
      - 8.1.2.5 Activating and deactivating the heated front seat
    - 8.1.3 Climate controls for windows and mirrors
      - 8.1.3.1 Activating and deactivating the heated rear window and door mirrors
      - 8.1.3.2 Automatically activating and deactivating the heated rear window and door mirrors
      - 8.1.3.3 Activating and deactivating the heated windshield
      - 8.1.3.4 Activating and deactivating automatic windshield heating
      - 8.1.3.5 Activating and deactivating max defroster
    - 8.1.4 Climate system controls
  - 8.2 Air distribution
    - 8.2.1 Activating and deactivating recirculation
    - 8.2.2 Activating and deactivating the recirculation timer setting
    - 8.2.3 Activating and deactivating max defroster
    - 8.2.4 Air distribution
    - 8.2.5 Adjusting air distribution
    - 8.2.6 Opening, closing and directing air vents
  - 8.3 Air quality
    - 8.3.1 Air quality

- 8.3.2 CleanZone
- 8.3.3 Clean Zone Interior Package
- 8.3.4 Interior Air Quality System
- 8.3.5 Activating and deactivating the air quality sensor
- 8.3.6 Passenger compartment air filter
- 8.3.7 Air purification
- 8.3.8 Starting and stopping air purification
- 8.3.9 Air Quality app
- 8.4 Parking climate
  - 8.4.1 Preconditioning
    - 8.4.1.1 Preconditioning
    - 8.4.1.2 Starting and stopping preconditioning
    - 8.4.1.3 Preconditioning timer
    - 8.4.1.4 Activating and deactivating preconditioning timer
    - 8.4.1.5 Deleting preconditioning timer settings
    - 8.4.1.6 Adding and editing timer settings for preconditioning
  - 8.4.2 Pre-cleaning
    - 8.4.2.1 Air purification
    - 8.4.2.2 Starting and stopping air purification
  - 8.4.3 Parking climate
  - 8.4.4 Parking climate symbols and messages
  - 8.4.5 Climate comfort retaining function
  - 8.4.6 Starting and switching off the climate retaining function when parking
- 8.5 Climate
- 8.6 Climate control system service
- 8.7 Climate control sensors
- 8.8 Climate zones
- 8.9 Perceived temperature
- 9. Key, locks and alarm
  - 9.1 Key
    - 9.1.1 User profiles
      - 9.1.1.1 User profiles
      - 9.1.1.2 Connect key to user profile
      - 9.1.1.3 Managing user profiles
      - 9.1.1.4 Profile settings
      - 9.1.1.5 Connecting an account to a user profile
    - 9.1.2 Electronic immobilizer
    - 9.1.3 Keys
    - 9.1.4 Ordering additional keys
    - 9.1.5 Replacing the key's battery
    - 9.1.6 Locking and unlocking using the key buttons
    - 9.1.7 Care Key – speed-restricted key
    - 9.1.8 Setting speed limitation for Care Key
    - 9.1.9 Unlocking the tailgate using the key button
    - 9.1.10 Detachable key blade
    - 9.1.11 Locking and unlocking with detachable key blade
    - 9.1.12 Key range
    - 9.1.13 Start and lock system type designations
    - 9.1.14 Antenna locations for the start and lock system
    - 9.1.15 Ignition modes
    - 9.1.16 Selecting ignition mode
  - 9.2 Locking and unlocking

- 9.2.1 Keyless locking and unlocking
    - 9.2.1.1 Operating the tailgate with a foot movement
    - 9.2.1.2 Antenna locations for the start and lock system
    - 9.2.1.3 Keyless locking and unlocking with touch-sensitive surfaces
    - 9.2.1.4 Keyless locking and unlocking
    - 9.2.1.5 Keyless unlock settings
    - 9.2.1.6 Closing and locking the tailgate using the buttons
    - 9.2.1.7 Keyless unlocking of the tailgate
  - 9.2.2 Keys
  - 9.2.3 Locking and unlocking using the key buttons
  - 9.2.4 Unlock settings
  - 9.2.5 Unlocking the tailgate using the key button
  - 9.2.6 Locking and unlocking with detachable key blade
  - 9.2.7 Automatic locking when driving
  - 9.2.8 Setting maximum opening height for the power tailgate
  - 9.2.9 Locking and unlocking from inside the vehicle
  - 9.2.10 Unlocking the tailgate from inside the vehicle
  - 9.2.11 Locking and unlocking
  - 9.2.12 Activating and deactivating child locks
  - 9.2.13 Lock indication
  - 9.2.14 Lock confirmation settings
- 9.3 Alarm
- 9.3.1 Alarm
  - 9.3.2 Arming and disarming the alarm
10. Driver support
- 10.1 Cruise Control functions
    - 10.1.1 Cruise control
      - 10.1.1.1 Cruise control
      - 10.1.1.2 Cruise control standby mode
      - 10.1.1.3 Adjusting set speed for speed-controlling functions
    - 10.1.2 Pilot Assist
      - 10.1.2.1 Auto-hold braking with speed-controlling functions
      - 10.1.2.2 Adjusting set speed for speed-controlling functions
      - 10.1.2.3 Switching target vehicles with speed-controlling functions
      - 10.1.2.4 Pilot Assist
      - 10.1.2.5 Pilot Assist displays
      - 10.1.2.6 Pilot Assist symbols and messages
      - 10.1.2.7 Pilot Assist standby mode
      - 10.1.2.8 Setting time interval to the vehicle ahead
      - 10.1.2.9 Differences between Pilot Assist and Lane Keeping Aid
      - 10.1.2.10 Collision risk warning from speed-controlling functions
    - 10.1.3 Passing assistance
      - 10.1.3.1 Passing assistance
      - 10.1.3.2 Using passing assistance
    - 10.1.4 Cruise control functions
    - 10.1.5 Steering wheel buttons for speed-controlling functions
    - 10.1.6 Selecting and activating speed-controlling functions
    - 10.1.7 Deactivating speed-controlling functions
  - 10.2 Distance Alert
    - 10.2.1 Setting time interval to the vehicle ahead
    - 10.2.2 Collision risk warning from speed-controlling functions
  - 10.3 Blind Spot Information

- 10.3.1 BLIS
- 10.3.2 BLIS messages
- 10.3.3 BLIS limitations
- 10.4 Cross Traffic Alert
  - 10.4.1 Warning and auto-braking while backing up
  - 10.4.2 Activating and deactivating warning and auto-braking when backing up
- 10.5 Rear Collision Warning
  - 10.5.1 Rear Collision Warning
  - 10.5.2 Rear Collision Warning limitations
- 10.6 Connected Safety
  - 10.6.1 Connected Safety
  - 10.6.2 Activating and deactivating Connected Safety
  - 10.6.3 Connected Safety limitations
- 10.7 Collision Assistance
  - 10.7.1 Assistance during collision risks
  - 10.7.2 Detecting obstacles with assistance during collision risks
  - 10.7.3 Opportunity to reduce speed with assistance during collision risks
  - 10.7.4 Symbols and messages for assistance during collision risks
  - 10.7.5 Assistance during collision risks limitations
  - 10.7.6 Assistance during collision risks in crossing traffic
  - 10.7.7 Assistance during collision risks in oncoming traffic
  - 10.7.8 Assistance during collision risks with vehicles in your blind spot
  - 10.7.9 Assistance during risk of run-off
- 10.8 Driver Alert Control
  - 10.8.1 Driver Alert
  - 10.8.2 Driver Alert limitations
- 10.9 Lane Keeping Aid
  - 10.9.1 Lane Keeping Aid
  - 10.9.2 Activating and deactivating Lane Keeping Aid
  - 10.9.3 Differences between Pilot Assist and Lane Keeping Aid
  - 10.9.4 Lane Keeping Aid symbols and messages
  - 10.9.5 Lane Keeping Aid display
  - 10.9.6 Lane Keeping Aid limitations
- 10.10 Electronic Stability Control
  - 10.10.1 Electronic Stability Control
  - 10.10.2 Electronic Stability Control symbols and messages
- 10.11 Road Sign Information
  - 10.11.1 Road Sign Information
  - 10.11.2 Road Sign Information limitations
  - 10.11.3 Speed limit and speed camera warnings from Road Sign Information
  - 10.11.4 Activating and deactivating warnings from Road Sign Information
  - 10.11.5 Road Sign Information display
- 10.12 Parking functions
  - 10.12.1 Parking Assist
    - 10.12.1.1 Park Assist
    - 10.12.1.2 Park Assist front, rear and sides
    - 10.12.1.3 Activating and deactivating the Park Assist system
    - 10.12.1.4 Park Assist limitations
    - 10.12.1.5 Park Assist and Park Assist Camera symbols and messages
  - 10.12.2 Park Assist Camera
    - 10.12.2.1 Park Assist Camera
    - 10.12.2.2 Activating Park Assist Camera



- 10.12.2.3 Park Assist and Park Assist Camera symbols and messages
    - 10.12.2.4 Park Assist Camera trajectory lines
    - 10.12.2.5 Location and field of vision of Park Assist Cameras
    - 10.12.2.6 Park Assist sensor field
  - 10.13 Camera and radar sensor
    - 10.13.1 Recommended maintenance for the camera, sensor and radar units
    - 10.13.2 Camera and radar unit symbols and messages
    - 10.13.3 Camera and radar unit limitations
    - 10.13.4 Camera
    - 10.13.5 Radar units
    - 10.13.6 Radar sensor type approval
  - 10.14 Driver support systems
  - 10.15 Driver support warnings
  - 10.16 Speed-dependent steering wheel resistance
  - 10.17 Ready to Drive notification
  - 10.18 Braking assist after a collision
- 11. Starting and driving
  - 11.1 Starting and switching off vehicle
    - 11.1.1 Electronic immobilizer
    - 11.1.2 Starting the vehicle
    - 11.1.3 Jump starting using another battery
    - 11.1.4 Switching off the vehicle
    - 11.1.5 Ignition modes
    - 11.1.6 Selecting ignition mode
  - 11.2 Transmission
    - 11.2.1 The kickdown function
    - 11.2.2 The Launch function
    - 11.2.3 Transmission
    - 11.2.4 Gear selector positions
    - 11.2.5 Shifting gears with automatic transmission
    - 11.2.6 Transmission symbols and messages
    - 11.2.7 All Wheel Drive (AWD)
    - 11.2.8 Shiftlock
  - 11.3 Brakes
    - 11.3.1 Foot brake
      - 11.3.1.1 Brake Assist System
      - 11.3.1.2 Braking on salted roads
      - 11.3.1.3 Braking on wet roads
      - 11.3.1.4 Brakes
      - 11.3.1.5 Maintenance of the brake system
    - 11.3.2 Parking brake
      - 11.3.2.1 Parking brake
      - 11.3.2.2 Activating and deactivating the parking brake
      - 11.3.2.3 Parking on a hill
      - 11.3.2.4 Parking brake malfunction
    - 11.3.3 Brake fluid specifications
    - 11.3.4 Brake functions
    - 11.3.5 Auto-hold brakes
    - 11.3.6 Activating and deactivating Auto-hold at a standstill
    - 11.3.7 Braking assist after a collision
    - 11.3.8 Regenerative braking
  - 11.4 Drive modes

- 11.4.1 Regenerative braking
- 11.4.2 Drive modes
- 11.4.3 Changing drive mode
- 11.4.4 Off-road mode
- 11.4.5 The Launch function
- 11.4.6 All Wheel Drive (AWD)
- 11.5 Start/stop function
  - 11.5.1 Start/Stop function
  - 11.5.2 Activating and deactivating the Start/Stop function
- 11.6 Driving recommendations
  - 11.6.1 Towing using a towline
  - 11.6.2 Braking on salted roads
  - 11.6.3 Braking on wet roads
  - 11.6.4 Parking on a hill
  - 11.6.5 Service stations
  - 11.6.6 Preparing for a long trip
  - 11.6.7 Battery drain
  - 11.6.8 Driving through standing water
  - 11.6.9 Winter driving
  - 11.6.10 Overheating of engine and transmission
- 11.7 Trailer hitch and trailer
  - 11.7.1 Towing capacity and tongue weight
  - 11.7.2 Towbar hitch
  - 11.7.3 Driving with a trailer
  - 11.7.4 Trailer Stability Assist
  - 11.7.5 Checking trailer lights
- 11.8 Fuel
  - 11.8.1 Fuel gauge
  - 11.8.2 Fuel
  - 11.8.3 Octane rating
  - 11.8.4 Emission controls
- 11.9 Refueling
  - 11.9.1 Service stations
  - 11.9.2 Fuel tank volume
  - 11.9.3 Refueling
  - 11.9.4 Opening/closing the fuel filler door
- 11.10 Emission control system
  - 11.10.1 Emission controls
- 11.11 HomeLink
  - 11.11.1 HomeLink®
  - 11.11.2 Using HomeLink®
  - 11.11.3 Programming HomeLink®
  - 11.11.4 Type approval for HomeLink®
- 11.12 Towing
  - 11.12.1 Towing using a towline
  - 11.12.2 Attaching and removing the towing eyelet
  - 11.12.3 Recovery
  - 11.12.4 Safety mode
  - 11.12.5 Starting and moving the vehicle when it is in safety mode
- 12. Audio, media and Internet
  - 12.1 Radio
    - 12.1.1 Sirius XM satellite radio

- 12.1.1.1 SiriusXM® Satellite radio
      - 12.1.1.2 Using SiriusXM® Satellite radio
    - 12.1.2 Radio
    - 12.1.3 Starting the radio
    - 12.1.4 RBDS
    - 12.1.5 Storing radio favorites
  - 12.2 Media player
    - 12.2.1 Bluetooth Media Player
  - 12.3 Phone
    - 12.3.1 Connecting a phone
      - 12.3.1.1 Connecting a phone to the vehicle
      - 12.3.1.2 Disconnecting a Bluetooth-connected phone
      - 12.3.1.3 Switch between phones connected via Bluetooth
      - 12.3.1.4 Disconnecting Bluetooth-connected devices
    - 12.3.2 Apple CarPlay
      - 12.3.2.1 Apple® CarPlay®
      - 12.3.2.2 Using Apple® CarPlay®
      - 12.3.2.3 Tips for using Apple® CarPlay®
    - 12.3.3 Connecting to the Internet via Bluetooth
    - 12.3.4 Phone
    - 12.3.5 Managing contacts
    - 12.3.6 Handling phone calls
    - 12.3.7 Handling text messages
    - 12.3.8 Wireless phone charger
    - 12.3.9 Using the wireless phone charger
    - 12.3.10 Certificate for wireless phone charger
  - 12.4 Apps
    - 12.4.1 Apps
    - 12.4.2 Download apps
    - 12.4.3 Deleting apps
    - 12.4.4 Volvo ID
    - 12.4.5 Creating a Volvo ID
  - 12.5 Internet connection
    - 12.5.1 Internet-based services
      - 12.5.1.1 Connected Safety
      - 12.5.1.2 Apps
      - 12.5.1.3 Volvo ID
      - 12.5.1.4 Creating a Volvo ID
    - 12.5.2 Connecting to the Internet via Bluetooth
    - 12.5.3 Internet connection
    - 12.5.4 Internet connection problems
    - 12.5.5 Connecting to the Internet via Wi-Fi
    - 12.5.6 Markets with Internet via vehicle modem
  - 12.6 Audio and media
  - 12.7 Hard disk storage space
  - 12.8 Sound settings
  - 12.9 Playing media
  - 12.10 Connection and entertainment
  - 12.11 Approval of terms and conditions and data collection
13. Volvo Assistance and the Volvo Cars app
- 13.1 Volvo Assistance
    - 13.1.1 Volvo Assistance

- 13.1.2 Emergency assistance with Volvo Assistance
- 13.1.3 Automatic Crash Notification with Volvo Assistance
- 13.1.4 Stolen Vehicle Tracking (SVT) with Volvo Assistance
- 13.1.5 Volvo Assistance help during a trip
- 13.1.6 Customer service via Volvo Assistance
- 13.1.7 Backup battery for Volvo Assistance
- 13.1.8 Volvo Assistance abroad
- 13.2 Volvo Cars app
  - 13.2.1 Getting started with the Volvo Cars app
  - 13.2.2 Devices compatible with the Volvo Cars app
  - 13.2.3 Contact between the Volvo Cars app and the vehicle
  - 13.2.4 Volvo Cars app
  - 13.2.5 Connecting the Volvo Cars app to the vehicle
  - 13.2.6 Booking service with the Volvo Cars app
  - 13.2.7 Remote Start of the vehicle using the Volvo Cars app
  - 13.2.8 Locking function in the Volvo Cars app
  - 13.2.9 Shortcuts to the Volvo Cars app
  - 13.2.10 Remote Start of the climate system using the Volvo Cars app
  - 13.2.11 Remote start of air purification using the Volvo Cars app
  - 13.2.12 Using the Volvo Cars app with an Apple Watch
  - 13.2.13 Removing the connection between the Volvo Cars app and the vehicle
  - 13.2.14 Change of ownership when the Volvo Cars app is connected to the vehicle
- 14. Navigation
  - 14.1 Map updates
    - 14.1.1 Map downloads
  - 14.2 Google Maps
  - 14.3 Use Google Maps
  - 14.4 Updating Google Maps
  - 14.5 Google Maps settings
  - 14.6 Electric vehicle functions with Google Maps
  - 14.7 Google Maps in the instrument panel
  - 14.8 Destinations in Google Maps
  - 14.9 Connected functions with Google Maps
  - 14.10 Creating route guidance with Google Maps
- 15. Wheels and tires
  - 15.1 Changing a wheel
    - 15.1.1 Changing a wheel
    - 15.1.2 Jack
    - 15.1.3 Wheel bolts
    - 15.1.4 Spare wheel
    - 15.1.5 Handling the spare wheel
    - 15.1.6 Snow chains
    - 15.1.7 Snow tires
    - 15.1.8 Flat tire
    - 15.1.9 Tool kit
  - 15.2 Tires
    - 15.2.1 Tire sidewall designations
    - 15.2.2 Uniform Tire Quality Grading
    - 15.2.3 Tire terminology
    - 15.2.4 Approved tire pressure
    - 15.2.5 Tire direction of rotation
    - 15.2.6 Tread wear indicator

- 15.3 Tire inflation pressure
    - 15.3.1 Tire inflation pressure monitoring
      - 15.3.1.1 Tire Pressure Monitoring System
      - 15.3.1.2 Viewing tire pressure status in the center display
      - 15.3.1.3 Action when warned of low tire pressure
      - 15.3.1.4 Saving new reference values for tire inflation pressure monitoring
      - 15.3.1.5 Messages for tire inflation pressure monitoring
    - 15.3.2 Checking tire pressure
    - 15.3.3 Adjusting tire pressure
    - 15.3.4 Location of tire pressure decal
  - 15.4 Temporary tire sealing
    - 15.4.1 Tire sealing system
    - 15.4.2 Inflating tires using the compressor included in the tire sealing system
    - 15.4.3 Using the tire sealing system
  - 15.5 Driving in winter
    - 15.5.1 Snow chains
    - 15.5.2 Snow tires
    - 15.5.3 Preparing for a long trip
    - 15.5.4 Winter driving
  - 15.6 Tires
  - 15.7 Determining the vehicle's permitted weight
16. Loading, storage and passenger compartment
- 16.1 Loading
    - 16.1.1 Loading recommendations
    - 16.1.2 Determining the vehicle's permitted weight
    - 16.1.3 Grocery bag holders
    - 16.1.4 Cargo anchoring eyelets
    - 16.1.5 Installing and removing the cargo net
    - 16.1.6 Roof loads and load carriers
  - 16.2 Cargo compartment
    - 16.2.1 Cargo net, steel cargo grid and cargo compartment cover
      - 16.2.1.1 Installing and removing the cargo net
    - 16.2.2 Cargo compartment
    - 16.2.3 Grocery bag holders
    - 16.2.4 Removing and storing the parcel shelf
    - 16.2.5 Folding up the cargo compartment floor
    - 16.2.6 Cargo anchoring eyelets
    - 16.2.7 Removing the folding cargo compartment floor
    - 16.2.8 Unlocking the tailgate using the key button
    - 16.2.9 Setting maximum opening height for the power tailgate
    - 16.2.10 Operating the tailgate with a foot movement
    - 16.2.11 Unlocking the tailgate from inside the vehicle
    - 16.2.12 Keyless unlocking of the tailgate
  - 16.3 Storage and passenger compartment
    - 16.3.1 Passenger compartment interior
    - 16.3.2 Electrical outlets
    - 16.3.3 Using the electrical outlets
    - 16.3.4 Using the glove compartment
    - 16.3.5 Sun visors
    - 16.3.6 Tunnel console
    - 16.3.7 USB ports
    - 16.3.8 Charging devices via USB ports

- 16.3.9 Fuses under the left front seat
- 16.4 Rear seat ski hatch
- 17. Maintenance and service
  - 17.1 Vehicle care
    - 17.1.1 Interior cleaning
      - 17.1.1.1 Cleaning the center display
      - 17.1.1.2 Cleaning the instrument panel
      - 17.1.1.3 Cleaning the leather steering wheel
      - 17.1.1.4 Cleaning the seat belt
      - 17.1.1.5 Cleaning the interior
      - 17.1.1.6 Cleaning textile floor and inlay mats
      - 17.1.1.7 Cleaning interior plastic, metal and wood surfaces
      - 17.1.1.8 Cleaning leather upholstery
      - 17.1.1.9 Cleaning Microtech upholstery
      - 17.1.1.10 Cleaning fabric upholstery and headliner
    - 17.1.2 Exterior cleaning
      - 17.1.2.1 Cleaning exterior lights
      - 17.1.2.2 Cleaning the wiper blades
      - 17.1.2.3 Paintwork
      - 17.1.2.4 Color codes
      - 17.1.2.5 Touching up minor paint damage
      - 17.1.2.6 Cleaning the exterior
      - 17.1.2.7 Corrosion protection
      - 17.1.2.8 Automatic car washes
      - 17.1.2.9 Cleaning exterior plastic, rubber and trim components
      - 17.1.2.10 Cleaning rims
      - 17.1.2.11 Hand washing
      - 17.1.2.12 High-pressure washing
      - 17.1.2.13 Polishing and waxing
  - 17.2 Wiper blades and washer fluid
    - 17.2.1 Wiper blades and washer fluid
    - 17.2.2 Putting the wiper blades in service position
    - 17.2.3 Refilling washer fluid
    - 17.2.4 Changing rear window wipers
    - 17.2.5 Replacing windshield wiper blades
  - 17.3 Replacing bulbs
    - 17.3.1 Replacing rear turn signal bulbs
    - 17.3.2 Replacing the brake light bulb
    - 17.3.3 Replacing the rear fog light bulb
    - 17.3.4 Replacing bulbs
    - 17.3.5 Location of exterior lights
    - 17.3.6 Bulb specifications
    - 17.3.7 Checking trailer lights
  - 17.4 Engine compartment
    - 17.4.1 Refilling washer fluid
    - 17.4.2 Brake fluid specifications
    - 17.4.3 Opening and closing the hood
    - 17.4.4 Engine compartment overview
    - 17.4.5 Coolant
    - 17.4.6 Refilling coolant
    - 17.4.7 Engine oil
    - 17.4.8 Checking and filling engine oil

- 17.4.9 Engine oil specifications
- 17.4.10 Fuses in the engine compartment
- 17.5 Tools and accessories
  - 17.5.1 Jack
  - 17.5.2 Tire sealing system
  - 17.5.3 Tool kit
- 17.6 Fuses
  - 17.6.1 Fuses and fuseboxes
  - 17.6.2 Replacing fuses
  - 17.6.3 Fuses under the left front seat
  - 17.6.4 Fuses in the engine compartment
- 17.7 Battery
  - 17.7.1 Replacing the key's battery
  - 17.7.2 Battery drain
  - 17.7.3 Jump starting using another battery
  - 17.7.4 Batteries and power supply
  - 17.7.5 Recycling of batteries
  - 17.7.6 Battery symbols
  - 17.7.7 Start battery
  - 17.7.8 Support battery
- 17.8 Service
  - 17.8.1 Climate control system service
  - 17.8.2 Volvo's service program
- 17.9 Recommended maintenance for the camera, sensor and radar units
- 17.10 Software Updates
- 17.11 Maintenance of the brake system
- 17.12 Data transfer between vehicle and workshop over Wi-Fi
- 17.13 Hoisting the vehicle
- 18. Specifications
  - 18.1 Dimensions and weights
    - 18.1.1 Towing capacity and tongue weight
    - 18.1.2 Dimensions
    - 18.1.3 Weights
  - 18.2 Engine specifications
    - 18.2.1 Engine specifications
    - 18.2.2 Engine oil specifications
  - 18.3 Specifications for fluids and lubricants
    - 18.3.1 Refilling washer fluid
    - 18.3.2 Air conditioning specifications
    - 18.3.3 Brake fluid specifications
    - 18.3.4 Transmission fluid specifications
    - 18.3.5 Fuel tank volume
    - 18.3.6 Engine oil specifications
  - 18.4 Specifications for wheels and tires
    - 18.4.1 Approved tire pressure
  - 18.5 Bulb specifications
  - 18.6 Type designations

# 1. Owner's information



---

## 1.1. Owner's information

Owner's information is available in several different formats, both digital and printed. The Owner's Manual is available on the vehicle's center display and on Volvo Cars' support site. There is also a digital Quick Guide that can be accessed from the Owner's Manual in the center display. The glove compartment contains a supplement to the Owner's Manual with a selection of practical information that can be good to have on hand for times when it's not possible or convenient to read from the center display, such as if you need to change a tire.



### Vehicle's center display

To access the Owner's Manual, tap  and then tap . This gives you access to visual navigation with exterior and interior images of the vehicle. The information is searchable and is divided into categories.

### Volvo Cars support site

Volvo Cars' website and support site contain additional information about your vehicle.

Go to [volvocars.com/intl/support](https://www.volvocars.com/intl/support) [<https://www.volvocars.com/intl/support>] and select your country. The website is available on most markets.

Contact information for customer support and your nearest Volvo retailer are available on the support site.



## Printed information

The glove compartment contains a printed supplement to the Owner's Manual, which contains a summary of important and practical information.

Other printed information may also be provided in the vehicle, depending on equipment level, market, etc.

### Important

The driver is always responsible for operating the vehicle in a safe manner and adhering to all applicable laws and regulations. It is also important that the vehicle is operated, maintained and serviced according to Volvo's recommendations provided in the owner's information.

If the information in the center display and other sources differs, the information in the center display applies.

### Note

Changing languages in the center display could mean that certain owner's information will not comply with national or local laws and regulations. Do not change to a language you do not speak well, as it can be difficult to find your way back through the menu.

## 1.2. Using the Owner's Manual

To get to know your new vehicle, read the Owner's Manual before driving it for the first time.

Reading your Owner's Manual is a way to familiarize yourself with new features and functions, get advice on how to handle your vehicle in different situations, and to learn how to take advantage of everything your Volvo has to offer. Pay particular attention to the safety warnings provided in the Owner's Manual.

Volvo continuously works to develop and improve our products. Modifications can mean that information, descriptions and illustrations in the Owner's Manual differ from the equipment in the vehicle. We reserve the right to make changes without prior notice.

© Volvo Car Corporation

### Option/accessory

In addition to standard equipment, the Owner's Manual also describes options (factory-installed equipment) and certain accessories (extra retrofitted equipment).

All, at the time of publication known, options and accessories are marked with an asterisk: \*.

The equipment described in the Owner's Manual is not available in all vehicles. Vehicles may be equipped differently depending on market requirements and national or local laws and regulations.

The intention of this owner's information is to explain all of the possible features, functions, options and accessories included in a Volvo vehicle. It is not intended as an indication or guarantee that all of these features, functions and options are included in every vehicle. Some terminology used may not exactly match terminology used in sales, marketing and advertising materials.

For more information on which equipment is standard and which is an option or accessory, please contact your Volvo retailer.

## Decals

There are various types of decals affixed in the vehicle to communicate important information in a clear manner. The importance of these decals is explained as follows, in descending order of importance.

### Risk of injury

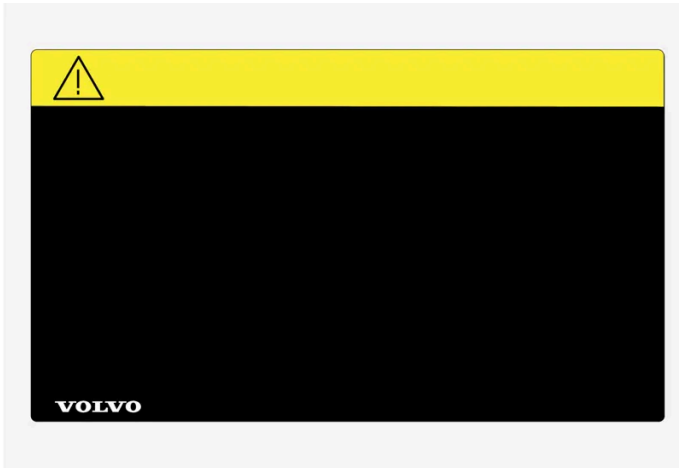

Black ISO symbols on a yellow warning field, white text/image on a black message field. Used to indicate potential danger. Ignoring a warning of this type could result in serious injury or death.

### Risk of damage



White ISO symbols and white text/image on a black or blue warning field and message field. Used to indicate potential danger. Ignoring a warning of this type could result in damage.



White ISO symbols and white text/image on a black message field.

 **Note**

The decals shown in the Owner's Manual do not claim to be exact reproductions of those found in the vehicle. The purpose is to show approximately how they look and about where they are located. The information that applies for your vehicle in particular is found on the decal on the vehicle.

## Illustrations, images and video clips

Illustrations, images and video clips used in the Owner's Manual are sometimes generic and are intended to provide an overview or an example of a certain function or feature. They may vary depending on equipment level and market and may differ from the appearance of your vehicle.

\* Option/accessory.

---

## 1.3. Complete Owner's Manual in the center display

The printed supplement only contains selected information. You can find complete and up-to-date information in the vehicle's center display.





**!** Important

To familiarize yourself with important safety instructions and to optimize your experience, Volvo recommends reading the owner's information under each category in the center display in its entirety before driving the vehicle for the first time.

**!** Important

The driver is always responsible for operating the vehicle in a safe manner and adhering to all applicable laws and regulations. It is also important that the vehicle is operated, maintained and serviced according to Volvo's recommendations provided in the owner's information.

## Finding information in the vehicle's center display

Complete and up-to-date information for your vehicle is always available in the center display. To access the Owner's Manual, tap  and then .

Find information by:

- using the search function
- visually navigating using exterior and interior images
- clicking through categories.

 **Note**

The digital Owner's Manual is not available during driving.

Changing languages in the center display could mean that some of the owner's information will not comply with national or local rules and regulations. Do not change to a language that you do not understand well, as this could make it difficult for you to navigate back through the menu.

## Printed information and support site

Other printed information may also be provided in the vehicle, depending on equipment level, market, etc.

The accompanying supplement can also be ordered. Contact a Volvo retailer to order.

The Owner's Manual is also available on [volvocars.com/intl/support](https://www.volvocars.com/intl/support) [<https://www.volvocars.com/intl/support>].

 **Note**

If the information in the center display and other sources differs, the information in the center display applies.

---

## 1.4. Navigate in the Owner's Manual in the center display

The digital Owner's Manual can be accessed from the center display.

To access the Owner's Manual, tap  and then .

There are a number of ways to find information in the Owner's Manual.

### Contents of the Owner Manual

#### Start page



Tap the symbol to return to the Owner's Manual start page.

#### Categories

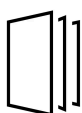

The articles in the Owner's Manual are structured into main and sub-categories. The same article may appear in several relevant categories in order to help make them easier to find.

#### Visual navigation

Exterior and interior overviews of the vehicle. Hotspots are provided for certain functions, components, etc. Tap a hotspot to come to a relevant article.

**1** Press **Exterior** or **Interior**.

➤ Exterior or interior images of the vehicle are shown with hotspots. The hotspots lead to articles about the corresponding function, component, etc. Swipe the screen horizontally to scroll between the images.

**2** Tap a hotspot.

➤ The title of a relevant article will be displayed.

**3** Tap the title to open the article.

To go back, tap the left arrow.

**Quick guide**

Useful information about the most commonly used features and functions in your vehicle.

**Video**



Tap the symbol to go to brief instructive videos for various functions in the vehicle.

**Release notes**

Read more about the current version and implemented updates.

## Search function

Tap the search field at the top of the Owner's Manual to reach the search function from the start page.

Use  at the top of the Owner's Manual to reach the search function from other pages.

## 2. Your Volvo

---

### 2.1. Volvo's innovation areas

---

#### 2.1.1. Eco-efficiency

Volvo is committed to the well-being of its customers. As a natural part of this commitment, we care about the environment in which we all live. Concern for the environment means an everyday involvement in reducing our environmental impact.

Volvo's environmental activities are based on a holistic view, which means we consider the overall environmental impact of a product throughout its complete life cycle. In this context, design, production, product use, and recycling are all important considerations. In production, Volvo has partly or completely phased out several chemicals including CFCs, lead chromates, asbestos, and cadmium; and reduced the number of chemicals used in our plants 50% since 1991.

Volvo was the first in the world to introduce into production a three-way catalytic converter with a Lambda sond, now called the heated oxygen sensor, in 1976. The current version of this highly efficient system reduces emissions of harmful substances (CO, HC, NOx) from the exhaust pipe by approximately 95 - 99% and the search to eliminate the remaining emissions continues. Volvo is the only automobile manufacturer to offer CFC-free retrofit kits for the air conditioning system of all models as far back as the 1975 model 240. Advanced electronic engine controls and cleaner fuels are bringing us closer to our goal. In addition to continuous environmental refinement of conventional gasoline-powered internal combustion engines, Volvo is actively looking at advanced technology alternative-fuel vehicles.

When you drive a Volvo, you become our partner in the work to lessen the vehicle's impact on the environment. To reduce your vehicle's environmental impact, you can:

- Maintain proper air pressure in your tires. Tests have shown decreased fuel economy with improperly inflated tires.
- Follow the recommended maintenance schedule in your Warranty and Service Records Information booklet.
- Drive at a constant speed whenever possible.
- See a trained and qualified Volvo service technician as soon as possible for inspection if the check engine (malfunction indicator) light illuminates, or stays on after the vehicle has started.
- Properly dispose of any vehicle-related waste such as used motor oil, used batteries, brake pads, etc.
- When cleaning your vehicle, please use genuine Volvo car care products. All Volvo car care products are formulated to be environmentally friendly.

---

#### 2.1.2. Connection and entertainment

The vehicle has an intelligent interface and offers Internet connection to the digital world. An intuitive navigation structure offers access to relevant assistance, information and entertainment when it is needed.

The content of this manual represents the status of the user manual at the time of printing and may not be completely valid in future instances. For more information refer to the first page for the complete disclaimer note.

It includes all of the solutions in the vehicle related to entertainment, Internet connection and navigation, and serves as the user interface between the driver and the vehicle.

Where Volvo is responsible for the provision of mobile connectivity services to enable use of certain functions, and excluding any separate contract for mobile connectivity services of the owner or any other user of the car that Volvo is not party to, each user understands and agrees that, to the extent permitted by law, it: (1) has no contractual relationship with the underlying wireless service carrier, (2) is not a third party beneficiary of any agreement between the car owner and the underlying carrier, (3) that the underlying carrier has no liability of any kind to the user, whether for breach of contract, warranty, negligence, strict liability in tort or otherwise, (4) that data transmissions and messages may be delayed, deleted or not delivered, and emergency calling may not be completed, (5) the underlying carrier cannot guarantee the security of wireless transmissions and will not be liable for any lack of security relating to the use of the services.

## Fair Use Policy

Your use of connectivity services that are part of your vehicle is subject to this Fair Use Policy.

When using this Service, you agree not to

- submit content that is unlawful, obscene, libelous, threatening, harassing, hateful, racially or ethnically offensive or otherwise inappropriate
- use the Service in breach of any applicable law
- use the Service for commercial purposes.

Your access to the Service is part of a shared access. Volvo reserves the right to suspend your access to or use of the Service if your use involves very high volumes of data, disproportionate to other users. Volvo may also suspend your access for technical reasons or to protect other functions of your vehicle. Your access to the connected Service is subject to the third-party terms and conditions of the mobile network provider.

## Information when it's needed, where it's needed

The vehicle's displays present the right information at the right time. Information is presented in different displays depending on how it should be prioritized by the driver.

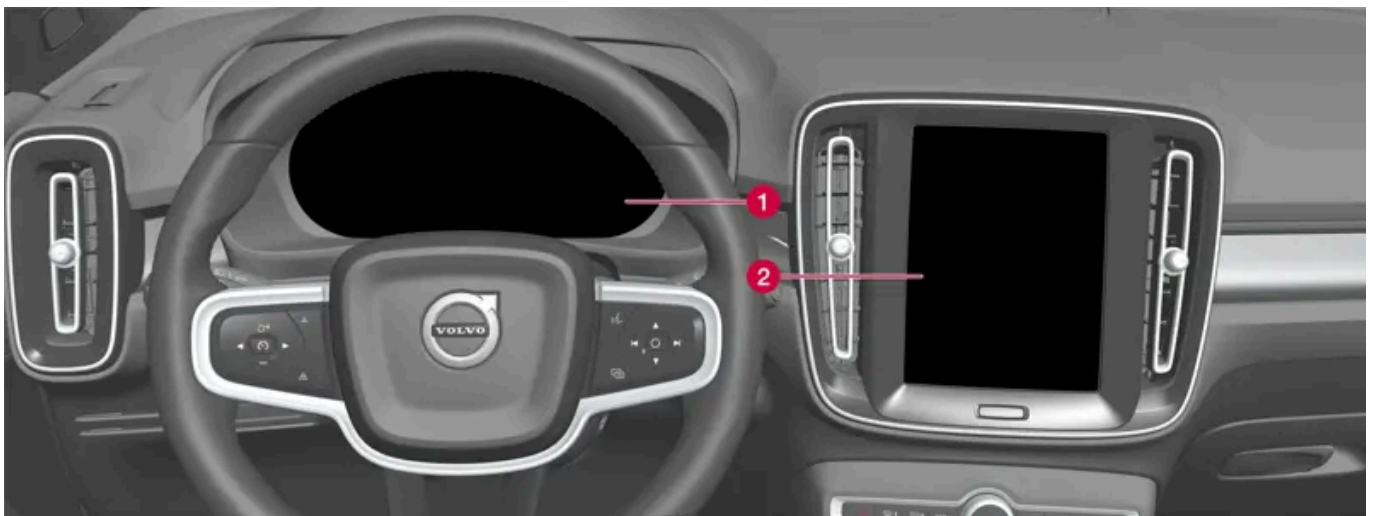

Different types of information are shown in different displays depending on how the information should be prioritized.

- 1** The instrument panel shows information about speed, road sign information, warning and indicator symbols, battery status, etc. The instrument panel can also show incoming calls or information about the current song on the radio. It is controlled using the steering wheel keypads.

**The content of this manual represents the status of the user manual at the time of printing and may not be completely valid in future instances. For more information refer to the first page for the complete disclaimer note.**



- 2 Many of the vehicle's main functions are controlled from the center display, such as the climate control system, the entertainment system and seat positions. The center display also shows navigation and road sign information. The information presented in the center display can be handled by the driver or by someone else in the vehicle.

**Note**

Wearing gloves can limit or prevent touchscreen response.

#### Voice control system

The voice control system enables the driver to control certain vehicle functions without taking their hands off the wheel. The system can understand natural speech. Use voice control to e.g. play a song, make a phone call, increase the temperature in the passenger compartment or have a text message read aloud.

## 2.2. Volvo ID

### 2.2.1. Volvo ID

Volvo ID is a personal ID that gives you access to a range of services using a single username and password.

One example of a service in which a Volvo ID is needed is to check the vehicle via your phone using the Volvo Cars app.

A Volvo ID can be created from the vehicle, at [volvoid.eu.volvocars.com/Account](https://volvoid.eu.volvocars.com/Account/) [https://volvoid.eu.volvocars.com/Account/] or in the Volvo Cars app.

**Note**

The available services can vary over time and depend on equipment level and market.

### 2.2.2. Creating a Volvo ID

To use Volvo services connected to the vehicle, such as via the Volvo Cars app, a Volvo ID must be created.

#### Creating a Volvo ID with the Volvo Cars app

- 1 Download the latest version of the Volvo Cars app<sup>[1]</sup> to your phone.
- 2 Choose to create a Volvo ID.

- 3 The website for creating a Volvo ID will appear.
  - 4 Enter a personal email address or cell phone number.
  - 5 Follow the instructions that will be sent automatically to this email address/cell phone number.
- A Volvo ID is created and ready for use.

#### Creating a Volvo ID on the Volvo Cars website

- 1 Go to [volvoid.eu.volvocars.com/Account](https://volvoid.eu.volvocars.com/Account) [<https://volvoid.eu.volvocars.com/Account/>]. Choose to create a Volvo ID.
  - 2 Enter a personal email address or cell phone number.
  - 3 Follow the instructions that will be sent automatically to this email address/cell phone number.
- A Volvo ID is created and ready for use.

<sup>[1]</sup> Can be downloaded from e.g. the Apple App Store or Google Play.

---

## 2.2.3. Problems logging in with Volvo ID

This article describes problems that may arise when logging in with Volvo ID. For example if you have forgotten your password or your Volvo ID username.

#### Forgotten your password

To reset your password, follow the instructions below:

In the Volvo Cars app<sup>[1]</sup>

- 1 Open the Volvo Cars app.
- 2 Select "Log in."
- 3 Press "Forgotten password?" and follow the instructions.

You can also change your password at [volvoid.eu.volvocars.com/Account](https://volvoid.eu.volvocars.com/Account) [<https://volvoid.eu.volvocars.com/Account/>].

#### Login error after creating a new account

Sometimes there may be a delay in the process which can result in an account not being available directly after it has been created. Try again after 24 hours and if the problem persists contact your local Volvo retailer or Volvo Cars customer service for further assistance.

#### **What is my Volvo ID (user name)?**

Your Volvo ID is the same as the registered email address/cellular phone number.

#### **Unlock your Volvo ID**

Your account will be locked after 5 failed attempts to log in to the Volvo Cars app<sup>[1]</sup>. You can unlock your account by clicking **Forgot password?** in the login screen.

#### **Changed email address**

If you get a new email address and still have access to your previous address, you can log in using your old credentials and change your username yourself. If you no longer have access to your old email address, you should create a new Volvo ID using your new address.

#### **Login error after changing Volvo ID (user name)**

Make sure you receive a confirmation message verifying your new username. When this has been done you should be able to login using the new username. If you did not receive the confirmation message, your old username will remain. Log in and try again to change the username.

#### **Login error after changing password**

Try logging in with your previous password. If this doesn't work, try to reset your password.

#### **Account registered to another market**

An account is registered to a specific market and cannot be moved to a different market. To be able to reuse the same email address/cellular phone number, we advise you to first delete your account for the old market and then create a new account for the new market.

#### **E-mail error**

If you have entered an email address as username and did not receive a confirmation message after registration, check that you provided a valid email address and that the message was not stopped by a junk mail filter. Try to register your email address again.

## **Further assistance**

If you have not found the solution to a problem regarding Volvo ID and need further assistance, contact your local Volvo retailer or Volvo Cars customer service.

<sup>[1]</sup> Certain markets only.

## 2.3. Type approval and licenses

### 2.3.1. Antenna type approval

Type approval for the vehicle's antenna is provided below.

Continental
Model: TCAM1NA0
FCC ID:KR5TCAM1NA0
IC:7812D-TCAM1NA0

This device complies with Part 15 of the FCC Rules and Industry Canada licence-exempt RSS standard(s). Operation is subject to the following two conditions: (1) this device may not cause interference, and (2) this device must accept any interference, including interference that may cause undesired operation of the device.

Le présent appareil est conforme aux CNR d'Industrie Canada applicables aux appareils radio exempts de licence. L'exploitation est autorisée aux deux conditions suivantes : (1) l'appareil ne doit pas produire de brouillage, et (2) l'utilisateur de l'appareil doit accepter tout brouillage radioélectrique subi, même si le brouillage est susceptible d'en compromettre le fonctionnement.

This device complies with FCC/ISED radiation exposure limits set forth for an uncontrolled environment and meets the FCC radio frequency (RF) Exposure Guidelines and RSS-102 of the ISED radio frequency (RF) Exposure rules. This transmitter must not be co-located or operating in conjunction with any other antenna or transmitter. The antenna should be installed and operated with minimum distance of 2.4 cm between the radiator and your body.

Le présent appareil est conforme à l'exposition aux radiations FCC / ISED définies pour un environnement non contrôlé et répond aux directives d'exposition de la fréquence de la FCC radiofréquence (RF) et RSS-102 de la fréquence radio (RF) ISED règles d'exposition. L'émetteur ne doit pas être colocalisé ni fonctionner conjointement avec à autre antenne ou autre émetteur. L'antenne doit être installée de façon à garder une distance minimale de 2.4 centimètres entre la source de rayonnements et votre corps.

#### **FCC Class B digital device notice**

This equipment has been tested and found to comply with the limits for a Class B digital device, pursuant to part 15 of the FCC Rules. These limits are designed to provide reasonable protection against harmful interference in a residential installation. This equipment generates, uses and can radiate radio frequency energy and, if not installed and used in accordance with the instructions, may cause harmful interference to radio communications. However, there is no guarantee that interference will not occur in a particular installation. If this equipment does cause harmful interference to radio or television reception, which can be determined by turning the equipment off and on, the user is encouraged to try to correct the interference by one or more of the following measures:

- Reorient or relocate the receiving antenna.
- Increase the separation between the equipment and receiver.
- Connect the equipment into an outlet on a circuit different from that to which the receiver is connected.
- Consult the dealer or an experienced radio/TV technician for help.

Continental Automotive GmbH has not approved any changes or modifications to this device by the user. Any changes or modifications could void the user's authority to operate the equipment.

Continental Automotive GmbH n'approuve aucune modification apportée à l'appareil par l'utilisateur, quelle qu'en soit la nature. Tout changement ou modification peuvent annuler le droit d'utilisation de l'appareil par l'utilisateur.

**CAN ICES-3 (B) / NMB-3 (B)**

This Class B digital apparatus complies with Canadian ICES-003.

Cet appareil numérique de classe B est conforme à la norme canadienne ICES-003.

## 2.3.2. License agreement for instrument panel

A license is an agreement on the right to conduct a certain activity or the right to use someone else's right according to terms and conditions specified in the agreement. The following text is Volvo's agreement with the manufacturer or developer.

### 1.1 List of used Open Source Components

This table contains a list of open source software (OSS) components used within the product under the terms of the respective licenses. The source code corresponding to the open source components is also provided along with the product wherever mandated by the respective OSS license

SI No.	Name of OSS Component	Version of OSS Component	Name and Version of License (License text can be found in Appendix below)	Home Page	More Information
1	BidiReferenceCpp	26	Unicode Terms of Use	<a href="http://www.unicode.org/Public/PR/OGRAMS/BidiReferenceCpp/">http://www.unicode.org/Public/PR/OGRAMS/BidiReferenceCpp/</a>	(C) Socionext Embedded Software Austria GmbH (SESA) Copyright (C) 1999-2009, ASMUS, Inc
2	FASTCRC32	1.2.8	License of Stephan brumme/ Zlib style License	<a href="http://stephan-brumme.com/">http://stephan-brumme.com/</a>	Copyright © 2011-2013 Stephan Brumme. All rights reserved, Copyright (C) 1995-2006, 2010, 2011, 2012 Mark Adler
3	Freescale IMX6 HDMI	5.0.11	BSD 3-clause "New" or "Revised" License	<a href="https://www.nxp.com/">https://www.nxp.com/</a> [ <a href="https://www.nxp.com/">https://www.nxp.com/</a> ]	Copyright © 2009-2012, Freescale Semiconductor, Inc, Copyright © 2010-2012, Freescale Semiconductor, Inc.
4	FreeType Hashing	2.6.3	MIT License	<a href="https://sourceforge.net/p/canvasdraw/cd/642/tree/trunk/freetype/include/freetype/internal/fthash.h">https://sourceforge.net/p/canvasdraw/cd/642/tree/trunk/freetype/include/freetype/internal/fthash.h</a> [ <a href="http://sourceforge.net/p/canvasdraw/cd/642/tree/trunk/freetype/include/freetype/internal/fthash.h">http://sourceforge.net/p/canvasdraw/cd/642/tree/trunk/freetype/include/freetype/internal/fthash.h</a> ]	Copyright 2000 Computing Research Labs, New Mexico State University Copyright 2001-2015 Francesco Zappa Nardelli

SI No.	Name of OSS Component	Version of OSS Component	Name and Version of License (License text can be found in Appendix below)	Home Page	More Information
5	Freetype Project - BDF	2.6.3	MIT License	<a href="https://sourceforge.net/projects/freetype/files/freetype2/2.6.3/[https://www.freetype.org/">https://sourceforge.net/projects/freetype/files/freetype2/2.6.3/[https://www.freetype.org/]</a>	Copyright (C) 2001-2014 by Francesco Zappa Nardelli. Copyright 2000 Computing Research Labs, New Mexico State University
6	Freetype Project - PCF	2.6.3	MIT License	<a href="https://sourceforge.net/projects/freetype/files/freetype2/2.6.3/[https://www.freetype.org/">https://sourceforge.net/projects/freetype/files/freetype2/2.6.3/[https://www.freetype.org/]</a>	Copyright 2000-2001, 2003 by Francesco Zappa Nardelli Copyright (C) 2000, 2001, 2002, 2003, 2006, 2010 by Francesco Zappa Nardelli Copyright (C) 2000-2004, 2006-2011, 2013, 2014 by Francesco Zappa Nardelli Copyright 2000-2010, 2012-2014 by Francesco Zappa Nardelli Copyright 2003 by Francesco Zappa Nardelli
7	Freetype Project - Pcfutil	2.6.3	Open Group License	<a href="https://sourceforge.net/projects/freetype/files/freetype2/2.6.3/[https://www.freetype.org/">https://sourceforge.net/projects/freetype/files/freetype2/2.6.3/[https://www.freetype.org/]</a>	Copyright 1990, 1994, 1998 The Open Group
8	HarfBuzz	1.3.1	MIT License	<a href="http://freedesktop.org/wiki/Software/HarfBuzz">http://freedesktop.org/wiki/Software/HarfBuzz</a>	Copyright © 2007 Chris Wilson Copyright © 2009,2010 Red Hat, Inc. Copyright © 2011, 2012 Google, Inc.
9	Integrity Libnet	1.16	Internet Software Consortium-IBM License ISC License	<a href="https://github.com/lattera/glibc/blob/master/resolv/inetpton.c">https://github.com/lattera/glibc/blob/master/resolv/inetpton.c</a> [https://github.com/lattera/glibc/blob/master/resolv/inetpton.c]	Copyright © 1996 by Internet Software Consortium. Consortium, Copyright © 1995 by International Business Machines, Inc.
10	Khronos EGL Headers	1.4	MIT License	<a href="http://www.khronos.org/registry/egl/">http://www.khronos.org/registry/egl/</a>	Copyright © 2007-2013 The Khronos Group Inc. Copyright 2008 VMware, Inc. Copyright © 2013-2014 The Khronos Group Inc.
11	Khronos Group - OpenGL ES	2.0	SGI Free Software License B v2.0	<a href="http://www.khronos.org/opengles/">http://www.khronos.org/opengles/</a>	
12	libjpeg	6b	Independent JPEG Group License	<a href="http://www.ijg.org/">http://www.ijg.org/</a>	Copyright (C) 1991-1998, Thomas G. Lane.
13	libpng	1.4.22	libpng License	<a href="http://github.com/coapp-packages/libpng/">http://github.com/coapp-packages/libpng/</a>	Copyright © 1998-2010 Glenn Randers-Pehrson Copyright © 2007, 2009 Glenn Randers-Pehrson Version 0.96 Copyright © 1996, 1997 Andreas Dilger Version 0.88 Copyright © 1995, 1996 Guy Eric Schalnat, Group 42, Inc.
14	Libunibreak	1.2.8	zlib License	<a href="https://github.com/adah1972/libunibreak">https://github.com/adah1972/libunibreak</a> [https://github.com/adah1972/libunibreak]	Copyright (C) 2008-2011 Wu Yongwei Copyright (C) 2012 Tom Hacoheh <a href="mailto:tom@stosb.com">tom@stosb.com</a>
15	Iz4 Compression algorithm	1.4.0	BSD 2-clause "Simplified" License	<a href="http://github.com/Cyan4973/iz4/">http://github.com/Cyan4973/iz4/</a>	Copyright (C) 2011-2014, Yann Collet

SI No.	Name of OSS Component	Version of OSS Component	Name and Version of License (License text can be found in Appendix below)	Home Page	More Information
16	md5	1.6	Public Domain	<a href="https://doxygen.reactos.org/d7/d04/sdk_2lib_23rdparty_2freetype_2src_2base_2md5_8c_source.html">https://doxygen.reactos.org/d7/d04/sdk_2lib_23rdparty_2freetype_2src_2base_2md5_8c_source.html</a> [ <a href="https://doxygen.reactos.org/d7/d04/sdk_2lib_23rdparty_2freetype_2src_2base_2md5_8c_source.html">https://doxygen.reactos.org/d7/d04/sdk_2lib_23rdparty_2freetype_2src_2base_2md5_8c_source.html</a> ]	
17	NetBSD	1.9	HPND like license IBM License BSD-4-Clause (University of California-Specific) BSD 3-clause "New" or "Revised" License BSD One Clause License	<a href="http://www.netbsd.org/">http://www.netbsd.org/</a>	Copyright © 1998 Manuel Bouyer Copyright © 1996 Matt Thomas. Copyright 1997 Marshall Kirk McKusick. All Rights Reserved, Copyright © 1985, 1988, 1989, 1991, 1993, 1995 The Regents of the University of California Copyright © 1989, 1993 The Regents of the University of California Copyright © 1983, 1993 The Regents of the University of California Copyright 2000-2011 Green Hills Software Copyright (c) 1996 by Internet Software Consortium. Copyright (C) 1998 WIDE Project, Portions Copyright © 1995 by International Business Machines, Inc, Copyright (C) 1994, 1995, 1997 TooLs GmbH Copyright (C) 1994, 1995, 1997 Wolfgang Solfrank Copyright © 1995, 1999 Berkeley Software Design, Inc Portions Copyright © 1993 by Digital Equipment Corporation Copyright © 1992 Henry Spencer Copyright © 1997, 1998, 1999 The NetBSD Foundation, Inc Copyright © 1996 by Internet Software Consortium. Copyright (c) 1994 James A. Jegers(c) © UNIX System Laboratories, Inc.
18	NetBSD_BSD4	1.9	BSD 4-clause "Original" or "Old" License	<a href="http://www.netbsd.org/">http://www.netbsd.org/</a>	Copyright 2000-2011, 2000-2013 Green Hills Software, Copyright © 1994, 1998 Christopher G. Demetriou, Copyright © 1982, 1986, 1990, 1993, 1994 The Regents of the University of California. All rights reserved. © UNIX System Laboratories, Inc.
19	The FreeType Project -freetype2	2.6.3	Freetype Project License	<a href="http://sourceforge.net/projects/freetype/">http://sourceforge.net/projects/freetype/</a>	Copyright 1996-2016 by David Turner, Robert Wilhelm, and Werner Lemberg, Copyright 2007-2016 by Rahul Bhalaria, Copyright 2009-2016 by Oran Agra and Mickey Gabel, Copyright 2008-2016 by David Turner, Robert Wilhelm, Werner Lemberg, and suzuki toshiya. Copyright 2000 Computing Research Labs, New Mexico State University, Copyright 2001-2015 Francesco Zappa Nardelli, Copyright 2004-2016 by Masatake YAMATO and Redhat K.K, Copyright 2007-2016 by Derek Clegg and Michael Toftdal, Copyright 2010-2016 by Joel Klinghed, Copyright 2007-2013 Adobe Systems Incorporated, Copyright 2007-2014 Adobe Systems Incorporated, Copyright 2004-2016 by Albert Chin-A-Young, Copyright 2013-2016 by Google, Inc, Copyright 2002-2016 by Roberto Alameda, Copyright 2003 Huw D M Davies for Codeweavers, Copyright 2007 Dmitry Timoshkov for Codeweavers
20	Vivante Driver software	viv5.0.11p7.4.i3	MIT License	<a href="http://www.vivante.com/">http://www.vivante.com/</a>	Copyright 2012 - 2016 Vivante Corporation, Santa Clara, California Copyright © 2007 The Khronos Group Inc Copyright © 2014 - 2016 Vivante Corporation Copyright 2012 Vivante Corporation, Sunnyvale, California Copyright © 2011 Intel Corporation Copyright (C) 1999-2001 Brian Paul
21	zlib	1.2.8	zlib License	<a href="http://www.zlib.net/">http://www.zlib.net/</a>	Copyright (C) 1995-2007 Mark Adler Copyright (C) 1995-2005 Jean-loup Gailly Copyright (C) 1995-2012 Mark Adler Copyright (C) 2003 Chris Anderson Copyright (C) 1998 Brian Raiter
22	RBTree.cpp	3.4.2	Public Domain	<a href="https://www.eu.socionext.com/">https://www.eu.socionext.com/</a>	(C) Socionext Embedded Software Austria GmbH (SESA)

## 2. APPENDIX - LICENSE TEXT

### 2.1 HPND Like license

The content of this manual represents the status of the user manual at the time of printing and may not be completely valid in future instances. For more information refer to the first page for the complete disclaimer note.

Portions Copyright (c) 1993 by Digital Equipment Corporation.

Permission to use, copy, modify, and distribute this software for any purpose with or without fee is hereby granted, provided that the above copyright notice and this permission notice appear in all copies, and that the name of Digital Equipment Corporation not be used in advertising or publicity pertaining to distribution of the document or software without specific, written prior permission.

THE SOFTWARE IS PROVIDED "AS IS" AND DIGITAL EQUIPMENT CORP. DISCLAIMS ALL WARRANTIES WITH REGARD TO THIS SOFTWARE, INCLUDING ALL IMPLIED WARRANTIES OF MERCHANTABILITY AND FITNESS. IN NO EVENT SHALL DIGITAL EQUIPMENT CORPORATION BE LIABLE FOR ANY SPECIAL, DIRECT, INDIRECT, OR CONSEQUENTIAL DAMAGES OR ANY DAMAGES WHATSOEVER RESULTING FROM LOSS OF USE, DATA OR PROFITS, WHETHER IN AN ACTION OF CONTRACT, NEGLIGENCE OR OTHER TORTIOUS ACTION, ARISING OUT OF OR IN CONNECTION WITH THE USE OR PERFORMANCE OF THIS SOFTWARE.

## **2.2 BSD 2-clause "Simplified" License**

BSD Two Clause License

Redistribution and use in source and binary forms, with or without modification, are permitted provided that the following conditions are met: Redistributions of source code must retain the above copyright notice, this list of conditions and the following disclaimer. Redistributions in binary form must reproduce the above copyright notice, this list of conditions and the following disclaimer in the documentation and/or other materials provided with the distribution.

THIS SOFTWARE IS PROVIDED BY THE AUTHOR "AS IS" AND ANY EXPRESS OR IMPLIED WARRANTIES, INCLUDING, BUT NOT LIMITED TO, THE IMPLIED WARRANTIES OF MERCHANTABILITY AND FITNESS FOR A PARTICULAR PURPOSE ARE DISCLAIMED. IN NO EVENT SHALL THE AUTHOR BE LIABLE FOR ANY DIRECT, INDIRECT, INCIDENTAL, SPECIAL, EXEMPLARY, OR CONSEQUENTIAL DAMAGES (INCLUDING, BUT NOT LIMITED TO, PROCUREMENT OF SUBSTITUTE GOODS OR SERVICES; LOSS OF USE, DATA, OR PROFITS; OR BUSINESS INTERRUPTION) HOWEVER CAUSED AND ON ANY THEORY OF LIABILITY, WHETHER IN CONTRACT, STRICT LIABILITY, OR TORT (INCLUDING NEGLIGENCE OR OTHERWISE) ARISING IN ANY WAY OUT OF THE USE OF THIS SOFTWARE, EVEN IF ADVISED OF THE POSSIBILITY OF SUCH DAMAGE.

## **2.3 IBM License**

Portions Copyright (c) 1995 by International Business Machines, Inc.

International Business Machines, Inc. (hereinafter called IBM) grants permission under its copyrights to use, copy, modify, and distribute this Software with or without fee, provided that the above copyright notice and all paragraphs of this notice appear in all copies, and that the name of IBM not be used in connection with the marketing of any product incorporating the Software or modifications thereof, without specific, written prior permission.

To the extent it has a right to do so, IBM grants an immunity from suit under its patents, if any, for the use, sale or manufacture of products to the extent that such products are used for performing Domain Name System dynamic updates in TCP/IP networks by means of the Software. No immunity is granted for any product per se or for any other function of any product.

THE SOFTWARE IS PROVIDED "AS IS", AND IBM DISCLAIMS ALL WARRANTIES, INCLUDING ALL IMPLIED WARRANTIES OF MERCHANTABILITY AND FITNESS FOR A PARTICULAR PURPOSE. IN NO EVENT SHALL IBM BE LIABLE FOR ANY SPECIAL, DIRECT, INDIRECT, OR CONSEQUENTIAL DAMAGES OR ANY DAMAGES WHATSOEVER ARISING OUT OF OR IN CONNECTION WITH THE USE OR PERFORMANCE OF THIS SOFTWARE, EVEN IF IBM IS APPRISED OF THE POSSIBILITY OF SUCH DAMAGES.

## **2.4 BSD 3-clause "New" or "Revised" License**

Copyright/Copyright holders – see List of Open Source Components



All rights reserved.

Redistribution and use in source and binary forms, with or without modification, are permitted provided that the following conditions are met:

Redistributions of source code must retain the above copyright notice, this list of conditions and the following disclaimer. Redistributions in binary form must reproduce the above copyright notice, this list of conditions and the following disclaimer in the documentation and/or other materials provided with the distribution. Neither the name of the [ORGANIZATION] nor the names of its contributors may be used to endorse or promote products derived from this software without specific prior written permission.

THIS SOFTWARE IS PROVIDED BY THE COPYRIGHT HOLDERS AND CONTRIBUTORS "AS IS" AND ANY EXPRESS OR IMPLIED WARRANTIES, INCLUDING, BUT NOT LIMITED TO, THE IMPLIED WARRANTIES OF MERCHANTABILITY AND FITNESS FOR A PARTICULAR PURPOSE ARE DISCLAIMED. IN NO EVENT SHALL THE COPYRIGHT OWNER OR CONTRIBUTORS BE LIABLE FOR ANY DIRECT, INDIRECT, INCIDENTAL, SPECIAL, EXEMPLARY, OR CONSEQUENTIAL DAMAGES (INCLUDING, BUT NOT LIMITED TO, PROCUREMENT OF SUBSTITUTE GOODS OR SERVICES; LOSS OF USE, DATA, OR PROFITS; OR BUSINESS INTERRUPTION) HOWEVER CAUSED AND ON ANY THEORY OF LIABILITY, WHETHER IN CONTRACT, STRICT LIABILITY, OR TORT (INCLUDING NEGLIGENCE OR OTHERWISE) ARISING IN ANY WAY OUT OF THE USE OF THIS SOFTWARE, EVEN IF ADVISED OF THE POSSIBILITY OF SUCH DAMAGE.

#### **2.5 BSD 4-clause "Original" or "Old" License**

Copyright/Copyright holders – see List of Open Source Components

All rights reserved.

Redistribution and use in source and binary forms, with or without modification, are permitted provided that the following conditions are met:

1. Redistributions of source code must retain the above copyright notice, this list of conditions and the following disclaimer.
2. Redistributions in binary form must reproduce the above copyright notice, this list of conditions and the following disclaimer in the documentation and/or other materials provided with the distribution.
3. All advertising materials mentioning features or use of this software must display the following acknowledgement: This product includes software developed by the organization.
4. Neither the name of the organization nor the names of its contributors may be used to endorse or promote products derived from this software without specific prior written permission.

THIS SOFTWARE IS PROVIDED BY COPYRIGHT HOLDER "AS IS" AND ANY EXPRESS OR IMPLIED WARRANTIES, INCLUDING, BUT NOT LIMITED TO, THE IMPLIED WARRANTIES OF MERCHANTABILITY AND FITNESS FOR A PARTICULAR PURPOSE ARE DISCLAIMED. IN NO EVENT SHALL {{COPYRIGHT HOLDER}} BE LIABLE FOR ANY DIRECT, INDIRECT, INCIDENTAL, SPECIAL, EXEMPLARY, OR CONSEQUENTIAL DAMAGES (INCLUDING, BUT NOT LIMITED TO, PROCUREMENT OF SUBSTITUTE GOODS OR SERVICES; LOSS OF USE, DATA, OR PROFITS; OR BUSINESS INTERRUPTION) HOWEVER CAUSED AND ON ANY THEORY OF LIABILITY, WHETHER IN CONTRACT, STRICT LIABILITY, OR TORT (INCLUDING NEGLIGENCE OR OTHERWISE) ARISING IN ANY WAY OUT OF THE USE OF THIS SOFTWARE, EVEN IF ADVISED OF THE POSSIBILITY OF SUCH DAMAGE.

#### **2.6 BSD-4-Clause (University of California-Specific)**

BSD-4-Clause (University of California-Specific)

Copyright/Copyright holders – see List of Open Source Components

Redistribution and use in source and binary forms, with or without modification, are permitted provided that the following conditions are met:

1. Redistributions of source code must retain the above copyright notice, this list of conditions and the following disclaimer.
2. Redistributions in binary form must reproduce the above copyright notice, this list of conditions and the following disclaimer in the documentation and/or other materials provided with the distribution.
3. All advertising materials mentioning features or use of this software must display the following acknowledgement: This product includes software developed by the University of California, Berkeley and its contributors.
4. Neither the name of the University nor the names of its contributors may be used to endorse or promote products derived from this software without specific prior written permission.

THIS SOFTWARE IS PROVIDED BY THE REGENTS AND CONTRIBUTORS "AS IS" AND ANY EXPRESS OR IMPLIED WARRANTIES, INCLUDING, BUT NOT LIMITED TO, THE IMPLIED WARRANTIES OF MERCHANTABILITY AND FITNESS FOR A PARTICULAR PURPOSE ARE DISCLAIMED. IN NO EVENT SHALL THE REGENTS OR CONTRIBUTORS BE LIABLE FOR ANY DIRECT, INDIRECT, INCIDENTAL, SPECIAL, EXEMPLARY, OR CONSEQUENTIAL DAMAGES (INCLUDING, BUT NOT LIMITED TO, PROCUREMENT OF SUBSTITUTE GOODS OR SERVICES; LOSS OF USE, DATA, OR PROFITS; OR BUSINESS INTERRUPTION) HOWEVER CAUSED AND ON ANY THEORY OF LIABILITY, WHETHER IN CONTRACT, STRICT LIABILITY, OR TORT (INCLUDING NEGLIGENCE OR OTHERWISE) ARISING IN ANY WAY OUT OF THE USE OF THIS SOFTWARE, EVEN IF ADVISED OF THE POSSIBILITY OF SUCH DAMAGE.

## 2.7 Freetype Project License

The FreeType Project LICENSE

2006-Jan-27

Copyright 1996-2002, 2006 by David Turner, Robert Wilhelm, and Werner Lemberg

### Introduction

The FreeType Project is distributed in several archive packages; some of them may contain, in addition to the FreeType font engine, various tools and contributions which rely on, or relate to, the FreeType Project. This license applies to all files found in such packages, and which do not fall under their own explicit license. The license affects thus the FreeType font engine, the test programs, documentation and makefiles, at the very least. This license was inspired by the BSD, Artistic, and IJG (Independent JPEG Group) licenses, which all encourage inclusion and use of free software in commercial and freeware products alike. As a consequence, its main points are that:

We don't promise that this software works. However, we will be interested in any kind of bug reports. ('as is' distribution)

You can use this software for whatever you want, in parts or full form, without having to pay us. ('royalty-free' usage)

You may not pretend that you wrote this software. If you use it, or only parts of it, in a program, you must acknowledge somewhere in your documentation that you have used the FreeType code. ('credits')

We specifically permit and encourage the inclusion of this software, with or without modifications, in commercial products. We disclaim all warranties covering The FreeType Project and assume no liability related to The FreeType Project. Finally, many people asked us for a preferred form for a credit/disclaimer to use in compliance with this license. We thus encourage you to use the following text: "Portions of this software are copyright © 1996-2002, 2006 The FreeType Project ([www.freetype.org](http://www.freetype.org)). All rights reserved."

### Definitions

Throughout this license, the terms 'package', 'FreeType Project', and 'FreeType archive' refer to the set of files originally distributed by the authors (David Turner, Robert Wilhelm, and Werner Lemberg) as the 'FreeType Project', be they named as alpha, beta or final release. 'You' refers to the licensee, or person using the project, where 'using' is a generic term including compiling the project's source code as well as linking it to form a 'program' or 'executable'. This program is referred to as 'a program using the FreeType engine'. This license applies to all files distributed in the original FreeType Project, including all source code, binaries and documentation, unless otherwise stated in the file in its original, unmodified form as distributed in the original archive. If you are unsure whether or not a particular file is covered by this license, you must contact us to verify this.

### **No Warranty**

THE FREETYPE PROJECT IS PROVIDED 'AS IS' WITHOUT WARRANTY OF ANY KIND, EITHER EXPRESS OR IMPLIED, INCLUDING, BUT NOT LIMITED TO, WARRANTIES OF MERCHANTABILITY AND FITNESS FOR A PARTICULAR PURPOSE. IN NO EVENT WILL ANY OF THE AUTHORS OR COPYRIGHT HOLDERS BE LIABLE FOR ANY DAMAGES CAUSED BY THE USE OR THE INABILITY TO USE, OF THE FREETYPE PROJECT. Redistribution

### **Redistribution**

This license grants a worldwide, royalty-free, perpetual and irrevocable right and license to use, execute, perform, compile, display, copy, create derivative works of, distribute and sublicense the FreeType Project (in both source and object code forms) and derivative works thereof for any purpose; and to authorize others to exercise some or all of the rights granted herein, subject to the following conditions:

Redistribution of source code must retain this license file ('FTL.TXT') unaltered; any additions, deletions or changes to the original files must be clearly indicated in accompanying documentation. The copyright notices of the unaltered, original files must be preserved in all copies of source files. Redistribution in binary form must provide a disclaimer that states that the software is based in part of the work of the FreeType Team, in the distribution documentation. We also encourage you to put an URL to the FreeType web page in your documentation, though this isn't mandatory. These conditions apply to any software derived from or based on the FreeType Project, not just the unmodified files. If you use our work, you must acknowledge us. However, no fee need be paid to us.

### **Advertising**

Neither the FreeType authors and contributors nor you shall use the name of the other for commercial, advertising, or promotional purposes without specific prior written permission. We suggest, but do not require, that you use one or more of the following phrases to refer to this software in your documentation or advertising materials: 'FreeType Project', 'FreeType Engine', 'FreeType library', or 'FreeType Distribution'. As you have not signed this license, you are not required to accept it. However, as the FreeType Project is copyrighted material, only this license, or another one contracted with the authors, grants you the right to use, distribute, and modify it. Therefore, by using, distributing, or modifying the FreeType Project, you indicate that you understand and accept all the terms of this license.

### **Contacts**

There are two mailing lists related to FreeType:

`freetype@nongnu.org`

Discusses general use and applications of FreeType, as well as future and wanted additions to the library and distribution. If you are looking for support, start in this list if you haven't found anything to help you in the documentation.

`devel@nongnu.org`

Discusses bugs, as well as engine internals, design issues, specific licenses, porting, etc.

Our home page can be found at: <http://www.freetype.org>

## 2.8 Independent JPEG Group License

The Independent JPEG Group's JPEG software README for release 6b of 27-Mar-1998

This distribution contains the sixth public release of the Independent JPEG Group's free JPEG software. You are welcome to re-distribute this software and to use it for any purpose, subject to the conditions under LEGAL ISSUES, below. Serious users of this software (particularly those incorporating it into larger programs) should contact IJG at jpeg-info@uunet.uu.net to be added to our electronic mailing list. Mailing list members are notified of updates and have a chance to participate in technical discussions, etc. This software is the work of Tom Lane, Philip Gladstone, Jim Boucher, Lee Crocker, Julian Minguillon, Luis Ortiz, George Phillips, Davide Rossi, Guido Vollbeding, Ge' Weijers, and other members of the Independent JPEG Group. IJG is not affiliated with the official ISO JPEG standards committee.

### LEGAL ISSUES

In plain English:

We don't promise that this software works. (But if you find any bugs, please let us know!) You can use this software for whatever you want. You don't have to pay us. You may not pretend that you wrote this software. If you use it in a program, you must acknowledge somewhere in your documentation that you've used the IJG code.

In legalese:

The authors make NO WARRANTY or representation, either express or implied, with respect to this software, its quality, accuracy, merchantability, or fitness for a particular purpose. This software is provided "AS IS", and you, its user, assume the entire risk as to its quality and accuracy. This software is copyright (C) 1991-1998, Thomas G. Lane. All Rights Reserved except as specified below.

Permission is hereby granted to use, copy, modify, and distribute this software (or portions thereof) for any purpose, without fee, subject to these conditions:

1. If any part of the source code for this software is distributed, then this README file must be included, with this copyright and no-warranty notice unaltered; and any additions, deletions, or changes to the original files must be clearly indicated in accompanying documentation.
2. If only executable code is distributed, then the accompanying documentation must state that "this software is based in part on the work of the Independent JPEG Group".
3. Permission for use of this software is granted only if the user accepts full responsibility for any undesirable consequences; the authors accept NO LIABILITY for damages of any kind.

These conditions apply to any software derived from or based on the IJG code, not just to the unmodified library. If you use our work, you ought to acknowledge us.

Permission is NOT granted for the use of any IJG author's name or company name in advertising or publicity relating to this software or products derived from it. This software may be referred to only as "the Independent JPEG Group's software".

We specifically permit and encourage the use of this software as the basis of commercial products, provided that all warranty or liability claims are assumed by the product vendor. ansi2knr.c is included in this distribution by permission of L. Peter Deutsch, sole proprietor of its copyright holder, Aladdin Enterprises of Menlo Park, CA. ansi2knr.c is NOT covered by the above copyright and conditions, but instead by the usual distribution terms of the Free Software Foundation; principally, that you must include source code if you redistribute it. (See the file ansi2knr.c for full details.)

However, since ansi2knr.c is not needed as part of any program generated from the IJG code, this does not limit you more than the foregoing paragraphs do. The Unix configuration script "configure" was produced with GNU Autoconf. It is copyright by the Free Software Foundation but is freely distributable. The same holds for its supporting scripts (config.guess, config.sub, ltconfig, ltmain.sh). Another support script, install-sh, is copyright by M.I.T. but is also freely distributable.

**The content of this manual represents the status of the user manual at the time of printing and may not be completely valid in future instances. For more information refer to the first page for the complete disclaimer note.**

It appears that the arithmetic coding option of the JPEG spec is covered by patents owned by IBM, AT&T, and Mitsubishi. Hence arithmetic coding cannot legally be used without obtaining one or more licenses. For this reason, support for arithmetic coding has been removed from the free JPEG software. (Since arithmetic coding provides only a marginal gain over the unpatented Huffman mode, it is unlikely that very many implementations will support it.) So far as we are aware, there are no patent restrictions on the remaining code.

The JG distribution formerly included code to read and write GIF files. To avoid entanglement with the Unisys LZW patent, GIF reading support has been removed altogether, and the GIF writer has been simplified to produce "uncompressed GIFs". This technique does not use the LZW algorithm; the resulting GIF files are larger than usual, but are readable by all standard GIF decoders. We are required to state that:

"The Graphics Interchange Format(c) is the Copyright property of CompuServe Incorporated. GIF(sm) is a Service Mark property of CompuServe Incorporated."

## **2.9 Internet Software Consortium-IBM License**

Copyright (c) 1996 by Internet Software Consortium.

Permission to use, copy, modify, and distribute this software for any purpose with or without fee is hereby granted, provided that the above copyright notice and this permission notice appear in all copies.

THE SOFTWARE IS PROVIDED "AS IS" AND INTERNET SOFTWARE CONSORTIUM DISCLAIMS ALL WARRANTIES WITH REGARD TO THIS SOFTWARE INCLUDING ALL IMPLIED WARRANTIES OF MERCHANTABILITY AND FITNESS. IN NO EVENT SHALL INTERNET SOFTWARE CONSORTIUM BE LIABLE FOR ANY SPECIAL, DIRECT, INDIRECT, OR CONSEQUENTIAL DAMAGES OR ANY DAMAGES WHATSOEVER RESULTING FROM LOSS OF USE, DATA OR PROFITS, WHETHER IN AN ACTION OF CONTRACT, NEGLIGENCE OR OTHER TORTIOUS ACTION, ARISING OUT OF OR IN CONNECTION WITH THE USE OR PERFORMANCE OF THIS SOFTWARE.

Portions Copyright (c) 1995 by International Business Machines, Inc.

International Business Machines, Inc. (hereinafter called IBM) grants permission under its copyrights to use, copy, modify, and distribute this Software with or without fee, provided that the above copyright notice and all paragraphs of this notice appear in all copies, and that the name of IBM not be used in connection with the marketing of any product incorporating the Software or modifications thereof, without specific, written prior permission.

To the extent it has a right to do so, IBM grants an immunity from suit under its patents, if any, for the use, sale or manufacture of products to the extent that such products are used for performing Domain Name System dynamic updates in TCP/IP networks by means of the Software. No immunity is granted for any product per se or for any other function of any product.

THE SOFTWARE IS PROVIDED "AS IS", AND IBM DISCLAIMS ALL WARRANTIES, INCLUDING ALL IMPLIED WARRANTIES OF MERCHANTABILITY AND FITNESS FOR A PARTICULAR PURPOSE. IN NO EVENT SHALL IBM BE LIABLE FOR ANY SPECIAL, DIRECT, INDIRECT, OR CONSEQUENTIAL DAMAGES OR ANY DAMAGES WHATSOEVER ARISING OUT OF OR IN CONNECTION WITH THE USE OR PERFORMANCE OF THIS SOFTWARE, EVEN IF IBM IS APPRISED OF THE POSSIBILITY OF SUCH DAMAGES.

## **2.10 Khronos License**

Copyright (c) 2013 The Khronos Group Inc.

\*\* \*\* Permission is hereby granted, free of charge, to any person obtaining a \*\* copy of this software and/or associated documentation files (the \*\* "Materials"), to deal in the Materials without restriction, including \*\* without limitation the rights to use, copy, modify, merge, publish, \*\* distribute, sublicense, and/or sell copies of the Materials, and to \*\* permit persons to whom the Materials are furnished to do so, subject to \*\* the following conditions: \*\* \*\* The above copyright notice and this permission notice shall be included \*\* in all copies or substantial portions of the Materials. \*\*

\*\* THE MATERIALS ARE PROVIDED "AS IS", WITHOUT WARRANTY OF ANY KIND, \*\* EXPRESS OR IMPLIED, INCLUDING BUT NOT LIMITED TO THE WARRANTIES OF \*\* MERCHANTABILITY, FITNESS FOR A PARTICULAR PURPOSE AND NONINFRINGEMENT. \*\* IN NO EVENT SHALL THE AUTHORS OR COPYRIGHT HOLDERS BE LIABLE FOR ANY \*\* CLAIM, DAMAGES OR OTHER LIABILITY, WHETHER IN AN ACTION OF CONTRACT, \*\* TORT OR OTHERWISE, ARISING FROM, OUT OF OR IN CONNECTION WITH THE \*\* MATERIALS OR THE USE OR OTHER DEALINGS IN THE MATERIALS.

### **2.11 License of Stephan Brumme/ Zlib style License**

This software is provided 'as-is', without any express or implied warranty. In no event will the author be held liable for any damages arising from the use of this software. Permission is granted to anyone to use this software for any purpose, including commercial applications, and to alter it and redistribute it freely, subject to the following restrictions: The origin of this software must not be misrepresented; you must not claim that you wrote the original software. If you use this software in a product, an acknowledgment in the product documentation would be appreciated but is not required. Altered source versions must be plainly marked as such, and must not be misrepresented as being the original software.

### **2.12 MIT License**

The MIT License

Copyright/Copyright holders – see List of Open Source Components

Permission is hereby granted, free of charge, to any person obtaining a copy of this software and associated documentation files (the "Software"), to deal in the Software without restriction, including without limitation the rights to use, copy, modify, merge, publish, distribute, sublicense, and/or sell copies of the Software, and to permit persons to whom the Software is furnished to do so, subject to the following conditions:

The above copyright notice and this permission notice shall be included in all copies or substantial portions of the Software.

THE SOFTWARE IS PROVIDED "AS IS", WITHOUT WARRANTY OF ANY KIND, EXPRESS OR IMPLIED, INCLUDING BUT NOT LIMITED TO THE WARRANTIES OF MERCHANTABILITY, FITNESS FOR A PARTICULAR PURPOSE AND NONINFRINGEMENT. IN NO EVENT SHALL THE AUTHORS OR COPYRIGHT HOLDERS BE LIABLE FOR ANY CLAIM, DAMAGES OR OTHER LIABILITY, WHETHER IN AN ACTION OF CONTRACT, TORT OR OTHERWISE, ARISING FROM, OUT OF OR IN CONNECTION WITH THE SOFTWARE OR THE USE OR OTHER DEALINGS IN THE SOFTWARE.

### **2.13 Open Group License**

Copyright 1996, 1998 The Open Group.

Permission to use, copy, modify, distribute, and sell this software and its documentation for any purpose is hereby granted without fee, provided that the above copyright notice appear in all copies and that both that copyright notice and this permission notice appear in supporting documentation. The above copyright notice and this permission notice shall be included in all copies or substantial portions of the Software.

THE SOFTWARE IS PROVIDED "AS IS", WITHOUT WARRANTY OF ANY KIND, EXPRESS OR IMPLIED, INCLUDING BUT NOT LIMITED TO THE WARRANTIES OF MERCHANTABILITY, FITNESS FOR A PARTICULAR PURPOSE AND NONINFRINGEMENT. IN NO EVENT SHALL THE OPEN GROUP BE LIABLE FOR ANY CLAIM, DAMAGES OR OTHER LIABILITY, WHETHER IN AN ACTION OF CONTRACT, TORT OR OTHERWISE, ARISING FROM, OUT OF OR IN CONNECTION WITH THE SOFTWARE OR THE USE OR OTHER DEALINGS IN THE SOFTWARE.

Except as contained in this notice, the name of The Open Group shall not be used in advertising or otherwise to promote the sale, use or other dealings in this Software without prior written authorization from The Open Group.

### **2.14 Public Domain**

Public domain code is not subject to any license.

**The content of this manual represents the status of the user manual at the time of printing and may not be completely valid in future instances. For more information refer to the first page for the complete disclaimer note.**

## 2.15 BSD One Clause License

BSD One Clause License

Copyright/Copyright holders – see List of Open Source Components

All rights reserved.

Redistribution and use in source and binary forms, with or without modification, are permitted provided that the following conditions are met:

\* Redistributions of source code must retain the above copyright notice, this list of conditions and the following disclaimer.

THIS SOFTWARE IS PROVIDED BY THE COPYRIGHT HOLDERS AND CONTRIBUTORS "AS IS" AND ANY EXPRESS OR IMPLIED WARRANTIES, INCLUDING, BUT NOT LIMITED TO, THE IMPLIED WARRANTIES OF MERCHANTABILITY AND FITNESS FOR A PARTICULAR PURPOSE ARE DISCLAIMED. IN NO EVENT SHALL THE COPYRIGHT OWNER OR CONTRIBUTORS BE LIABLE FOR ANY DIRECT, INDIRECT, INCIDENTAL, SPECIAL, EXEMPLARY, OR CONSEQUENTIAL DAMAGES (INCLUDING, BUT NOT LIMITED TO, PROCUREMENT OF SUBSTITUTE GOODS OR SERVICES; LOSS OF USE, DATA, OR PROFITS; OR BUSINESS INTERRUPTION) HOWEVER CAUSED AND ON ANY THEORY OF LIABILITY, WHETHER IN CONTRACT, STRICT LIABILITY, OR TORT (INCLUDING NEGLIGENCE OR OTHERWISE) ARISING IN ANY WAY OUT OF THE USE OF THIS SOFTWARE, EVEN IF ADVISED OF THE POSSIBILITY OF SUCH DAMAGE.

## 2.16 ISC License

ISC License (ISCL)

Copyright/Copyright holders – see List of Open Source Components

Permission to use, copy, modify, and/or distribute this software for any purpose with or without fee is hereby granted, provided that the above copyright notice and this permission notice appear in all copies.

THE SOFTWARE IS PROVIDED "AS IS" AND THE AUTHOR DISCLAIMS ALL WARRANTIES WITH REGARD TO THIS SOFTWARE INCLUDING ALL IMPLIED WARRANTIES OF MERCHANTABILITY AND FITNESS. IN NO EVENT SHALL THE AUTHOR BE LIABLE FOR ANY SPECIAL, DIRECT, INDIRECT, OR CONSEQUENTIAL DAMAGES OR ANY DAMAGES WHATSOEVER RESULTING FROM LOSS OF USE, DATA OR PROFITS, WHETHER IN AN ACTION OF CONTRACT, NEGLIGENCE OR OTHER TORTIOUS ACTION, ARISING OUT OF OR IN CONNECTION WITH THE USE OR PERFORMANCE OF THIS SOFTWARE.

## 2.17 SGI Free Software License B v2.0

ISC License (ISCL)

Copyright/Copyright holders – see List of Open Source Components

Permission is hereby granted, free of charge, to any person obtaining a copy of this software and associated documentation files (the "Software"), to deal in the Software without restriction, including without limitation the rights to use, copy, modify, merge, publish, distribute, sublicense, and/or sell copies of the Software, and to permit persons to whom the Software is furnished to do so, subject to the following conditions:

The above copyright notice including the dates of first publication and either this permission notice or a reference to <http://oss.sgi.com/projects/FreeB/> shall be included in all copies or substantial portions of the Software.

THE SOFTWARE IS PROVIDED "AS IS" AND THE AUTHOR DISCLAIMS ALL WARRANTIES WITH REGARD TO THIS SOFTWARE INCLUDING ALL IMPLIED WARRANTIES OF MERCHANTABILITY AND FITNESS. IN NO EVENT SHALL THE AUTHOR BE LIABLE FOR ANY SPECIAL, DIRECT, INDIRECT, OR CONSEQUENTIAL DAMAGES OR ANY DAMAGES

WHATSOEVER RESULTING FROM LOSS OF USE, DATA OR PROFITS, WHETHER IN AN ACTION OF CONTRACT, NEGLIGENCE OR OTHER TORTIOUS ACTION, ARISING OUT OF OR IN CONNECTION WITH THE USE OR PERFORMANCE OF THIS SOFTWARE.

Except as contained in this notice, the name of Silicon Graphics, Inc. shall not be used in advertising or otherwise to promote the sale, use or other dealings in this Software without prior written authorization from Silicon Graphics, Inc.

## **2.18 Unicode Terms of Use**

For the general privacy policy governing access to this site, see the Unicode Privacy Policy. For trademark usage, see the Unicode® Consortium Name and Trademark Usage Policy.

### **A. Unicode Copyright.**

1. Copyright © 1991-2014 Unicode, Inc. All rights reserved.
2. Certain documents and files on this website contain a legend indicating that "Modification is permitted." Any person is hereby authorized, without fee, to modify such documents and files to create derivative works conforming to the Unicode® Standard, subject to Terms and Conditions herein.
3. Any person is hereby authorized, without fee, to view, use, reproduce, and distribute all documents and files solely for informational purposes in the creation of products supporting the Unicode Standard, subject to the Terms and Conditions herein.
4. Further specifications of rights and restrictions pertaining to the use of the particular set of data files known as the "Unicode Character Database" can be found in Exhibit 1.
5. Each version of the Unicode Standard has further specifications of rights and restrictions of use. For the book editions (Unicode 5.0 and earlier), these are found on the back of the title page. The online code charts carry specific restrictions. All other files, including online documentation of the core specification for Unicode 6.0 and later, are covered under these general Terms of Use.
6. No license is granted to "mirror" the Unicode website where a fee is charged for access to the "mirror" site.
7. Modification is not permitted with respect to this document. All copies of this document must be verbatim.

### **B. Restricted Rights Legend.**

Any technical data or software which is licensed to the United States of America, its agencies and/or instrumentalities under this Agreement is commercial technical data or commercial computer software developed exclusively at private expense as defined in FAR 2.101, or DFARS 252.227-7014 (June 1995), as applicable. For technical data, use, duplication, or disclosure by the Government is subject to restrictions as set forth in DFARS 202.227-7015 Technical Data, Commercial and Items (Nov 1995) and this Agreement. For Software, in accordance with FAR 12-212 or DFARS 227-7202, as applicable, use, duplication or disclosure by the Government is subject to the restrictions set forth in this Agreement.

### **C. Warranties and Disclaimers.**

1. This publication and/or website may include technical or typographical errors or other inaccuracies. Changes are periodically added to the information herein; these changes will be incorporated in new editions of the publication and/or website. Unicode may make improvements and/or changes in the product(s) and/or program(s) described in this publication and/or website at any time.
2. If this file has been purchased on magnetic or optical media from Unicode, Inc. the sole and exclusive remedy for any claim will be exchange of the defective media within ninety (90) days of original purchase.
3. EXCEPT AS PROVIDED IN SECTION C.2, THIS PUBLICATION AND/OR SOFTWARE IS PROVIDED "AS IS" WITHOUT WARRANTY OF ANY KIND EITHER EXPRESS, IMPLIED, OR STATUTORY, INCLUDING, BUT NOT LIMITED TO, ANY WARRANTIES OF MERCHANTABILITY, FITNESS FOR A PARTICULAR PURPOSE, OR NON-INFRINGEMENT. UNICODE

The content of this manual represents the status of the user manual at the time of printing and may not be completely valid in future instances. For more information refer to the first page for the complete disclaimer note.



AND ITS LICENSORS ASSUME NO RESPONSIBILITY FOR ERRORS OR OMISSIONS IN THIS PUBLICATION AND/OR SOFTWARE OR OTHER DOCUMENTS WHICH ARE REFERENCED BY OR LINKED TO THIS PUBLICATION OR THE UNICODE WEBSITE.

#### **D. Waiver of Damages.**

In no event shall Unicode or its licensors be liable for any special, incidental, indirect or consequential damages of any kind, or any damages whatsoever, whether or not Unicode was advised of the possibility of the damage, including, without limitation, those resulting from the following: loss of use, data or profits, in connection with the use, modification or distribution of this information or its derivatives.

#### **E. Trademarks & Logos.**

1. The Unicode Word Mark and the Unicode Logo are trademarks of Unicode, Inc. "The Unicode Consortium" and "Unicode, Inc." are trade names of Unicode, Inc. Use of the information and materials found on this website indicates your acknowledgement of Unicode, Inc.'s exclusive worldwide rights in the Unicode Word Mark, the Unicode Logo, and the Unicode trade names.
2. The Unicode Consortium Name and Trademark Usage Policy ("Trademark Policy") are incorporated herein by reference and you agree to abide by the provisions of the Trademark Policy, which may be changed from time to time in the sole discretion of Unicode, Inc.
3. All third party trademarks referenced herein are the property of their respective owners.

#### **F. Miscellaneous.**

1. Jurisdiction and Venue. This server is operated from a location in the State of California, United States of America. Unicode makes no representation that the materials are appropriate for use in other locations. If you access this server from other locations, you are responsible for compliance with local laws. This Agreement, all use of this site and any claims and damages resulting from use of this site are governed solely by the laws of the State of California without regard to any principles which would apply the laws of a different jurisdiction. The user agrees that any disputes regarding this site shall be resolved solely in the courts located in Santa Clara County, California. The user agrees said courts have personal jurisdiction and agree to waive any right to transfer the dispute to any other forum.
2. Modification by Unicode. Unicode shall have the right to modify this Agreement at any time by posting it to this site. The user may not assign any part of this Agreement without Unicode's prior written consent.
3. Taxes. The user agrees to pay any taxes arising from access to this website or use of the information herein, except for those based on Unicode's net income.
4. Severability. If any provision of this Agreement is declared invalid or unenforceable, the remaining provisions of this Agreement shall remain in effect.
5. Entire Agreement. This Agreement constitutes the entire agreement between the parties.

#### **2.19 libpng License**

This copy of the libpng notices is provided for your convenience. In case of any discrepancy between this copy and the notices in the file png.h that is included in the libpng distribution, the latter shall prevail.

COPYRIGHT NOTICE, DISCLAIMER, and LICENSE:

The above copyright notice and this permission notice shall be included in all copies or substantial portions of the Software.

If you modify libpng you may insert additional notices immediately following this sentence. libpng versions 1.0.7, July 1, 2000, through 1.0.13, April 15, 2002, are Copyright (c) 2000-2002 Glenn Randers-Pehrson and are distributed according to the same disclaimer and license as libpng-1.0.6 with the following individuals added to the list of Contributing Authors:

**The content of this manual represents the status of the user manual at the time of printing and may not be completely valid in future instances. For more information refer to the first page for the complete disclaimer note.**

Simon-Pierre Cadieux, Eric S. Raymond, Gilles Vollant

and with the following additions to the disclaimer:

There is no warranty against interference with your enjoyment of the library or against infringement. There is no warranty that our efforts or the library will fulfill any of your particular purposes or needs. This library is provided with all faults, and the entire risk of satisfactory quality, performance, accuracy, and effort is with the user.

libpng versions 0.97, January 1998, through 1.0.6, March 20, 2000, are Copyright (c) 1998, 1999 Glenn Randers-Pehrson, and are distributed according to the same disclaimer and license as libpng-0.96, with the following individuals added to the list of Contributing Authors:

Tom Lane, Glenn Randers-Pehrson, Willem van Schaik.

libpng versions 0.89, June 1996, through 0.96, May 1997, are Copyright (c) 1996, 1997 Andreas Dilger Distributed according to the same disclaimer and license as libpng-0.88, with the following individuals added to the list of Contributing Authors:

John Bowler, Kevin Bracey, Sam Bushe, Magnus Holmgren, Greg Roelofs, Tom Tanner.

libpng versions 0.5, May 1995, through 0.88, January 1996, are Copyright (c) 1995, 1996 Guy Eric Schalnat, Group 42, Inc. For the purposes of this copyright and license, "Contributing Authors" is defined as the following set of individuals:

Andreas Dilger, Dave Martindale, Guy Eric Schalnat, Paul Schmidt, Tim Wegner.

The PNG Reference Library is supplied "AS IS". The Contributing Authors and Group 42, Inc. disclaim all warranties, expressed or implied, including, without limitation, the warranties of merchantability and of fitness for any purpose. The Contributing Authors and Group 42, Inc. assume no liability for direct, indirect, incidental, special, exemplary, or consequential damages, which may result from the use of the PNG Reference Library, even if advised of the possibility of such damage. Permission is hereby granted to use, copy, modify, and distribute this source code, or portions hereof, for any purpose, without fee, subject to the following restrictions:

1. The origin of this source code must not be misrepresented.
2. Altered versions must be plainly marked as such and must not be misrepresented as being the original source.
3. This Copyright notice may not be removed or altered from any source or altered source distribution.

The Contributing Authors and Group 42, Inc. specifically permit, without fee, and encourage the use of this source code as a component to supporting the PNG file format in commercial products. If you use this source code in a product, acknowledgment is not required but would be appreciated. A "png\_get\_copyright" function is available, for convenient use in "about" boxes and the like:

```
printf("%s",png_get_copyright(NULL));
```

Also, the PNG logo (in PNG format, of course) is supplied in the files "pngbar.png" and "pngbar.jpg (88x31) and "pngnow.png" (98x31).

Libpng is OSI Certified Open Source Software. OSI Certified Open Source is a certification mark of the Open Source Initiative.

Glenn Randers-Pehrson

randeg@alum.rpi.edu

April 15, 2002

## 2.20 zlib License

Copyright/Copyright holders – see List of Open Source Components

**The content of this manual represents the status of the user manual at the time of printing and may not be completely valid in future instances. For more information refer to the first page for the complete disclaimer note.**

This software is provided 'as-is', without any express or implied warranty. In no event will the authors be held liable for any damages arising from the use of this software.

Permission is granted to anyone to use this software for any purpose, including commercial applications, and to alter it and re-distribute it freely, subject to the following restrictions:

1. The origin of this software must not be misrepresented; you must not claim that you wrote the original software. If you use this software in a product, an acknowledgment in the product documentation would be appreciated but is not required.
2. Altered source versions must be plainly marked as such, and must not be misrepresented as being the original software.
3. This notice may not be removed or altered from any source distribution.

---

### 2.3.3. Type approval for HomeLink® \* [1]

Type approval for HomeLink® is provided below.

Country/Area	Type approval
USA and Canada	This device complies with FCC rules part 15 and Industry Canada RSS-210. Operation is subject to the following two conditions: (1) This device may not cause harmful interference, and (2) This device must accept any interference that may be received including interference that may cause undesired operation.
Europe	Gentex Corporation hereby declares that HomeLink® Model UAHL5 complies with the Radio equipment directive 2014/53/EU. Wavelengths within which the radio equipment operates: <ul style="list-style-type: none"><li>• 433.05MHz-434.79MHz &lt;10mW E.R.P.</li><li>• 868.00MHz-868.60MHz &lt;25mW E.R.P.</li><li>• 868.70MHz-868.20MHz &lt;25mW E.R.P.</li><li>• 869.40MHz-869.65MHz &lt;25mW E.R.P.</li><li>• 869.70MHz-870.00MHz &lt;25mW E.R.P.</li></ul> Certificate holder address: Gentex Corporation, 600 North Centennial Street, Zeeland MI 49464, USA

 **Warning**

The transmitter has been tested and complies with FCC and IC rules. Changes or modifications not expressly approved by the party responsible for compliance could void the user's authority to operate the device. [2]

\* Option/accessory.

[1] Certain markets only.

[2] The term "IC:" before the certification/registration number only signifies that Industry Canada technical specifications were met.

---

### 2.3.4. Type approval Radio Equipment Directive

The content of this manual represents the status of the user manual at the time of printing and may not be completely valid in future instances. For more information refer to the first page for the complete disclaimer note.



Country/Area	
US/Canada	<p>FCC ID : BEJWC510MVV20  IC : 2703H-WC510MVV20</p> <p>This device complies with part 15 of the FCC rules and with RSS-Gen,RSS-216 rules of Canada. Operation is subject to the following two conditions:  (1) This device may not cause harmful interference, and  (2) This device must accept any interference received, including interference that may cause undesired operation.</p> <p>Any changed or modifications not expressly approved by the party responsible for compliance could void the user's authority to operate this equipment.  FCC RF Radiation Exposure Statement: This equipment complies with FCC RF Radiation exposure limits set forth for an uncontrolled environment. This device and its antenna must not be co-located or operating in conjunction with any other antenna or transmitter. This equipment should be installed and operated with a minimum distance of 15cm between the radiator and your body.</p> <p>—</p> <p>IDéclaration d'avertissement ISED  Son fonctionnement est soumis aux deux conditions suivantes:  (1) Cet appareil ne doit pas provoquer d'interférences nuisibles, et  (2) Cet appareil doit accepter toute interference recue, y compris les interferences pouvant entraîner un fonctionnement indésirable.</p> <p>Les changements ou modifications non expressement approuvés par LG Vehicle Components Company pourraient annuler l'autorité de l'utilisateur à utiliser l'équipement.</p> <p>Déclaration d'exposition aux radiations RF de l'ISED: Cet équipement est conforme aux limites d'exposition aux rayonnements RF de l'ISED définies pour un environnement non contrôlé. Cet appareil et son antenne ne doivent pas être situés ou fonctionner conjointement avec une autre antenne ou un autre émetteur.</p> <p>Cet équipement doit être installé pour fonctionner avec une distance minimale de 10cm entre le radiateur et le corps de l'utilisateur final.</p>

## 2.3.6. Start and lock system type designations

The following information contains type designations for the start and lock system.

### Alarm system

USA FCC ID: MAYDA 5823(3)

This device complies with part 15 of the FCC rules. Operation is subject to the following conditions: (1) This device may not cause harmful interference, and (2) this device must accept any interference received, including interference that may cause undesired operation.

Canada IC: 4405A-DA 5823(3)

This device is subject to the following conditions: (1) This device may not cause interference, and (2) this device must accept any interference, including interference that may cause undesired operation of the device.

### Remote keys (Passive Entry \*/Passive Start)

#### USA

Volvo Standard Key FCC ID: YGOHUF8423MS

Volvo Tag ID FCC ID: YGOHUF8432MS

This device complies with part 15 of the FCC Rules. Operation is subject to the following two conditions:

(1) This device may not cause harmful interference, and (2) this device must accept any interference received, including interference that may cause undesired operation.

CAUTION: Changes or modifications not expressly approved by the party responsible for compliance could void the user's authority to operate the equipment.

#### Canada

The content of this manual represents the status of the user manual at the time of printing and may not be completely valid in future instances. For more information refer to the first page for the complete disclaimer note.

Volvo Standard Key IC: 4008C-HUF8423MS

Volvo Tag ID IC: 4008C-HUF8432MS

This device complies with part 15 of the FCC Rules and Industry Canada license-exempt RSS standard(s). Operation is subject to the following two conditions:

(1) This device may not cause harmful interference, and (2) this device must accept any interference received, including interference that may cause undesired operation.

Le présent appareil est conforme aux CNR d'Industrie Canada applicables aux appareils radio exempts de licence. L'exploitation est autorisée aux deux conditions suivantes :

(1) l'appareil ne doit pas produire de brouillage, et (2) l'utilisateur de l'appareil doit accepter tout brouillage radioélectrique subi, même si le brouillage est susceptible d'en compromettre le fonctionnement.

## Immobilizer and Passive Entry\*/Passive Start systems

USA-FCC ID: LTQVO3134

This device complies with part 15 of the FCC rules. Operation is subject to the following two conditions:

(1) This device may not cause harmful interference, and

(2) this device must accept any interference received, including interference that may cause undesired operation.

Any changes or modification not expressly approved by the party responsible for compliance could void the user's authority to operate this equipment.

Canada-IC:3659A-VO3134

This device complies with Industry Canada license-exempt RSS standards. Operation is subject to the following two conditions:

(1) This device may not cause harmful interference, and (2) this device must accept any interference received, including interference that may cause undesired operation.

\* Option/accessory.

---

## 2.3.7. Approval of terms and conditions and data collection

Messages about different terms and conditions and data collection may be shown in the center display. Data is collected, for example, in order to provide better safety, vehicle and app functions.

The first time you use your vehicle, a guide will open in the center display to help you adjust various settings. In connection with the guide, you are also prompted to give your agreement to different types of terms and conditions and the collection of information.

You may also be asked to provide your consent in other situations, such as:

- First use of apps and services
- New user profiles
- Logging out from and deleting user profiles
- Change of ownership
- Resetting settings

To access privacy settings:

- 1 Tap  in the center display.
- 2 Tap **Privacy**.
- 3 Then select **Volvo privacy settings**, **Data sharing with Google** or **Legal information from Google**.

Certain settings can only be made from a profile with administrative rights.

## 2.4. Displays and controls by the driver in a left-hand drive vehicle

The overviews show the location of the vehicle's displays and controls.

### Steering wheel and dashboard

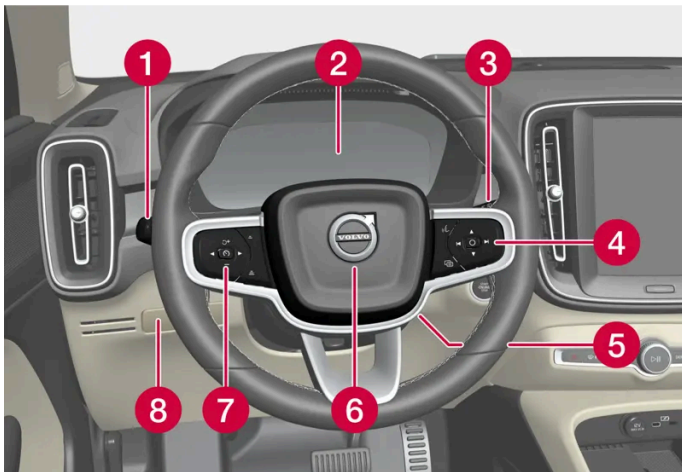

- 1 Parking lights, daytime running lights, low beams, high beams, turn signals, front fog lights/cornering illumination\*, rear fog light, trip computer reset
- 2 Instrument panel
- 3 Wipers and washers, rain sensor\*
- 4 Right-side steering wheel keypad
- 5 Steering wheel adjustment

The content of this manual represents the status of the user manual at the time of printing and may not be completely valid in future instances. For more information refer to the first page for the complete disclaimer note.

- 6 Horn
- 7 Left-side steering wheel keypad
- 8 Display lighting, unlocking/locking\*/closing\* the trunk lid/tailgate

## Ceiling console

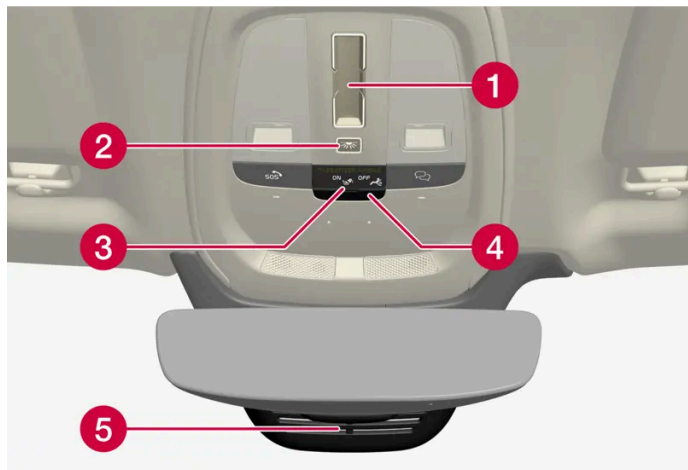

- 1 Panoramic roof\*
- 2 Front reading lights and courtesy lighting
- 3 Ceiling console display button
- 4 SIM card slot
- 5 HomeLink®\*

## Center and tunnel console

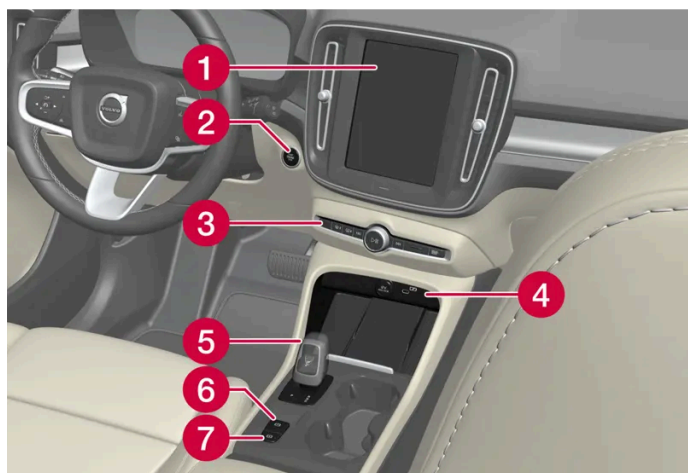

- 1 Center display
- 2 Start button
- 3 Hazard warning flashers, defrosting, media, drive mode button\*
- 4 Electrical outlet, USB port, wireless phone charger\*
- 5 Gear selector
- 6 Parking brake
- 7 Auto-hold brake when stationary

The content of this manual represents the status of the user manual at the time of printing and may not be completely valid in future instances. For more information refer to the first page for the complete disclaimer note.



## Driver's door

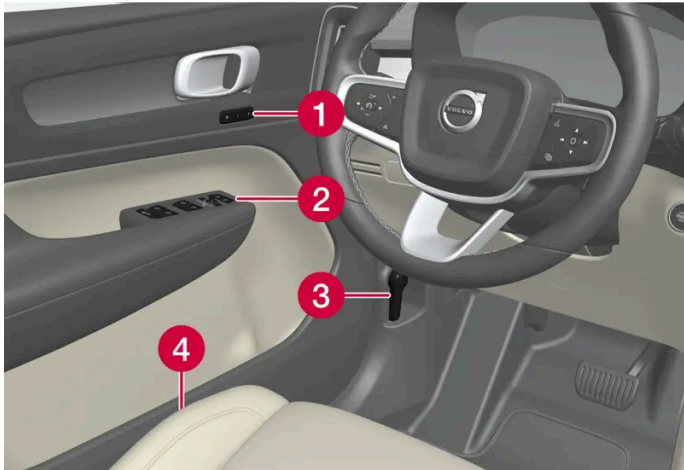

- 1 Memory for power front seat\*, door mirror settings
- 2 Central locking, power windows, door mirrors and child locks\*
- 3 Hood open
- 4 Controls for front seat

\* Option/accessory.

---

## 2.5. Technician certification

In addition to Volvo factory training, Volvo supports certification by the National Institute for Automotive Service Excellence (A.S.E.).

Certified technicians have demonstrated a high degree of competence in specific areas. Besides passing exams, each technician must also have worked in the field for two or more years before a certificate is issued. These professional technicians are best able to analyze vehicle problems and perform the necessary maintenance procedures to keep your Volvo at peak operating condition.

### Electrified vehicles

Technicians performing work on a vehicle with electrification should also have the necessary training and specialized certification required for performing repairs and/or maintenance on a vehicle with electrification.

#### **Warning**

A number of electrical components in electrified vehicles use high-voltage current and can be extremely dangerous if handled incorrectly. These components and any orange wiring in the vehicle may only be handled by trained and qualified Volvo service technicians.

## 2.6. Connecting equipment to the vehicle's data link connector

Incorrectly connected or installed software or diagnostic tools may have an adverse effect on the vehicle's electronics.

Volvo strongly recommends that Volvo owners use only genuine, Volvo-approved accessories, and that accessory installations be performed only by a trained and qualified Volvo service technician. Certain accessories only work when the associated software is installed in the vehicle's computer system.

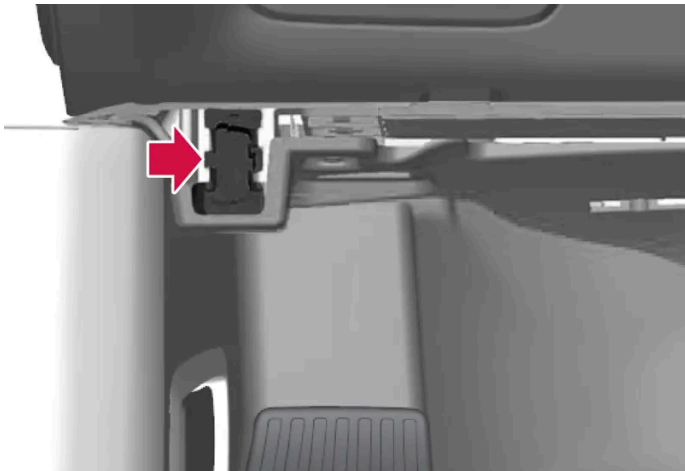

On-board Diagnostic (OBDII) socket under the dashboard on the driver's side.

### Note

Volvo Cars takes no responsibility for the consequences of connecting non-authorized equipment to the On-board Diagnostic (OBDII) socket. This socket should only be used by a trained and qualified Volvo service technician.

## Type approval

### USA

FCC ID: 2AGKKACUII-06

This device complies with part 15 of the FCC rules. Operation is subject to the following two conditions:

- (1) This device may not cause harmful interference, and
- (2) this device must accept any interference received, including interference that may cause undesired operation.

### Warning

Changes or modifications not expressly approved by the party responsible for compliance could void the user's authority to operate the equipment.

### Canada

IC: 20839-ACUII06

The content of this manual represents the status of the user manual at the time of printing and may not be completely valid in future instances. For more information refer to the first page for the complete disclaimer note.

This device complies with Industry Canada license-exempt RSS standards. Operation is subject to the following two conditions:

- (1) This device may not cause interference, and
- (2) this device must accept any interference received, including interference that may cause undesired operation.

---

## 2.7. Driver distraction

A driver has a responsibility to do everything possible to ensure his or her own safety and the safety of passengers in the vehicle and others sharing the roadway. Part of this responsibility is avoiding distractions, including performing activities that are not directly related to controlling the vehicle in the driving environment.

Your new Volvo is equipped with feature-rich entertainment and communication systems. You may also own other portable electronic devices for your own convenience. Use these systems and devices safely to avoid distraction.

For all of these systems, we want to provide the following warning that reflects the strong Volvo concern for your safety. Never use these devices or any feature of your vehicle in a way that distracts you from the task of driving safely. Distraction can lead to a serious accident. In addition to this general warning, we offer the following guidance regarding specific new features that may be found in your vehicle:

### **Warning**

- Never use a hand-held cellular telephone while driving. Some jurisdictions prohibit cellular telephone use by a driver while the vehicle is moving.
- If your vehicle is equipped with a navigation system, set and make changes to your travel itinerary only with the vehicle parked.
- Never program your audio system while the vehicle is moving. Program radio presets with the vehicle parked, and use your programmed presets to make radio use quicker and simpler.
- Never use portable computers or personal digital assistants while the vehicle is moving.

---

## 2.8. Getting started with Google services

Connect your Google account to your user profile to get started with Google services.



Being logged in with a Google account makes Google services such as the Google Assistant and Google Maps more personalized. For Google Play to open, a Google account must be connected to that user profile.

## Creating a Google account

Go to [accounts.google.com/signup](https://accounts.google.com/signup) [https://accounts.google.com/signup]. Enter your name, create or use an existing email address and password. Enter your phone number and verify the account using the code sent to the phone.

## Logging in with a Google account in the center display

- 1 Tap , then **Google** and then **Google Assistant**. Tap the profile symbol to log in.
- 2 Enter the email address connected to your Google account. Then tap **Next**.
- 3 Enter the password connected to your Google account. Then tap **Next**.

If the login problem persists, make sure the vehicle is connected to the Internet.

---

## 2.9. Change of market when importing or relocating

If you import a vehicle or move to another country, it is important that you register the vehicle in the new market to help ensure that online services work correctly, that the vehicle meets local laws and regulations,

The content of this manual represents the status of the user manual at the time of printing and may not be completely valid in future instances. For more information refer to the first page for the complete disclaimer note.

etc.

## Visit an authorized Volvo retailer

Visit an authorized Volvo retailer for assistance registering the vehicle in the new market.

If you do not do this then you may experience that apps, Volvo Assistance<sup>[1]</sup>, software downloads and other online services are affected and do not work correctly.

### Creating a new Volvo ID in your new home market

When you relocate to another country you should create a Volvo ID in the new country.

If you have already created a Volvo ID in another country and want to use the same email address, you must first delete your Volvo ID in the region you originally created it. You can also create a new Volvo ID with another email address.

### For vehicles with Volvo Assistance

Download the Volvo Cars app from the country the vehicle will be used in and link the app to your vehicle.

#### Note

Visit an authorized Volvo retailer if you have imported or relocated with your vehicle to a new country.  
Available services may vary depending on market and car model.

#### Note

If the vehicle is exported to another market, Volvo is not responsible for any adaptations to the vehicle in order to meet applicable requirements or laws in the country of import. For more information, see the Warranty and Service Records Information booklet or contact your Volvo workshop.

<sup>[1]</sup> Applicable only to markets that have access to Volvo Assistance.

---

## 2.10. Viewing the Vehicle Identification Number (VIN)

All vehicles have a unique identification number, a VIN<sup>[1]</sup>.

- 1 Tap settings  at the bottom of the center display.
- 2 Proceed to **System** and then **About**.

The VIN can also be found:

**The content of this manual represents the status of the user manual at the time of printing and may not be completely valid in future instances. For more information refer to the first page for the complete disclaimer note.**

- on the first page of the Warranty and Service Records Information booklet
- on the vehicle's registration card
- by looking at the dashboard through the vehicle's windshield.



The VIN has a similar location on all models.

[1] Vehicle Identification Number

## 2.11. Data recording

As part of Volvo's commitment to safety and quality, certain information is recorded regarding vehicle operation, functionality and incidents.

### US market only:

#### EDR

This vehicle is equipped with an "Event Data Recorder" (EDR). The main purpose of an EDR is to record, in certain crash or near crash-like situations, such as an air bag deployment or hitting a road obstacle, data that will assist in understanding how a vehicle's systems performed. The EDR is designed to record data related to vehicle dynamics and safety systems for a short period of time, typically 30 seconds or less. The EDR in this vehicle is designed to record such data as:

- How various systems in your vehicle were operating;
- Whether or not the driver and passenger safety belts were buckled/fastened;
- How far (if at all) the driver was depressing the accelerator and/or brake pedal; and,
- How fast the vehicle was traveling.

This data can help provide a better understanding of the circumstances in which crashes and injuries occur. NOTE: EDR data is recorded by your vehicle only if a non-trivial crash situation occurs; no data is recorded by the EDR under normal driving conditions and no personal data (e.g., name, gender, age, and crash location) is recorded. However, other parties, such as law enforcement, could combine the EDR data with the type of personally identifying data routinely acquired during a crash investigation.

The content of this manual represents the status of the user manual at the time of printing and may not be completely valid in future instances. For more information refer to the first page for the complete disclaimer note.

To read data recorded by an EDR, special equipment is required, and access to the vehicle or the EDR is needed. In addition to the vehicle manufacturer, other parties, such as law enforcement, that have the special equipment, can read the information if they have access to the vehicle or the EDR.

## **ASDR**

This vehicle is equipped with an Active Safety Data Recorder (ASDR). This data recorder can record information related to the usage of the car, functional errors and active safety actuations (e.g. auto brake). The information saved is used by technicians for service and maintenance to diagnose and repair possible faults that has occurred in the vehicle and to fulfil certain legal requirements. The registered data can also, in congregated form, be used for research and product development purposes to continuously improve the safety and quality of Volvo Cars. For more information contact your local Volvo retailer.

## **Canadian market only:**

## **EDR**

This vehicle is equipped with an "Event Data Recorder" (EDR). The main purpose of an EDR is to record, in certain crash or near crash-like situations, such as an air bag deployment or hitting a road obstacle, data that will assist in understanding how a vehicle's systems performed. The EDR is designed to record data related to vehicle dynamics and safety systems for a short period of time, typically 30 seconds or less. The EDR in this vehicle is designed to record such data as:

- How various systems in your vehicle were operating;
- Whether or not the driver and passenger safety belts were buckled/fastened;
- How far (if at all) the driver was depressing the accelerator and/or brake pedal; and,
- How fast the vehicle was traveling.

This data can help provide a better understanding of the circumstances in which crashes and injuries occur. NOTE: EDR data is recorded by your vehicle only if a non-trivial crash situation occurs; no data is recorded by the EDR under normal driving conditions and no personal data (e.g., name, gender, age, and crash location) is recorded. However, other parties, such as law enforcement, could combine the EDR data with the type of personally identifying data routinely acquired during a crash investigation.

To read data recorded by an EDR, special equipment is required, and access to the vehicle or the EDR is needed. In addition to the vehicle manufacturer, other parties, such as law enforcement, that have the special equipment, can read the information if they have access to the vehicle or the EDR.

In addition to the EDR, the vehicle is equipped with a number of computers that continuously control and monitor the vehicle's performance. These computers may record data during normal driving conditions, particularly if they detect a fault relating to the vehicle's operation and functionality or upon activation of the vehicle's active driver support functions (e.g. City Safety or the auto-brake function).

Some of this recorded data is required by technicians performing service and maintenance in order to diagnose and rectify any faults that may have occurred in the vehicle. The recorded information is also needed to enable Volvo to fulfill legal and other regulatory requirements. Information registered in the vehicle is stored in its computers until the vehicle is serviced or repaired. In addition to the above, the recorded information may be used in aggregated form for research and product development purposes in order to continuously improve the safety and quality of Volvo vehicles.

Volvo will not provide this information to any third parties without the vehicle owner's consent. However, national legislation and regulations may require Volvo to disclose this type of information to law enforcement or other authorities that can claim a legal right to the information. Special technical equipment, which Volvo and workshops that have entered agreements with Volvo have access to, is required to read and interpret the recorded data. Volvo is responsible for ensuring that information provided to Volvo in conjunction with service and maintenance is stored and handled securely and in compliance with applicable legal requirements. For more information, please contact a Volvo retailer.

**The content of this manual represents the status of the user manual at the time of printing and may not be completely valid in future instances. For more information refer to the first page for the complete disclaimer note.**

## TCAM

Vehicles equipped with TCAM can collect data on the vehicle's safety functions as well as other functions in the vehicle. This data is collected for product development, quality follow-up, safety work and to improve and monitor the vehicle's quality and its safety functions. Data is also collected in order to manage Volvo Cars' warranty commitments and to comply with legal requirements related to engine emission data.

---

## 2.12. Accessory installation

We strongly recommend that Volvo owners install only genuine, Volvo-approved accessories, and that accessory installations be performed only by a trained and qualified Volvo service technician. Certain functions only work when the associated software is installed in the vehicle's computer system.

- Genuine Volvo accessories are tested to ensure compatibility with the performance, safety, and emission systems in your vehicle. Additionally, a trained and qualified Volvo service technician knows where accessories may and may not be safely installed in your Volvo. In all cases, please consult a trained and qualified Volvo service technician before installing any accessory in or on your vehicle.
  - Accessories that have not been approved by Volvo may or may not be specifically tested for compatibility with your vehicle.
  - Any of your vehicle's performance and safety systems could be adversely affected if you install accessories that Volvo has not tested, or if you allow accessories to be installed by someone unfamiliar with your vehicle.
  - Damage caused by unapproved or improperly installed accessories may not be covered by your new vehicle warranty. See your Warranty and Service Records Information booklet for more warranty information. Volvo assumes no responsibility for death, injury, or expenses that may result from the installation of non-genuine accessories.
- 

## 2.13. Volvo Structural Parts Statement

Volvo is one of the leading companies for car safety.

Volvo engineers and manufactures vehicles designed to help protect vehicle occupants in the event of a collision.

Volvos are designed to absorb the impact of a collision. This energy absorption system including, but not limited to, structural components such as bumper reinforcement bars, bumper energy absorbers, frames, rails, fender aprons, A-pillars, B-pillars and body panels must work together to maintain cabin integrity and protect the vehicle occupants.

The supplemental restraint system including but not limited to air bags, side curtain air bags, and deployment sensors work together with the above components to provide proper timing for air bag deployment.

Due to the above, Volvo Car USA does not support the use of aftermarket, alternative or anything other than original Volvo parts for collision repair.

Volvo Car USA also recommends using Volvo-approved replacement glass. The use of aftermarket glass, particularly a windshield, can have an adverse effect on collision avoidance and advanced lighting systems.

In addition Volvo does not support the use or re-use of structural components from an existing vehicle that has been previously damaged. Although these parts may appear equivalent, it is difficult to tell if the parts have been previously replaced with non-



OE parts or if the part has been damaged as a result of a prior collision. The quality of these used parts may also have been affected due to environmental exposure.

---

## 2.14. Contacting Volvo

Use the following contact information if you would like to get in touch with Volvo in the United States or Canada.

### In the USA:

#### Volvo Car USA

1800 Volvo Place

Mahwah, NJ 07430

Attn: Volvo Consumer Relations Center

For faster delivery of your letter, send us a fax at 1-866-631-9059.

Phone: 1-800-458-1552

[volvocars.com/us](http://volvocars.com/us)

#### Volvo Car Financial Services

P.O. Box 91300

Mobile, AL 36691-1300

Visit Volvo Car Financial Service for questions about your existing VCF contract.

### In Canada:

Volvo Car Canada Ltd.

Customer Care Centre

9130 Leslie Street, Suite 101

Richmond Hill, Ontario L4B 0B9

1-800-663-8255

[volvocars.com/ca](http://volvocars.com/ca)

---

## 2.15. Important information on accessories and extra equipment

The content of this manual represents the status of the user manual at the time of printing and may not be completely valid in future instances. For more information refer to the first page for the complete disclaimer note.

Incorrectly connected or installed accessories or extra equipment may have an adverse effect on the vehicle's electronics.

Volvo strongly recommends that Volvo owners install only genuine, Volvo-approved accessories, and that accessory installations be performed only by a trained and qualified Volvo service technician. Certain functions only work when the associated software is installed in the vehicle's computer system.

The equipment described in the Owner's Manual is not available in all vehicles. Vehicles may be equipped differently depending on market requirements and national or local laws and regulations.

Optional or accessory equipment may not be available in all countries or markets. Please note that some vehicles may be equipped differently, depending on special legal requirements. For more information on which equipment is standard and which is an option or accessory, please contact your Volvo retailer.

 **Note**

Do not export your Volvo to another country before investigating that country's applicable safety and exhaust emission requirements. In some cases it may be difficult or impossible to comply with these requirements. Modifications to the emission control system(s) may render your Volvo not certifiable for legal operation in the U.S., Canada and other countries.

 **Warning**

CALIFORNIA proposition 65

Engine exhaust, some of its constituents, and certain vehicle components contain or emit chemicals known to the state of California to cause cancer, and birth defects or other reproductive harm. In addition, certain fluids contained in vehicles and certain products of component wear contain or emit chemicals known to the State of California to cause cancer, and birth defects or other reproductive harm.

See [www.P65Warnings.ca.gov/passenger-vehicle](http://www.P65Warnings.ca.gov/passenger-vehicle).

 **Warning**

Certain components of this vehicle such as air bag modules, seat belt tensioners, adaptive steering columns, and button cell batteries may contain Perchlorate material. Special handling may apply for service or vehicle end of life disposal.

See [www.dtsc.ca.gov/hazardouswaste/perchlorate](http://www.dtsc.ca.gov/hazardouswaste/perchlorate).

 **Warning**

The driver is always responsible for operating the vehicle in a safe manner and for complying with current statutes and regulations.

It is also essential to maintain and service the vehicle according to Volvo's recommendations as stated in the owner's information and the Warranty and Service Records Information booklet.

If the information in the center display differs from information in other sources, the information in the center display always takes precedence.



## 3. Safety

---

### 3.1. Seat belts

---

#### 3.1.1. Seat belts

Seat belts should always be worn by all occupants in your vehicle. Children should be properly restrained using an infant seat, adjustable child seat or booster cushion as determined by age, weight and height.

Most states and provinces make it mandatory for occupants of a vehicle to use seat belts.

#### Seat belt maintenance

Check periodically that the seat belts are in good condition. Use water and a mild detergent for cleaning. Check the seat belt mechanism's function as follows: attach the seat belt and pull rapidly on the strap.

 **Warning**

- Never repair the belt yourself. Repairs should only be performed by a trained and qualified Volvo service technician.
- Any device used to induce slack into the shoulder belt portion of the three-point belt system will have a detrimental effect on the amount of protection available in the event of a collision.
- The seat back should not be tilted too far back. The shoulder belt must be taut in order to function properly.
- Do not use any type of child restraint in the front passenger seat. We recommend that children who have outgrown these devices sit in the rear seat with the seat belt properly fastened.

---

#### 3.1.2. Buckling and unbuckling seat belts

Make sure that all passengers have buckled their seat belts before starting to drive.

#### Buckling seat belts

- 1 Pull out the belt slowly and make sure it is not twisted or damaged.

**Note**

The seat belt is equipped with a seat belt retractor that will lock up in the following situations:

- if the belt is pulled out too quickly.
- during braking and acceleration.
- if the vehicle is leaning excessively.
- when driving in sharp turns.
- if the automatic locking retractor/emergency locking retractor (ALR/ELR) is activated. Each seat belt (except for the driver's) is equipped with an ALR function, which is designed to keep the seat belt taut when installing a child restraint. ALR is activated when the seat belt is pulled out as far as possible. If this is done, a sound from the seat belt retractor will be audible, which is normal. The seat belt can now only be fed into the retractor, not pulled out. This function is automatically disabled when the seat belt is unbuckled and fully retracted.

**2** Buckle the seat belt by pushing the latch plate into the receptacle.

➤ A distinct "click" indicates that the belt is locked into place.

**Warning**

Always insert the seat belt latch plate into the belt buckle on the correct side. Failure to do so could cause the seat belts and belt buckles to malfunction in a collision. There is a risk of serious injury.

**3** The height of the seat belts in the front seats can be adjusted.



Press the button on the seat belt holder and move the belt up or down.

Position the belt as high as possible without it chafing against the neck.

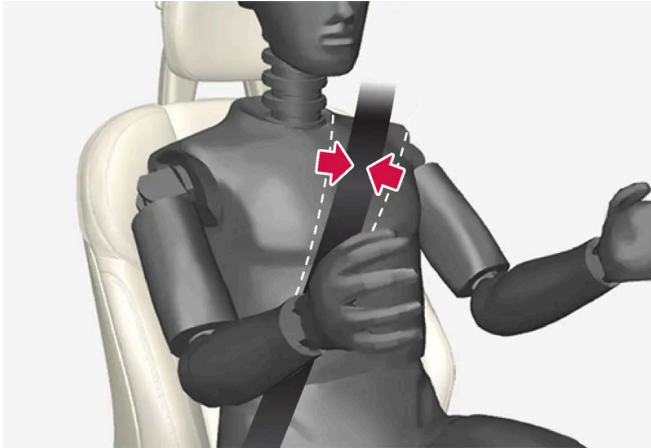

The belt should be positioned closely over the shoulder (against the collarbone, not down over the arm).

- 4 Tighten the lap section of the seat belt over the hips by pulling the diagonal section upward toward the shoulder.

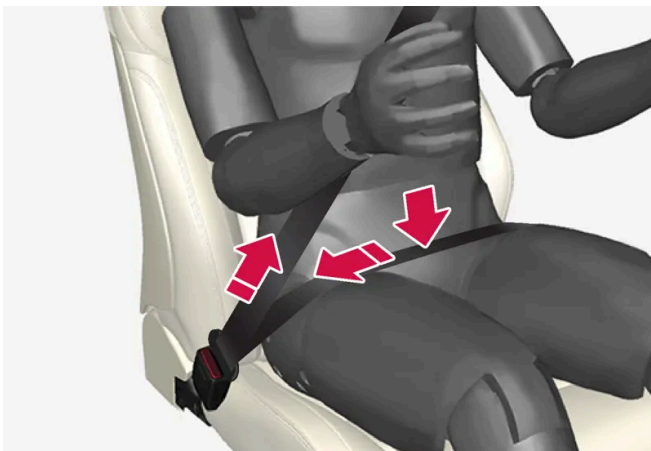

The lap section of the seat belt should be positioned low on the hips (not against the abdomen).

 **Warning**

Never use a seat belt for more than one occupant. Never wear the shoulder portion of the belt under the arm, behind the back or otherwise out of position. Such use could cause injury in the event of an accident. As seat belts lose much of their strength when exposed to violent stretching, they should be replaced after any collision, even if they appear to be undamaged.

 **Warning**

Do not use clips or fasten the belts around hooks or other parts of the interior. This will prevent the seat belt from fitting properly.

 **Warning**

Never damage the seat belts and never insert any foreign objects into the belt buckle. This may cause the seat belts and belt buckles to malfunction in a collision. There is a risk of serious injury.

## Unbuckling seat belts

- 1 Press the red button on the seat belt receptacle and make sure the seat belt retracts fully into the retractor slot.
- 2 If it does not fully retract, guide the belt manually into the slot and make sure it does not hang loose.

---

### 3.1.3. Seat belt tensioners

The vehicle is equipped with standard and electric\* seat belt tensioners that can help tension the seat belt in a critical situation or collision.

#### Standard seat belt tensioners

The seat belts on the front seats and rear outboard seats are equipped with standard seat belt tensioners.

In a collision of sufficiently violent force, the seat belt tensioners will tension the seat belts in order to more effectively restrain the occupants.

#### Electric seat belt tensioners \*

The driver's and front passenger's seat belts are equipped with electric seat belt tensioners.

The seat belt tensioners interact and can be activated in conjunction with the assistance during collision risks and Rear Collision Warning\* driver support systems. In critical situations, such as if the vehicle brakes suddenly, begins to skid or runs off the road (e.g if the vehicle rolls into a ditch, lifts off the ground or hits an obstacle in the road), or if there is a risk of collision, the seat belts can be pulled taut by the seat belt tensioner's electric motor.

The electric seat belt tensioner helps to position the occupant more effectively in the seat, which reduces the risk of the occupant striking the interior of the passenger compartment and improves the effect of other safety systems such as the airbags.

When a critical situation has passed, the seat belt and the electric seat belt tensioner are reset automatically. However, they can also be reset manually.

#### Important

If the passenger airbag is deactivated, the passenger-side electric seat belt tensioner is also deactivated.

 **Warning**

Never attempt to alter or repair the seat belt on your own. Volvo recommends contacting an authorized Volvo workshop.

If the seat belt has been exposed to extreme forces, e.g. in conjunction with a collision, the entire seat belt must be replaced. Even if the seat belt appears undamaged, some of its protective properties may have been lost. Also replace the seat belt if it is worn or damaged. The new seat belt must be type approved and intended for the same seating position as the replaced seat belt.

\* Option/accessory.

---

### 3.1.4. Resetting the electric seat belt tensioners\*

The electric seat belt tensioners are designed to be reset automatically, but if the seat belt remains taut it can be reset manually.

- 1 Stop the vehicle in a safe location.
  - 2 Unbuckle the seat belt and then rebuckle it.
- The seat belt and the electric seat belt tensioner will be reset.

 **Warning**

Never attempt to alter or repair the seat belt on your own. Volvo recommends contacting an authorized Volvo workshop.

If the seat belt has been exposed to extreme forces, e.g. in conjunction with a collision, the entire seat belt must be replaced. Even if the seat belt appears undamaged, some of its protective properties may have been lost. Also replace the seat belt if it is worn or damaged. The new seat belt must be type approved and intended for the same seating position as the replaced seat belt.

\* Option/accessory.

---

### 3.1.5. Door and seat belt reminders

This system is intended to remind occupants to buckle their seat belts and to alert the driver if a door, hood or other opening (trunk, sunroof, etc.) is open.



## Information in the instrument panel

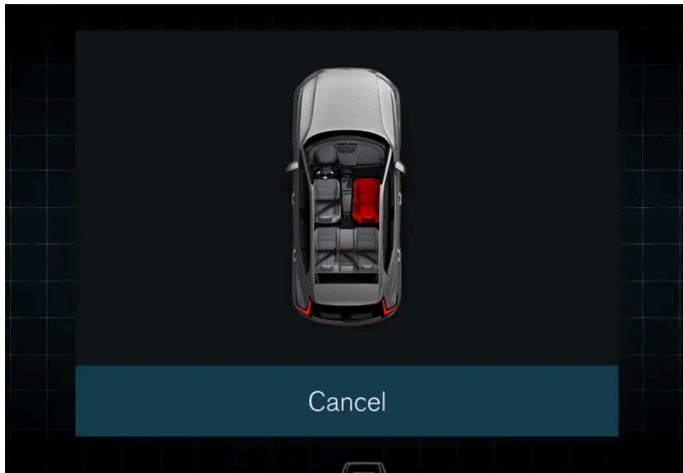

Graphic in the instrument panel.

Graphics in the instrument panel show the status of the seat belts, hood, tailgate and doors.

Confirm the graphic by briefly pressing the **O** button on the right-side steering wheel keypad.



As soon as the graphic is acknowledged, or after a short period of time if the graphic is not acknowledged, it may switch to a smaller format and be shown at the top of the instrument panel instead.

## Seat belt reminder



Reminder light in overhead console.

A seat belt reminder light illuminates in the overhead console and a warning symbol is displayed in the instrument panel.

The type of visible reminder (steady or flashing) and audible reminder (different signals) provided depends on the speed of the vehicle as well as driving time and distance driven.

### **i** Note

The child seat's integrated seat belt is not covered by the seat belt reminder system.

Reminders or information through graphics are provided in different ways depending on the location of the seat belt.

**The content of this manual represents the status of the user manual at the time of printing and may not be completely valid in future instances. For more information refer to the first page for the complete disclaimer note.**

The following is provided for the front seat:

- reminder when the driver or a passenger is not using their seat belt while driving
- reminder when a seat belt is removed while driving
- information on which seat belts are being used or not used.

The following is provided for the rear seat:

- reminder when a seat belt is removed while driving
- information on which seat belts are being used or not used.

## Door, hood and tailgate reminders

If the hood, tailgate or any door is not properly closed, this will be indicated by a graphic in the instrument panel. Stop the vehicle safely and close the open door, hood, etc.



If the vehicle is moving at a speed under approx. 10 km/h (6 mph), the information symbol will illuminate in the instrument panel.



If the vehicle is moving at a speed above approx. 10 km/h (6 mph), the warning symbol will illuminate in the instrument panel.

---

## 3.2. Airbags

### 3.2.1. Airbags

The vehicle is equipped with a number of different airbags to help protect the driver and passengers.

 **Warning**

- If the airbag warning light stays on after the engine has started or if it illuminates while you are driving, have the vehicle inspected by a trained and qualified Volvo service technician as soon as possible.
- Never attempt to alter or repair any of the vehicle's safety systems yourself. Incorrectly performed repairs to any system could impair function and lead to serious injury. All work on these systems should be performed by a trained and qualified Volvo service technician.

 **Warning**

If your vehicle has become water-damaged in any way (e.g., soaked floor mats/standing water on the floor of the vehicle), do not attempt to start the engine. This may cause airbag deployment, which could result in serious injury. Volvo recommends towing the vehicle directly to an authorized Volvo workshop.

Before attempting to tow the vehicle:

1. Switch off the ignition for at least 10 minutes and disconnect the battery.
2. Follow the instructions for manually overriding the shiftlock system.

## Deployed airbags

 **Warning**

If any of the airbags have deployed:

- Do not attempt to drive the vehicle. Have it towed to an authorized workshop.
- If necessary, seek medical attention.

### 3.2.2. Driver/passenger side front airbags

As a supplement to the seat belts, the vehicle is equipped with driver and passenger side front airbags.

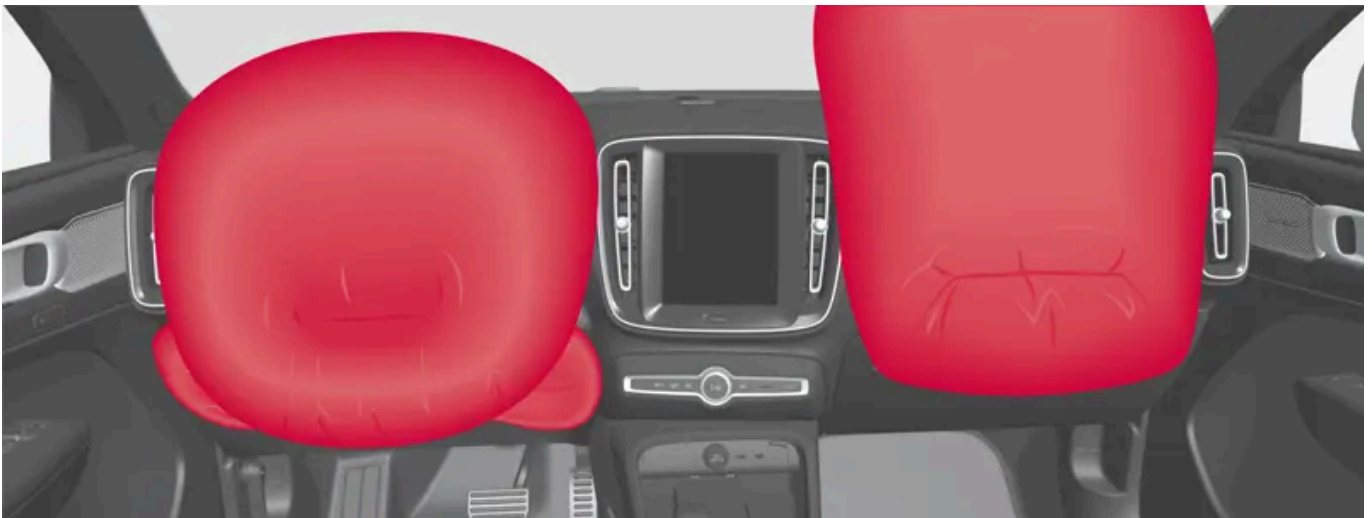

Driver/passenger side front airbags.

In a frontal collision, the airbags help protect the driver's and passenger's head, neck, face and chest and the driver's knees and legs.

A collision of a sufficiently violent force will trigger the sensors and one or more airbags will inflate. The airbag helps cushion the initial impact of the collision for the passenger. The airbag deflates when compressed by the collision. A small amount of powder will also be released from the airbag. This may appear to be smoke and is normal. The entire process, from inflation to deflation of the airbag, occurs within tenths of a second.

 **Note**

The sensors react differently depending on the circumstances of the accident and whether or not the seat belt is used. This applies to all belt positions.

There may therefore be accident situations in which only one (or none) of the airbags are deployed. The sensors monitor the impact of the collision and react accordingly to deploy one, several or no airbags.

 **Warning**

The seat belt and the airbag work together. If the seat belt is not used or is used incorrectly, the airbag may not provide the intended protection in a collision.

To help prevent injury in the event the airbag is deployed, passengers should sit as upright as possible, with their feet on the floor and their backs against the seat backrest.

 **Warning**

Volvo recommends contacting an authorized Volvo workshop for repairs. Incorrectly performed repairs to the airbag system could impair function and lead to serious injury.

## The front airbag system

The front airbag system includes gas generators surrounded by the airbags, and deceleration sensors that activate the gas generators, causing the airbags to be inflated with nitrogen gas.

As the movement of the seats' occupants compresses the airbags, some of the gas is expelled at a controlled rate to provide better cushioning. The belt tensioners minimize slack in the seat belts and are activated for occupants wearing their seat belts. The entire process, from inflation to deflation of the airbag, occurs within tenths of a second.

The location of the front airbags is indicated by the AIRBAG marking on the steering wheel pad and above the glove compartment, and by decals on both sun visors and on the front and far right side of the dashboard.

The **driver's side front airbag** is folded and located in the steering wheel hub.

The **knee airbag** is folded on the underside of the dashboard on the driver's side. AIRBAG is embossed on the panel.

The **passenger's side front airbag** is folded behind a panel located above the glove compartment.

 **Warning**

- The airbags in the vehicle are designed to be a SUPPLEMENT to-not a replacement for-the three-point seat belts. For maximum protection, wear seat belts at all times. Be aware that no system can prevent all possible injuries that may occur in an accident.
- Never drive with your hands on the steering wheel pad/airbag housing.
- The front airbags are designed to help prevent serious injury. Deployment occurs very quickly and with considerable force. During normal deployment and depending on variables such as seating position, one may experience abrasions, bruises, swellings, or other injuries as a result of deployment of one or both of the airbags.
- When installing any accessory equipment, make sure that the front airbag system is not damaged. Any interference in the system could cause malfunction.

## Front airbag deployment

- The front airbags are designed to deploy during certain frontal or front-angular collisions, impacts, or decelerations, depending on the crash severity, angle, speed and object impacted. The airbags may also deploy in certain non-frontal collisions where rapid deceleration occurs.
- The airbag system's sensors, which trigger the front airbags, are designed to determine if the collision is powerful enough to activate the belt tensioners and/or the airbags.

However, not all frontal collisions activate the front airbags.

- If the collision involves a nonrigid object (e.g., a snow drift or bush), or a rigid, fixed object at a low speed, the front airbags will not necessarily deploy.
- Front airbags do not normally deploy in a side impact collision, in a collision from the rear or in a rollover situation.
- The amount of damage to the bodywork does not reliably indicate if the airbags should have deployed or not.

 **Note**

- The front airbags and seat belt tensioners may be activated in a collision. The airbags are only activated one time during an accident. Some noise occurs and a small amount of powder is released. The release of the powder may appear as smoke-like matter. This is a normal characteristic and does not indicate fire.
- Volvo's front airbags use special sensors that are integrated with the front seat buckles. The point at which the airbag deploys is determined by whether or not the seat belt is being used, as well as the severity of the collision.
- Collisions can occur where only one of the airbags deploys. If the impact is less severe, but severe enough to present a clear injury risk, the airbags are triggered at partial capacity. If the impact is more severe, the airbags are triggered at full capacity.

 **Warning**

- Do not use child safety seats or child booster cushions/backrests in the front passenger's seat. Volvo follows NHTSA's recommendations and recommends that ALL children up to and including 12 years of age sit in the rear seat. This is very strongly recommended for children in rear-facing child seats. See also the Occupant Classification System information.
- Never drive with the airbags deployed. The fact that they hang out can impair the steering of your vehicle. Other safety systems can also be damaged.
- The smoke and dust formed when the airbags are deployed can cause skin and eye irritation in the event of prolonged exposure.

Should you have questions about any component in the SRS system, please contact a trained and qualified Volvo service technician or Volvo customer support:

**In the United States**

Volvo Car USA, LLC

Customer Care Center

1800 Volvo Place

Mahwah, New Jersey 07430

1-800-458-1552

[www.volvocars.com/us](http://www.volvocars.com/us)

**In Canada**

Volvo Car Canada Ltd.

Customer Care Centre

9130 Leslie Street, Suite 101

Richmond Hill, Ontario L4B 0B9

1-800-663-8255

[www.volvocars.com/ca](http://www.volvocars.com/ca)

## Airbag decals



Airbag decal on the outside of both sun visors.



Passenger's side airbag decal.

### **Warning**

- Children must never be allowed in the front passenger's seat.
- Occupants in the front passenger's seat must never sit on the edge of the seat, sit leaning toward the instrument panel or otherwise sit out of position.
- The occupant's back must be as upright as comfort allows and be against the seat back with the seat belt properly fastened.
- Feet must be on the floor, e.g., not on the dash, seat or out of the window.

 **Warning**

- No objects or accessory equipment, e.g. dashboard covers, may be placed on, attached to, or installed near the air bag cover (the area above the glove compartment) or the area affected by airbag deployment.
- There should be no loose articles, such as coffee cups on the floor, seat, or dashboard area.
- Never try to open the airbag cover on the steering wheel or the passenger's side dashboard. This should only be done by a trained and qualified Volvo service technician.
- Failure to follow these instructions can result in injury to the vehicle's occupants.

### 3.2.3. Occupant Classification System

The Occupant Classification System (OCS) is designed to meet the regulatory requirements of Federal Motor Vehicle Safety Standard (FMVSS) 208 and is designed to disable (will not inflate) the passenger's side front airbag under certain conditions.



OCS indicator light.

The front passenger-side airbag is either enabled or disabled depending on the classification of the passenger in the front passenger seat.

Volvo follows NHTSA's recommendations and recommends that ALL children up to and including 12 years of age sit in the rear seat and are restrained in a suitable manner appropriate to their height and weight. This is strongly recommended for children in rear-facing child seats.

Classification of passengers in front passenger seat	OCS indicator light status	Passenger's side front airbag status
The passenger is classified as an adult.	OCS indicator light is not lit.	Enabled
The passenger is classified as a small child in a front-facing child seat.	The OCS indicator light is lit or not lit depending on several parameters that determine the most suitable status.	Enabled or disabled depending on several parameters that determine the most suitable status.
The passenger is classified as a small child in a rear-facing child seat.	OCS indicator light is lit.	Disabled
The passenger seat is empty.	OCS indicator light is lit.	Disabled



## Occupant Classification System function

OCS works in combination with sensors in the front passenger seat. The sensors are intended to detect the presence, and classification of, an occupant sitting correctly and determine whether the front passenger airbag should be enabled (able to be deployed) or disabled (cannot be deployed).

The OCS uses an indicator light with the text **PASSENGER AIRBAG OFF**, which will illuminate and stay on to remind you that the passenger's side front airbag is disabled. The **PASSENGER AIRBAG OFF** indicator light is located in the overhead console near the bracket for the rearview mirror.

Always pay attention that the status of the indicator light shows the correct classification both before and while driving when the front passenger seat is occupied.

### Note

When the ignition is switched on, the OCS indicator light will illuminate for several seconds while the system performs a self-diagnostic test. The indicator light will then go out or remain illuminated, depending on the classification of the passenger in the front passenger seat.



If a malfunction is detected in the system, the OCS indicator light will remain illuminated and the SRS warning symbol will be shown in the instrument panel along with a text message.

### Warning

If a fault in the system is detected and indicated as described, be aware that the passenger's side front airbag will not deploy in the event of a collision. If this occurs, have the airbag system and Occupant Classification System checked by a workshop as soon as possible. Volvo recommends contacting an authorized Volvo workshop.

## Classification of adult

To help ensure accurate classification when a person of adult size is sitting in the front passenger seat, the passenger must:

- be wearing their seat belt
- sit normally in the seat, in the center of the seat cushion
- sit upright in the seat with their shoulders against the backrest

- have their legs comfortably extended with their feet on the floor.

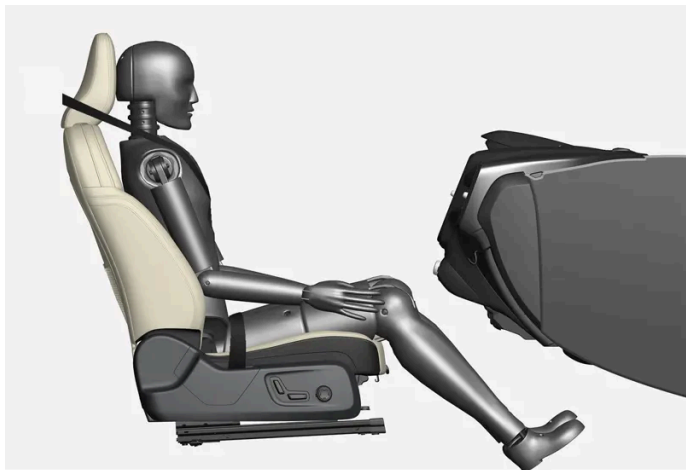

Correct seating position.

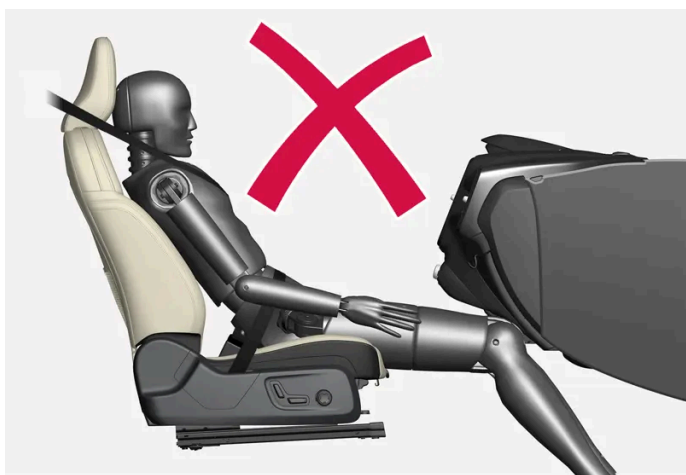

Example of incorrect seating position – the passenger must not have slid forward on the seat cushion.

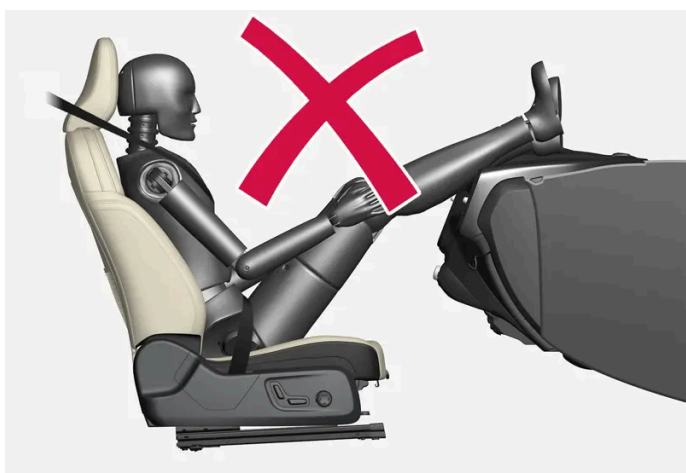

Example of incorrect seating position – the passenger must be seated with their feet on the floor.

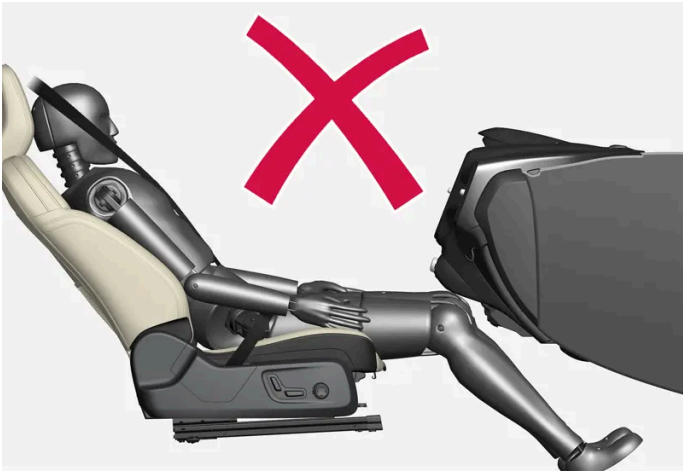

Example of incorrect seating position – the passenger must not fold the backrest to a lying position.

Remember the following when an adult sits in the front passenger seat:

- The passenger must never get up from the seat cushion using the armrest in the door or center console, by pushing their feet against the floor or by pushing against the backrest.
- The passenger must never sit on the side of the seat cushion, slide forward on the seat cushion or fold the backrest to a lying position.
- The passenger must never wear wet or thick clothing, e.g. ski wear or padded garments.
- Never place any objects between the passenger and the seat cushion, e.g. pillows, heating blankets or ordinary blankets, seat liners or mats.
- Never place a radio transmitter (e.g. hunting radio or walkie-talkie) or device that is being charged (e.g. cellular phone, tablet or computer) on or under the seat cushion. Never let anyone sitting on the passenger seat use a radio transmitter or device that is being charged.

 **Warning**

Failure to follow the above instructions could adversely affect the Occupant Classification System functions and result in death or serious injury.

If a person of adult size is sitting in the front passenger's seat, but the OCS indicator lamp is on, it is possible that the person isn't sitting properly in the seat.

If this occurs, turn off the vehicle and ask the person to follow the above instructions for accurate classification. Restart the vehicle and have the person remain in this position for about two minutes. This will allow the system to detect that person and enable the passenger's frontal airbag.

If the OCS indicator lamp remains on even after this, the person should be advised to ride in the rear seat.

This may indicate restrictions in the OCS classification ability, e.g. that the person is too light to be classified as an adult. It does not need to indicate an OCS error.

## Classification of child

Volvo follows NHTSA's recommendations and recommends that ALL children up to and including 12 years of age sit in the rear seat. This is strongly recommended for children in rear-facing child seats.

If a child in a child restraint is placed in the front passenger seat, the child restraint must be installed according to the manufacturer's instructions to help ensure accurate classification.

Remember the following if a child in a child seat sits in the front passenger seat:

- Never place any items or accessories on the passenger seat, between the child seat and the seat cushion or near to the seat cushion.
- Never place a radio transmitter (e.g. hunting radio or walkie-talkie) or device that is being charged (e.g. cellular phone, tablet or computer) on the seat cushion. Never let anyone sitting on the passenger seat use a radio transmitter or device that is being charged.
- Never place wet clothing or fluids on the passenger seat.
- Always correctly position the child seat so that the entire lower section of the child seat rests against the seat cushion.
- Always place a front-facing child seat as far back as possible against the seat back.



**Warning**

Failure to follow the above instructions could adversely affect the Occupant Classification System functions and result in death or serious injury.

## Modifications

If you are considering modifying your vehicle in any way to accommodate a disability, for example by altering or adapting the driver's or front passenger's seat(s) and/or airbag systems, please contact Volvo at:

### In the United States

Volvo Car USA, LLC

Customer Care Center

1800 Volvo Place

Mahwah, New Jersey 07430

1-800-458-1552

### In Canada

Volvo Car Canada Ltd.

Customer Care Centre

9130 Leslie Street, Suite 101

Richmond Hill, Ontario L4B 0B9

1-800-663-8255

 **Warning**

Never attempt to open, remove or repair any components in the OCS system. Volvo recommends contacting an authorized Volvo workshop. Incorrectly performed repairs to the OCS system could impair function and lead to serious injury. The front passenger's seat should not be modified in any way. This could affect the function of the OCS system.

## 3.2.4. Inflatable curtain

The inflatable curtain, Inflatable Curtain (IC), helps to prevent the driver and passengers from striking their heads on the inside of the vehicle during a collision.

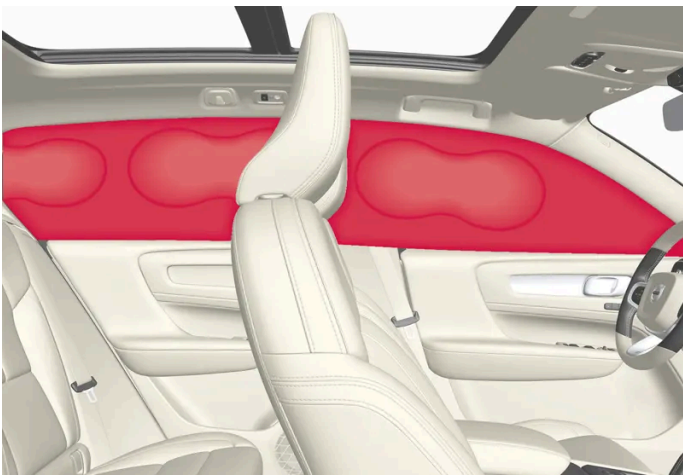

The inflatable curtains are installed along both sides of the inside of the roof and help protect occupants in the vehicle's outer seats. IC AIRBAG is embossed on the panels.

A collision of a sufficiently violent force will trigger the sensors and the inflatable curtain will inflate.

 **Warning**

Volvo recommends contacting an authorized Volvo workshop for repair. Incorrectly performed repairs to the inflatable curtain system could impair function and lead to serious injury.

 **Warning**

Never hang or attach heavy objects in the handle in the ceiling bracket. The hooks are only intended for lightweight garments (not for hard objects such as umbrellas).

Never screw or mount anything to the vehicle's headliner, door pillars or side panels. This could impair the intended protective properties. Volvo recommends only using Volvo original parts that are approved for placement in these areas.

 **Warning**

If objects are loaded higher than the upper edge of the side windows, leave a 10 cm (4 in.) space between the objects and the window. Objects placed closer to this could impede the function of the inflatable curtain concealed inside the headlining.

 **Warning**

The inflatable curtain is a supplement to the seat belt. Always wear your seat belt.

---

## 3.2.5. Near-side airbags

The near-side airbags on the driver's and passenger sides protect the chest and hips in a collision.



The near-side airbags are located in the front seats' outer backrest frames and help protect the driver and front-seat passenger.

A collision of a sufficiently violent force will trigger the sensors and the near-side airbag will inflate. The side airbags inflate between the seat occupant and the door panel to help cushion the initial impact of the collision. The airbag deflates when compressed by the collision. The near-side airbag normally only inflates on the side of the vehicle impacted by the collision.

 **Warning**

Volvo recommends contacting an authorized Volvo workshop for repairs. Incorrectly performed repairs to the side airbag system could impair function and lead to serious injury.

 **Warning**

Do not place any objects in the area between the outer edges of the seats and the door panels, as this could impair the function of the side airbags.

Volvo recommends only using seat covers approved by Volvo. Other seat covers could prevent the side airbags from functioning properly.

 **Warning**

The side airbag is a supplement to the seat belt. Always wear your seat belt.

---

## 3.3. Child safety

---

### 3.3.1. Attachment points for child seats

The content of this manual represents the status of the user manual at the time of printing and may not be completely valid in future instances. For more information refer to the first page for the complete disclaimer note.

---

### 3.3.1.1. Lower child seat attachment points

The rear seats are equipped with lower child seat attachment points.

The lower child seat attachment points are intended for use with certain rear-facing child restraints.

Always follow the manufacturer's installation instructions when attaching a child seat to the lower child seat attachment points.

#### Location of child seat attachment points



Location of child seat attachment points in the rear seat.

The child seat attachment points in the rear seat are located on the rear section of the front seat floor rails.

***i* Note**

Never store loose items around the support legs of a child seat. Make sure that the child seat's loose parts (straps, for example) are secured in accordance with the child seat's installation instructions.

---

### 3.3.1.2. ISOFIX/LATCH lower anchors

The lower anchors for ISOFIX/LATCH-equipped child seats are located in the rear outer seats, behind covers in the lower section of the backrest.



## Using the ISOFIX/LATCH lower child seat anchors

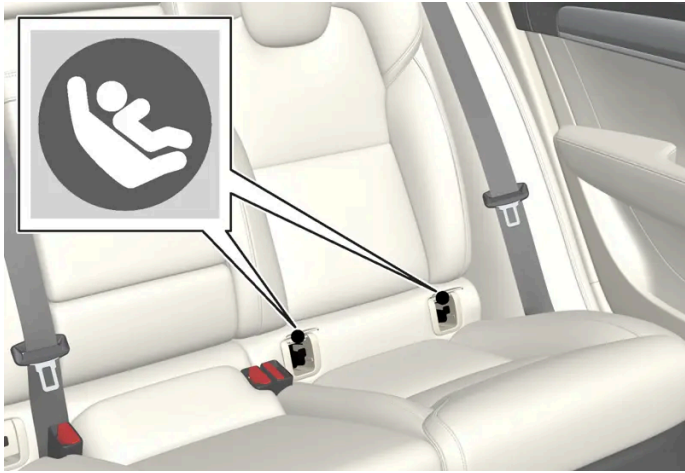

Location of the ISOFIX/LATCH anchors

Symbols on the covers mark the ISOFIX/LATCH anchor positions, as shown in the illustration. The anchors are located behind the covers between the backrest and the seat cushion. Always follow your child seat manufacturer's installation instructions, and use both ISOFIX/LATCH lower anchors and top tethers whenever possible.

### To access the anchors

- 1 Put the child restraint in position.
- 2 Open the covers to access the anchors.
- 3 Fasten the attachment on the child restraint's lower straps to the ISOFIX/LATCH lower anchors.
- 4 Firmly tension the lower child seat straps according to the manufacturer's instructions.

#### **Warning**

Volvo's ISOFIX/LATCH anchors conform to FMVSS/CMVSS standards. Always refer to the child restraint system's manual for weight and size ratings.

**Note**

- The rear center seat is not equipped with ISOFIX/LATCH lower tether anchors. If a child restraint is used in this seat, attach the restraint's upper anchor strap (if equipped with these) to the top tether anchor point for this strap and secure the child restraint with the vehicle's center seat belt.
- Always follow your child seat manufacturer's installation instructions, and use both ISOFIX/LATCH lower anchors and top tethers whenever possible.

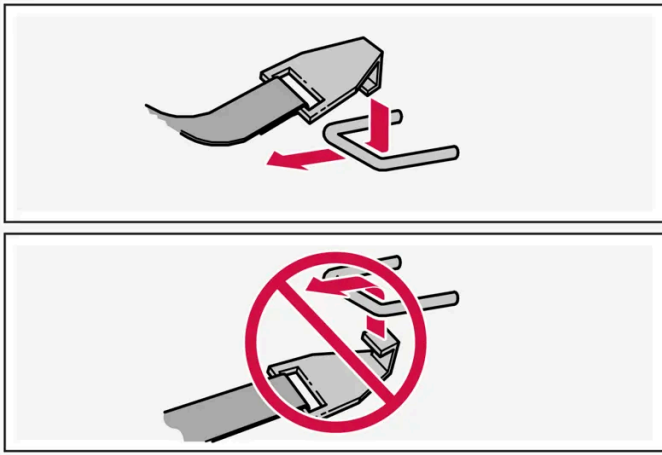

Fasten the attachment correctly to the ISOFIX/LATCH lower anchors

**Warning**

- Be sure to fasten the attachment correctly to the anchor (see the illustration). If the attachment is not correctly fastened, the child restraint may not be properly secured in the event of a collision.
- The ISOFIX/LATCH lower child restraint anchors are only intended for use with child seats positioned in the outboard seating positions. These anchors are not certified for use with any child restraint that is positioned in the center seating position. When securing a child restraint in the center seating position, use only the vehicle's center seat belt.

### 3.3.1.3. Top tether anchors

Your Volvo is equipped with child restraint top tether anchorages for all three seating positions in the rear seat. They are located on the rear side of the backrests.

## Child restraint anchorages

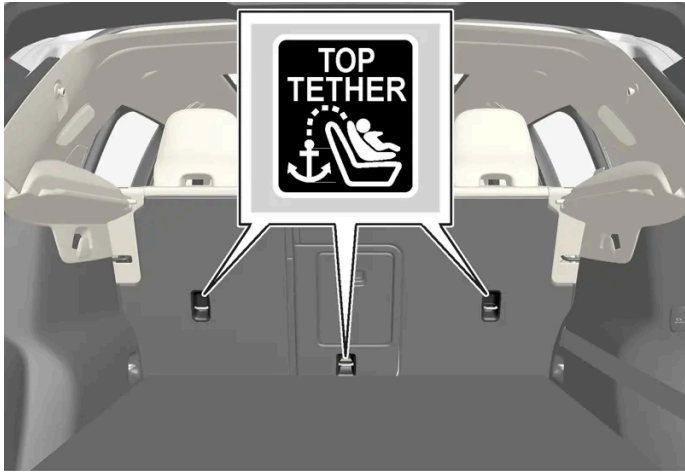

Top tether anchors and symbols on the rear side of the rear seat backrests.

### Securing a child seat

- 1 Place the child restraint on the rear seat.
- 2 Route the top tether strap under the head restraint and attach it to the anchor.
- 3 Attach the strap for the lower tether anchors in the lower ISOFIX/LATCH attachment points. If the child restraint is not equipped with straps for the lower tether anchors, or if the child restraint is used on the center seating position, follow the instructions for attaching a child restraint using the automatic locking seat belt.
- 4 Firmly tension all straps.

Refer also to the child seat manufacturer's instructions for information on securing the child seat.

#### **Note**

The parcel shelf must be removed before a child seat can be attached in the tether anchors.

 **Warning**

- Always refer to the recommendations made by the child restraint manufacturer.
- Volvo recommends that the top tether anchors be used when installing a forward-facing child restraint with upper tether straps.
- Never route a top tether strap over the top of the head restraint. The strap should be routed beneath the head restraint.
- Child restraint anchorages are designed to withstand only those loads imposed by correctly fitted child restraints. Under no circumstances are they to be used for adult seat belts or harnesses. The anchorages are not able to withstand excessive forces on them in the event of collision if full harness seat belts or adult seat belts are installed to them. An adult who uses a belt anchored in a child restraint anchorage runs a great risk of suffering severe injuries should a collision occur.
- Do not install rear speakers that require the removal of the top tether anchors or interfere with the proper use of the top tether strap.

## 3.3.2. Activating and deactivating child locks

The child locks help prevent the rear doors from being able to be opened from the inside. With the electric child lock, the power windows are also prevented from being operated from the rear seat.

The child lock can be either manual or electric\*.

### Manual child lock

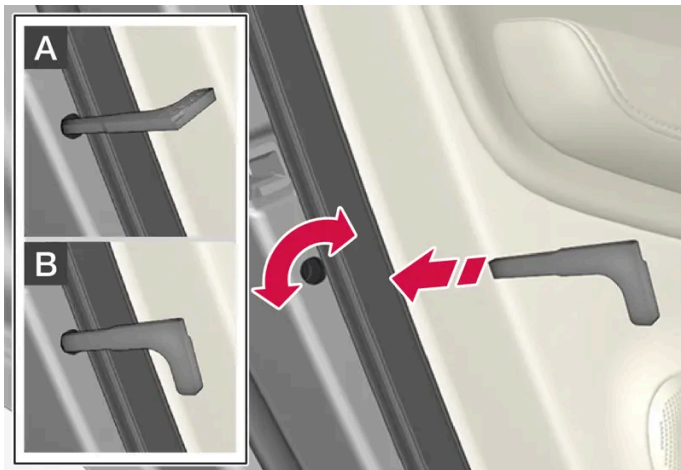

Manual child lock. This is not the manual door lock.

- 1 Use the detachable key blade in the key to turn the control.

**A** The door cannot be opened from the inside.

**B** The door can be opened from both the outside and the inside.

The content of this manual represents the status of the user manual at the time of printing and may not be completely valid in future instances. For more information refer to the first page for the complete disclaimer note.

**Note**

- The door's knob control only locks that specific door, not both rear doors simultaneously.
- There are no manual child locks on models equipped with electric child locks.

## Electric child lock\*

The electric child lock can be activated and deactivated in any ignition mode higher than **0**. The lock can be activated and deactivated up to 2 minutes after the ignition is turned off if no door has been opened.



Button for activation and deactivation.

### Rear child lock activated

When the indicator light in the button is lit, the child lock is activated.

If the child lock is activated when the vehicle is switched off, it will remain activated the next time the vehicle is started.



- Rear doors cannot be opened from the inside.
- Rear power windows can only be operated from the driver's door.

### Rear child lock deactivated

When the indicator light in the button is not lit, the child lock is deactivated.

- Rear doors can be opened from the inside and power windows can be operated from the rear seat.

## Symbols and messages

Symbol	Message	Meaning
	Rear child lock activated	The child lock is activated.
	Rear child lock deactivated	The child lock is deactivated.

\* Option/accessory.

---

### 3.3.3. Child safety

Children should always be seated safely when traveling in the vehicle.

#### General information

Volvo recommends the proper use of restraint systems for all occupants including children. Remember that, regardless of age and size, a child should always be properly restrained in a vehicle.

Your vehicle is also equipped with ISOFIX/LATCH attachments, which make it more convenient to install child seats.

Some restraint systems for children are designed to be secured in the vehicle by lap belts or the lap portion of a lap-shoulder belt. Such child restraint systems can help protect children in vehicles in the event of an accident only if they are used properly. However, children could be endangered in a crash if the child restraints are not properly secured in the vehicle. Failure to follow the installation instructions for your child restraint can result in your child striking the vehicle's interior in a sudden stop.

Holding a child in your arms is NOT a suitable substitute for a child restraint system. In an accident, a child held in a person's arms can be crushed between the vehicle's interior and an unrestrained person. The child could also be injured by striking the interior, or by being ejected from the vehicle during a sudden maneuver or impact. The same can also happen if the infant or child rides unrestrained on the seat. Other occupants should also be properly restrained to help reduce the chance of injuring or increasing the injury of a child.

All states and provinces have legislation governing how and where children should be carried in a vehicle. Find out the regulations existing in your state or province. Recent accident statistics have shown that children are safer in rear seating positions than front seating positions when properly restrained. A child restraint system can help protect a child in a vehicle. Here's what to look for when selecting a child restraint system:

It should have a label certifying that it meets applicable Federal Motor Vehicle Safety Standards (FMVSS 213) - or in Canada, CMVSS 213.

Make sure the child restraint system is approved for the child's height, weight and development - the label required by the standard or regulation, or instructions for infant restraints, typically provide this information.

In using any child restraint system, we urge you to carefully look over the instructions that are provided with the restraint. Be sure you understand them and can use the device properly and safely in this vehicle. A misused child restraint system can result in increased injuries for both the infant or child and other occupants in the vehicle.

When a child has outgrown the child safety seat, you should use the rear seat with the standard seat belt fastened. The best way to help protect the child here is to place the child on a cushion so that the seat belt is properly located on the hips. Legislation in your state or province may mandate the use of a child seat or cushion in combination with the seat belt, depending on the child's age and/or size. Please check local regulations.

A specially designed and tested booster cushion and backrest can be obtained from your Volvo retailer. See also the article "Integrated booster cushion."



 **Warning**

- Do not use child safety seats or child booster cushions/backrests in the front passenger's seat. Volvo follows NHTSA's recommendations and recommends that ALL children up to and including 12 years of age sit in the rear seat. This is very strongly recommended for children in rear-facing child seats.
- On hot days, the temperature in the vehicle interior can rise very quickly. Exposure to these high temperatures for even a short period of time can cause heat-related injury or death. Small children are particularly at risk. Never leave children unattended in a vehicle.

Child seats should always be registered with the child seat manufacturer.

## Volvo's recommendations

Why does Volvo believe that no child should sit in the front seat of a vehicle? It's quite simple really. A front airbag is a very powerful device designed, by law, to help protect an adult.

Because of the size of the airbag and its speed of inflation, a child should never be placed in the front seat, even if he or she is properly belted or strapped into a child safety seat. Volvo has been an innovator in the field of safety since it was founded. And we have no intention of resting on our laurels. But we need your help. Please remember to put your children in the back seat, and buckle them up.

 **Warning**

A child restraint should never be reused if:

- The vehicle has been involved in a collision, no matter how minor
- Its history is unknown
- It is older than the manufacturer's expiration date

### Volvo has some very specific recommendations

- Always wear your seat belt.

The content of this manual represents the status of the user manual at the time of printing and may not be completely valid in future instances. For more information refer to the first page for the complete disclaimer note.

- Airbags are a SUPPLEMENTAL safety device which, when used with a three-point seat belt can help reduce serious injuries during certain types of accidents. Volvo recommends that you do not disconnect the airbag system in your vehicle.
- Volvo strongly recommends that everyone in the vehicle be properly restrained.
- Volvo follows NHTSA's recommendations and recommends that ALL children up to and including 12 years of age sit in the rear seat. This is strongly recommended for children in rear-facing child seats.
- Drive safely!

---

### 3.3.4. Child restraints

Suitable child restraints should always be used when children travel in the vehicle.

#### Child restraint systems

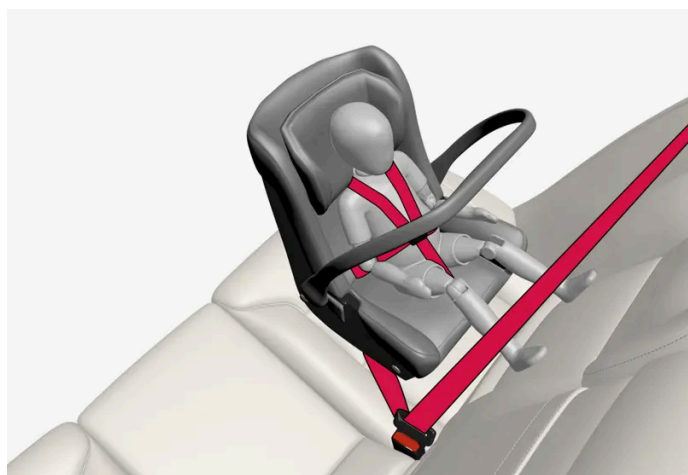

Infant seat

There are three main types of child restraint systems: infant seats, convertible seats and booster cushions. They are classified according to the child's age and size.

The child restraint should be secured using a three-point seat belt, ISOFIX/LATCH anchors or top tether anchors.

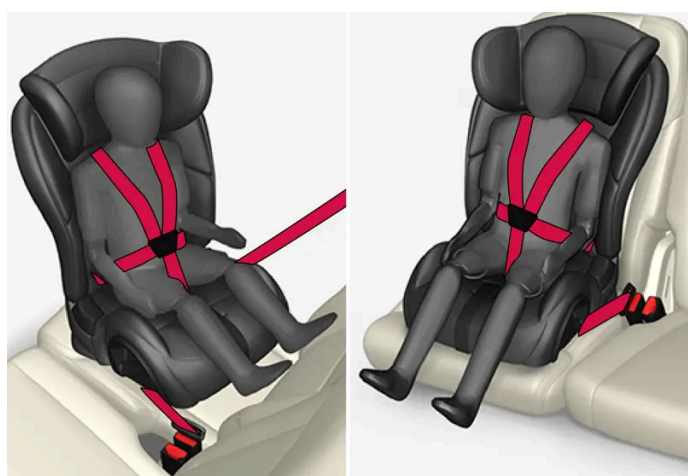

Convertible seat



 **Warning**

A child seat should never be used in the front passenger seat of any vehicle with a front passenger airbag - not even if the "Passenger airbag off" symbol near the rear-view mirror is illuminated. If the severity of an accident were to cause the airbag to inflate, this could lead to serious injury or death to a child seated in this position.



Booster cushion

 **Warning**

Always refer to the child restraint manufacturer's instructions for detailed information on securing the restraint.

 **Warning**

- When not in use, keep the child restraint system secured or remove it from the passenger compartment to help prevent it from injuring passengers in the event of a sudden stop or collision.
- A small child's head represents a considerable part of its total weight and its neck is still very weak. Volvo recommends that children up to age 4 travel, properly restrained, facing rearward. In addition, Volvo recommends that children should ride rearward facing, properly restrained, as long as possible.

 **Note**

For child seats in which the child uses one of the vehicle's integrated seat belts, read the Owner's Manual's seat belt recommendations.

 **Note**

Use caution when installing child seats to ensure that sharp edges or protruding parts on the child seat do not damage the vehicle's interior.

Long-term installation and use of child seats could damage the vehicle's interior. Volvo recommends using the kick guard accessory to help protect the vehicle's interior.

## Automatic Locking Retractor/Emergency Locking Retractor (ALR/ELR)

To make child seat installation easier, each seat belt (except for the driver's belt) is equipped with a locking mechanism to help keep the seat belt taut.

**When attaching the seat belt to a child seat:**

- 1 Position the child seat and secure it using the seat belt according to the manufacturer's instructions.
- 2 Pull the seat belt out as far as possible.
- 3 Insert the seat belt latch plate into the buckle (lock) in the usual way.
- 4 Release the seat belt and pull it taut around the child seat.

A sound from the seat belt retractor will be audible at this time and is normal. The belt will now be locked in place. This function is automatically disabled when the seat belt is unlocked and the belt is fully retracted.



### Warning

Do not use child safety seats or child booster cushions/backrests in the front passenger's seat. We also recommend that children who have outgrown these devices sit in the rear seat with the seat belt properly fastened.

## Child restraint registration and recalls

Child restraints could be recalled for safety reasons. You must register your child restraint to be reached in a recall. To stay informed about child safety seat recalls, be sure to fill out and return the registration card that comes with new child restraints.

Child restraint recall information is readily available in both the U.S. and Canada. For recall information in the U.S., call the U.S. Government's Auto Safety Hotline at 1-800-424-9393 or go to <https://www-odi.nhtsa.dot.gov/owners/SearchSafetyIssues> [<https://www-odi.nhtsa.dot.gov/owners/SearchSafetyIssues>]. In Canada, visit Transport Canada's Child Safety website at <https://www.tc.gc.ca/en/services/road/child-car-seat-safety.html> [<https://www.tc.gc.ca/en/services/road/child-car-seat-safety.html>].

### 3.3.5. Infant seats

Suitable child restraints should always be used when children (depending on their age/size) are seated in the vehicle.

## Securing an infant seat with a seat belt

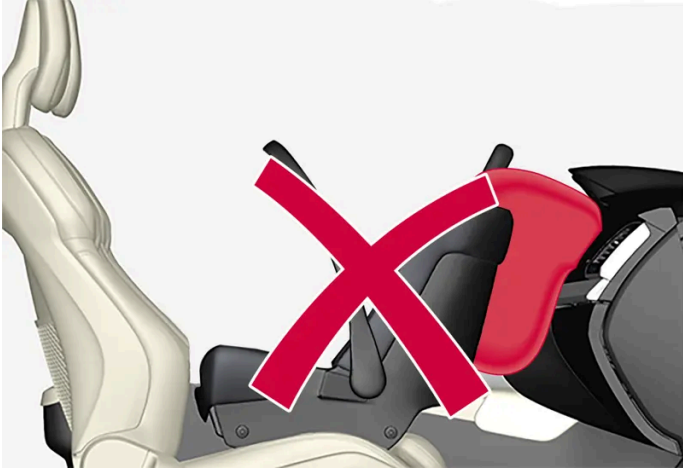

Do not place the infant seat in the front passenger's seat

- 1 Place the infant seat in the rear seat of the vehicle.
- 2 Secure the child seat for small children using the seat belt according to the manufacturer's instructions.



Route the seat belt through the infant seat.

### **Warning**

- An infant seat must be in the rear-facing position only.
- The infant seat should not be positioned behind the driver's seat unless there is adequate space for safe installation.

 **Warning**

A child seat should never be used in the front passenger seat of any vehicle with a front passenger airbag - not even if the "Passenger airbag off" symbol near the rear-view mirror is illuminated. If the severity of an accident were to cause the airbag to inflate, this could lead to serious injury or death to a child seated in this position.



Fasten the seat belt.

Fasten the seat belt by inserting the latch plate into the buckle (lock) until a distinct click is audible.



Pull out the shoulder section of the seat belt.

**4** Pull the shoulder section of the seat belt out as far as possible to activate the belt's automatic locking function.

**5**

 **Note**

The locking retractor will automatically release when the seat belt is unbuckled and allowed to retract fully.

Press the infant seat firmly in place, let the seat belt retract and pull it taut. A sound from the seat belt retractor's auto-

matic locking function will be audible at this time and is normal. The seat belt should now be locked in place.



Check that the infant seat is properly secured.

- 6 Press and pull the infant seat along the direction of the seat belt to check that it is properly held in place by the seat belt.

 **Warning**

It should not be possible to move the child restraint more than 2.5 cm (1 in.) in any direction along the seat belt path.



When installing infant seats in the rear seat, Volvo recommends maintaining a distance of at least 50 mm (2 inches) from the front-most part of the infant seat to the rear-most part of the seat in front.

The infant seat can be removed by unbuckling the seat belt and letting it retract completely.

### 3.3.6. Booster cushions

Suitable child restraints should always be used when children (depending on their age/size) are seated in the vehicle.

## Securing a booster cushion



Position the child correctly on the booster cushion.

Booster cushions are recommended for children who have outgrown convertible seats.

- 1 Place the booster cushion in the rear seat of the vehicle.
- 2 With the child properly seated on the booster cushion, attach the seat belt to or around the cushion according to the manufacturer's instructions.
- 3 Fasten the seat belt by inserting the latch plate into the buckle (lock) until a distinct click is audible.

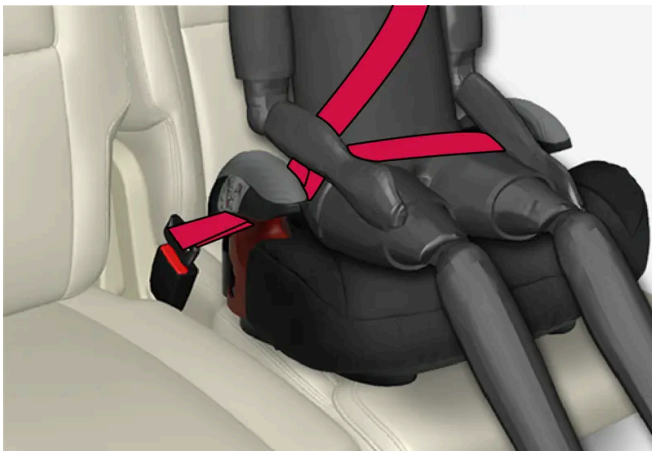

Positioning the seat belt.

- 4 Ensure that the seat belt is pulled taut and fits snugly around the child.

### **Warning**

- The hip section of the three-point seat belt must fit snugly across the child's hips, not across the stomach.
- The shoulder section of the three-point seat belt should be positioned across the chest and shoulder.
- The shoulder belt must never be placed behind the child's back or under the arm.

### 3.3.7. Convertible seats

Suitable child restraints should always be used when children (depending on their age/size) are seated in the vehicle.

#### Securing a convertible seat with a seat belt



Do not place the convertible seat in the front passenger's seat.

Convertible seats can be used in either a forward or rearward-facing position, depending on the age and size of the child.

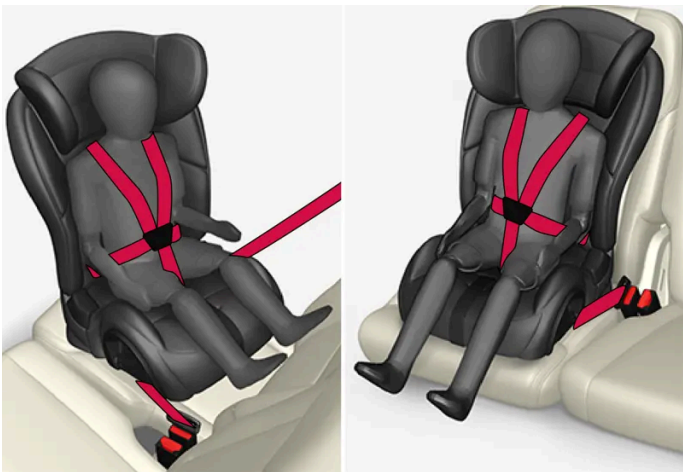

Route the seat belt through the convertible seat.

#### **Warning**

Always use a convertible seat that is suitable for the child's age and size. See the convertible seat manufacturer's recommendations.

- 1 Place the convertible seat in the rear seat of the vehicle.

2

 **Warning**

- A small child's head represents a considerable part of its total weight and its neck is still very weak. Volvo recommends that children up to age 4 travel, properly restrained, facing rearward. In addition, Volvo recommends that children should ride rearward facing, properly restrained, as long as possible.
- Convertible child seats should be installed in the rear seat only.
- A rear-facing convertible seat should not be positioned behind the driver's seat unless there is adequate space for safe installation.

Attach the seat belt to the convertible seat according to the child restraint manufacturer's instructions.



Fasten the seat belt.

- 3 Fasten the seat belt by inserting the latch plate into the buckle (lock) until a distinct click is audible.
- 4 Pull the shoulder section of the seat belt out as far as possible to activate the belt's automatic locking function.

5

 **Note**

The locking retractor will automatically release when the seat belt is unbuckled and allowed to retract fully.

Press the convertible seat firmly in place, let the seat belt retract and pull it taut. A sound from the seat belt retractor's automatic locking function will be audible at this time and is normal. The seat belt should now be locked in place.

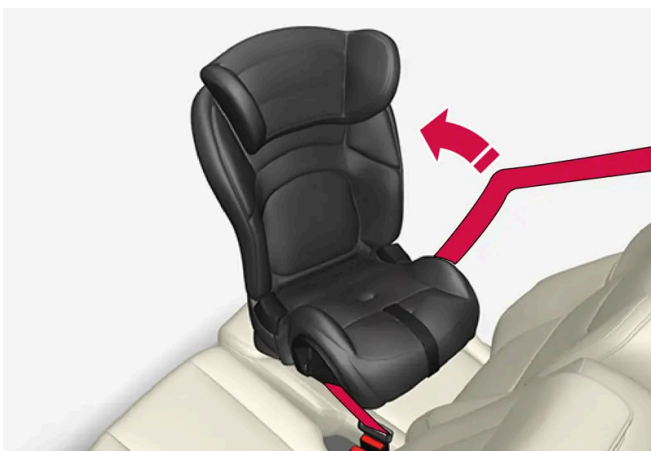

Pull out the shoulder section of the seat belt.

- 6 Push and pull the convertible seat along the seat belt path to ensure that it is held securely in place by the seat belt.



 **Warning**

It should not be possible to move the child restraint more than 2.5 cm (1 in.) in any direction along the seat belt path.

The convertible seat can be removed by unbuckling the seat belt and letting it retract completely.



Ensure that the convertible seat is securely in place.

 **Warning**

A child seat should never be used in the front passenger seat of any vehicle with a front passenger airbag - not even if the "Passenger airbag off" symbol near the rear-view mirror is illuminated. If the severity of an accident were to cause the airbag to inflate, this could lead to serious injury or death to a child seated in this position.

### 3.3.8. Occupant Classification System

The Occupant Classification System (OCS) is designed to meet the regulatory requirements of Federal Motor Vehicle Safety Standard (FMVSS) 208 and is designed to disable (will not inflate) the passenger's side front airbag under certain conditions.



The content of this manual represents the status of the user manual at the time of printing and may not be completely valid in future instances. For more information refer to the first page for the complete disclaimer note.

OCS indicator light.

The front passenger-side airbag is either enabled or disabled depending on the classification of the passenger in the front passenger seat.

Volvo follows NHTSA's recommendations and recommends that ALL children up to and including 12 years of age sit in the rear seat and are restrained in a suitable manner appropriate to their height and weight. This is strongly recommended for children in rear-facing child seats.

Classification of passengers in front passenger seat	OCS indicator light status	Passenger's side front airbag status
The passenger is classified as an adult.	OCS indicator light is not lit.	Enabled
The passenger is classified as a small child in a front-facing child seat.	The OCS indicator light is lit or not lit depending on several parameters that determine the most suitable status.	Enabled or disabled depending on several parameters that determine the most suitable status.
The passenger is classified as a small child in a rear-facing child seat.	OCS indicator light is lit.	Disabled
The passenger seat is empty.	OCS indicator light is lit.	Disabled

## Occupant Classification System function

OCS works in combination with sensors in the front passenger seat. The sensors are intended to detect the presence, and classification of, an occupant sitting correctly and determine whether the front passenger airbag should be enabled (able to be deployed) or disabled (cannot be deployed).

The OCS uses an indicator light with the text **PASSENGER AIRBAG OFF**, which will illuminate and stay on to remind you that the passenger's side front airbag is disabled. The **PASSENGER AIRBAG OFF** indicator light is located in the overhead console near the bracket for the rearview mirror.

Always pay attention that the status of the indicator light shows the correct classification both before and while driving when the front passenger seat is occupied.

### Note

When the ignition is switched on, the OCS indicator light will illuminate for several seconds while the system performs a self-diagnostic test. The indicator light will then go out or remain illuminated, depending on the classification of the passenger in the front passenger seat.



If a malfunction is detected in the system, the OCS indicator light will remain illuminated and the SRS warning symbol will be shown in the instrument panel along with a text message.

### Warning

If a fault in the system is detected and indicated as described, be aware that the passenger's side front airbag will not deploy in the event of a collision. If this occurs, have the airbag system and Occupant Classification System checked by a workshop as soon as possible. Volvo recommends contacting an authorized Volvo workshop.

## Classification of adult

To help ensure accurate classification when a person of adult size is sitting in the front passenger seat, the passenger must:

- be wearing their seat belt
- sit normally in the seat, in the center of the seat cushion
- sit upright in the seat with their shoulders against the backrest
- have their legs comfortably extended with their feet on the floor.

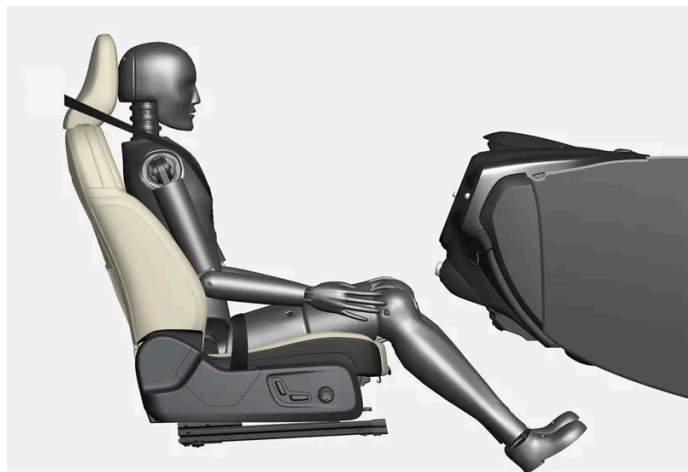

Correct seating position.

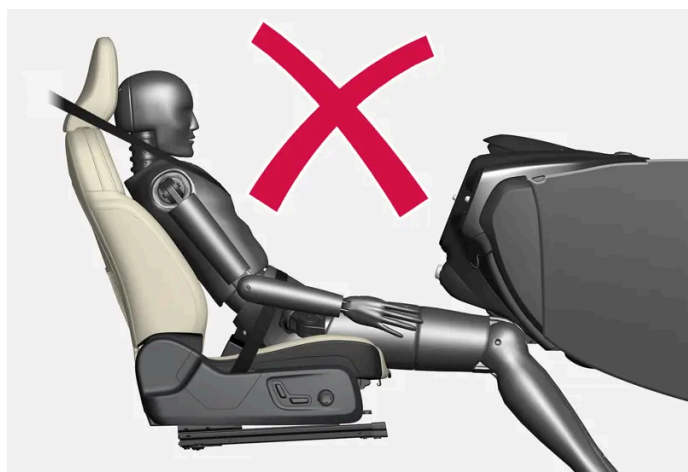

Example of incorrect seating position – the passenger must not have slid forward on the seat cushion.

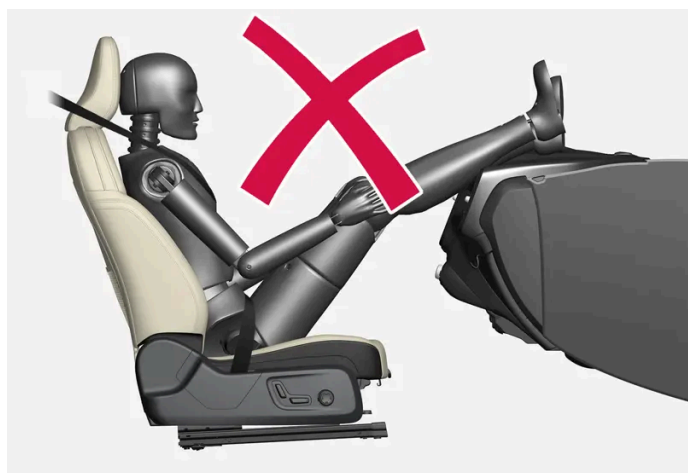

Example of incorrect seating position – the passenger must be seated with their feet on the floor.

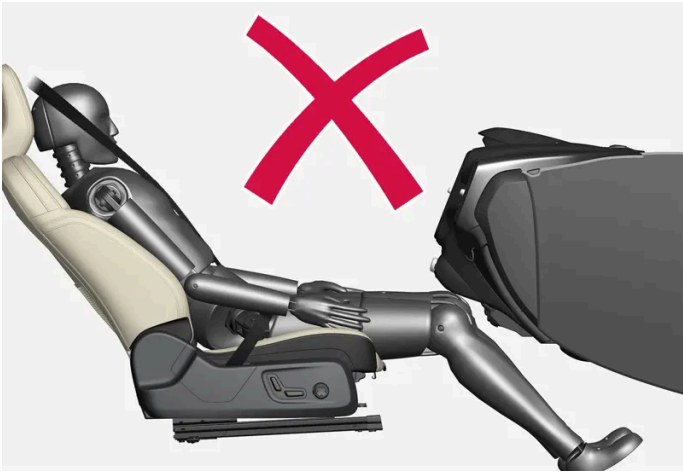

Example of incorrect seating position – the passenger must not fold the backrest to a lying position.

Remember the following when an adult sits in the front passenger seat:

- The passenger must never get up from the seat cushion using the armrest in the door or center console, by pushing their feet against the floor or by pushing against the backrest.
- The passenger must never sit on the side of the seat cushion, slide forward on the seat cushion or fold the backrest to a lying position.
- The passenger must never wear wet or thick clothing, e.g. ski wear or padded garments.
- Never place any objects between the passenger and the seat cushion, e.g. pillows, heating blankets or ordinary blankets, seat liners or mats.
- Never place a radio transmitter (e.g. hunting radio or walkie-talkie) or device that is being charged (e.g. cellular phone, tablet or computer) on or under the seat cushion. Never let anyone sitting on the passenger seat use a radio transmitter or device that is being charged.

 **Warning**

Failure to follow the above instructions could adversely affect the Occupant Classification System functions and result in death or serious injury.

If a person of adult size is sitting in the front passenger's seat, but the OCS indicator lamp is on, it is possible that the person isn't sitting properly in the seat.

If this occurs, turn off the vehicle and ask the person to follow the above instructions for accurate classification. Restart the vehicle and have the person remain in this position for about two minutes. This will allow the system to detect that person and enable the passenger's frontal airbag.

If the OCS indicator lamp remains on even after this, the person should be advised to ride in the rear seat.

This may indicate restrictions in the OCS classification ability, e.g. that the person is too light to be classified as an adult. It does not need to indicate an OCS error.

## Classification of child

Volvo follows NHTSA's recommendations and recommends that ALL children up to and including 12 years of age sit in the rear seat. This is strongly recommended for children in rear-facing child seats.

If a child in a child restraint is placed in the front passenger seat, the child restraint must be installed according to the manufacturer's instructions to help ensure accurate classification.

Remember the following if a child in a child seat sits in the front passenger seat:

- Never place any items or accessories on the passenger seat, between the child seat and the seat cushion or near to the seat cushion.
- Never place a radio transmitter (e.g. hunting radio or walkie-talkie) or device that is being charged (e.g. cellular phone, tablet or computer) on the seat cushion. Never let anyone sitting on the passenger seat use a radio transmitter or device that is being charged.
- Never place wet clothing or fluids on the passenger seat.
- Always correctly position the child seat so that the entire lower section of the child seat rests against the seat cushion.
- Always place a front-facing child seat as far back as possible against the seat back.



**Warning**

Failure to follow the above instructions could adversely affect the Occupant Classification System functions and result in death or serious injury.

## Modifications

If you are considering modifying your vehicle in any way to accommodate a disability, for example by altering or adapting the driver's or front passenger's seat(s) and/or airbag systems, please contact Volvo at:

### In the United States

Volvo Car USA, LLC

Customer Care Center

1800 Volvo Place

Mahwah, New Jersey 07430

1-800-458-1552

### In Canada

Volvo Car Canada Ltd.

Customer Care Centre

9130 Leslie Street, Suite 101

Richmond Hill, Ontario L4B 0B9

1-800-663-8255

 **Warning**

Never attempt to open, remove or repair any components in the OCS system. Volvo recommends contacting an authorized Volvo workshop. Incorrectly performed repairs to the OCS system could impair function and lead to serious injury. The front passenger's seat should not be modified in any way. This could affect the function of the OCS system.

---

## 3.4. Safety mode

---

### 3.4.1. Safety mode

Safety mode is a feature that is triggered after a collision if there is potential damage to an important function in the vehicle, such as the fuel lines, sensors for one of the safety systems, the brake system, etc.

If the vehicle has been involved in a collision, the text **Safety mode See Owner's manual** may appear in the instrument panel along with the warning symbol if the panel is undamaged and the vehicle's electrical system is intact. The message indicates that one or more of the vehicle's functions may be reduced.

 **Warning**

Never attempt to restart the vehicle if you smell fuel fumes when the message **Safety mode See Owner's manual** is displayed in the instrument panel. Leave the vehicle immediately.

If safety mode has been set, it may be possible to reset the system in order to start and move the vehicle a short distance, for example, if it is blocking traffic.

 **Warning**

Never attempt to perform repairs or reset electrical components on your own after the vehicle has been in safety mode. This could result in injury or prevent the vehicle from functioning properly. Volvo recommends having the vehicle inspected and reset to normal operating status by an authorized Volvo workshop after **Safety mode See Owner's manual** has been displayed.

 **Warning**

When the vehicle is in safety mode, it should not be towed behind another vehicle. It should be towed from the site on a tow truck. Volvo recommends towing the vehicle directly to an authorized Volvo workshop.

## 3.4.2. Starting and moving the vehicle when it is in safety mode

If safety mode has been set, it may be possible to reset the system in order to start and move the vehicle a short distance, for example, if it is blocking traffic.

### Resetting and starting the vehicle when it is in safety mode

- 1 Check the vehicle for damage, particularly for fuel leakage. Make sure you do not detect any gasoline fumes.

If the damage to the vehicle is minor and there is no fuel leakage/fumes, you may attempt to start the engine.

#### **Warning**

Never attempt to restart the vehicle if you smell fuel fumes when the message **Safety mode See Owner's manual** is displayed in the instrument panel. Leave the vehicle immediately.

- 2 Switch off the vehicle manually.
  - 3 Then try to start the vehicle.
- The vehicle's electrical system will perform a system check and then attempt to reset to normal operating mode.

#### **Important**

If the message **Safety mode See Owner's manual** is still displayed, the vehicle should not be driven or towed behind another vehicle. If the vehicle needs to be moved, it must be towed on a tow truck. Even if no damage is apparent, there may be hidden damage that could make the vehicle impossible to control.

### Moving the vehicle when it is in safety mode

- 1 If the message **The car is now in normal mode** is displayed after attempting to start the vehicle, the vehicle may be moved carefully from its present position if, for example, it is blocking traffic.
- 2 Do not move the vehicle farther than absolutely necessary.

#### **Warning**

When the vehicle is in safety mode, it should not be towed behind another vehicle. It should be towed from the site on a tow truck. Volvo recommends towing the vehicle directly to an authorized Volvo workshop.

## 3.5. Safety

The vehicle is equipped with a number of safety systems that work together to help protect the vehicle's driver and passengers in the event of an accident.

The vehicle is equipped with a number of sensors that may react in the event of an accident and activate different safety systems, such as the airbag system and seat belt tensioners. Depending on the specific conditions of the accident, e.g. collisions at certain angles, overturning or swerving, the systems react differently to help provide good protection.

There are also mechanical safety systems such as the Whiplash Protection System. The vehicle is also built so that a large part of the force of a collision is distributed to the vehicle's members, pillars, floor, roof and other parts of the body.

After an accident, the vehicle's safety mode may be activated if any important function in the vehicle has been damaged.

### Warning symbol in the instrument panel



The warning symbol in the instrument panel illuminates when the vehicle's electrical system is in ignition mode II. The symbol will go out after approx. 6 seconds if no faults are detected in the vehicle's safety systems.



#### Warning

If the warning symbol remains illuminated or switches on while driving and the message **Drive to workshop SRS airbag Service urgent** is displayed in the instrument panel, this indicates that something in the safety system is not functioning properly. Volvo recommends contacting an authorized Volvo workshop for repairs as soon as possible.



#### Warning

Never attempt to alter or repair any of the vehicle's safety systems yourself. Incorrectly performed repairs to any system could impair function and lead to serious injury. Volvo recommends contacting an authorized Volvo workshop.



If this dedicated warning symbol is not functioning, the general warning symbol will illuminate instead and the same message will be displayed in the instrument panel.

## 3.6. Recall information

### Volvo customers in the US

On our website, click on the three lines next to "Our Cars" up at the right of the screen, then click "Help & Support" and then "Recall information". Enter the vehicle's Vehicle Identification Number (VIN) (found at the bottom of the windshield). If your vehicle has any open Recalls, they will be displayed on this page.

You can also enter the Vehicle Identification Number in the search field on the National Highway Traffic Safety Administration's (NHTSA) website at: [www.nhtsa.gov](https://www.nhtsa.gov/) [<https://www.nhtsa.gov/>].



## Volvo customers in Canada

For any questions regarding open recalls for your vehicle, please contact your authorized Volvo retailer. If your retailer is unable to answer your questions, please contact Volvo Customer Relations at 800-663-8255, Monday through Friday, 8:30 A.M. to 5:00 P.M. EST or [volvocars.com/ca](https://volvocars.com/ca) [<https://volvocars.com/ca>]. You may also write us at:

Volvo Car Canada Ltd.

Customer Care Centre

9130 Leslie Street, Suite 101

Richmond Hill, Ontario L4B 0B9

You can also search for manufacturer, model and model year on Transport Canada's website:

[www.tc.gc.ca](http://www.tc.gc.ca)

---

## 3.7. Occupant safety

Safety is Volvo's cornerstone.

### Volvo's concern for safety

Our concern for safety dates back to 1927 when the first Volvo rolled off the production line. Three-point seat belts (a Volvo invention), safety cages, and energy-absorbing impact zones were designed into Volvo vehicles long before it was fashionable or required by government regulation.

We will not compromise our commitment to safety. We continue to seek out new safety features and to refine those already in our vehicles. You can help. We would appreciate hearing your suggestions about improving automobile safety. We also want to know if you ever have a safety concern with your vehicle. Call us in the U.S. at: 1-800-458-1552 or in Canada at: 1-800-663-8255.

#### Occupant safety reminders

How safely you drive doesn't depend on how old you are but rather on:

- How well you see.
- Your ability to concentrate.
- How quickly you make decisions under stress to avoid an accident.

The following suggestions are intended to help you cope with the ever changing traffic environment.

- Never drink and drive.
- If you are taking any medication, consult your physician about its potential effects on your driving abilities.
- Take a driver-retraining course.
- Have your eyes checked regularly.
- Keep your windshield and headlights clean.
- Replace wiper blades when they start to leave streaks.

**The content of this manual represents the status of the user manual at the time of printing and may not be completely valid in future instances. For more information refer to the first page for the complete disclaimer note.**

- Take into account the traffic, road, and weather conditions, particularly with regard to stopping distance.
  - Never text while driving.
  - Refrain from using or minimize the use of a cell phone while driving.
- 

## 3.8. Safety during pregnancy

It is important that seat belts are worn correctly during pregnancy and that pregnant drivers adjust their seating position accordingly.

### Seat belt

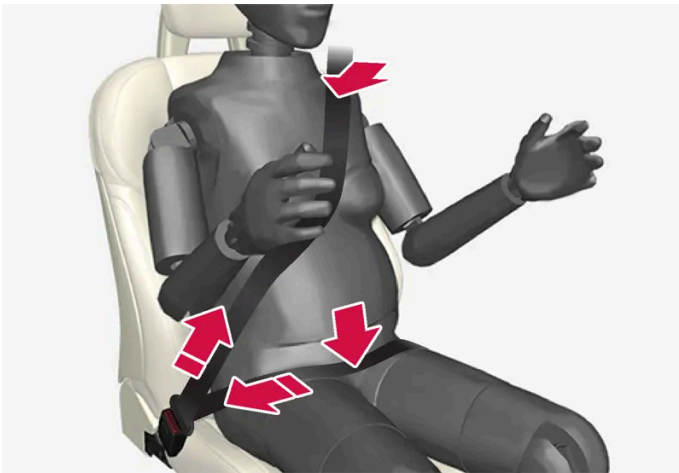

The seat belt should fit closely against the shoulder, with the diagonal section between the breasts and to the side of the stomach.

The lap section of the seat belt should lie flat over the thighs and as far as possible under the stomach. Never let it ride upward. Remove unnecessary slack and make sure the seat belt fits as close as possible to the body. Make sure there are no twists in the seat belt.

### Seating position

As pregnancy progresses, pregnant drivers should adjust the seat and steering wheel to a position that allows them to retain full control of the vehicle (which means they should be able to easily reach the steering wheel and foot pedals). Try to maintain as much distance as possible between the stomach and the steering wheel.

---

## 3.9. Reporting safety defects

The following information will help you report any perceived safety-related defects in your vehicle.

### Reporting safety defects in the U.S.

If you believe that your vehicle has a defect which could cause a crash or could cause injury or death, you should immediately inform the National Highway Traffic Safety Administration (NHTSA) in addition to notifying Volvo Car USA, LLC. If NHTSA receives similar complaints, it may open an investigation, and if it finds that a safety defect exists in a group of vehicles, it may order a recall and remedy campaign. However, NHTSA cannot become involved in individual problems between you, your retailer, or Volvo Car USA, LLC. To contact NHTSA, you may either call the Auto Safety Hotline tollfree at

1-888-327-4236

(TTY: 1-800-424-9153) or write to: NHTSA Headquarters, 1200 New Jersey Avenue SE., West Building, Washington D.C. 20590.

You can also obtain other information about motor vehicle safety from <http://www.safercar.gov>, where you can also enter your vehicle's VIN (Vehicle Identification Number) to see if it has any open recalls.

Volvo strongly recommends that if your vehicle is covered under a service campaign, safety or emission recall or similar action, it should be completed as soon as possible. Please check with your local retailer or Volvo Car USA, LLC if your vehicle is covered under these conditions.

NHTSA can be reached at:

Internet:

<http://www.nhtsa.gov>

Telephone:

1-888-327-4236

## Reporting safety defects in Canada

If you believe your vehicle has a defect that could cause a crash or could cause injury or death, you should immediately inform Transport Canada in addition to notifying Volvo Car Canada Ltd.

**Transport Canada can be contacted at:**

1-866-995-9737

Teletypewriter (TTY): 1-888-675-6863

Fax: 613-954-4731

Mailing Address: Transport Canada - 330 Sparks St, Ottawa, (Ontario) K1A 0N5

[www.tc.gc.ca](http://www.tc.gc.ca)

---

## 3.10. Whiplash Protection System

The Whiplash Protection System (WHIPS) is designed to help reduce the risk of whiplash-type injuries. The system consists of energy absorbing backrests and seat cushions as well as specially designed head

The content of this manual represents the status of the user manual at the time of printing and may not be completely valid in future instances. For more information refer to the first page for the complete disclaimer note.

restraints in the front seats.

WHIPS is activated in the event of a rear-end collision and adapted to the angle and speed of the collision and to the characteristics of the colliding vehicle.

When WHIPS is activated, the front seat backrests move rearward and the seat cushions move downward to change the seating positions of the driver and front seat passenger. This movement helps absorb some of the forces that could result in whiplash.

 **Warning**

WHIPS is a supplement to the seat belt. Always wear your seat belt.

 **Warning**

Do not attempt to alter or repair the seat or WHIPS on your own. Volvo recommends contacting an authorized Volvo workshop.

If the front seats have been subjected to severe stress, e.g. in a collision, the seats must be replaced. Even if the seats appear undamaged, some of their protective properties may have been lost.

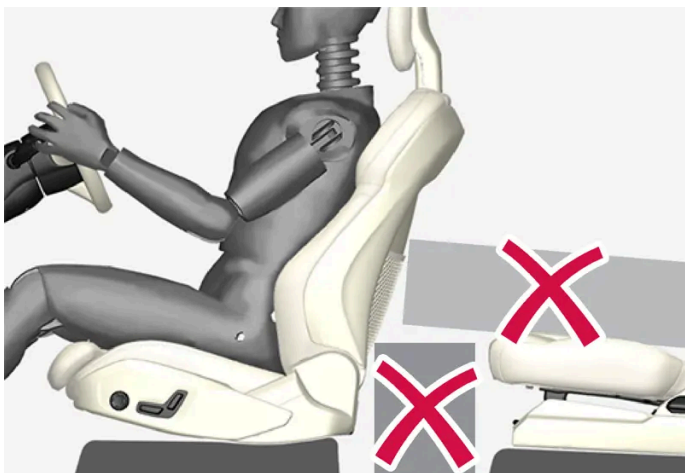

Do not place any objects on the floor behind or under the front seats or on the rear seat that could prevent WHIPS from functioning correctly.

 **Warning**

Do not squeeze box-like cargo between the rear seat cushion and the front seat backrest.

If the rear seat backrests are folded down, cargo must be secured to prevent it from sliding forward against the front seat backrests in the event of a collision.

 **Warning**

If a rear seat backrest is folded down or if a rear-facing child restraint is being used in the rear seat, the seat in front must be moved forward so that it does not come into contact with the backrest or child restraint.

## Seating position

For WHIPS to provide good protection, the driver and passenger must be seated correctly and the system's function must not be impeded in any way.

Set the front seat to the correct seating position before starting to drive.

The driver and the front seat passenger should sit in the center of the seat with their heads as close as possible to the head restraints.

---

## 4. Displays and voice control

---

### 4.1. Instrument panel

---

#### 4.1.1. Gauges and indicators in the instrument panel

---

##### 4.1.1.1. Fuel gauge

The fuel gauge in the instrument panel shows the fuel level in the tank.

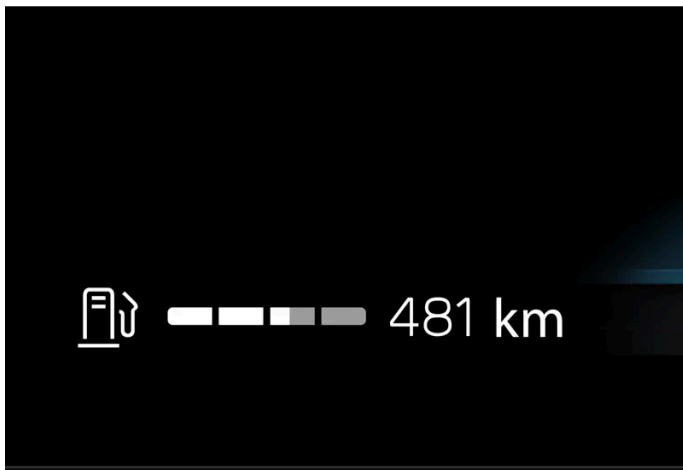

The white area in the fuel gauge indicates the amount of fuel left in the tank.

When the fuel level is low, the fuel pump symbol will illuminate with an amber-colored light. Distance to empty is also indicated in the fuel gauge.

##### Distance to empty tank

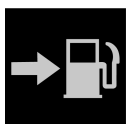

The trip computer calculates how far you can drive on the fuel remaining in the tank.

This calculation is based on average fuel consumption during the last 30 km (20 miles) and the amount of fuel remaining in the tank.

When the gauge displays "----", there is not enough fuel remaining to calculate the remaining mileage. Refuel as soon as possible.

 **Note**

The information will change based on your driving style.

An economical driving style will generally increase how far you can drive on a certain amount of fuel.

---

## 4.1.1.2. Ambient temperature sensor

The temperature outside the vehicle is displayed in the instrument panel. If the vehicle has been stationary for a prolonged period of time, the gauge may show a higher temperature than the actual temperature.



When the temperature outside the vehicle is between  $-5^{\circ}\text{C}$  ( $23^{\circ}\text{F}$ ) and  $+2^{\circ}\text{C}$  ( $36^{\circ}\text{F}$ ), a snowflake symbol will illuminate to alert the driver of the risk of slippery conditions.

### Temperature gauge settings

- 1 Tap .
- 2 Select **System**.
- 3 Tap **Units**.
- 4 Adjust desired settings.

---

## 4.1.2. Trip computer

### 4.1.2.1. Trip computer

The vehicle's trip computer registers data while driving, such as mileage, average consumption and average speed.

## Information in the trip computer

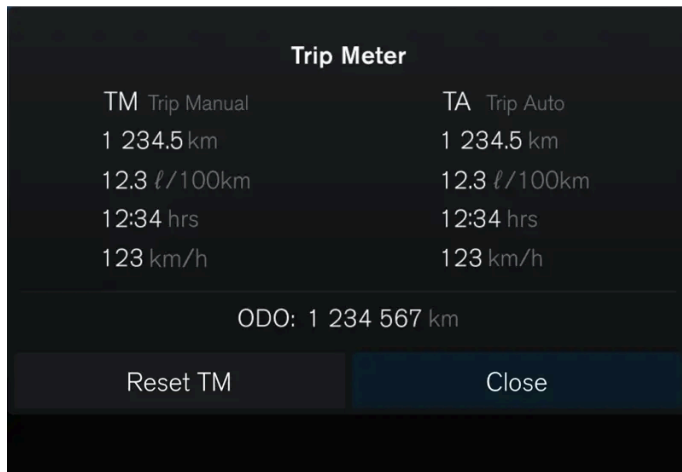

The trip computer shows the following values:

- Mileage
- Average consumption
- Driving time
- Average speed

### Opening the trip computer

- 1 Press the  button on the steering wheel.
  - > The trip computer opens.

### Trip odometer

There are two trip odometers: TM and TA.

TM can be reset manually and TA is reset automatically if the vehicle is not used for four hours.

### Odometer

The odometer records the vehicle's total mileage. This reading cannot be reset.

## Trip computer settings

Settings for the trip computer are adjusted via the center display.

- 1 Tap .
- 2 Select **Controls**.



- 3 Adjust desired settings.

---

## 4.1.2.2. Resetting the trip odometer

The trip odometer can be reset in the instrument panel or by using the left-side steering wheel lever.

Reset all information in the trip odometer (mileage, average consumption, average speed and driving time).

### Resetting in the instrument panel

- 1 Press the **O** button on the steering wheel.
  - 2 Select **Reset TM** using the buttons on the steering wheel.
  - 3 Confirm with the **O** button to reset.
- The trip odometer is reset.

### Resetting using the steering wheel lever



- 1 Press and hold down the **RESET** button on the steering wheel lever.
- The trip odometer is reset.

## 4.1.3. Instrument panel

The instrument panel displays information related to the vehicle and driving.

The instrument panel includes gauges, driver support functions and indicator and warning symbols. What is shown in the instrument panel varies depending on the equipment, settings and functions currently active.

The instrument panel is activated as soon as a door is opened. The panel will power down after a short period of time if it is not used. To reactivate it, do one of the following:

- Activate ignition mode I.
- Open one of the doors.

### Warning

If the instrument panel turns off, does not activate when the ignition is switched on, or part/all of the panel cannot be read, do not drive the vehicle. Consult a workshop immediately. Volvo recommends an authorized Volvo workshop.

### Warning

If the instrument panel is not functioning properly, information about brakes, airbags or other safety-related systems may not be displayed. The driver will then not be able to check the status of the vehicle systems or receive relevant warnings and information.

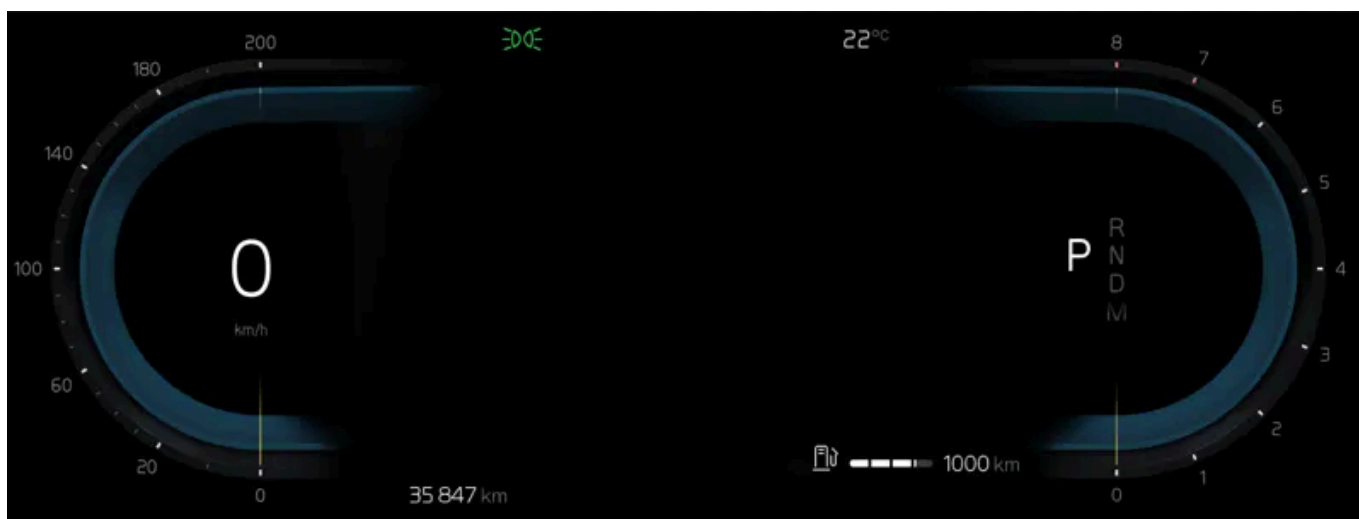

Location in the instrument panel:

Left side	In the center	Right side
Indicator and warning symbols	Indicator and warning symbols	Indicator and warning symbols
Speedometer	Temperature	Tachometer
Cruise control/speed limiter information	Messages (also graphics in some cases)	Drive Mode
Trip odometer	Door and seat belt status	Selected direction of travel
–	Driver support system	Regenerative braking <sup>[1]</sup>

The content of this manual represents the status of the user manual at the time of printing and may not be completely valid in future instances. For more information refer to the first page for the complete disclaimer note.

Left side	In the center	Right side
-	App menu (activated using steering wheel keypad)	Fuel gauge

[1] Mild hybrid only.

## 4.1.4. Instrument panel settings

Change display mode or adjust display settings for the instrument panel.

### App menu

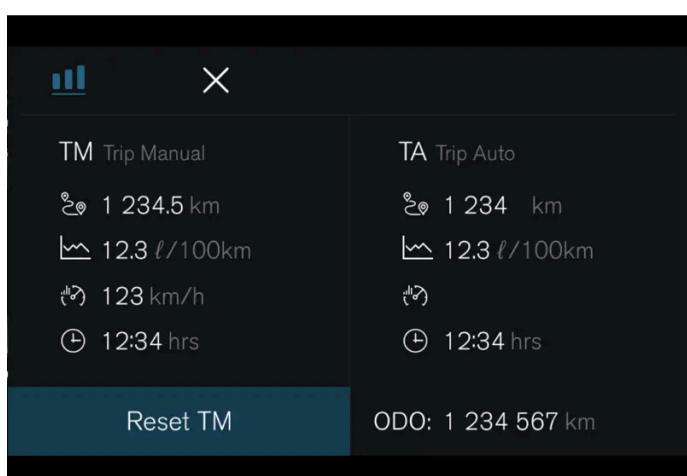

 – Information about trip odometer, odometer, etc.

### Managing the App menu

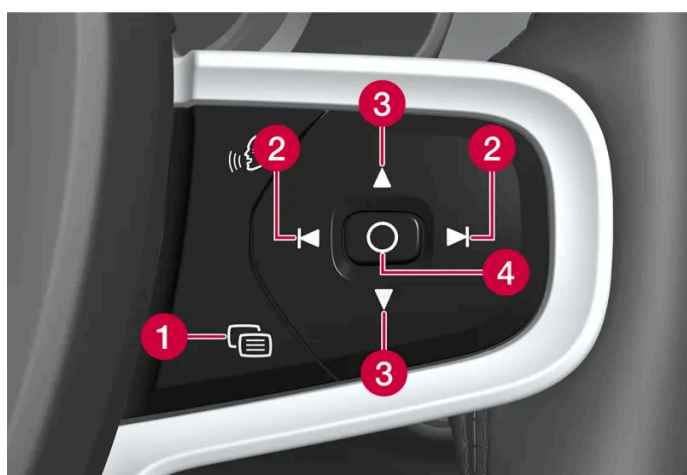

- 1 Close menu/change display mode
- 2 Left/right
- 3 Up/down
- 4 Open menu/confirm

The content of this manual represents the status of the user manual at the time of printing and may not be completely valid in future instances. For more information refer to the first page for the complete disclaimer note.

The App menu turns off after a period of inactivity or after certain selections are made.

## Display modes

The instrument panel has two different display modes, which can be changed using the  button on the right-side steering wheel keypad.

- Calm – the center part of the instrument panel is empty.
- Navigation\* – a map is displayed over the entire instrument panel.

## Center display settings

Instrument panel settings are adjusted via the center display.

- 1 Tap .
- 2 Select **Controls**.
- 3 Adjust desired settings.

The settings are personal and saved in the active user profile.

## Alternative speedometer

The alternative speedometer makes it easier to drive in countries where speed limit signs are shown in a different measurement unit than the one usually shown in the vehicle.

When the driver changes unit to display the speedometer in e.g. km/h a smaller speedometer is displayed digitally in mph above the standard speedometer and vice versa.

\* Option/accessory.

---

## 4.1.5. License agreement for instrument panel

A license is an agreement on the right to conduct a certain activity or the right to use someone else's right according to terms and conditions specified in the agreement. The following text is Volvo's agreement with the manufacturer or developer.

### 1.1 List of used Open Source Components

This table contains a list of open source software (OSS) components used within the product under the terms of the respective licenses. The source code corresponding to the open source components is also provided along with the product wherever mandated by the respective OSS license

SI No.	Name of OSS Component	Version of OSS Component	Name and Version of License (License text can be found in Appendix below)	Home Page	More Information
1	BidiReferenceCpp	26	Unicode Terms of Use	<a href="http://www.unicode.org/Public/PR/OGRAMS/BidiReferenceCpp/">http://www.unicode.org/Public/PR/OGRAMS/BidiReferenceCpp/</a>	(C) Socionext Embedded Software Austria GmbH (SESA) Copyright (C) 1999-2009, ASMUS, Inc
2	FASTCRC32	1.2.8	License of Stephan brumme/ Zlib style License	<a href="http://stephan-brumme.com/">http://stephan-brumme.com/</a>	Copyright © 2011-2013 Stephan Brumme. All rights reserved, Copyright (C) 1995-2006, 2010, 2011, 2012 Mark Adler
3	Freescale IMX6 HDMI	5.0.11	BSD 3-clause "New" or "Revised" License	<a href="https://www.nxp.com/">https://www.nxp.com/</a> [ <a href="https://www.nxp.com/">https://www.nxp.com/</a> ]	Copyright © 2009-2012, Freescale Semiconductor, Inc, Copyright © 2010-2012, Freescale Semiconductor, Inc.
4	FreeType Hashing	2.6.3	MIT License	<a href="https://sourceforge.net/p/canvasdraw/cd/642/tree/trunk/freetype/include/freetype/internal/ftstash.h">https://sourceforge.net/p/canvasdraw/cd/642/tree/trunk/freetype/include/freetype/internal/ftstash.h</a> [ <a href="https://sourceforge.net/p/canvasdraw/cd/642/tree/trunk/freetype/include/freetype/internal/ftstash.h">https://sourceforge.net/p/canvasdraw/cd/642/tree/trunk/freetype/include/freetype/internal/ftstash.h</a> ]	Copyright 2000 Computing Research Labs, New Mexico State University Copyright 2001-2015 Francesco Zappa Nardelli
5	Freetype Project - BDF	2.6.3	MIT License	<a href="https://sourceforge.net/projects/freetype/files/freetype2/2.6.3/">https://sourceforge.net/projects/freetype/files/freetype2/2.6.3/</a> [ <a href="https://www.freetype.org/">https://www.freetype.org/</a> ]	Copyright (C) 2001-2014 by Francesco Zappa Nardelli. Copyright 2000 Computing Research Labs, New Mexico State University
6	Freetype Project - PCF	2.6.3	MIT License	<a href="https://sourceforge.net/projects/freetype/files/freetype2/2.6.3/">https://sourceforge.net/projects/freetype/files/freetype2/2.6.3/</a> [ <a href="https://www.freetype.org/">https://www.freetype.org/</a> ]	Copyright 2000-2001, 2003 by Francesco Zappa Nardelli Copyright (C) 2000, 2001, 2002, 2003, 2006, 2010 by Francesco Zappa Nardelli Copyright (C) 2000-2004, 2006-2011, 2013, 2014 by Francesco Zappa Nardelli Copyright 2000-2010, 2012-2014 by Francesco Zappa Nardelli Copyright 2003 by Francesco Zappa Nardelli
7	Freetype Project - Pcfutil	2.6.3	Open Group License	<a href="https://sourceforge.net/projects/freetype/files/freetype2/2.6.3/">https://sourceforge.net/projects/freetype/files/freetype2/2.6.3/</a> [ <a href="https://www.freetype.org/">https://www.freetype.org/</a> ]	Copyright 1990, 1994, 1998 The Open Group
8	HarfBuzz	1.3.1	MIT License	<a href="http://freedesktop.org/wiki/Software/HarfBuzz">http://freedesktop.org/wiki/Software/HarfBuzz</a>	Copyright © 2007 Chris Wilson Copyright © 2009, 2010 Red Hat, Inc. Copyright © 2011, 2012 Google, Inc.
9	Integrity Libnet	1.16	Internet Software Consortium-IBM License ISC License	<a href="https://github.com/lattera/glibc/blob/master/resolv/inetpton.c">https://github.com/lattera/glibc/blob/master/resolv/inetpton.c</a> [ <a href="https://github.com/lattera/glibc/blob/master/resolv/inetpton.c">https://github.com/lattera/glibc/blob/master/resolv/inetpton.c</a> ]	Copyright © 1996 by Internet Software Consortium. Consortium, Copyright © 1995 by International Business Machines, Inc.

SI No.	Name of OSS Component	Version of OSS Component	Name and Version of License (License text can be found in Appendix below)	Home Page	More Information
10	Khronos EGL Headers	1.4	MIT License	<a href="http://www.khronos.org/registry/egl/">http://www.khronos.org/registry/egl/</a>	Copyright © 2007-2013 The Khronos Group Inc. Copyright 2008 VMware, Inc. Copyright © 2013-2014 The Khronos Group Inc.
11	Khronos Group - OpenGL ES	2.0	SGI Free Software License B v2.0	<a href="http://www.khronos.org/opengles/">http://www.khronos.org/opengles/</a>	
12	libjpeg	6b	Independent JPEG Group License	<a href="http://www.ijg.org/">http://www.ijg.org/</a>	Copyright (C) 1991-1998, Thomas G. Lane.
13	libpng	1.4.22	libpng License	<a href="http://github.com/coapp-package/s/libpng/">http://github.com/coapp-package/s/libpng/</a>	Copyright © 1998-2010 Glenn Randers-Pehrson Copyright © 2007, 2009 Glenn Randers-Pehrson Version 0.96 Copyright © 1996, 1997 Andreas Dilger Version 0.88 Copyright © 1995, 1996 Guy Eric Schalnat, Group 42, Inc.
14	Libunibreak	1.2.8	zlib License	<a href="https://github.com/adah1972/libunibreak">https://github.com/adah1972/libunibreak</a> [ <a href="https://github.com/adah1972/libunibreak">https://github.com/adah1972/libunibreak</a> ]	Copyright (C) 2008-2011 Wu Yongwei Copyright (C) 2012 Tom Hacohen <a href="mailto:tom@stosb.com">tom@stosb.com</a>
15	lz4 Compression algorithm	1.4.0	BSD 2-clause "Simplified" License	<a href="http://github.com/Cyan4973/lz4/">http://github.com/Cyan4973/lz4/</a>	Copyright (C) 2011-2014, Yann Collet
16	md5	1.6	Public Domain	<a href="https://doxygen.reactos.org/d7/d04/sdk_2lib_23rdparty_2freetype_2src_2base_2md5_8c_source.html">https://doxygen.reactos.org/d7/d04/sdk_2lib_23rdparty_2freetype_2src_2base_2md5_8c_source.html</a> [ <a href="https://doxygen.reactos.org/d7/d04/sdk_2lib_23rdparty_2freetype_2src_2base_2md5_8c_source.html">https://doxygen.reactos.org/d7/d04/sdk_2lib_23rdparty_2freetype_2src_2base_2md5_8c_source.html</a> ]	
17	NetBSD	1.9	HPND like license IBM License BSD-4-Clause (University of California-Specific) BSD 3-clause "New" or "Revised" License BSD One Clause License	<a href="http://www.netbsd.org/">http://www.netbsd.org/</a>	Copyright © 1998 Manuel Bouyer Copyright © 1996 Matt Thomas. Copyright 1997 Marshall Kirk McKusick. All Rights Reserved, Copyright © 1985, 1988, 1989, 1991, 1993, 1995 The Regents of the University of California Copyright © 1989, 1993 The Regents of the University of California Copyright © 1983, 1993 The Regents of the University of California Copyright 2000-2011 Green Hills Software Copyright (c) 1996 by Internet Software Consortium. Copyright (C) 1998 WIDE Project, Portions Copyright © 1995 by International Business Machines, Inc, Copyright (C) 1994, 1995, 1997 TooLs GmbH Copyright (C) 1994, 1995, 1997 Wolfgang Solfrank Copyright © 1995, 1999 Berkeley Software Design, Inc Portions Copyright © 1993 by Digital Equipment Corporation Copyright © 1992 Henry Spencer Copyright © 1997, 1998, 1999 The NetBSD Foundation, Inc Copyright © 1996 by Internet Software Consortium. Copyright (c) 1994 James A. Jegers(c) © UNIX System Laboratories, Inc.
18	NetBSD_BSD4	1.9	BSD 4-clause "Original" or "Old" License	<a href="http://www.netbsd.org/">http://www.netbsd.org/</a>	Copyright 2000-2011, 2000-2013 Green Hills Software, Copyright © 1994, 1998 Christopher G. Demetriou, Copyright © 1982, 1986, 1990, 1993, 1994 The Regents of the University of California. All rights reserved. © UNIX System Laboratories, Inc.

SI No.	Name of OSS Component	Version of OSS Component	Name and Version of License (License text can be found in Appendix below)	Home Page	More Information
19	The FreeType Project - freetype2	2.6.3	Freetype Project License	<a href="http://sourceforge.net/projects/freetype/">http://sourceforge.net/projects/freetype/</a>	Copyright 1996-2016 by David Turner, Robert Wilhelm, and Werner Lemberg, Copyright 2007-2016 by Rahul Bhalaria, Copyright 2009-2016 by Oran Agra and Mickey Gabel, Copyright 2008-2016 by David Turner, Robert Wilhelm, Werner Lemberg, and suzuki toshiya. Copyright 2000 Computing Research Labs, New Mexico State University, Copyright 2001-2015 Francesco Zappa Nardelli, Copyright 2004-2016 by Masatake YAMATO and Redhat K.K, Copyright 2007-2016 by Derek Clegg and Michael Toftdal, Copyright 2010-2016 by Joel Klinghed, Copyright 2007-2013 Adobe Systems Incorporated, Copyright 2007-2014 Adobe Systems Incorporated, Copyright 2004-2016 by Albert Chin-A-Young, Copyright 2013-2016 by Google, Inc, Copyright 2002-2016 by Roberto Alameda, Copyright 2003 Huw D M Davies for Codeweavers, Copyright 2007 Dmitry Timoshkov for Codeweavers
20	Vivante Driver software	viv5.0.1p7.4.i3	MIT License	<a href="http://www.vivante.com/">http://www.vivante.com/</a>	Copyright 2012 - 2016 Vivante Corporation, Santa Clara, California Copyright © 2007 The Khronos Group Inc Copyright © 2014 - 2016 Vivante Corporation Copyright 2012 Vivante Corporation, Sunnyvale, California Copyright © 2011 Intel Corporation Copyright (C) 1999-2001 Brian Paul
21	zlib	1.2.8	zlib License	<a href="http://www.zlib.net/">http://www.zlib.net/</a>	Copyright (C) 1995-2007 Mark Adler Copyright (C) 1995-2005 Jean-loup Gailly Copyright (C) 1995-2012 Mark Adler Copyright (C) 2003 Chris Anderson Copyright (C) 1998 Brian Raiter
22	RBTree.cpp	3.4.2	Public Domain	<a href="https://www.eu.socionext.com/">https://www.eu.socionext.com/</a>	(C) Socionext Embedded Software Austria GmbH (SESA)

## 2. APPENDIX - LICENSE TEXT

### 2.1 HPND Like license

Portions Copyright (c) 1993 by Digital Equipment Corporation.

Permission to use, copy, modify, and distribute this software for any purpose with or without fee is hereby granted, provided that the above copyright notice and this permission notice appear in all copies, and that the name of Digital Equipment Corporation not be used in advertising or publicity pertaining to distribution of the document or software without specific, written prior permission.

THE SOFTWARE IS PROVIDED "AS IS" AND DIGITAL EQUIPMENT CORP. DISCLAIMS ALL WARRANTIES WITH REGARD TO THIS SOFTWARE, INCLUDING ALL IMPLIED WARRANTIES OF MERCHANTABILITY AND FITNESS. IN NO EVENT SHALL DIGITAL EQUIPMENT CORPORATION BE LIABLE FOR ANY SPECIAL, DIRECT, INDIRECT, OR CONSEQUENTIAL DAMAGES OR ANY DAMAGES WHATSOEVER RESULTING FROM LOSS OF USE, DATA OR PROFITS, WHETHER IN AN ACTION OF CONTRACT, NEGLIGENCE OR OTHER TORTIOUS ACTION, ARISING OUT OF OR IN CONNECTION WITH THE USE OR PERFORMANCE OF THIS SOFTWARE.

### 2.2 BSD 2-clause "Simplified" License

BSD Two Clause License

Redistribution and use in source and binary forms, with or without modification, are permitted provided that the following conditions are met: Redistributions of source code must retain the above copyright notice, this list of conditions and the following disclaimer. Redistributions in binary form must reproduce the above copyright notice, this list of conditions and the following disclaimer in the documentation and/or other materials provided with the distribution.

THIS SOFTWARE IS PROVIDED BY THE AUTHOR "AS IS" AND ANY EXPRESS OR IMPLIED WARRANTIES, INCLUDING, BUT NOT LIMITED TO, THE IMPLIED WARRANTIES OF MERCHANTABILITY AND FITNESS FOR A PARTICULAR PURPOSE

The content of this manual represents the status of the user manual at the time of printing and may not be completely valid in future instances. For more information refer to the first page for the complete disclaimer note.

ARE DISCLAIMED. IN NO EVENT SHALL THE AUTHOR BE LIABLE FOR ANY DIRECT, INDIRECT, INCIDENTAL, SPECIAL, EXEMPLARY, OR CONSEQUENTIAL DAMAGES (INCLUDING, BUT NOT LIMITED TO, PROCUREMENT OF SUBSTITUTE GOODS OR SERVICES; LOSS OF USE, DATA, OR PROFITS; OR BUSINESS INTERRUPTION) HOWEVER CAUSED AND ON ANY THEORY OF LIABILITY, WHETHER IN CONTRACT, STRICT LIABILITY, OR TORT (INCLUDING NEGLIGENCE OR OTHERWISE) ARISING IN ANY WAY OUT OF THE USE OF THIS SOFTWARE, EVEN IF ADVISED OF THE POSSIBILITY OF SUCH DAMAGE.

### **2.3 IBM License**

Portions Copyright (c) 1995 by International Business Machines, Inc.

International Business Machines, Inc. (hereinafter called IBM) grants permission under its copyrights to use, copy, modify, and distribute this Software with or without fee, provided that the above copyright notice and all paragraphs of this notice appear in all copies, and that the name of IBM not be used in connection with the marketing of any product incorporating the Software or modifications thereof, without specific, written prior permission.

To the extent it has a right to do so, IBM grants an immunity from suit under its patents, if any, for the use, sale or manufacture of products to the extent that such products are used for performing Domain Name System dynamic updates in TCP/IP networks by means of the Software. No immunity is granted for any product per se or for any other function of any product.

THE SOFTWARE IS PROVIDED "AS IS", AND IBM DISCLAIMS ALL WARRANTIES, INCLUDING ALL IMPLIED WARRANTIES OF MERCHANTABILITY AND FITNESS FOR A PARTICULAR PURPOSE. IN NO EVENT SHALL IBM BE LIABLE FOR ANY SPECIAL, DIRECT, INDIRECT, OR CONSEQUENTIAL DAMAGES OR ANY DAMAGES WHATSOEVER ARISING OUT OF OR IN CONNECTION WITH THE USE OR PERFORMANCE OF THIS SOFTWARE, EVEN IF IBM IS APPRISED OF THE POSSIBILITY OF SUCH DAMAGES.

### **2.4 BSD 3-clause "New" or "Revised" License**

Copyright/Copyright holders – see List of Open Source Components

All rights reserved.

Redistribution and use in source and binary forms, with or without modification, are permitted provided that the following conditions are met:

Redistributions of source code must retain the above copyright notice, this list of conditions and the following disclaimer. Redistributions in binary form must reproduce the above copyright notice, this list of conditions and the following disclaimer in the documentation and/or other materials provided with the distribution. Neither the name of the [ORGANIZATION] nor the names of its contributors may be used to endorse or promote products derived from this software without specific prior written permission.

THIS SOFTWARE IS PROVIDED BY THE COPYRIGHT HOLDERS AND CONTRIBUTORS "AS IS" AND ANY EXPRESS OR IMPLIED WARRANTIES, INCLUDING, BUT NOT LIMITED TO, THE IMPLIED WARRANTIES OF MERCHANTABILITY AND FITNESS FOR A PARTICULAR PURPOSE ARE DISCLAIMED. IN NO EVENT SHALL THE COPYRIGHT OWNER OR CONTRIBUTORS BE LIABLE FOR ANY DIRECT, INDIRECT, INCIDENTAL, SPECIAL, EXEMPLARY, OR CONSEQUENTIAL DAMAGES (INCLUDING, BUT NOT LIMITED TO, PROCUREMENT OF SUBSTITUTE GOODS OR SERVICES; LOSS OF USE, DATA, OR PROFITS; OR BUSINESS INTERRUPTION) HOWEVER CAUSED AND ON ANY THEORY OF LIABILITY, WHETHER IN CONTRACT, STRICT LIABILITY, OR TORT (INCLUDING NEGLIGENCE OR OTHERWISE) ARISING IN ANY WAY OUT OF THE USE OF THIS SOFTWARE, EVEN IF ADVISED OF THE POSSIBILITY OF SUCH DAMAGE.

### **2.5 BSD 4-clause "Original" or "Old" License**

Copyright/Copyright holders – see List of Open Source Components

All rights reserved.



Redistribution and use in source and binary forms, with or without modification, are permitted provided that the following conditions are met:

1. Redistributions of source code must retain the above copyright notice, this list of conditions and the following disclaimer.
2. Redistributions in binary form must reproduce the above copyright notice, this list of conditions and the following disclaimer in the documentation and/or other materials provided with the distribution.
3. All advertising materials mentioning features or use of this software must display the following acknowledgement: This product includes software developed by the organization.
4. Neither the name of the organization nor the names of its contributors may be used to endorse or promote products derived from this software without specific prior written permission.

THIS SOFTWARE IS PROVIDED BY COPYRIGHT HOLDER "AS IS" AND ANY EXPRESS OR IMPLIED WARRANTIES, INCLUDING, BUT NOT LIMITED TO, THE IMPLIED WARRANTIES OF MERCHANTABILITY AND FITNESS FOR A PARTICULAR PURPOSE ARE DISCLAIMED. IN NO EVENT SHALL {{COPYRIGHT HOLDER}} BE LIABLE FOR ANY DIRECT, INDIRECT, INCIDENTAL, SPECIAL, EXEMPLARY, OR CONSEQUENTIAL DAMAGES (INCLUDING, BUT NOT LIMITED TO, PROCUREMENT OF SUBSTITUTE GOODS OR SERVICES; LOSS OF USE, DATA, OR PROFITS; OR BUSINESS INTERRUPTION) HOWEVER CAUSED AND ON ANY THEORY OF LIABILITY, WHETHER IN CONTRACT, STRICT LIABILITY, OR TORT (INCLUDING NEGLIGENCE OR OTHERWISE) ARISING IN ANY WAY OUT OF THE USE OF THIS SOFTWARE, EVEN IF ADVISED OF THE POSSIBILITY OF SUCH DAMAGE.

#### **2.6 BSD-4-Clause (University of California-Specific)**

BSD-4-Clause (University of California-Specific)

Copyright/Copyright holders – see List of Open Source Components

Redistribution and use in source and binary forms, with or without modification, are permitted provided that the following conditions are met:

1. Redistributions of source code must retain the above copyright notice, this list of conditions and the following disclaimer.
2. Redistributions in binary form must reproduce the above copyright notice, this list of conditions and the following disclaimer in the documentation and/or other materials provided with the distribution.
3. All advertising materials mentioning features or use of this software must display the following acknowledgement: This product includes software developed by the University of California, Berkeley and its contributors.
4. Neither the name of the University nor the names of its contributors may be used to endorse or promote products derived from this software without specific prior written permission.

THIS SOFTWARE IS PROVIDED BY THE REGENTS AND CONTRIBUTORS "AS IS" AND ANY EXPRESS OR IMPLIED WARRANTIES, INCLUDING, BUT NOT LIMITED TO, THE IMPLIED WARRANTIES OF MERCHANTABILITY AND FITNESS FOR A PARTICULAR PURPOSE ARE DISCLAIMED. IN NO EVENT SHALL THE REGENTS OR CONTRIBUTORS BE LIABLE FOR ANY DIRECT, INDIRECT, INCIDENTAL, SPECIAL, EXEMPLARY, OR CONSEQUENTIAL DAMAGES (INCLUDING, BUT NOT LIMITED TO, PROCUREMENT OF SUBSTITUTE GOODS OR SERVICES; LOSS OF USE, DATA, OR PROFITS; OR BUSINESS INTERRUPTION) HOWEVER CAUSED AND ON ANY THEORY OF LIABILITY, WHETHER IN CONTRACT, STRICT LIABILITY, OR TORT (INCLUDING NEGLIGENCE OR OTHERWISE) ARISING IN ANY WAY OUT OF THE USE OF THIS SOFTWARE, EVEN IF ADVISED OF THE POSSIBILITY OF SUCH DAMAGE.

#### **2.7 Freetype Project License**

The FreeType Project LICENSE

2006-Jan-27

The content of this manual represents the status of the user manual at the time of printing and may not be completely valid in future instances. For more information refer to the first page for the complete disclaimer note.

## Introduction

The FreeType Project is distributed in several archive packages; some of them may contain, in addition to the FreeType font engine, various tools and contributions which rely on, or relate to, the FreeType Project. This license applies to all files found in such packages, and which do not fall under their own explicit license. The license affects thus the FreeType font engine, the test programs, documentation and makefiles, at the very least. This license was inspired by the BSD, Artistic, and IJG (Independent JPEG Group) licenses, which all encourage inclusion and use of free software in commercial and freeware products alike. As a consequence, its main points are that:

We don't promise that this software works. However, we will be interested in any kind of bug reports. ('as is' distribution)

You can use this software for whatever you want, in parts or full form, without having to pay us. ('royalty-free' usage)

You may not pretend that you wrote this software. If you use it, or only parts of it, in a program, you must acknowledge somewhere in your documentation that you have used the FreeType code. ('credits')

We specifically permit and encourage the inclusion of this software, with or without modifications, in commercial products. We disclaim all warranties covering The FreeType Project and assume no liability related to The FreeType Project. Finally, many people asked us for a preferred form for a credit/disclaimer to use in compliance with this license. We thus encourage you to use the following text: "Portions of this software are copyright © 1996-2002, 2006 The FreeType Project ([www.freetype.org](http://www.freetype.org)). All rights reserved."

## Definitions

Throughout this license, the terms 'package', 'FreeType Project', and 'FreeType archive' refer to the set of files originally distributed by the authors (David Turner, Robert Wilhelm, and Werner Lemberg) as the 'FreeType Project', be they named as alpha, beta or final release. 'You' refers to the licensee, or person using the project, where 'using' is a generic term including compiling the project's source code as well as linking it to form a 'program' or 'executable'. This program is referred to as 'a program using the FreeType engine'. This license applies to all files distributed in the original FreeType Project, including all source code, binaries and documentation, unless otherwise stated in the file in its original, unmodified form as distributed in the original archive. If you are unsure whether or not a particular file is covered by this license, you must contact us to verify this.

## No Warranty

THE FREETYPE PROJECT IS PROVIDED 'AS IS' WITHOUT WARRANTY OF ANY KIND, EITHER EXPRESS OR IMPLIED, INCLUDING, BUT NOT LIMITED TO, WARRANTIES OF MERCHANTABILITY AND FITNESS FOR A PARTICULAR PURPOSE. IN NO EVENT WILL ANY OF THE AUTHORS OR COPYRIGHT HOLDERS BE LIABLE FOR ANY DAMAGES CAUSED BY THE USE OR THE INABILITY TO USE, OF THE FREETYPE PROJECT. Redistribution

## Redistribution

This license grants a worldwide, royalty-free, perpetual and irrevocable right and license to use, execute, perform, compile, display, copy, create derivative works of, distribute and sublicense the FreeType Project (in both source and object code forms) and derivative works thereof for any purpose; and to authorize others to exercise some or all of the rights granted herein, subject to the following conditions:

Redistribution of source code must retain this license file ('FTL.TXT') unaltered; any additions, deletions or changes to the original files must be clearly indicated in accompanying documentation. The copyright notices of the unaltered, original files must be preserved in all copies of source files. Redistribution in binary form must provide a disclaimer that states that the software is based in part of the work of the FreeType Team, in the distribution documentation. We also encourage you to put an URL to the FreeType web page in your documentation, though this isn't mandatory. These conditions apply to any software derived from or

based on the FreeType Project, not just the unmodified files. If you use our work, you must acknowledge us. However, no fee need be paid to us.

### **Advertising**

Neither the FreeType authors and contributors nor you shall use the name of the other for commercial, advertising, or promotional purposes without specific prior written permission. We suggest, but do not require, that you use one or more of the following phrases to refer to this software in your documentation or advertising materials: `FreeType Project', `FreeType Engine', `FreeType library', or `FreeType Distribution'. As you have not signed this license, you are not required to accept it. However, as the FreeType Project is copyrighted material, only this license, or another one contracted with the authors, grants you the right to use, distribute, and modify it. Therefore, by using, distributing, or modifying the FreeType Project, you indicate that you understand and accept all the terms of this license.

### **Contacts**

There are two mailing lists related to FreeType:

freetype@nongnu.org

Discusses general use and applications of FreeType, as well as future and wanted additions to the library and distribution. If you are looking for support, start in this list if you haven't found anything to help you in the documentation.

devel@nongnu.org

Discusses bugs, as well as engine internals, design issues, specific licenses, porting, etc.

Our home page can be found at: <http://www.freetype.org>

### **2.8 Independent JPEG Group License**

The Independent JPEG Group's JPEG software README for release 6b of 27-Mar-1998

This distribution contains the sixth public release of the Independent JPEG Group's free JPEG software. You are welcome to re-distribute this software and to use it for any purpose, subject to the conditions under LEGAL ISSUES, below. Serious users of this software (particularly those incorporating it into larger programs) should contact IJG at [jpeg-info@uunet.uu.net](mailto:jpeg-info@uunet.uu.net) to be added to our electronic mailing list. Mailing list members are notified of updates and have a chance to participate in technical discussions, etc. This software is the work of Tom Lane, Philip Gladstone, Jim Boucher, Lee Crocker, Julian Minguillon, Luis Ortiz, George Phillips, Davide Rossi, Guido Vollbeding, Ge' Weijers, and other members of the Independent JPEG Group. IJG is not affiliated with the official ISO JPEG standards committee.

### **LEGAL ISSUES**

In plain English:

We don't promise that this software works. (But if you find any bugs, please let us know!) You can use this software for whatever you want. You don't have to pay us. You may not pretend that you wrote this software. If you use it in a program, you must acknowledge somewhere in your documentation that you've used the IJG code.

In legalese:

The authors make NO WARRANTY or representation, either express or implied, with respect to this software, its quality, accuracy, merchantability, or fitness for a particular purpose. This software is provided "AS IS", and you, its user, assume the entire risk as to its quality and accuracy. This software is copyright (C) 1991-1998, Thomas G. Lane. All Rights Reserved except as specified below.

Permission is hereby granted to use, copy, modify, and distribute this software (or portions thereof) for any purpose, without fee, subject to these conditions:

1. If any part of the source code for this software is distributed, then this README file must be included, with this copyright and no-warranty notice unaltered; and any additions, deletions, or changes to the original files must be clearly indicated in accompanying documentation.
2. If only executable code is distributed, then the accompanying documentation must state that "this software is based in part on the work of the Independent JPEG Group".
3. Permission for use of this software is granted only if the user accepts full responsibility for any undesirable consequences; the authors accept NO LIABILITY for damages of any kind.

These conditions apply to any software derived from or based on the IJG code, not just to the unmodified library. If you use our work, you ought to acknowledge us.

Permission is NOT granted for the use of any IJG author's name or company name in advertising or publicity relating to this software or products derived from it. This software may be referred to only as "the Independent JPEG Group's software".

We specifically permit and encourage the use of this software as the basis of commercial products, provided that all warranty or liability claims are assumed by the product vendor. ansi2knr.c is included in this distribution by permission of L. Peter Deutsch, sole proprietor of its copyright holder, Aladdin Enterprises of Menlo Park, CA. ansi2knr.c is NOT covered by the above copyright and conditions, but instead by the usual distribution terms of the Free Software Foundation; principally, that you must include source code if you redistribute it. (See the file ansi2knr.c for full details.)

However, since ansi2knr.c is not needed as part of any program generated from the IJG code, this does not limit you more than the foregoing paragraphs do. The Unix configuration script "configure" was produced with GNU Autoconf. It is copyright by the Free Software Foundation but is freely distributable. The same holds for its supporting scripts (config.guess, config.sub, ltconfig, ltmain.sh). Another support script, install-sh, is copyright by M.I.T. but is also freely distributable.

It appears that the arithmetic coding option of the JPEG spec is covered by patents owned by IBM, AT&T, and Mitsubishi. Hence arithmetic coding cannot legally be used without obtaining one or more licenses. For this reason, support for arithmetic coding has been removed from the free JPEG software. (Since arithmetic coding provides only a marginal gain over the unpatented Huffman mode, it is unlikely that very many implementations will support it.) So far as we are aware, there are no patent restrictions on the remaining code.

The IJG distribution formerly included code to read and write GIF files. To avoid entanglement with the Unisys LZW patent, GIF reading support has been removed altogether, and the GIF writer has been simplified to produce "uncompressed GIFs". This technique does not use the LZW algorithm; the resulting GIF files are larger than usual, but are readable by all standard GIF decoders. We are required to state that:

"The Graphics Interchange Format(c) is the Copyright property of CompuServe Incorporated. GIF(sm) is a Service Mark property of CompuServe Incorporated."

## **2.9 Internet Software Consortium-IBM License**

Copyright (c) 1996 by Internet Software Consortium.

Permission to use, copy, modify, and distribute this software for any purpose with or without fee is hereby granted, provided that the above copyright notice and this permission notice appear in all copies.

THE SOFTWARE IS PROVIDED "AS IS" AND INTERNET SOFTWARE CONSORTIUM DISCLAIMS ALL WARRANTIES WITH REGARD TO THIS SOFTWARE INCLUDING ALL IMPLIED WARRANTIES OF MERCHANTABILITY AND FITNESS. IN NO EVENT SHALL INTERNET SOFTWARE CONSORTIUM BE LIABLE FOR ANY SPECIAL, DIRECT, INDIRECT, OR CONSEQUENTIAL DAMAGES OR ANY DAMAGES WHATSOEVER RESULTING FROM LOSS OF USE, DATA OR PROFITS,

WHETHER IN AN ACTION OF CONTRACT, NEGLIGENCE OR OTHER TORTIOUS ACTION, ARISING OUT OF OR IN CONNECTION WITH THE USE OR PERFORMANCE OF THIS SOFTWARE.

Portions Copyright (c) 1995 by International Business Machines, Inc.

International Business Machines, Inc. (hereinafter called IBM) grants permission under its copyrights to use, copy, modify, and distribute this Software with or without fee, provided that the above copyright notice and all paragraphs of this notice appear in all copies, and that the name of IBM not be used in connection with the marketing of any product incorporating the Software or modifications thereof, without specific, written prior permission.

To the extent it has a right to do so, IBM grants an immunity from suit under its patents, if any, for the use, sale or manufacture of products to the extent that such products are used for performing Domain Name System dynamic updates in TCP/IP networks by means of the Software. No immunity is granted for any product per se or for any other function of any product.

THE SOFTWARE IS PROVIDED "AS IS", AND IBM DISCLAIMS ALL WARRANTIES, INCLUDING ALL IMPLIED WARRANTIES OF MERCHANTABILITY AND FITNESS FOR A PARTICULAR PURPOSE. IN NO EVENT SHALL IBM BE LIABLE FOR ANY SPECIAL, DIRECT, INDIRECT, OR CONSEQUENTIAL DAMAGES OR ANY DAMAGES WHATSOEVER ARISING OUT OF OR IN CONNECTION WITH THE USE OR PERFORMANCE OF THIS SOFTWARE, EVEN IF IBM IS APPRISED OF THE POSSIBILITY OF SUCH DAMAGES.

#### **2.10 Khronos License**

Copyright (c) 2013 The Khronos Group Inc.

\*\* \*\* Permission is hereby granted, free of charge, to any person obtaining a \*\* copy of this software and/or associated documentation files (the \*\* "Materials"), to deal in the Materials without restriction, including \*\* without limitation the rights to use, copy, modify, merge, publish, \*\* distribute, sublicense, and/or sell copies of the Materials, and to \*\* permit persons to whom the Materials are furnished to do so, subject to \*\* the following conditions: \*\* \*\* The above copyright notice and this permission notice shall be included \*\* in all copies or substantial portions of the Materials. \*\*

\*\* THE MATERIALS ARE PROVIDED "AS IS", WITHOUT WARRANTY OF ANY KIND, \*\* EXPRESS OR IMPLIED, INCLUDING BUT NOT LIMITED TO THE WARRANTIES OF \*\* MERCHANTABILITY, FITNESS FOR A PARTICULAR PURPOSE AND NONINFRINGEMENT. \*\* IN NO EVENT SHALL THE AUTHORS OR COPYRIGHT HOLDERS BE LIABLE FOR ANY \*\* CLAIM, DAMAGES OR OTHER LIABILITY, WHETHER IN AN ACTION OF CONTRACT, \*\* TORT OR OTHERWISE, ARISING FROM, OUT OF OR IN CONNECTION WITH THE \*\* MATERIALS OR THE USE OR OTHER DEALINGS IN THE MATERIALS.

#### **2.11 License of Stephan Brumme/ Zlib style License**

This software is provided 'as-is', without any express or implied warranty. In no event will the author be held liable for any damages arising from the use of this software. Permission is granted to anyone to use this software for any purpose, including commercial applications, and to alter it and redistribute it freely, subject to the following restrictions: The origin of this software must not be misrepresented; you must not claim that you wrote the original software. If you use this software in a product, an acknowledgment in the product documentation would be appreciated but is not required. Altered source versions must be plainly marked as such, and must not be misrepresented as being the original software.

#### **2.12 MIT License**

The MIT License

Copyright/Copyright holders – see List of Open Source Components

Permission is hereby granted, free of charge, to any person obtaining a copy of this software and associated documentation files (the "Software"), to deal in the Software without restriction, including without limitation the rights to use, copy, modify, merge, publish, distribute, sublicense, and/or sell copies of the Software, and to permit persons to whom the Software is furnished to do so, subject to the following conditions:

**The content of this manual represents the status of the user manual at the time of printing and may not be completely valid in future instances. For more information refer to the first page for the complete disclaimer note.**

The above copyright notice and this permission notice shall be included in all copies or substantial portions of the Software.

THE SOFTWARE IS PROVIDED "AS IS", WITHOUT WARRANTY OF ANY KIND, EXPRESS OR IMPLIED, INCLUDING BUT NOT LIMITED TO THE WARRANTIES OF MERCHANTABILITY, FITNESS FOR A PARTICULAR PURPOSE AND NONINFRINGEMENT. IN NO EVENT SHALL THE AUTHORS OR COPYRIGHT HOLDERS BE LIABLE FOR ANY CLAIM, DAMAGES OR OTHER LIABILITY, WHETHER IN AN ACTION OF CONTRACT, TORT OR OTHERWISE, ARISING FROM, OUT OF OR IN CONNECTION WITH THE SOFTWARE OR THE USE OR OTHER DEALINGS IN THE SOFTWARE.

### **2.13 Open Group License**

Copyright 1996, 1998 The Open Group.

Permission to use, copy, modify, distribute, and sell this software and its documentation for any purpose is hereby granted without fee, provided that the above copyright notice appear in all copies and that both that copyright notice and this permission notice appear in supporting documentation. The above copyright notice and this permission notice shall be included in all copies or substantial portions of the Software.

THE SOFTWARE IS PROVIDED "AS IS", WITHOUT WARRANTY OF ANY KIND, EXPRESS OR IMPLIED, INCLUDING BUT NOT LIMITED TO THE WARRANTIES OF MERCHANTABILITY, FITNESS FOR A PARTICULAR PURPOSE AND NONINFRINGEMENT. IN NO EVENT SHALL THE OPEN GROUP BE LIABLE FOR ANY CLAIM, DAMAGES OR OTHER LIABILITY, WHETHER IN AN ACTION OF CONTRACT, TORT OR OTHERWISE, ARISING FROM, OUT OF OR IN CONNECTION WITH THE SOFTWARE OR THE USE OR OTHER DEALINGS IN THE SOFTWARE.

Except as contained in this notice, the name of The Open Group shall not be used in advertising or otherwise to promote the sale, use or other dealings in this Software without prior written authorization from The Open Group.

### **2.14 Public Domain**

Public domain code is not subject to any license.

### **2.15 BSD One Clause License**

BSD One Clause License

Copyright/Copyright holders – see List of Open Source Components

All rights reserved.

Redistribution and use in source and binary forms, with or without modification, are permitted provided that the following conditions are met:

\* Redistributions of source code must retain the above copyright notice, this list of conditions and the following disclaimer.

THIS SOFTWARE IS PROVIDED BY THE COPYRIGHT HOLDERS AND CONTRIBUTORS "AS IS" AND ANY EXPRESS OR IMPLIED WARRANTIES, INCLUDING, BUT NOT LIMITED TO, THE IMPLIED WARRANTIES OF MERCHANTABILITY AND FITNESS FOR A PARTICULAR PURPOSE ARE DISCLAIMED. IN NO EVENT SHALL THE COPYRIGHT OWNER OR CONTRIBUTORS BE LIABLE FOR ANY DIRECT, INDIRECT, INCIDENTAL, SPECIAL, EXEMPLARY, OR CONSEQUENTIAL DAMAGES (INCLUDING, BUT NOT LIMITED TO, PROCUREMENT OF SUBSTITUTE GOODS OR SERVICES; LOSS OF USE, DATA, OR PROFITS; OR BUSINESS INTERRUPTION) HOWEVER CAUSED AND ON ANY THEORY OF LIABILITY, WHETHER IN CONTRACT, STRICT LIABILITY, OR TORT (INCLUDING NEGLIGENCE OR OTHERWISE) ARISING IN ANY WAY OUT OF THE USE OF THIS SOFTWARE, EVEN IF ADVISED OF THE POSSIBILITY OF SUCH DAMAGE.

### **2.16 ISC License**

ISC License (ISCL)

The content of this manual represents the status of the user manual at the time of printing and may not be completely valid in future instances. For more information refer to the first page for the complete disclaimer note.

Copyright/Copyright holders – see List of Open Source Components

Permission to use, copy, modify, and/or distribute this software for any purpose with or without fee is hereby granted, provided that the above copyright notice and this permission notice appear in all copies.

THE SOFTWARE IS PROVIDED "AS IS" AND THE AUTHOR DISCLAIMS ALL WARRANTIES WITH REGARD TO THIS SOFTWARE INCLUDING ALL IMPLIED WARRANTIES OF MERCHANTABILITY AND FITNESS. IN NO EVENT SHALL THE AUTHOR BE LIABLE FOR ANY SPECIAL, DIRECT, INDIRECT, OR CONSEQUENTIAL DAMAGES OR ANY DAMAGES WHATSOEVER RESULTING FROM LOSS OF USE, DATA OR PROFITS, WHETHER IN AN ACTION OF CONTRACT, NEGLIGENCE OR OTHER TORTIOUS ACTION, ARISING OUT OF OR IN CONNECTION WITH THE USE OR PERFORMANCE OF THIS SOFTWARE.

## **2.17 SGI Free Software License B v2.0**

ISC License (ISCL)

Copyright/Copyright holders – see List of Open Source Components

Permission is hereby granted, free of charge, to any person obtaining a copy of this software and associated documentation files (the "Software"), to deal in the Software without restriction, including without limitation the rights to use, copy, modify, merge, publish, distribute, sublicense, and/or sell copies of the Software, and to permit persons to whom the Software is furnished to do so, subject to the following conditions:

The above copyright notice including the dates of first publication and either this permission notice or a reference to <http://oss.sgi.com/projects/FreeB/> shall be included in all copies or substantial portions of the Software.

THE SOFTWARE IS PROVIDED "AS IS" AND THE AUTHOR DISCLAIMS ALL WARRANTIES WITH REGARD TO THIS SOFTWARE INCLUDING ALL IMPLIED WARRANTIES OF MERCHANTABILITY AND FITNESS. IN NO EVENT SHALL THE AUTHOR BE LIABLE FOR ANY SPECIAL, DIRECT, INDIRECT, OR CONSEQUENTIAL DAMAGES OR ANY DAMAGES WHATSOEVER RESULTING FROM LOSS OF USE, DATA OR PROFITS, WHETHER IN AN ACTION OF CONTRACT, NEGLIGENCE OR OTHER TORTIOUS ACTION, ARISING OUT OF OR IN CONNECTION WITH THE USE OR PERFORMANCE OF THIS SOFTWARE.

Except as contained in this notice, the name of Silicon Graphics, Inc. shall not be used in advertising or otherwise to promote the sale, use or other dealings in this Software without prior written authorization from Silicon Graphics, Inc.

## **2.18 Unicode Terms of Use**

For the general privacy policy governing access to this site, see the Unicode Privacy Policy. For trademark usage, see the Unicode® Consortium Name and Trademark Usage Policy.

### **A. Unicode Copyright.**

1. Copyright © 1991-2014 Unicode, Inc. All rights reserved.
2. Certain documents and files on this website contain a legend indicating that "Modification is permitted." Any person is hereby authorized, without fee, to modify such documents and files to create derivative works conforming to the Unicode® Standard, subject to Terms and Conditions herein.
3. Any person is hereby authorized, without fee, to view, use, reproduce, and distribute all documents and files solely for informational purposes in the creation of products supporting the Unicode Standard, subject to the Terms and Conditions herein.
4. Further specifications of rights and restrictions pertaining to the use of the particular set of data files known as the "Unicode Character Database" can be found in Exhibit 1.

5. Each version of the Unicode Standard has further specifications of rights and restrictions of use. For the book editions (Unicode 5.0 and earlier), these are found on the back of the title page. The online code charts carry specific restrictions. All other files, including online documentation of the core specification for Unicode 6.0 and later, are covered under these general Terms of Use.
6. No license is granted to "mirror" the Unicode website where a fee is charged for access to the "mirror" site.
7. Modification is not permitted with respect to this document. All copies of this document must be verbatim.

#### **B. Restricted Rights Legend.**

Any technical data or software which is licensed to the United States of America, its agencies and/or instrumentalities under this Agreement is commercial technical data or commercial computer software developed exclusively at private expense as defined in FAR 2.101, or DFARS 252.227-7014 (June 1995), as applicable. For technical data, use, duplication, or disclosure by the Government is subject to restrictions as set forth in DFARS 202.227-7015 Technical Data, Commercial and Items (Nov 1995) and this Agreement. For Software, in accordance with FAR 12-212 or DFARS 227-7202, as applicable, use, duplication or disclosure by the Government is subject to the restrictions set forth in this Agreement.

#### **C. Warranties and Disclaimers.**

1. This publication and/or website may include technical or typographical errors or other inaccuracies . Changes are periodically added to the information herein; these changes will be incorporated in new editions of the publication and/or website. Unicode may make improvements and/or changes in the product(s) and/or program(s) described in this publication and/or website at any time.
2. If this file has been purchased on magnetic or optical media from Unicode, Inc. the sole and exclusive remedy for any claim will be exchange of the defective media within ninety (90) days of original purchase.
3. EXCEPT AS PROVIDED IN SECTION C.2, THIS PUBLICATION AND/OR SOFTWARE IS PROVIDED "AS IS" WITHOUT WARRANTY OF ANY KIND EITHER EXPRESS, IMPLIED, OR STATUTORY, INCLUDING, BUT NOT LIMITED TO, ANY WARRANTIES OF MERCHANTABILITY, FITNESS FOR A PARTICULAR PURPOSE, OR NON-INFRINGEMENT. UNICODE AND ITS LICENSORS ASSUME NO RESPONSIBILITY FOR ERRORS OR OMISSIONS IN THIS PUBLICATION AND/OR SOFTWARE OR OTHER DOCUMENTS WHICH ARE REFERENCED BY OR LINKED TO THIS PUBLICATION OR THE UNICODE WEBSITE.

#### **D. Waiver of Damages.**

In no event shall Unicode or its licensors be liable for any special, incidental, indirect or consequential damages of any kind, or any damages whatsoever, whether or not Unicode was advised of the possibility of the damage, including, without limitation, those resulting from the following: loss of use, data or profits, in connection with the use, modification or distribution of this information or its derivatives.

#### **E. Trademarks & Logos.**

1. The Unicode Word Mark and the Unicode Logo are trademarks of Unicode, Inc. "The Unicode Consortium" and "Unicode, Inc." are trade names of Unicode, Inc. Use of the information and materials found on this website indicates your acknowledgement of Unicode, Inc.'s exclusive worldwide rights in the Unicode Word Mark, the Unicode Logo, and the Unicode trade names.
2. The Unicode Consortium Name and Trademark Usage Policy ("Trademark Policy") are incorporated herein by reference and you agree to abide by the provisions of the Trademark Policy, which may be changed from time to time in the sole discretion of Unicode, Inc.
3. All third party trademarks referenced herein are the property of their respective owners.

#### **F. Miscellaneous.**

The content of this manual represents the status of the user manual at the time of printing and may not be completely valid in future instances. For more information refer to the first page for the complete disclaimer note.



1. Jurisdiction and Venue. This server is operated from a location in the State of California, United States of America. Unicode makes no representation that the materials are appropriate for use in other locations. If you access this server from other locations, you are responsible for compliance with local laws. This Agreement, all use of this site and any claims and damages resulting from use of this site are governed solely by the laws of the State of California without regard to any principles which would apply the laws of a different jurisdiction. The user agrees that any disputes regarding this site shall be resolved solely in the courts located in Santa Clara County, California. The user agrees said courts have personal jurisdiction and agree to waive any right to transfer the dispute to any other forum.
2. Modification by Unicode. Unicode shall have the right to modify this Agreement at any time by posting it to this site. The user may not assign any part of this Agreement without Unicode's prior written consent.
3. Taxes. The user agrees to pay any taxes arising from access to this website or use of the information herein, except for those based on Unicode's net income.
4. Severability. If any provision of this Agreement is declared invalid or unenforceable, the remaining provisions of this Agreement shall remain in effect.
5. Entire Agreement. This Agreement constitutes the entire agreement between the parties.

## 2.19 libpng License

This copy of the libpng notices is provided for your convenience. In case of any discrepancy between this copy and the notices in the file png.h that is included in the libpng distribution, the latter shall prevail.

COPYRIGHT NOTICE, DISCLAIMER, and LICENSE:

The above copyright notice and this permission notice shall be included in all copies or substantial portions of the Software.

If you modify libpng you may insert additional notices immediately following this sentence. libpng versions 1.0.7, July 1, 2000, through 1.0.13, April 15, 2002, are Copyright (c) 2000-2002 Glenn Randers-Pehrson and are distributed according to the same disclaimer and license as libpng-1.0.6 with the following individuals added to the list of Contributing Authors:

Simon-Pierre Cadieux, Eric S. Raymond, Gilles Vollant

and with the following additions to the disclaimer:

There is no warranty against interference with your enjoyment of the library or against infringement. There is no warranty that our efforts or the library will fulfill any of your particular purposes or needs. This library is provided with all faults, and the entire risk of satisfactory quality, performance, accuracy, and effort is with the user.

libpng versions 0.97, January 1998, through 1.0.6, March 20, 2000, are Copyright (c) 1998, 1999 Glenn Randers-Pehrson, and are distributed according to the same disclaimer and license as libpng-0.96, with the following individuals added to the list of Contributing Authors:

Tom Lane, Glenn Randers-Pehrson, Willem van Schaik.

libpng versions 0.89, June 1996, through 0.96, May 1997, are Copyright (c) 1996, 1997 Andreas Dilger Distributed according to the same disclaimer and license as libpng-0.88, with the following individuals added to the list of Contributing Authors:

John Bowler, Kevin Bracey, Sam Bushe, Magnus Holmgren, Greg Roelofs, Tom Tanner.

libpng versions 0.5, May 1995, through 0.88, January 1996, are Copyright (c) 1995, 1996 Guy Eric Schalnat, Group 42, Inc. For the purposes of this copyright and license, "Contributing Authors" is defined as the following set of individuals:

Andreas Dilger, Dave Martindale, Guy Eric Schalnat, Paul Schmidt, Tim Wegner.

The PNG Reference Library is supplied "AS IS". The Contributing Authors and Group 42, Inc. disclaim all warranties, expressed or implied, including, without limitation, the warranties of merchantability and of fitness for any purpose. The Contributing Authors and Group 42, Inc. assume no liability for direct, indirect, incidental, special, exemplary, or consequential damages,

**The content of this manual represents the status of the user manual at the time of printing and may not be completely valid in future instances. For more information refer to the first page for the complete disclaimer note.**

which may result from the use of the PNG Reference Library, even if advised of the possibility of such damage. Permission is hereby granted to use, copy, modify, and distribute this source code, or portions hereof, for any purpose, without fee, subject to the following restrictions:

1. The origin of this source code must not be misrepresented.
2. Altered versions must be plainly marked as such and must not be misrepresented as being the original source.
3. This Copyright notice may not be removed or altered from any source or altered source distribution.

The Contributing Authors and Group 42, Inc. specifically permit, without fee, and encourage the use of this source code as a component to supporting the PNG file format in commercial products. If you use this source code in a product, acknowledgment is not required but would be appreciated. A "png\_get\_copyright" function is available, for convenient use in "about" boxes and the like:

```
printf("%s",png_get_copyright(NULL));
```

Also, the PNG logo (in PNG format, of course) is supplied in the files "pngbar.png" and "pngbar.jpg (88x31) and "pngnow.png" (98x31).

Libpng is OSI Certified Open Source Software. OSI Certified Open Source is a certification mark of the Open Source Initiative.

Glenn Randers-Pehrson

randeg@alum.rpi.edu

April 15, 2002

## **2.20 zlib License**

Copyright/Copyright holders – see List of Open Source Components

This software is provided 'as-is', without any express or implied warranty. In no event will the authors be held liable for any damages arising from the use of this software.

Permission is granted to anyone to use this software for any purpose, including commercial applications, and to alter it and re-distribute it freely, subject to the following restrictions:

1. The origin of this software must not be misrepresented; you must not claim that you wrote the original software. If you use this software in a product, an acknowledgment in the product documentation would be appreciated but is not required.
2. Altered source versions must be plainly marked as such, and must not be misrepresented as being the original software.
3. This notice may not be removed or altered from any source distribution.

---

## **4.1.6. Messages in the instrument panel**

The instrument panel shows messages in certain circumstances to inform or assist the driver.

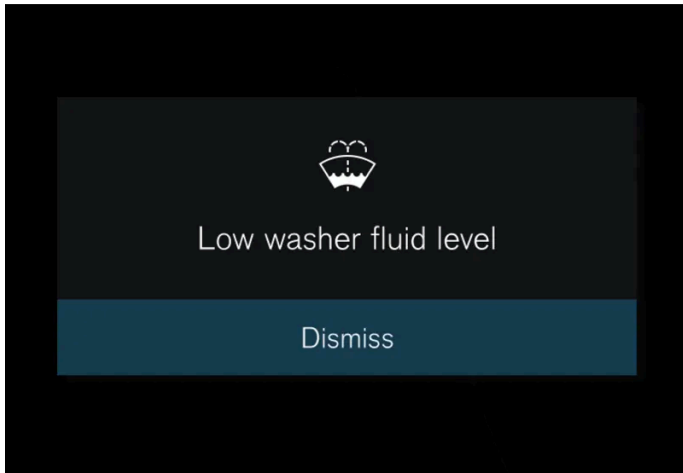

The messages are shown in the center of the instrument panel. The layout may vary and include graphics, symbols or buttons to e.g. acknowledge the message or accept a request.

#### Managing messages

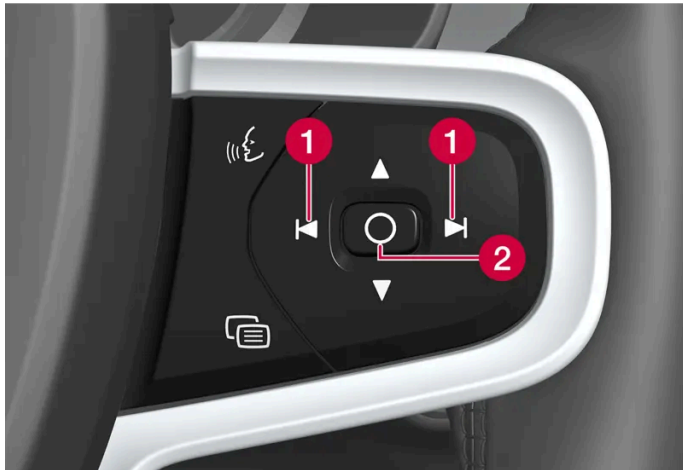

- 1 Left/right
- 2 Confirm

The message disappears from the instrument panel when it is acknowledged or any required action has been taken. Certain messages appear in the center display's Notifications view.

### Service messages

The following table lists a selection of service messages and what they mean.

Message	Meaning
Do not drive <sup>[1]</sup>	Stop and contact a workshop. Serious risk of damage.
Book time for regular maintenance	Time for service - contact a workshop <sup>[1]</sup> . Shown before the next service date.
Time for regular maintenance	Time for service - contact a workshop <sup>[1]</sup> . Shown on the next service date.
Regular maintenance overdue	Time for service - contact a workshop <sup>[1]</sup> . Shown when the date for service has passed.

[1] Part of message, shown along with information on the location of the problem.

---

## 4.2. Center display

---

### 4.2.1. Settings

---

#### 4.2.1.1. Resetting user data

User data and system settings can be reset via the center display.

Settings that can be reset to default values:

- app settings
- network settings (admin only)
- factory reset (admin only) – profiles, user data, connected keys, personal settings, etc. are deleted.

If the vehicle changes owners, all user data and system settings should be reset to factory defaults.

##### Resetting settings via the center display

- 1 Tap .
- 2 Go to **System**, **Reset settings** to reset the desired setting.

To reset network settings or reset the vehicle to factory default settings, the user profile must have administrative rights, which can be obtained by tapping **Become an admin** in Profile view. All of the vehicle's keys must also be in the vehicle to perform a factory reset.

---

#### 4.2.1.2. Changing system units of measurement

Measurement unit settings are adjusted via the center display.

- 1 Tap .

- 2 Proceed to **System, Units**.
- 3 Select the desired unit standard for distance, speed, temperature, etc.
  - > The units in the instrument panel and center display are changed.

---

### 4.2.1.3. Changing system language

Language settings are adjusted via the center display.

 **Note**

Changing languages in the center display could mean that certain owner's information will not comply with national or local laws and regulations. Do not change to a language you do not speak well, as it can be difficult to find your way back through the menu.

- 1 Tap .
- 2 Proceed to **System, Languages and input**.
- 3 Select the desired language.
  - > The language in the instrument panel and center display is changed.

When the system language is changed, the Google Assistant language will also be changed. If another language is desired for the Google Assistant, it can be selected separately in the Google Assistant menu.

---

### 4.2.1.4. Unlock settings

Several different sequences are available for unlocking.

- 1 Tap  in the center display.
- 2 Tap **Controls**.
- 3 Select setting for unlocking.

---

## 4.2.1.5. Setting speed limitation for Care Key

The speed limitation for the Care Key is set in the center display.

The speed limitation for the Care Key can only be set from a profile with administrative rights. To access the settings:

- 1 Tap  in the center display.
- 2 Select **Profiles**.
- 3 Select **Care key**.
- 4 Activate **Speed limit** and select the desired maximum speed<sup>[1]</sup>.
  - The speed limitation is activated when the vehicle is used with a Care Key.

To deactivate the function, the vehicle must be unlocked using an unrestricted key. The speed limitation for the Care Key can be deactivated via settings in the center display. The Care Key can then be used as a regular key.

### Indication in the instrument panel

An active speed limitation is indicated in the instrument panel with a symbol and the message **Speed limitation cannot be exceeded Care Key in use**. A yellow dotted line on the speedometer shows the current speed limitation.

Symbol	Meaning
	Speed limitation is active.

<sup>[1]</sup> The speed can be set within the range of 50-150 km/h (30-95 mph), in increments of 10 km/h (5 mph).

---

## 4.2.1.6. Lock confirmation settings

Settings for how the vehicle confirms locking and unlocking can be adjusted in the center display's Settings menu.

- 1 Tap  in the center display.
  - 2 Tap **Controls**.
  - 3 Select to activate or deactivate confirmation for locking/unlocking.
- 

### 4.2.1.7. Keyless unlock settings\*

Several different sequences are available for keyless unlocking.

- 1 Tap  in the center display.
- 2 Tap **Controls**.
- 3 Select setting for unlocking.

\* Option/accessory.

---

## 4.2.2. User profiles

---

### 4.2.2.1. User profiles

Many of the vehicle's settings can be saved in a personal user profile.

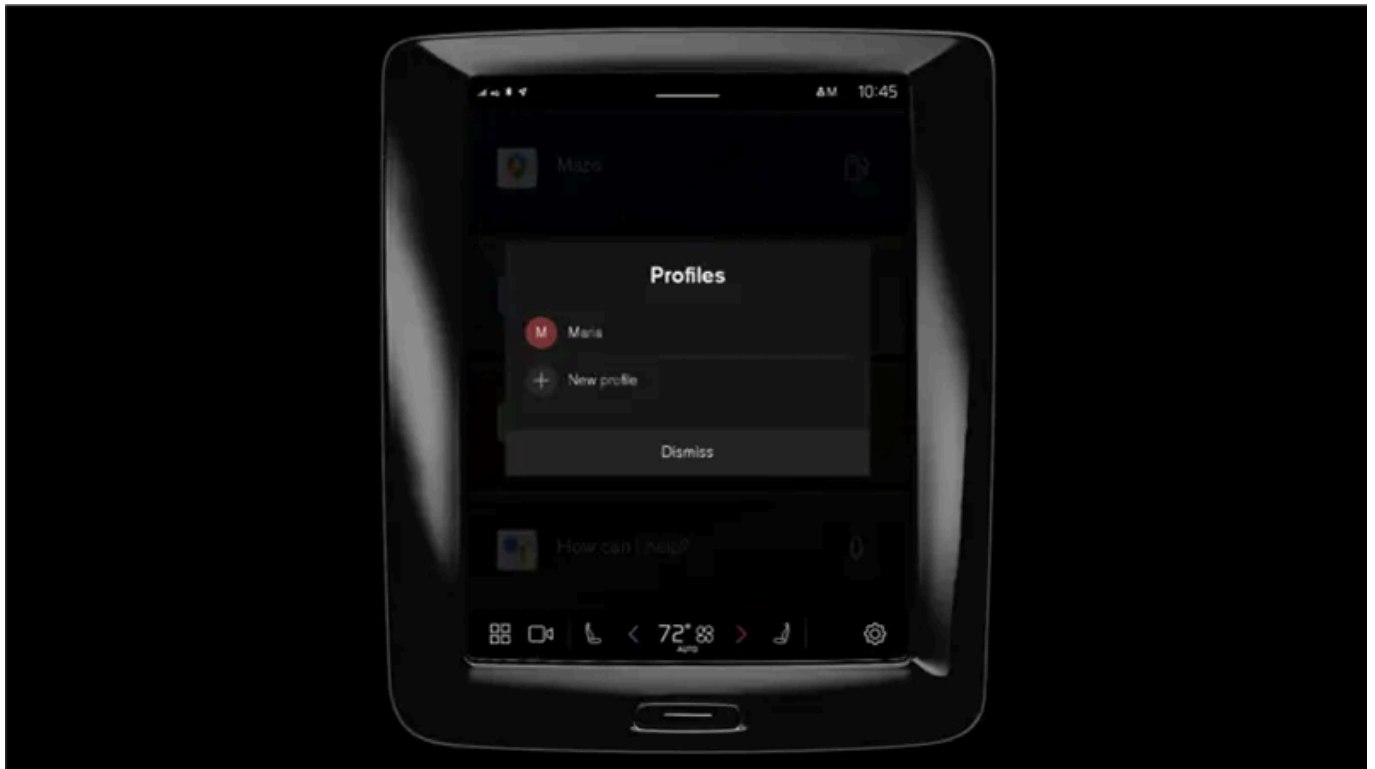

The first time the vehicle is used, or after a factory reset, the **Owner** profile is preinstalled and active in the vehicle.

The **Owner** profile has administrative rights and cannot be deleted.

Pull down Notifications view to access user profiles.

A  symbol is shown in the status bar along with the initials of the active profile. When the system is logged out, no symbol/initials will be shown in the status bar.

## Automatic profile selection

A key can be linked to a profile. This profile and all of its settings will then be selected every time this specific key is identified when unlocking or opening the driver's door.

The last-used profile will be activated if a key is not connected to a specific profile.

## General information about settings

Changes to the vehicle's settings can be saved in different ways depending on which category the settings belong to. The settings can be personal, global or customized for one driving cycle.

### Personal settings

Personal settings are saved to an active profile.

There are two sorts of personal settings:

- Function settings – settings related to driver support, driver's side climate control, the driver's seat, the power door mirrors, as well as interior and exterior lighting. These settings retain their values when a profile is added or when logging out from an active profile.

**The content of this manual represents the status of the user manual at the time of printing and may not be completely valid in future instances. For more information refer to the first page for the complete disclaimer note.**



- Audio and media settings – settings related to navigation, audio and media system, apps and linked accounts. These settings go back to default values when a profile is added or when logging out from an active profile.

### Global settings

The global settings are not changed when the profile is changed. They remain the same regardless of which profile is currently active. Examples of global settings are passenger-side climate control, memory function for the passenger seat, and some system settings.

### Default settings for driving cycle

A number of settings revert to default settings <sup>[1]</sup> after one driving cycle.

These settings can be adjusted while driving. At the next driving cycle, the settings will revert to default values.

<sup>[1]</sup> Default settings may vary depending on market.

---

## 4.2.2.2. Connect key to user profile

A key can be linked to a profile. This profile and all of its settings will then be automatically selected every time this specific key is identified when unlocking or opening the driver's door.

The first time the key is used, it is not connected to any specific profile. The **Owner** profile or the last-used profile is automatically activated when the vehicle is started.

### Connecting a key to a profile

 **Note**

If the key was previously linked to another profile, the link will be moved from the previous profile to the active profile.

- 1 Tap .
- 2 Select **Profiles**.
- 3 Select **Connect key to profile** to connect the selected key to a profile.

A profile can only be connected to the key currently being used in the vehicle. If there are any other keys in the vehicle, the message **More than one key found. Place the key you want to connect on the backup reader.** will be displayed



Location of the backup reader in the tunnel console.

## Disconnecting a key from a profile

- 1 Tap .
- 2 Select **Profiles**.
- 3 Select **Disconnect key from profile** to delete the active profile from the connected key.

A key can be deleted from a profile even if the key is not inside the vehicle.

---

## 4.2.2.3. Managing user profiles

It is possible to change to another profile even if the key used is connected to another profile.

### Creating a profile

- 1 Pull down Notifications view to access user profiles.
- 2 Tap on an active profile.
- 3 Select **New profile**.
- 4 The profile is created.
- > The profile will be set as the active profile.

You will be guided through an interactive flow to set up the new profile. From here you can select to pair a phone with the vehicle or connect different accounts, e.g. Volvo ID, to the profile. Certain steps can be skipped to be finished later.

It is possible to create up to six different profiles.

## Selecting a profile

- 1 Pull down Notifications view to access user profiles.
  - 2 Tap on an active profile.
  - 3 Selectable profiles are shown.
  - 4 Select a profile.
- The profile has now been selected and the system will load the settings stored in the selected profile.

### Note

To stop the seat's movement when switching to a different profile, press any of the buttons on the front seat cushion.

## Logging out of a profile

- 1 Pull down Notifications view to access user profiles.
  - 2 Select **Log out**.
- You are logged out of the profile and it is no longer possible to access accounts connected to that profile.
- 3 The system goes into logged-out mode and changed settings are not saved to any profile.

### Note

Creating, selecting and logging out of a user profile is only possible when the vehicle is at a standstill.

---

## 4.2.2.4. Profile settings

From profile settings, among other things, it is possible to change profile name, add and delete connected keys, connect accounts (e.g. Volvo ID), activate screen lock and delete an active profile.

## Activating screen lock

When screen lock is activated, a passcode is required to use the active profile.

- 1 Tap .
- 2 Select **Profiles**.
- 3 Select **Screen lock**.
- 4 Select type of screen lock and activate.
  - The screen lock will be shown on the center display when switching to a profile with a passcode as well as each time the system is restarted.

## Deleting a profile

Settings that have been saved for one or more profiles can only be deleted when the vehicle is stationary.

- 1 Tap .
- 2 Select **Profiles**.
- 3 Select **Delete this profile**.
  - User information and connections linked to the profile are deleted.
- 4 The system goes into logged-out mode and changed settings are not saved to any profile.

## Becoming an administrator

A profile can be set as administrator.

- 1 Tap .
- 2 Select **Profiles**.
- 3 Select **Become an admin**.

## Changing a profile name

- 1 Tap .

- 2 Select **Profiles**.
  - 3 Tap **Edit** next to the current profile name.
  - 4 Change the profile name and confirm the change.
- 

## 4.2.2.5. Connecting an account to a user profile

An account can be connected to the selected user profile. Examples of accounts that can be added are Volvo ID and Google account.

### Adding an account

- 1 Tap .
- 2 Select **Profiles**.
- 3 Select **Accounts**.
- 4 Select to add an account.
  - A list will appear of the accounts that can be added.
- 5 Select an account.

Then follow the instructions provided. The instructions depend on what type of account is selected.

---

## 4.2.3. Center display overview

Many of the vehicle's functions can be controlled from the center display. The center display and its possibilities are presented below.



## Home view

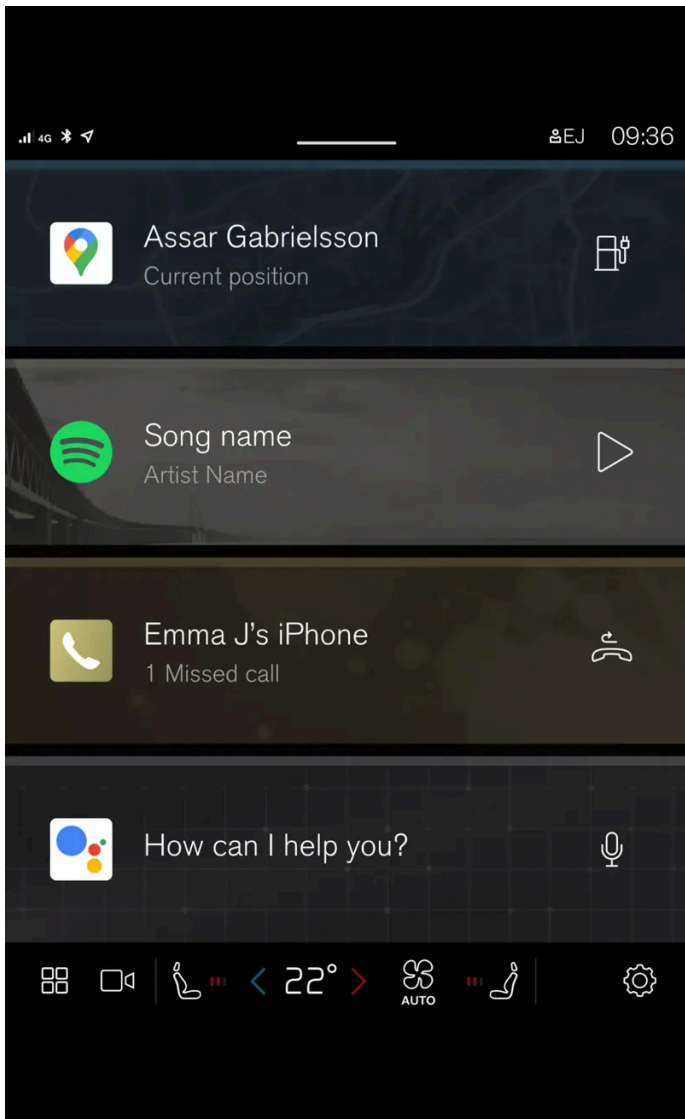

Home view is the first view displayed when the screen is activated.

Home view consists of four tiles showing the most recently used apps. Other views in the center display, such as Climate view, Camera view, App view and Notifications view, can be accessed from Home view.

## Camera view

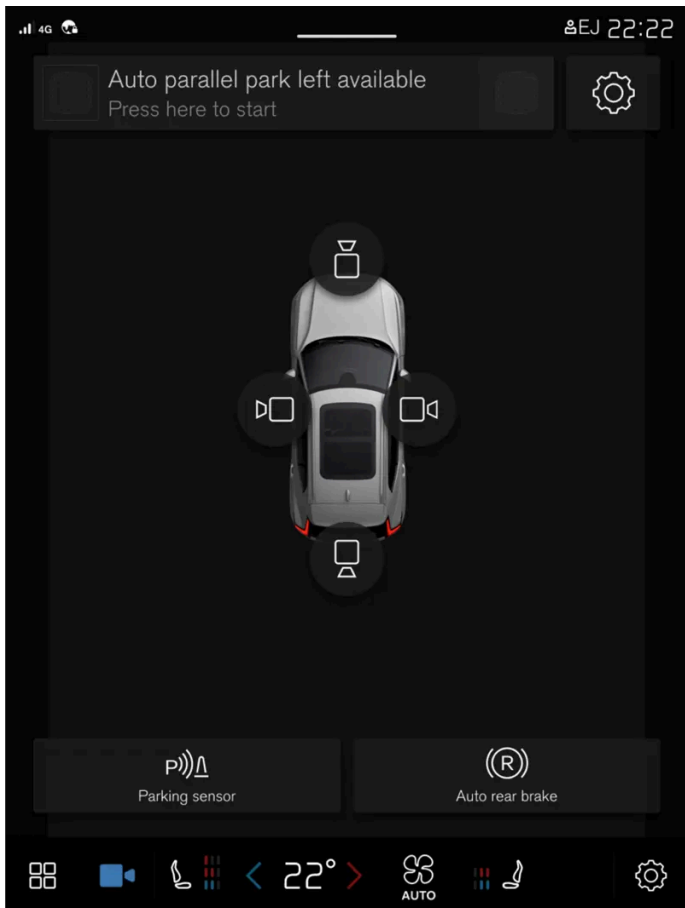

Camera view shows the Park Assist Cameras (PAC<sup>[1]</sup>), which display a 360° panoramic view as well as separate views for each of the four cameras: rear, front, left and right.



## App view

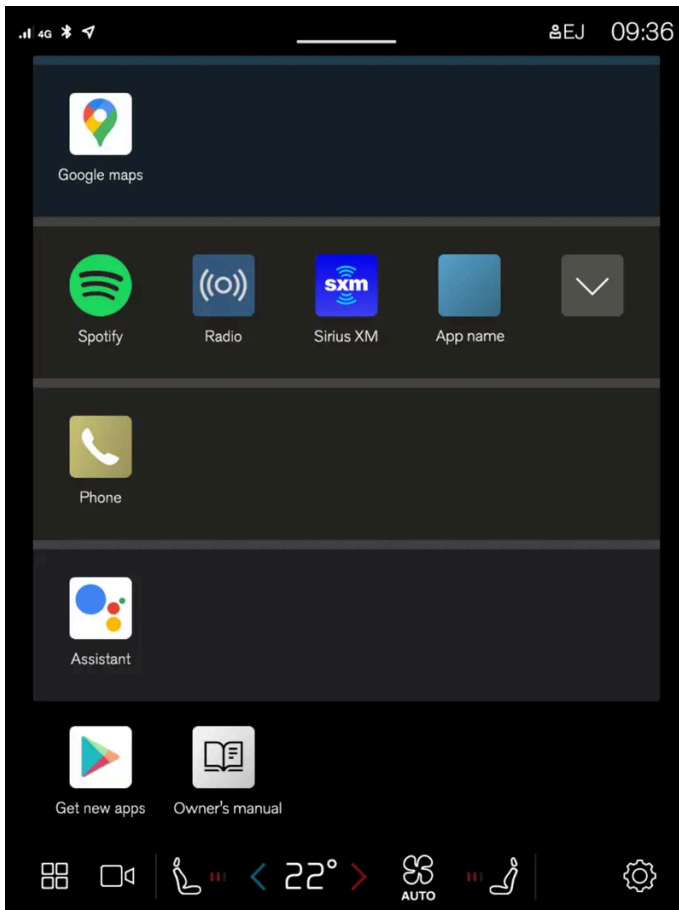

View for downloaded apps (third-party apps) and apps for integrated functions.

### Note

The climate system can be used to cool down the media system in the center display if needed. In these cases, the message **Cooling infotainment system** will be shown in the instrument panel.

<sup>[1]</sup> Park Assist Camera

## 4.2.4. Handling the center display

Many of the vehicle's functions and features can be controlled and adjusted from the center display. The center display is a touchscreen that reacts to taps and other gestures.

### Using the center display's touchscreen

The screen reacts differently depending on whether it is touched by dragging, swiping or tapping. It is possible to e.g. move between different views, mark objects and scroll in a list by touching the screen in various ways.

The center display is an optic touchscreen.

The content of this manual represents the status of the user manual at the time of printing and may not be completely valid in future instances. For more information refer to the first page for the complete disclaimer note.

Two people can interact with the screen at the same time, e.g. to adjust climate system settings for both the driver and passenger sides.

 **Important**

Do not use sharp objects on the screen as this could cause scratches.

 **Note**

Wearing gloves can limit or prevent touchscreen response.

## Returning to Home view from another view

- 1 Briefly press the home button below the center display.
  - > The most recent Home view mode will be displayed.

## 4.2.5. Center display views

The center display is automatically activated when the driver's door is opened.

### Home view

Home view is the view displayed when the screen is activated. It consists of four tiles.

You can choose which apps will be shown in Home view tiles. An app that is selected from App view starts in the respective tile in Home view.

The tiles are dynamic and show the last-used apps, such as navigation, media, phone, etc. Tap an app to expand it or swipe from the left in the tile to view additional apps.

 **Note**

When the vehicle is moving:

- Certain applications (e.g. the Owner's Manual) may be deactivated.
- Certain messages (e.g. those generated by apps) will be shortened.

### Status bar

Current vehicle activities are shown at the top of the screen in the status bar. The status bar shows information such as active user profile, network and connection status as well as the clock.

## Notifications view

The vehicle's notifications are collected at the top of the screen.

Pull the tab down to access Notifications view. Notifications shows missed calls or information about the vehicle. User profiles are also accessed from Notifications view.

To leave Notification view, tap outside of Notifications, press the Home button or swipe upwards. The views behind will become visible again and can be used.

## Climate view

At the bottom of the screen are buttons for App view, settings and the most common climate settings, such as temperature and seat heating settings.

Tap the temperature button at the bottom center of the center display to open Climate view and additional settings options.

Tap the Home button to close Climate view.

## Camera view

Camera view starts automatically when gear selector position R is used.

Camera view shows the Park Assist Cameras (PAC<sup>[1]</sup>), which display a 360° panoramic view as well as separate views for each of the four cameras: rear, front, left and right.

Camera view closes automatically when the vehicle reaches a certain speed or can be closed manually by tapping  or the Home button.

## App view

Tap  toward the bottom of the center display.

App view provides access to the vehicle's preinstalled and downloaded apps. From App view, you can download and install additional apps and access the Owner's Manual.

Tap an app to open it in full-screen mode.

## User profiles

Pull down Notifications view to access user profiles.

Many of the vehicle's settings can be customized to the user's personal preferences and saved in different user profiles.

Settings that can be saved in a user profile include screens, mirrors, front seat, navigation, audio and media system, language and voice control.

You can add profiles, log out or switch between profiles in Notifications view.

<sup>[1]</sup> Park Assist Camera

## 4.2.6. Handling tiles in the center display

The center display's Home and App views contain expandable tiles.

### Expanding an app in Home view

To expand an app:

- 1 Tap the desired app. When an app is opened, the other apps are temporarily hidden.  
Opening an app provides access to its basic functions.

To close an app:

- 1 Press briefly on the Home button under the center display.

### Expanding a tile in App view

Expanding a tile:

- 1 Tap .
- > The tile expands and provides access to additional apps.

Closing an expanded tile:

- 1 The tile can be closed in two ways:
  - Tap .

- Briefly press the Home button at the bottom of the center display.



Center display's home button.

You can always press the Home button to return to Home view.

## 4.2.7. Symbols in the center display status bar

Overview of symbols displayed in the center display status bar.

The status bar shows current vehicle activities and in certain cases, also their status. Due to the limited space in the status bar, not all symbols will be displayed at all times. Several examples are provided below.

Symbol	Meaning
	Connected to the network.
LTE2G3G4G	Network type.
R	Roaming activated.
	Bluetooth device connected.
	Information sent to and from GPS.
15:45	Clock.
	Wireless phone charging.

## 4.2.8. Moving apps in the center display

App view consists of four tiles in which apps can be moved and arranged according to preference. Expand a tile for access to other apps in addition to those shown.

Recently installed apps are placed in App view.

- 1 Open App view.  
Tap .
- 2 Press and hold an app.  
➤ It can then be moved.
- 3 Drag the app to the desired location in App view.

Swipe the screen to scroll up or down in the view to display information outside the view.

 **Note**  
There must be at least one app in every tile.

 **Note**  
Apps cannot be situated at spots already in use.

## 4.2.9. Message in the center display

The following illustration shows how messages and notifications may appear in the center display in different situations.

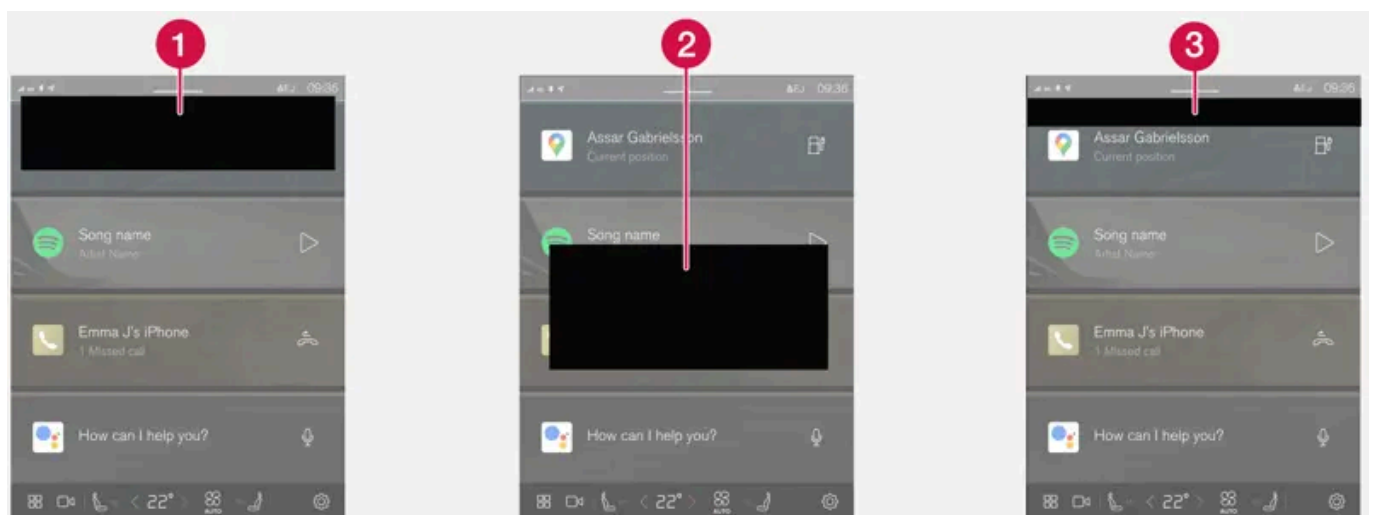

- 1 Shown at the top of the center display. Requires immediate action and may have up to three buttons allowing the user to manage the message. Dismiss by swiping right or left. The message will then be saved in Notifications view.
- 2 Shown as a window in the center display and requires immediate action. May have 1-3 buttons for management.

- 3 Shown for a few seconds at the top of the center display. It is not possible to do anything with the notification, and it is not saved anywhere.
- 

## 4.2.10. Keyboard in the center display

You can use the keyboard in the center display to enter characters or to switch to handwriting mode to "write" letters and characters on the screen.

The keyboard can be used to enter characters (letters, numbers, symbols, etc.) to e.g. send text messages from the vehicle, enter passwords or search for information in the digital Owner's Manual.

The keyboard will only appear when it is possible to enter text on the screen.



This button hides the keyboard. In cases where this is not possible, the button will not be displayed.



Used to change to handwriting mode.

Tap the confirm button over the keyboard once to confirm the text that has been entered. The button's appearance differs depending on the context.

### Variants of letters or characters

Variants of a letter or character, e.g. **é** or **è**, can be entered by pressing and holding the letter or character. A box containing possible variants of the letter or character will appear. Tap the desired variant. If no variant is selected, the original letter/character will be used.

---

## 4.2.11. Entering characters, letters and words by hand in the center display

Characters, letters and words can be entered in the center display by handwriting them on the touchscreen.



Tap the button on the center display's keyboard to switch from the keyboard to handwriting mode.



Return to the standard keyboard layout.

Handwriting characters/letters/words

- 1 Write a character, a letter, a word or parts of a word in the field for handwritten letters. Write the word or part of the word vertically or horizontally.
- A number of suggestions for characters, letters or words will be displayed. The most likely will be shown at the top of the list.

 **Important**

Do not use sharp objects on the screen as this could cause scratches.

- 2 The character/letter/word will be entered automatically after a short pause if no other action is taken.
- The character/letter/word at the top of the list will be used. Tap one of the other characters/letters/words in the list to use it instead.

---

## 4.2.12. Changing keyboard language in the center display

In order to toggle between keyboard languages, the languages must first be added under **Settings**.

### Adding or deleting languages in Settings

The keyboard is automatically set to the same language as the system language. The keyboard language can be changed manually without affecting the system language.

- 1 Tap  at the bottom of the center display.
  - 2 Tap **System, Languages and input, Keyboard**.
  - 3 Select one or more languages in the list.
- It is now possible to toggle between the selected languages using the keyboard.

If no language has been selected under **Settings**, the keyboard will remain in the same language as the vehicle's system language.

### Toggling between keyboard languages



If more than one language has been selected in **Settings**, the button in the keyboard can be used to switch between the different languages.

To toggle between keyboard languages from the list:



- 1 Press and hold the button.
  - > A list will appear.
- 2 Select the desired language. If more than four languages have been selected, you can browse through the list shown on the keyboard.
  - > The keyboard and word suggestions will be adapted to the selected language.

To change keyboard language without displaying the list:

- 1 Briefly press the button.
  - > The keyboard layout will change to the next language in the list without displaying the list.

---

## 4.2.13. Date and time

The clock is shown in the center display, where it is also possible to adjust settings for date and time.

### Location of clock



The clock is located at the top right in the center display's status bar.

### Settings for date and time

- 1 Tap  and then **System**. Then select **Date and time**.
- 2 Select your preferred settings.

### Automatic date and time setting



By default, the date and time are already set and the time zone is automatically adjusted to the vehicle's location.

To adjust the date and time manually, switch off the setting for automatic date and time. To adjust the time zone manually, switch off the setting for automatic time zone. It is also possible to select either a 24-hour or a 12-hour clock.

---

## 4.2.14. Navigate in the Owner's Manual in the center display

The digital Owner's Manual can be accessed from the center display.

To access the Owner's Manual, tap  and then .

There are a number of ways to find information in the Owner's Manual.

### Contents of the Owner Manual

#### Start page



Tap the symbol to return to the Owner's Manual start page.

#### Categories

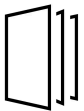

The articles in the Owner's Manual are structured into main and sub-categories. The same article may appear in several relevant categories in order to help make them easier to find.

#### Visual navigation

Exterior and interior overviews of the vehicle. Hotspots are provided for certain functions, components, etc. Tap a hotspot to come to a relevant article.

- 1** Press **Exterior** or **Interior**.
  - Exterior or interior images of the vehicle are shown with hotspots. The hotspots lead to articles about the corresponding function, component, etc. Swipe the screen horizontally to scroll between the images.
- 2** Tap a hotspot.
  - The title of a relevant article will be displayed.
- 3** Tap the title to open the article.

To go back, tap the left arrow.

## Quick guide

Useful information about the most commonly used features and functions in your vehicle.

## Video



Tap the symbol to go to brief instructive videos for various functions in the vehicle.

## Release notes

Read more about the current version and implemented updates.

## Search function

Tap the search field at the top of the Owner's Manual to reach the search function from the start page.

Use **Q** at the top of the Owner's Manual to reach the search function from other pages.

---

# 4.3. Symbols and messages

---

## 4.3.1. BLIS\* messages

A number of messages related to BLIS<sup>[1]</sup> may be displayed in the instrument panel. Several examples are provided below.

Message	Meaning
Blind spot sensor Service required	The system is not functioning as intended. Contact a workshop <sup>[2]</sup> .
Blind spot system off Trailer attached	BLIS and Cross Traffic Alert* have been deactivated because a trailer has been connected to the vehicle's electrical system.

A text message can be erased by briefly pressing the **O** button in the center of the right-side steering wheel keypad.

If the message persists, contact a workshop. An authorized Volvo workshop is recommended.

\* Option/accessory.

<sup>[1]</sup> Blind Spot Information



<sup>[2]</sup> An authorized Volvo workshop is recommended.

---

## 4.3.2. Electronic Stability Control symbols and messages

The content of this manual represents the status of the user manual at the time of printing and may not be completely valid in future instances. For more information refer to the first page for the complete disclaimer note.

A number of symbols and messages related to Electronic Stability Control (ESC<sup>[1]</sup>) may be displayed in the instrument panel. Several examples are provided below.

Symbol	Message	Meaning
	Steady glow for approx. 2 seconds	System check when the engine is started.
	Flashing light	The system is actively operating.
–	Traction control temporarily off	Active yaw control has been temporarily reduced due to too-high brake system temperature. The function will be automatically reactivated when the brakes have cooled.
	ESC Service required	The system is not functioning properly. Stop the vehicle in a safe location. Check if the problem was temporary or if it persists by switching off the engine and then starting it again. If the problem persists, contact a workshop – an authorized Volvo workshop is recommended. The vehicle can be driven, but without ESC functionality.





A text message can be erased by briefly pressing the  button in the center of the right-side steering wheel keypad.

If the message persists, contact a workshop. An authorized Volvo workshop is recommended.

<sup>[1]</sup> Electronic Stability Control

### 4.3.3. Pilot Assist\* symbols and messages

A number of symbols and messages relating to Pilot Assist<sup>[1]</sup> may be displayed. Several examples are provided below.

Symbol	Message	Meaning
	The symbol is illuminated. The vehicle symbol is illuminated when the vehicle has a vehicle ahead to relate to.	The vehicle is maintaining the set speed.
	Pilot Assist Service required The symbol is extinguished	The system is not functioning as intended. Contact a workshop. Pilot Assist is in standby mode.
	Extinguished steering wheel symbol	Indicates that steering assistance is deactivated. When Pilot Assist is providing steering assistance, the steering wheel is illuminated.
	Symbol for hands on the steering wheel	The system cannot detect the driver's hands on the steering wheel. Place your hands on the steering wheel and actively steer the vehicle. The system alerts in various stages along with audible signals. The hazard warning flashers are activated if the vehicle needs to brake down to a standstill.
	Radar sensor front Sensor blocked See Owner's manual, Front radar alignment incomplete or Front camera alignment incomplete	Clean the area in front of the radar sensors.

A text message can be erased by briefly pressing the  button in the center of the right-side steering wheel keypad.

If the message persists, contact a workshop. An authorized Volvo workshop is recommended.



\* Option/accessory.

<sup>[1]</sup> Depending on market, this function can be either standard or optional.

---

## 4.3.4. Lane Keeping Aid symbols and messages

A number of symbols and messages related to Lane Keeping Aid (LKA<sup>[1]</sup>) may be displayed in the instrument panel. Several examples are provided below.

Symbol	Message	Meaning
	Driver support system Reduced functionality Service required	The system is not functioning as intended. Contact a workshop <sup>[2]</sup> .
	Windscreen sensor blocked See Owner's manual	The camera's ability to detect the lane in front of the vehicle is reduced.
	Apply steering Lane Keeping Aid	Steering assistance is disabled when the driver's hands are not on the wheel. Follow the instructions and steer the vehicle.

A text message can be erased by briefly pressing the  button in the center of the right-side steering wheel keypad.

If the message persists, contact a workshop. An authorized Volvo workshop is recommended.

<sup>[1]</sup> Lane Keeping Aid

<sup>[2]</sup> An authorized Volvo workshop is recommended.

---

## 4.3.5. Lane Keeping Aid display

Lane Keeping Aid (LKA<sup>[1]</sup>) uses symbols in the instrument panel for various situations.



Some examples of symbols and descriptions of the situations in which they might appear are provided below.

**Available**



Available – the marker lines in the symbol are white.

Lane Keeping Aid is able to detect one or both of the traffic lane's side marker lines.

**Unavailable**



Unavailable – the marker lines in the symbol are extinguished.

Lane Keeping Aid is unable to detect the lane marker lines, the vehicle's speed is too low or the road is too narrow.

**Steering/warning indicator**

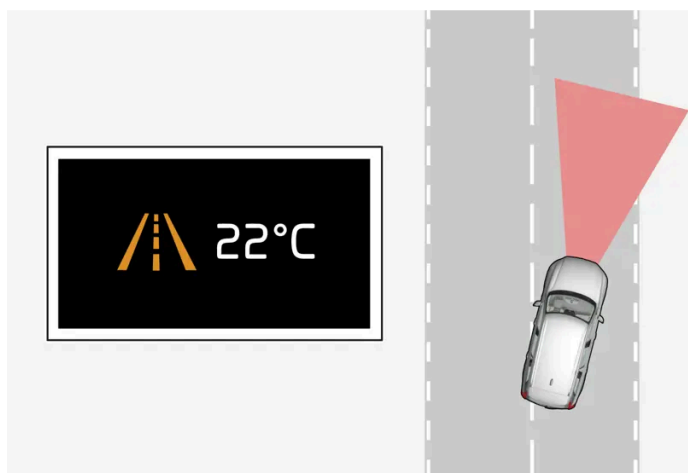

Steering/warning – the marker lines in the symbol are colored.

Indicates that the Lane Keeping Aid system is alerting the driver and/or attempting to steer the vehicle back into the lane.

<sup>[1]</sup> Lane Keeping Aid

## 4.3.6. Park Assist\* and Park Assist Camera\* symbols and messages

Symbols and messages for the Park Assist system and the Park Assist Camera can be displayed in the instrument panel and/or the center display. Several examples are provided below.

Symbol	Message	Meaning
	If the symbol is extinguished.	The rear Park Assist sensors are <b>turned off</b> and no acoustic warnings or field markings for obstacles/objects will be provided.
	Cleaning needed Park Assist System sensors blocked	One or more of the sensors are blocked. Check and clean/remove the obstacle as soon as possible.
	Park Assist System unavailable Service required	The system is not functioning as intended. Contact a workshop <sup>[1]</sup> .

A text message can be erased by briefly pressing the  button in the center of the right-side steering wheel keypad.

If the message persists, contact a workshop. An authorized Volvo workshop is recommended.

### Warning



Be extra cautious when reversing if this symbol is shown when a trailer, bike carrier or similar is attached and electrically connected to the vehicle.

An unlit symbol indicates that the rear parking assist sensors are **deactivated** and will not warn of any obstacles.

## Defective Park Assist Camera

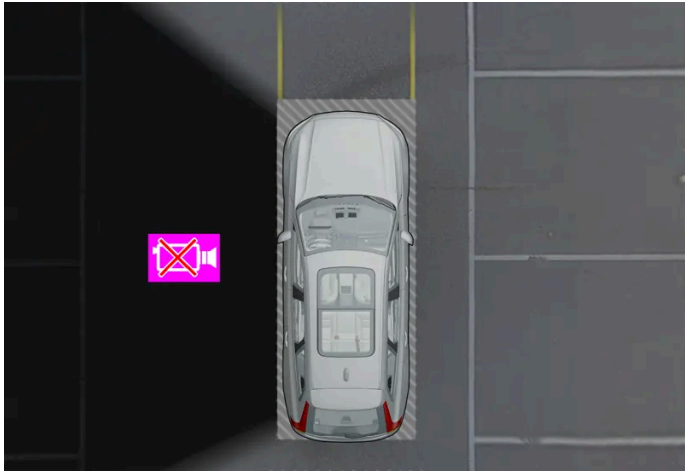

Example indicating that the vehicle's left camera is malfunctioning.

If a camera sector is dark, this indicates that the camera is not functioning properly.

A dark camera sector may also be displayed in the following situations, but **without** the defective camera symbol:

- a door is open
- the tailgate is open
- a rearview mirror is folded in

\* Option/accessory.

[1] An authorized Volvo workshop is recommended.

## 4.3.7. Symbols in the center display status bar

Overview of symbols displayed in the center display status bar.

The status bar shows current vehicle activities and in certain cases, also their status. Due to the limited space in the status bar, not all symbols will be displayed at all times. Several examples are provided below.











Symbol	Meaning
	Connected to the network.
LTE2G3G4G	Network type.
R	Roaming activated.
	Bluetooth device connected.
	Information sent to and from GPS.
15:45	Clock.
	Wireless phone charging.















## 4.3.8. Indicator and warning symbols

Indicator and warning symbols alert the driver that a function is active, that a symbol is working, or that an error or serious fault has occurred.



### Red symbols

	<p><b>WARNING</b></p> <p>The red warning symbol illuminates to indicate that a fault has been detected that could affect safety or driveability. An explanatory message will be simultaneously displayed in the instrument panel.</p> <p>The warning symbol may also illuminate in combination with other symbols.</p>
	<p><b>Seat belt reminder</b></p> <p>Lights up or flashes when someone in the vehicle has not fastened their seat belt.</p>
	<p><b>Airbags</b></p> <p>A fault has been detected in one of the vehicle's safety systems.</p> <p>Read the message in the instrument panel and contact a workshop. Volvo recommends contacting an authorized Volvo workshop.</p>
 <small>[1]</small>  <small>[2]</small>	<p><b>Fault in brake system</b></p> <p>A fault has occurred in the brake system.</p> <p>Read the message in the instrument panel and contact a workshop. Volvo recommends contacting an authorized Volvo workshop.</p>
 <small>[1]</small>  <small>[2]</small>	<p><b>Parking brake</b></p> <p>Steady glow: the parking brake is activated.</p> <p>Flashing: a fault has occurred in the parking brake. Read the message in the instrument panel.</p>
	<p><b>Fault in electrical system</b></p> <p>A fault has occurred in the electrical system.</p> <p>Read the message in the instrument panel and contact a workshop. Volvo recommends contacting an authorized Volvo workshop.</p>
	<p><b>High engine temperature</b></p> <p>The engine's temperature is too high. Read the message in the instrument panel.</p>
	<p><b>Assistance at risk of collision</b></p> <p>Warns the driver if there is a risk of a collision with another vehicle, pedestrian, cyclist or large animal.</p>
	<p><b>Low oil pressure</b></p> <p>The engine's oil pressure is too low. Switch off the engine immediately and check the engine oil level. Add oil if necessary.</p> <p>If this symbol lights up and the oil level is normal, read the message in the instrument panel and contact a workshop. Volvo recommends contacting an authorized Volvo workshop.</p>





## Amber symbols

	<p><b>Information</b></p> <p>A problem has occurred in one of the vehicle's systems. Read the message in the instrument panel. The information symbol may also illuminate in combination with other symbols.</p>
 <p>[1]</p>  <p>[2]</p>	<p><b>Fault in brake system</b></p> <p>A fault has occurred in the brake system. Read the message in the instrument panel.</p>
 <p>[1]</p>  <p>[2]</p>	<p><b>Fault in ABS system</b></p> <p>The system is not functioning properly. The vehicle's regular brakes will still work, but without the ABS function.</p>
	<p><b>Emission control system</b></p> <p>Fault in emission control system. Have the vehicle checked by a workshop. Volvo recommends contacting an authorized Volvo workshop.</p>
	<p><b>Rear fog light</b></p> <p>Rear fog light on.</p>
	<p><b>Tire pressure system</b></p> <p>Tire pressure low.</p> <p>If there is a fault in the tire pressure system, the symbol will first flash for approximately 1 minute and then glow steadily. This may occur if the system cannot detect or alert the driver of low tire pressure as intended.</p>
	<p><b>Fault in headlight system</b></p> <p>A fault has occurred in the headlight system. Read the message in the instrument panel.</p>
	<p><b>Lane Keeping Aid</b></p> <p>Lane Keeping Aid is alerting/intervening.</p>
	<p><b>Stability system</b></p> <p>Steady glow: a fault has occurred in the system.</p> <p>Flashing: the system is working.</p>
	<p><b>Assistance during collision risks System not available</b></p> <p>The system for assistance during collision risks is not available or is working but performance is reduced.</p>





## Blue symbols

	<p><b>Active high beam</b></p> <p>Active high beam is activated and on.</p>
	<p><b>High beams</b></p> <p>High beams on.</p>

## Green symbols

 <small>[1]</small>	<p><b>Auto-hold brake</b> The function is activated and the brakes or the parking brake are being used.</p>
	<p><b>Front fog light</b> Front fog light on.</p>
	<p><b>Parking lights</b> Parking lights on.</p>
	<p><b>Left/right turn signals</b> Turn signal in use.</p>

## White/gray symbols

	<p><b>Active high beam</b> Active high beam is activated but not on.</p>
	<p><b>Driver Alert</b> Driver Alert is activated.</p>
	<p><b>Preconditioning</b> Engine and passenger compartment heater/air conditioning is preconditioning the vehicle.</p>
	<p><b>Lane Keeping Aid</b> White symbol: Lane Keeping Aid is on and lane marker lines are detected. Gray symbol: Lane Keeping Aid is on and lane marker lines are not detected.</p>
	<p><b>Rain sensor</b> The rain sensor is activated.</p>



[1] Canadian models.

[2] US models.

## 4.3.9. Parking climate symbols and messages\*

A number of symbols and messages related to parking climate may be displayed in the instrument panel.

Messages related to parking climate can also be displayed in a device that has the Volvo Cars\* app.

Symbol	Message	Meaning
	Parking climate Service required	Parking climate is not functioning properly. Contact a workshop <sup>[1]</sup> to have the system checked as soon as possible.
	Parking climate Temporarily unavailable	Parking climate is temporarily not functioning properly.
	Parking climate unavailable Desired temperature reached	Parking climate will not run because the heating need is low.

\* Option/accessory.

<sup>[1]</sup> An authorized Volvo workshop is recommended.

## 4.3.10. Overheating of engine and transmission



In certain driving conditions, such as driving in mountainous areas or hot weather, there is an increased risk of the engine or drive system overheating, especially when carrying heavy loads.

- Engine power may be temporarily limited.
- Remove any auxiliary lights mounted in front of the grille when driving in hot weather.
- If the temperature in the engine's cooling system becomes too high, a warning symbol will appear in the instrument panel along with the message **Stop safely High engine temperature**. Pull over to a safe location and let the engine idle for a few minutes to cool down.
- If the message **Turn off engine High engine temperature** or **Turn off engine Coolant level low** is displayed, stop the vehicle and turn off the engine.
- If the transmission becomes overheated, an integrated safety function is activated. A warning symbol illuminates and the instrument panel displays the message **Reduce speed to lower temperature Transmission warm** or **Stop safely Transmission hot Wait for cooling**. Follow the recommendations given by reducing speed or stopping the vehicle safely and letting the engine idle for a few minutes to let the transmission cool.
- If the vehicle begins to overheat, the air conditioning may be temporarily switched off.
- After a prolonged period of driving in demanding conditions, do not turn off the engine immediately after stopping.

### Note

It is normal for the engine's cooling fan to operate for a short time after the engine is switched off.

## Symbols in the instrument panel



Symbol	Meaning
	High engine temperature. Follow the recommendations provided.
	Low coolant level. Follow the recommendations provided.
	Transmission hot/overheated/cooling. Follow the recommendations provided.

## 4.3.11. Transmission symbols and messages

If a problem occurs with the transmission, a symbol and a message are displayed in the instrument panel.

### Important

Check the operating temperature of the transmission to help avoid damage to any of the drive system components. If there is a risk of overheating, a warning symbol will appear in the instrument panel and a text message will be displayed. Follow the recommendations given.

Symbol	Meaning
	A fault has occurred in the transmission. Read the message in the instrument panel.
	Hot or overheated transmission. Read the message in the instrument panel.
	Temporary fault in driveline. Read the message in the instrument panel.

## 4.4. Voice control

### 4.4.1. Voice control with the Google Assistant

The Google Assistant, which is integrated in the vehicle, makes it possible to control a number of functions, such as the climate system, Google Maps for navigation, FM radio\* and phone, using your voice.



## What is the Google Assistant?

The Google Assistant is a virtual assistant that enables you control various functions in the vehicle using your voice and get assistance with other things, such as searching for information, getting weather forecasts, managing your Google Calendar, etc.

The assistant understands natural speech, i.e., no knowledge of specific commands is needed to get the system to perform different tasks. Instead, the user can speak freely with the system, which will respond with answers to questions or will notify the user that it did not understand what was said.

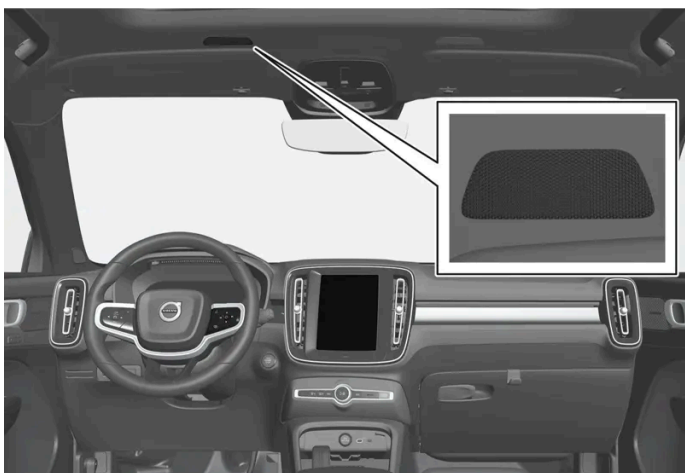

Voice control microphone

## What areas can be controlled using the Google Assistant?

In addition to asking the assistant to search for information on Google, search for weather forecasts, or manage your Google Calendar<sup>[1]</sup>, you can also control a number of functions in the vehicle using your voice. These include:

**The content of this manual represents the status of the user manual at the time of printing and may not be completely valid in future instances. For more information refer to the first page for the complete disclaimer note.**

- media
- FM radio \*
- phone and text messages<sup>[2]</sup>
- navigation via Google Maps
- climate

 **Note**

A poor Internet connection can limit the number of available functions.

 **Warning**

The driver is always responsible for ensuring that the vehicle is operated in a safe manner and that all applicable traffic regulations are followed.

\* Option/accessory.

<sup>[1]</sup> Requires Internet connection.

<sup>[2]</sup> Dictating text messages is only possible for phones with Android or iOS 13 or later.

---

## 4.4.2. Using voice control

The Google Assistant enables you to use your voice to control various functions in the vehicle or to ask for other information, such as a weather forecast.



## Starting the Google Assistant

The Google Assistant can be started in three different ways:

- saying the voice command "Ok Google" or "Hey Google"<sup>[1]</sup>
- briefly pressing the steering wheel button for voice control 🗨️
- pressing the microphone in the center display 🗨️.

The system indicates that it is active and listening by emitting a brief audible signal<sup>[2]</sup> and a graphic acknowledgment in the center display.

## Voice control examples

After the system starts, you can give instructions and ask questions in natural speech. Here are some examples of how to use voice control.

- "Navigate home" – Get route guidance to the address stored in Maps as the home address for the Google account used to log in.
- "Read my messages" – Have text messages sent to your phone read out loud.
- "Raise the temperature" – Raise the temperature in the passenger compartment.
- "Play music" – Play music in selected media app.

Logging in with a Google account means that the Assistant will be more personalized when the vehicle is connected to the Internet. For example, it is possible to call contacts stored in [contacts.google.com \[https://contacts.google.com/\]](https://contacts.google.com/) or ask about information entered in Google Calendar.

The content of this manual represents the status of the user manual at the time of printing and may not be completely valid in future instances. For more information refer to the first page for the complete disclaimer note.



**i Note**

Google Assistant is not yet available in all languages. Read more at [support.google.com \[https://support.google.com/\]](https://support.google.com/) for availability or, if possible, try another language.

**i Note**

The above instructions provide a general description and include third-party suppliers. Availability, procedures and functionality may vary or be changed.

[1] "Hey Google" only works in some languages.

[2] When voice commands are used to start the system, the audible signal will only sound if you pause before continuing your instructions.

## 4.5. Displays and controls by the driver in a left-hand drive vehicle

The overviews show the location of the vehicle's displays and controls.

### Steering wheel and dashboard

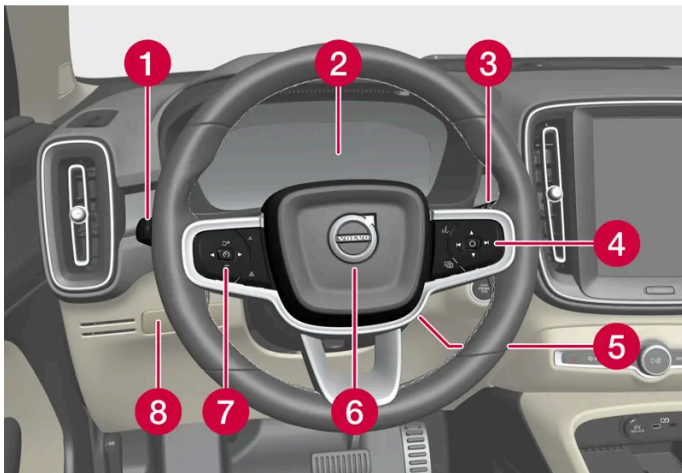



- 1 Parking lights, daytime running lights, low beams, high beams, turn signals, front fog lights/cornering illumination\*, rear fog light, trip computer reset
- 2 Instrument panel
- 3 Wipers and washers, rain sensor\*
- 4 Right-side steering wheel keypad
- 5 Steering wheel adjustment
- 6 Horn
- 7 Left-side steering wheel keypad

The content of this manual represents the status of the user manual at the time of printing and may not be completely valid in future instances. For more information refer to the first page for the complete disclaimer note.

- 8 Display lighting, unlocking/locking\*/closing\* the trunk lid/tailgate

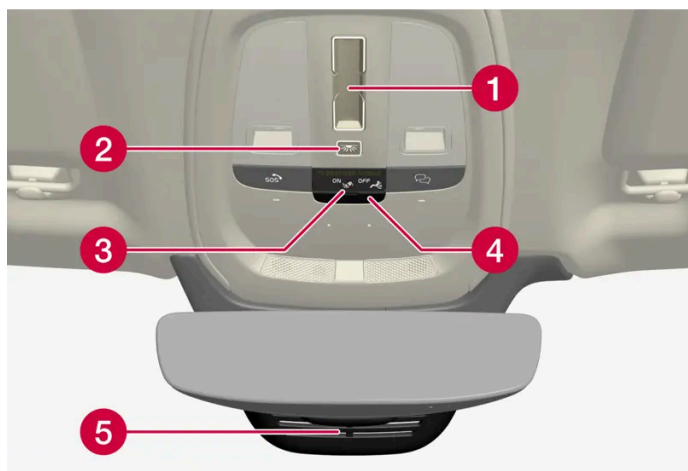
## Ceiling console



- 1 Panoramic roof\*
- 2 Front reading lights and courtesy lighting
- 3 Ceiling console display  button
- 4 SIM card slot
- 5 HomeLink®\*

## Center and tunnel console

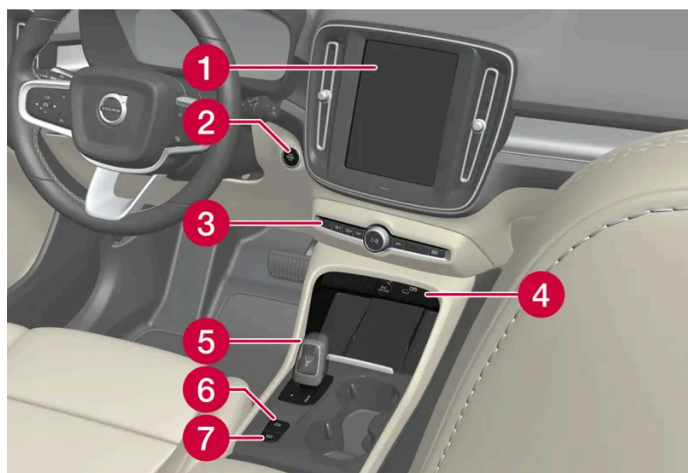

- 1 Center display
- 2 Start button
- 3 Hazard warning flashers, defrosting, media, drive mode button\*
- 4 Electrical outlet, USB port, wireless phone charger\*
- 5 Gear selector
- 6 Parking brake
- 7 Auto-hold brake when stationary

## Driver's door

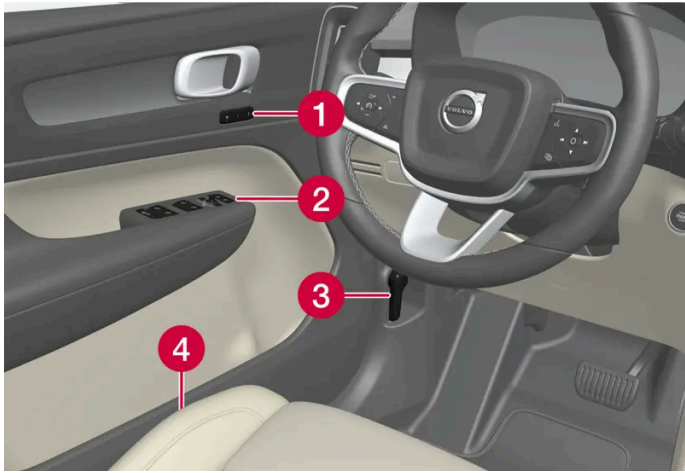

- ① Memory for power front seat\*, door mirror settings
- ② Central locking, power windows, door mirrors and child locks\*
- ③ Hood open
- ④ Controls for front seat

\* Option/accessory.

## 5. Lighting

---

### 5.1. Exterior lighting

---

#### 5.1.1. Active Bending Lights\*

Active Bending Lights (ABL) are designed to help provide extra illumination in curves and intersections. Depending on equipment level, vehicles with LED<sup>[1]</sup> headlights\* may be equipped with Active Bending Lights.

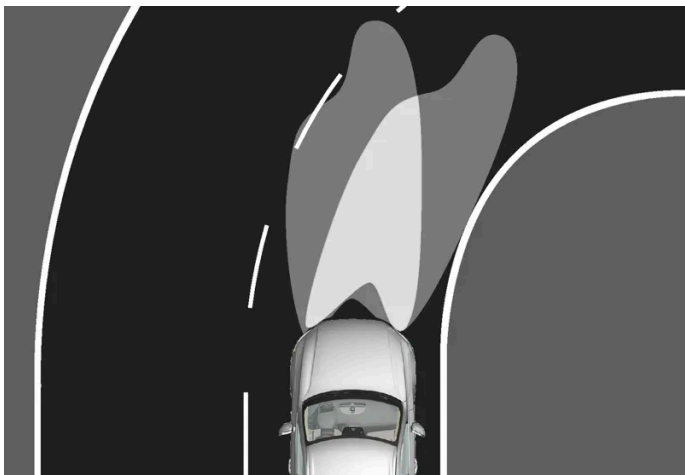

Headlight pattern without Active Bending Lights (left), and with (right).

Active Bending Lights follow the movement of the steering wheel to help provide extra illumination in curves and intersections, helping to improve visibility for the driver.

If a fault is detected in the system, the  symbol will illuminate in the instrument panel and a message will be displayed.

Active Bending lights are only activated in weak daylight or darkness or when the lighting ring on the steering wheel lever is in position **AUTO**. The vehicle must be moving with high beams or low beams on.

\* Option/accessory.

<sup>[1]</sup> LED (Light Emitting Diode)

---

#### 5.1.2. Active high beam



Active high beam uses the camera sensor at the top of the windshield. The camera sensor registers the headlights of oncoming vehicles or the taillights of vehicles ahead and automatically switches from high beams to low beams.



Active high beams is indicated by the  symbol.

This function can be used in dark conditions when the vehicle's speed is approx. 20 km/h (approx. 12 mph) or higher. The function can also detect street lighting. When the camera sensor no longer detects an approaching vehicle or a vehicle ahead, the headlights will return to high beams after a second or two.

## Activating active high beams

Active high beams can be activated and deactivated by turning the lighting ring on the left-side steering wheel lever to position . The lighting ring will then return to **AUTO**. When active high beams are activated, a white  symbol will be displayed in the instrument panel. When high beams are on, the symbol will be blue.

If active high beams are deactivated when the high beams are on, the headlights will automatically switch to low beams.

## Limitations for active high beams

The camera sensor on which the function is based has limitations.



If this symbol and the message **Active High Beam Temporarily unavailable** is displayed in the instrument panel, switching between high and low beams must be done manually.



The same applies if this symbol along with the message **Windscreen sensor blocked See Owner's manual** is displayed.

Active high beams may be temporarily unavailable in certain situations, e.g. heavy fog or rain. When active high beams become available again, or the windshield sensors are no longer blocked, the message will disappear and active high beams will be reactivated.

 **Warning**

Automatic high beam is an aid in using the best possible light based on prevailing conditions.

The driver is always responsible for manually switching between high and low beam when traffic situations or weather conditions require this.

## 5.1.3. Using turn signals

The vehicle's turn signals are controlled using the left-side steering wheel lever. The turn signals flash three times or continuously, depending on how far up or down the lever is moved.

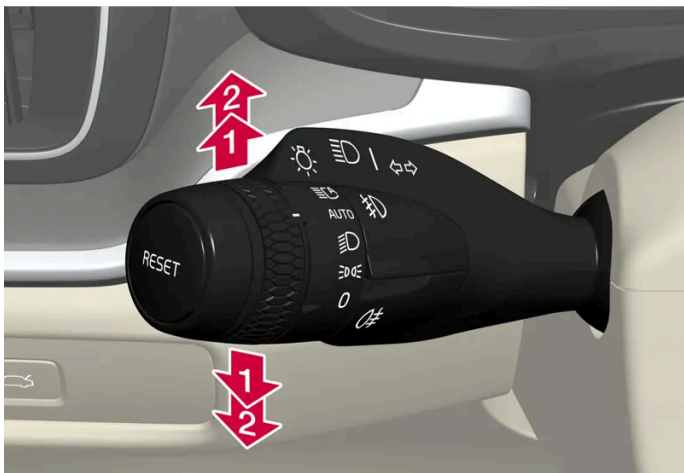

Turn signals.

### Triple flash indicator

 Move the steering wheel lever up or down to the first position and release. The turn signals will flash three times.

 **Note**

This automatic flashing sequence can be interrupted by immediately moving the lever in the opposite direction.

### Continuous flashing sequence

 Move the lever up or down as far as possible.

The lever will stop in its end position and can be moved back manually or automatically by moving the steering wheel.

 **Note**

If the turn signal indicator flashes more quickly than normal, refer to the message in the instrument panel.

---

## 5.1.4. Brake lights

The brake lights are automatically illuminated when braking.

The brake lights are illuminated when the brake pedal is depressed and when the brakes are automatically applied by a driver support system.

---

## 5.1.5. Rear fog light

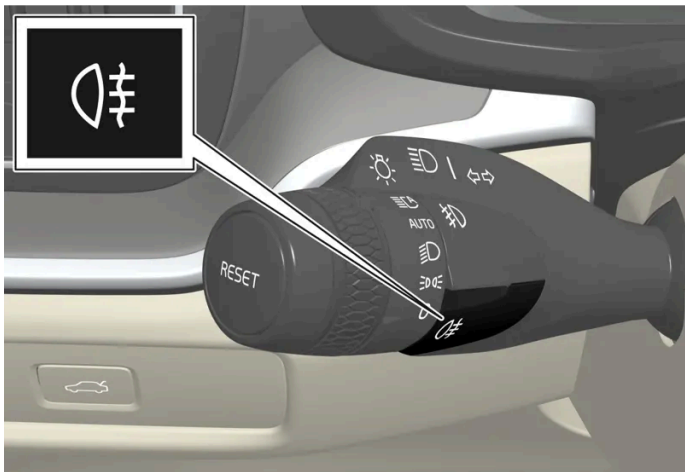

The rear fog light is considerably brighter than ordinary taillights and should only be used to help other road users see the vehicle when visibility is reduced by conditions such as fog, snow, smoke or dust.



Rear fog light button.

The fog lights are located on the right and left sides of the rear of the vehicle.

The rear fog light can only be used when:

- ignition mode II is active and the lighting ring is in position **AUTO** or 
- ignition mode II is active, the lighting ring is in position  and the fog lights are on.

Press the button to switch on/off. The  symbol in the instrument panel illuminates when the rear fog light is on.

The rear fog light turns off automatically when:

- the ignition is off or the lighting ring is in the **0** position.
- the lighting ring is in the  position and the front fog lights are turned off.

### Note

Regulations concerning rear fog light use vary from country to country.



## 5.1.6. Front fog lights/corner illumination \*

The fog lights can be activated manually when driving in fog and are activated automatically when backing up to help augment the backup light.

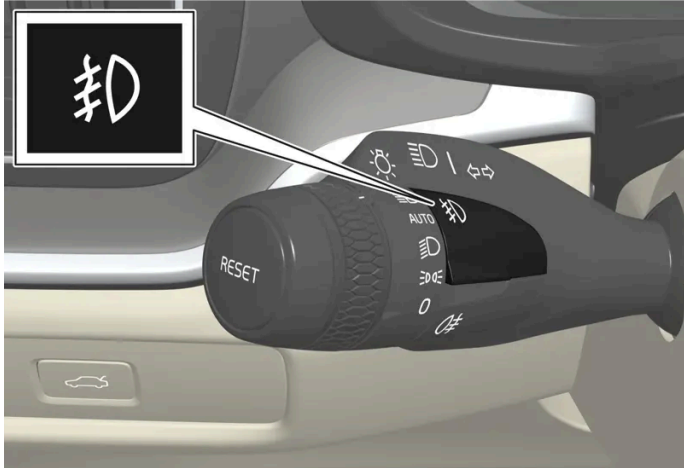
If the vehicle is equipped with corner illumination \*, the fog lights are activated automatically in weak daylight or dark conditions to illuminate the area diagonally in front of the vehicle.



Front fog lights button.

The front fog lights can be turned on when the ignition is in mode II and the lighting ring is in position **AUTO**,  or .

Tap the button to activate or deactivate the function. The  symbol in the instrument panel comes on when the front fog lights are on.

The front fog lights turn off automatically when the ignition is switched off or when the lighting ring is in position **0**.

### Note

Regulations concerning fog light use vary from country to country.

## Cornering illumination \*

The front fog lamps can include the cornering lights function, which temporarily illuminates the area diagonally in front of the car in the direction the steering wheel is turned on a sharp bend, or in the direction shown by the direction indicators.

The function is activated in weak daylight or dark conditions when the lighting ring is in **AUTO** or  mode and the vehicle speed is less than about 30 km/h (about 20 mph).

Both cornering illumination are also illuminated as a complement to the taillights when reversing. They will go out when the vehicle drives forward again.

\* Option/accessory.

## 5.1.7. Low beams

The content of this manual represents the status of the user manual at the time of printing and may not be completely valid in future instances. For more information refer to the first page for the complete disclaimer note.



When driving with the lighting ring in the **AUTO** position, low beam will be automatically activated in weak daylight or dark conditions, when the ignition is in the **II** position.



Lighting ring in **AUTO** position.

With the lighting ring in the **AUTO** position, the low beams will also be automatically activated if the rear fog light is activated.

With the lighting ring in the **D** position, low beams will always be on when the ignition is in the **II** position.

#### **Tunnel detection**

The vehicle will detect if it enters a tunnel and shift from daytime running lights to low beams.

Note that the left-hand steering wheel lever must be in **AUTO** position for tunnel detection to work.

---

## **5.1.8. Using high beam**

High beam is operated via the left-hand steering wheel lever. High beam is the vehicle's strongest lighting and should be used when driving in dark conditions, provided it does not blind other road users, to improve visibility.

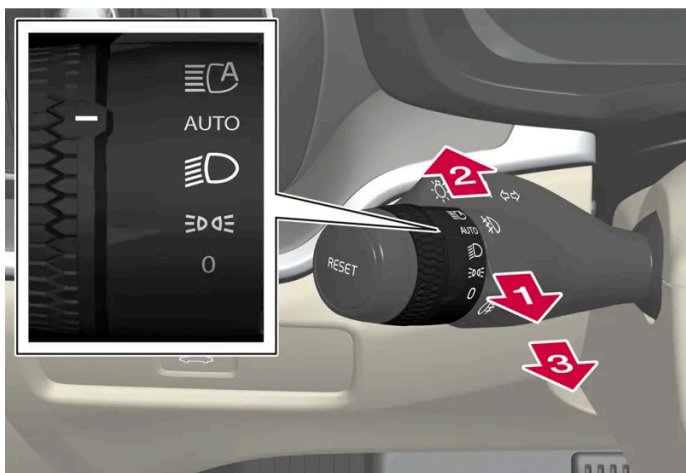



Steering wheel lever with lighting ring.

### **High beam flash**

The content of this manual represents the status of the user manual at the time of printing and may not be completely valid in future instances. For more information refer to the first page for the complete disclaimer note.



 Move the steering wheel lever slightly backward to the high beam flash mode. The high beams will illuminate until the lever is released.

## High beams

 The high beams can be activated when the lighting ring is in mode **AUTO**<sup>[1]</sup> or . Activate high beams by moving the steering wheel lever forward.

 Deactivate by moving the steering wheel lever backward.

### Note

When high beams are activated, they can be deactivated by moving the steering wheel lever back to either position  or .

When the high beams are activated, the  symbol will be illuminated in the instrument panel.



<sup>[1]</sup> When the low beams are on.

---

## 5.1.9. Using Guidance Light

Some of the exterior lights remain on to illuminate the area around the vehicle and work as Guidance Light after the vehicle is locked.

To activate the function:

- 1 Make sure the vehicle is switched off.
  - 2 Push the left-side steering wheel lever toward the dashboard and release.
  - 3 Exit the vehicle and lock the doors.
-  The  symbol illuminates in the instrument panel to indicate that the function is activated and exterior lighting switches on: Parking lights, headlights, license plate lighting and outer door handle lighting\*.

The Guidance Light remains illuminated for about 60 seconds.

\* Option/accessory.

---

## 5.1.10. Emergency brake lights

The content of this manual represents the status of the user manual at the time of printing and may not be completely valid in future instances. For more information refer to the first page for the complete disclaimer note.

The emergency brake lights are activated to warn following vehicles of hard braking. This function causes an additional taillight on each side of the vehicle to illuminate.

The emergency brake lights are activated in the event of hard braking or if the ABS system is activated and the vehicle is traveling at a high speed.

After the driver decelerates to a low speed and then releases the brake, the brake lights resume their normal function and the lights go out.

---

## 5.1.11. Parking lights

The parking lights can be used to help other road users see the vehicle if it is stopped or parked. Use the lighting ring on the steering wheel lever to turn on the parking lights.

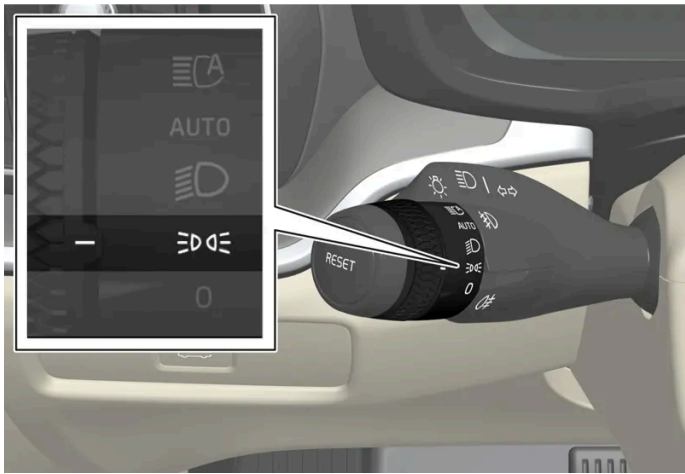

Lighting ring in the parking light position.

Turn the lighting ring to the  position to turn on the parking lights (the license plate lighting will also illuminate).

**Canadian models:** If the vehicle is in Drive mode, the daytime running lights will be illuminated instead of the front parking lights.

**US models:** When **AUTO** mode is selected, the daytime running lights can be deactivated in the center display. The parking lights will also be deactivated. In weak daylight or dark conditions, the parking lights and low beams will be illuminated.

In dark conditions, the rear parking lights also illuminate when the tailgate is opened to alert following traffic. This happens regardless of what position the lighting ring or ignition is in.

In dark conditions, the rear parking lights also illuminate when the tailgate is opened to alert following traffic.

---

## 5.1.12. Welcome Light

The Welcome Light is activated when the vehicle is unlocked and can be used to provide light as you walk toward the vehicle.

The function is activated when the vehicle is unlocked. The parking lights, overhead lights, footwell lights and trunk/cargo compartment lights are activated in daylight conditions. In weak daylight or dark conditions, the license plate lighting and outer door handle lighting\* will also be activated, with the light directed toward the ground.

If no door is opened, the lights will remain illuminated for approx. 2 minutes. If a door is opened while the function is activated, the interior lighting and outer door handle lighting\* will remain on for a longer period of time.

This function can be activated and deactivated in the center display.

\* Option/accessory.

---

## 5.1.13. Hazard warning flashers

Hazard warning flashers warn other road users by all of the vehicle's turn signals being activated at the same time. The function can be used to warn about a traffic hazard.

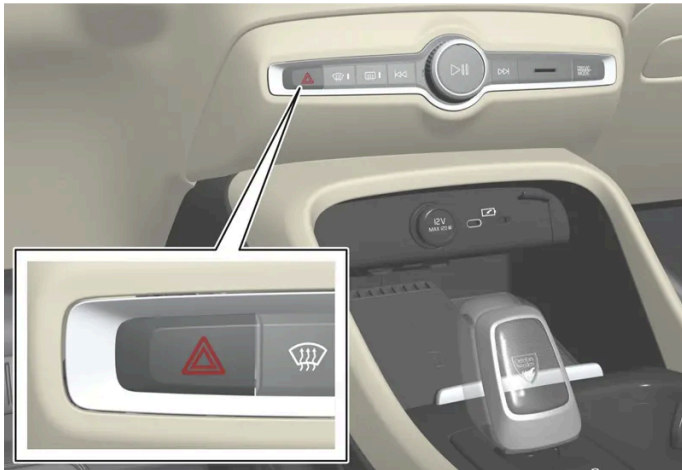

Hazard warning flashers button.

Press the button to activate the hazard warning flashers.

The hazard warning flashers are automatically activated in a collision.

### **i** Note

Regulations concerning the use of hazard warning flashers may vary from country to country.

---

## 5.1.14. Daytime running lights

The vehicle has sensors that detect ambient lighting conditions. With the lighting ring in the **AUTO** position, the daytime running lights will be on. In weak daylight or dark conditions, the headlights automatically switch to low beams.



Lighting ring in **AUTO** position.

With the steering wheel lever's lighting ring in the **AUTO** position, the daytime running lights (DRL<sup>[1]</sup>) will illuminate when the vehicle is driven in daylight conditions. The headlights will switch automatically from daytime running lights to low beams in weak daylight or dark conditions. The headlights will also switch to low beams if the front\* and/or rear fog lights are activated.

**US models:** When **AUTO** mode is selected, the daytime running lights can be deactivated in the center display. The parking lights will also be deactivated. In weak daylight or dark conditions, the parking lights and low beams will be illuminated.

**US models:** With the lighting ring in the **0** or **DRL** position, the daytime running lights will be **off**.

**Canadian models:** With the lighting ring in the **0** or **DRL** position, the daytime running lights will be on.

**Note**

Volvo recommends use of Daytime Running Lights in the US. Its use is mandatory in Canada.

**Warning**

The system is an energy saving aid – it cannot in all situations determine when the daylight is too weak or not strong enough, e.g. when there is fog or rain.

The driver is always responsible for driving the vehicle with lighting that is safe for the traffic conditions and as specified by applicable traffic regulations.

<sup>[1]</sup> Daytime Running Lights

\* Option/accessory.

## 5.1.15. Location of exterior lights

The content of this manual represents the status of the user manual at the time of printing and may not be completely valid in future instances. For more information refer to the first page for the complete disclaimer note.

The vehicle's exterior lighting consists of several different bulbs. LED<sup>[1]</sup> bulbs must be replaced by a workshop. An authorized Volvo workshop is recommended.

## Front lights

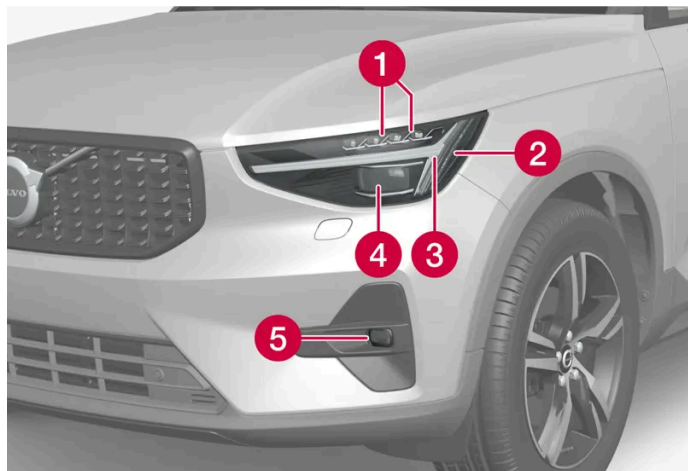

- 1 High beams/low beams (LED)
- 2 Side marker lights (LED)
- 3 Daytime running lights/position lamps/direction indicators (LED)
- 4 Pixel module\* for high and low beams (LED)
- 5 Front fog light/cornering illumination\* (LED)

## Rear bulbs



- 1 Brake light – central, high-mounted (LED)
- 2 Fog light
- 3 Parking light (LED)
- 4 Turn signals
- 5 Brake lights
- 6 Backup light (LED)

<sup>[1]</sup> LED (Light Emitting Diode)

\* Option/accessory.

---

## 5.1.16. Bulb specifications

Specifications for replaceable light bulbs.

If you are experiencing problems with any lights other than light bulbs, contact a workshop<sup>[1]</sup>. If there is a problem with an LED<sup>[2]</sup> light, the entire lamp unit will normally need to be replaced.

Function	W <sup>[3]</sup>	Type
Rear turn signals	21	PY21W
Brake lights	21	H21W LL
Rear fog light	21	H21W LL

<sup>[1]</sup> An authorized Volvo workshop is recommended.

<sup>[2]</sup> LED (Light Emitting Diode)

<sup>[3]</sup> Watt

---

## 5.1.17. Checking trailer lights \*

When connecting a trailer, make sure that the trailer's lights are functioning before starting to drive.

### Checking trailer lights \*

#### Automatic check

When the trailer has been connected to the vehicle's electrical system, its lights can be checked by automatically activating them. This function helps the driver check that the trailer's lights are functioning correctly before starting to drive.

- 1 When a trailer is connected to the towbar, the message **Perform a trailer lamp check?** will appear in the instrument panel.
- 2 Acknowledge the message by pressing the **O** button on the right-side steering wheel keypad.
  - > The light check will begin.
- 3 Get out of the vehicle to perform the check.
  - > All of the lights on the trailer will begin flashing, and then illuminate separately one at a time.
- 4 Visually check that all of the trailer's lights are functioning correctly.

The content of this manual represents the status of the user manual at the time of printing and may not be completely valid in future instances. For more information refer to the first page for the complete disclaimer note.

5 After a short time, all of the trailer's lights will start flashing again.

➤ The light check is completed.

## Trailer rear fog light

When a trailer is connected, the vehicle's rear fog light may not illuminate and rear fog light functionality is instead transferred to only the trailer. If this is the case, check to see if the trailer is equipped with a rear fog light before activating the vehicle's rear fog light when driving with a trailer to help ensure safe operation.

## Symbols and messages in the instrument panel

If one or more of the turn signals or brake lights on the trailer is not working, a symbol and message will be displayed in the instrument panel. The other lights on the trailer must be checked manually by the driver before the vehicle is driven.

Symbol	Message
	Right trailer turn indicator malfunction Left trailer turn indicator malfunction
	Trailer brake light malfunction

If any of the trailer's turn signal lights is not working, the turn signal symbol in the instrument panel will also flash more quickly than normal.

\* Option/accessory.

---

## 5.2. Interior lighting

### 5.2.1. Interior Lighting

The passenger compartment is equipped with several different types of lighting, e.g. general lighting, adjustable interior lighting and reading lights.



## Front overhead lighting



Lighting and controls in the overhead console.

- 1 General lighting
- 2 Reading light
- 3 Button for courtesy lighting and automatic courtesy lighting
- 4 Interior Mood Lighting

### Reading lights

Briefly press one of the reading lights in the overhead console to turn it on or off. The light intensity can be adjusted by pressing and holding your finger on the light.

### Passenger compartment lighting

Briefly press the courtesy lighting button in the overhead console to switch on or off the footwell lighting and general lighting.

### Courtesy lighting auto switch

Press and hold the courtesy lighting button to activate and deactivate automatic passenger compartment lighting. When the button lights up

- white, automatic passenger compartment lighting is activated
- orange, automatic passenger compartment lighting is deactivated.

When automatic passenger compartment lighting is activated, courtesy lighting will illuminate as follows.

Courtesy lighting is switched on when

- the vehicle is unlocked
- a side door is opened.

Courtesy lighting is switched off when

- the vehicle is locked
- gear selector position D, R or N is selected
- a side door is closed

- a side door has been open for approx. 2 minutes.

## Rear roof lighting\*

Reading lights are located in the rear section of the vehicle and can also be used as general lighting.



Reading lights over the rear seat.



In vehicles with a panoramic roof\*, there are two lighting units on each side of the roof.

Gently press the light briefly to turn on or off the reading lights. The light intensity can be adjusted by pressing and holding your finger on the light.

## Glove compartment lighting

The glove compartment lighting comes on or goes off when the glove compartment is opened or closed.

## Vanity mirror lighting\*

The vanity mirror lighting comes on or goes off when the cover over the mirror is opened or closed.

## Ground lighting\*

The ground lighting comes on or goes off when a door is opened or closed.

## Cargo compartment lighting

The cargo compartment lighting comes on or goes off when the cargo compartment is opened or closed.

## Interior Lighting

A number of ambient light sources inside the vehicle can be adjusted via the center display.

## Lighting in the door storage compartments

The lights in the door storage compartments come on when the vehicle is unlocked and go out when the vehicle is locked. The brightness can be adjusted via the center display.

## Lighting in the tunnel console's front cup holder\*

The lighting in front console cup holders switches on when the vehicle is unlocked and off when the vehicle is locked. The brightness can be adjusted via the center display.

\* Option/accessory.

---

## 5.2.2. Adjusting interior lighting

Illumination in the vehicle varies depending on ignition mode. The interior lighting can be adjusted via the center display.

### Adjusting interior lighting via the center display

- 1 Tap  in the center display.
- 2 Then press **Controls**.
- 3 Set a preference for interior lighting.

---

## 5.3. Adjusting light functions via the center display

Light functions can be adjusted and activated via the center display.

- 1 Tap  in the center display.

- 2 Then press **Controls**.
- 3 Adjust the desired function for interior or exterior lighting.

---

## 5.4. Lighting control and panel

The lighting panel and controls can be used to adjust both exterior and interior lighting. The lighting ring on the left-side steering wheel lever can be used to activate and adjust the exterior lighting. Both exterior and interior lighting can be activated and adjusted via the center display.



## Exterior Lights



Lighting ring position.

When the vehicle's ignition is in mode II, the lighting ring positions have the following functions:

Position	Meaning
<b>0</b>	US: Daytime running lights and parking lights are off. Canada: Daytime running lights and parking lights are on. High beam flash can be used.
	Parking lights when the vehicle is parked. US: Daytime running lights are off. Canada: Daytime running lights are on. High beam flash can be used.
	Low beams and parking lights. High beams can be activated. High beam flash can be used.
<b>AUTO</b>	Front daytime running lights and rear parking lights in daylight. <sup>[1]</sup> Low beams and parking lights in weak daylight or dark conditions or when the front fog lights* and/or rear fog light are activated. Active high beam can be activated. High beams can be activated when low beams are on. High beam flash can be used.
	Active high beams on/off.

### Note

Volvo recommends use of Daytime Running Lights in the US. Its use is mandatory in Canada.

Volvo recommends using position **AUTO** when the vehicle is in motion.

### Warning

The vehicle lighting system cannot in all situations determine when the daylight is too weak or not strong enough, e.g. when there is fog or rain.

The driver is always responsible for driving the vehicle with lighting that is safe for the traffic conditions and as specified by applicable traffic regulations.

## Exterior and interior lighting

Both exterior and interior lighting can be adjusted via the center display.

<sup>[1]</sup> US models only: Daytime running lights and parking lights can be deactivated in the center display.

\* Option/accessory.

---

## 6. Windows, glass and mirrors

---

### 6.1. Rearview and door mirrors

---

#### 6.1.1. HomeLink® \* [1]

HomeLink® [2] is a programmable remote control integrated in the vehicle's electrical system. It can remotely control up to three different devices, such as garage door openers or alarm systems, and thereby replace the remote controls for these.

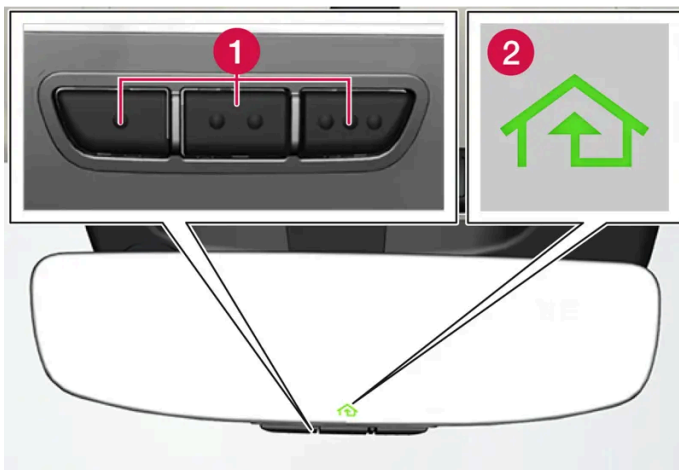

The illustration is generic – the design may vary.

- 1 Programmable buttons
- 2 Indicator light

HomeLink® is integrated in the rearview mirror and consists of three programmable buttons and an indicator light in the mirror.

#### *i* Note

Save the original remote controls for future reprogramming (e.g. for use in another vehicle).

It is also advisable to delete the button programming if the vehicle is sold.

### More information

Visit [homelink.com](http://homelink.com) or call 1-800-355-3515.

\* Option/accessory.

[1] Certain markets only.

The content of this manual represents the status of the user manual at the time of printing and may not be completely valid in future instances. For more information refer to the first page for the complete disclaimer note.

## 6.1.2. Rearview/door mirrors

The rearview mirror and door mirrors can be used to improve the driver's visibility behind the vehicle.

### Rearview mirror

The rearview mirror is equipped with HomeLink\* and automatic dimming\*.

The rearview mirror can be adjusted manually.

### Door mirrors



#### Warning

The door mirror on the passenger side is curved to improve visibility. Objects in the mirror may appear farther away than they actually are.

The joystick in the drivers' door control panel is used to adjust the position of the door mirrors.

There are also several automatic settings that can also be connected to the memory function buttons for the power seat\*.

\* Option/accessory.

---

## 6.1.3. Adjusting the door mirrors

To improve visibility to the rear, the door mirrors need to be adjusted to the driver's height and seating position.

There are several automatic settings that can also be connected to the memory function buttons for the power seat\*.



## Controls used for door mirrors

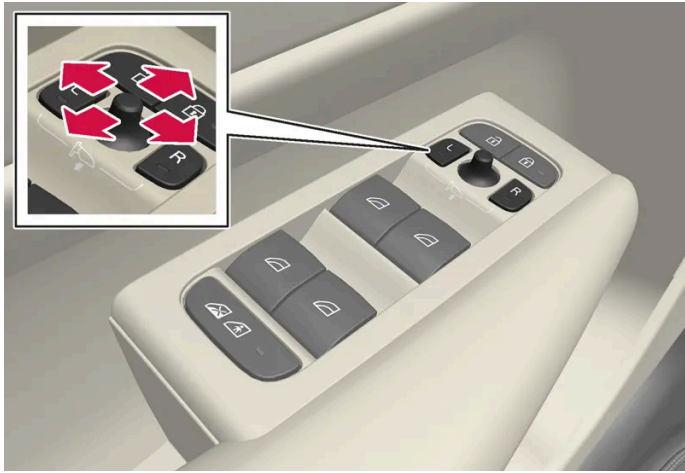

Door mirror controls.

The joystick in the drivers' door control panel is used to adjust the position of the door mirrors. The vehicle must be at least in usage mode Comfort.

- 1 Press the L button for the left door mirror or R for the right door mirror. The button will light up.
- 2 Adjust the position using the joystick located between the buttons.
- 3 Press the L or R button again. The light in the button will go out.

## Automatically folding door mirrors \*

The door mirrors can be automatically folded when driving or parking in tight spaces.

- 1 Press the L and R buttons at the same time.
- 2 Release the buttons after about 1 second. The mirrors will automatically stop when they are completely folded in.

Open the mirrors by pressing L and R at the same time. The mirrors will automatically stop when they reach the last-used setting.

## Resetting the mirrors' position

Mirrors that are moved from their position due to outside influence, for example, being frozen in the folded-in position and then manually moved to the folded-out position, must be electrically reset to their original position for electric folding\* to function correctly.

- 1 Fold in the mirrors by pressing the L and R buttons at the same time.

- 2 Open them again by pressing the L and R buttons at the same time.
- 3 Repeat the above procedure as needed.

The mirrors are reset to their original positions and electric folding functions again.

## Tilting when parking<sup>[1]</sup>

The door mirrors can be tilted down to help give the driver a better view along the sides of the vehicle, e.g. of the curb when parking.

- 1 Select reverse gear and press the L or R mirror button.

Note that the button needs to be pressed twice. When the door mirror is tilted down, the light in the button will flash. When reverse gear is selected, the door mirrors automatically begin to return to their original positions.

## Automatically tilting when parking<sup>[1]</sup>

With this setting, the door mirrors will automatically tilt down when reverse gear is engaged. The folded position is preset and cannot be adjusted.

- 1 Tap  in the center display.
- 2 Tap **Controls**.
- 3 Choose a setting under **Exterior mirrors tilt at reverse**.

To immediately return the door mirrors to their original position, press the L or R button twice.

## Automatic folding when the vehicle is locked\*

The door mirrors fold in or out automatically when the vehicle is locked/unlocked using the key.

### **Note**

If the mirrors are folded in manually using the L and R buttons and the vehicle is then locked, the mirrors will not fold out automatically when the vehicle is unlocked, even if this preference has been set. The door mirrors must be folded out manually using the L and R buttons.

\* Option/accessory.

<sup>[1]</sup> Only on models equipped with a power driver's seat with memory buttons\*.

---

## 6.1.4. Adjusting the rearview mirror dimming function

Bright light entering the vehicle from behind, e.g. from the headlights of following vehicles, could reflect in the rearview mirror and door mirrors and cause a glare. Use the dimming function when light from behind is distracting.

### Auto-dim

If bright light enters the vehicle from behind, the door mirrors will automatically dim when it is dark outside or when lighting conditions are low, for example when driving in tunnels.

Auto-dim can be set in the center display to be active or not active while driving.

- 1 Tap  in the center display.
- 2 Tap **Controls**.
- 3 Choose a setting under **Mirror auto-dimming**.

Dimming is automatically adjusted via the light sensors in the rearview mirror.

#### **Note**

If the sensors are obstructed by e.g. a parking permit, transponder, sunshade or objects on the seats or in the cargo compartment in a way that prevents light from reaching the sensors, the auto-dim function in the door and rearview mirrors will be reduced.

---

## 6.1.5. Using stored positions for seats and mirrors

If the positions for the power\* seat and door mirrors have been stored, they can be activated using the memory buttons.

## Using a stored position

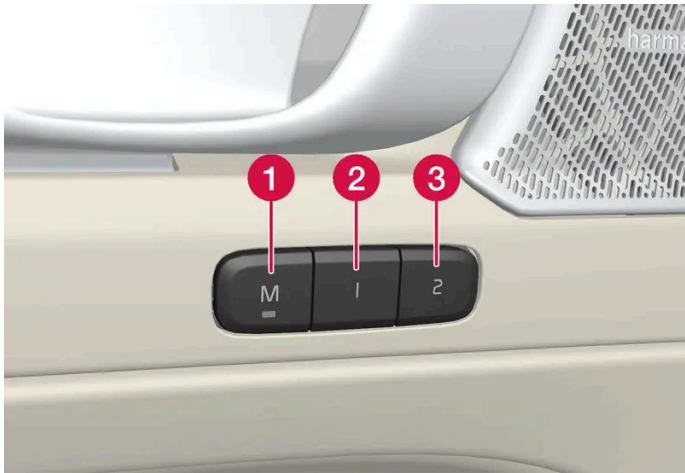

A stored position can be used with the front door open or closed:

### Front door open

- 1 Briefly press one of the memory buttons 1 (2) or 2 (3). The power seats and door mirrors will move and stop at the positions stored in that button.

### Front door closed

- 1 Press and hold one of the memory buttons (1 (2) or 2 (3)) until the seat and door mirrors stop in the positions stored in that memory button.

If the memory button is released, the seat and door mirrors will stop moving.

#### **Warning**

- This list point needs to be translated exactly to: "Because the driver's seat can be adjusted with the ignition off, children should never be left unattended in the vehicle."
- Movement of the seat can be STOPPED at any time by pressing any button on the power seat control panel.
- Do not adjust the seat while driving.
- The seat should be adjusted so that the brake pedal can be depressed fully. In addition, position the seat as far rearward as comfort and control allow.
- The seat rails on the floor must not be obstructed in any way when the seat is in motion.

\* Option/accessory.

---

## 6.1.6. Storing positions for seats and mirrors

Adjustment settings for the power\* seat and door mirrors can be stored in the memory buttons.

Two different positions for the power\* seat and the door mirrors can be stored using the memory buttons. The buttons are located on the inside of either one or both\* front doors.



1 Button **M** for storing a setting.

2 Memory button.

3 Memory button.

### Storing positions

- 1 Adjust the seat and door mirrors to the desired position.
  - 2 Press and hold the **M** button. The indicator light in the button will illuminate.
  - 3 Within three seconds, press and hold the **1** or **2** button.
- When the position has been stored in the memory button, an audio signal will sound and the indicator light in the **M** button will go out.

If none of the memory buttons are pressed within three seconds, the **M** button will go out and no position will be stored.

The seats or door mirrors must be readjusted before a new memory position can be set.

\* Option/accessory.

## 6.1.7. Activating and deactivating the heated rear window and door mirrors

The heated rear window and door mirrors are used to quickly remove condensation and ice from the glass.

### Activating and deactivating the heated rear window and door mirrors from the center console

A button in the center console offers quick access to the heated rear window and door mirrors functions.



Button in center console.

- 1 Tap the button.
  - Heated windows and door mirrors are activated and the button lights up/goes out.

### Activating and deactivating the heated rear window and door mirrors from the center display

- 1 Tap the temperature button in the middle at the bottom of the center display to open Climate view.



Tap the button for heated rear window and door mirrors.

- Heated windows and door mirrors are activated and the button lights up/goes out.

## 6.1.8. Automatically activating and deactivating the heated rear window and door mirrors

The heated rear window and door mirrors are used to quickly remove condensation and ice from the glass.

Automatic start of heated rear window and door mirrors can be set to be activated/deactivated when the driver gets into the vehicle.<sup>[1]</sup> With automatic start activated, heating will be turned on when there is a risk of ice or condensation on the windows or mirrors. Heating is automatically switched off when the window or door mirror is sufficiently warm and the condensation or ice is gone.

- 1 Tap the temperature button in the middle at the bottom of the center display to open Climate view.
- 2 Press ...
- 3 Choose a setting under **Auto rear defroster** to activate/deactivate automatic start of heated rear window and door mirrors.

<sup>[1]</sup> Usage mode Comfort

---

## 6.2. Windshield and rear window

---

### 6.2.1. Damaged windshield

It is important to repair a damaged windshield as soon as possible. Minor damage due to e.g. stone chips can often be repaired without replacing the entire windshield. Volvo recommends contacting an authorized Volvo workshop if the windshield is damaged.

#### Minor glass damage

If possible, repair the damage within 24 hours to help prevent it from worsening. If the windshield has minor damage, a windshield stone chip sticker can help protect the damaged area from dust and dirt until it can be repaired.

#### Major glass damage

In the event of major damage to the windshield, the entire windshield must be replaced.

 **Warning**

Do not drive the vehicle if there is major damage to the windshield. The damage can quickly worsen, obscuring the driver's view and preventing the vehicle from being driven safely.

## Replacing a windshield

It is important that the new windshield and its installation comply with Volvo's specifications for safety and compatibility with the vehicle's functions. Volvo recommends contacting an authorized Volvo workshop for windshield replacements.

## 6.2.2. Wiper blades and washer fluid

The wipers and the washer fluid are designed to improve visibility and the headlight pattern.

The washer nozzles are heated\* automatically in cold weather to prevent the washer fluid from freezing.

When there is approximately 1 liter (1 qt) of washer fluid remaining, a message to refill will appear in the instrument panel.

\* Option/accessory.

## 6.2.3. Using the rain sensor

The rain sensor monitors the amount of water on the windshield and automatically starts the windshield wipers. Rain sensor sensitivity can be adjusted using the thumb wheel on the right-hand steering wheel lever.



Right-hand steering wheel lever.

- 1** Rain sensor button
- 2** Thumb wheel, sensitivity/interval wiper speed

When the rain sensor is activated, the  rain sensor symbol will be displayed in the instrument panel.



The rain sensor is automatically off or on when the vehicle starts depending on the rain sensor position when the vehicle is switched off.

## Activating the rain sensor

When the rain sensor is activated, the windshield wipers must be in 0 position or in the single sweep position.

Activate the rain sensor by pressing the rain sensor button .

Move the lever downward for an extra wiper sweep.

Turn the thumb wheel upward for increased sensitivity and downward for decreased sensitivity. The wipers will make one extra sweep when the thumb wheel is turned upward.

## Deactivate the rain sensor

Deactivate the rain sensor by pressing the  rain sensor button or moving the lever upward to another wiper mode.

The rain sensor is automatically deactivated when the vehicle is switched off.

The rain sensor is also automatically deactivated when the wiper blades are put in the service position. The rain sensor will reactivate when service mode is switched off.

### Important

The windshield wipers may start inadvertently and be damaged in automatic car washes. Switch off the rain sensor before washing the vehicle. The symbol in the instrument panel will go out.

---

## 6.2.4. Using the windshield and headlight washers

The windshield and headlight washers are designed to clean the windshield and headlights. Use the right-side steering wheel lever to start the windshield and headlight washers.

## Starting the windshield and headlight washers



Washing function, right-hand steering wheel lever.

- 1 Move the right-hand steering wheel lever toward the steering wheel to start the windshield and headlight washers.
  - After the lever is released, the wipers make several extra sweeps.

### Important

Avoid activating the washer system when it is frozen or the fluid reservoir is empty. Otherwise, there is a risk of damaging the pump.

## Headlight washer\*

When the windshield washers are activated and the headlights are on, the headlights are also washed automatically according to a defined interval.

## Reduced washing

When there is about 1 liter (1 qt) of washer fluid left in the reservoir and the message Washer fluid **Refill washer fluid, level low** is displayed in the instrument panel together with the  symbol, the washer fluid supply to the headlights is cut off. This is to prioritize windshield cleaning and visibility through it. The headlights are only washed if high or low beam is on.

\* Option/accessory.

---

## 6.2.5. Using the windshield wipers

The windshield wipers are designed to clean the windshield. The right-side steering wheel lever is used to adjust windshield wiper settings.



Right-hand steering wheel lever.

**1** The thumb wheel is used to set rain sensor sensitivity and interval wiper speed.

## Single sweep

- ▼ Move the lever down and release for a single sweep.

## Wipers off

- 0 Move the lever to position 0 to turn off the windshield wipers.

## Interval wipers

- INT Move the lever upward to put the wipers in interval wiping mode. Set the number of sweeps per time unit with the thumb wheel when interval wipers are selected.

## Continuous wipers

- ▲ Move the lever upward for the wipers to operate at normal speed.
- ⬆ Move the lever upward again for the wipers to operate at high speed.

### ! Important

Before activating the wipers, make sure that the wiper blades are not frozen in place and that any snow or ice on the windshield and rear window has been scraped away.

## 6.2.6. Activating and deactivating the heated rear window and door mirrors

The heated rear window and door mirrors are used to quickly remove condensation and ice from the glass.

## Activating and deactivating the heated rear window and door mirrors from the center console

A button in the center console offers quick access to the heated rear window and door mirrors functions.



Button in center console.

- 1 Tap the button.
  - > Heated windows and door mirrors are activated and the button lights up/goes out.

## Activating and deactivating the heated rear window and door mirrors from the center display

- 1 Tap the temperature button in the middle at the bottom of the center display to open Climate view.



Tap the button for heated rear window and door mirrors.

- > Heated windows and door mirrors are activated and the button lights up/goes out.

---

## 6.2.7. Automatically activating and deactivating the heated rear window and door mirrors

The heated rear window and door mirrors are used to quickly remove condensation and ice from the glass.

Automatic start of heated rear window and door mirrors can be set to be activated/deactivated when the driver gets into the vehicle.<sup>[1]</sup> With automatic start activated, heating will be turned on when there is a risk of ice or condensation on the windows or mirrors. Heating is automatically switched off when the window or door mirror is sufficiently warm and the condensation or ice is gone.

- 1 Tap the temperature button in the middle at the bottom of the center display to open Climate view.
- 2 Press ...
- 3 Choose a setting under **Auto rear defroster** to activate/deactivate automatic start of heated rear window and door mirrors.

<sup>[1]</sup> Usage mode Comfort

---

## 6.2.8. Activating and deactivating the heated windshield\*

Windshield heating is used to quickly remove condensation and ice from the windshield.

### Activating and deactivating windshield heating from the center console

A button in the center console is used to quickly access windshield heating.



Button in center console.

- 1 Press the button repeatedly to switch between the three levels:
  - Activated windshield heating
  - Activated windshield heating and max defroster

The content of this manual represents the status of the user manual at the time of printing and may not be completely valid in future instances. For more information refer to the first page for the complete disclaimer note.

- Deactivated.

➤ The heated windshield and max defroster are activated/deactivated and the button lights up/goes out.

## Activating and deactivating windshield heating from the center display

1 Tap the temperature button in the middle at the bottom of the center display to open Climate view.



Tap the button for heated windshield.

➤ The heated windshield is activated/deactivated and the button lights up/goes out.

### Note

Triangular areas at the far sides of the windshield are not heated and will take slightly longer to defrost/de-ice.

### Note

The heated windshield may affect the performance of transponders and other communication equipment.

\* Option/accessory.

---

## 6.2.9. Activating and deactivating automatic windshield heating\*

Windshield heating is used to quickly remove condensation and ice from the windshield.

Automatic start of heated windshield can be set to be activated/deactivated when the driver gets into the vehicle.<sup>[1]</sup> With automatic start activated, heating will be turned on when there is a risk of ice or condensation on the windows or mirrors. Heating is automatically switched off when the window or door mirror is sufficiently warm and the condensation or ice is gone.

1 Tap the temperature button in the middle at the bottom of the center display to open Climate view.

2 Press •••

- 3 Choose a setting under **Auto front defroster** to activate/deactivate automatic start of heated rear window and door mirrors.

\* Option/accessory.

[1] Usage mode Comfort

---

## 6.3. Door windows and panoramic roof

---

### 6.3.1. Power windows

Every door has a control panel for the power windows. The driver's door has controls for operating all windows and for activating the child safety locks.

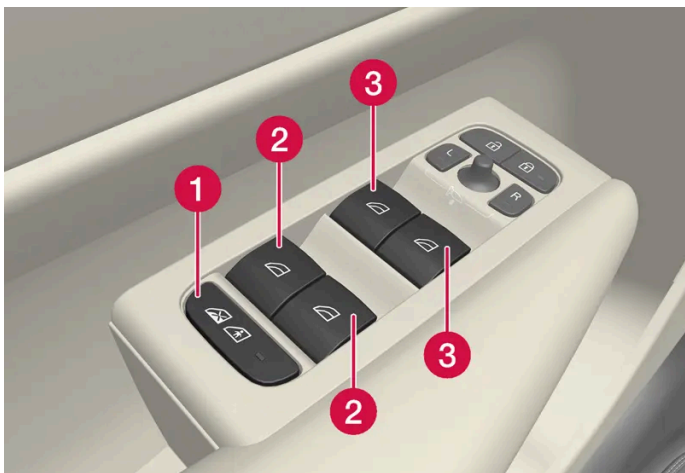

Driver's door control panel.

- 1 Electric child safety locks\* that deactivate the controls in the rear doors to prevent the doors or windows from being opened from the inside.
- 2 Rear window controls.
- 3 Front window controls.

 **Warning**

Children, other passengers or objects can be trapped by the moving parts.

- Always operate the windows with caution.
- Do not allow children to play with the operating controls.
- Never leave a child alone in the vehicle.
- Remember to always cut the current to the power windows by setting the vehicle's electrical system to ignition mode 0 and then taking the key with you when leaving the vehicle.
- Never stick objects or body parts out through the windows, even if the vehicle electrical system is completely turned off.

\* Option/accessory.

---

## 6.3.2. Operating the power windows

All power windows can be operated using the control panel in the driver's door. The control panels in the other doors can be used to operate that particular door.

The power windows have pinch protection. If there is any problem with the pinch protection, a reset procedure can be tested.



 **Warning**

Children, other passengers or objects can be trapped by the moving parts.

- Always operate the windows with caution.
- Do not allow children to play with the operating controls.
- Never leave a child alone in the vehicle.
- Remember to always cut the current to the power windows by setting the vehicle's electrical system to ignition mode 0 and then taking the key with you when leaving the vehicle.
- Never stick objects or body parts out through the windows, even if the vehicle electrical system is completely turned off.



Operating the power windows.

- 1** Operating manually. Move one of the controls slightly up or down. The power windows go up or down while the control is held in position.
- 2** Operating with automatic controls. Move one of the controls up or down to its end position and release it. The window moves automatically to its fully closed/open position.

To use the power windows, the ignition must be in at least mode I or II. After the ignition has been switched off, the power windows can be operated for several minutes or until a door is opened. Only one control can be operated at a time.

It can also be operated using keyless opening\* with the door handle.

 **Warning**

Make sure that no child or other passenger comes into contact with the windows as they are closing with keyless closing\*.

 **Note**

One way to reduce the pulsating wind noise heard when the rear windows are open is to also open the front windows slightly.

**Note**

The windows cannot be opened at speeds over approx. 180 km/h (ca 112 mph), but they can be closed.

The driver is always responsible for following applicable traffic regulations.

**Note**

It may not be possible to operate the windows in low temperatures.

\* Option/accessory.

### 6.3.3. Panoramic roof\*

The panoramic roof is divided into two glass sections. The front section can be opened vertically at the rear edge (ventilation position) or horizontally (open position). The rear section cannot be moved.

The panoramic roof has a wind deflector and sun curtain made of perforated fabric (located beneath the glass sections) for extra protection in e.g. bright sunlight.



The panoramic roof and sun curtain are operated using the controls in the overhead console.

To operate the panoramic roof and sun curtain, the vehicle must be in usage mode Comfort or Drive.

 **Warning**

Children, other passengers or objects can be trapped by the moving parts.

- Always operate the windows with caution.
- Do not allow children to play with the operating controls.
- Never leave a child alone in the vehicle.
- Remember to always cut the current to the power windows by setting the vehicle's electrical system to ignition mode 0 and then taking the key with you when leaving the vehicle.
- Never stick objects or body parts out through the windows, even if the vehicle electrical system is completely turned off.

 **Important**

- Do not open the panoramic roof when load carriers are installed.
- Never place heavy objects on the panoramic roof.

 **Important**

- Remove ice and snow before opening the panoramic roof. Be careful not to scratch any surfaces or damage the trim.
- Do not operate the panoramic roof if it is frozen in place.

## Wind blocker



The panoramic roof is equipped with a wind blocker that folds up when the roof is open.

\* Option/accessory.

## 6.3.4. Operating the panoramic roof\*

The panoramic roof and sun curtain are operated using a control in the overhead console, and both are equipped with pinch protection.

### **Warning**

Children, other passengers or objects can be trapped by the moving parts.

- Always operate the windows with caution.
- Do not allow children to play with the operating controls.
- Never leave a child alone in the vehicle.
- Remember to always cut the current to the power windows by setting the vehicle's electrical system to ignition mode 0 and then taking the key with you when leaving the vehicle.
- Never stick objects or body parts out through the windows, even if the vehicle electrical system is completely turned off.

### **Important**

- Do not open the panoramic roof when load carriers are installed.
- Never place heavy objects on the panoramic roof.

### **Important**

- Remove ice and snow before opening the panoramic roof. Be careful not to scratch any surfaces or damage the trim.
- Do not operate the panoramic roof if it is frozen in place.

To operate the panoramic roof and sun curtain, the vehicle must be in usage mode Comfort or Drive.

It can also be operated using keyless opening\* with the door handle.

### **Warning**

Make sure that no child or other passenger comes into contact with the windows as they are closing with keyless closing\*.

### **Important**

Check that the panoramic roof is properly closed when closing.

The panoramic roof and sun curtain are also equipped with pinch protection. If there is any problem with the pinch protection, a reset procedure can be tested.

**Note**

It may not be possible to operate the windows in low temperatures.

## Opening and closing the panoramic roof to ventilation position using the control in the overhead console



Ventilation position, rear edge raised.

Open and close by pressing once anywhere on the touch-sensitive control.

When ventilation mode is selected, the rear edge of the front section of the roof is raised. If the sun curtain is fully closed when ventilation position is selected, it will automatically open approx. 150 mm (approx. 6 inches).

If the panoramic roof is closed from the ventilation position, the sun curtain will also automatically close.

## Fully opening and closing the panoramic roof with the control in the overhead console

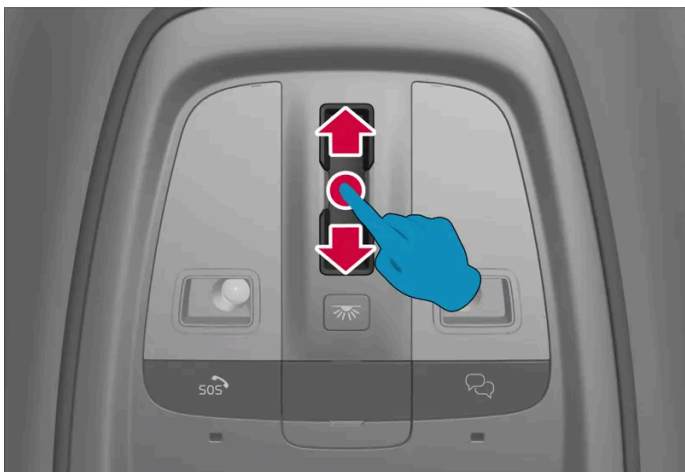

Make a steady and continuous swiping motion rearward/forward over the touch-sensitive control to fully open/close the panoramic roof. If this doesn't work, try making the motion more quickly or slowly.

### Auto operation

- 1 To open the sun curtain to its fully open position, swipe rearward over the control once.
- 2 To open the panoramic roof to comfort position, swipe rearward over the control a second time.
- 3 To open the panoramic roof to its fully open position, swipe rearward over the control a third time.

To close, swipe forward over the control twice.

#### **Automatic operation – rapid opening or closing**

The panoramic roof and sun curtain can be opened or closed simultaneously:

- 1 Open – swipe rearward over the control twice. It is not necessary to wait for the sun curtain to open all the way before swiping again.
  
- 1 Close – swipe forward over the control twice. It is not necessary to wait for the sun curtain to close all the way before swiping again.

\* Option/accessory.

---

## **6.3.5. Auto closing the panoramic roof\* sun curtain**

With this function, the sun curtain closes automatically 15 minutes after the vehicle has been locked if it is parked in hot weather. This is done to lower the passenger compartment temperature and protect the upholstery against being bleached by the sun.

The function is deactivated as the default factory setting and can be activated or deactivated using the center display.

- 1 Tap , **Controls, Auto-close sunroof cover** and choose a setting.

### **Note**

The sun curtain also closes when all windows are closed with keyless closing\*.

\* Option/accessory.

---

## 6.4. Windows, glass and mirrors

The vehicle is equipped with several different types of windows, glass and mirrors. Some of the windows in the car are laminated.

The windshield has laminated glass. Laminated glass is also available as an option for some other glass surfaces<sup>[1]</sup>. Laminated glass is reinforced, which provides better protection against break-ins and improved soundproofing in the passenger compartment.

The panoramic roof\* also has laminated glass.



The symbol shows the windows containing laminated glass.<sup>[2]</sup>

<sup>[1]</sup> Certain models only.

\* Option/accessory.

<sup>[2]</sup> Does not apply to windshield and panoramic roof\*, which are always laminated and therefore do not have this symbol.

---

## 6.5. Pinch protection for windows and sun curtains

All power windows and sun curtains\* have a pinch protection function that is triggered if anything blocks them while they are opening or closing.

If pinch protection is activated, movement will stop and then retract automatically to approx. 50 mm (2 inches) from the point at which it was blocked (or to full ventilation position).

It is still possible to override pinch protection when closing is interrupted (e.g. due to ice) by pressing and holding down the control in the same direction.

If there is any problem with the pinch protection, a reset procedure can be tested.

### **Warning**

If the starter battery is disconnected, the function for automatic opening and closing must be reset to function correctly. A reset is required in order for the pinch protection to work.

\* Option/accessory.

---

## 6.6. Reset procedure for pinch protection

If you experience any problems with the electrical functions for the power windows, you can try to perform a reset.

 **Warning**

If the starter battery is disconnected, the function for automatic opening and closing must be reset to function correctly. A reset is required in order for the pinch protection to work.

Consult a workshop<sup>[1]</sup> if you experience any problems with the panoramic roof.

### Resetting a power window

- 1 Start with the window in the closed position.
- 2 Then move the control in manual mode three times upward toward the closed position.
  - The system will be automatically activated.

If the problem persists, contact a workshop.

<sup>[1]</sup> An authorized Volvo workshop is recommended.

---

## 6.7. Activating and deactivating max defroster

Max defroster is used to quickly remove condensation and ice from windows.

Max defroster deactivates automatic climate control and air recirculation, activates the air conditioning, and changes blower speed to 5 and temperature to HI.

 **Note**

The volume increases when the blower speed is changed to 5.

When max defroster is deactivated, the climate system reverts to the previous settings.

### Activating and deactivating max defroster from the center console

The content of this manual represents the status of the user manual at the time of printing and may not be completely valid in future instances. For more information refer to the first page for the complete disclaimer note.



A button in the center console offers quick access to the max defroster.

For models with heated windshields\*, tapping the button once activates the windshield heating and a second tap activates the max defroster. A third tap deactivates both.



Button in center console.

Vehicles without a heated windshield:

- 1 Tap the button.
  - Max defroster is activated/deactivated and the button lights up/goes out. While max defroster is activated, the temperature in the different climate zones is not synchronized.

Vehicles with a heated windshield:

- 1 Press the button repeatedly to switch between the three levels:
  - Activated windshield heating
  - Activated windshield heating and max defroster
  - Deactivated.
  - The heated windshield and max defroster are activated/deactivated and the button lights up/goes out.

**i Note**

The max defroster starts after a slight delay to avoid a brief increase in blower speed if the heated windshield function has been deactivated by pressing the button twice in quick succession.

## Activating and deactivating max defroster from the center display

1 Tap the temperature button in the middle at the bottom of the center display to open Climate view.

2



Tap the max defroster button.

- Max defroster is activated/deactivated and the button lights up/goes out. While max defroster is activated, the temperature in the different climate zones is not synchronized.

\* Option/accessory.

---

# 7. Seats and steering wheel

---

## 7.1. Front seat

---

### 7.1.1. Climate controls for front seat

---

#### 7.1.1.1. Activating and deactivating power front seats\*

The seats can be heated for added comfort for the driver and passengers in cold weather.



Tap the seat button for the driver's or passenger's side at the bottom of the center display to open the control for seat heating.



Tap the seat heating button repeatedly to turn on/off heating and to switch between the three heat levels.

➤ The level is changed and the set level is displayed in the button.

 **Warning**

Heated seats should not be used by people who have difficulty detecting temperature increases due to nerve damage or numbness or who for another reason may have difficulty operating the controls for seat heating.

\* Option/accessory.

---

## 7.1.1.2. Activating and deactivating the heated front seat\*

The seats can be heated for added comfort for the driver and passengers in cold weather.

Automatic start of heated seats can be set to be activated/deactivated when the driver gets into the vehicle.<sup>[1]</sup> With automatic start activated, heating will be turned on at an ambient temperature of 10 °C (50 °F) or lower.

- 1 Tap the temperature button in the middle at the bottom of the center display to open Climate view.
- 2 Press ⋮
- 3 Choose a setting under **Auto driver seat heat** and **Auto passenger seat heat** to activate/deactivate automatic start of heated driver's and passenger's seat.

\* Option/accessory.

<sup>[1]</sup> Usage mode Comfort

---

## 7.1.1.3. Setting the blower speed for the front seats<sup>[1]</sup>

The blower can be set to several different automatically controlled speeds for the front seat.

- 1 Tap the temperature button in the middle at the bottom of the center display to open Climate view.
  - 2 Tap the desired blower speed: **OFF**, **1-5** or **Max**.
- The blower speed will be changed and the set speed will light up.

### Important

The air conditioning will not engage if the blower is turned off completely, which may cause fogging on the inside of the windows.

### Note

The climate system automatically adapts airflow as needed within the set blower speed, which means that airflow speed may vary slightly within the same blower speed.

High blower speed in the rear seat can cause increased sound volume in the front seat.

<sup>[1]</sup> The same setting applies to the rear seats with the 2-zone climate system.

---

## 7.1.1.4. Setting the temperature for the front seats<sup>[1]</sup>

The temperature can be set to the desired number of degrees for the front seat climate zones.

- 1 Tap the temperature button at the bottom in the middle of the center display to open the control.<sup>[2]</sup>
  - 2 Tap the arrows next to the temperature to raise or lower the temperature. When the temperature is synchronized, you can also tap directly on the arrows without having to press the temperature button first.
- The temperature will be set and the button will display the new temperature.

### Note

Heating/cooling cannot be accelerated by choosing a higher/lower temperature than the desired temperature.

<sup>[1]</sup> The same setting applies to the rear seats with the 2-zone climate system.

<sup>[2]</sup> If temperature synchronization has been deactivated, the current temperature for both the driver's and passenger sides will be shown.

---

## 7.1.1.5. Synchronize temperature

By default, the temperature in the vehicle's various climate zones is synchronized with the set temperature for the driver's side, but it is possible to deactivate the synchronization and set the temperature separately for the different climate zones.

### Deactivating temperature synchronization

- 1 Tap the temperature button at the bottom in the middle of the center display to open the control.



Tap the synchronization button between the temperature controls.

- The temperature can now be set separately for the individual climate zones. The set temperature is now shown separately on the driver's and passenger's sides in the climate bar instead of only in the middle.

Temperature synchronization can also be deactivated by changing the temperature on the passenger side.

## Resetting synchronized temperature

- 1 Tap the temperature button for the driver's or passenger's side at the bottom of the center display to open the control.



Tap the synchronization button between the temperature controls.

- The temperature for all zones in the vehicle is synchronized with the set temperature on the driver's side.

---

## 7.1.2. Memory function for front seat

---

### 7.1.2.1. Using stored positions for seats and mirrors

If the positions for the power\* seat and door mirrors have been stored, they can be activated using the memory buttons.

#### Using a stored position



A stored position can be used with the front door open or closed:

## Front door open

- 1 Briefly press one of the memory buttons 1 (2) or 2 (3). The power seats and door mirrors will move and stop at the positions stored in that button.

## Front door closed

- 1 Press and hold one of the memory buttons (1 (2) or 2 (3)) until the seat and door mirrors stop in the positions stored in that memory button.

If the memory button is released, the seat and door mirrors will stop moving.

### **Warning**

- This list point needs to be translated exactly to: "Because the driver's seat can be adjusted with the ignition off, children should never be left unattended in the vehicle."
- Movement of the seat can be STOPPED at any time by pressing any button on the power seat control panel.
- Do not adjust the seat while driving.
- The seat should be adjusted so that the brake pedal can be depressed fully. In addition, position the seat as far rearward as comfort and control allow.
- The seat rails on the floor must not be obstructed in any way when the seat is in motion.

\* Option/accessory.

---

## 7.1.2.2. Storing positions for seats and mirrors

Adjustment settings for the power\* seat and door mirrors can be stored in the memory buttons.

Two different positions for the power\* seat and the door mirrors can be stored using the memory buttons. The buttons are lo-

cated on the inside of either one or both\* front doors.



- 1 Button **M** for storing a setting.
- 2 Memory button.
- 3 Memory button.

## Storing positions

- 1 Adjust the seat and door mirrors to the desired position.
- 2 Press and hold the **M** button. The indicator light in the button will illuminate.
- 3 Within three seconds, press and hold the **1** or **2** button.
  - When the position has been stored in the memory button, an audio signal will sound and the indicator light in the **M** button will go out.

If none of the memory buttons are pressed within three seconds, the **M** button will go out and no position will be stored.

The seats or door mirrors must be readjusted before a new memory position can be set.

\* Option/accessory.

---

## 7.1.3. Front seats

The seat has a number of setting options to increase comfort.

---

## 7.1.4. Power\* front seats

The content of this manual represents the status of the user manual at the time of printing and may not be completely valid in future instances. For more information refer to the first page for the complete disclaimer note.



The front seats can be adjusted in a number of different ways to help enhance your seating comfort. The power seat can be moved forward/backward and up/down. The front edge of the seat cushion can be raised/lowered and the tilt of the backrest can be adjusted. Lumbar support\* can be adjusted up/down/forward/rearward. The length of the seat cushion can be adjusted manually\*.

The seats can be adjusted when the vehicle is running and for a certain period of time after the door has been unlocked without the vehicle running. They can also be adjusted for a short period after the vehicle is turned off.

**! Important**

The power seats have an overload protector that is triggered if a seat is blocked by any object. If this occurs, remove the object and attempt to adjust the seat again.

\* Option/accessory.

## 7.1.5. Adjusting the power\* front seats

Set the desired seating position using the controls on the front seat cushion. Activate lumbar support\* by pressing the four-way control.

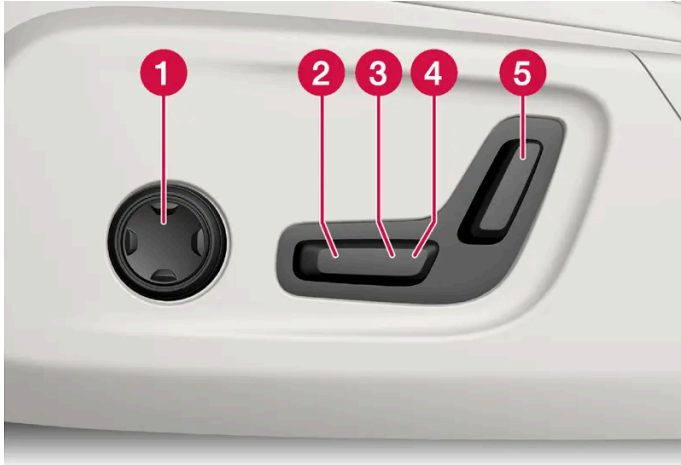

- 1 Activate and use the lumbar support control by pressing the four-way control upwards/downwards/forwards/backwards.
- 2 Raise/lower the front edge of the seat cushion by moving the control up/down.
- 3 Raise/lower the seat by moving the control up/down.
- 4 Move the seat forward/rearward by moving the control forward/rearward.
- 5 Change the backrest tilt by moving the control forward/backward.

Only one movement (forward/rearward/up/down) can be performed at a time.

The front seat backrests cannot be folded down completely.

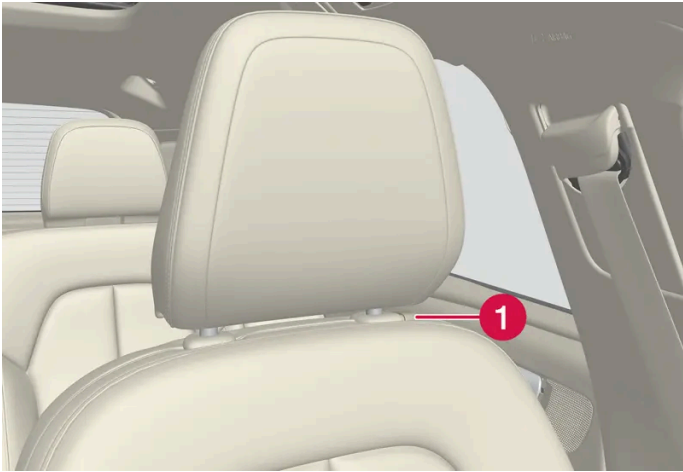

- 1 The head restraint can be adjusted up or down by pressing the button and manually moving the head restraint to the desired position.

\* Option/accessory.

---

## 7.1.6. Manual front seats

The front seats can be adjusted in a number of different ways to help enhance your seating comfort.



- 1 Move the seat forward/backward by lifting the handle and moving the seat to a suitable distance from the steering wheel and pedals. Check to make sure the seat is securely locked into place after its setting has been changed.
- 2 Change the length of the seat cushion\* by pulling up the lever and moving the cushion forward/backward.
- 3 Raise/lower the front edge of the seat cushion\* by moving the control up/down.<sup>[1]</sup>
- 4 Adjust lumbar support\* by pressing the button up/down/forward/rearward.
- 5 Raise/lower the seat by moving the lever up/down.

6 Change the backrest tilt by turning the knob on the backrest.

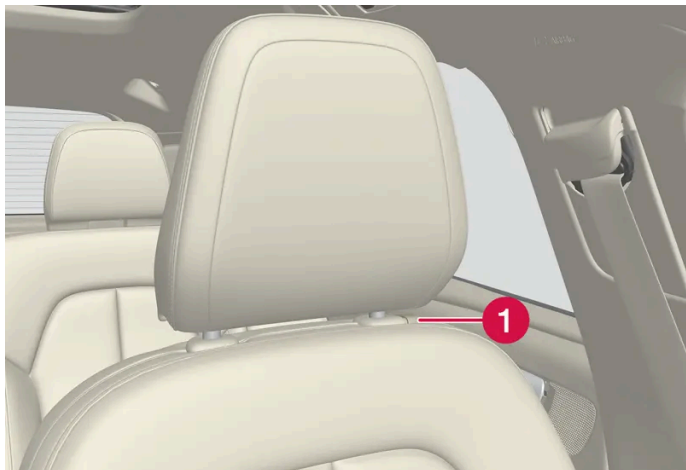

1 The head restraint can be adjusted up or down by pressing the button and manually moving the head restraint to the desired position.

 **Warning**

- Do not adjust the seat while driving. The seat should be adjusted so that the brake pedal can be depressed fully. In addition, position the seat as far rearward as comfort and control allow.
- Check that the seat is securely locked into position after adjusting.

\* Option/accessory.

[1] Only applies to the driver's seat.

---

## 7.1.7. Adjusting\* front seat cushion length

The length of the seat cushion can be adjusted to increase comfort.

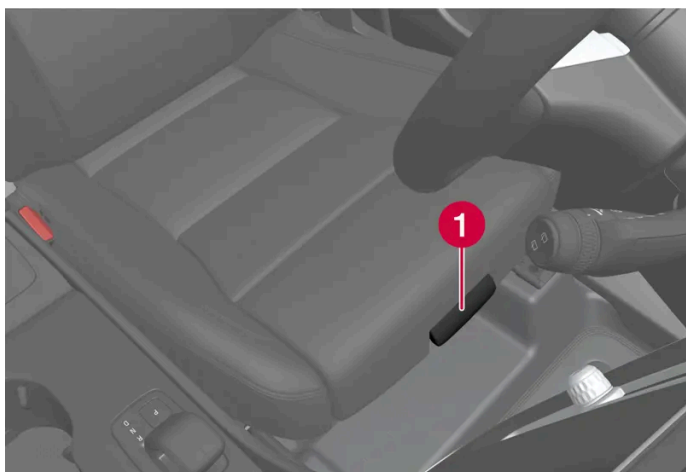

Control for adjusting seat cushion.

- 1 Grasp the **1** handle on the front of the seat and pull upward.
- 2 Adjust the length of the seat cushion.
- 3 Release the handle and make sure the seat cushion locks into position.

\* Option/accessory.

---

## 7.1.8. Adjusting front seat lumbar support \*

Use the control on the side of the seat cushion to adjust the lumbar support.



The four-way button is located on the side of the seat cushion.

Four-way lumbar support is adjusted using the four-way button (the round one) located on the side of the seat cushion. The lumbar support can be adjusted forward/backward and up/down.

## Adjusting lumbar support

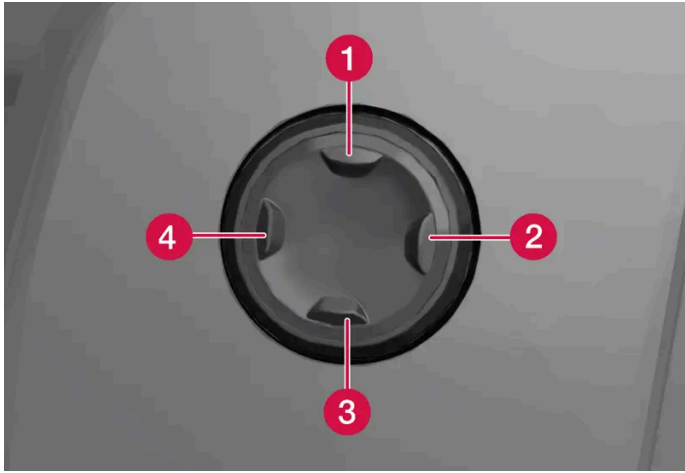

- Press the four-way button up **1**/down **3** to move the lumbar support upward/downward.
- Press the front part **4** of the four-way button to increase lumbar support.
- Press the rear part **2** of the four-way button to decrease lumbar support.

\* Option/accessory.

---

## 7.2. Rear seat

---

### 7.2.1. Climate controls for rear seat

---

#### 7.2.1.1. Activating and deactivating the heated rear seats\*

The seats can be heated for added comfort for the passengers in cold weather.

With 2-zone system:



Buttons for seat heating on the rear side of the tunnel console.

Press the left or right seat heating buttons on the back of the tunnel console to turn on/off seat heating and switch between the three heating levels.

- The level is changed and the indicator lights in the button display the level.

With 4-zone system\*:



Seat heating controls and indicator lights on the rear side of the tunnel console.

Press repeatedly on the left or right seat heating buttons on the climate panel on the tunnel console to select one of four heating levels.

- The level will be changed and the climate panel screen will show the new level.

 **Warning**

Heated seats should not be used by people who have difficulty detecting temperature increases due to nerve damage or numbness or who for another reason may have difficulty operating the controls for seat heating.

\* Option/accessory.

---

## 7.2.2. Rear seat

The vehicle has five seats. The rear seat is divided into two folding sections. One section has two seating positions and the other has one seating position.

---

## 7.2.3. Adjusting the rear seat head restraints

Adjust the center head restraint in the rear seat to the seat occupant's height. Fold down the outboard head restraints\* to improve rear visibility.

### Adjusting the center seat head restraint

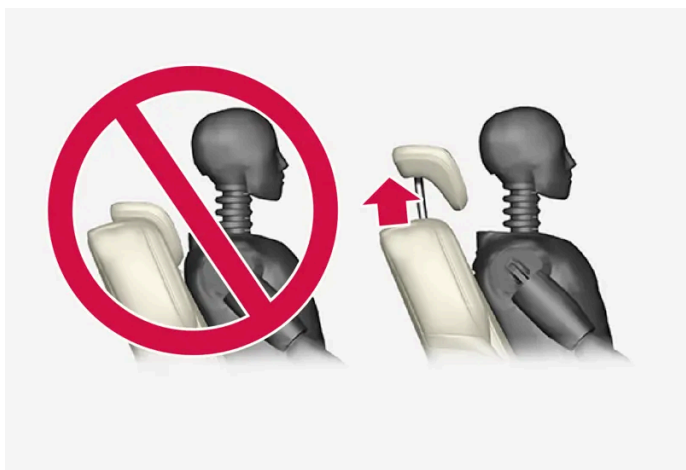

The center head restraint should be adjusted to suit the passenger's height. The entire back of the head should be covered if possible. Manually move the restraint up or down as needed.

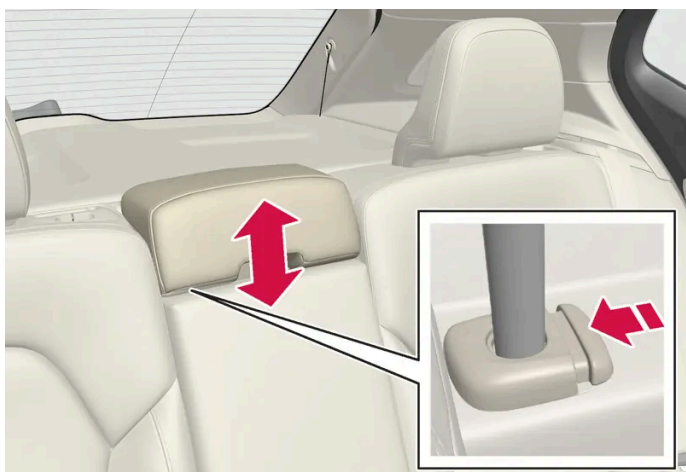

To lower the restraint, push and hold the button (see illustration) while carefully lowering the head restraint.

 **Warning**

The center seat head restraint must be in its lowest position when the seat is not occupied. When the center seat is occupied, the head restraint must be correctly adjusted to the passenger's height, covering the entire back of the head if possible.

## Folding the rear seat outboard head restraints using the center display\*

The outer head restraints can be folded via the center display. The head restraint can be folded down when the vehicle is in Passive usage mode.

- 1 Tap  in the center display.
- 2 Tap **Controls**.
- 3 Choose a setting under **Headrest fold**.

Manually push the head restraint until it clicks into position.

 **Warning**

Do not lower the head restraint if there are passengers in any of the rear seats.

 **Warning**

The head restraint must be locked in the upright position after it has been folded up.

\* Option/accessory.

---

## 7.2.4. Folding down the rear seat backrests

The rear seat backrest is split into two sections. The two sections can be folded forward individually.



 **Warning**

- Adjust the seat and ensure it locks into position before driving. Use caution when adjusting the seat. Uncontrolled or careless adjustments could lead to injury.
- Long objects must always be securely tied down to help prevent injury or damage in the event of sudden braking.
- Always turn off the vehicle and apply the parking brake when loading or unloading the vehicle.
- Put the gear selector in P to help prevent the gear selector from being inadvertently moved.

 **Important**

When the backrest is folded down, make sure there are no objects in the rear seat, and the seat belts are not buckled. Otherwise there is a risk of damage to the upholstery.

 **Important**

The armrest\* in the center seat must be raised before the seat backrest is folded down.

The ski hatch\* must be closed before the seat backrest is folded down.

 **Note**

The front seats may need to be pushed forward and the backrest adjusted so that the rear seat backrests can be fully lowered.

## Folding down the backrests

The vehicle must be stationary and at least one of the rear doors must be open before a backrest can be folded down.

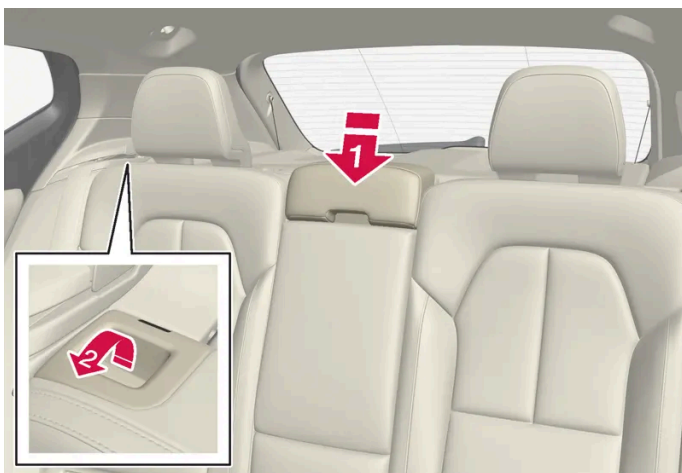

Make sure that the rear seat is unoccupied and that there are no objects on the seat.

**1** 

Fold down the center seat's head restraint manually.

The content of this manual represents the status of the user manual at the time of printing and may not be completely valid in future instances. For more information refer to the first page for the complete disclaimer note.

2 

Pull the handle in the vehicle's left or right rear seat backrest forward to fold down the left or right section of the rear seat.

3 The backrest lock will release and the backrest will automatically fold down to the horizontal position.

## Folding up the backrest

To fold up the backrest to the upright position manually:

- 1 Move the backrest upward/rearward.
- 2 Press the backrest until it locks into position.
- 3 Fold up the head restraints manually.
- 4 Adjust the center head restraint if necessary.



### Warning

When the backrest is restored to an upright position, the red indicator should no longer be visible. If it is still visible, the backrest is not locked in place.



### Warning

Make sure that the rear seat backrest and head restraint are locked securely in place after the seat is folded up.

The head restraints at the outer seats must always be raised when there is a passenger in one of these spots of the rear seat.

\* Option/accessory.

---

## 7.2.5. Rear seat ski hatch\*

The hatch in the rear seat backrest can be opened to transport long, narrow objects such as skis.

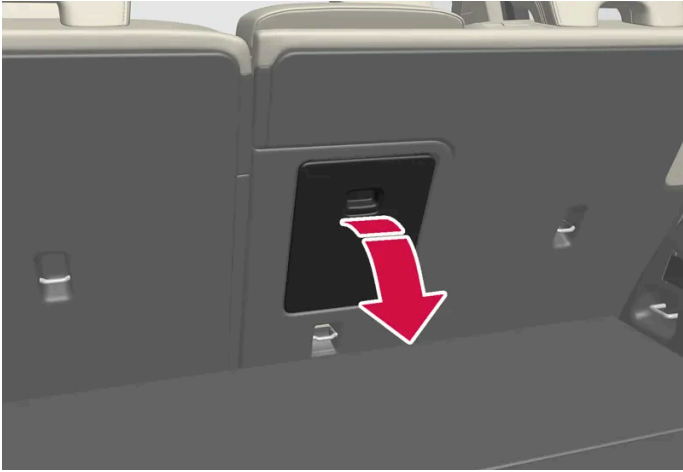

- 1 In the cargo compartment, grasp the ski hatch handle and pull it down.
- 2 Fold down the armrest in the rear seat.
- 3 Adjust the center seat head restraint upwards so the steel tubes do not block the opening.

\* Option/accessory.

---

## 7.3. Steering wheel

---

### 7.3.1. Speed-dependent steering wheel resistance

Speed-dependent power steering increases the steering wheel resistance in pace with the vehicle's speed, which can help give the driver an enhanced feeling of control and stability. Steering is stiffer on highways. When parking and at low speeds, it will be easier to move the steering wheel.

#### Reduced power

In rare situations, the power steering may need to work at reduced power and the steering wheel may then feel more difficult to move. This may happen when the power steering becomes too hot and needs to be temporarily cooled. It can also happen if there is a disturbance in power supply.



If there is reduced power, the message **Power steering assistance Temporarily reduced** and this symbol are shown in the instrument panel.

While the power steering is working at reduced power, the driver support functions and systems with steering assistance are not available.

 **Warning**

If the temperature rises too high, the power steering may be forced to switch off completely. In such a situation, the driver display shows the message **Stop safely Power steering failure** along with a symbol.

## Changing the level of steering wheel resistance

- 1 Tap  in the center display.
- 2 Then press **Driving**.
- 3 Activate or deactivate **Steering feel firm**.

Steering wheel resistance settings can only be accessed if the vehicle is stationary or is moving straight ahead at a low speed.

## 7.3.2. Steering wheel controls and horn

The steering wheel has a horn and controls for e.g. driver support systems and voice control.



Keypad in the steering wheel.

- 1 Driver support system controls.<sup>[1]</sup>
- 2 Controls for voice control, accessing menus and messages, and handling phone calls.

## Horn



The horn is located in the center of the steering wheel.

\* Option/accessory.

[1] Cruise Control, Adaptive Cruise Control\*, Distance Alert\* and Pilot Assist.

---

### 7.3.3. Adjusting the steering wheel

The steering wheel can be adjusted to various positions.

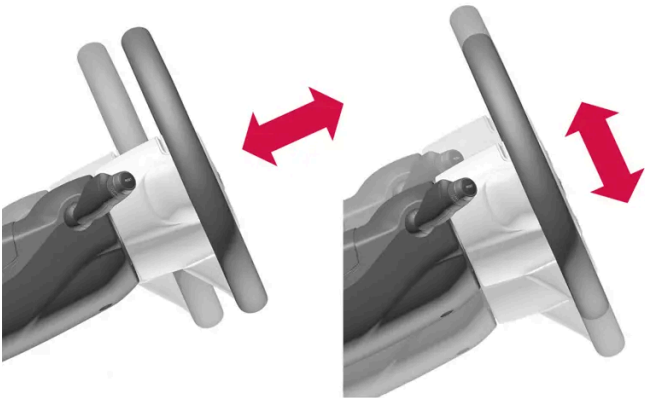

The steering wheel's reach and height can be adjusted.

 **Warning**

Adjust the steering wheel and ensure it locks into position before driving. Never adjust the steering wheel while driving.

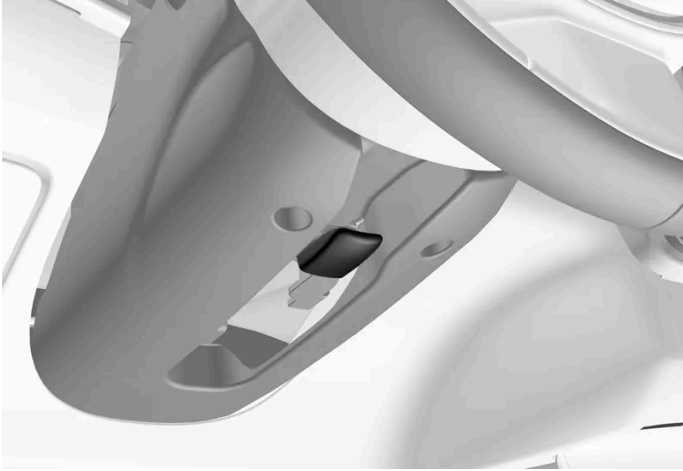

Steering wheel adjuster lever.

- 1 Move the lever forward to release the steering wheel.
- 2 Adjust the steering wheel to the desired position.
- 3 Pull the lever back to lock the steering wheel into place. If the lever is difficult to move, press or lift the steering wheel lightly while pulling the lever.

---

## 7.3.4. Activating and deactivating the heated steering wheel\*

The steering wheel can be heated for added comfort in cold weather.



Tap the driver's side seat button at the bottom of the center display to show the control for steering wheel heating.



Tap the steering wheel heating button repeatedly to turn on/off heating and to switch between the three heat levels.

- The level is changed and the set level is displayed in the button.

\* Option/accessory.

---

## 7.3.5. Activating and deactivating automatic steering wheel heating\*

The steering wheel can be heated for added comfort in cold weather.

Automatic start of heated steering wheel can be set to be activated/deactivated when the driver gets into the vehicle.<sup>[1]</sup> With automatic start activated, heating will be turned on at low ambient temperatures.

- 1 Tap the temperature button in the middle at the bottom of the center display to open Climate view.
- 2 Press ⋮
- 3 Choose a setting under **Auto steering wheel heat** to activate/deactivate automatic start of heated steering wheel.

\* Option/accessory.

<sup>[1]</sup> Usage mode Comfort

## 8. Climate control

---

### 8.1. Climate controls

---

#### 8.1.1. Climate controls for passenger compartment

---

##### 8.1.1.1. Activating auto climate control

If auto climate control is activated, several climate system functions are controlled automatically.

- 1 Tap the temperature button in the middle at the bottom of the center display to open Climate view.
  - 2 Tap or press and hold **AUTO**.
    - Tap - air recirculation, air conditioning and air distribution are controlled automatically.
    - Press and hold - air recirculation, air conditioning and air distribution are controlled automatically. Temperature and blower speed are changed to standard settings: 22 °C (72 °F) and speed 3.
- Auto climate mode is activated and the button lights up.

##### Note

It is possible to change the temperature and blower speed without deactivating automatic climate control. Automatic climate control is deactivated when the air distribution is changed manually or when the max defroster is activated.

##### 8.1.1.2. Setting the blower speed for the front seats <sup>[1]</sup>

The blower can be set to several different automatically controlled speeds for the front seat.

- 1 Tap the temperature button in the middle at the bottom of the center display to open Climate view.



2 Tap the desired blower speed: **OFF**, **1-5** or **Max**.

➤ The blower speed will be changed and the set speed will light up.

 **Important**

The air conditioning will not engage if the blower is turned off completely, which may cause fogging on the inside of the windows.

 **Note**

The climate system automatically adapts airflow as needed within the set blower speed, which means that airflow speed may vary slightly within the same blower speed.

High blower speed in the rear seat can cause increased sound volume in the front seat.

<sup>[1]</sup> The same setting applies to the rear seats with the 2-zone climate system.

---

## 8.1.1.3. Activating and deactivating air conditioning

The air conditioning cools and dehumidifies incoming air as needed.

When the air conditioning is activated, it will be switched on and off automatically by the climate system as needed.

1 Tap the temperature button in the middle at the bottom of the center display to open Climate view.



Tap the air conditioning button.

➤ Air conditioning is activated/deactivated and the button lights up/goes out.

 **Note**

For optimal air conditioning function, close all the side windows and the panoramic roof\*.

**i Note**

The air conditioning cannot be activated when the fan speed is set to **Off**.

\* Option/accessory.

---

## 8.1.1.4. Activating and deactivating recirculation

The climate system's recirculation function helps shut out smog, smoke, exhaust fumes, etc. by reusing the air in the passenger compartment.

1 Tap the temperature button in the middle at the bottom of the center display to open Climate view.



Tap the air recirculation button.

➤ Air recirculation is activated/deactivated and the button lights up/goes out.

**! Important**

If the air in the vehicle is recirculated too long, there is a risk of fogging on the inside of the windows.

**i Note**

Recirculation cannot be activated when the max defroster is on.

**i Note**

If the system's air quality sensors detect contaminants in the outside air, the air intake closes and air circulation activates automatically.

---

## 8.1.1.5. Activating and deactivating the recirculation timer setting

The content of this manual represents the status of the user manual at the time of printing and may not be completely valid in future instances. For more information refer to the first page for the complete disclaimer note.

The climate system's recirculation function helps shut out smog, smoke, exhaust fumes, etc. by reusing the air in the passenger compartment.

When the recirculation timer is activated, air recirculation will switch off automatically after 20 minutes.

- 1 Tap the temperature button in the middle at the bottom of the center display to open Climate view.
- 2 Press ...
- 3 Choose a setting under **Recirculation timer** to activate/deactivate the air recirculation timer.

---

## 8.1.1.6. Setting the temperature for the front seats <sup>[1]</sup>

The temperature can be set to the desired number of degrees for the front seat climate zones.

- 1 Tap the temperature button at the bottom in the middle of the center display to open the control. <sup>[2]</sup>
  - 2 Tap the arrows next to the temperature to raise or lower the temperature. When the temperature is synchronized, you can also tap directly on the arrows without having to press the temperature button first.
- The temperature will be set and the button will display the new temperature.

### Note

Heating/cooling cannot be accelerated by choosing a higher/lower temperature than the desired temperature.

<sup>[1]</sup> The same setting applies to the rear seats with the 2-zone climate system.

<sup>[2]</sup> If temperature synchronization has been deactivated, the current temperature for both the driver's and passenger sides will be shown.

---

## 8.1.1.7. Synchronize temperature

By default, the temperature in the vehicle's various climate zones is synchronized with the set temperature for the driver's side, but it is possible to deactivate the synchronization and set the temperature separately for the different climate zones.

## Deactivating temperature synchronization

1 Tap the temperature button at the bottom in the middle of the center display to open the control.



Tap the synchronization button between the temperature controls.

- The temperature can now be set separately for the individual climate zones. The set temperature is now shown separately on the driver's and passenger's sides in the climate bar instead of only in the middle.

Temperature synchronization can also be deactivated by changing the temperature on the passenger side.

## Resetting synchronized temperature

1 Tap the temperature button for the driver's or passenger's side at the bottom of the center display to open the control.



Tap the synchronization button between the temperature controls.

- The temperature for all zones in the vehicle is synchronized with the set temperature on the driver's side.

---

## 8.1.1.8. Adjusting air distribution

Air distribution can be adjusted manually if needed.

1 Tap the temperature symbol in the middle at the bottom of the center display to open Climate view.

2 The air distribution buttons in the Climate view are located in the middle around the **AUTO** button, from top to bottom:

- Air distribution - windshield defrost vents
- Air distribution - dashboard and center console air vents
- Air distribution - floor air vents

Tap one or more air distribution buttons to open/close the airflow for that vent.

- The air distribution changes and the buttons will light up or go out.

If all air distribution buttons are deselected in manual mode, the climate control system will revert to automatic mode.

---

## 8.1.2. Climate controls for seats and steering wheel

---

### 8.1.2.1. Activating and deactivating the heated steering wheel\*

The steering wheel can be heated for added comfort in cold weather.



Tap the driver's side seat button at the bottom of the center display to show the control for steering wheel heating.



Tap the steering wheel heating button repeatedly to turn on/off heating and to switch between the three heat levels.

➤ The level is changed and the set level is displayed in the button.

\* Option/accessory.

---

### 8.1.2.2. Activating and deactivating automatic steering wheel heating\*

The steering wheel can be heated for added comfort in cold weather.

Automatic start of heated steering wheel can be set to be activated/deactivated when the driver gets into the vehicle.<sup>[1]</sup> With automatic start activated, heating will be turned on at low ambient temperatures.

1 Tap the temperature button in the middle at the bottom of the center display to open Climate view.

The content of this manual represents the status of the user manual at the time of printing and may not be completely valid in future instances. For more information refer to the first page for the complete disclaimer note.

2 Press ...

3 Choose a setting under **Auto steering wheel heat** to activate/deactivate automatic start of heated steering wheel.

\* Option/accessory.

[1] Usage mode Comfort

---

## 8.1.2.3. Activating and deactivating the heated rear seats\*

The seats can be heated for added comfort for the passengers in cold weather.

With 2-zone system:



Buttons for seat heating on the rear side of the tunnel console.

Press the left or right seat heating buttons on the back of the tunnel console to turn on/off seat heating and switch between the three heating levels.

➤ The level is changed and the indicator lights in the button display the level.

With 4-zone system\*:



Seat heating controls and indicator lights on the rear side of the tunnel console.

Press repeatedly on the left or right seat heating buttons on the climate panel on the tunnel console to select one of four heating levels.

➤ The level will be changed and the climate panel screen will show the new level.

 **Warning**

Heated seats should not be used by people who have difficulty detecting temperature increases due to nerve damage or numbness or who for another reason may have difficulty operating the controls for seat heating.

\* Option/accessory.

## 8.1.2.4. Activating and deactivating power front seats\*

The seats can be heated for added comfort for the driver and passengers in cold weather.



Tap the seat button for the driver's or passenger's side at the bottom of the center display to open the control for seat heating.



Tap the seat heating button repeatedly to turn on/off heating and to switch between the three heat levels.

The content of this manual represents the status of the user manual at the time of printing and may not be completely valid in future instances. For more information refer to the first page for the complete disclaimer note.

- The level is changed and the set level is displayed in the button.

 **Warning**

Heated seats should not be used by people who have difficulty detecting temperature increases due to nerve damage or numbness or who for another reason may have difficulty operating the controls for seat heating.

\* Option/accessory.

---

## 8.1.2.5. Activating and deactivating the heated front seat \*

The seats can be heated for added comfort for the driver and passengers in cold weather.

Automatic start of heated seats can be set to be activated/deactivated when the driver gets into the vehicle.<sup>[1]</sup> With automatic start activated, heating will be turned on at an ambient temperature of 10 °C (50 °F) or lower.

- 1 Tap the temperature button in the middle at the bottom of the center display to open Climate view.
- 2 Press •••
- 3 Choose a setting under **Auto driver seat heat** and **Auto passenger seat heat** to activate/deactivate automatic start of heated driver's and passenger's seat.

\* Option/accessory.

<sup>[1]</sup> Usage mode Comfort

---

## 8.1.3. Climate controls for windows and mirrors

### 8.1.3.1. Activating and deactivating the heated rear window and door mirrors

The heated rear window and door mirrors are used to quickly remove condensation and ice from the glass.



## Activating and deactivating the heated rear window and door mirrors from the center console

A button in the center console offers quick access to the heated rear window and door mirrors functions.



Button in center console.

- 1 Tap the button.
  - > Heated windows and door mirrors are activated and the button lights up/goes out.

## Activating and deactivating the heated rear window and door mirrors from the center display

- 1 Tap the temperature button in the middle at the bottom of the center display to open Climate view.



Tap the button for heated rear window and door mirrors.

- > Heated windows and door mirrors are activated and the button lights up/goes out.

---

### 8.1.3.2. Automatically activating and deactivating the heated rear window and door mirrors

The heated rear window and door mirrors are used to quickly remove condensation and ice from the glass.

Automatic start of heated rear window and door mirrors can be set to be activated/deactivated when the driver gets into the vehicle.<sup>[1]</sup> With automatic start activated, heating will be turned on when there is a risk of ice or condensation on the windows or mirrors. Heating is automatically switched off when the window or door mirror is sufficiently warm and the condensation or ice is gone.

- 1 Tap the temperature button in the middle at the bottom of the center display to open Climate view.
- 2 Press ...
- 3 Choose a setting under **Auto rear defroster** to activate/deactivate automatic start of heated rear window and door mirrors.

<sup>[1]</sup> Usage mode Comfort

---

### 8.1.3.3. Activating and deactivating the heated windshield\*

Windshield heating is used to quickly remove condensation and ice from the windshield.

## Activating and deactivating windshield heating from the center console

A button in the center console is used to quickly access windshield heating.



Button in center console.

- 1 Press the button repeatedly to switch between the three levels:
    - Activated windshield heating
    - Activated windshield heating and max defroster
    - Deactivated.
- The heated windshield and max defroster are activated/deactivated and the button lights up/goes out.

## Activating and deactivating windshield heating from the center display

- 1 Tap the temperature button in the middle at the bottom of the center display to open Climate view.



Tap the button for heated windshield.

- The heated windshield is activated/deactivated and the button lights up/goes out.

### Note

Triangular areas at the far sides of the windshield are not heated and will take slightly longer to defrost/de-ice.

 **Note**

The heated windshield may affect the performance of transponders and other communication equipment.

\* Option/accessory.

---

## 8.1.3.4. Activating and deactivating automatic windshield heating\*

Windshield heating is used to quickly remove condensation and ice from the windshield.

Automatic start of heated windshield can be set to be activated/deactivated when the driver gets into the vehicle.<sup>[1]</sup> With automatic start activated, heating will be turned on when there is a risk of ice or condensation on the windows or mirrors. Heating is automatically switched off when the window or door mirror is sufficiently warm and the condensation or ice is gone.

- 1 Tap the temperature button in the middle at the bottom of the center display to open Climate view.
- 2 Press **•••**
- 3 Choose a setting under **Auto front defroster** to activate/deactivate automatic start of heated rear window and door mirrors.

\* Option/accessory.

<sup>[1]</sup> Usage mode Comfort

---

## 8.1.3.5. Activating and deactivating max defroster

Max defroster is used to quickly remove condensation and ice from windows.

Max defroster deactivates automatic climate control and air recirculation, activates the air conditioning, and changes blower speed to **5** and temperature to **HI**.

 **Note**

The volume increases when the blower speed is changed to **5**.

When max defroster is deactivated, the climate system reverts to the previous settings.

## Activating and deactivating max defroster from the center console

A button in the center console offers quick access to the max defroster.

For models with heated windshields\*, tapping the button once activates the windshield heating and a second tap activates the max defroster. A third tap deactivates both.



Button in center console.

Vehicles without a heated windshield:

- 1 Tap the button.
  - Max defroster is activated/deactivated and the button lights up/goes out. While max defroster is activated, the temperature in the different climate zones is not synchronized.

Vehicles with a heated windshield:

- 1 Press the button repeatedly to switch between the three levels:
  - Activated windshield heating
  - Activated windshield heating and max defroster
  - Deactivated.
  - The heated windshield and max defroster are activated/deactivated and the button lights up/goes out.

### Note

The max defroster starts after a slight delay to avoid a brief increase in blower speed if the heated windshield function has been deactivated by pressing the button twice in quick succession.

## Activating and deactivating max defroster from the center display

The content of this manual represents the status of the user manual at the time of printing and may not be completely valid in future instances. For more information refer to the first page for the complete disclaimer note.

1 Tap the temperature button in the middle at the bottom of the center display to open Climate view.



Tap the max defroster button.

- Max defroster is activated/deactivated and the button lights up/goes out. While max defroster is activated, the temperature in the different climate zones is not synchronized.

\* Option/accessory.

---

## 8.1.4. Climate system controls

The climate system functions are controlled from physical buttons on the center console, the center display, and the climate panel on the rear side of the tunnel console\*.

### Physical buttons in the center console

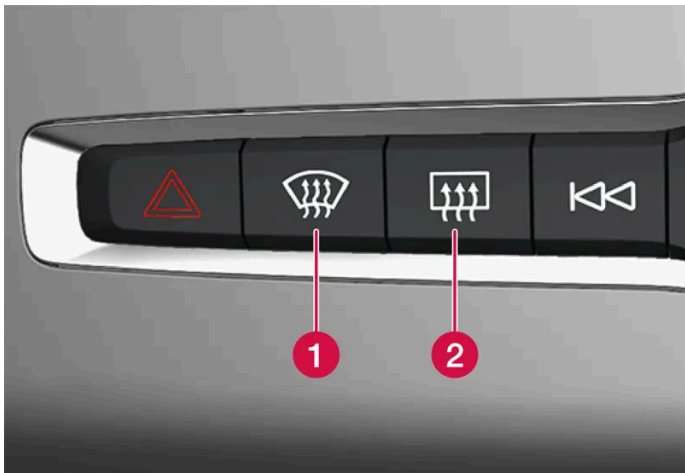

1 Button for heated windshield\* and max defroster.

2 Button for heated rear window and door mirrors.

### Climate buttons in the center display

The most common climate functions are always available at the bottom of the center display.

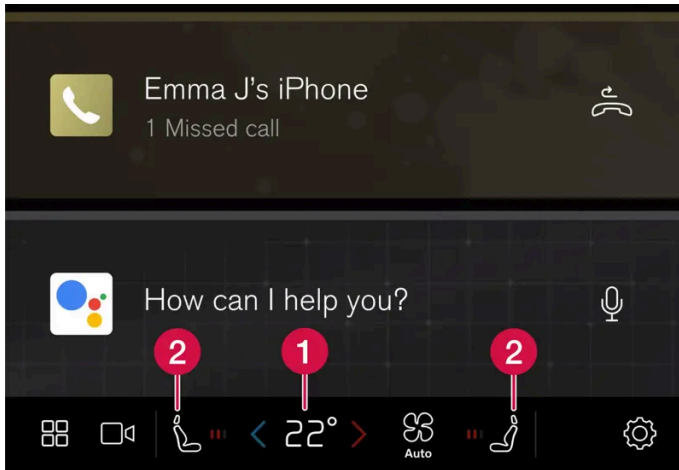

1 Temperature controls for driver and passenger side. <sup>[1]</sup>

2 Controls for heated\* driver and front passenger seat, as well as heated steering wheel\*.

## Climate view in the center display

Tap the fan symbol or the temperature button in the middle at the bottom of the center display to open Climate view.

### Main climate

In addition to the climate functions that can always be accessed in the center display, other main climate functions can also be controlled under **Main climate**.



Control for max defroster.



Controls for heated windshield.



Air conditioning controls.



Air recirculation controls.



Control for heated rear window and door mirrors.

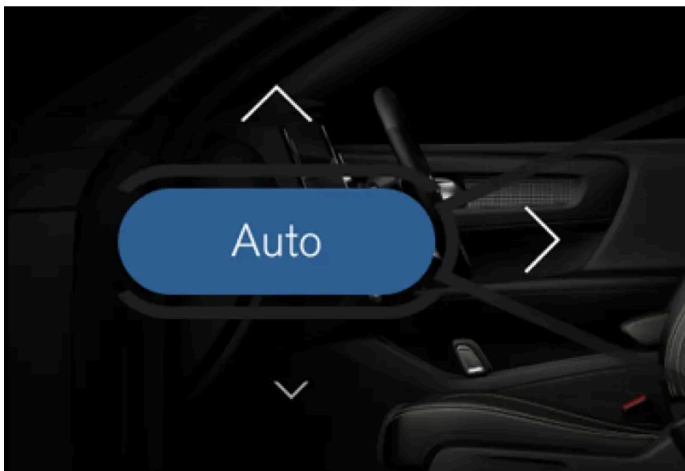

Button for auto-regulation of climate control and arrows for air distribution.

#### **Parking climate**

The vehicle's parking climate can be controlled under **Parking**.

#### **Settings**

Additional climate settings can be adjusted under **•••**.

### **Physical buttons at the rear of the tunnel console \***

There are physical buttons on the rear side of the tunnel console for adjusting rear seat heating.

\* Option/accessory.



[1] If temperature synchronization has been deactivated, the current temperature for both the driver's and passenger sides will be shown.

---

## 8.2. Air distribution

---

### 8.2.1. Activating and deactivating recirculation

The climate system's recirculation function helps shut out smog, smoke, exhaust fumes, etc. by reusing the air in the passenger compartment.

1 Tap the temperature button in the middle at the bottom of the center display to open Climate view.



Tap the air recirculation button.

> Air recirculation is activated/deactivated and the button lights up/goes out.

 **Important**

If the air in the vehicle is recirculated too long, there is a risk of fogging on the inside of the windows.

 **Note**

Recirculation cannot be activated when the max defroster is on.

 **Note**

If the system's air quality sensors detect contaminants in the outside air, the air intake closes and air circulation activates automatically.

---

### 8.2.2. Activating and deactivating the recirculation timer setting

The content of this manual represents the status of the user manual at the time of printing and may not be completely valid in future instances. For more information refer to the first page for the complete disclaimer note.

The climate system's recirculation function helps shut out smog, smoke, exhaust fumes, etc. by reusing the air in the passenger compartment.

When the recirculation timer is activated, air recirculation will switch off automatically after 20 minutes.

- 1 Tap the temperature button in the middle at the bottom of the center display to open Climate view.
- 2 Press ⋮
- 3 Choose a setting under **Recirculation timer** to activate/deactivate the air recirculation timer.

---

## 8.2.3. Activating and deactivating max defroster

Max defroster is used to quickly remove condensation and ice from windows.

Max defroster deactivates automatic climate control and air recirculation, activates the air conditioning, and changes blower speed to 5 and temperature to HI.

**Note**

The volume increases when the blower speed is changed to 5.

When max defroster is deactivated, the climate system reverts to the previous settings.

### Activating and deactivating max defroster from the center console

A button in the center console offers quick access to the max defroster.

For models with heated windshields\*, tapping the button once activates the windshield heating and a second tap activates the max defroster. A third tap deactivates both.



Button in center console.

Vehicles without a heated windshield:

- 1 Tap the button.
  - Max defroster is activated/deactivated and the button lights up/goes out. While max defroster is activated, the temperature in the different climate zones is not synchronized.

Vehicles with a heated windshield:

- 1 Press the button repeatedly to switch between the three levels:
  - Activated windshield heating
  - Activated windshield heating and max defroster
  - Deactivated.
  - The heated windshield and max defroster are activated/deactivated and the button lights up/goes out.

***i* Note**

The max defroster starts after a slight delay to avoid a brief increase in blower speed if the heated windshield function has been deactivated by pressing the button twice in quick succession.

## Activating and deactivating max defroster from the center display

- 1 Tap the temperature button in the middle at the bottom of the center display to open Climate view.



Tap the max defroster button.

- Max defroster is activated/deactivated and the button lights up/goes out. While max defroster is activated, the temperature in the different climate zones is not synchronized.

\* Option/accessory.

## 8.2.4. Air distribution

The climate system distributes incoming air through a number of vents in the passenger compartment.

### Automatic and manual air distribution

When the auto-climate feature is on, air distribution is regulated automatically. Air distribution can also be controlled manually.

### Adjustable air vents

Certain air vents in the vehicle are adjustable, which means they can be opened/closed and the direction of the air flow from the vent can be adjusted.

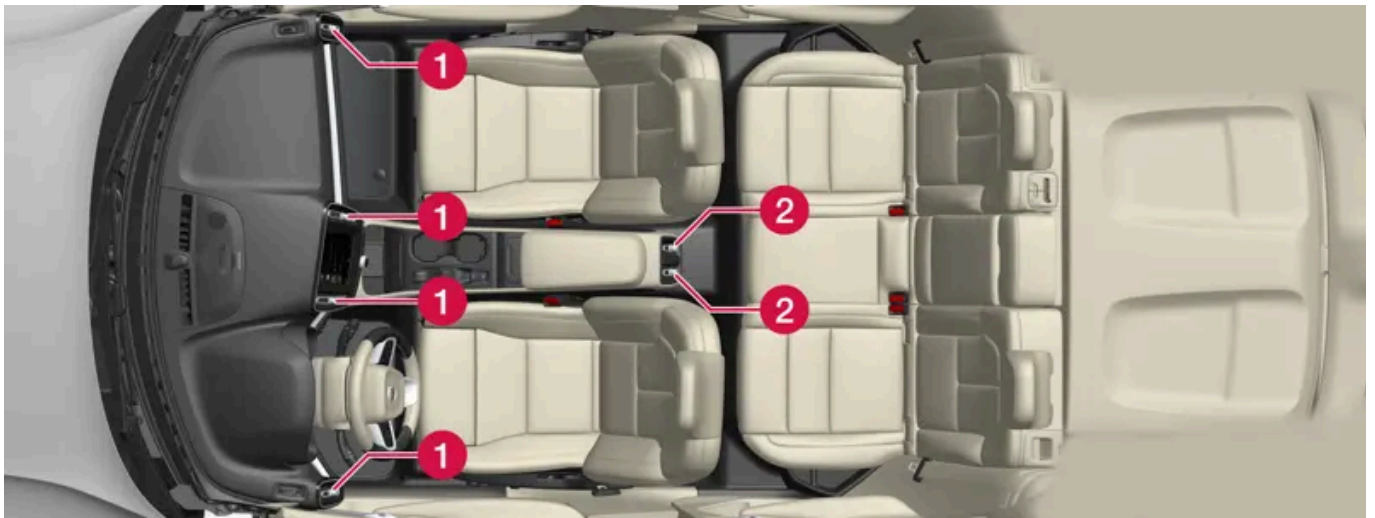

Location of adjustable air vents in the passenger compartment.

- ① With 1-zone climate system - four on dashboard.
- ② 2-zone climate system\* - two additional vents on the rear side of the tunnel console.

\* Option/accessory.

---

## 8.2.5. Adjusting air distribution

Air distribution can be adjusted manually if needed.

- 1 Tap the temperature symbol in the middle at the bottom of the center display to open Climate view.
- 2 The air distribution buttons in the Climate view are located in the middle around the **AUTO** button, from top to bottom:
  - Air distribution - windshield defrost vents
  - Air distribution - dashboard and center console air vents
  - Air distribution - floor air vents

The content of this manual represents the status of the user manual at the time of printing and may not be completely valid in future instances. For more information refer to the first page for the complete disclaimer note.

Tap one or more air distribution buttons to open/close the airflow for that vent.

- The air distribution changes and the buttons will light up or go out.  
If all air distribution buttons are deselected in manual mode, the climate control system will revert to automatic mode.

---

## 8.2.6. Opening, closing and directing air vents

Some of the air vents in the passenger compartment can be individually opened, closed and directed.

Misting can be eliminated by directing the outer air vents towards the door windows.

Direct the outer air vents into the passenger compartment to maintain a comfortable temperature in warm weather.

### Opening and closing the air vents

- 1 Turn the knob in the center of the air vent to open/close airflow from the vent.  
When the mark on the knob is vertical, the airflow is strongest.

### Directing air flow

- 1 Move the lever in the center of the air vent horizontally or vertically to direct the airflow from the vent.

---

## 8.3. Air quality

### 8.3.1. Air quality

The materials used in the passenger compartment and air purification system have been selected to ensure a high level of air quality in the passenger compartment.

#### Materials used in the passenger compartment

The materials in the passenger compartment are designed to be pleasant and comfortable, even for people with asthma or allergies.

The materials have been developed and tested to reduce dust in the passenger compartment and make it easier to keep clean.

The mats in both the passenger compartment and cargo compartment can be easily removed for cleaning.

Use Volvo-recommended cleaning agents and car care products to clean the interior.

## Air purification system

In addition to the passenger compartment air filter, the vehicle is also equipped with an air purification system that helps you maintain high air quality in the passenger compartment.

---

### 8.3.2. CleanZone \*

The CleanZone function monitors the conditions affecting good air quality in the passenger compartment and indicates whether they are fulfilled or not.

If the conditions are not met, the text **CleanZone** will be shown in white in Climate view.

When all the conditions are met, the text will change to blue.

The following conditions must be met:

- All doors and tailgate are closed.
- All side windows and panoramic roof\* are closed.
- The Interior Air Quality System \* is activated.
- The blower is activated.
- Air recirculation is deactivated.

#### Note

CleanZone does not indicate that the air quality is good, but only that the conditions for good air quality have been met.

\* Option/accessory.

---

### 8.3.3. Clean Zone Interior Package \*

Clean Zone Interior Package (CZIP) is a series of modifications that filters even more allergy and asthma-inducing substances and other pollutants from the passenger compartment.

CZIP includes the following:

**The content of this manual represents the status of the user manual at the time of printing and may not be completely valid in future instances. For more information refer to the first page for the complete disclaimer note.**

- An enhanced function that starts the blower when the vehicle is unlocked using the key. The blower will then fill the passenger compartment with fresh air. The function starts when required and switches off automatically after a period of time or when one of the passenger compartment doors is opened. The amount of time the blower runs gradually decreases due to reduced need up until the vehicle is 4 years old.
- The fully automatic Interior Air Quality System (IAQS).

\* Option/accessory.

---

## 8.3.4. Interior Air Quality System \*

Interior Air Quality System (IAQS) is a fully automatic air quality system that removes gases and particles to reduce odors and contaminants in the passenger compartment.

IAQS is part of the Clean Zone Interior Package (CZIP) and removes air contaminants such as particles, hydrocarbons, nitric oxides and ground-level ozone.

If the system's air quality sensors detect contaminants in the outside air, the air intake closes and air recirculation is activated.

### Note

The air quality sensor should always be connected so that it can help improve the air quality in the passenger compartment.

Recirculation is limited in cold weather to prevent fogging.

In the event of fogging, use the defroster functions for the windshield, side windows and rear window.

\* Option/accessory.

---

## 8.3.5. Activating and deactivating the air quality sensor \*

The air quality sensor is part of the fully automated Interior Air Quality System (IAQS).

The air quality sensor can be switched on or off.

- 1 Tap the temperature button in the middle at the bottom of the center display to open Climate view.
- 2 Tap **•••** in Climate view.
- 3 Choose a setting under **Air quality sensor** to activate/deactivate the air quality sensor.

\* Option/accessory.

---

## 8.3.6. Passenger compartment air filter

All air entering the passenger compartment through the climate control system intake is filtered.

### Replacing the passenger compartment filter

To maintain the high performance of the climate control system, the filter must be replaced regularly. Follow Volvo's service schedule for recommended replacement intervals. When driving in areas with a lot of smog, dust, etc., the filter may need to be changed more frequently.

 **Note**

There are two types of passenger compartment filters. Make sure that the correct filter is installed.

---

## 8.3.7. Air purification \*

Air purification is used to improve the air quality in the passenger compartment before driving.

It is possible to activate air purification manually from the center display, but the function is also started automatically when preconditioning has finished.

The function uses the ventilation system to blow fresh air into the passenger compartment and then circulates the air through the climate system's passenger compartment air filter.

The amount of small particulates (PM<sub>2,5</sub>) in the passenger compartment can be monitored in the Volvo Cars app during the pre-cleaning cycle.

\* Option/accessory.

---

## 8.3.8. Starting and stopping air purification \*

Air purification improves the air quality in the passenger compartment before driving.

The function can be started directly from the center display or the Volvo Cars app.

- 1 Tap the temperature button in the middle at the bottom of the center display to open Climate view.



2 Tap **Parking**.

3 Tap **Start air purification** to start air purification immediately.

 **Note**

Air purification\* starts automatically when preconditioning is complete.  
Windows and doors must be closed for air purification to be performed.

\* Option/accessory.

---

## 8.3.9. Air Quality app

The Air Quality app is a service that visualizes the measured concentration of airborne particulate matter inside and outside the vehicle over time.

A climate sensor measures the concentration of PM<sub>2.5</sub> particles (particles smaller than 2.5 µm) in the passenger compartment<sup>[1]</sup>. Measurements of pollutants outside the vehicle are provided by an external service and based on modeled data.

<sup>[1]</sup> Availability of pollen data depends on market.

---

## 8.4. Parking climate

---

### 8.4.1. Preconditioning

---

#### 8.4.1.1. Preconditioning\*

Preconditioning is a climate function that, if possible, attempts to achieve a comfortable temperature in the passenger compartment before driving.

Preconditioning can be started immediately or started at a preset time using a timer from the center display. It can also be started from a device that has the Volvo Cars app\*.

The content of this manual represents the status of the user manual at the time of printing and may not be completely valid in future instances. For more information refer to the first page for the complete disclaimer note.

In warm weather, the climate system ventilates the passenger compartment by blowing air in from outside. The function cannot heat the passenger compartment.

**i Note**

During preconditioning of the passenger compartment, the vehicle works to reach a comfortable temperature and not the temperature set in the climate system.

**i Note**

Air purification\* starts automatically when preconditioning is complete.  
Windows and doors must be closed for air purification to be performed.

\* Option/accessory.

---

## 8.4.1.2. Starting and stopping preconditioning

Preconditioning heats or cools the passenger compartment, if possible, before driving. The function can be started directly from the center display or the Volvo Cars app.

- 1 Tap the temperature button in the middle at the bottom of the center display to open Climate view.
- 2 Tap **Parking**.
- 3 Tap **Start heating/cooling** to start preconditioning immediately.

**i Note**

The vehicle doors and windows should be closed during preconditioning of the passenger compartment.

**i Note**

Air purification\* starts automatically when preconditioning is complete.  
Windows and doors must be closed for air purification to be performed.

 **Note**

When the vehicle starts driving<sup>[1]</sup>, preconditioning is switched off.

\* Option/accessory.

<sup>[1]</sup> Usage mode Drive

---

### 8.4.1.3. Preconditioning timer

The timer can be set to finish preconditioning at a predetermined time.

The timer can store up to 8 preset times for

- a time on one or more days of the week, with or without the repeat function.

---

### 8.4.1.4. Activating and deactivating preconditioning timer

Timer settings in the preconditioning timer can be activated or deactivated as needed.

- 1 Open Climate view in the center display.
- 2 Select the **Parking** tab.
- 3 Activate/deactivate a timer setting by tapping the button to the right of the setting.
  - The timer is activated/deactivated and the button lights up/goes out.

---

### 8.4.1.5. Deleting preconditioning timer settings

A preconditioning timer setting that is no longer needed can be deleted.

- 1 Open Climate view in the center display.
- 2 Select the **Parking** tab.
- 3 Tap the timer setting you would like to delete.

4 Press **Delete timer**.

➤ The timer setting is deleted.

---

## 8.4.1.6. Adding and editing timer settings for preconditioning

The preconditioning timer can store up to 8 preset timer settings.

### Adding a timer setting

- 1 Open Climate view in the center display.
- 2 Select the **Parking** tab.
- 3 Tap **Timers**.
- 4 Tap **Add new timer**.

 **Note**

It is not possible to add a time setting if there are already 8 settings for the timer. Delete a time setting to be able to add a new one.

- 5 Set a time for one or more days of the week. Activate/deactivate repeat by tapping to **Repeat weekly**.
  - 6 Tap **Set timer**.
- The timer setting will be added to the list and activated.

### Editing the timer setting

- 1 Open Climate view in the center display.
- 2 Select the **Parking** tab.
- 3 Tap the timer setting you would like to change.  
➤ A pop-up window will appear.
- 4 To edit a timer setting, follow the procedures described under the heading "Adding a timer setting" above.

---

## 8.4.2. Pre-cleaning

---

### 8.4.2.1. Air purification \*

Air purification is used to improve the air quality in the passenger compartment before driving.

It is possible to activate air purification manually from the center display, but the function is also started automatically when preconditioning has finished.

The function uses the ventilation system to blow fresh air into the passenger compartment and then circulates the air through the climate system's passenger compartment air filter.

The amount of small particulates (PM<sub>2.5</sub>) in the passenger compartment can be monitored in the Volvo Cars app during the pre-cleaning cycle.

\* Option/accessory.

---

### 8.4.2.2. Starting and stopping air purification \*

Air purification improves the air quality in the passenger compartment before driving.

The function can be started directly from the center display or the Volvo Cars app.

- 1 Tap the temperature button in the middle at the bottom of the center display to open Climate view.
- 2 Tap **Parking**.
- 3 Tap **Start air purification** to start air purification immediately.

 **Note**

Air purification \* starts automatically when preconditioning is complete.

Windows and doors must be closed for air purification to be performed.

\* Option/accessory.

### 8.4.3. Parking climate \*

Parking climate is an umbrella term for various functions that improve the passenger compartment climate when the vehicle is parked, e.g. preconditioning.

Parking climate functions are controlled from the **Parking** tab in the center display's Climate view. Tap the temperature symbol in the middle at the bottom of the center display to open Climate view.



\* Option/accessory.

---

### 8.4.4. Parking climate symbols and messages \*

A number of symbols and messages related to parking climate may be displayed in the instrument panel.

Messages related to parking climate can also be displayed in a device that has the Volvo Cars\* app.

Symbol	Message	Meaning
	Parking climate Service required	Parking climate is not functioning properly. Contact a workshop <sup>[1]</sup> to have the system checked as soon as possible.
	Parking climate Temporarily unavailable	Parking climate is temporarily not functioning properly.
	Parking climate unavailable Desired temperature reached	Parking climate will not run because the heating need is low.

\* Option/accessory.

[1] An authorized Volvo workshop is recommended.

---

### 8.4.5. Climate comfort retaining function \*

The climate in the passenger compartment can be maintained when the vehicle is parked, e.g. if the engine is turned off but the driver or passengers remain in the vehicle.

This function can only be direct-started from the center display.

The function utilizes several of the vehicle's systems:

- Residual heat from the engine is used to help heat the passenger compartment to a comfortable temperature.
- In warm weather, the ventilation system cools the passenger compartment by blowing air in from outside.

 **Warning**

Never leave children or people who cannot exit the vehicle without help alone in the vehicle.

 **Note**

Climate comfort maintenance will be deactivated if the vehicle is locked from the outside in order to avoid using residual engine heat unnecessarily. This function is intended to be used to maintain climate comfort when the driver or a passenger remains in the vehicle after the engine is turned off.

The climate comfort retaining function is limited in duration in cold weather depending on the amount of residual warmth available.

\* Option/accessory.

## 8.4.6. Starting and switching off the climate retaining function when parking\*

The climate retaining function maintains the climate settings in the vehicle after the engine has been switched off. The function can be activated in the center display.



Tap the symbol in the center of the climate bar to open Climate view in the center display.

2 Tap **Use heat from drive** to start climate comfort.

> The climate comfort retaining function will be activated/deactivated and the button light will go on/off.

 **Note**

Maintained climate comfort is not possible when there is not sufficient residual engine heat to maintain the climate settings in the passenger compartment, or if the outside temperature is above approximately 20 °C (68 °F).

 **Note**

Climate comfort maintenance will be deactivated if the vehicle is locked from the outside in order to avoid using residual engine heat unnecessarily. This function is intended to be used to maintain climate comfort when the driver or a passenger remains in the vehicle after the engine is turned off.

The climate comfort retaining function is limited in duration in cold weather depending on the amount of residual warmth available.

\* Option/accessory.

---

## 8.5. Climate

The vehicle is equipped with electronic climate control. The climate system cools, heats and dehumidifies the air in the passenger compartment.

All of the climate system functions are controlled from the center display and the buttons on the center console.

Certain rear seat functions can also be controlled from the climate controls\* on the rear of the tunnel console.

Most climate functions can also be controlled via voice control. Certain functions require an internet connection to be voice controlled.

 **Note**

The climate system can be used to cool down the media system in the center display if needed. In these cases, the message **Cooling infotainment system** will be shown in the instrument panel.

\* Option/accessory.

---

## 8.6. Climate control system service

Service and repairs on the air conditioning system should only be done by an authorized workshop.

### Troubleshooting and repairs

The air conditioning system contains a fluorescent tracer substance. Ultraviolet light is used to search for leaks.

Volvo recommends contacting an authorized Volvo workshop.

The climate system in the vehicle uses a freon-free R1234yf refrigerant. For information regarding the refrigerant, refer to the decal located on the inside of the hood.



 **Warning**

The air conditioning system contains the refrigerant R1234yf under pressure. In accordance with SAE J2845 (Technician Training for Safe Service and Containment of Refrigerants Used in Mobile A/C System), service and repairs to the refrigerant system may only be performed by trained and certified technicians in order to ensure the safety of the system.

## 8.7. Climate control sensors

The climate system has a number of sensors to help regulate the climate settings in the vehicle. Do not cover or block the sensors with clothing or other objects.

### Location of the sensors

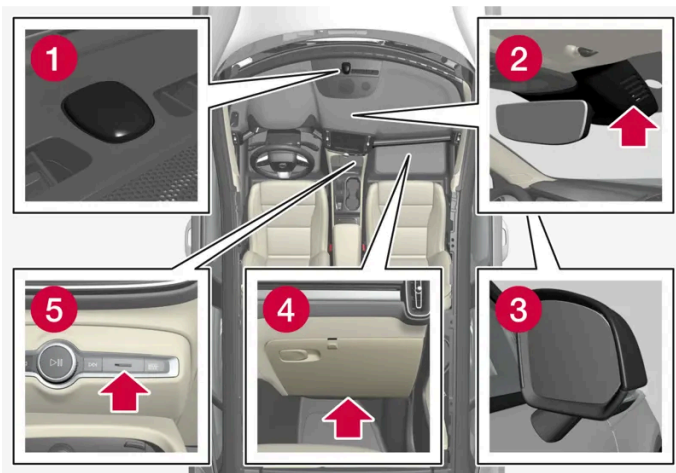

- 1 Sunlight sensors - on the upper side of the dashboard.
- 2 Humidity sensor - in the rearview mirror console.
- 3 Ambient temperature sensor - in the right-side door mirror.
- 4 Airborne particulate matter sensor\* – on the underside of the glove compartment.
- 5 Passenger compartment temperature sensor - near the buttons in the center console.

On vehicles equipped with the Interior Air Quality System\*, there is also an air quality sensor in the climate system's air intake.

\* Option/accessory.

## 8.8. Climate zones

The vehicle is divided into climate zones to make it possible to set different temperatures for different parts of the passenger compartment.

## 2-zone climate system

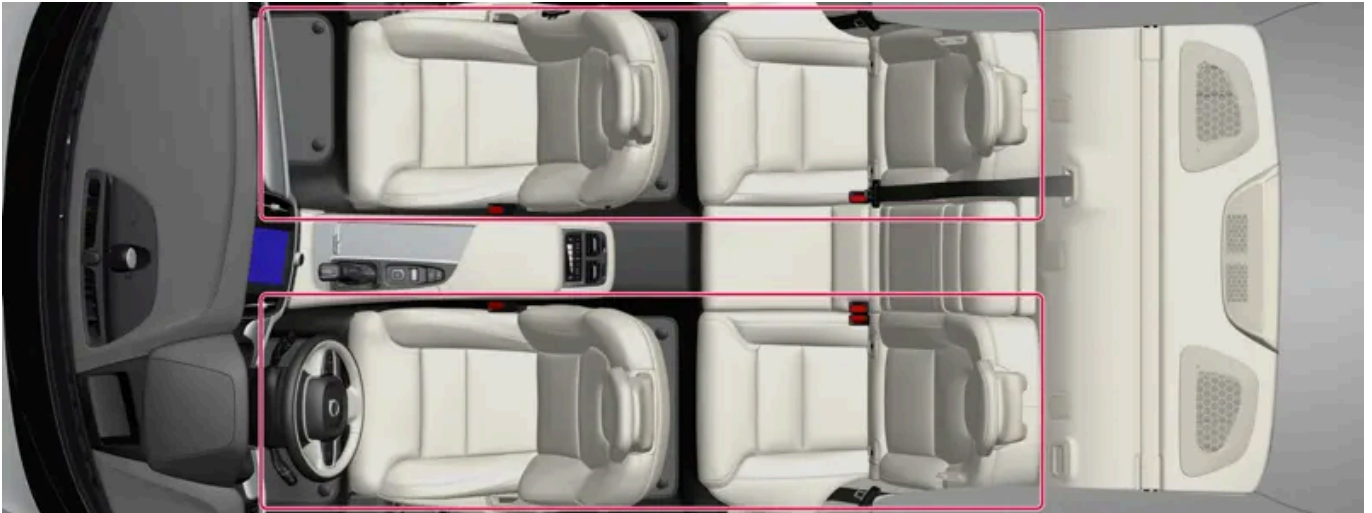

Climate zones with 2-zone climate system.

In 2-zone climate systems, the passenger compartment temperature can be set separately for the left and right sides of the vehicle.

## 4-zone climate system \*

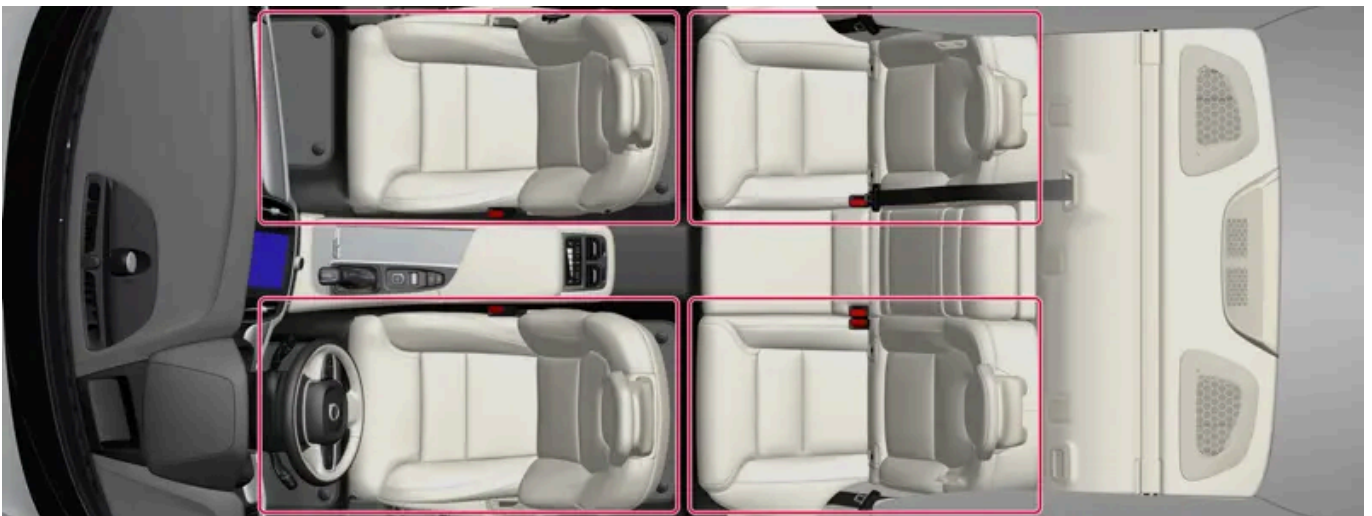

Climate zones with 4-zone climate system.

In 4-zone climate systems, the passenger compartment temperature can be set separately for the left and right sides of the vehicle, and for the front and rear seats.

\* Option/accessory.

---

## 8.9. Perceived temperature

The content of this manual represents the status of the user manual at the time of printing and may not be completely valid in future instances. For more information refer to the first page for the complete disclaimer note.

The climate control system regulates the climate in the passenger compartment based on perceived temperature, not actual temperature.

The selected passenger compartment temperature is based on the physical perception of the current ambient temperature, air-flow speed, humidity, sunlight in the passenger compartment, etc.

The system has a sunlight sensor that detects which side of the vehicle the sunlight is shining on and adjusts the temperature accordingly. This means that the temperature of the air coming out of the vents may be different for the left and right sides, even if the temperature setting is the same for both sides.

---

## 9. Key, locks and alarm

---

### 9.1. Key

---

#### 9.1.1. User profiles

---

##### 9.1.1.1. User profiles

Many of the vehicle's settings can be saved in a personal user profile.

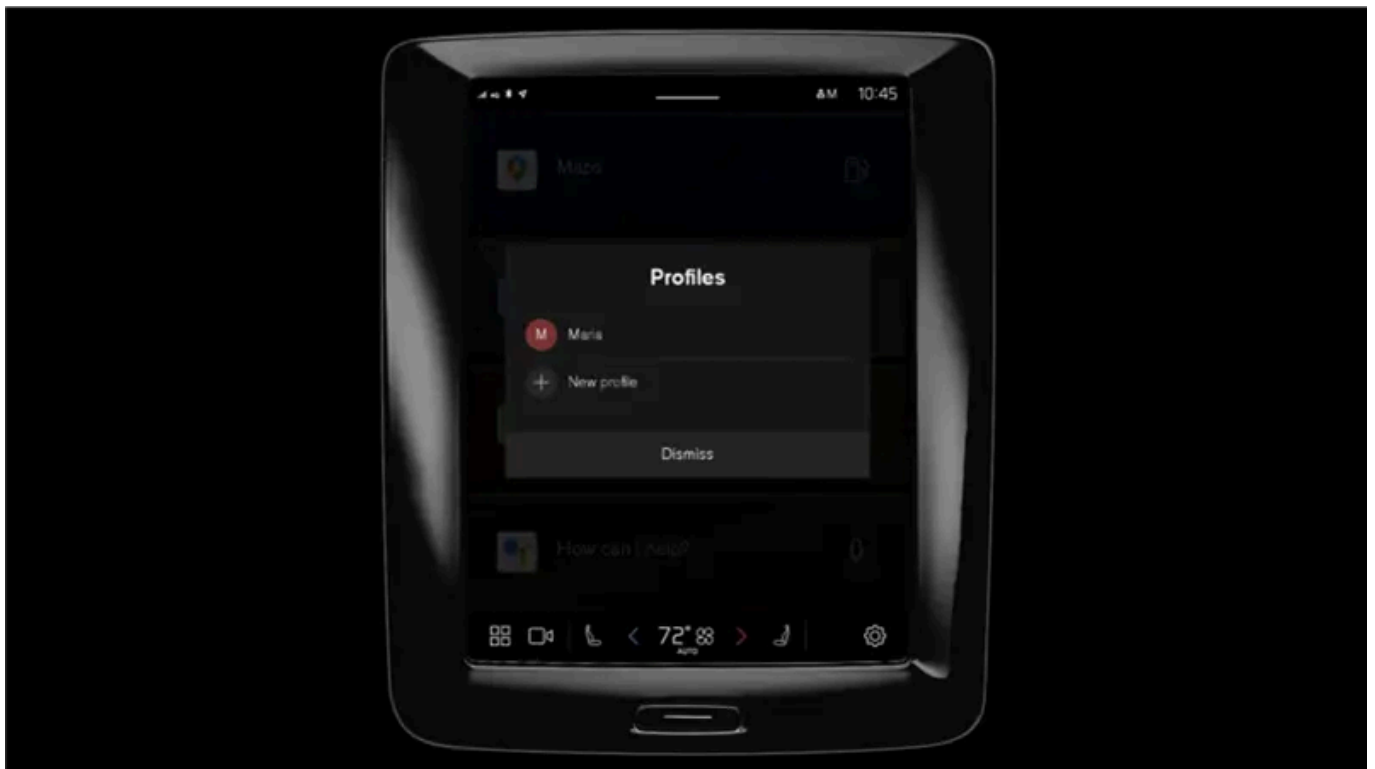

The first time the vehicle is used, or after a factory reset, the **Owner** profile is preinstalled and active in the vehicle.

The **Owner** profile has administrative rights and cannot be deleted.

Pull down Notifications view to access user profiles.

A  symbol is shown in the status bar along with the initials of the active profile. When the system is logged out, no symbol/initials will be shown in the status bar.

## Automatic profile selection

A key can be linked to a profile. This profile and all of its settings will then be selected every time this specific key is identified when unlocking or opening the driver's door.

The last-used profile will be activated if a key is not connected to a specific profile.

## General information about settings

Changes to the vehicle's settings can be saved in different ways depending on which category the settings belong to. The settings can be personal, global or customized for one driving cycle.

### Personal settings

Personal settings are saved to an active profile.

There are two sorts of personal settings:

- Function settings – settings related to driver support, driver's side climate control, the driver's seat, the power door mirrors, as well as interior and exterior lighting. These settings retain their values when a profile is added or when logging out from an active profile.
- Audio and media settings – settings related to navigation, audio and media system, apps and linked accounts. These settings go back to default values when a profile is added or when logging out from an active profile.

### Global settings

The global settings are not changed when the profile is changed. They remain the same regardless of which profile is currently active. Examples of global settings are passenger-side climate control, memory function for the passenger seat, and some system settings.

### Default settings for driving cycle

A number of settings revert to default settings<sup>[1]</sup> after one driving cycle.

These settings can be adjusted while driving. At the next driving cycle, the settings will revert to default values.

<sup>[1]</sup> Default settings may vary depending on market.

---

## 9.1.1.2. Connect key to user profile

A key can be linked to a profile. This profile and all of its settings will then be automatically selected every time this specific key is identified when unlocking or opening the driver's door.

The first time the key is used, it is not connected to any specific profile. The **Owner** profile or the last-used profile is automatically activated when the vehicle is started.

## Connecting a key to a profile

**Note**

If the key was previously linked to another profile, the link will be moved from the previous profile to the active profile.

- 1 Tap .
- 2 Select **Profiles**.
- 3 Select **Connect key to profile** to connect the selected key to a profile.

A profile can only be connected to the key currently being used in the vehicle. If there are any other keys in the vehicle, the message **More than one key found. Place the key you want to connect on the backup reader.** will be displayed



Location of the backup reader in the tunnel console.

## Disconnecting a key from a profile

- 1 Tap .
- 2 Select **Profiles**.
- 3 Select **Disconnect key from profile** to delete the active profile from the connected key.

A key can be deleted from a profile even if the key is not inside the vehicle.

---

### 9.1.1.3. Managing user profiles

It is possible to change to another profile even if the key used is connected to another profile.

## Creating a profile

- 1 Pull down Notifications view to access user profiles.
- 2 Tap on an active profile.
- 3 Select **New profile**.
- 4 The profile is created.
  - > The profile will be set as the active profile.

You will be guided through an interactive flow to set up the new profile. From here you can select to pair a phone with the vehicle or connect different accounts, e.g. Volvo ID, to the profile. Certain steps can be skipped to be finished later.

It is possible to create up to six different profiles.

## Selecting a profile

- 1 Pull down Notifications view to access user profiles.
- 2 Tap on an active profile.
- 3 Selectable profiles are shown.
- 4 Select a profile.
  - > The profile has now been selected and the system will load the settings stored in the selected profile.

### Note

To stop the seat's movement when switching to a different profile, press any of the buttons on the front seat cushion.

## Logging out of a profile

- 1 Pull down Notifications view to access user profiles.
- 2 Select **Log out**.
  - > You are logged out of the profile and it is no longer possible to access accounts connected to that profile.
- 3 The system goes into logged-out mode and changed settings are not saved to any profile.

 **Note**

Creating, selecting and logging out of a user profile is only possible when the vehicle is at a standstill.

## 9.1.1.4. Profile settings

From profile settings, among other things, it is possible to change profile name, add and delete connected keys, connect accounts (e.g. Volvo ID), activate screen lock and delete an active profile.

### Activating screen lock

When screen lock is activated, a passcode is required to use the active profile.

- 1 Tap .
- 2 Select **Profiles**.
- 3 Select **Screen lock**.
- 4 Select type of screen lock and activate.
  - The screen lock will be shown on the center display when switching to a profile with a passcode as well as each time the system is restarted.

### Deleting a profile

Settings that have been saved for one or more profiles can only be deleted when the vehicle is stationary.

- 1 Tap .
- 2 Select **Profiles**.
- 3 Select **Delete this profile**.
  - User information and connections linked to the profile are deleted.
- 4 The system goes into logged-out mode and changed settings are not saved to any profile.

### Becoming an administrator

A profile can be set as administrator.



- 1 Tap .
- 2 Select **Profiles**.
- 3 Select **Become an admin**.

## Changing a profile name

- 1 Tap .
- 2 Select **Profiles**.
- 3 Tap **Edit** next to the current profile name.
- 4 Change the profile name and confirm the change.

---

### 9.1.1.5. Connecting an account to a user profile

An account can be connected to the selected user profile. Examples of accounts that can be added are Volvo ID and Google account.

#### Adding an account

- 1 Tap .
- 2 Select **Profiles**.
- 3 Select **Accounts**.
- 4 Select to add an account.
  - A list will appear of the accounts that can be added.
- 5 Select an account.

Then follow the instructions provided. The instructions depend on what type of account is selected.

---

## 9.1.2. Electronic immobilizer

The content of this manual represents the status of the user manual at the time of printing and may not be completely valid in future instances. For more information refer to the first page for the complete disclaimer note.

The electronic immobilizer is a start inhibitor that helps prevent the vehicle from being started by an unauthorized person.

The vehicle can only be started with the right key.

The following instrument panel error messages are related to the electronic immobilizer:

Symbol	Message	Meaning
	The car key is not detected. See <b>Owner's Manual</b> for more information.	Key not recognized during start. Place the key on the key symbol in the tunnel console's storage compartment and try to start the vehicle again.

---

## 9.1.3. Keys

The vehicle's physical keys are available in different variants. The vehicle detects when a key is inside the front part of the passenger compartment, and can then be started.



Available key types are the standard key, the buttonless key (Key Tag)\*, and Care Key.<sup>[1]</sup>

The standard key and the Care Key are equipped with buttons. Additional keys than those included as standard can be ordered. For vehicles equipped with keyless locking and unlocking\*, a smaller, lighter and buttonless key (Key Tag) can be purchased as an accessory.

To start the vehicle, a key must be in the front section of the passenger compartment.

For vehicles equipped with keyless locking and unlocking (Passive Entry)\*, the engine can be started with the key anywhere in the vehicle.

The keys can be linked to different user profiles to store personal settings in the vehicle.

 **Warning**

The key contains a button cell battery. Keep new and used batteries out of the reach of children. If batteries are swallowed, they can cause serious injury.

If any damage is detected, e.g. if the battery cover cannot be closed properly, do not use the product. Keep defective products out of the reach of children.

## Standard key and its buttons



The key has four buttons, one on the left side and three on the right.

### **Locking**

Press the button once to lock the vehicle and arm the alarm.

Press and hold to close all windows.

### **Unlocking**

Press the button once to unlock the vehicle and disarm the alarm. Press and hold to open all windows at the same time. This can be used, for example, to quickly air out a hot passenger compartment before getting in.

### **Tailgate**

Press the button once to disarm\* and unlock the tailgate. On vehicles with power tailgates\*, press and hold to open or close the tailgate. A warning signal will sound when the tailgate is opening or closing.

### **Panic alarm**

The panic alarm is used to attract attention in emergency situations. Press and hold the button for at least 3 seconds or press twice within 3 seconds to activate the vehicle's turn signals and horn. The function can be switched off with the unlocking button after it has been activated for at least 5 seconds. Otherwise it switches off automatically after 2 minutes and 45 seconds.

 **Warning**

If anyone is left in the vehicle, make sure that power to the power windows and panoramic roof\* is cut off by taking the key with you when you leave the vehicle.

**i Note**

A key that has been locked in the vehicle is temporarily deactivated and cannot be used until the vehicle is unlocked using another valid key.

## Button-less key (Key Tag)\*

A buttonless key<sup>[2]</sup> can be ordered as an accessory for vehicles equipped with the keyless locking and unlocking function. Start and keyless locking and unlocking function in the same way as with the standard key. The key is waterproof up to a depth of approx. 10 meters (30 feet) for up to 60 minutes. It does not have a key blade and the battery cannot be replaced.

## Care Key

It is possible to set a speed limitation that will be active when Care Key is used. This limit is intended to promote safe use of the vehicle, e.g. when it is loaned out.

## If the active key is removed from the vehicle



If the key is removed from the vehicle while the engine is running, the warning message **The car key is not detected. See Owner's Manual for more information.** will be displayed in the instrument panel and an audible signal will sound when the last door is closed.

The message will disappear when the key is returned to the vehicle and the **O** button on the right-side steering wheel keypad is pressed or when all doors are closed.

## Interference

Electromagnetic fields or obstructing objects may interfere with the key's functions for keyless start and keyless locking and unlocking\*.

**i Note**

Do not store the vehicle's keys near metal objects or electronic devices (phones, tablets, laptops, chargers, etc.). Keep a distance between them of at least 10-15 cm (4-6 inches).

If you experience interference, use the key's detachable blade to unlock the vehicle. Then place the key in the backup reader in the cup holder to disarm the alarm and start the vehicle.

**i Note**

To help ensure that the key can be detected by the backup reader, make sure there are no other vehicle keys, metal objects or electronic devices (phones, tablets, laptops, chargers, etc.) in the cup holder. These objects can interfere with its functioning.



### Warning

#### California Proposition 65

Operating, servicing and maintaining a passenger vehicle can expose you to chemicals including engine exhaust, carbon monoxide, phthalates, and lead, which are known to the State of California to cause cancer and birth defects or other reproductive harm. To minimize exposure, avoid breathing exhaust, do not idle the engine except as necessary, service your vehicle in a well ventilated area and wear gloves or wash your hands frequently when servicing your vehicle. For more information go to [www.P65Warnings.ca.gov/passenger-vehicle](http://www.P65Warnings.ca.gov/passenger-vehicle) [<https://www.p65warnings.ca.gov/products/passenger-vehicle>].

\* Option/accessory.

[1] The illustration is generic - details may vary according to vehicle model.

[2] Also called sport key.

## 9.1.4. Ordering additional keys

If more keys than the standard number supplied with the vehicle are needed, or if any key is lost, new keys can be ordered. If the vehicle is equipped with keyless locking and unlocking\*, a buttonless key (Key Tag) can also be ordered.

A total of 12 keys can be programmed and used for the same vehicle. An additional driver profile will be added for each new key. This also applies to the key tag.

### Lost key

If a key is lost, a replacement key can be ordered through a Volvo retailer or an authorized Volvo workshop. As an anti-theft measure, the code of the lost remote key must be erased from the system. All remaining keys must be brought to the workshop.

#### Note

Volvo recommends that you order a new or duplicate key from an authorized Volvo workshop.

You can also obtain additional or duplicate keys from certain independent repair facilities and locksmiths that are qualified to make keys. Each key must be programmed to work with your vehicle.

A list of independent repair facilities and/or locksmiths known to Volvo that can cut and code replacement keys can be found:

- at [volvocars.com](http://volvocars.com)
- by calling Volvo Customer Care 1-800-458-1552.

\* Option/accessory.

---

## 9.1.5. Replacing the key's battery

The battery in the key can be replaced when it is discharged. Battery life depends on how much the key is used. The battery for the buttonless key (Key Tag)\* cannot be replaced.

 **Note**

All batteries have a limited service life and must eventually be replaced (does not apply for Key Tag). The battery's service life varies depending on how often the vehicle/key is used.



When the information icon illuminates and the message **The car key battery is low. See Owner's Manual for replacement.** appears in the instrument panel, the key's battery needs to be replaced.

Reduced key range is another sign that the battery level is low.

The battery in the buttonless key (Key Tag)\* cannot be replaced. When the battery is discharged, a new buttonless key can be ordered from an authorized Volvo workshop.

 **Important**

Hand in used Key Tags to an authorized Volvo workshop, where the key can be deleted from the vehicle's system. The key can still be used even if the battery is discharged to start the vehicle via a back-up start.

## Opening the key and replacing its battery

 **Important**

Do not touch the contact surfaces of new batteries. This impairs the battery's function.

Hold the key with the front side (with the Volvo logo) facing up, and the key ring bracket facing you.

There should be a catch to the left of the key ring bracket. If this catch is on the wrong side, the front and back sides have been switched during a previous battery change.

1 **1**



Move the catch next to the key ring bracket to the side and slide the front cover away from the bracket.

- The cover comes loose and can be lifted off.  
There is an additional catch under the front cover for removing the back cover.

2 **2**



Move the catch behind the front cover to the side and slide the rear cover away from the key ring bracket.

- The cover comes loose and can be lifted off.  
Under the rear cover is a battery cover.

3 **3**



Turn the battery cover counterclockwise to the OPEN position. Use a screwdriver, coin or similar.



Remove the battery cover. If it is difficult to remove, use a narrow object to carefully pry it up.

4 **4**



The battery's positive side (+) faces upward. Remove the battery by pressing its edge and then lifting it out.

5 **5**



Insert a new battery with the positive side (+) facing upward. Do not touch the contact surfaces of the key battery.

Place the edge of the battery under the two lower plastic catches.

Then push the battery down so that it is held in place by the upper plastic catch.

**i** Note

Use batteries with the designation CR2032, 3 V.

**i** Note

Volvo recommends that replacement batteries for the key meet the UN Manual of Test and Criteria, Part III, sub-section 38.3. The supplied batteries or batteries replaced by an authorized Volvo workshop meet the same criteria.

6 **6**



Put the battery cover back into place and turn it clockwise to the CLOSE position.

7 **7**



Put the back cover on in the reverse order it was removed. The back cover does not have a logo. Press the cover down until it clicks and then push it the last few millimeters back to its original position.

- A second click indicates that the cover is correctly positioned and locked into place. There should not be any gaps.

8 **8**



Turn the key and put the front cover back on in the same way as the back cover.

 **Warning**

Make sure the battery is positioned correctly with the right polarity. If the key will not be used for a prolonged period of time, remove the battery to avoid battery leakage and damage. Wear protective gloves when handling damaged batteries, as batteries that are damaged or leaking can cause corrosive damage in contact with the skin.

- Keep batteries out of the reach of children.
- Do not leave batteries lying out where they could be swallowed by children or pets.
- Never disassemble, short-circuit or place a battery into open fire.
- Do not charge non-chargeable batteries. They could explode.
- Check products with batteries regularly for signs of damage.

Do not use the key if there is anything to suggest that the key or its battery has been damaged or is beginning to leak. Keep defective products out of the reach of children.

 **Important**

Batteries must be recycled in an environmentally sound manner at the end of their service life.

 **Warning**

**California Proposition 65**

Operating, servicing and maintaining a passenger vehicle can expose you to chemicals including engine exhaust, carbon monoxide, phthalates, and lead, which are known to the State of California to cause cancer and birth defects or other reproductive harm. To minimize exposure, avoid breathing exhaust, do not idle the engine except as necessary, service your vehicle in a well ventilated area and wear gloves or wash your hands frequently when servicing your vehicle. For more information go to [www.P65Warnings.ca.gov/passenger-vehicle](http://www.P65Warnings.ca.gov/passenger-vehicle) [<https://www.p65warnings.ca.gov/products/passenger-vehicle>].

\* Option/accessory.

---

## 9.1.6. Locking and unlocking using the key buttons

The buttons on the key can be used to lock or unlock the entire vehicle. <sup>[1]</sup>



### Locking with the key's buttons

- 1 Press the  button to lock the vehicle.

To activate the locking sequence, the driver's door must be closed <sup>[2]</sup>. If any of the other doors or the tailgate are open, they will be locked and the alarm will be armed once they are closed.

 **Note**

A key that has been locked in the vehicle is temporarily deactivated and cannot be used until the vehicle is unlocked using another valid key.

#### Locking when the tailgate is open

 **Note**

If the vehicle is locked and the tailgate is still open, make sure that the key is not left in the cargo compartment when the tailgate is closed<sup>[2]</sup>.

## Unlocking with the key's buttons

- 1 Press the  button to unlock the vehicle.

## Automatic relocking

If none of the doors or tailgate are opened within two minutes after being unlocked, they will automatically relock. This function reduces the risk of inadvertently leaving the vehicle unlocked.

## If the key doesn't work

If the key's buttons are not working, its battery may be discharged. Replace the battery or use the detachable key blade.

<sup>[1]</sup> Including the fuel filler door.

\* Option/accessory.

<sup>[2]</sup> If the vehicle is equipped with keyless locking/unlocking\*, all side doors must be closed.

---

## 9.1.7. Care Key – speed-restricted key

A Care Key enables the vehicle owner to set a maximum speed limit for the vehicle. This speed limit is intended to promote safe use of the vehicle, e.g. when it is loaned out.



The button functions for the Care Key are the same as for the regular key. If no speed limit has been set, the vehicle and the key work as normal. Like other keys, the Care Key can be linked to a user profile to save personal settings in the vehicle.

The speed limitation can be set by the user profile who is the administrator. The speed limitation is activated when the vehicle is unlocked with a Care Key, or when the driver's door is opened and the vehicle detects a Care Key on the driver's side.

The ability to set a maximum speed for use with a specific key is intended to give the vehicle owner increased peace of mind when handing over the vehicle to a young or inexperienced driver, a valet, a workshop, etc.

---

## 9.1.8. Setting speed limitation for Care Key

The speed limitation for the Care Key is set in the center display.

The speed limitation for the Care Key can only be set from a profile with administrative rights. To access the settings:

- 1 Tap  in the center display.
  - 2 Select **Profiles**.
  - 3 Select **Care key**.
  - 4 Activate **Speed limit** and select the desired maximum speed <sup>[1]</sup>.
- The speed limitation is activated when the vehicle is used with a Care Key.

To deactivate the function, the vehicle must be unlocked using an unrestricted key. The speed limitation for the Care Key can be deactivated via settings in the center display. The Care Key can then be used as a regular key.

**Indication in the instrument panel**

An active speed limitation is indicated in the instrument panel with a symbol and the message **Speed limitation cannot be exceeded Care Key in use**. A yellow dotted line on the speedometer shows the current speed limitation.

Symbol	Meaning
	Speed limitation is active.

[1] The speed can be set within the range of 50-150 km/h (30-95 mph), in increments of 10 km/h (5 mph).

## 9.1.9. Unlocking the tailgate using the key button

There is a button on the key for unlocking only the tailgate.

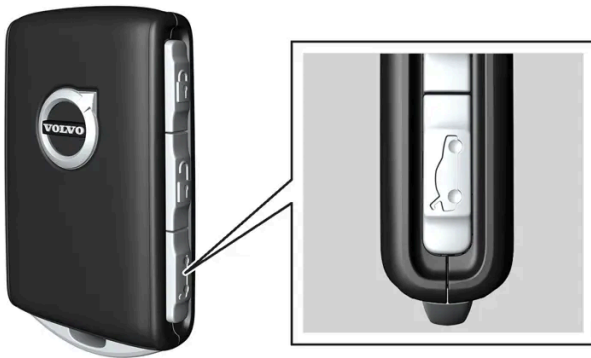

- 1 Press the  button on the key.
  - > The tailgate will be unlocked but remain closed. The side doors remain locked and armed. The lock and alarm indicator on the dashboard will go out to indicate that the vehicle is no longer fully locked. The tailgate can be opened by grasping the rubberized button under the lower edge of the trunk lid. If the tailgate is not opened within 2 minutes, it will be relocked and the alarm armed.

### Power tailgate\*

- 1 Press and hold the key's  button for a few seconds.
  - > The tailgate will unlock and open. However, the side doors will remain locked and armed.

**Note**

If the power tailgate system \* has been working continuously for too long, it will be switched off to help prevent overheating. It can be used again after a few minutes.

\* Option/accessory.

## 9.1.10. Detachable key blade

The standard key contains a detachable metal key blade that has several different functions.

A Volvo workshop can provide you with the key blade's unique code, which is recommended in case you need to order a new key blade.

### Using the detachable key blade

The detachable key blade can be used to:

- manually open the left-side front door if central locking cannot be activated by pushing a button
- emergency lock all doors
- activate/deactivate the rear door mechanical child locks.

If the key blade has been used to unlock the vehicle, the alarm can be disabled and the vehicle started by placing the key in the backup reader in the tunnel console storage compartment.

The optional buttonless key (Key Tag) does not have a detachable key blade.

### Removing the key blade

Hold the key with the front side (with the Volvo logo) facing up, and the key ring bracket facing you.

There should be a catch to the left of the key ring bracket. If this catch is on the wrong side, the front and back sides have been switched at some point when the key was disassembled.

1 **1**



Move the catch next to the key ring bracket to the side and slide the front cover away from the bracket.

➤ The cover comes loose and can be lifted off.

2 **2**



Remove the key blade.

3 **3**



Put the front cover on in the reverse order it was removed. Press the cover down until it clicks and then push it the last few millimeters back to its original position.

➤ A second click indicates that the cover is correctly positioned and locked into place. There should not be any gaps.

---

## 9.1.11. Locking and unlocking with detachable key blade

The detachable key blade can be used to unlock one of the vehicle's doors from the outside, for example if the key's battery is discharged.

### Unlocking using the key blade



**i Note**

When the door is unlocked using the detachable key blade and then opened, the alarm will be triggered. The alarm must be deactivated manually – it can be a good idea to read the section about this before opening the vehicle.

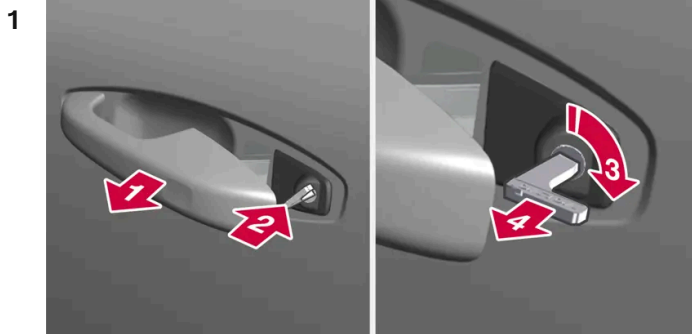

Pull the handle on the left-side front door to its end position.



Insert the key.



Turn the key clockwise 45 degrees so that the key is pointing straight rearward.



Turn the key back 45 degrees to the original position and remove it.

➤ The door can be opened using the handle.

## Locking using the key blade

The front left door can also be locked using the detachable key blade.

The other doors have a lock mechanism in the side of the door that must be pushed in using the key blade. The doors will then be mechanically locked and cannot be opened from the outside. The doors can still be opened from inside the vehicle.

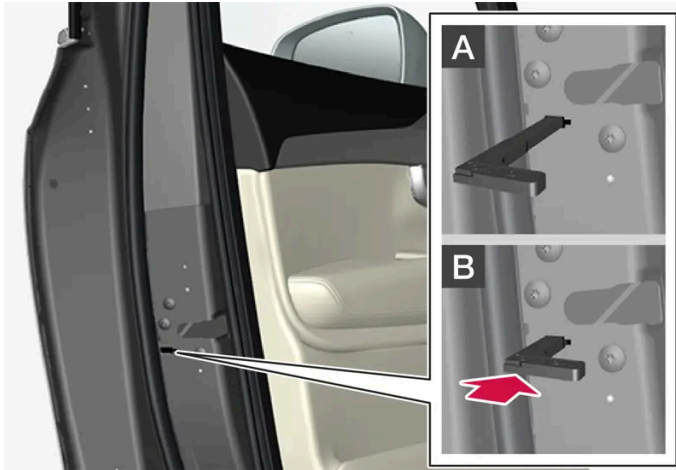

Manual door lock. This is not the child lock.

- 1 Remove the detachable key blade from the key with buttons.
- 2 Insert the key blade into the opening for the lock mechanism.
- 3 Push in the key until it stops, about 12 mm (0.5 inch).

**A** The door can be opened from both the outside and the inside.

**B** The door cannot be opened from the outside. To return to position A, open the door using the inside door handle.

**Note**

- The door's lock controls only lock that specific door, not all doors simultaneously.
- A manually locked rear door with an activated child lock cannot be opened from either the outside or the inside. It can be unlocked using the key buttons, central locking button, keyless locking system \* or through the Volvo Cars app.

\* Option/accessory.

## 9.1.12. Key range

In order to function correctly, the key must be within a certain distance from the vehicle.

Physical barriers between the key and the vehicle may adversely affect the range or obstruct the signal completely.

### When using the key buttons

The content of this manual represents the status of the user manual at the time of printing and may not be completely valid in future instances. For more information refer to the first page for the complete disclaimer note.

The key's functions that are controlled by the buttons have a range of about 20 meters (65 feet) from the vehicle.

If the vehicle's locks do not react, move closer and try again.

## Keyless\* use

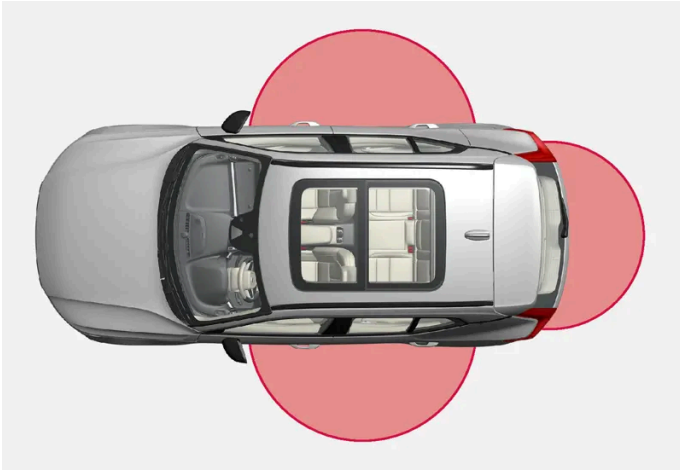

For keyless operation to be possible, the key must be within a distance of about 1 to 1.5 meters (3 to 5 feet) from the vehicle's doors or tailgate.

### Note

The functions of the key can be disrupted by ambient radio waves, buildings, topographical conditions, etc. The vehicle can always be locked/unlocked using the key blade.

\* Option/accessory.

---

## 9.1.13. Start and lock system type designations

The following information contains type designations for the start and lock system.

### Alarm system

USA FCC ID: MAYDA 5823(3)

This device complies with part 15 of the FCC rules. Operation is subject to the following conditions: (1) This device may not cause harmful interference, and (2) this device must accept any interference received, including interference that may cause undesired operation.

Canada IC: 4405A-DA 5823(3)

This device is subject to the following conditions: (1) This device may not cause interference, and (2) this device must accept any interference, including interference that may cause undesired operation of the device.

## Remote keys (Passive Entry\* /Passive Start)

### USA

Volvo Standard Key FCC ID: YGOHUF8423MS

Volvo Tag ID FCC ID: YGOHUF8432MS

This device complies with part 15 of the FCC Rules. Operation is subject to the following two conditions:

(1) This device may not cause harmful interference, and (2) this device must accept any interference received, including interference that may cause undesired operation.

CAUTION: Changes or modifications not expressly approved by the party responsible for compliance could void the user's authority to operate the equipment.

### Canada

Volvo Standard Key IC: 4008C-HUF8423MS

Volvo Tag ID IC: 4008C-HUF8432MS

This device complies with part 15 of the FCC Rules and Industry Canada license-exempt RSS standard(s). Operation is subject to the following two conditions:

(1) This device may not cause harmful interference, and (2) this device must accept any interference received, including interference that may cause undesired operation.

Le présent appareil est conforme aux CNR d'Industrie Canada applicables aux appareils radio exempts de licence. L'exploitation est autorisée aux deux conditions suivantes :

(1) l'appareil ne doit pas produire de brouillage, et (2) l'utilisateur de l'appareil doit accepter tout brouillage radioélectrique subi, même si le brouillage est susceptible d'en compromettre le fonctionnement.

## Immobilizer and Passive Entry\* /Passive Start systems

USA-FCC ID: LTQVO3134

This device complies with part 15 of the FCC rules. Operation is subject to the following two conditions:

(1) This device may not cause harmful interference, and

(2) this device must accept any interference received, including interference that may cause undesired operation.

Any changes or modification not expressly approved by the party responsible for compliance could void the user's authority to operate this equipment.

Canada-IC:3659A-VO3134

This device complies with Industry Canada license-exempt RSS standards. Operation is subject to the following two conditions:

(1) This device may not cause harmful interference, and (2) this device must accept any interference received, including interference that may cause undesired operation.

\* Option/accessory.

---

## 9.1.14. Antenna locations for the start and lock system

The antennas for the keyless start system and keyless locking system\* are integrated in the vehicle.



Location of the antennas:

- 1 In the storage compartment in the tunnel console
- 2 In the upper front section of the left-side rear door<sup>[1]</sup>
- 3 In the upper front section of the right-side rear door<sup>[1]</sup>
- 4 In the cargo compartment<sup>[1]</sup>

 **Warning**

People with a pacemaker should keep a distance of at least 22 cm (9 inches) from the antennas to prevent interference between the pacemaker and the key system.

\* Option/accessory.

<sup>[1]</sup> Only in vehicles equipped with keyless locking and unlocking\*.

---

## 9.1.15. Ignition modes

The vehicle's ignition can be put in various modes (levels) to make different functions available.

To enable the use of a limited number of functions when the engine is not running, the ignition can be put in one of three different levels: **0**, **I** and **II**. These levels are referred to as "ignition modes" in the Owner's Manual.

The following table shows which functions are available in each ignition mode:

Mode	Functions
0	<ul style="list-style-type: none"> <li>The odometer, clock and temperature gauge are illuminated<sup>[1]</sup>.</li> <li>The power* seats can be adjusted.</li> <li>The center display is activated and can be used<sup>[1]</sup>.</li> <li>The infotainment system can be used<sup>[1]</sup>.</li> </ul> <p>In this mode, the functions are available for a limited time and then switch off automatically.</p>
I	<ul style="list-style-type: none"> <li>The panoramic roof, power windows, 12-volt electrical socket in the passenger compartment, Bluetooth, navigation, phone, blower and windshield wipers can be used.</li> <li>The power seats can be adjusted.</li> <li>The 12-volt electrical socket* in the cargo compartment can be used.</li> </ul> <p><b>Electrical current will be taken from the battery in this ignition mode.</b></p>
II	<ul style="list-style-type: none"> <li>The headlights illuminate.</li> <li>Warning/indicator lights illuminate for 5 seconds.</li> <li>A number of other systems are activated. However, seat and rear window heating can only be activated when the engine is running.</li> </ul> <p><b>This ignition mode uses a lot of current from the battery and should be avoided whenever possible!</b></p>

<sup>[1]</sup> Also activated when the door is opened.

\* Option/accessory.

## 9.1.16. Selecting ignition mode

The vehicle's ignition can be put in various modes (levels) to make different functions available.

## Selecting an ignition mode



Location of the start button.

- **Ignition mode 0** – Unlock the vehicle and keep the key in the passenger compartment.

### Note

To set level I or II **without** engine start – do **not** depress the brake pedal when selecting this ignition mode.

- **Ignition mode I** – Press the start button and release.
- **Ignition mode II** – Press the button and hold it in for approx. 5 seconds. Release the button.
- **Back to ignition mode 0** – To return to ignition mode 0 from modes I and II, press the start button.

---

## 9.2. Locking and unlocking

---

### 9.2.1. Keyless locking and unlocking

---

#### 9.2.1.1. Operating the tailgate with a foot movement\*

The tailgate can be opened and closed by making a foot movement\* under the rear bumper. This function makes it easy to access the cargo compartment when your hands are full.

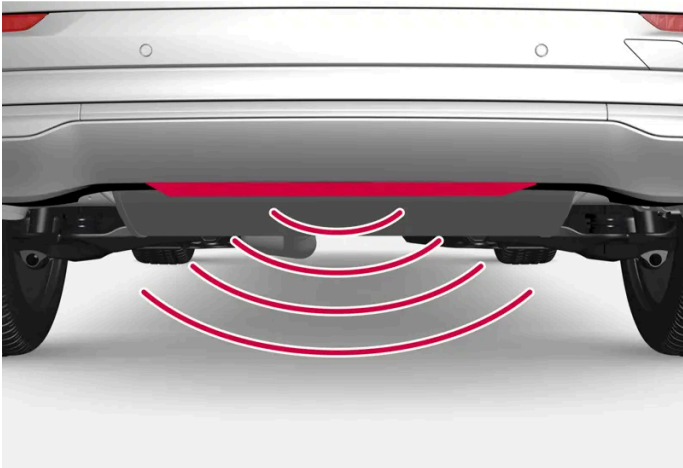

The sensor is located in the center under the bumper.

One of the vehicle's keys must be within range behind the vehicle, approx. 1 meter (3 feet) for opening and closing to be possible. This applies even if the vehicle is unlocked in order to prevent the trunk lid from inadvertently opening e.g. at a car wash.

## Foot movement operation

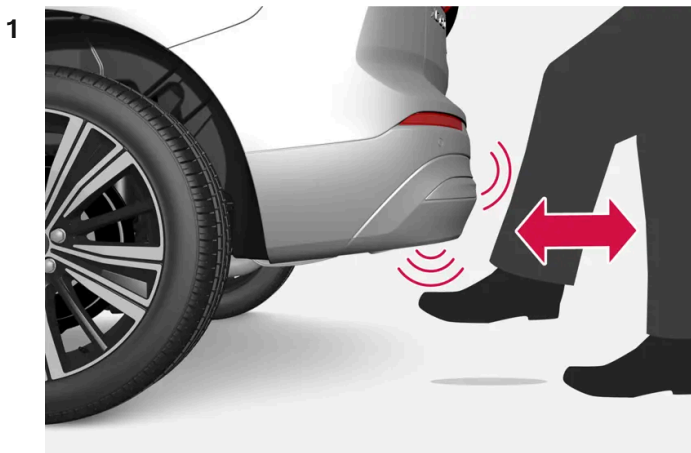

Make **one** forward kicking motion with your foot under the sensor area under the rear bumper. Then take a step back. Do not touch the bumper.

➤ A brief audible signal will be heard when opening or closing is activated - the tailgate will open/close.

If several opening attempts have been made without a key in range behind the vehicle, foot movement operation will not be available for a short period of time.

Do not hold your foot under the vehicle in a kicking motion – this can cause the activation to fail.

### Interrupting opening or closing with a foot movement

The content of this manual represents the status of the user manual at the time of printing and may not be completely valid in future instances. For more information refer to the first page for the complete disclaimer note.



1 Make **one** forward kicking motion during opening or closing.

➤ The tailgate will stop opening or closing.

The key does not need to be within range of the vehicle to interrupt opening or closing of the tailgate.

If the tailgate stops near the closed position, it will open the next time it is activated.

**i Note**

Keep the area around the foot movement sensor clean. The accumulation of dirt, ice or snow may interfere with its functioning.

**i Note**

Please note that the system could be inadvertently activated in a car wash if the key is within range.

\* Option/accessory.

## 9.2.1.2. Antenna locations for the start and lock system

The antennas for the keyless start system and keyless locking system\* are integrated in the vehicle.

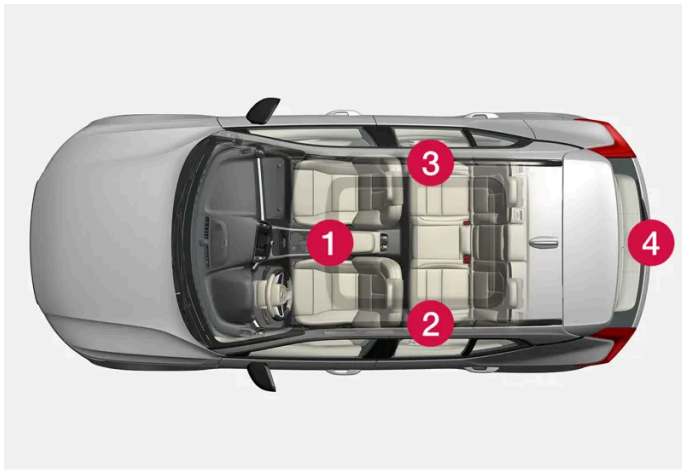

Location of the antennas:

- 1 In the storage compartment in the tunnel console
- 2 In the upper front section of the left-side rear door<sup>[1]</sup>
- 3 In the upper front section of the right-side rear door<sup>[1]</sup>
- 4 In the cargo compartment<sup>[1]</sup>

 **Warning**

People with a pacemaker should keep a distance of at least 22 cm (9 inches) from the antennas to prevent interference between the pacemaker and the key system.

\* Option/accessory.

[1] Only in vehicles equipped with keyless locking and unlocking\*.

### 9.2.1.3. Keyless locking and unlocking with touch-sensitive surfaces\*

With keyless locking and unlocking, the key's buttons do not need to be used – the key only needs to be near the vehicle. The vehicle can then be locked or unlocked by touching the pressure-sensitive surface on the door handle.

#### Pressure-sensitive surfaces

##### Door handle

There are indentations on the outside of the outer door handles for locking, and pressure-sensitive surfaces on the inside of the handles for unlocking.

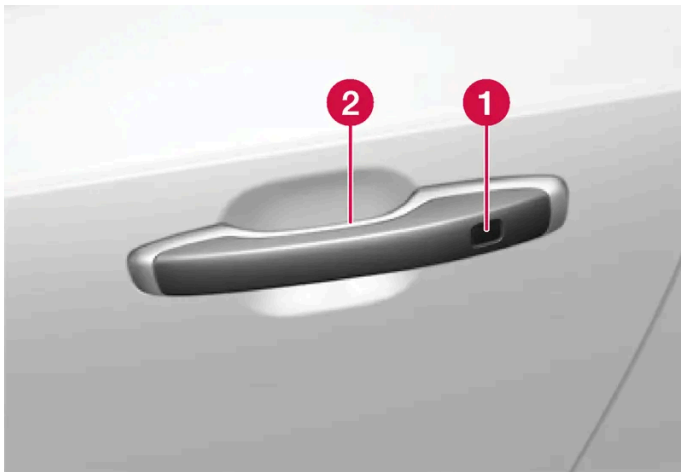

- 1 Pressure-sensitive indentation for locking
- 2 Pressure-sensitive surface for unlocking

 **Note**

It is important that only one pressure-sensitive surface is activated at a time. If the handle is grasped at the same time as the lock area is pressed, there is a risk that double commands may be sent. This may cause the requested action (locking/unlocking) to be delayed or not performed at all.

## Tailgate handle

The tailgate handle has a rubberized button underneath that can only be used for unlocking.

### **i** Note

Please be aware that the system could be activated in a car wash if the key is within range.

\* Option/accessory.

## 9.2.1.4. Keyless locking and unlocking\*

With keyless locking and unlocking, touching the pressure-sensitive surfaces on the door handle will lock or unlock the vehicle. A key must be detected near the vehicle.

### **i** Note

One of the vehicle's keys must be within range for locking and unlocking to be possible.

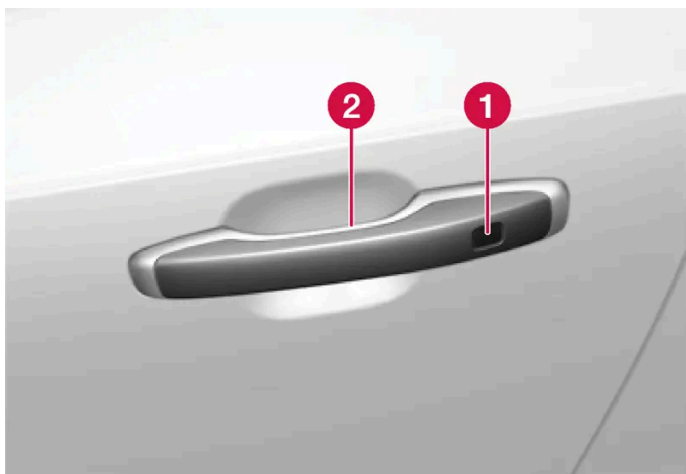

**1** Pressure-sensitive indentation for locking

**2** Pressure-sensitive surface for unlocking

### **i** Note

Please be aware that the system could be activated in a car wash if the key is within range.

## Keyless locking

Keyless locking can be performed by touching the vehicle's handle when it is completely closed.

It is also possible to lock using one of the side door handles when the tailgate is open. In this case, the tailgate will lock after it has been closed.

- 1 Touch the marked area on the outside of a door handle after the door is closed.

It is also possible to lock the vehicle without a key by pressing the  button on the bottom edge of the tailgate and then closing it.

- The lock indicator light on the dashboard will flash to confirm locking.

#### Closing the windows with keyless locking

To close all side windows at the same time, press and hold the touch-sensitive indentation on the outside of the door handle until the windows close.

## Keyless unlocking

- 1 To unlock, grasp a door handle or lightly press the rubberized button on the underside of the tailgate handle.

- The lock indicator light on the dashboard will stop flashing to confirm that the vehicle is unlocked.

## Automatic relocking

If the vehicle is not opened again within 2 minutes after unlocking, it will automatically lock again. This function reduces the risk of inadvertently leaving the vehicle unlocked.

\* Option/accessory.

---

### 9.2.1.5. Keyless unlock settings\*

Several different sequences are available for keyless unlocking.

- 1 Tap  in the center display.
- 2 Tap **Controls**.
- 3 Select setting for unlocking.

\* Option/accessory.

---

## 9.2.1.6. Closing and locking the tailgate using the buttons\*

The buttons underneath the tailgate can be used to close and lock the vehicle automatically.



Location of button(s) on underside of tailgate.

### **Important**

When operating the tailgate manually, open and close it slowly. If you encounter resistance, do not use force. This could damage the tailgate and lead to loss of function.

### Closing<sup>[1]</sup>

- 1 Press the  button on the underside of the tailgate.
  - The tailgate will close automatically and remain unlocked.

 **Note**

- The button remains active 24 hours after the tailgate was opened. After this time, the tailgate must be closed manually.
- If the tailgate has been open for more than 30 minutes, it will automatically close slowly.

## Closing and locking<sup>[2]</sup>

- 1 Press the  button on the underside of the tailgate.
  - > The tailgate closes automatically and the vehicle locks<sup>[3]</sup>.

 **Note**

- One of the vehicle's keys must be within range for locking and unlocking to be possible.
- When the keyless locking or closing\* functions are used, three audible signals will sound if the key is not close enough to the tailgate.

## Interrupting closing

- Press the button on the dashboard.
- Press the button on the key.
- Press the close button on the underside of the tailgate<sup>[1]</sup>.
- Press the rubberized pressure plate on the underside of the tailgate's outer handle.
- Using a foot movement\*.

Tailgate movement is interrupted and stops. The tailgate can then be opened or closed manually.

If the tailgate stops near the closed position, it will open the next time it is activated.

## Pinch protection

If anything obstructs the tailgate with enough force to prevent it from opening or closing, pinch protection will be activated.

- When opening - the tailgate will stop moving and an audible signal will sound.
- When closing - the tailgate will stop, a long audible signal will sound and the tailgate will return to the programmed maximum opening position.

 **Warning**

Be aware of the risk of injury when opening and closing.

Before opening or closing, make sure that no one is near the tailgate's range of motion. Serious injury could occur.

Always operate the tailgate with caution.

## Preloaded springs



Preloaded springs for the power tailgate.

 **Warning**

Do not attempt to open or access the preloaded springs in the power tailgate struts. They are preloaded with high pressure and can cause injury if opened.

\* Option/accessory.

[1] Vehicles with power-operated trunk lid.

[2] Vehicles with keyless locking/unlocking and power-operated tailgate.

[3] All doors must be closed for the vehicle to lock.

## 9.2.1.7. Keyless unlocking of the tailgate \*

With keyless locking and unlocking, the tailgate can be unlocked by lightly touching the rubberized button under the tailgate handle.

 **Note**

One of the vehicle's keys must be within range behind the vehicle for unlocking to be possible.

The tailgate is held closed by an electronic locking mechanism.

To open:

- 1 Lightly press the rubberized pressure plate on the underside of the tailgate handle.
  - The lock will disengage.
- 2 Lift the outer handle to open the tailgate.

 **Important**

- Handle the rubber plate carefully to help prevent damage to its electrical connections. Very little force is needed for activation.
- Use the handle to lift – do not apply force to the rubberized pressure plate.

The tailgate can also be unlocked by making a foot movement\* under the rear bumper; see the separate section.

 **Warning**

Do not drive with the tailgate open. Toxic exhaust fumes can be sucked into the vehicle through the cargo compartment.

\* Option/accessory.

---

## 9.2.2. Keys



The vehicle's physical keys are available in different variants. The vehicle detects when a key is inside the front part of the passenger compartment, and can then be started.



Available key types are the standard key, the buttonless key (Key Tag)\*, and Care Key.<sup>[1]</sup>

The standard key and the Care Key are equipped with buttons. Additional keys than those included as standard can be ordered. For vehicles equipped with keyless locking and unlocking\*, a smaller, lighter and buttonless key (Key Tag) can be purchased as an accessory.

To start the vehicle, a key must be in the front section of the passenger compartment.

For vehicles equipped with keyless locking and unlocking (Passive Entry)\*, the engine can be started with the key anywhere in the vehicle.

The keys can be linked to different user profiles to store personal settings in the vehicle.

 **Warning**

The key contains a button cell battery. Keep new and used batteries out of the reach of children. If batteries are swallowed, they can cause serious injury.

If any damage is detected, e.g. if the battery cover cannot be closed properly, do not use the product. Keep defective products out of the reach of children.

## Standard key and its buttons



The key has four buttons, one on the left side and three on the right.

### **Locking**

Press the button once to lock the vehicle and arm the alarm.

Press and hold to close all windows.

### **Unlocking**

Press the button once to unlock the vehicle and disarm the alarm. Press and hold to open all windows at the same time. This can be used, for example, to quickly air out a hot passenger compartment before getting in.

### **Tailgate**

Press the button once to disarm\* and unlock the tailgate. On vehicles with power tailgates\*, press and hold to open or close the tailgate. A warning signal will sound when the tailgate is opening or closing.

### **Panic alarm**

The panic alarm is used to attract attention in emergency situations. Press and hold the button for at least 3 seconds or press twice within 3 seconds to activate the vehicle's turn signals and horn. The function can be switched off with the unlocking button after it has been activated for at least 5 seconds. Otherwise it switches off automatically after 2 minutes and 45 seconds.

 **Warning**

If anyone is left in the vehicle, make sure that power to the power windows and panoramic roof\* is cut off by taking the key with you when you leave the vehicle.

**i Note**

A key that has been locked in the vehicle is temporarily deactivated and cannot be used until the vehicle is unlocked using another valid key.

## Button-less key (Key Tag)\*

A buttonless key<sup>[2]</sup> can be ordered as an accessory for vehicles equipped with the keyless locking and unlocking function. Start and keyless locking and unlocking function in the same way as with the standard key. The key is waterproof up to a depth of approx. 10 meters (30 feet) for up to 60 minutes. It does not have a key blade and the battery cannot be replaced.

## Care Key

It is possible to set a speed limitation that will be active when Care Key is used. This limit is intended to promote safe use of the vehicle, e.g. when it is loaned out.

## If the active key is removed from the vehicle



If the key is removed from the vehicle while the engine is running, the warning message **The car key is not detected. See Owner's Manual for more information.** will be displayed in the instrument panel and an audible signal will sound when the last door is closed.

The message will disappear when the key is returned to the vehicle and the **O** button on the right-side steering wheel keypad is pressed or when all doors are closed.

## Interference

Electromagnetic fields or obstructing objects may interfere with the key's functions for keyless start and keyless locking and unlocking\*.

**i Note**

Do not store the vehicle's keys near metal objects or electronic devices (phones, tablets, laptops, chargers, etc.). Keep a distance between them of at least 10-15 cm (4-6 inches).

If you experience interference, use the key's detachable blade to unlock the vehicle. Then place the key in the backup reader in the cup holder to disarm the alarm and start the vehicle.

**i Note**

To help ensure that the key can be detected by the backup reader, make sure there are no other vehicle keys, metal objects or electronic devices (phones, tablets, laptops, chargers, etc.) in the cup holder. These objects can interfere with its functioning.

 **Warning**

**California Proposition 65**

Operating, servicing and maintaining a passenger vehicle can expose you to chemicals including engine exhaust, carbon monoxide, phthalates, and lead, which are known to the State of California to cause cancer and birth defects or other reproductive harm. To minimize exposure, avoid breathing exhaust, do not idle the engine except as necessary, service your vehicle in a well ventilated area and wear gloves or wash your hands frequently when servicing your vehicle. For more information go to [www.P65Warnings.ca.gov/passenger-vehicle](http://www.P65Warnings.ca.gov/passenger-vehicle) [<https://www.p65warnings.ca.gov/products/passenger-vehicle>].

\* Option/accessory.

[1] The illustration is generic - details may vary according to vehicle model.

[2] Also called sport key.

---

## 9.2.3. Locking and unlocking using the key buttons

The buttons on the key can be used to lock or unlock the entire vehicle. [1]



### Locking with the key's buttons

- 1 Press the  button to lock the vehicle.

To activate the locking sequence, the driver's door must be closed [2]. If any of the other doors or the tailgate are open, they will be locked and the alarm will be armed once they are closed.

 **Note**

A key that has been locked in the vehicle is temporarily deactivated and cannot be used until the vehicle is unlocked using another valid key.

#### Locking when the tailgate is open

 **Note**

If the vehicle is locked and the tailgate is still open, make sure that the key is not left in the cargo compartment when the tailgate is closed<sup>[2]</sup>.

## Unlocking with the key's buttons

- 1 Press the  button to unlock the vehicle.

## Automatic relocking

If none of the doors or tailgate are opened within two minutes after being unlocked, they will automatically relock. This function reduces the risk of inadvertently leaving the vehicle unlocked.

## If the key doesn't work

If the key's buttons are not working, its battery may be discharged. Replace the battery or use the detachable key blade.

<sup>[1]</sup> Including the fuel filler door.

\* Option/accessory.

<sup>[2]</sup> If the vehicle is equipped with keyless locking/unlocking\*, all side doors must be closed.

---

## 9.2.4. Unlock settings

Several different sequences are available for unlocking.

- 1 Tap  in the center display.
- 2 Tap **Controls**.
- 3 Select setting for unlocking.

---

## 9.2.5. Unlocking the tailgate using the key button

There is a button on the key for unlocking only the tailgate.

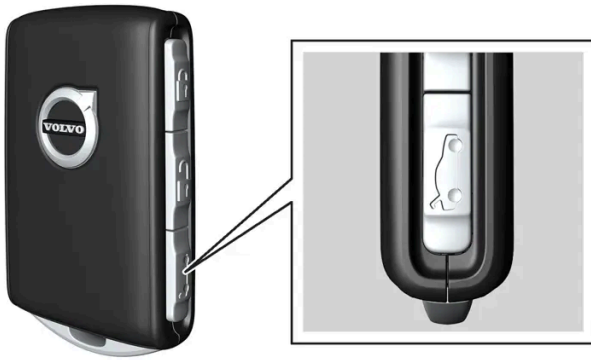

- 1 Press the  button on the key.
  - The tailgate will be unlocked but remain closed.  
The side doors remain locked and armed. The lock and alarm indicator on the dashboard will go out to indicate that the vehicle is no longer fully locked.  
The tailgate can be opened by grasping the rubberized button under the lower edge of the trunk lid.  
If the tailgate is not opened within 2 minutes, it will be relocked and the alarm armed.

### Power tailgate\*

- 1 Press and hold the key's  button for a few seconds.
  - The tailgate will unlock and open. However, the side doors will remain locked and armed.

 **Note**

If the power tailgate system \* has been working continuously for too long, it will be switched off to help prevent overheating. It can be used again after a few minutes.

\* Option/accessory.

---

## 9.2.6. Locking and unlocking with detachable key blade

The detachable key blade can be used to unlock one of the vehicle's doors from the outside, for example if the key's battery is discharged.

## Unlocking using the key blade

### Note

When the door is unlocked using the detachable key blade and then opened, the alarm will be triggered. The alarm must be deactivated manually – it can be a good idea to read the section about this before opening the vehicle.

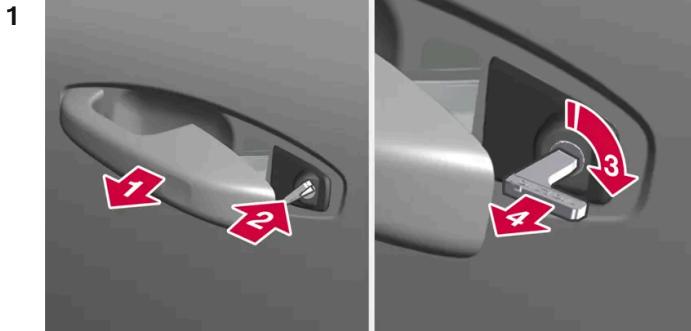

1

Pull the handle on the left-side front door to its end position.

2

Insert the key.

3

Turn the key clockwise 45 degrees so that the key is pointing straight rearward.

4

Turn the key back 45 degrees to the original position and remove it.

➤ The door can be opened using the handle.

## Locking using the key blade

The front left door can also be locked using the detachable key blade.



The other doors have a lock mechanism in the side of the door that must be pushed in using the key blade. The doors will then be mechanically locked and cannot be opened from the outside. The doors can still be opened from inside the vehicle.

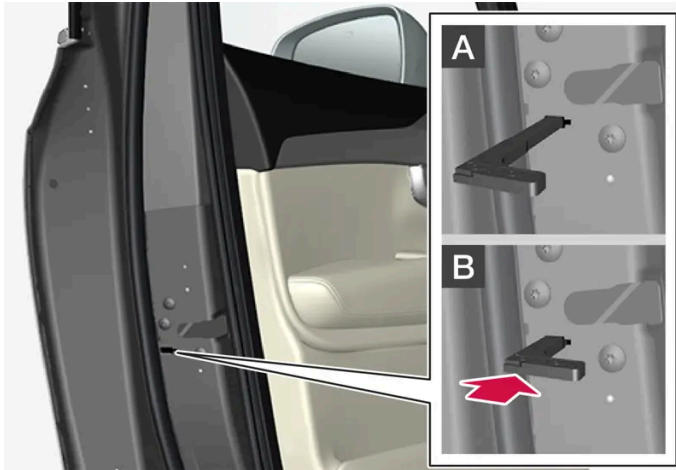

Manual door lock. This is not the child lock.

- 1 Remove the detachable key blade from the key with buttons.
- 2 Insert the key blade into the opening for the lock mechanism.
- 3 Push in the key until it stops, about 12 mm (0.5 inch).

**A** The door can be opened from both the outside and the inside.

**B** The door cannot be opened from the outside. To return to position A, open the door using the inside door handle.

**Note**

- The door's lock controls only lock that specific door, not all doors simultaneously.
- A manually locked rear door with an activated child lock cannot be opened from either the outside or the inside. It can be unlocked using the key buttons, central locking button, keyless locking system \* or through the Volvo Cars app.

\* Option/accessory.

## 9.2.7. Automatic locking when driving

For safety reasons, the doors and tailgate automatically lock when the vehicle starts driving.

The doors can still be opened from the inside during automatic locking when driving. Depending on lock settings, either all doors will be unlocked or only the door being opened.

 **Note**

The child lock should be used to help prevent a rear door from being opened from the inside.

 **Note**

For safety reasons, all of the vehicle's doors will unlock in the event of a collision. This will only happen if one of the safety systems has been triggered.

## 9.2.8. Setting maximum opening height for the power tailgate\*

The tailgate can be set to stop opening at a certain height, for example if the vehicle is parked in a garage with a low ceiling.

### Setting maximum opening height

- 1 Open the tailgate manually to the desired opening height.
- 2 Press the \* button on the lower edge of the tailgate and hold it for about 3 seconds.
  - > Two audio signals will sound to indicate that the position has been stored.

 **Note**

It is not possible to program an opening position lower than half-open tailgate.

### Resetting maximum opening position

- 1 Open the tailgate manually to the fully open position.
- 2 Press the \* button on the lower edge of the tailgate and hold it for about 3 seconds.
  - > Two audio signals will sound to indicate that the stored position has been erased.

\* Option/accessory.

---

## 9.2.9. Locking and unlocking from inside the vehicle

There are several lock buttons inside the vehicle. The inner door handles can also be used to unlock the vehicle from the inside.

### Central locking

The central locking buttons in the front door lock or unlock the entire vehicle.



### Unlocking using the front door buttons

- 1 Press the  button to unlock all side doors and the tailgate.

### Unlocking using the front door handle

- 1 Pull one of the front side door's inner handles and release.
  - The vehicle is unlocked. Depending on settings, either only the selected door is unlocked or all doors are unlocked.

### Locking using the front door buttons

- 1 Press the  button (both front doors must be closed).
  - All doors and the tailgate will lock.

## Locking using the rear door button \*

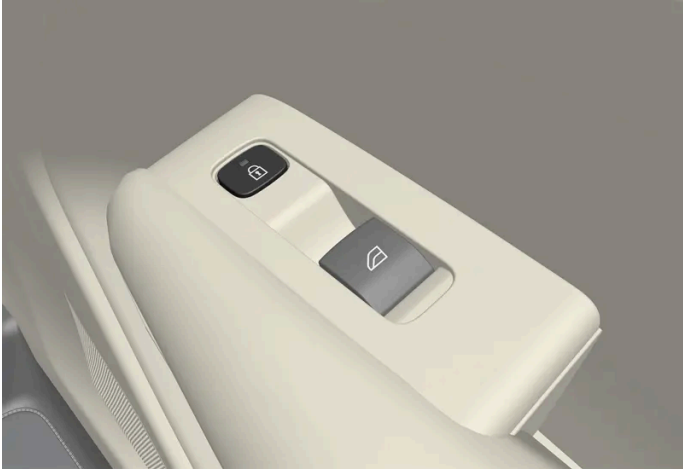

Button with indicator light for locking/unlocking in rear door.

The lock buttons in the rear doors lock/unlock that particular door.

## Unlocking a rear door using the door handle

- 1 Pull the opening handle to unlock the rear door.
- 2 Pull the opening handle again to open the rear door<sup>[1]</sup>.

\* Option/accessory.

<sup>[1]</sup> If the child lock is not activated.

---

## 9.2.10. Unlocking the tailgate from inside the vehicle

The tailgate can be unlocked from inside the vehicle by pressing the button on the dashboard, to the side of the steering wheel.



- 1 Press the  button on the dashboard.
  - > The tailgate is unlocked and can be opened from the outside.

With the optional power tailgate\*:

- 1 Press and hold the  button on the dashboard for a few seconds.
  - The tailgate will open.  
The same button can then be used to close the tailgate.

 **Note**

If the power tailgate system\* has been working continuously for too long, it will be switched off to help prevent overheating. It can be used again after a few minutes.

\* Option/accessory.

---

## 9.2.11. Locking and unlocking

The vehicle can be locked and unlocked in several different ways.

These are:

- with the key buttons
- with the detachable key blade (if the battery in the key is discharged)
- keyless\* (the vehicle detects when a key is within range)
- from the inside of the vehicle with the door handles and lock buttons
- with the Volvo Cars app
- automatic locking when the vehicle is driving.

 **Note**

For safety reasons, all of the vehicle's doors will unlock in the event of a collision. This will only happen if one of the safety systems has been triggered.

\* Option/accessory.

---

## 9.2.12. Activating and deactivating child locks

The content of this manual represents the status of the user manual at the time of printing and may not be completely valid in future instances. For more information refer to the first page for the complete disclaimer note.

The child locks help prevent the rear doors from being able to be opened from the inside. With the electric child lock, the power windows are also prevented from being operated from the rear seat.

The child lock can be either manual or electric\*.

## Manual child lock

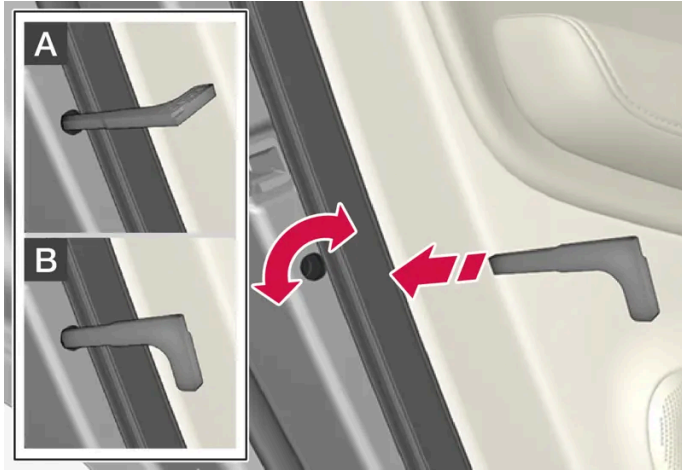

Manual child lock. This is not the manual door lock.

- 1 Use the detachable key blade in the key to turn the control.

- A The door cannot be opened from the inside.
- B The door can be opened from both the outside and the inside.

### *i* Note

- The door's knob control only locks that specific door, not both rear doors simultaneously.
- There are no manual child locks on models equipped with electric child locks.

## Electric child lock\*

The electric child lock can be activated and deactivated in any ignition mode higher than **0**. The lock can be activated and deactivated up to 2 minutes after the ignition is turned off if no door has been opened.



Button for activation and deactivation.

#### Rear child lock activated

When the indicator light in the button is lit, the child lock is activated.

If the child lock is activated when the vehicle is switched off, it will remain activated the next time the vehicle is started.



- Rear doors cannot be opened from the inside.
- Rear power windows can only be operated from the driver's door.

#### Rear child lock deactivated

When the indicator light in the button is not lit, the child lock is deactivated.

- Rear doors can be opened from the inside and power windows can be operated from the rear seat.

## Symbols and messages

Symbol	Message	Meaning
	Rear child lock activated	The child lock is activated.
	Rear child lock deactivated	The child lock is deactivated.

\* Option/accessory.

## 9.2.13. Lock indication

The vehicle can indicate locking and unlocking in different ways. You can adjust how the vehicle confirms locking and unlocking through settings for lock indication and door mirrors.

## Exterior confirmation

### Locking

- The turn signals will flash once and the door mirrors will fold in <sup>[1]</sup> to confirm the vehicle is locked.

### Unlocking

- The turn signals will flash twice and the door mirrors will fold out <sup>[1]</sup> to confirm the vehicle is unlocked.

The tailgate, hood and all doors must be closed for confirmation to be given. If only the driver's door is closed when the vehicle is locked <sup>[2]</sup>, the vehicle will be locked but the turn signals will only flash to indicate locking when all doors and the tailgate and hood have been closed.

## Lock and alarm indicators on the dashboard

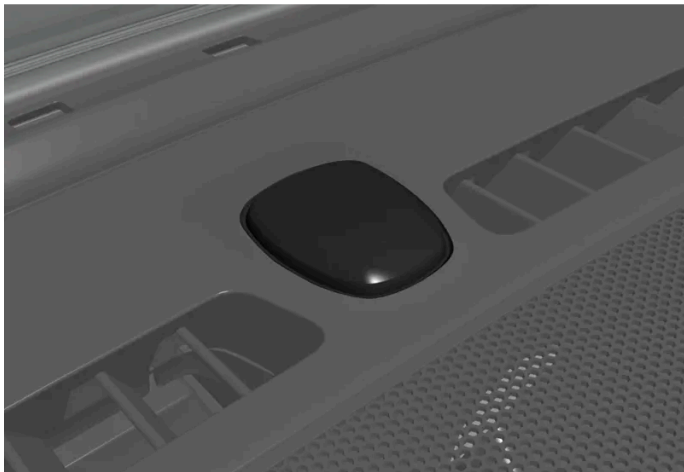

The locks and alarm indicator is located in the center of the dashboard, near the windshield.

The locks and alarm indicator will display the status of the locking system:

- One long flash indicates locking.
- When the vehicle is locked, this will be indicated by short, pulsating flashes.
- Rapid flashing after disabling the alarm indicates that the alarm has been triggered.

## Indicators in the doors' lock buttons

There are lock buttons inside the vehicle with lock symbols and lock indicator lights.



When the front doors' indicator lights are lit, all doors are locked. The lights go out if any of the vehicle's doors are opened.

The rear doors' indicator lights\* go out if the relevant door is unlocked and opened.



## Other indicators

Depending on the vehicle's settings, functions such as home safe lighting, Guidance Light and automatic folding in or out of the door mirrors can indicate locking or unlocking.

<sup>[1]</sup> Only vehicles with power folding mirrors.

\* Option/accessory.

<sup>[2]</sup> Not possible with keyless locking\*.

---

## 9.2.14. Lock confirmation settings

Settings for how the vehicle confirms locking and unlocking can be adjusted in the center display's Settings menu.

- 1 Tap  in the center display.
  - 2 Tap **Controls**.
  - 3 Select to activate or deactivate confirmation for locking/unlocking.
- 

## 9.3. Alarm

---

### 9.3.1. Alarm

The alarm emits sound and light signals if anyone without a valid key attempts to break into the vehicle, attempts to tow away the vehicle, or interferes with the vehicle's battery or alarm siren.

## Alarm indicator

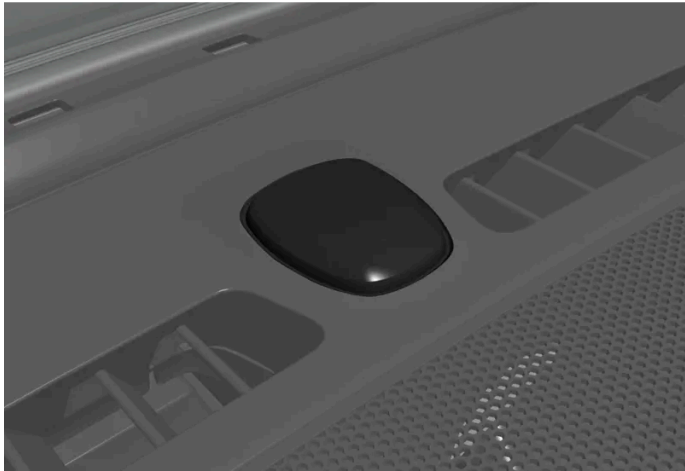

The locks and alarm indicator is located in the center of the dashboard, near the windshield.

A red indicator light shows the status of the alarm system:

- Indicator off – the alarm is disarmed.
- Indicator flashes once every two seconds – the alarm is armed.
- The indicator flashes quickly after the alarm has been disabled for up to 30 seconds or until the ignition is put in I mode – the alarm has been triggered.

When armed, the alarm will be triggered if:

- the hood, tailgate or any door is opened<sup>[1]</sup>.
- the battery is disconnected
- the alarm siren is disconnected.

## Alarm signals

The following occurs if the alarm is triggered:

- A siren will sound for 30 seconds or until the alarm is turned off.
- The hazard warning flashers will flash for 5 minutes or until the alarm is turned off.

If the reason the alarm was triggered is not rectified, the alarm cycle will repeat up to 10 times<sup>[1]</sup>.

## Symbols and messages

Symbol	Message	Meaning
	Alarm system failure Service required	Contact a workshop – an authorized Volvo workshop is recommended.

**Note**

Do not attempt to repair or alter any of the components in the alarm system yourself. Any such attempt could affect the terms and conditions of your insurance policy.

<sup>[1]</sup> Certain markets only.

## 9.3.2. Arming and disarming the alarm

The alarm is armed when the vehicle is locked and disarmed when the vehicle is unlocked. The alarm can also be disarmed without a functioning key.

### Arming and disarming the alarm

The alarm is armed when the vehicle is locked and disarmed when the vehicle is unlocked.

**Note**

It is not possible to lock the vehicle without activating the alarm.

#### Disarming the alarm without a functioning key

The vehicle can be unlocked and disarmed even if the key is not functioning, e.g. if its battery is discharged.

1 Open the driver's door using the detachable key blade.

> This will trigger the alarm.



Place the key on the key symbol in the backup reader in the tunnel console's storage compartment.

3 Press the start button.

➤ The alarm will be disarmed.

 **Note**

To help ensure that the key can be detected by the backup reader, make sure there are no other vehicle keys, metal objects or electronic devices (phones, tablets, laptops, chargers, etc.) in the area. These objects can interfere with its functioning.

**Turning off a triggered alarm**

A triggered alarm can be turned off by pushing the key's unlock button or by starting the vehicle, provided that an authorized key is on the key symbol in the backup reader in the tunnel console's storage compartment.

**1** Press the start button.

Press the unlock button on the key or select ignition mode I by turning the start knob clockwise and then releasing it.

# 10. Driver support

---

## 10.1. Cruise Control functions

---

### 10.1.1. Cruise control

---

#### 10.1.1.1. Cruise control

Cruise Control (CC<sup>[1]</sup>) can help the driver maintain an even speed to provide a more relaxing driving experience on highways and long, straight roads with even traffic flows.

Cruise control is not available in vehicles equipped with Pilot Assist.

#### Using engine braking instead of applying the brakes

Cruise Control regulates speed by lightly applying the brakes. On downgrades, it can sometimes be desirable to roll a bit faster and let speed be reduced instead by engine braking alone. The driver can temporarily disengage the Cruise Control braking function.

To disengage CC:

- 1 Press the accelerator pedal about halfway down and then release it.
- Cruise Control will automatically disengage the automatic brake function and speed will only be reduced using the engine braking function.

#### Warning

- The function is supplementary driver support intended to facilitate driving and help make it safer – it cannot handle all situations in all traffic, weather and road conditions.
- The driver is advised to read all sections in the Owner's Manual about this function to learn of its limitations, which the driver must be aware of before using the function.
- Driver support functions are not a substitute for the driver's attention and judgment. The driver is always responsible for ensuring the vehicle is driven in a safe manner, at the appropriate speed, with an appropriate distance to other vehicles, and in accordance with current traffic rules and regulations.

## 10.1.1.2. Cruise control standby mode

Cruise control (CC<sup>[1]</sup>) can be deactivated and put in standby mode. This can take place automatically or be due to driver intervention.

Standby mode means that the function is selected in the instrument panel but not activated. The symbol in the instrument panel is not illuminated and cruise control is not regulating the speed.

### Standby mode due to action by the driver

Cruise control will be deactivated and put in standby mode if any of the following occurs:

- The brakes are applied.
- The gear selector is moved to **N**.
- The vehicle is driven faster than the set speed for more than 1 minute.

The driver must then control the vehicle's speed.

Temporarily increasing speed using the accelerator pedal, e.g. when passing another vehicle, will not affect the setting. The vehicle will return to the set speed when the accelerator pedal is released.

### Automatic standby mode

The function may automatically go into standby mode if one of the following occurs:

- The wheels lose traction.
- The engine speed (rpm) is too low/high.
- The temperature in the brake system becomes too high.
- The vehicle's speed goes below 30 km/h (20 mph).

The driver must then control the vehicle's speed.

## 10.1.1.3. Adjusting set speed for speed-controlling functions

It is possible to adjust set speeds for cruise control and Pilot Assist\* functions.

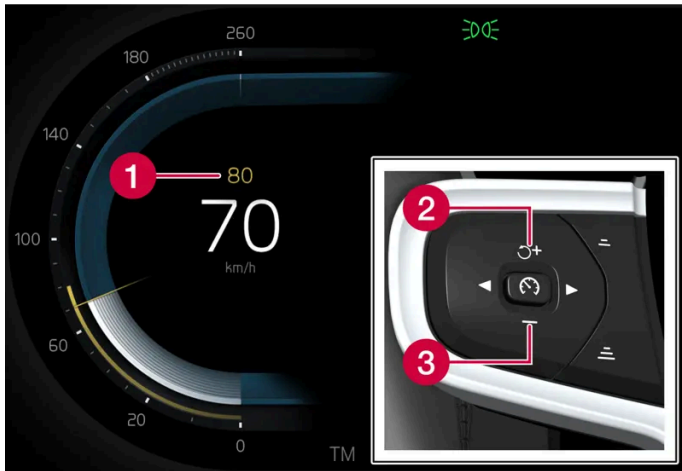

- 1 Set speed
- 2 + : Increases the set speed
- 3 - : Reduces the set speed

- 1 Change a set speed by pressing the + (1) or - (2) buttons briefly or by pressing and holding them:
    - **Brief press:** Each press changes the speed in +/- 5 km/h (+/- 5 mph) increments.
    - **Press and hold:** Release the button when the set speed indicator (3) has moved to the desired speed.
- > The most recently set speed will be stored.

**Note**

For vehicles without Pilot Assist, speed instead increases by +/- 1 km/h (+/- 1 mph) each time the button is pressed.

## Pressing the accelerator pedal

If speed is increased by depressing the accelerator pedal while pressing the + (1) button on the steering wheel, the vehicle's speed when the button is pressed will be stored as the set speed.

Temporarily increasing speed using the accelerator pedal, e.g. when passing another vehicle, will not affect the setting. The vehicle will return to the set speed when the accelerator pedal is released.

## Possible speed

### Automatic transmission

The driver support functions can follow another vehicle at speeds from a standstill up to the vehicle's maximum speed.

Pilot Assist can provide steering assistance from near-stationary speeds up to 140 km/h (87 mph).

The lowest speed that can be set is 30 km/h (20 mph). When following another vehicle, ACC can monitor that vehicle's speed and slow your own vehicle down to a standstill, but it is not possible to set speeds lower than 30 km/h (20 mph).

\* Option/accessory.

---

## 10.1.2. Pilot Assist

---

### 10.1.2.1. Auto-hold braking with speed-controlling functions

The driver support function Pilot Assist\* has a special braking function in slow traffic and at a standstill. In certain situations, the parking brake will be applied to keep the vehicle at a standstill.

#### Braking function in slow traffic and at a standstill

In slow-moving, stop-and-go traffic or when stopped at a traffic light, driving will resume automatically if the vehicle is stopped for less than approx. 3 seconds. If it takes more than 3 seconds for the vehicle ahead to begin moving again, the driver support function will go into standby mode and the auto-hold brake function will activate.

- 1 The function can be reactivated by:
  - Pressing the  button on the steering wheel keypad.
  - Pressing the accelerator pedal.
- > The function will resume following the vehicle ahead if it begins to move within approx. 6 seconds.

 **Warning**

A noticeable increase in speed may follow when the speed is resumed with the  steering wheel button.

 **Warning**

The driver support system only issues a warning for obstacles detected by its radar sensor – thus, a warning may come after a delay or not at all.

- Never wait for a warning or assistance. Apply the brakes when necessary.



 **Note**

Driver support can keep the vehicle stationary for no more than 10 minutes – after that time the parking brake is applied and the function is deactivated.

The parking brake must be released before driver support can be reactivated.

#### **Deactivation of the Auto-hold brake function**

In certain situations, auto-hold will be deactivated when the vehicle is at a standstill and the function will go into standby mode. This means that the brakes will be released and the vehicle could begin to roll. The driver must actively apply the brakes to keep the vehicle stationary.

This can occur if:

- The driver depresses the brake pedal.
- The parking brake is applied.
- The gear selector is moved to the P, N or R position.
- The driver puts Pilot Assist in standby mode.

### **Auto Activate Parking Brake**

The parking brake will be applied if the function is keeping the vehicle stationary using the brakes and:

- The driver opens the door or unbuckles his/her seat belt.
- The function has kept the vehicle at a standstill for more than approx. 10 minutes.
- The brakes overheat.
- The driver switches off the engine.

\* Option/accessory.

---

## **10.1.2.2. Adjusting set speed for speed-controlling functions**

It is possible to adjust set speeds for cruise control and Pilot Assist\* functions.

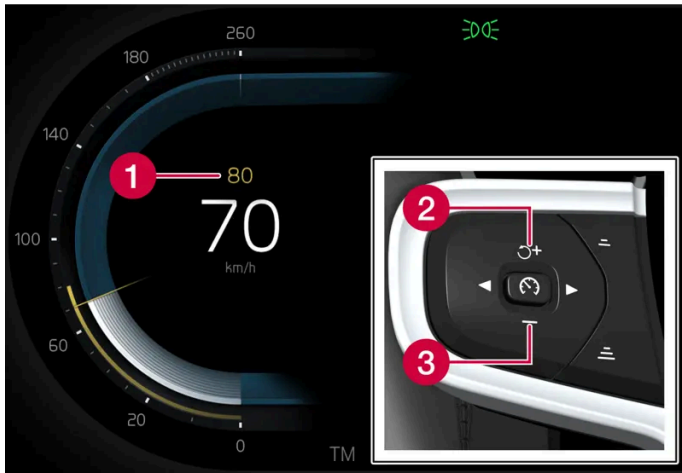

- 1 Set speed
- 2 + : Increases the set speed
- 3 - : Reduces the set speed

- 1 Change a set speed by pressing the + (1) or - (2) buttons briefly or by pressing and holding them:
    - **Brief press:** Each press changes the speed in +/- 5 km/h (+/- 5 mph) increments.
    - **Press and hold:** Release the button when the set speed indicator (3) has moved to the desired speed.
- > The most recently set speed will be stored.

**Note**

For vehicles without Pilot Assist, speed instead increases by +/- 1 km/h (+/- 1 mph) each time the button is pressed.

## Pressing the accelerator pedal

If speed is increased by depressing the accelerator pedal while pressing the + (1) button on the steering wheel, the vehicle's speed when the button is pressed will be stored as the set speed.

Temporarily increasing speed using the accelerator pedal, e.g. when passing another vehicle, will not affect the setting. The vehicle will return to the set speed when the accelerator pedal is released.

## Possible speed

### Automatic transmission

The driver support functions can follow another vehicle at speeds from a standstill up to the vehicle's maximum speed.

Pilot Assist can provide steering assistance from near-stationary speeds up to 140 km/h (87 mph).

The lowest speed that can be set is 30 km/h (20 mph). When following another vehicle, ACC can monitor that vehicle's speed and slow your own vehicle down to a standstill, but it is not possible to set speeds lower than 30 km/h (20 mph).

\* Option/accessory.

---

### 10.1.2.3. Switching target vehicles with speed-controlling functions

At certain speeds, models with automatic transmissions and the Pilot Assist\* driver support function can switch target vehicles.

#### Switching target vehicles

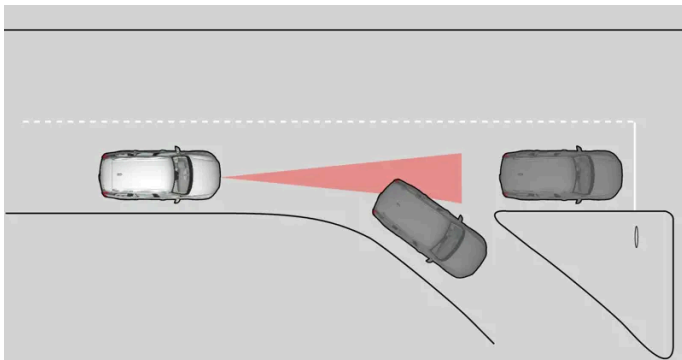

If the target vehicle ahead turns suddenly, there may be stationary traffic ahead.

When Pilot Assist is actively following another vehicle at speeds **under** 30 km/h (20 mph) and switches target vehicles – from a moving to a stationary vehicle – Pilot Assist will brake for the stationary vehicle.

#### Warning

When Pilot Assist is following another vehicle at speeds **over** approx. 30 km/h (20 mph) and changes target vehicle – from a moving vehicle to a stationary one – Pilot Assist will **ignore** the stationary vehicle and instead accelerate to the stored speed.

- The driver must then intervene and apply the brakes.

#### Automatic standby mode when switching targets

Pilot Assist disengages and goes into standby mode if:

- your vehicle's speed goes below 5 km/h (3 mph) and Pilot Assist cannot determine if the target object is a stationary vehicle or another object, e.g. a speed bump.
- your vehicle's speed goes under 5 km/h (3 mph) and the vehicle ahead turns so that Pilot Assist no longer has a vehicle to follow.

\* Option/accessory.

The content of this manual represents the status of the user manual at the time of printing and may not be completely valid in future instances. For more information refer to the first page for the complete disclaimer note.

## 10.1.2.4. Pilot Assist \*

Pilot Assist<sup>[1]</sup> can help the driver to maintain a constant speed, combined with a preset time interval to the vehicle ahead. Pilot Assist can also help the driver keep the vehicle within the lane markings.

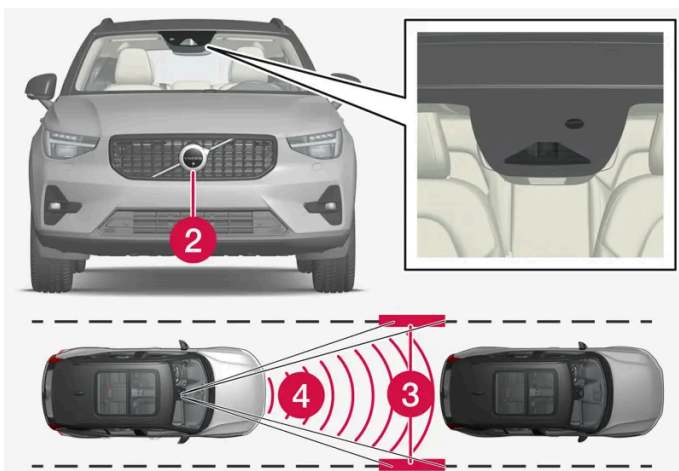

The camera and radar units monitor the distance to the vehicle ahead and detect lane markings.

- 1 Camera
- 2 Radar sensor
- 3 Lane marking detection
- 4 Distance detection

### Get to know Pilot Assist

The content of this manual represents the status of the user manual at the time of printing and may not be completely valid in future instances. For more information refer to the first page for the complete disclaimer note.

Pilot Assist helps to steer the vehicle, and you may need to drive a few miles with Pilot Assist before you feel completely at home with the function. It is important to be familiar with all of the function's applications and limitations in order to take advantage of all it has to offer.

The Pilot Assist function is primarily intended for use on highways and other major roads where it can help provide a more comfortable and relaxing driving experience.

The driver sets the desired speed and distance to the vehicle ahead. Pilot Assist monitors the distance to the vehicle ahead and the traffic lane's side markers using the camera. The system maintains the set time interval to the vehicle ahead by automatically adjusting your vehicle's speed and keeps your vehicle in its lane by providing steering assistance.

Pilot Assist regulates speed by accelerating and braking. It is normal for the brakes to emit a slight sound when they are being used to adjust speed.

Pilot Assist is designed to:

- smoothly regulate speed. The driver must apply the brakes in situations requiring immediate braking. For example, when there are great differences in speed between vehicles or if the vehicle ahead brakes suddenly. Due to limitations in the camera and radar sensor, braking may occur unexpectedly or not at all.
- follow a vehicle ahead in the same lane and maintain a time interval to that vehicle set by the driver. If the radar unit does not detect a vehicle ahead, it will instead maintain the maximum speed selected by the driver. This will also happen if the speed of the vehicle ahead exceeds the selected maximum speed for your vehicle.

## The vehicle's position in the traffic lane \*

When Pilot Assist helps to steer, it attempts to position the vehicle halfway between the visible lane marking lines. For a smoother drive, it is a good idea to allow the vehicle to find a good position. The driver can always adjust the position him/herself by increasing steering input. It is important for the driver to make sure the vehicle is positioned safely in the lane.

If Pilot Assist does not position the vehicle appropriately in the lane, the driver should turn off Pilot Assist or switch to Adaptive Cruise Control. This is done by pressing the right-facing arrow on the steering wheel.

## Steering assistance \*

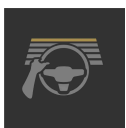

The color of the steering wheel symbol indicates the current status of steering assistance:

- Illuminated indicates that steering assistance is active
- Extinguished (as shown in illustration) indicates that steering assistance is deactivated.

Pilot Assist's steering assistance is based on monitoring the direction of the vehicle ahead and the traffic lane's side marker lines. The driver can adjust steering assistance from Pilot Assist at any time and steer in another direction, e.g. to change lanes or avoid obstacles on the road. Resistance will be felt in the steering wheel as long as steering assistance is active.

### Temporarily deactivating steering assistance



#### Warning

Pilot Assist is deactivated automatically and resumes working without prior notice.

When the turn signals are used, Pilot Assist's steering assistance will be temporarily deactivated. When the direction indicator is turned off, steering assistance is reactivated automatically if the lane's edge markings can still be detected.

If Pilot Assist cannot clearly interpret the lane's side marker lines and if the camera is unable for some other reason to clearly interpret the lane, Pilot Assist will temporarily deactivate steering assistance. Adaptive Cruise Control will remain active. Steering assistance will resume when the side marker lines can once again be interpreted. In these situations, the driver may be alerted through slight vibrations in the steering wheel that steering assistance is temporarily deactivated.

## In curves and forks in the road

Pilot Assist is designed to interact with the driver. The driver should never wait for steering assistance from Pilot Assist, but instead should always be ready to increase his or her own steering efforts, particularly in curves.

When the vehicle is approaching an off-ramp or a fork in the road, the driver should steer toward the desired lane so that Pilot Assist can detect the desired direction of travel.

## Hands on the steering wheel <sup>[2]</sup>

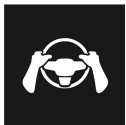

Pilot Assist only functions if the driver's hands are on the steering wheel. It is also important for the driver to always continue to be active and alert when driving since Pilot Assist is unable to read all situations and may toggle between off and on without prior warning.

### **Warning**

Act immediately if any warning signal is triggered – do not wait for all levels of warnings and assistance from the systems to be provided.

1. If Pilot Assist detects that the driver's hands are not on the steering wheel, the system will provide a symbol and a text message in the instrument panel to instruct the driver to actively steer the vehicle.
2. If the driver's hands are still detected on the steering wheel after a few seconds have passed the instructions to actively steer the vehicle will be repeated accompanied by an audible signal.
3. If Pilot Assist still does not detect the driver's hands on the steering wheel after a few more seconds have passed, the audible signal will become intense and the steering function will switch off. Pilot Assist must then be reactivated by pressing the  button on the steering wheel.
4. When Pilot Assist is switched off, additional sound and light signals will be given, and the vehicle's systems will begin braking the vehicle. This braking takes place intermittently in order to attract the driver's attention. <sup>[3]</sup> <sup>[2]</sup>
5. The system continues to brake the vehicle to a standstill in its own lane and activates the hazard warning flashers <sup>[4]</sup> <sup>[2]</sup>

## Steep roads and/or heavy loads

Pilot Assist is primarily intended to be driven on flat roads. The function may not be able to maintain the correct time interval to the vehicle ahead when driving down steep downgrades. The driver should be extra attentive and prepared to apply the brakes.

Do not use Pilot Assist if the vehicle is carrying a heavy load or towing a trailer.

Pilot Assist will not provide steering assistance if anything is connected in the towbar connector.

### **Note**

Pilot Assist will not provide steering assistance if anything is connected to the towbar connector, for example a trailer or bicycle holder.

## Read all warnings before use

### **Warning**

- The function is supplementary driver support intended to facilitate driving and help make it safer – it cannot handle all situations in all traffic, weather and road conditions.
- The driver is advised to read all sections in the Owner's Manual about this function to learn of its limitations, which the driver must be aware of before using the function.
- Driver support functions are not a substitute for the driver's attention and judgment. The driver is always responsible for ensuring the vehicle is driven in a safe manner, at the appropriate speed, with an appropriate distance to other vehicles, and in accordance with current traffic rules and regulations.

### **Note**

The function uses the vehicle's camera and radar sensor, which has certain general limitations.

### **Important**

Only a workshop may perform maintenance on driver support components – an authorized Volvo workshop is recommended.

 **Warning**

In some situations, steering assistance may have trouble helping the driver properly or may be deactivated automatically – we advise against using steering assistance in such cases. Examples of such situations include:

- the lane markings are unclear, worn, missing, cross each other, or there are multiple sets of road markings.
- the lane division changes, e.g. when lanes split or merge, and at off-ramps.
- when there is road construction and sudden changes to the road surface, e.g. when the lines may no longer mark the correct route.
- edges or other lines than lane markings are present on or near the road, e.g. curbs, joints or repairs to the road surface, edges of barriers, roadside edges or strong shadows.
- the lane is narrow or winding.
- the lane contains ridges or holes.
- weather conditions are poor, e.g. rain, snow or fog or slush or reduced visibility with poor light conditions, backlighting, wet road surface, etc.

The driver should also note that Pilot Assist has the following limitations:

- High curbs, roadside barriers, temporary obstacles (traffic cones, safety barriers, etc.) are not detected. Alternatively, they may be detected incorrectly as lane markings, with a subsequent risk of contact between the vehicle and such obstacles. The driver is responsible for ensuring that the vehicle maintains a suitable distance from such obstacles.
- The camera and radar units do not have the capacity to detect all oncoming objects and obstacles in traffic environments, e.g. potholes, stationary obstacles or objects that completely or partially block the route.
- Pilot Assist does not "see" pedestrians, animals, etc.
- The steering assistance is limited in force, which means that Pilot Assist cannot always help the driver to steer and keep the vehicle within the lane.
- In vehicles equipped with map data, the function is able to use information from map data, which could cause variations in performance.
- Pilot Assist will be switched off if the speed-dependent power steering wheel resistance is working at reduced power, e.g. during cooling due to overheating.

 **Warning**

Steering assistance should only be used if there are clear lane lines painted on each side of the lane. All other use will increase the risk of contact with nearby obstacles that cannot be detected by the functions.

 **Warning**

- This is not a collision avoidance system. The driver is always responsible and must intervene if the system fails to detect a vehicle ahead.
- The function does not brake consistently for people or animals and does not brake for small vehicles, such as bicycles and motorcycles. Similarly, it does not brake for low trailers, oncoming, slow-moving or stationary vehicles and objects.
- Do not use the function in demanding situations, such as in city traffic, at intersections, on slippery surfaces, with a lot of water or slush on the road, in heavy rain/snow, in poor visibility, on winding roads, or on on/off ramps.



\* Option/accessory.

[1] Depending on market, this function can be either standard or optional.

[2] The function is available in certain markets.

[3] The function can vary between countries.



[4] Regulations for using hazard warning flashers may vary from country to country.

---

## 10.1.2.5. Pilot Assist\* displays

The following illustrations show how Pilot Assist\* and Adaptive Cruise Control<sup>[1]</sup> may be displayed in the instrument panel.

### Symbol indication

	Adaptive Cruise Control is active. Pilot Assist is selected but not available. The conditions for the function are not met.
	Pilot Assist is active.

### Speed

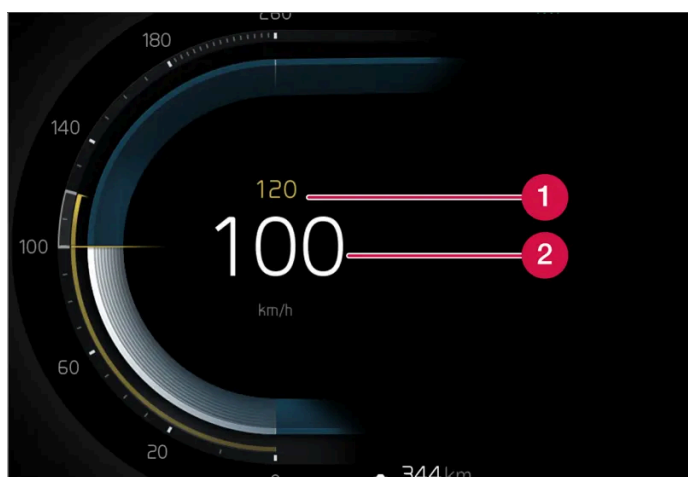



Speed indicators.

1 Set speed

2 The current speed of your vehicle

## Time interval





	When the symbol in the instrument panel shows a vehicle, the time interval to the vehicle ahead is being regulated.
	When no vehicle is shown, the functions are following the saved speed.

\* Option/accessory.

<sup>[1]</sup> Depending on market, these functions can be either standard or optional.

## 10.1.2.6. Pilot Assist\* symbols and messages

A number of symbols and messages relating to Pilot Assist<sup>[1]</sup> may be displayed. Several examples are provided below.

Symbol	Message	Meaning
	The symbol is illuminated. The vehicle symbol is illuminated when the vehicle has a vehicle ahead to relate to.	The vehicle is maintaining the set speed.
	Pilot Assist Service required The symbol is extinguished	The system is not functioning as intended. Contact a workshop. Pilot Assist is in standby mode.
	Extinguished steering wheel symbol	Indicates that steering assistance is deactivated. When Pilot Assist is providing steering assistance, the steering wheel is illuminated.
	Symbol for hands on the steering wheel	The system cannot detect the driver's hands on the steering wheel. Place your hands on the steering wheel and actively steer the vehicle. The system alerts in various stages along with audible signals. The hazard warning flashers are activated if the vehicle needs to brake down to a standstill.
	Radar sensor front Sensor blocked See Owner's manual, Front radar alignment incomplete or Front camera alignment incomplete	Clean the area in front of the radar sensors.

A text message can be erased by briefly pressing the  button in the center of the right-side steering wheel keypad.

If the message persists, contact a workshop. An authorized Volvo workshop is recommended.

\* Option/accessory.

<sup>[1]</sup> Depending on market, this function can be either standard or optional.

## 10.1.2.7. Pilot Assist\* standby mode

Pilot Assist and Adaptive Cruise Control<sup>[1]</sup> can be deactivated and put in standby mode. This can take place automatically or be due to driver intervention.

Standby mode means that the function is selected in the instrument panel but not activated. The functions will then not regulate speed or distance to the vehicle ahead, or provide steering assistance.

## Standby mode due to action by the driver

Pilot Assist will be deactivated and put in standby mode if any of the following occurs:

- The brakes are applied.
- The gear selector is moved to **N**.
- A turn signal is used for more than 1 minute.
- The vehicle is driven faster than the set speed for more than 1 minute.

Temporarily increasing speed using the accelerator pedal, e.g. when passing another vehicle, will not affect the setting. The vehicle will return to the set speed when the accelerator pedal is released.

### **Warning**

- With Adaptive Cruise Control in standby mode, the driver must intervene and regulate both speed and distance to the vehicle ahead.
- If the vehicle comes too close to a vehicle ahead when Adaptive Cruise Control is in standby mode, the driver can be warned of the short distance by the Distance Alert\* function instead.

## Automatic standby mode

### **Warning**

With automatic standby mode, the driver is warned by an audible signal and a message in the instrument panel.

- The driver must then regulate vehicle speed, apply the brakes if necessary, steer the vehicle and maintain a safe distance to other vehicles.

The function may automatically go into standby mode if one of the following occurs.

- One of the systems that Pilot Assist is dependent on stops working, such as Electronic Stability Control<sup>[2]</sup>.
- The driver opens the door.
- The driver unbuckles the seat belt.
- The engine speed (rpm) is too low/high.
- One or more of the wheels lose traction.
- The brake temperature is high.
- The parking brake is applied.
- The camera and radar units are covered by snow or heavy rain (the camera lens/radar waves are blocked).
- Your vehicle's speed goes below 5 km/h(3 mph) and Pilot Assist cannot determine if the vehicle ahead is stationary or if it is another object, e.g. a speed bump.

**The content of this manual represents the status of the user manual at the time of printing and may not be completely valid in future instances. For more information refer to the first page for the complete disclaimer note.**

- Your vehicle's speed goes below 5 km/h(3 mph) and the vehicle ahead turns so that Pilot Assist no longer has a vehicle to follow.

\* Option/accessory.

[1] Depending on market, this function can be either standard or optional.

[2] Electronic Stability Control

## 10.1.2.8. Setting time interval to the vehicle ahead

The time interval to the vehicle ahead can be set for Pilot Assist\*.

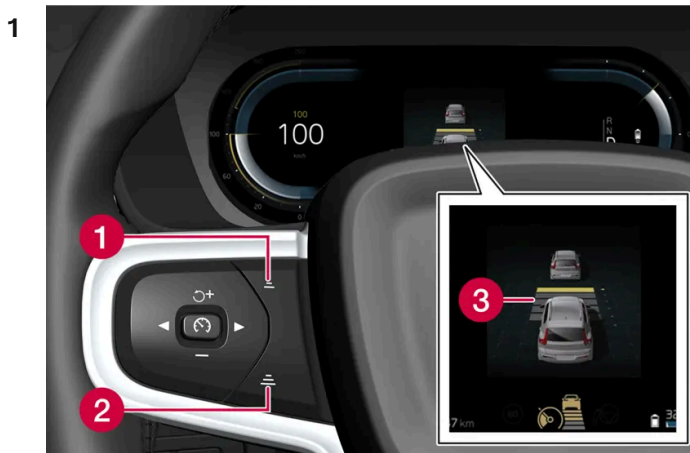

Controls for setting a time interval.

- 1 Reduce the time interval
- 2 Increase the time interval
- 3 Distance indicator

Press the (1) or (2) button to decrease or increase the time interval.

➤ The distance indicator (3) shows the current time interval.

Different time intervals to the vehicle ahead can be selected and are shown in the instrument panel as 1–5 horizontal bars. The more bars, the longer the time interval. One bar represents an interval of approx. 1 second to the vehicle ahead. 5 bars represents approx. 3 seconds.

In order to help your vehicle follow the vehicle ahead as smoothly and comfortably as possible, Pilot Assist allows the time interval to vary noticeably in certain situations. At low speeds, when the distance to the vehicle ahead is short, Pilot Assist increases the time interval slightly.

 **Note**

When the symbol in the instrument panel shows a vehicle and a steering wheel, Pilot Assist follows a vehicle ahead at a preset time interval.

When only a steering wheel is shown, there is no vehicle ahead within a reasonable distance.

 **Note**

- The greater the vehicles' speed, the greater the distance between them for a set time interval.
- Only use the time intervals permitted by local traffic regulations.
- If driver support does not seem to respond with a speed increase when activated, it may be because the time interval to the vehicle ahead is shorter than the set time interval.

 **Warning**

- Only use a time interval suitable for the current traffic conditions.
- The driver should be aware that short time intervals give them limited time to react and act to any unforeseen traffic situation.

\* Option/accessory.

---

## 10.1.2.9. Differences between Pilot Assist\* and Lane Keeping Aid

Pilot Assist is a comfort function that can help keep the vehicle in its own lane and maintain the distance to the vehicle in front of you. Lane Keeping Aid<sup>[1]</sup> is a function that similarly helps in certain situations to reduce the risk of the vehicle unintentionally veering out of its lane.

### Pilot Assist



Pilot Assist can help you to steer your vehicle between the lane markings, as well as maintain a preset speed and distance to the vehicle ahead. The function can also use the lane marking lines to help the driver maintain a favorable position in the lane.

#### What does Pilot Assist do?

- Can help to keep the vehicle within its lane by assisting steering in some cases.
- Can help to maintain a preset speed or the distance to the vehicle ahead by means of acceleration and braking operations.

#### How do I know that Pilot Assist is on?

Symbols in the vehicle's instrument panel let you know when Pilot Assist is on.

	Adaptive Cruise Control is active. Pilot Assist is selected but not available. The conditions for the function are not met.
	Pilot Assist is active.

## Lane Keeping Aid

Lane Keeping Aid can provide steering assistance and/or a warning to the driver when the vehicle is about to leave its lane unintentionally. The function is active between 65-180 km/h (40-112 mph) on roads with clearly visible side markings.

### What does Lane Keeping Aid do?

- Lane Keeping Aid can provide the driver with steering assistance, steering the vehicle back into its lane and/or providing warnings using steering wheel vibration.

### How do I know that Lane Keeping Aid is on?

Symbols in the vehicle's instrument panel show the function status.



An extinguished symbol in the instrument panel means that the function is on but that the conditions for LKA have not been met.



White symbol in the instrument panel means that the conditions for LKA have been met and that the function is available.



An orange symbol in the instrument panel means that LKA is providing steering assistance back into the lane and/or giving a warning with vibration in the steering wheel.

### Warning

The driver is always responsible for ensuring that the vehicle is operated in a safe manner. The driver is advised to read all of the sections in the Owner's Manual about this function before using the function.

### Warning

- The function is supplementary driver support intended to facilitate driving and help make it safer – it cannot handle all situations in all traffic, weather and road conditions.
- The driver is advised to read all sections in the Owner's Manual about this function to learn of its limitations, which the driver must be aware of before using the function.
- Driver support functions are not a substitute for the driver's attention and judgment. The driver is always responsible for ensuring the vehicle is driven in a safe manner, at the appropriate speed, with an appropriate distance to other vehicles, and in accordance with current traffic rules and regulations.

\* Option/accessory.

[1] Lane Keeping Aid(LKA)

## 10.1.2.10. Collision risk warning from speed-controlling functions

The driver support system Pilot Assist\* can alert the driver if the distance to the vehicle ahead suddenly decreases to an unsafe distance.

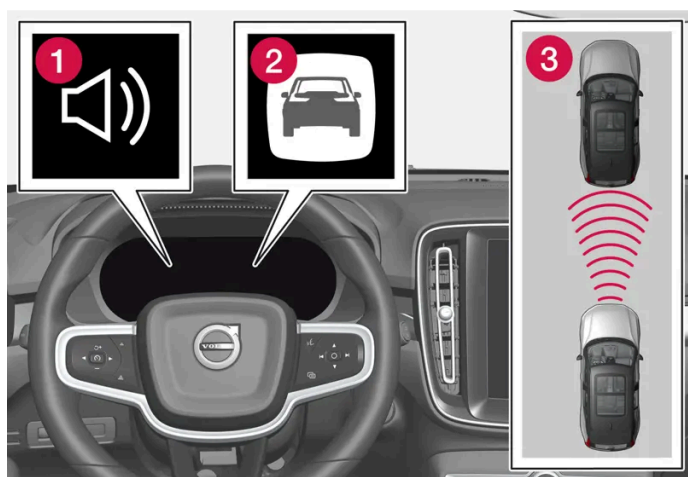

Collision warning audible signal and symbol

- 1 Audible signal at risk of collision
- 2 Collision warning symbol
- 3 Camera and radar unit distance monitoring

Pilot Assist uses approx. 40% of the vehicle's braking capacity. If a situation requires more braking force than driver support can provide, and if the driver does not apply the brakes, a warning light and audible warning signal will be activated to alert the driver that immediate action is required.

### Warning

The driver support system only issues a warning for vehicles detected by its radar unit – thus, a warning may come after a delay or not at all. Never wait for a warning. Apply the brakes when necessary.

\* Option/accessory.

## 10.1.3. Passing assistance

The content of this manual represents the status of the user manual at the time of printing and may not be completely valid in future instances. For more information refer to the first page for the complete disclaimer note.

---

## 10.1.3.1. Passing assistance \*

Passing assistance can assist the driver when passing other vehicles. The function can be used with Pilot Assist\*.

When Pilot Assist is following another vehicle and you indicate that you intend to pass that vehicle by using the turn signal<sup>[1]</sup>, the system can assist by beginning to accelerate toward the vehicle ahead **before** your vehicle has moved into the passing lane.

The function will then delay a speed reduction to avoid early braking as your vehicle approaches a slower-moving vehicle.

The function remains active until your vehicle has passed the other vehicle.

### Warning

Please note that this function can be activated in more situations than just passing another vehicle, such as when a direction indicator is used to indicate a lane change or before exiting to another road – the vehicle will then briefly accelerate.

### Warning

- The function is supplementary driver support intended to facilitate driving and help make it safer – it cannot handle all situations in all traffic, weather and road conditions.
- The driver is advised to read all sections in the Owner's Manual about this function to learn of its limitations, which the driver must be aware of before using the function.
- Driver support functions are not a substitute for the driver's attention and judgment. The driver is always responsible for ensuring the vehicle is driven in a safe manner, at the appropriate speed, with an appropriate distance to other vehicles, and in accordance with current traffic rules and regulations.

\* Option/accessory.

<sup>[1]</sup> Only the left-hand turn signal for left-hand drive vehicles, or right-hand turn signal for right-hand drive vehicles.

---

## 10.1.3.2. Using passing assistance \*

Passing assistance can be used with Pilot Assist\* and Adaptive Cruise Control. Several conditions must be met for passing assistance to be possible.

In order to activate passing assistance:

- your vehicle must be following a vehicle ahead (target vehicle)
- your vehicle's **current speed** must be at least 70 km/h (43 mph)
- **the selected speed** must be high enough to safely pass another vehicle.



To start passing assistance:

- 1 Turn on the left turn signal.
- Passing assistance begins accelerating and shortens the time interval to the vehicle ahead for a short period of time to facilitate passing. If the passing maneuver is not completed, the time interval will revert to the preset value.

 **Warning**

The driver should be aware that if conditions suddenly change when using Passing Assistance, the function may implement an undesired acceleration in certain conditions.

Some situations should be avoided, e.g. if:

- the vehicle is approaching an exit in the same direction as passing would normally occur
- the vehicle ahead slows before your vehicle has had time to switch to the passing lane
- traffic in the passing lane slows down



Situations of this type can be avoided by temporarily putting Pilot Assist in standby mode.

\* Option/accessory.

## 10.1.4. Cruise control functions

There are several driver support systems that can assist you while driving in order to maintain a suitable speed depending on situation. Here is a summary to make them more easily distinguishable.

We recommend that you read all of the sections in the Owner's Manual that relate to a function in order to learn about factors such as its limitations and what the driver should be aware of before using the system.

	Cruise control <sup>[1]</sup>	Adaptive Cruise Control <sup>[2]</sup>	Pilot Assist* <sup>[2]</sup>
Symbol in the instrument panel			
Brief description	Cruise control can help the driver maintain an even speed to provide a more relaxing driving experience on e.g. highways and long, straight roads with even traffic flows.	Adaptive Cruise Control can help the driver to maintain a constant speed, combined with a preset time interval to the vehicle in front.	Pilot Assist can help the driver keep the vehicle in the current traffic lane by providing steering assistance and maintaining an even speed and a set time interval to the vehicle ahead.

[1] Cruise Control

[2] Depending on market, this function can be either standard or optional.

\* Option/accessory.

## 10.1.5. Steering wheel buttons for speed-controlling functions

In the center display, the selected speed-controlling function can be controlled via the left steering wheel keypad. This applies for cruise control (CC<sup>[1]</sup>), Pilot Assist\* and Adaptive Cruise Control\*.

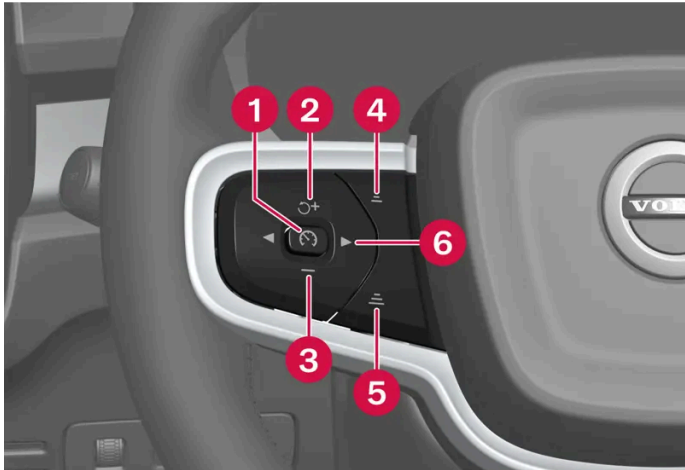

Buttons for speed-controlling functions

- 1 : **From standby mode** – Activates the selected function and sets the current speed. : **From active mode** – Puts the function in standby mode.
- 2 : **From standby mode** – Activates the selected function and resumes the stored speed. : **From active mode** – Increases the stored speed.
- 3 : Reduces the set speed.
- 4 : Reduces the time interval to the vehicle ahead.
- 5 : Increases the time interval to the vehicle ahead.
- 6 : Switches between Pilot Assist\* and Adaptive Cruise Control\*.

### **Warning**

- The function is supplementary driver support intended to facilitate driving and help make it safer – it cannot handle all situations in all traffic, weather and road conditions.
- The driver is advised to read all sections in the Owner's Manual about this function to learn of its limitations, which the driver must be aware of before using the function.
- Driver support functions are not a substitute for the driver's attention and judgment. The driver is always responsible for ensuring the vehicle is driven in a safe manner, at the appropriate speed, with an appropriate distance to other vehicles, and in accordance with current traffic rules and regulations.



<sup>[1]</sup> Cruise Control

\* Option/accessory.

## 10.1.6. Selecting and activating speed-controlling functions

The content of this manual represents the status of the user manual at the time of printing and may not be completely valid in future instances. For more information refer to the first page for the complete disclaimer note.

When a particular speed-controlling function is preferred, it can be selected in the center display before being activated with the steering wheel button. This applies for cruise control (CC<sup>[1]</sup>), Pilot Assist\* and Adaptive Cruise Control\*.

- 1 Tap  in the center display.
- 2 Tap **Driving** and activate your preferred function.
- 3 When the desired function is selected, press  on the steering wheel keypad to activate.
  - The symbol in the instrument panel lights up – the function starts and the current speed is stored as the maximum speed.
- 4 If the function goes into standby mode – press the  button on the steering wheel to reactivate.
  - The speed-controlling markings in the instrument panel illuminate and the vehicle will then return to the most recently set speed.

To always get Pilot Assist when activating speed-controlling functions at each new driving cycle:

- 1 Tap  in the center display.
- 2 Tap **Driving**.
- 3 Activate **Pilot Assist as default**.

#### **Warning**

A noticeable increase in speed may follow when the speed is resumed with the  steering wheel button.

## Requirements

Certain conditions must be met in order to start any of the functions.

### Cruise control

- In order to start Cruise Control from standby mode, the vehicle's current speed must be 30 km/h (20 mph) or higher.

### Adaptive Cruise Control

- The driver's seat belt must be buckled and the driver's door must be closed.
- There must be a vehicle ahead (target vehicle) within a reasonable distance or your vehicle's current speed must be at least 15 km/h (9 mph).

### Pilot Assist

The content of this manual represents the status of the user manual at the time of printing and may not be completely valid in future instances. For more information refer to the first page for the complete disclaimer note.

- The driver's seat belt must be buckled and the driver's door must be closed.
- The side markings of the lane must be clearly visible and detected by the vehicle.
- There must be a vehicle ahead (target vehicle) within a reasonable distance or your vehicle's current speed must be at least 15 km/h (9 mph).
- The speed must not exceed 140 km/h (87 mph).
- The driver must keep their hands on the steering wheel.

<sup>[1]</sup> Cruise Control

\* Option/accessory.

---

## 10.1.7. Deactivating speed-controlling functions

The speed-controlling functions can be deactivated using the button on the steering wheel. The relevant function will then go into standby mode. This applies for cruise control (CC<sup>[1]</sup>) and Pilot Assist\*.

- 1 Pressing the  button on the steering wheel keypad.
  - The symbol and the markings in the instrument panel are extinguished – the selected speed-controlling functions are in standby mode.

When another function is selected in the center display, the instrument panel's symbol and marking for the previously selected function are hidden, and the set/stored maximum speed is deleted.

### Warning

When speed-controlling functions are in standby mode, the driver must intervene and regulate both speed and distance to the vehicle ahead.

<sup>[1]</sup> Cruise Control

\* Option/accessory.

---

## 10.2. Distance Alert

---

## 10.2.1. Setting time interval to the vehicle ahead

The time interval to the vehicle ahead can be set for Pilot Assist\*.

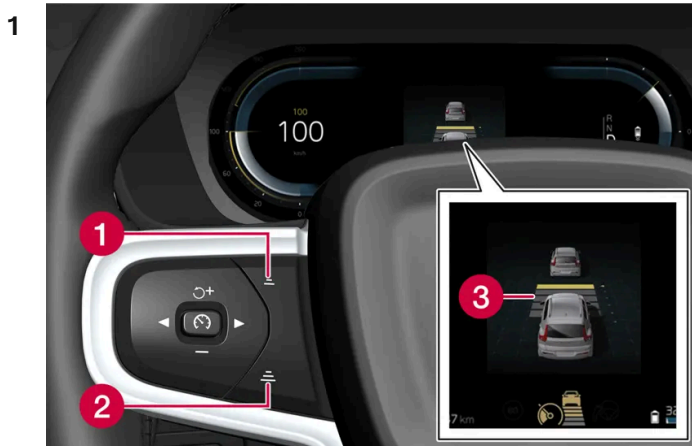

Controls for setting a time interval.

- 1 Reduce the time interval
- 2 Increase the time interval
- 3 Distance indicator

Press the (1) or (2) button to decrease or increase the time interval.

➤ The distance indicator (3) shows the current time interval.

Different time intervals to the vehicle ahead can be selected and are shown in the instrument panel as 1–5 horizontal bars. The more bars, the longer the time interval. One bar represents an interval of approx. 1 second to the vehicle ahead. 5 bars represents approx. 3 seconds.

In order to help your vehicle follow the vehicle ahead as smoothly and comfortably as possible, Pilot Assist allows the time interval to vary noticeably in certain situations. At low speeds, when the distance to the vehicle ahead is short, Pilot Assist increases the time interval slightly.

### Note

When the symbol in the instrument panel shows a vehicle and a steering wheel, Pilot Assist follows a vehicle ahead at a preset time interval.

When only a steering wheel is shown, there is no vehicle ahead within a reasonable distance.

**Note**

- The greater the vehicles' speed, the greater the distance between them for a set time interval.
- Only use the time intervals permitted by local traffic regulations.
- If driver support does not seem to respond with a speed increase when activated, it may be because the time interval to the vehicle ahead is shorter than the set time interval.

**Warning**

- Only use a time interval suitable for the current traffic conditions.
- The driver should be aware that short time intervals give them limited time to react and act to any unforeseen traffic situation.

\* Option/accessory.

## 10.2.2. Collision risk warning from speed-controlling functions

The driver support system Pilot Assist\* can alert the driver if the distance to the vehicle ahead suddenly decreases to an unsafe distance.

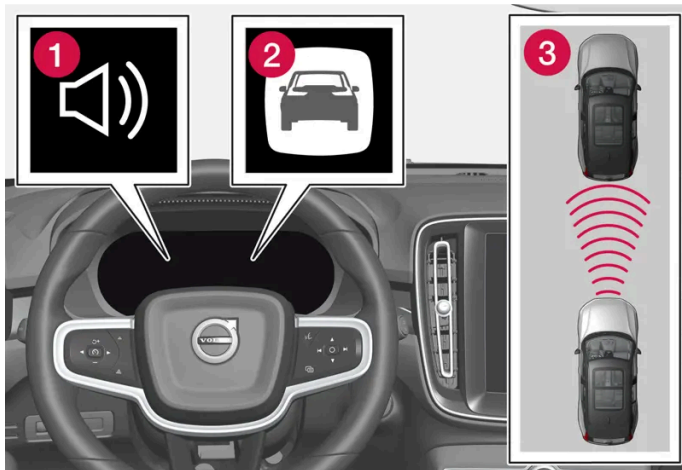

Collision warning audible signal and symbol

- 1 Audible signal at risk of collision
- 2 Collision warning symbol
- 3 Camera and radar unit distance monitoring

Pilot Assist uses approx. 40% of the vehicle's braking capacity. If a situation requires more braking force than driver support can provide, and if the driver does not apply the brakes, a warning light and audible warning signal will be activated to alert the driver that immediate action is required.

 **Warning**

The driver support system only issues a warning for vehicles detected by its radar unit – thus, a warning may come after a delay or not at all. Never wait for a warning. Apply the brakes when necessary.

\* Option/accessory.

---

## 10.3. Blind Spot Information

---

### 10.3.1. BLIS \*

The BLIS<sup>[1]</sup> function is designed to help provide assistance in heavy traffic with several lanes moving in the same direction by helping the driver to detect the presence of vehicles in the "blind spot" area behind and to the side of the vehicle.



Location of BLIS indicator light

BLIS is a driver support system designed to alert the driver of:

- vehicles in your "blind spot"

- vehicles approaching rapidly in adjacent lanes.

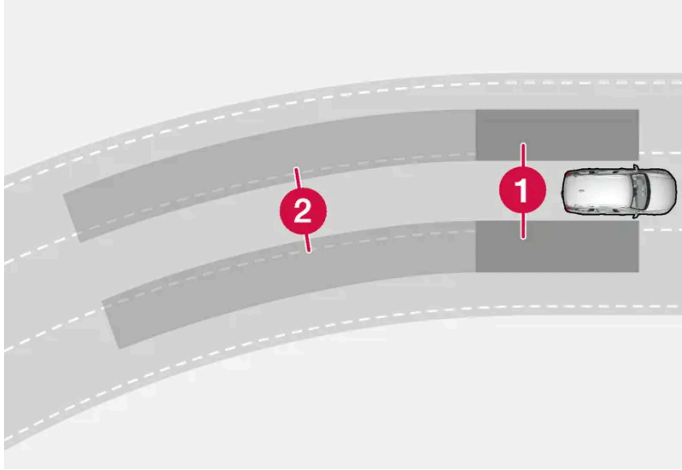

BLIS overview

- 1 Blind spot zone
- 2 Rapidly approaching vehicle zone

The system is designed to react to:

- vehicles passing your vehicle
- another vehicle is rapidly approaching your vehicle.

When BLIS detects a vehicle in zone 1 or a rapidly approaching vehicle in zone 2, an indicator light will illuminate in the right or left rearview mirror and glow steadily. If the driver then uses the turn signal on the side in which the warning has been given, the indicator light will become brighter and begin flashing.

BLIS is active when your vehicle is traveling at a speed over 12 km/h (7 mph).

BLIS reacts to passing vehicles traveling up to 100 km/h (62 mph) faster than your vehicle.

**Note**

The light illuminates on the side of the vehicle where the system has detected the vehicle. If the vehicle is passed on both sides simultaneously, both lights come on.

**Warning**

- The function is supplementary driver support intended to facilitate driving and help make it safer – it cannot handle all situations in all traffic, weather and road conditions.
- The driver is advised to read all sections in the Owner's Manual about this function to learn of its limitations, which the driver must be aware of before using the function.
- Driver support functions are not a substitute for the driver's attention and judgment. The driver is always responsible for ensuring the vehicle is driven in a safe manner, at the appropriate speed, with an appropriate distance to other vehicles, and in accordance with current traffic rules and regulations.

\* Option/accessory.

The content of this manual represents the status of the user manual at the time of printing and may not be completely valid in future instances. For more information refer to the first page for the complete disclaimer note.



---

## 10.3.2. BLIS\* messages

A number of messages related to BLIS [1] may be displayed in the instrument panel. Several examples are provided below.

Message	Meaning
Blind spot sensor Service required	The system is not functioning as intended. Contact a workshop [2].
Blind spot system off Trailer attached	BLIS and Cross Traffic Alert* have been deactivated because a trailer has been connected to the vehicle's electrical system.

A text message can be erased by briefly pressing the  button in the center of the right-side steering wheel keypad.

If the message persists, contact a workshop. An authorized Volvo workshop is recommended.

\* Option/accessory.

[1] Blind Spot Information

[2] An authorized Volvo workshop is recommended.

---

## 10.3.3. BLIS\* limitations

BLIS [1] functionality may be reduced in certain situations.



Keep the marked area clean (on both the left and right sides of the vehicle).

Examples of limitations:

- Dirt, ice and snow covering the sensors may reduce functionality and prevent the system from providing warnings.

- The BLIS function is automatically deactivated if a trailer, bicycle holder or similar is connected to the vehicle's electrical system.
- For BLIS to function effectively, bicycle holders, luggage racks or similar should not be mounted on the vehicle's towbar.

 **Warning**

- BLIS does not work in sharp curves.
- BLIS does not work when the vehicle is being reversed.

 **Note**

The function uses the vehicle's radar sensors, which have certain general limitations.

\* Option/accessory.

<sup>[1]</sup> Blind Spot Information

---

## 10.4. Cross Traffic Alert

---

### 10.4.1. Warning and auto-braking while backing up\*

There are systems in the vehicle that can help the driver detect obstacles when backing up and even automatically brake the vehicle if the driver does not react in time.

The Rear Auto Brake (RAB) and Cross Traffic Alert (CTA)\* functions are only active when the vehicle is moving backward or if reverse gear is engaged.

If an obstacle is detected:

1. A warning signal and the Park Assist graphic illuminate to indicate the location of the obstacle.
2. If the driver does not react to the warning and a collision is unavoidable, the vehicle may automatically brake, and a message will appear explaining why the brakes were applied.

If the accelerator pedal is depressed forcibly, the vehicle will back up even after auto-braking.

 **Warning**

- The functions are supplementary driver support intended to facilitate driving and help make it safer – they cannot handle all situations in all traffic, weather and road conditions.
- The driver is advised to read all sections in the Owner's Manual about these functions to learn of their limitations, which the driver must be aware of before using the functions.
- Driver support functions are not a substitute for the driver's attention and judgment. The driver is always responsible for ensuring the vehicle is driven in a safe manner, at the appropriate speed, with an appropriate distance to other vehicles, and in accordance with current traffic rules and regulations.

 **Note**

The functions use the vehicle's sensors and radar units, which have certain general limitations.

## Obstacles directly behind the vehicle

Rear Auto Brake is designed to help the driver detect stationary obstacles directly behind the vehicle when backing up.

This function is primarily designed to detect stationary objects that are taller than the rear bumper and not, for example, moving vehicles.

Braking intervention with Rear Auto Brake is active at speeds under 10 km/h (6 mph).

The auto brake needs to be deactivated before entering automatic car washes and may also need to be deactivated to avoid undesirable interventions, e.g. when backing up in tall grass.

## Obstacles from the side

Cross Traffic Alert is intended to help the driver detect vehicles crossing behind the vehicle while backing up.

This function is primarily designed to detect larger moving vehicles, but in certain cases can also detect pedestrians or smaller objects such as bicycles.

Braking intervention with Cross Traffic Alert is active at speeds under 15 km/h (9 mph).

The auto brake needs to be deactivated before entering automatic car washes and may also need to be deactivated to avoid undesirable interventions, e.g. when backing up in tall grass.

## Examples of detection and limitations

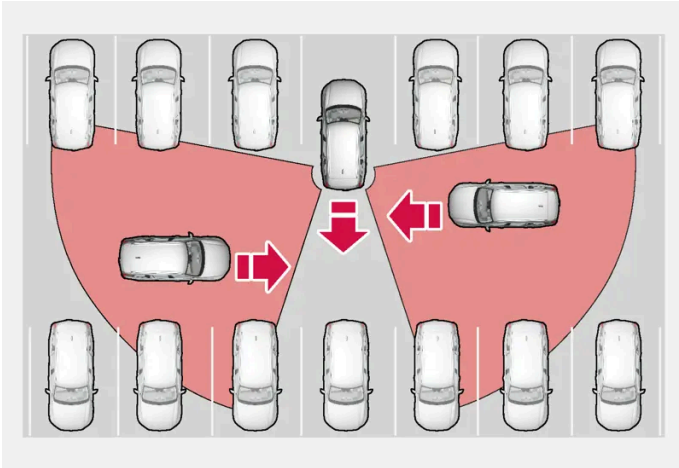

Examples of areas in which the function can help the driver detect obstacles while backing up.

The function's sensors cannot detect movements in traffic through other parked vehicles or objects blocking the vehicle. Here are some examples of when approaching vehicles can therefore not be detected until they are very close.

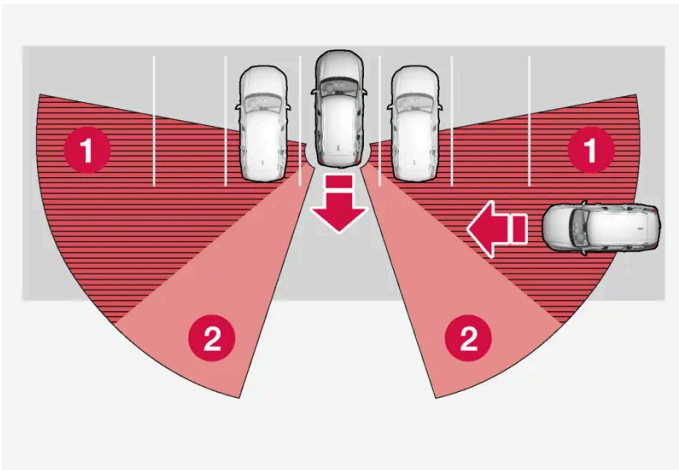

The vehicle is parked very far into a parking space.

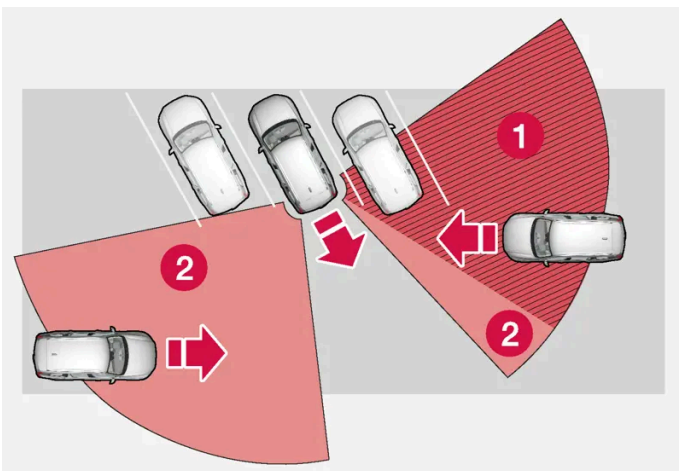

In a diagonal parking space, the sensors may be completely blocked on one side of your vehicle.

- 1 Blind zone
- 2 The function's detection sectors

However, as you back your vehicle slowly out of a parking space, CTA's field of vision changes in relation to the obstructing vehicle/object and its blind zone is reduced.

## Backing up with equipment connected to the towbar

RAB and CTA are automatically deactivated when a trailer, bicycle holder or similar is connected to the trailer contact. If the connected equipment does not have an electrical connection, RAB and CTA must be deactivated manually via the button in the center display.

\* Option/accessory.

---

## 10.4.2. Activating and deactivating warning and auto-braking when backing up\*

The driver can choose to disable auto-braking with Rear Auto Brake (RAB) and Cross Traffic Alert (CTA)\*. The warning signal can be deactivated separately.

### Warning signal



Activate or deactivate warning signals using this button in Park Assist Camera view.

### Auto-brake



Activate or deactivate automatic braking using this button in Park Assist Camera view.

- Illuminated button – the function is activated.
- Extinguished button – the function is deactivated.

The functions are automatically activated each time the vehicle is started.

\* Option/accessory.

---

## 10.5. Rear Collision Warning

---

## 10.5.1. Rear Collision Warning\*

The Rear Collision Warning<sup>[1]</sup> (RCW) function can help the driver avoid rear-end collisions from vehicles approaching from behind.

If, at a speed below 30 km/h (20 mph), the function detects that the vehicle is in danger of being hit from behind, the seat belt tensioners may tension the front seat belts. The Whiplash Protection System will also be activated in a collision.

Immediately before a collision from behind, the function may also activate the brakes in order to reduce the forward acceleration of the vehicle during the collision. However, the brakes will only be applied if your vehicle is stationary. The brakes will be immediately released if the accelerator pedal is depressed.

The function is automatically activated each time the engine is started.

### Warning

- The function is supplementary driver support intended to facilitate driving and help make it safer – it cannot handle all situations in all traffic, weather and road conditions.
- The driver is advised to read all sections in the Owner's Manual about this function to learn of its limitations, which the driver must be aware of before using the function.
- Driver support functions are not a substitute for the driver's attention and judgment. The driver is always responsible for ensuring the vehicle is driven in a safe manner, at the appropriate speed, with an appropriate distance to other vehicles, and in accordance with current traffic rules and regulations.

\* Option/accessory.

<sup>[1]</sup> This function is not available on all markets.

---

## 10.5.2. Rear Collision Warning\* limitations

In some situations, it may be difficult for Rear Collision Warning (RCW)<sup>[1]</sup> to warn the driver of a collision risk.

This may be the case if:

- the vehicle approaching from the rear is detected at a late stage
- the vehicle approaching from the rear changes lanes at a late stage
- a trailer, bicycle holder or similar is connected to the vehicle's electrical system - the function will then be automatically deactivated.

### Note

In certain markets RCW does **not** warn with the direction indicators due to local traffic regulations – in such cases, that part of the function is deactivated.

 **Note**

The function uses the vehicle's radar sensors, which have certain general limitations.

\* Option/accessory.

<sup>[1]</sup> Warning of collision from the rear.

---

## 10.6. Connected Safety

---

### 10.6.1. Connected Safety

Connected Safety<sup>[1]</sup> communicates information between your vehicle and other vehicles via a cloud service<sup>[2]</sup>. The function is designed to notify the driver of any hazardous road conditions ahead.

The function can notify the driver if another vehicle further down the road has activated its hazard warning flashers or detected slippery road conditions. You will also be notified if your own vehicle detects slippery road conditions.

Connected Safety can assist the driver with the following:

- Hazard warning flashers alert
- Slippery road alerts

Connected Safety communication between vehicles only works for vehicles equipped with this function. Connected Safety also needs to be approved via **Volvo privacy settings**.

#### Hazard warning flashers alert

If your vehicle's hazard warning flashers are activated, information on this can be sent to other vehicles approaching your location.



When your vehicle approaches a vehicle with its hazard warning flashers on, this symbol will appear in the instrument panel.

#### Slippery road alerts



If your vehicle detects reduced friction between the tires and the road, this symbol will be shown in the instrument panel. This information can then be forwarded to vehicles approaching your vehicle's location.



If your vehicle receives information about slippery conditions from another vehicle, this symbol will be shown in the instrument panel.

 **Warning**

- The function is supplementary driver support intended to facilitate driving and help make it safer – it cannot handle all situations in all traffic, weather and road conditions.
- The driver is advised to read all sections in the Owner's Manual about this function to learn of its limitations, which the driver must be aware of before using the function.
- Driver support functions are not a substitute for the driver's attention and judgment. The driver is always responsible for ensuring the vehicle is driven in a safe manner, at the appropriate speed, with an appropriate distance to other vehicles, and in accordance with current traffic rules and regulations.

<sup>[1]</sup> Not available in all markets.

<sup>[2]</sup> There may be a charge for transmitting data over the cloud service, depending on your service plan.

---

## 10.6.2. Activating and deactivating Connected Safety

For Connected Safety to be able to share information about road conditions with other drivers, the function must be approved in **Volvo privacy**.

- 1 Tap  in the center display.
- 2 Press **Privacy** or **Profiles**. The menu path depends on whether or not you are logged in to a Google account.
- 3 Then tap **Privacy settings** and approve Connected Safety.

Even when your vehicle is not connected to the Internet, you will still be notified if the system in your own vehicle detects slippery road conditions. For Connected Safety to function at full capacity, your vehicle needs to be connected to the Internet.

---

## 10.6.3. Connected Safety limitations

Information on vehicles with activated hazard warning flashers or which have detected slippery road conditions is not always communicated between all vehicles in the affected area.

This may be the case if:

- No or insufficient Internet connection.
- The maneuvers (steering wheel movements, acceleration or braking) made by the vehicles on slippery surfaces are too weak for friction between the tires and road to be detected.



- Vehicles that have detected slippery road conditions, or have turned on their hazard warning flashers, do not have the function active.
- Vehicles that have detected slippery road conditions or activated hazard warning flashers are not equipped with the function.
- Insufficient GPS/satellite navigation may prevent warnings.
- Slippery road conditions were detected or hazard warning flashers were activated on a road that is not registered in the Volvo Cars database.
- Connected Safety is not developed on all markets and does not cover all areas. Consult a Volvo retailer for more information on covered areas.

 **Warning**

- In certain situations, the function may give false warnings of slippery road conditions.
- The function cannot always detect other vehicles with activated hazard warning factors or detect all stretches of road with slippery conditions.

## 10.7. Collision Assistance

### 10.7.1. Assistance during collision risks<sup>[1]</sup>

Assistance during collision risks<sup>[2]</sup> can help the driver avoid or mitigate a collision by providing warnings, automatic braking and steering assistance.



Collision warning audible signal and symbol

- 1 Audible signal at risk of collision
- 2 Collision warning symbol
- 3 Camera and radar unit distance monitoring

Normally, the occupants of the vehicle will not be aware of the function except when the system intervenes when a collision is imminent.

can help the driver avoid a collision when e.g. driving in stop-and-go traffic, when changes in the traffic ahead and driver distraction could lead to an incident. The function then activates a brief, forceful braking in an attempt to stop your vehicle immediately behind the vehicle or object ahead.

The function is always active and cannot be switched off.

## Sub-functions

Assistance during collision risks can, if necessary, provide the following:

- Collision warning
- Assisted braking
- Auto-hold brakes
- Steering assistance

### Step 1 – Collision warning

In the event of a collision with a pedestrian, cyclist, larger animal or vehicle, this is brought to the driver's attention with a warning symbol as well as sound and brake pulse warnings. During hard braking or if the accelerator pedal is pressed, the brake pedal pulsation warning will not be given. The intensity of the brake pedal pulsations varies according to the vehicle's speed.

### Step 2 – Assisted braking

If the system determines that the pressure the driver is exerting on the brake pedal is insufficient to prevent the collision, assisted braking will increase pressure.

### Step 3 – Auto-hold brakes

If the driver has not taken evasive action and a collision is imminent, the automatic braking function will be triggered. This occurs whether or not the driver is pressing the brake pedal. Full braking force will be applied to reduce the speed at impact or reduced braking effect will be applied if this is sufficient to avoid the collision.

The seat belt tensioner may be activated when the automatic braking function is triggered.

The function is designed to be activated as late as possible to help avoid unnecessary intervention. Automatic braking will only be applied after or during a collision warning.

If braking assistance has prevented a collision, the vehicle will be kept at a standstill until the driver takes action. If the vehicle has slowed to avoid colliding with a slower-moving vehicle ahead your speed will be reduced to that vehicle's speed.

Auto-braking can always be cancelled if the driver presses hard on the accelerator pedal.

When the function is activated and braking, the brake light will illuminate. A message will be displayed in the instrument panel saying that the function is or has been active.

#### **Warning**

The function must not be used to change how the driver operates the vehicle. The driver must not only rely on the function to brake the vehicle.

## Steering assistance

The function can help the driver reduce the risk of the vehicle leaving its lane unintentionally or colliding with another vehicle or obstacle by actively steering the vehicle back into its lane or swerving. Steering assistance is not provided sequentially, but instead can occur regardless of when the other steps take place.

After the system has automatically intervened, this text message will appear in the instrument panel.

### Note

It is always the driver who must decide how much the vehicle should be in control – the vehicle can never take command.

### Warning

- The function is supplementary driver support intended to facilitate driving and help make it safer – it cannot handle all situations in all traffic, weather and road conditions.
- The driver is advised to read all sections in the Owner's Manual about this function to learn of its limitations, which the driver must be aware of before using the function.
- Driver support functions are not a substitute for the driver's attention and judgment. The driver is always responsible for ensuring the vehicle is driven in a safe manner, at the appropriate speed, with an appropriate distance to other vehicles, and in accordance with current traffic rules and regulations.

<sup>[1]</sup> This function is not available on all markets.

<sup>[2]</sup> Collision Avoidance

---

## 10.7.2. Detecting obstacles with assistance during collision risks

Assistance during collision risks<sup>[1]</sup> can help the driver detect different types of obstacles.

The function can detect pedestrians, cyclists or vehicles that are stationary or ahead and moving in the same direction as your vehicle. The function can also detect pedestrians, cyclists or large animals crossing the road in front of your vehicle.

### Warning

Warnings and brake interventions may occur late or not at all. The driver is always responsible for ensuring that the vehicle is driven correctly and with a safety distance suitable for the speed.

## Vehicles

For the function to be able to detect a vehicle in the dark, its headlights and taillights must be on and clearly visible.

## Cyclists



Examples of what the function would interpret to be a cyclist: clear body and bicycle shapes.

For good performance, the system's camera and radar units for cyclist detection need the clearest possible information about the contours of the bicycle and of the cyclist's head, arm, shoulders, legs, torso and lower body in combination with normal human movements.

If large portions of the cyclist's body or the bicycle itself are not visible to the function's camera, it will not be able to detect a cyclist.

The system can only detect adult cyclists riding on bicycles intended for adults.

### **Warning**

The function is supplementary driver support, but it cannot detect all cyclists in all situations and, for example, cannot see:

- partially obscured cyclists.
- cyclists if the contrast to the cyclist's background is poor.
- cyclists in clothing that hides their body contour.
- bikes loaded with large objects.

## Pedestrians

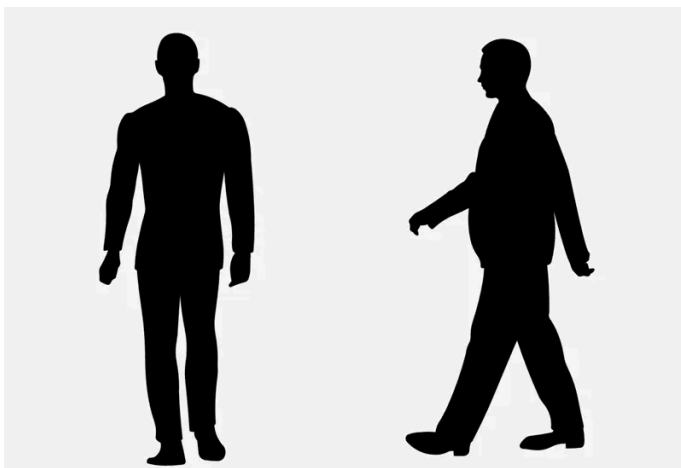

Examples of what the function considers to be a pedestrian: clear body contours.

For good performance, the system's camera and radar units for pedestrian detection need the clearest possible information about the contours of the pedestrian's head, arm, shoulders, legs, torso and lower body in combination with normal human movements.

In order to detect a pedestrian, there must be a contrast to the background, which could depend on clothing, weather conditions, etc. If there is little contrast, the person may be detected late or not at all, which may result in a delayed reaction from the system or no reaction at all.

The function can detect pedestrians even in dark conditions if they are illuminated by the vehicle's headlights.

 **Warning**

The function is supplementary driver support, but it cannot detect all pedestrians in all situations and, for example, cannot see:

- partially obscured pedestrians, people in clothing that hides their body contour or pedestrians shorter than 80 cm (32 tum).
- pedestrians if the contrast to the pedestrian's background is poor.
- pedestrians who are carrying large objects.

## Large animals

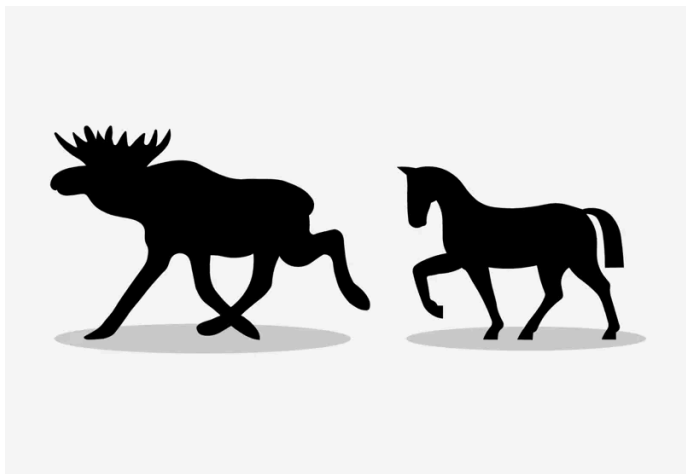

Examples of what the function would interpret as a large animal: stationary or moving slowly and with clear body contours.

For good performance, the system's function for detecting large animals (e.g. moose, horses, etc.) needs the clearest possible information about body contours. This entails being able to detect the animal straight from the side in combination with normal movements for that animal.

If parts of the animal's body are not visible to the function's camera, the system will not be able to detect the animal.

The function can detect large animals even in dark conditions if they are illuminated by the vehicle's headlights.

 **Warning**

The function is supplementary driver support, but it cannot detect all large animals in all situations and, for example, cannot see:

- partially obscured larger animals.
- larger animals seen from the front or from behind.
- running or fast moving larger animals.
- larger animals if the contrast to the animal's background is poor.
- smaller animals such as cats and dogs.

Warnings and brake interventions may occur late or not at all. The driver is always responsible for ensuring that the vehicle is driven correctly and with a safety distance suitable for the speed.

<sup>[1]</sup> Collision Avoidance

## 10.7.3. Opportunity to reduce speed with assistance during collision risks

Assistance during collision risks<sup>[1]</sup> can help prevent a collision or lower the vehicle's speed at the point of impact.

If the difference in speed between your vehicle and the obstacle is greater than the speeds specified below, the automatic brake function cannot prevent a collision, but it can help mitigate its effects.

### Vehicles

Braking assistance can help prevent a collision with a vehicle ahead by reducing your vehicle's speed by up to 60 km/h (37 mph).

### Cyclists

Braking assistance can help prevent a collision with a cyclist ahead by reducing your vehicle's speed by up to 50 km/h (30 mph).

### Pedestrians

Braking assistance can help prevent a collision with a pedestrian ahead by reducing your vehicle's speed by up to 45 km/h (28 mph).

### Large animals

If there is a risk of colliding with a large animal, braking assistance can help reduce your vehicle's speed by up to 15 km/h (9 mph).





The braking function for large animals is primarily intended to mitigate the force of a collision at higher speeds. Braking is most effective at speeds above 70 km/h (43 mph) and less effective at lower speeds.

<sup>[1]</sup> Collision Avoidance

---

## 10.7.4. Symbols and messages for assistance during collision risks

A number of symbols and messages related to assistance during collision risks<sup>[1]</sup> may be displayed in the instrument panel. Several examples are provided below.

Symbol	Message	Meaning
	Automatic intervention Collision Avoidance	When the function is activated, a message will appear to alert the driver.
	Collision Avoidance system unavailable	The system is temporarily malfunctioning or working with reduced performance.
	Collision Avoidance Reduced functionality Service required	The system is not functioning as intended. Contact workshop.
	Windscreen sensor blocked See Owner's manual	The camera's ability to detect the lane in front of the vehicle is reduced.

A text message can be erased by briefly pressing the  button in the center of the right-side steering wheel keypad.

If the message persists, contact a workshop. An authorized Volvo workshop is recommended.

<sup>[1]</sup> Collision Avoidance

## 10.7.5. Assistance during collision risks limitations

Assistance during collision risks <sup>[1]</sup> has certain limitations that a driver needs to be aware of.

### Braking assistance limitations

#### Extra equipment

Hanging objects, such as a flag or streamer to signal an over-sized load, or accessories such as auxiliary lights or front protective grids that extend beyond the height of the vehicle's hood, may obstruct the camera or radar unit.

#### Slippery road conditions

The extended braking distance on slippery roads may reduce the function's capacity to help avoid a collision. In these types of situations, the Anti-lock Braking System and Electronic Stability Control (ESC<sup>[2]</sup>) are designed for optimal braking power with maintained stability.

#### Low speed

The function is not activated at very low speeds under 4 km/h (3 mph). The system will therefore not intervene in situations in which your vehicle is approaching another vehicle very slowly, such as when parking.

#### Active driver

The driver's commands are always prioritized. In situations in which the driver is clearly steering and applying the accelerator pedal, the function will not intervene, even if a collision is unavoidable. An active and aware driving style may therefore delay collision warnings and intervention in order to minimize unnecessary warnings.

### Steering assistance limitations



The function may have limited functionality in certain situations and not intervene, e.g.:

- for smaller vehicles such as motorcycles
- if more than half of your vehicle has moved into the adjacent lane
- on roads/lanes with indistinct or no side lane markings
- outside the speed range 60-140 km/h (37-87 mph)
- when speed-dependent power steering wheel resistance is working at reduced power – e.g. during cooling due to overheating.

Functionality may also be reduced in other situations, such as:

- road work
- winter driving conditions
- narrow roads
- poor road surfaces
- a very sporty driving style
- bad weather with reduced visibility.

In these demanding driving conditions, the function may not be able to properly assist the driver.

## Important warnings

### **Warning**

The driver support system only issues a warning for obstacles detected by its radar sensor – thus, a warning may come after a delay or not at all.

- Never wait for a warning or assistance. Apply the brakes when necessary.

### **Warning**

- Automatic braking can prevent a collision or reduce collision speed, but to ensure full brake performance the driver should always depress the brake pedal – even when the vehicle brakes automatically.
- The warning and steering assistance are only activated if there is a high risk of collision – you must therefore never wait for the collision warning or the function to intervene.
- The function does not activate automatic braking intervention during heavy acceleration.

 **Warning**

- Warnings and brake interventions can be triggered late or not at all if the traffic situation or external influences prevent the camera and radar units from properly detecting pedestrians, cyclists, large animals or vehicles ahead of the vehicle.
- To be able to detect vehicles at night, its front and rear lights must work and illuminate clearly.
- Warnings for stationary and slow-moving vehicles, as well as large animals, can be disengaged due to darkness or poor visibility.
- Warnings and brake interventions for pedestrians and cyclists are disengaged at vehicle speeds over 80 km/h (50 mph).
- The system can provide effective warnings and brake intervention if the relative speed is lower than 50 km/h (30 mph).
- For stationary or slow-moving vehicles, warnings and brake interventions are effective at vehicle speeds of up to 70 km/h (43 mph).
- Speed reduction for large animals is less than 15 km/h (9 mph) and can be achieved at vehicle speeds over 70 km/h (43 mph). At lower speeds, the warning and brake intervention for large animals is less effective.
- Do not place, affix or mount anything on the inside or outside of the windshield, or in front of or around the camera – this could disrupt camera-based functions.
- Objects, snow, ice or dirt in the area of the camera and radar units can reduce the function, disengage it completely or give an improper function response.

 **Note**

The function uses the vehicle's camera and radar sensor, which has certain general limitations.

 **Important**

Only a workshop may perform maintenance on driver support components – an authorized Volvo workshop is recommended.

<sup>[1]</sup> Collision Avoidance

<sup>[2]</sup> Electronic Stability Control

---

## 10.7.6. Assistance during collision risks in crossing traffic

Assistance during collision risks <sup>[1]</sup> can assist the driver when turning in the path of an oncoming vehicle in an intersection.

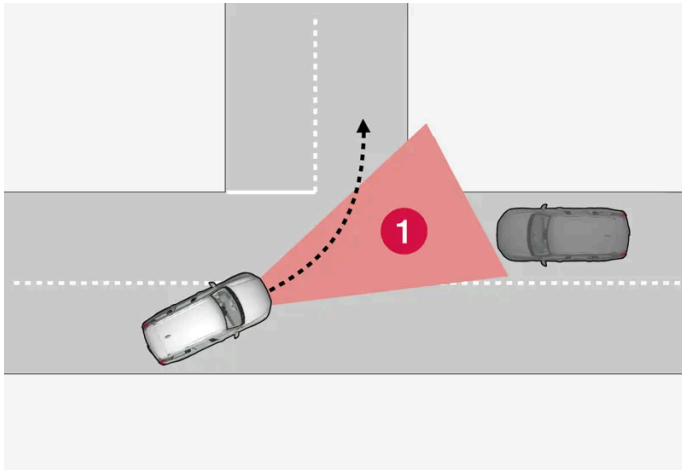

**1** Sector in which the function can detect an oncoming vehicle in crossing traffic.

In order for the function to detect an oncoming vehicle in situations where there is a risk of a collision, that vehicle must be within the sector in which the function can analyze the situation.

The following conditions must also be met:

- your vehicle's speed must be at least 4 km/h (3 mph).
- your vehicle must be making a left turn.
- the oncoming vehicle's headlights must be on.

The function may be unable to assist the driver if, for example:

- the road is slippery and Electronic Stability Control <sup>[2]</sup> is intervening.
- the approaching vehicle is detected at a late stage.
- the oncoming vehicle is partially obstructed by another vehicle or object.
- the oncoming vehicle's headlights are off.
- the oncoming vehicle is moving erratically and e.g. suddenly changes lanes at a late stage.

 **Warning**

Warnings and steering assistance due to an imminent collision with an oncoming vehicle always come very late.

 **Note**

The function uses the vehicle's camera and radar sensor, which has certain general limitations.

<sup>[1]</sup> Collision Avoidance

<sup>[2]</sup> Electronic Stability Control (ESC)

## 10.7.7. Assistance during collision risks in oncoming traffic

Assistance during collision risks <sup>[1]</sup> can help the driver by providing steering assistance to help prevent collisions with vehicles in oncoming lanes. The function can also reduce your vehicle's speed when an oncoming vehicle is approaching in your lane to attempt to mitigate the force of the impact.

### Oncoming vehicles in your own lane

If an oncoming vehicle veers into your lane and a collision is unavoidable, the function can help reduce your vehicle's speed to attempt to mitigate the force of the collision.

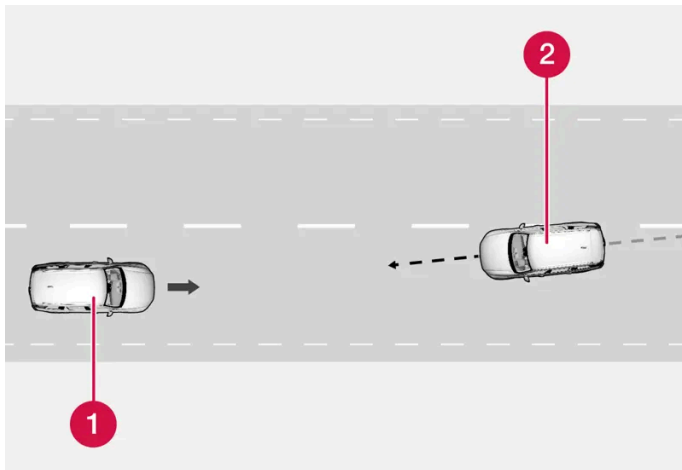

- 1 Own vehicle
- 2 Oncoming vehicles

The following criteria must be met for the function to work:

- your vehicle's speed must be above 4 km/h (3 mph)
- the road must be straight
- your lane must have clear side lane markings
- your vehicle must be positioned straight in your lane
- the oncoming vehicle must be positioned within your vehicle's lane markings
- the oncoming vehicle's headlights must be on
- the function can only handle “front-to-front” collisions
- the function can only detect vehicles with four wheels.

### When the vehicle veers into oncoming traffic

This function can help assist a distracted driver who has not noticed that the vehicle is veering into oncoming traffic.

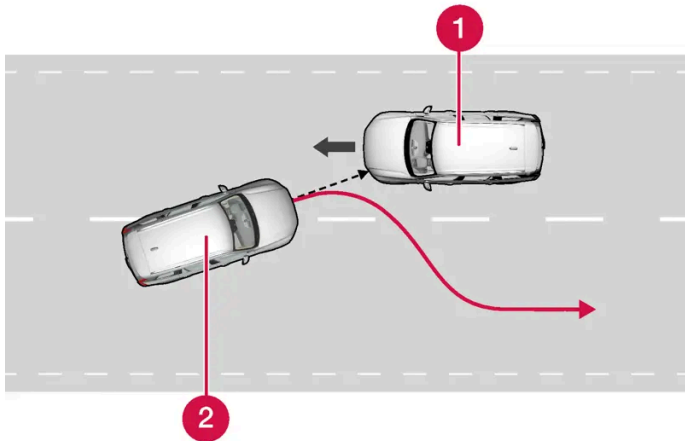

The function provides assistance by swerving your vehicle back into your own lane.

- 1 Oncoming vehicles
- 2 Own vehicle

The function is active at speeds between 60-140 km/h (37-87 mph) on roads with clearly visible traffic lane markings/lines.

If your vehicle is starting to veer from your own lane and a vehicle is approaching from the opposite direction, this function can help the driver steer the vehicle back into its own lane.

However, the function will **not** provide steering assistance if the turn signal is used. The function will also not be activated if it detects that the driver is actively operating the vehicle.

When the function is intervening, a symbol and a message will appear in the instrument panel and an audible signal will sound.

#### **Warning**

Warnings and steering assistance due to an imminent collision with an oncoming vehicle always come very late.

#### **Note**

The function uses the vehicle's camera and radar sensor, which has certain general limitations.

<sup>[1]</sup> Collision Avoidance

## 10.7.8. Assistance during collision risks with vehicles in your blind spot\*

If you become distracted and do not notice your vehicle starting to veer out of the lane while another vehicle is approaching from behind or is in your vehicle's blind spot, assistance during collision risks<sup>[1]</sup> can help

provide assistance.

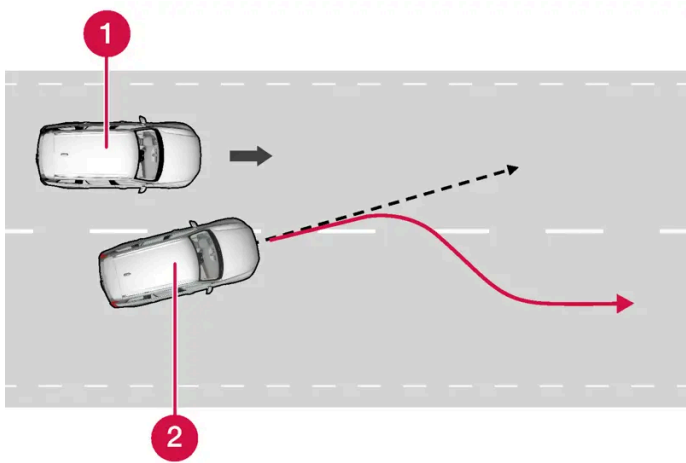

The function provides assistance by steering your vehicle back into your own lane.

- 1 Another vehicle in blind spot zone
- 2 Own vehicle

Even if the driver intentionally changes lanes using a turn signal without noticing another vehicle approaching, the function can provide assistance.

The function is active at speeds between 60-140 km/h (37-87 mph) on roads with clearly visible traffic lane markings/lines.

The lights in the door mirrors will flash and steering assistance will be provided. An audible signal will also sound.

When the function is intervening, a message is displayed in the instrument panel.

 **Warning**

Warnings and steering assistance due to an imminent collision always come very late.

 **Note**

The function uses the vehicle's camera and radar sensor, which has certain general limitations.

\* Option/accessory.

<sup>[1]</sup> Collision Avoidance

## 10.7.9. Assistance during risk of run-off

Assistance during collision risks <sup>[1]</sup> can help the driver and reduce the risk of the vehicle inadvertently running off the road by actively steering the vehicle back onto the road.

This function has two levels for intervention:

The content of this manual represents the status of the user manual at the time of printing and may not be completely valid in future instances. For more information refer to the first page for the complete disclaimer note.

- Steering assistance only
- Steering assistance with braking

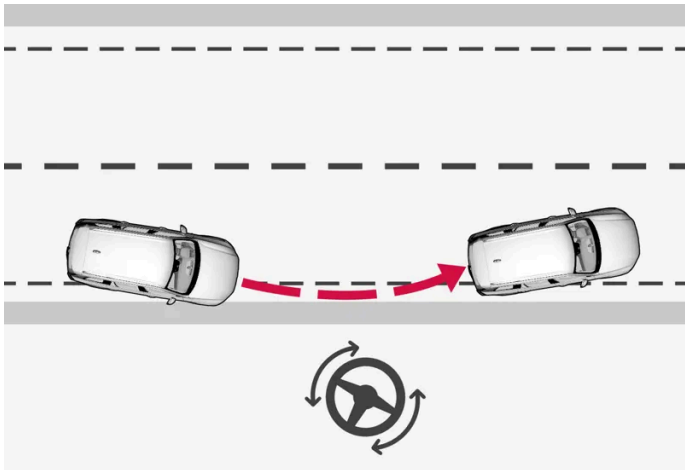

Intervention with steering assistance

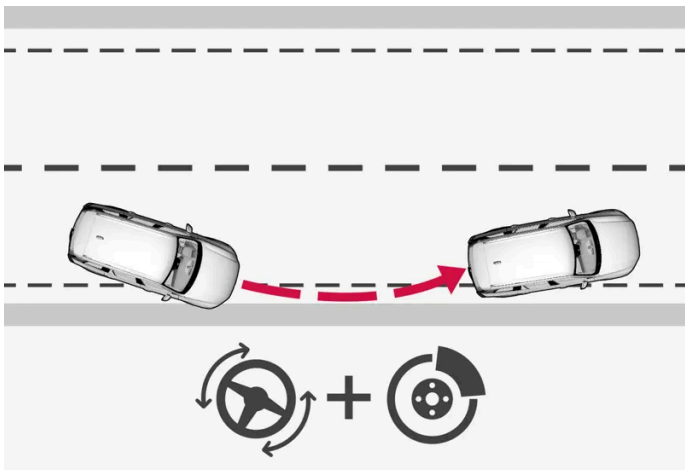

Intervention with steering assistance and braking

Braking intervention assists in situations where steering assistance alone is not sufficient. Braking force is automatically adapted according to the situation at the moment the vehicle begins to run off the road.

The function is active at speeds between 65-140 km/h (40-87 mph) on roads with clearly visible traffic lane markings/lines.

The vehicle's camera unit monitors the edges of the road and the painted side marker lines. If the vehicle is about to cross the edge of the road, the function may attempt to steer the vehicle back onto the road. If this is not sufficient to keep the vehicle on the road, the brakes will also be applied.

However, the function will not provide either steering assistance or braking if a direction indicator is used. The function will also not be activated if it detects that the driver is actively operating the vehicle.

When the function is intervening, a message is displayed in the instrument panel.

 **Warning**

Warnings and steering assistance due to an imminent collision with an oncoming vehicle always come very late.

**Note**

The function uses the vehicle's camera and radar sensor, which has certain general limitations.

[1] Collision Avoidance

---

## 10.8. Driver Alert Control

---

### 10.8.1. Driver Alert

The Driver Alert function is designed to help alert the driver to erratic behavior, e.g. if the driver is distracted or showing signs of fatigue.

The objective of the function is to detect slowly deteriorating driving behavior and is primarily intended to be used on major roads. The function is not intended for use in city traffic.

DAC is activated when the vehicle's speed exceeds 65 km/h (40 mph) and remains active as long as speeds are above 60 km/h (37 mph).

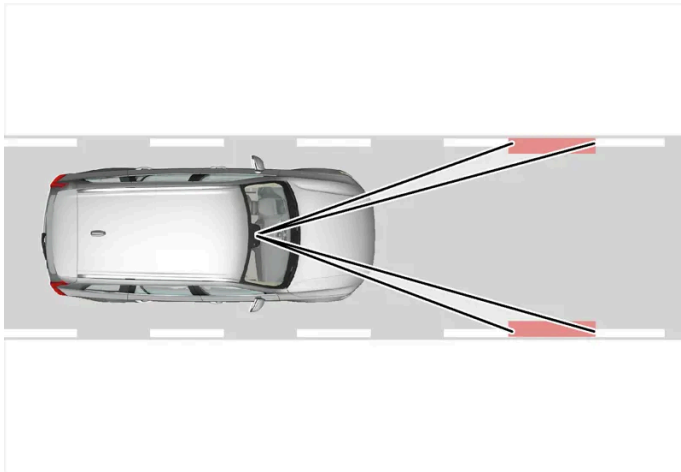

Driver Alert detects the vehicle's position in the traffic lane.



A camera monitors the traffic lane's marker lines and compares the direction of the road with the driver's movements of the steering wheel.

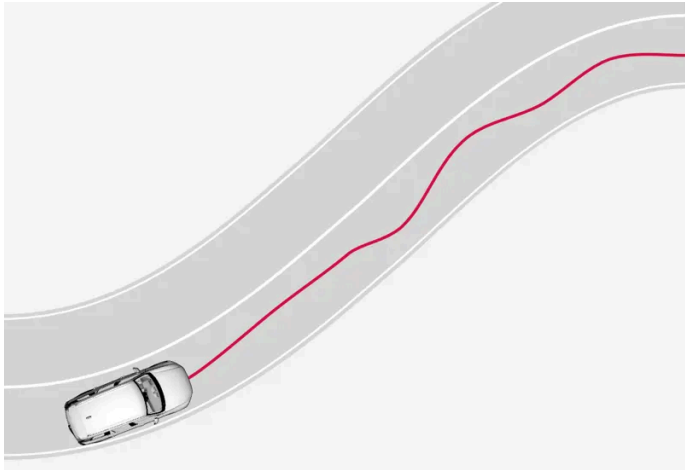

The vehicle is moving erratically in the lane.



If driving behavior becomes considerably erratic, the driver will be alerted by this symbol in the instrument panel, an audible signal and the message **Time for a break Driver Alert**.

The warning will be repeated after a short time if driving behavior does not improve.

 **Warning**

Driver Alert must not be used to extend a period of driving. The driver should plan in breaks at regular intervals and make sure they are well rested.

 **Warning**

An alarm from Driver Alert should be taken very seriously since a sleepy driver is often not aware of their own condition.

If the alarm sounds or you feel fatigued:

- Stop the vehicle safely as soon as possible and rest.

Studies have shown that it is just as dangerous to drive while tired as it is to drive under the influence of alcohol or other stimulants.

 **Warning**

- The function is supplementary driver support intended to facilitate driving and help make it safer – it cannot handle all situations in all traffic, weather and road conditions.
- The driver is advised to read all sections in the Owner's Manual about this function to learn of its limitations, which the driver must be aware of before using the function.
- Driver support functions are not a substitute for the driver's attention and judgment. The driver is always responsible for ensuring the vehicle is driven in a safe manner, at the appropriate speed, with an appropriate distance to other vehicles, and in accordance with current traffic rules and regulations.

---

## 10.8.2. Driver Alert limitations

Driver Alert functionality may be reduced in certain situations.

In certain situations, the system may provide a warning even if it has not detected a change in driving behavior, e.g.:

- in strong crosswinds
- on grooved road surfaces.

### **Warning**

In certain cases, driving behavior might not be affected despite the driver's fatigue – when using the Pilot Assist\* function – resulting in the driver not getting a warning from Driver Alert.

### **Note**

The function uses the vehicle's camera and radar sensor, which has certain general limitations.

\* Option/accessory.

---

## 10.9. Lane Keeping Aid

### 10.9.1. Lane Keeping Aid

Lane Keeping Aid (LKA<sup>[1]</sup>) is designed to actively steer the vehicle on freeways, highways and other major roads to help the driver reduce the risk of the vehicle unintentionally veering out of the lane.

Lane Keeping Aid steers the vehicle back into the lane and/or alerts the driver using vibrations in the steering wheel.

Lane Keeping Aid is active at speeds between 65–200 km/h (40–125 mph) on roads with clearly visible traffic lane marker lines.

On narrow roads, the function may be unavailable and go into standby mode. The function will become available again when the road becomes sufficiently wide.

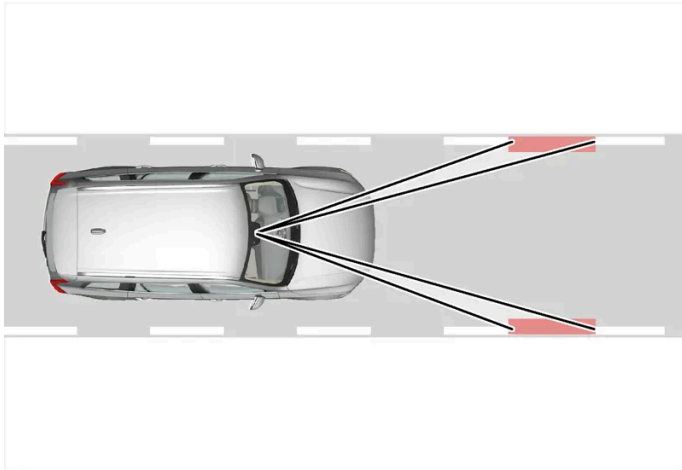

A camera monitors the road/traffic lane's marker lines.

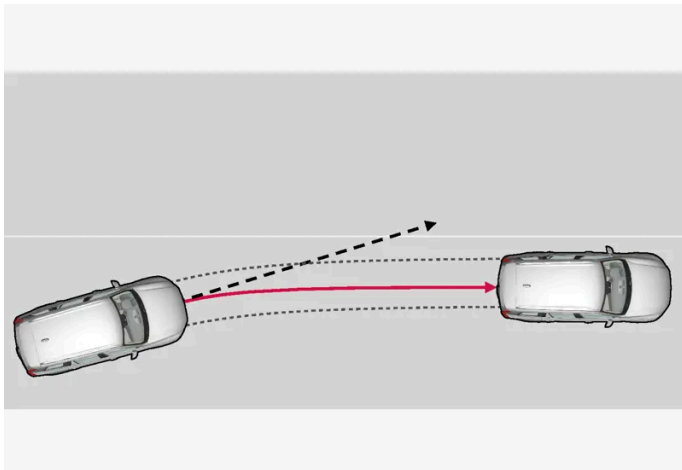

Lane Keeping Aid steers the vehicle back into its lane.

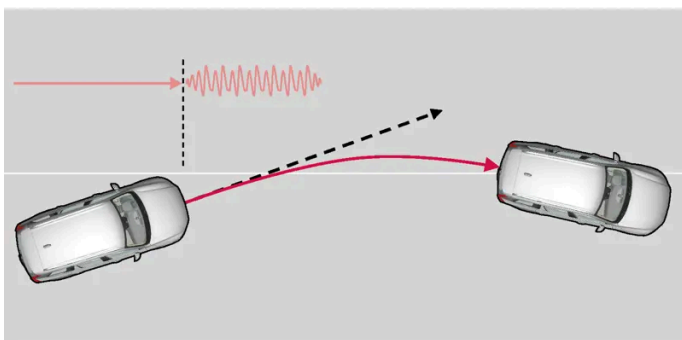

Lane Keeping Aid alerts the driver using vibrations in the steering wheel.

Lane Keeping Aid functions as follows:

- When the vehicle approaches a lane marker line, the function will actively steer the vehicle back into the lane using light pressure on the steering wheel.
- If the vehicle is about to move over a lane marker line, the driver will be alerted by vibrations in the steering wheel.

**The content of this manual represents the status of the user manual at the time of printing and may not be completely valid in future instances. For more information refer to the first page for the complete disclaimer note.**

**Note**

When the direction indicators/turn signals are activated, the Lane Keeping Aid does not provide any warning or intervene with steering.

**Warning**

- The function is supplementary driver support intended to facilitate driving and help make it safer – it cannot handle all situations in all traffic, weather and road conditions.
- The driver is advised to read all sections in the Owner's Manual about this function to learn of its limitations, which the driver must be aware of before using the function.
- Driver support functions are not a substitute for the driver's attention and judgment. The driver is always responsible for ensuring the vehicle is driven in a safe manner, at the appropriate speed, with an appropriate distance to other vehicles, and in accordance with current traffic rules and regulations.

## Lane Keeping Aid does not intervene

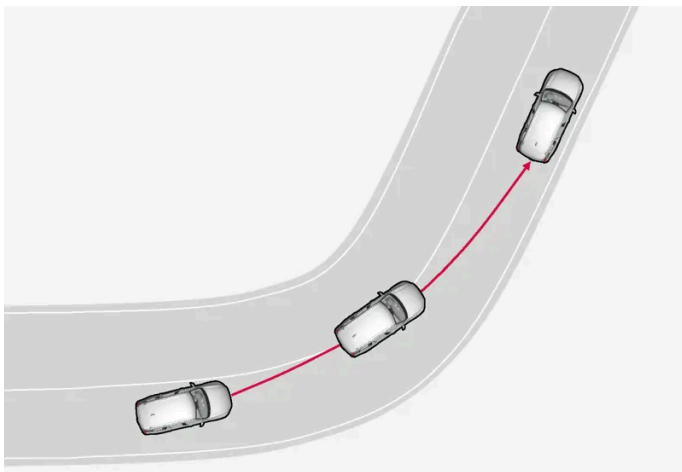

Lane Keeping Aid does not intervene in sharp inside curves.

In certain cases, such as when a turn signal is used or when "straightening out" an inside curve, Lane Keeping Aid will not provide steering assistance or alerts.

## Hands on the steering wheel

Steering assistance with Lane Keeping Aid only functions if the driver's hands are on the steering wheel, which the system continuously monitors.

If the driver's hands are not on the steering wheel, an audible signal will be given and a message will instruct the driver to actively steer the vehicle:

- **Apply steering Lane Keeping Aid**

If the driver does not follow the recommendations and begin actively steering the vehicle, a warning signal will sound until the driver begins steering the vehicle again.

## 10.9.2. Activating and deactivating Lane Keeping Aid

The Lane Keeping Aid (LKA<sup>[1]</sup>) function is optional – the driver can choose to have the function activated or deactivated. However, steering assistance for solid lines is always on.

Activate or deactivate the function under settings.

- 1 Tap  in the center display.
- 2 Tap **Driving** and activate your preferred function.

## 10.9.3. Differences between Pilot Assist\* and Lane Keeping Aid

Pilot Assist is a comfort function that can help keep the vehicle in its own lane and maintain the distance to the vehicle in front of you. Lane Keeping Aid<sup>[1]</sup> is a function that similarly helps in certain situations to reduce the risk of the vehicle unintentionally veering out of its lane.

### Pilot Assist



Pilot Assist can help you to steer your vehicle between the lane markings, as well as maintain a preset speed and distance to the vehicle ahead. The function can also use the lane marking lines to help the driver maintain a favorable position in the lane.

#### What does Pilot Assist do?

- Can help to keep the vehicle within its lane by assisting steering in some cases.
- Can help to maintain a preset speed or the distance to the vehicle ahead by means of acceleration and braking operations.

#### How do I know that Pilot Assist is on?

Symbols in the vehicle's instrument panel let you know when Pilot Assist is on.

	Adaptive Cruise Control is active. Pilot Assist is selected but not available. The conditions for the function are not met.
	Pilot Assist is active.

## Lane Keeping Aid

Lane Keeping Aid can provide steering assistance and/or a warning to the driver when the vehicle is about to leave its lane unintentionally. The function is active between 65-180 km/h (40-112 mph) on roads with clearly visible side markings.

### What does Lane Keeping Aid do?

- Lane Keeping Aid can provide the driver with steering assistance, steering the vehicle back into its lane and/or providing warnings using steering wheel vibration.

### How do I know that Lane Keeping Aid is on?

Symbols in the vehicle's instrument panel show the function status.



An extinguished symbol in the instrument panel means that the function is on but that the conditions for LKA have not been met.



White symbol in the instrument panel means that the conditions for LKA have been met and that the function is available.



An orange symbol in the instrument panel means that LKA is providing steering assistance back into the lane and/or giving a warning with vibration in the steering wheel.

### Warning

The driver is always responsible for ensuring that the vehicle is operated in a safe manner. The driver is advised to read all of the sections in the Owner's Manual about this function before using the function.

### Warning

- The function is supplementary driver support intended to facilitate driving and help make it safer – it cannot handle all situations in all traffic, weather and road conditions.
- The driver is advised to read all sections in the Owner's Manual about this function to learn of its limitations, which the driver must be aware of before using the function.
- Driver support functions are not a substitute for the driver's attention and judgment. The driver is always responsible for ensuring the vehicle is driven in a safe manner, at the appropriate speed, with an appropriate distance to other vehicles, and in accordance with current traffic rules and regulations.



\* Option/accessory.

<sup>[1]</sup> Lane Keeping Aid(LKA)

---

## 10.9.4. Lane Keeping Aid symbols and messages

A number of symbols and messages related to Lane Keeping Aid (LKA <sup>[1]</sup>) may be displayed in the instrument panel. Several examples are provided below.

Symbol	Message	Meaning
	Driver support system Reduced functionality Service required	The system is not functioning as intended. Contact a workshop <sup>[2]</sup> .
	Windscreen sensor blocked See Owner's manual	The camera's ability to detect the lane in front of the vehicle is reduced.
	Apply steering Lane Keeping Aid	Steering assistance is disabled when the driver's hands are not on the wheel. Follow the instructions and steer the vehicle.

A text message can be erased by briefly pressing the  button in the center of the right-side steering wheel keypad.

If the message persists, contact a workshop. An authorized Volvo workshop is recommended.

<sup>[1]</sup> Lane Keeping Aid

<sup>[2]</sup> An authorized Volvo workshop is recommended.

---

## 10.9.5. Lane Keeping Aid display

Lane Keeping Aid (LKA <sup>[1]</sup>) uses symbols in the instrument panel for various situations.



Some examples of symbols and descriptions of the situations in which they might appear are provided below.

**Available**

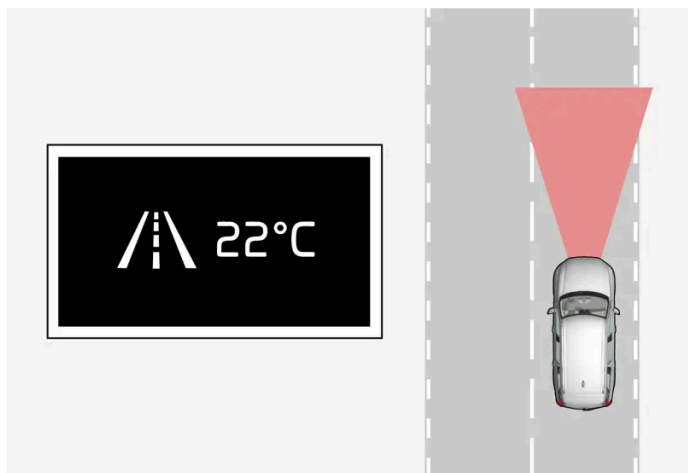

Available – the marker lines in the symbol are white.

Lane Keeping Aid is able to detect one or both of the traffic lane's side marker lines.

**Unavailable**



Unavailable – the marker lines in the symbol are extinguished.

Lane Keeping Aid is unable to detect the lane marker lines, the vehicle's speed is too low or the road is too narrow.

**Steering/warning indicator**

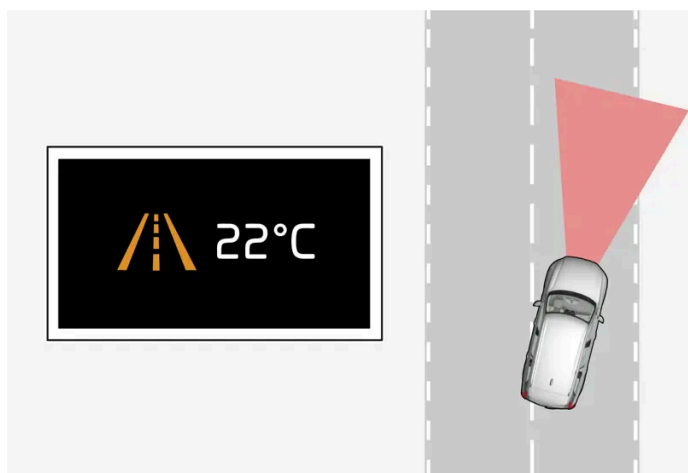



Steering/warning – the marker lines in the symbol are colored.

Indicates that the Lane Keeping Aid system is alerting the driver and/or attempting to steer the vehicle back into the lane.

<sup>[1]</sup> Lane Keeping Aid

---

## 10.9.6. Lane Keeping Aid limitations

In certain demanding driving conditions, Lane Keeping Aid (LKA<sup>[1]</sup>) may not be able to properly assist the driver. In these situations, it is recommended that the function be deactivated.

Examples of such situations include:

- road work
- winter driving conditions
- poor road surfaces
- a very sporty driving style
- bad weather with reduced visibility
- roads with indistinct or no lane markings
- sharp edges or lines other than the lane's side markings
- when speed-dependent power steering wheel resistance is working at reduced power – e.g. during cooling due to overheating.

The function cannot detect barriers, railings or similar obstacles at the side of the lane.

### Note

The function uses the vehicle's camera and radar sensor, which has certain general limitations.

<sup>[1]</sup> Lane Keeping Aid

---

## 10.10. Electronic Stability Control

---

### 10.10.1. Electronic Stability Control

The Electronic Stability Control (ESC <sup>[1]</sup>) function helps the driver avoid skidding and improves the vehicle's directional stability.



This symbol will be displayed in the instrument panel when the system is intervening.

When the system has intervened to apply the brakes, a pulsing sound may be heard and the vehicle may accelerate more slowly than expected when the accelerator pedal is depressed.

The system consists of the following sub-functions:

- Stability control <sup>[2]</sup>
- Spin control and active yaw control
- Engine drag control
- Trailer Stability Assist
- Roll Stability Control

#### **Warning**

- The function is supplementary driver support intended to facilitate driving and help make it safer – it cannot handle all situations in all traffic, weather and road conditions.
- The driver is advised to read all sections in the Owner's Manual about this function to learn of its limitations, which the driver must be aware of before using the function.
- Driver support functions are not a substitute for the driver's attention and judgment. The driver is always responsible for ensuring the vehicle is driven in a safe manner, at the appropriate speed, with an appropriate distance to other vehicles, and in accordance with current traffic rules and regulations.

## Stability control <sup>[2]</sup>

This function helps control the driving and braking force of each individual wheel in an attempt to stabilize the vehicle.

## Spin control and active yaw control

Spin control is active at all speeds and prevents the wheels from spinning while the vehicle is accelerating.

Active yaw control is active at low speeds and can brake the wheels that are spinning in order to increase power to the wheel on the opposite side.

## Engine drag control

Engine drag control (EDC <sup>[3]</sup>) can help prevent involuntary wheel locking, such as after engine braking on slippery roads. Inadvertent wheel lock while driving could impair the driver's ability to steer the vehicle.

## Trailer Stability Assist\* <sup>[4]</sup>

Trailer Stability Assist (TSA <sup>[5]</sup>) is designed to help stabilize a vehicle that is towing a trailer if the vehicle and trailer have begun to sway.

## Roll Stability Control

The content of this manual represents the status of the user manual at the time of printing and may not be completely valid in future instances. For more information refer to the first page for the complete disclaimer note.

This function helps reduce the risk of a rollover in the event of e.g. a sudden evasive maneuver or if the vehicle begins to skid. The system monitors the lateral angle at which the vehicle is leaning and registers any changes. Using this information, the system calculates the likelihood of a rollover. If there is an imminent risk of a rollover, Electronic Stability Control is activated, engine torque is reduced and brakes are applied to one or more of the wheels until the vehicle has regained stability.

 **Warning**

The vehicle's stability systems help improve vehicle safety but do not replace the driver's responsibility for operating the vehicle in a safe manner. Speed and driving style should always be adapted to the current road, traffic and weather conditions. Posted speed limits should always be respected.

[1] Electronic Stability Control

[2] Also called traction control.

[3] Engine Drag Control



\* Option/accessory.

[4] Trailer Stability Assist is included if the vehicle is equipped with a Volvo original towbar.

[5] Trailer Stability Assist

## 10.10.2. Electronic Stability Control symbols and messages

A number of symbols and messages related to Electronic Stability Control (ESC<sup>[1]</sup>) may be displayed in the instrument panel. Several examples are provided below.

Symbol	Message	Meaning
	Steady glow for approx. 2 seconds	System check when the engine is started.
	Flashing light	The system is actively operating.
–	Traction control temporarily off	Active yaw control has been temporarily reduced due to too-high brake system temperature. The function will be automatically reactivated when the brakes have cooled.
	ESC Service required	The system is not functioning properly. Stop the vehicle in a safe location. Check if the problem was temporary or if it persists by switching off the engine and then starting it again. If the problem persists, contact a workshop – an authorized Volvo workshop is recommended. The vehicle can be driven, but without ESC functionality.

A text message can be erased by briefly pressing the  button in the center of the right-side steering wheel keypad.

If the message persists, contact a workshop. An authorized Volvo workshop is recommended.

[1] Electronic Stability Control

## 10.11. Road Sign Information

---

## 10.11.1. Road Sign Information \*

The Road Sign Information function can help the driver observe speed-related road signs <sup>[1]</sup>.

The function is available in certain markets.



Examples of signs that can be detected <sup>[2]</sup>.

If the vehicle passes a speed limit sign, it will be displayed in the instrument panel.

There are also subfunctions for Road Sign Information that can alert the driver if the speed limit has been exceeded or if there are speed cameras nearby.

### Note

In certain markets, the Road Sign Information function is only available in combination with map data. Google Maps <sup>[3]</sup> settings may need to be changed.

### Note

In certain markets, the Road Sign Information function is only available in combination with map data.

### Warning

- The function is supplementary driver support intended to facilitate driving and help make it safer – it cannot handle all situations in all traffic, weather and road conditions.
- The driver is advised to read all sections in the Owner's Manual about this function to learn of its limitations, which the driver must be aware of before using the function.
- Driver support functions are not a substitute for the driver's attention and judgment. The driver is always responsible for ensuring the vehicle is driven in a safe manner, at the appropriate speed, with an appropriate distance to other vehicles, and in accordance with current traffic rules and regulations.

\* Option/accessory.

<sup>[1]</sup> An Internet connection is needed for Road Sign Information to work.

<sup>[2]</sup> Road signs differ according to market – the illustrations shown here are just some examples.

<sup>[3]</sup> Read more at Maps Privacy center.

---

## 10.11.2. Road Sign Information\* limitations

Road Sign Information functionality may be reduced in certain situations. The function is available in certain markets.

The function could have reduced functionality due to e.g.:

- faded road signs
- signs located in a curve in the road
- twisted or damaged signs
- signs positioned high above the road
- fully/partially obstructed or poorly positioned signs
- signs partially or fully covered by frost, snow and/or dirt
- digital map data with outdated, incorrect or missing speed information<sup>[1]</sup>
- no Internet connection
- approval for Google Maps<sup>[2]</sup>.

### Note

In certain markets, the Road Sign Information function is only available in combination with map data.

### Note

The function uses the vehicle's camera and radar sensor, which has certain general limitations.

\* Option/accessory.

<sup>[1]</sup> Map data and speed information is not available for all areas.

<sup>[2]</sup> Read more at Maps Privacy center.

---

## 10.11.3. Speed limit and speed camera warnings from Road Sign Information\*

There are subfunctions for Road Sign Information that can alert the driver if the speed limit has been exceeded or if there are speed cameras nearby<sup>[1]</sup>.

The content of this manual represents the status of the user manual at the time of printing and may not be completely valid in future instances. For more information refer to the first page for the complete disclaimer note.

The function is available in certain markets.

## Speed limit warning



The symbol<sup>[2]</sup> in the instrument panel will flash when the speed limit is exceeded by 5 km/h(3 mph).

The warning will be repeated once after about 30 seconds if the speed is not reduced.

After this, new warnings will only be provided if the speed is reduced by at least 5 km/h(3 mph) under the speed limit and then exceeded again. A new warning may also be provided if the vehicle enters a new speed limit zone.

The driver can be alerted if the vehicle is exceeding a detected speed limit and is approaching a speed camera.<sup>[1]</sup>

## Speed camera warning



Vehicles equipped with Road Sign Information and map data<sup>[1]</sup> can provide information about upcoming speed cameras in the instrument panel, provided that the navigation map for the relevant area contains information on speed cameras.

\* Option/accessory.

<sup>[1]</sup> Information on speed cameras on the navigation map is not available for all markets/areas.

<sup>[2]</sup> Road signs differ by market – the illustration shown here is just an example.

---

## 10.11.4. Activating and deactivating warnings from Road Sign Information \*

Road Sign Information can be deactivated on some markets.

The function is available in certain markets.

Activate or deactivate the function under settings.

- 1 Tap  in the center display.
- 2 Tap **Privacy settings** and select settings for Road Sign Information.

\* Option/accessory.

## 10.11.5. Road Sign Information\* display

Road Sign Information displays road signs in different ways depending on the sign and situation. The following illustrations are examples.

The function is available in certain markets.



Example <sup>[1]</sup> of registered speed information.

When the function has registered a speed limit sign, the instrument panel will display the sign as a symbol.

If the vehicle is equipped with map data\*, speed-related information will also be retrieved from map data, which means that the instrument panel can display or change information about speed limits even if the vehicle has not passed a speed-related sign.

### Signs for "School" and "Children playing"



The instrument panel can display signs for "School" or "Children playing" if this data is available.

\* Option/accessory.

<sup>[1]</sup> Road signs differ according to market – the illustrations shown here are just examples.

---

## 10.12. Parking functions

---

### 10.12.1. Parking Assist

---



## 10.12.1.1. Park Assist \*

The Park Assist function uses sensors to help the driver when maneuvering in tight spaces by indicating distances to obstacles using audible signals and graphics in the center display.

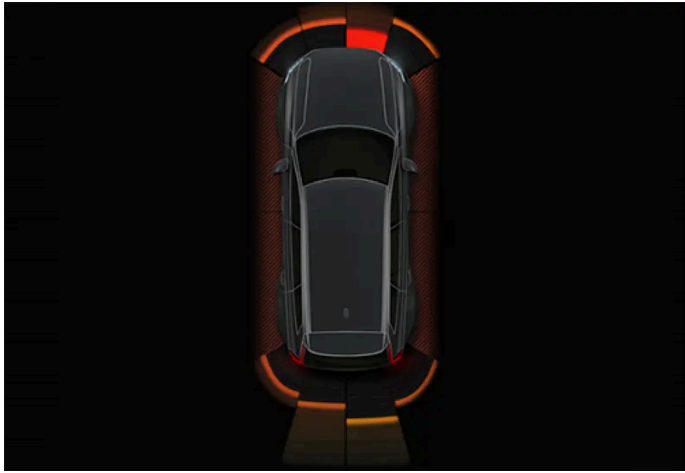

Example of display view showing obstacle zones and sensor sectors.

The center display shows an overview of the vehicle in relation to objects that have been detected.

The marked sector indicates where the obstacle is located. The closer the vehicle symbol is to a marked sector forward/rearward, the closer the detected obstacle is to your vehicle.

The side sectors change color as the distance between the vehicle and an object decreases.

The audible signals will also speed up the closer the obstacle is to the vehicle. The volume of the audio system will be automatically lowered.

Audible signals for obstacles in front and to the sides of the vehicle are active when the vehicle is moving but will cease after the vehicle has been stationary for approx. 2 seconds. Audible signals for obstacles behind the vehicle will remain active even when the vehicle is stationary.

If a detected obstacle is within approx. 30 cm (1 foot) from the front or rear of the vehicle, the tone will become constant and the active sensor field closest to the vehicle symbol will be filled in.

At distances within approx. 25 cm (0.8 foot) from an obstacle to the sides of the vehicle, a rapid pulsing signal will be given and the active sector fields will change color from orange to red.

The volume of the Park Assist audible signals can be adjusted while the signal is being given using the >|| knob or in Park Assist settings.

### Note

Besides in the sector closest to the vehicle symbol, audible warnings are only provided for objects located directly in the vehicle's path.

 **Warning**

- The Park Assist sensors are a complement to the driver's attention to the surroundings around the vehicle. Their ability to detect obstacles at certain angles may be affected by the conditions during use.
- Pay particular attention to people and animals near the vehicle.
- Bear in mind that the front end of the vehicle may swing out towards oncoming traffic during the parking maneuver.
- Objects/obstacles may be closer to the vehicle than they appear on the screen.

 **Warning**

- The function is supplementary driver support intended to facilitate driving and help make it safer – it cannot handle all situations in all traffic, weather and road conditions.
- The driver is advised to read all sections in the Owner's Manual about this function to learn of its limitations, which the driver must be aware of before using the function.
- Driver support functions are not a substitute for the driver's attention and judgment. The driver is always responsible for ensuring the vehicle is driven in a safe manner, at the appropriate speed, with an appropriate distance to other vehicles, and in accordance with current traffic rules and regulations.

\* Option/accessory.

## 10.12.1.2. Park Assist front, rear and sides \*

Park Assist behaves differently depending on which part of the vehicle is approaching an obstacle.

### Front camera

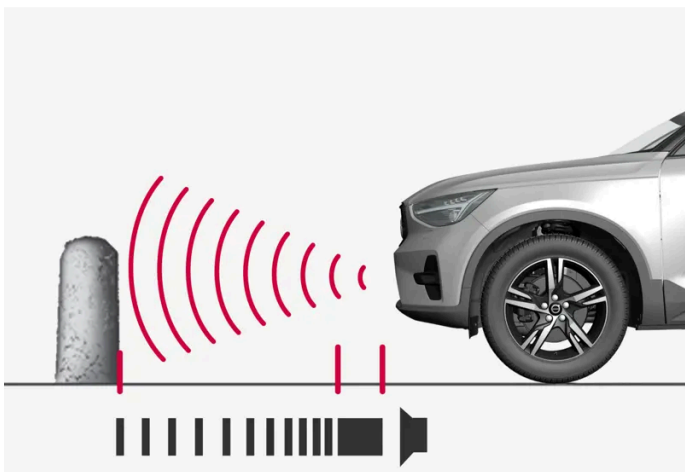

The warning signal has a continuous audible tone when the obstacle is less than approx. 30 cm (1 foot) from the vehicle.

The Park Assist system's front sensors are automatically activated when the engine is started. They are active at speeds below 10 km/h (6 mph).

The distance monitored extends approx. 80 cm (2.5 feet) in front of the vehicle.

**Note**

The Park Assist system is deactivated when the parking brake is used or when **P** is selected on vehicles with automatic transmission.

**Important**

When installing auxiliary lights: Make sure these do not obscure the sensors – the auxiliary lights could be perceived as an obstacle.

## Back

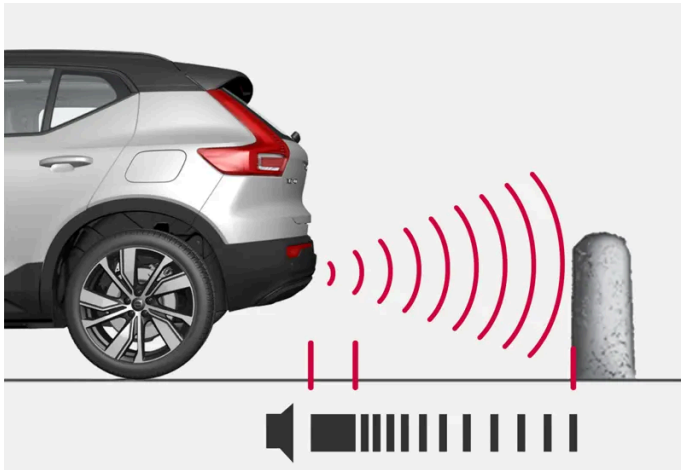

The warning signal has a continuous tone when the obstacle is less than approx. 30 cm (1 foot) from the vehicle.

The rear sensors will be activated if the vehicle begins rolling backward or if reverse gear is engaged.

The distance monitored extends approx. 1.5 meter (5 feet) behind the vehicle.

The Park Assist system's rear sensors will be automatically deactivated if the vehicle is backing up with a trailer connected to the vehicle's electrical system.

**Note**

When reversing with e.g. a trailer or bike carrier on the trailer hitch – without Volvo original trailer cables – the Parking Assist system may have to be turned off manually to prevent the sensors from reacting to these.

## Side sensors

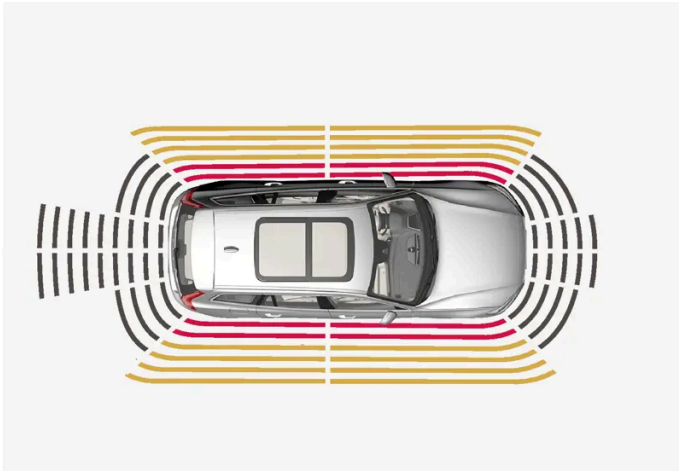

The warning signal pulsates rapidly when the obstacle is less than approx. 25 cm (0.8 foot) from the vehicle.

Park Assist's side sensors are automatically activated when the engine is started. They are active at speeds below 10 km/h (6 mph).

The distance monitored is approx. 25 cm (0.8 foot) out from the sides.

The detection area of the side sensors increases significantly, however, when the steering angle of the front wheel increases and depending on the position of the steering wheel, obstacles up to approx. 90 cm (3 feet) diagonally behind or in front of the vehicle can be detected.

\* Option/accessory.

---

### 10.12.1.3. Activating and deactivating the Park Assist system \*

The Park Assist function can be activated or deactivated.

Park Assist's front and side sensors are automatically activated when the engine is started. The rear sensors are activated if the vehicle is moving backward or reverse gear is engaged.



Activate or deactivate the function using this button in Park Assist Camera view.

- Illuminated button – the function is activated.
- Extinguished button – the function is deactivated.

In vehicles equipped with Park Assist Camera\*, Park Assist can also be activated or deactivated from the relevant camera view.

\* Option/accessory.

## 10.12.1.4. Park Assist limitations \*

Park Assist may not be able to detect all conditions in all situations and functionality may therefore be limited in certain cases.

The driver should be aware of the following limitations for Park Assist:

### Warning

- The Park Assist Cameras' ability to clearly reproduce the surroundings in all zones around the vehicle may be affected by the conditions during use.
- Pay particular attention to people and animals near the vehicle.
- Bear in mind that the front end of the vehicle may swing out towards oncoming traffic during the parking maneuver.
- Objects/obstacles may be closer to the vehicle than they appear on the screen.

### Warning



Be extra cautious when reversing if this symbol is shown when a trailer, bike carrier or similar is attached and electrically connected to the vehicle.

An unlit symbol indicates that the rear parking assist sensors are **deactivated** and will not warn of any obstacles.

### Important

Objects such as chains, thin and glossy poles or low obstacles may end up in the "signal shadow" and then go temporarily undetected by the sensors – the pulsating tone may then unexpectedly stop instead of becoming a constant tone as expected.

The sensors cannot detect high objects, such as protruding ramps.

- In such situations, pay extra attention and maneuver/drive the vehicle very slowly or stop the current parking maneuver – there may be a high risk of damage to the vehicle or other objects since information from the sensors is not always reliable in such situations.

### Important

In some circumstances, the Park Assist System may produce false warnings due to external sound sources with the same ultrasonic frequencies as those the system works with.

Examples of such sources are horns, wet tires on asphalt, pneumatic brakes, exhaust noise from motorcycles, etc.

 **Note**

When a trailer hitch is configured with the vehicle electrical system, the trailer hitch protrusion is included when the function measures the distance to objects behind the vehicle.

\* Option/accessory.

## 10.12.1.5. Park Assist\* and Park Assist Camera\* symbols and messages

Symbols and messages for the Park Assist system and the Park Assist Camera can be displayed in the instrument panel and/or the center display. Several examples are provided below.

Symbol	Message	Meaning
	If the symbol is extinguished.	The rear Park Assist sensors are <b>turned off</b> and no acoustic warnings or field markings for obstacles/objects will be provided.
	Cleaning needed Park Assist System sensors blocked	One or more of the sensors are blocked. Check and clean/remove the obstacle as soon as possible.
	Park Assist System unavailable Service required	The system is not functioning as intended. Contact a workshop <sup>[1]</sup> .

A text message can be erased by briefly pressing the  button in the center of the right-side steering wheel keypad.

If the message persists, contact a workshop. An authorized Volvo workshop is recommended.

 **Warning**



Be extra cautious when reversing if this symbol is shown when a trailer, bike carrier or similar is attached and electrically connected to the vehicle.

An unlit symbol indicates that the rear parking assist sensors are **deactivated** and will not warn of any obstacles.

## Defective Park Assist Camera

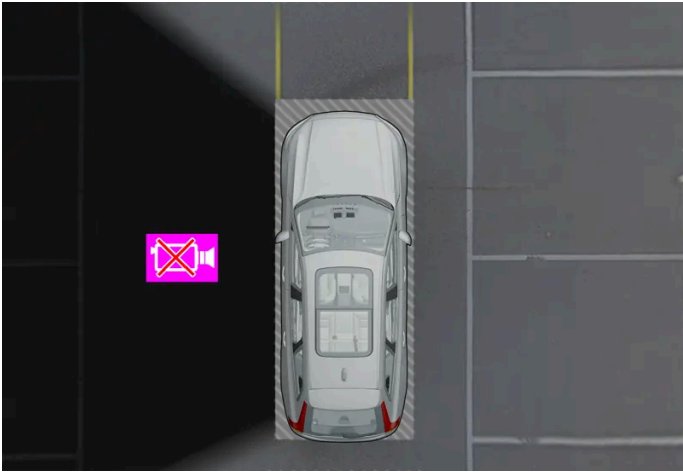

Example indicating that the vehicle's left camera is malfunctioning.

If a camera sector is dark, this indicates that the camera is not functioning properly.

A dark camera sector may also be displayed in the following situations, but **without** the defective camera symbol:

- a door is open
- the tailgate is open
- a rearview mirror is folded in

\* Option/accessory.

<sup>[1]</sup> An authorized Volvo workshop is recommended.

---

## 10.12.2. Park Assist Camera

---

### 10.12.2.1. Park Assist Camera\*

The Park Assist Camera can assist the driver when maneuvering in tight spaces by indicating obstacles using the camera screen and graphics in the center display.

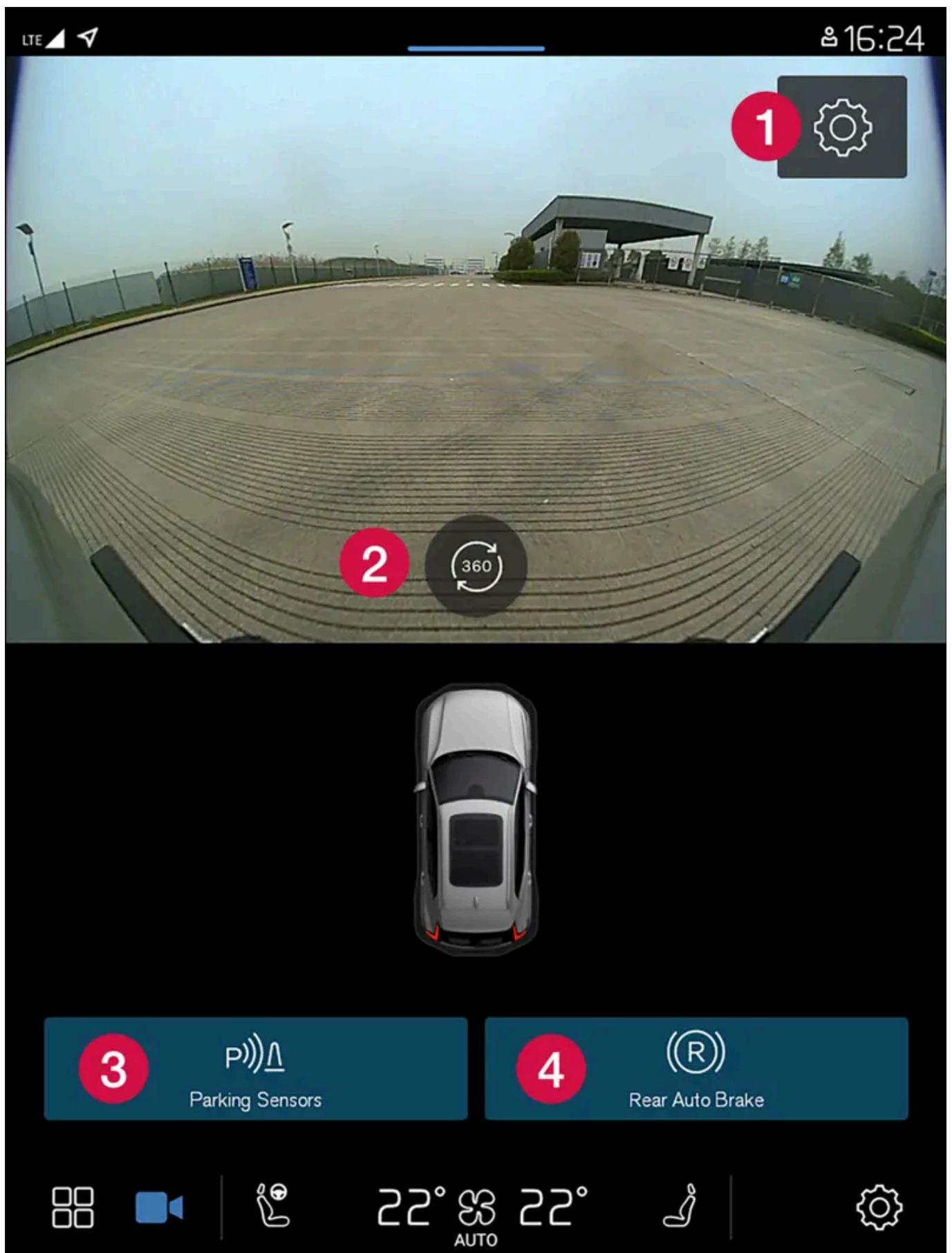

Example camera view.



- 1 Settings
- 2 Activates all cameras to provide a 360° view
- 3 Activates/deactivates Park Assist system sensors
- 4 Activates and deactivates auto-braking when backing up\*

The Park Assist Camera is a support function that is automatically activated when reverse gear is engaged. It can also be started manually in the center display.

 **Warning**

- The Park Assist Cameras' ability to clearly reproduce the surroundings in all zones around the vehicle may be affected by the conditions during use.
- Pay particular attention to people and animals near the vehicle.
- Bear in mind that the front end of the vehicle may swing out towards oncoming traffic during the parking maneuver.
- Objects/obstacles may be closer to the vehicle than they appear on the screen.

 **Warning**

- The function is supplementary driver support intended to facilitate driving and help make it safer – it cannot handle all situations in all traffic, weather and road conditions.
- The driver is advised to read all sections in the Owner's Manual about this function to learn of its limitations, which the driver must be aware of before using the function.
- Driver support functions are not a substitute for the driver's attention and judgment. The driver is always responsible for ensuring the vehicle is driven in a safe manner, at the appropriate speed, with an appropriate distance to other vehicles, and in accordance with current traffic rules and regulations.

\* Option/accessory.

---

## 10.12.2.2. Activating Park Assist Camera\*

The Park Assist Camera is automatically activated when reverse gear is engaged or can be started manually using one of the center display's function buttons.

### Camera view when backing up

When reverse gear is selected, rear view will be shown on the screen.

### Camera view when manually activating the camera



Activate the Park Assist Camera using this button in the center display. The screen will first show the most recently used camera view. But every time the engine is started, the previously shown side view will be replaced by the 360° view.

The content of this manual represents the status of the user manual at the time of printing and may not be completely valid in future instances. For more information refer to the first page for the complete disclaimer note.

- Illuminated button – the function is activated.
- Extinguished button – the function is deactivated.

## Automatically deactivating the camera

Front view switches off when the vehicle's speed reaches 25 km/h (16 mph) to help avoid distracting the driver. It will be automatically reactivated if the vehicle's speed falls below 22 km/h (14 mph) within 1 minute as long as the vehicle's speed has not exceeded 50 km/h (31 mph).

Other camera views switch off at 15 km/h (9 mph) and are not reactivated.

\* Option/accessory.

## 10.12.2.3. Park Assist\* and Park Assist Camera\* symbols and messages

Symbols and messages for the Park Assist system and the Park Assist Camera can be displayed in the instrument panel and/or the center display. Several examples are provided below.

Symbol	Message	Meaning
	If the symbol is extinguished.	The rear Park Assist sensors are <b>turned off</b> and no acoustic warnings or field markings for obstacles/objects will be provided.
	Cleaning needed Park Assist System sensors blocked	One or more of the sensors are blocked. Check and clean/remove the obstacle as soon as possible.
	Park Assist System unavailable Service required	The system is not functioning as intended. Contact a workshop <sup>[1]</sup> .

A text message can be erased by briefly pressing the  button in the center of the right-side steering wheel keypad.

If the message persists, contact a workshop. An authorized Volvo workshop is recommended.

### Warning



Be extra cautious when reversing if this symbol is shown when a trailer, bike carrier or similar is attached and electrically connected to the vehicle.

An unlit symbol indicates that the rear parking assist sensors are **deactivated** and will not warn of any obstacles.

## Defective Park Assist Camera

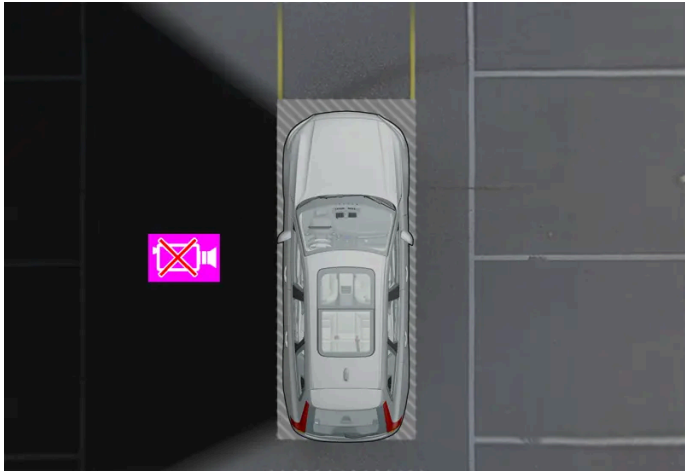

Example indicating that the vehicle's left camera is malfunctioning.

If a camera sector is dark, this indicates that the camera is not functioning properly.

A dark camera sector may also be displayed in the following situations, but **without** the defective camera symbol:

- a door is open
- the tailgate is open
- a rearview mirror is folded in

\* Option/accessory.

[1] An authorized Volvo workshop is recommended.

---

## 10.12.2.4. Park Assist Camera trajectory lines\*

The Park Assist Camera uses trajectory lines and fields on the screen to indicate the vehicle's position in relation to its immediate surroundings.

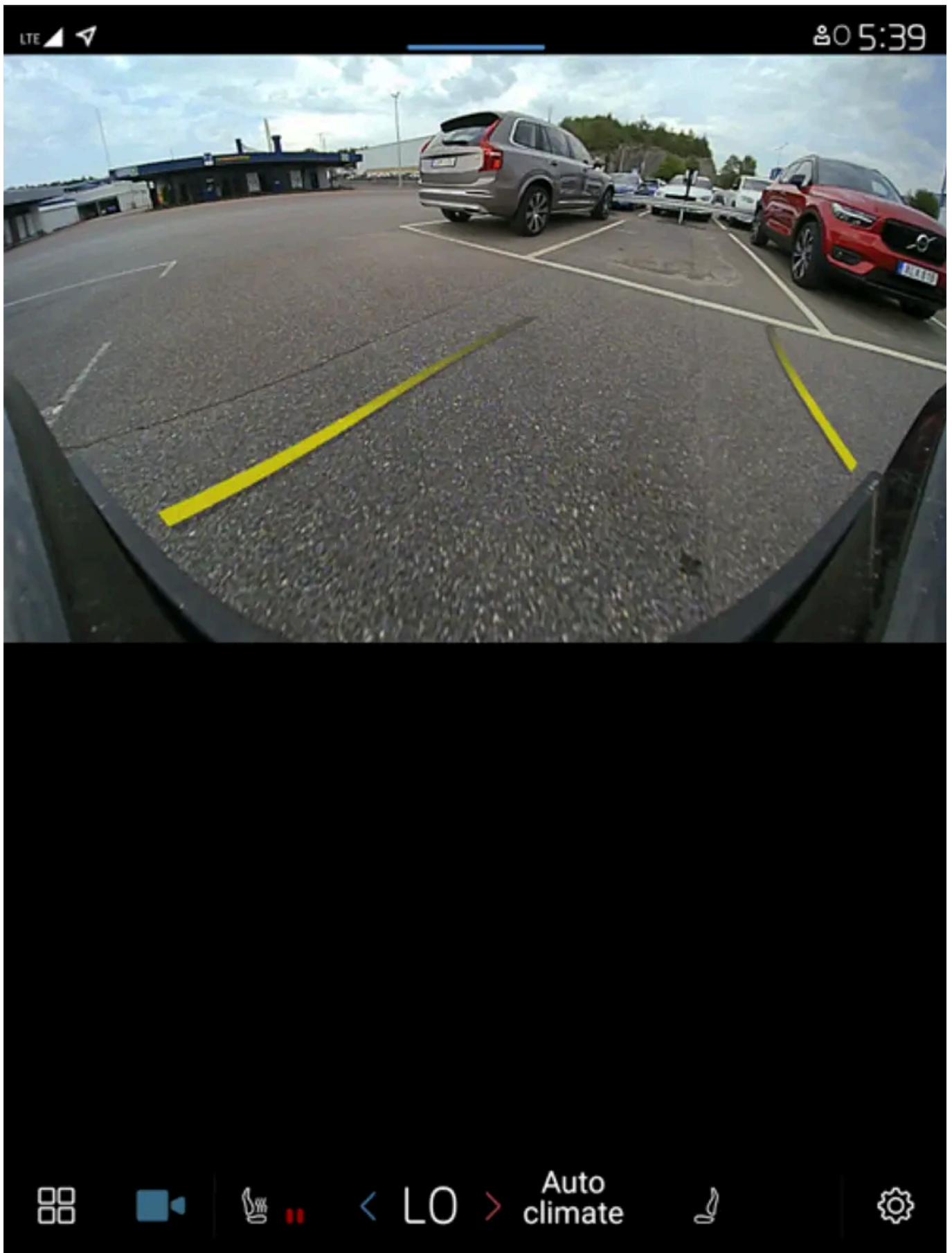

Example of trajectory lines

The content of this manual represents the status of the user manual at the time of printing and may not be completely valid in future instances. For more information refer to the first page for the complete disclaimer note.

The trajectory lines show the anticipated trajectory for the vehicle's outermost dimensions based on the current position of the steering wheel and can help simplify parallel parking, backing into tight spaces or attaching a trailer.

The lines on the screen are projected as if they were painted lines on the ground behind the vehicle and are directly affected by the way in which the steering wheel is turned. This makes it possible for the driver to see path the vehicle will take, even if he/she turns the steering wheel.

These lines also indicate the outermost limits that any object (towbar, rearview mirrors, corners of the body, etc.) extends out from the vehicle.

**Note**

- When backing up with a trailer that is not electrically connected to the vehicle, the trajectory lines on the screen show the path the **vehicle** will take – not the trailer.
- The screen does not show guide lines when a trailer is electrically connected to the vehicle's electrical system.

**Important**

- Bear in mind that when the rearward camera view is selected, the screen only shows the area behind the vehicle – pay attention to the sides and front of the vehicle when steering while reversing.
- The same applies to the reverse – pay attention to what is happening with the rear parts of the vehicle when the front camera view is selected.
- Note that the guide lines show the **shortest** path – pay extra attention to ensure that the vehicle sides do not come in contact with/travel over anything when steering while driving forward or that the vehicle front moves toward/over anything when steering while reversing.

**Trajectory lines in 360° view\***

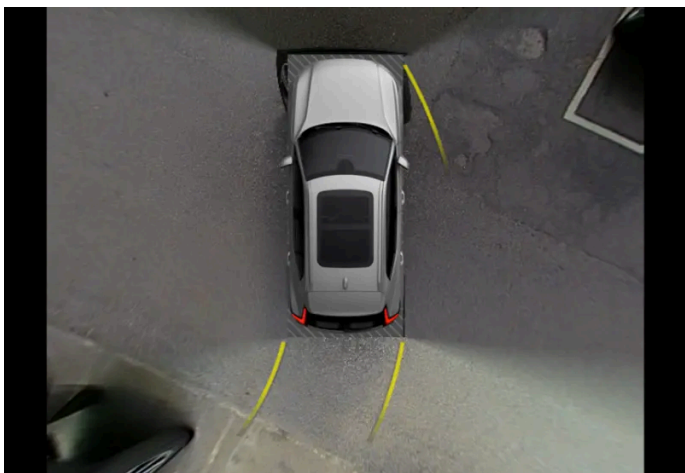

360° view with trajectory lines

In the 360° view, trajectory lines are shown behind, in front of, or to the sides of the vehicle, depending on the direction of travel.

- When driving forward: Front lines
- When backing up: Side lines and rear lines

When the front or rear camera is selected, the trajectory lines will be shown regardless of the vehicle's direction of travel.

With a side camera selected, the trajectory lines will only be shown if the vehicle is backing up.

#### Trajectory lines for a towbar

A trajectory line for the towbar's intended direction of travel can be shown to assist when hitching a trailer. The function is activated under the Park Assist Camera settings.

Trajectory lines cannot be displayed for the towbar and the entire vehicle at the same time.

\* Option/accessory.

---

## 10.12.2.5. Location and field of vision of Park Assist Cameras \*

The Park Assist Cameras can individually show rear, front, left or right camera views. You can also get a combined 360° view showing the views from all sides of the vehicle.

### 360° view\*

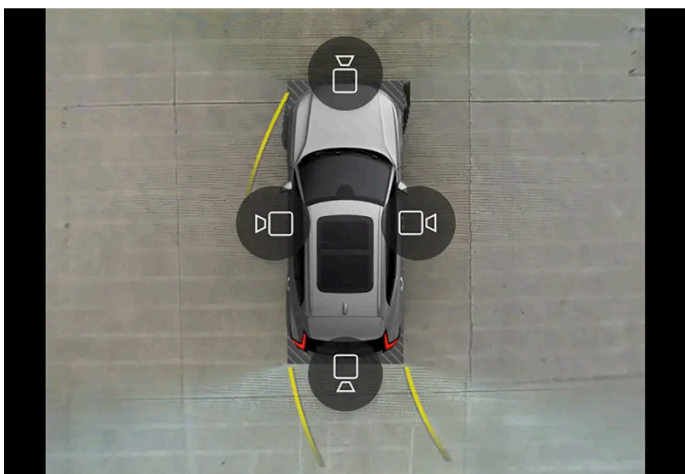

Example of how all camera symbols are displayed in 360° view.

The 360° view function activates all Park Assist Cameras and all four sides of the vehicle are shown in the center display at once to help the driver see what is around the vehicle while maneuvering at low speeds. From the 360° view, each camera view can be activated separately. Tap the screen to display the camera symbols and select a view. These camera symbols disappear after a moment if the screen is not touched.

The cameras can be activated automatically or manually.

## Back



The rear camera is located above the license plate.

The rear camera shows a wide area behind the vehicle. On certain models, part of the bumper and the towbar (if installed) may be visible.

Objects in the center display may appear to be leaning slightly. This is normal.

## Front camera



The front Park Assist Camera is located in the grille.

The front camera can be useful when pulling out from areas with limited visibility, such as when pulling out of a garage. The front camera is active at speeds up to 25 km/h (16 mph) and is automatically turned off when the vehicle exceeds this speed.

If the vehicle does not reach a speed of 50 km/h (30 mph) and speed falls below 22 km/h (14 mph) within 1 minute after the front camera turns off, the camera will be reactivated.

## Side cameras

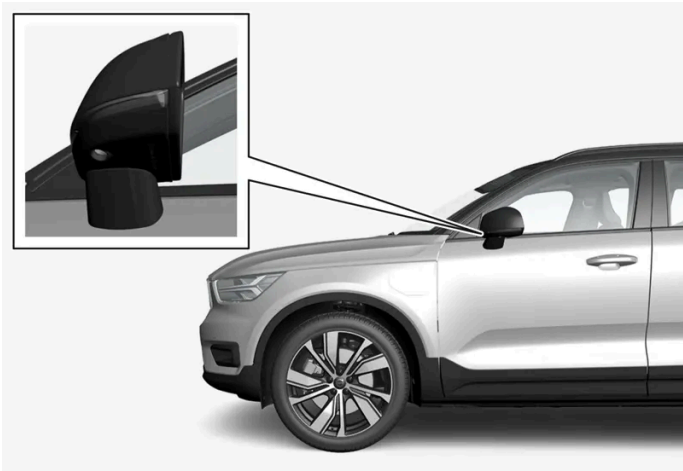

The side cameras are located in the rearview mirrors.

The side cameras can show views along each side of the vehicle.

\* Option/accessory.

---

## 10.12.2.6. Park Assist sensor field\*

If the vehicle is equipped with Park Assist, distances will be shown in the Park Assist Camera's 360° view with colored fields for each sensor that has detected an obstacle.

### Front and rear sensors

The front and rear fields change colors (from yellow to orange to red) as the vehicle moves closer to an obstacle.

Field color rearward	Distance in meters (feet)
Yellow	0.6-1.5 (2.0-4.9)
Orange	0.3-0.6 (1.0-2.0)
Red	0-0.3 (0-1.0)

Field color forward	Distance in meters (feet)
Yellow	0.6-0.8 (2.0-2.6)
Orange	0.3-0.6 (1.0-2.0)
Red	0-0.3 (0-1.0)

When the sensor field color is red, the audible pulsing sounds will change to a continuous tone.



 **Warning**

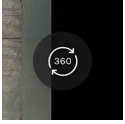

The sensor fields on the 360° symbol only show in which direction an obstacle is located. It does not show the distance to the obstacle.

## Side sensor fields

Warning signals vary depending on the vehicle's intended direction of travel. Depending on the steering wheel position, warnings may be given for obstacles diagonally in front of or behind the vehicle, not only directly behind the vehicle.

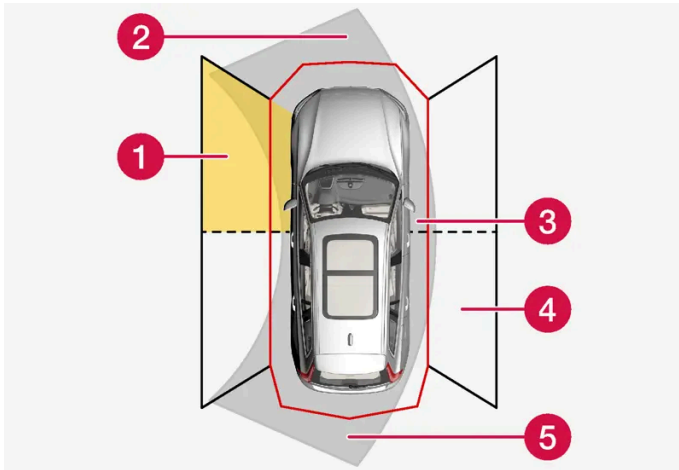

Parking sensor sectors where obstacles can be detected.

- 1 Left-side front sensor field
- 2 Obstacle sector in the vehicle's intended direction of travel forward – varies according to steering wheel position
- 3 Sector with red field color and rapidly pulsing tone
- 4 Right-side rear sensor field
- 5 Obstacle sector in the vehicle's intended direction of travel rearward – varies according to steering wheel position.

The color of the side field changes as the vehicle moves closer to the object – from yellow to red.

Side field color	Distance in meters (feet)
Yellow	0.25–0.9 (0.8–3.0)
Red	0–0.25 (0–0.8)

When the sensor field is red, the audible pulsing signal will become more rapid.

\* Option/accessory.

## 10.13. Camera and radar sensor

## 10.13.1. Recommended maintenance for the camera, sensor and radar units

In order for the cameras, parking sensors and radar units to function properly, they must be kept free of dirt, ice, snow, etc. and should be washed regularly with water and car washing detergent.

- Do not attach any items, tape or decals in the areas described below.
- Clean the camera lenses regularly using lukewarm water and car washing detergent. Wash gently to avoid scratching the lens.
- Avoid mounting extra lights or similar in the grille, as this could affect the front radar unit's performance.
- To help ensure proper functioning of the front radar unit, use only the Volvo original emblem in the grille in front of the front radar unit.

### Location of the radar units



Location of the front radar sensor



Location of rear radar sensors

## Location of the Park Assist sensors



Location of the parking sensors around the vehicle

### **i** Note

Dirt, ice and snow covering the sensors could cause false warnings, reduced function, or no function.

## Location of the camera



Location of the camera

### **!** Important

Only a workshop may perform maintenance on driver support components – an authorized Volvo workshop is recommended.

## 10.13.2. Camera and radar unit symbols and messages

Here are examples of some of the messages and symbols related to the camera and radar units that may be displayed in the instrument panel.

## Sensor blocked



If this symbol and a message are displayed in the instrument panel, it means that the camera and radar units are unable to detect other vehicles, cyclists, pedestrians and large animals in front of the vehicle and that the vehicle's camera and radar-based functions may be obstructed.

The following table shows some of the situations that can cause the message to be displayed, and suggested actions:

Cause	Action
The area in front of the radar unit is dirty or covered by ice or snow.	Clean the area in front of the radar unit to remove dirt, ice and snow.
The area of the windshield in front of the camera is dirty or covered by ice or snow.	Clean the windshield in front of the camera and remove dirt, ice and snow.
Thick fog, heavy rain or snow is blocking the radar signals or the camera's range of visibility.	No action. Heavy precipitation may sometimes prevent the camera/radar sensor from functioning.
Water or snow is spraying/swirling up and blocking the radar signals or the camera's range of visibility.	No action. Very wet or snow-covered roads may sometimes prevent the camera/radar sensor from functioning.
Bright sunlight.	No action. The camera/radar sensor will reset automatically when lighting conditions improve.

## 10.13.3. Camera and radar unit limitations

The camera and radar used by several of the driver support functions have certain limitations, which also affect the functions using the camera and radar units. The driver should be aware of the following limitations:

### Common camera and radar limitations

Cameras and radar are aids for intelligent driving that cannot be called upon to achieve intelligent driving, and necessary safety management must be implemented to avoid traffic safety risks or accidents caused by the driver's incorrect use of cameras and radar.

#### Obstructed camera

Do not place, affix or mount anything in front of or around the camera and radar units – this could disrupt camera- and radar-based functions. It could cause functions to be reduced, deactivated completely or to produce an incorrect function response.

#### Damaged windshield

When a camera is mounted in the windshield, the following also applies:

- If there are cracks, scratches or stone chips in front of the unit covering an area of about 0.5 × 3.0 mm (0.02 × 0.12 in.) or more, contact a workshop<sup>[1]</sup> to have the windshield replaced.
- Volvo advises **against** repairing cracks, scratches or stone chips in the area in front of the unit – the entire windshield should instead be replaced.
- Before replacing the windshield, contact a workshop<sup>[1]</sup> to verify that the right windshield has been ordered and installed.
- The same type of windshield wipers or wipers approved by Volvo should be used for replacement.

The content of this manual represents the status of the user manual at the time of printing and may not be completely valid in future instances. For more information refer to the first page for the complete disclaimer note.

- If the windshield is replaced, the camera must be recalibrated by a workshop <sup>[1]</sup> to help ensure proper functioning of all of the vehicle's camera-based systems.

 **Note**

Failure to take action could result in reduced performance for the driver support systems that use the camera and/or radar units. It could cause functions to be reduced, deactivated completely or to produce an incorrect function response.

## Additional radar limitations

### Vehicle speed

The radar sensor's ability to detect a vehicle ahead is significantly reduced if the speed of the vehicle ahead differs greatly from your vehicle's speed.

### Limited field of vision

The radar sensor has a limited field of vision. In some situations, it may detect a vehicle later than expected or not at all.

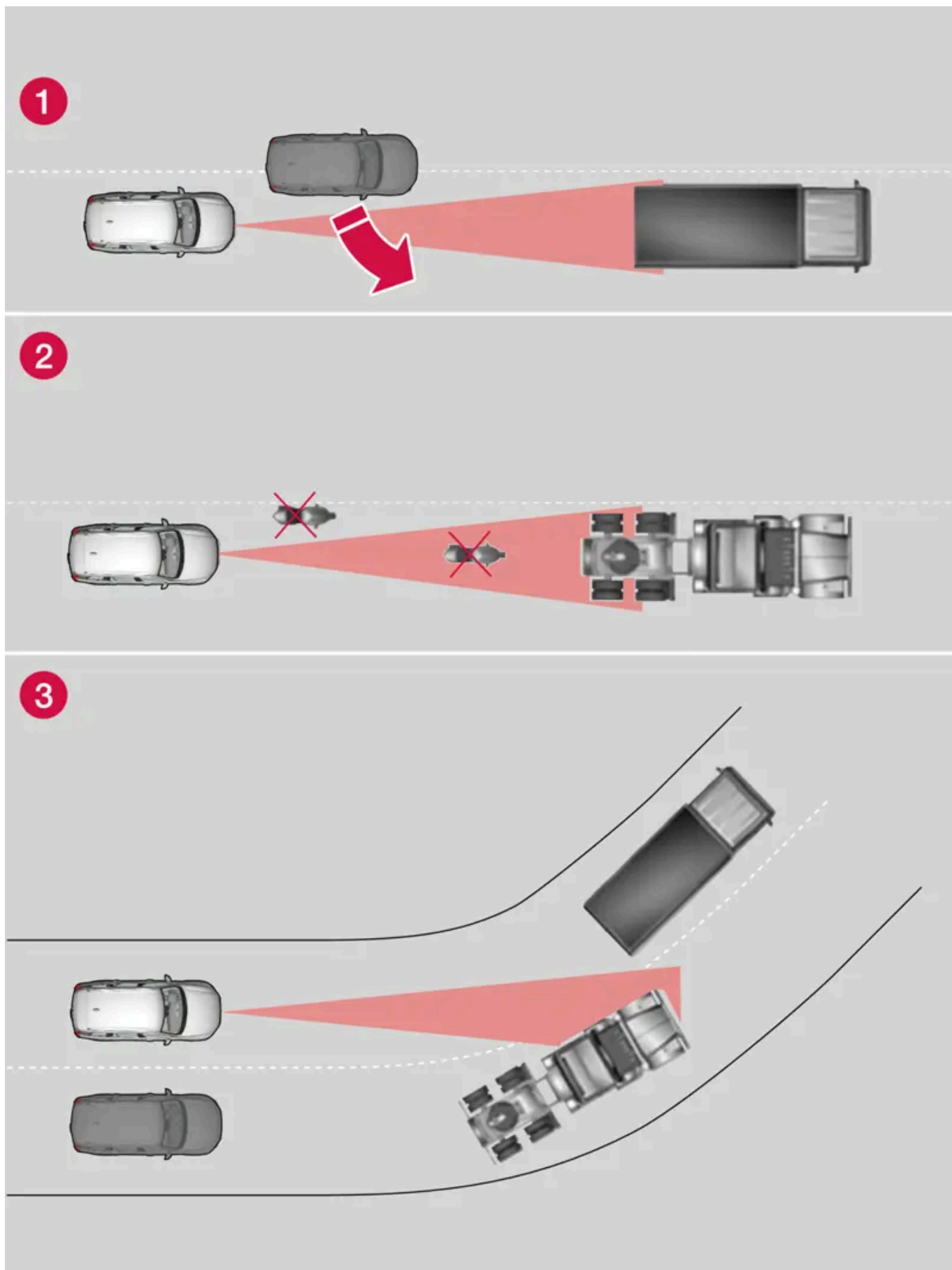

The radar sensor's field of vision

- 1 The radar sensor's detection of vehicles very close to your vehicle may be delayed in certain situations, e.g. if a vehicle pulls in between your vehicle and the vehicle directly ahead.
- 2 Small vehicles, such as motorcycles, or vehicles that are not driving in the center of the lane may remain undetected.
- 3 In curves, the radar may detect the a different vehicle than intended or lose sight of a target vehicle.

#### Reduced functionality

In heavy rain or if there is wet snow or ice on the emblem, the radar's functions may be reduced, completely disabled or provide inaccurate responses.

## Additional camera limitations

#### Reduced visibility

Cameras have the same limitations as the human eye. In other words, their "vision" is impaired by adverse weather conditions such as heavy snowfall/rain, dense fog, swirling dust/snow, etc. These conditions may reduce the function of systems that depend on the camera or cause these systems to temporarily stop functioning.

Strong sunlight, reflections from the road surface, ice or snow covering the road, a dirty road surface, or unclear lane marker lines may drastically reduce the camera's ability to detect the side of a lane, a pedestrian, a cyclist, a large animal or another vehicle.

Bicycle holders or other accessories mounted behind the vehicle may obstruct the camera's view.

## Additional Park Assist Camera\* limitations

#### Blind sectors

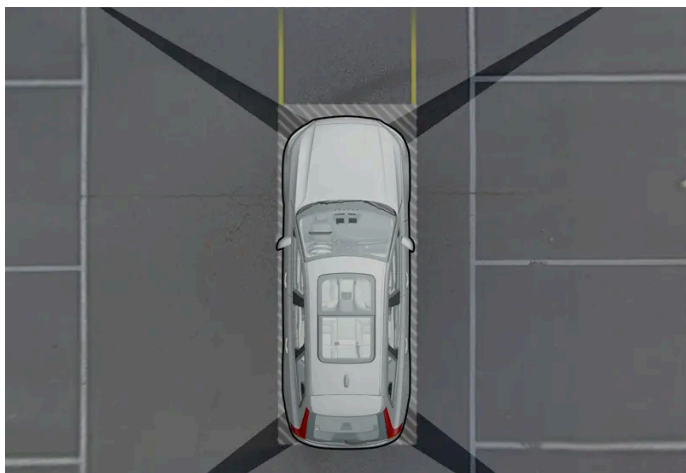

There are "blind" sectors between the cameras' fields of vision.

With the Park Assist Camera's 360° view\* selected, objects/obstacles may not be detected if they are located in the "joints" where the edges of the individual camera views meet.

#### **Warning**

Even if it seems as though only a fairly small section of the screen image is obstructed, this may mean that a relatively large sector is hidden and obstacles there may not be detected until they are very near the vehicle.

### Lighting conditions

The camera image is automatically adjusted according to the current lighting conditions. This means that the brightness and quality of the image may vary slightly. Poor lighting conditions may result in reduced image quality.

[1] An authorized Volvo workshop is recommended.

\* Option/accessory.

---

## 10.13.4. Camera

The camera is used by several driver support systems to e.g. detect lane marker lines or road signs.



Location of the camera

The camera is used by the following functions:

- Pilot Assist\*
- Lane Keeping Aid\*
- Assistance at risk of collision
- Driver Alert\*
- Road Sign Information\*
- Active high beams\*
- Park Assist\*
- Ready to Drive notification

#### Important

Do not attempt to access the camera with sharp or foreign objects through the ventilation openings as this could damage the equipment.

\* Option/accessory.



---

## 10.13.5. Radar units

The radar units are used by several driver support systems and detect different areas around the vehicle.



Location of the front radar sensor



Location of rear radar sensors

Modifying the radar units can make them illegal to use.

Avoid mounting extra lights or similar in front of the grille, as this could affect the radar unit's function.

To help ensure proper functioning of the front radar unit, use only the Volvo original emblem in the grille in front of the front radar unit.

---

## 10.13.6. Radar sensor type approval

The type approval for the vehicle's radar units for Pilot Assist\* and BLIS\* <sup>[1]</sup>.

Market	PA	BLIS	Type approval
Canada	✓		IC: 8436B-77V12FLR
		✓	IC:2694A-RS4
USA	✓		FCC ID: WU877V12FLR
		✓	FCC ID: NBG01RS4

### Canada

This device contains license-exempt transmitter(s)/receiver(s) that comply with Innovation, Science and Economic Development Canada's license exempt RSS(s). Operation is subject to the following two conditions:

- (1) This device may not cause interference.
- (2) This device must accept any interference, including interference that may cause undesired operation of the device.

L'émetteur/récepteur exempt de licence contenu dans le présent appareil est conforme aux CNR d'Innovation, Sciences et Développement économique Canada applicables aux appareils radio exempts de licence. L'exploitation est autorisée aux deux conditions suivantes :

- 1) L'appareil ne doit pas produire de brouillage;
- 2) L'appareil doit accepter tout brouillage radioélectrique subi, même si le brouillage est susceptible d'en compromettre le fonctionnement.

### USA

This device complies with Part 15 of the FCC Rules. Operation is subject to the following two conditions: (1) this device may not cause harmful interference, and (2) this device must accept any interference received, including interference that may cause undesired operation.

#### CAUTION TO USERS

Changes or modifications not expressly approved by the party responsible for compliance could void the user's authority to operate the equipment.

For detailed information about type approval, go to [volvocars.com/intl/support](https://www.volvocars.com/intl/support) [<https://www.volvocars.com/intl/support>].

\* Option/accessory.

[1] Blind Spot Information

## 10.14. Driver support systems

The vehicle is equipped with a number of driver support systems that can provide the driver with active or passive assistance in various situations.

The systems can, for example, help the driver:

- with steering assistance to reduce the risk of inadvertently veering from your own lane or colliding with another vehicle
- maintain a set speed
- maintain a set time interval to the vehicle ahead
- help prevent a collision by warning the driver and applying the brakes
- park.

Some of the systems are standard and others are options. This also varies from market to market.

Some of the systems have improved functionality when Google Maps is in use.

### **Warning**

The driver support systems are only supplementary aids – they cannot manage all situations in all conditions.

The driver is always responsible for ensuring that the vehicle is driven in a safe manner and in accordance with applicable traffic rules and regulations.

## 10.15. Driver support warnings

If you find that the vehicle is acting in a way that you did not expect, it may be that one of the vehicle's safety-related functions has been activated.

### What is happening in your vehicle?

There are a number of functions in your vehicle that can actively help to improve safety in traffic, both for you and for other road users. To help prepare you in the event any of the functions is suddenly activated, an overview is provided here of some of the functions and how they might react. If a function is activated, you can also be notified of this via a text message in the instrument panel.

### **Note**

Read the individual parts about each system to fully understand the functions and be notified of important warnings.

### Warning with symbols, sounds, lights or vibration

The driver support functions in your vehicle can alert you in different ways. They can provide alerts through e.g. vibrations in the steering wheel, brake pulsations, visible or audible signals, or through symbols in the instrument panel.

### Assistance at risk of collision

Assistance during collision risks<sup>[1]</sup> can help the driver avoid or mitigate a collision by providing warnings, automatic braking and steering assistance.

How the function is experienced can therefore differ depending on which subfunction is activated.

Assistance during collision risks can, if necessary, provide the following:

**The content of this manual represents the status of the user manual at the time of printing and may not be completely valid in future instances. For more information refer to the first page for the complete disclaimer note.**

- Collision warning
- Assisted braking
- Auto-hold brakes
- Steering assistance

## Lane Keeping Aid (LKA <sup>[2]</sup>)



Lane Keeping Aid can help you reduce the risk of the vehicle inadvertently veering out of its own lane.

- Assist: If the function detects that the vehicle is approaching a lane marker line, you will feel light pressure applied to the steering wheel. Both hands must be on the steering wheel for this function to work.
- Warning: If the function detects that the vehicle is approaching a lane marker line, you will be alerted through vibrations in the steering wheel.
- Both: You are alerted with vibrations and light pressure on the steering wheel.

## Rear Collision Warning (RCW)\*



Rear Collision Warning is a system that can help you avoid being hit from behind by an approaching vehicle. If the system detects a collision risk from behind, it can alert you and provide the following types of assistance depending on the situation.

- Intense flashes of the direction indicators.
- At lower speeds, the function can tension the seat belts by activating the seat belt tensioners and the Whiplash Protection System.
- If the vehicle is stationary, the brakes can be applied.

## Blind Spot Information (BLIS)

BLIS is designed to help provide assistance in heavy traffic with several lanes moving in the same direction by alerting the driver to rapidly approaching vehicles and to the presence of vehicles in the "blind spot" area behind and to the side of your vehicle.



- Warning with an indicator light in the door mirror, with steady and flashing lights.

## Driver Alert



The function is designed to catch the driver's attention if he/she starts driving inconsistently, for example, if the driver is distracted or starts to fall asleep.

- Audible signal combined with a symbol in the instrument panel and a message.

## Warning and auto-braking while backing up



There are two functions that can help the driver avoid a collision while backing up.

- Cross Traffic Alert (CTA)\* is designed to alert the driver of crossing traffic when the vehicle is backing up.
- Rear Auto Brake (RAB) is designed to help the driver detect stationary obstacles directly behind the vehicle when backing up.

If an obstacle is detected:

1. A warning signal and graphic for Park Assist illuminate to indicate the location of the obstacle.
2. If the driver does not react to the warning and a collision is unavoidable, the vehicle will automatically brake, and a message will appear explaining why the brakes were applied.

## Electronic Stability Control (ESC)



The Electronic Stability Control (ESC<sup>[3]</sup>) function helps the driver avoid skidding and improves the vehicle's directional stability. When the system engages, the symbol flashes in the instrument panel. If an error has occurred and the system is not available, the symbol lights with a steady glow together with a text message.

### **Warning**

The functions described here are supplementary aids - they cannot manage all situations in all conditions.

The driver is always responsible for ensuring that the vehicle is driven in a safe manner and in accordance with applicable traffic rules and regulations.

<sup>[1]</sup> Collision Avoidance

<sup>[2]</sup> Lane Keeping Aid

\* Option/accessory.

## 10.16. Speed-dependent steering wheel resistance

Speed-dependent power steering increases the steering wheel resistance in pace with the vehicle's speed, which can help give the driver an enhanced feeling of control and stability. Steering is stiffer on highways. When parking and at low speeds, it will be easier to move the steering wheel.

### Reduced power

In rare situations, the power steering may need to work at reduced power and the steering wheel may then feel more difficult to move. This may happen when the power steering becomes too hot and needs to be temporarily cooled. It can also happen if there is a disturbance in power supply.



If there is reduced power, the message **Power steering assistance Temporarily reduced** and this symbol are shown in the instrument panel.

While the power steering is working at reduced power, the driver support functions and systems with steering assistance are not available.



If the temperature rises too high, the power steering may be forced to switch off completely. In such a situation, the driver display shows the message **Stop safely Power steering failure** along with a symbol.

## Changing the level of steering wheel resistance

- 1 Tap  in the center display.
- 2 Then press **Driving**.
- 3 Activate or deactivate **Steering feel firm**.

Steering wheel resistance settings can only be accessed if the vehicle is stationary or is moving straight ahead at a low speed.

---

## 10.17. Ready to Drive notification

The vehicle's system can help alert the driver when the vehicle ahead starts driving again.

To help prevent the vehicle from remaining stationary too long and causing traffic disturbances, the **Ready to drive notification** function can provide an audible signal and display a symbol and message in the instrument panel. If the system detects pedestrians or cyclists near the vehicle, it might not provide a notification.

 **Warning**

However, the system cannot detect pedestrians and cyclists in all situations. The driver is always responsible for ensuring that the vehicle is operated in a safe manner.

To activate or deactivate the function:

- 1 Tap  in the center display.
- 2 Tap **Driving** and change the setting.

 **Warning**

- The function is supplementary driver support intended to facilitate driving and help make it safer – it cannot handle all situations in all traffic, weather and road conditions.
- The driver is advised to read all sections in the Owner's Manual about this function to learn of its limitations, which the driver must be aware of before using the function.
- Driver support functions are not a substitute for the driver's attention and judgment. The driver is always responsible for ensuring the vehicle is driven in a safe manner, at the appropriate speed, with an appropriate distance to other vehicles, and in accordance with current traffic rules and regulations.

 **Note**

This function uses the vehicle's radar and/or camera units, which have some general limitations.

## 10.18. Braking assist after a collision

In a collision in which the activation level is reached for the pyrotechnic seat belt tensioners or airbags, or if a collision with a large animal is detected, the vehicle's brakes will be automatically activated. This function is intended to help prevent or reduce the effects of any subsequent collision.

After a serious collision, it may no longer be possible to control and steer the vehicle. In order to avoid or mitigate a possible further collision with a vehicle or an object in the vehicle's path, the brake assist system is activated automatically to help stop the vehicle safely.

The brake lights and hazard warning flashers are activated during braking. When the vehicle has stopped, the hazard warning flashers will continue to flash and the parking brake will be applied.

If braking is not appropriate, e.g. if there is a risk of being hit by passing traffic, the driver can override the system by depressing the accelerator pedal.

This function assumes that the brake system is intact after a collision.

---



# 11. Starting and driving

---

## 11.1. Starting and switching off vehicle

---

### 11.1.1. Electronic immobilizer

The electronic immobilizer is a start inhibitor that helps prevent the vehicle from being started by an unauthorized person.

The vehicle can only be started with the right key.

The following instrument panel error messages are related to the electronic immobilizer:

Symbol	Message	Meaning
	The car key is not detected. See Owner's Manual for more information.	Key not recognized during start. Place the key on the key symbol in the tunnel console's storage compartment and try to start the vehicle again.

### 11.1.2. Starting the vehicle

The vehicle can be started using the start button next to the steering wheel when the key is in the passenger compartment.

 **Warning**

Before starting:

- Buckle your seat belt.
- Adjust the seat, steering wheel and mirrors.
- Make sure you can fully depress the brake pedal.



Location of the start button.

Make sure the key is in the vehicle<sup>[1]</sup>.

- 1 Fasten your seat belt.
  - 2 Depress the brake pedal<sup>[2]</sup>.
  - 3 Press the start button.
- The engine is started.
- 4 Put the gear selector in position D or R.

 **Important**

If the engine has not responded after 3 attempts – wait for 3 minutes before starting a new attempt. Starting capability increases if the starter battery is given time to recover.

The starter motor will crank until the engine starts or until overheating protection is triggered<sup>[3]</sup>.

## Error messages

If the **Car key not detected** message is shown at start, place the key at the backup reader and then make a new start attempt.

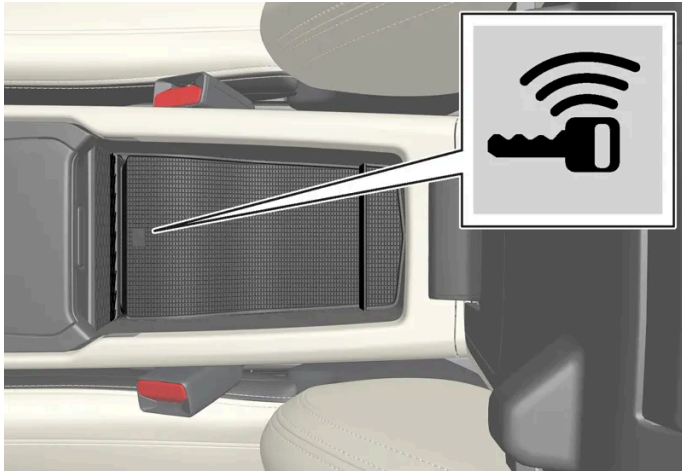

Location of the backup reader.

**Note**

When the key is placed in the backup reader, make sure that no other keys, metal objects or electronic devices (e.g. cellular phones, tablets, laptops or chargers) are in the backup reader. Multiple keys close to each other in the backup reader can disrupt their functionality.

**Warning**

**Never** remove the key from the vehicle while driving or while the vehicle is being towed.

**Warning**

- Always remove the key from the passenger compartment when you leave the vehicle and make sure the ignition is in mode **O**.
- Always put the gear selector in P and apply the parking brake before leaving the vehicle. Never leave the vehicle unsupervised while the engine is running.
- Always open the garage door fully and make sure that ventilation is very good before starting the engine in a garage. The exhaust fumes produced by the vehicle contain carbon monoxide, which is invisible and odorless but very toxic.

 **Important**

- When starting in cold weather, the automatic transmission may shift up at slightly higher engine speeds than normal until the automatic transmission fluid reaches normal operating temperature.
- Do not race a cold engine immediately after starting. This could prevent fluids from properly lubricating vital components in the engine before it has reached the proper operating temperature.
- The engine should be idling when the gear selector is moved. Never accelerate until the gear is fully engaged. Accelerating rapidly before a gear is properly engaged could lead to harder wear of components.
- To help prevent the transmission oil from overheating, select P or N when idling at a standstill for prolonged periods of time.

 **Note**

With a cold start, idling speed may be considerably higher than normal for certain engine types. This is done to get the emissions system up to normal operating temperature as quickly as possible, which minimizes exhaust emissions and protects the environment.

 **Warning**

- Never use more than one inlay mat at a time on the driver's floor. If any other type of floor mat is used, remove the original mat from the driver's seat floor before driving. All types of mats must be securely anchored in the attachment points in the floor. Make sure the floor mat does not impede the movement of the brake pedal or accelerator pedal in any way, as this could be a serious safety hazard.
- Volvo's floor mats are specially manufactured for your vehicle. They must be properly secured in the attachment points in the floor to help ensure they cannot slide and become trapped under the pedals.

<sup>[1]</sup> For vehicles with passive start, the key must be in the front section of the passenger compartment.

<sup>[2]</sup> If the vehicle is moving, it is only necessary to press the start button to start the engine.

<sup>[3]</sup> Does not apply for KERS vehicles, which use the generator for starting.

## 11.1.3. Jump starting using another battery

If the start battery is discharged, current from another battery can be used to start the vehicle.

Jump-starting requires access to another vehicle's 12 V battery and jumper cables.

 **Important**

The charging points in mild hybrid vehicles are only intended for jump-starting your own vehicle. Don't use the charging points on mild hybrid vehicles to start other vehicles – the charging circuit's fuse could be overloaded and stop working.

In mild hybrid vehicles, a discharged start battery can be caused by an overloaded fuse that is preventing charging. If the fuse has blown, **12 V battery fuse failure Service required** will be displayed in the instrument panel. Volvo recommends contacting an authorized Volvo workshop.

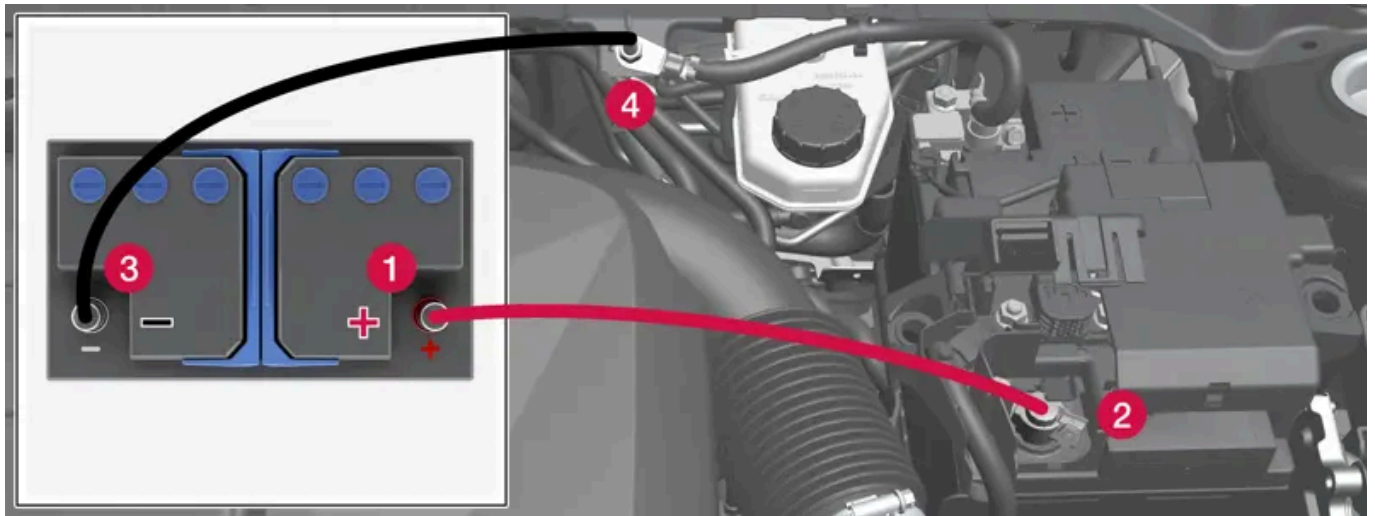

Jumper cable charging points. Engine compartment appearance may vary depending on vehicle model and equipment level.

To avoid short circuits or other damage, the following steps are recommended when jump starting the battery using another battery:

- 1 Put the ignition in mode 0.
- 2 Make sure that the assisting battery has a voltage of 12 V.
- 3 If the battery is in another vehicle, turn off that vehicle's engine and make sure that the vehicles are not touching each other.
- 4 Clamp one end of the red jumper cable to the assisting battery's positive terminal (1).

**!** Important

Connect the jumper cable carefully to prevent short circuit and contact with other components in the engine compartment.

- 5 Fold back the cover over your vehicle's positive charging point (2).
- 6 Clamp the other end of the red jumper cable to your vehicle's positive charging point (2).
- 7 Clamp one end of the black jumper cable to the assisting battery's negative terminal (3).
- 8 Clamp the other end of the black jumper cable to your vehicle's negative charging point (4).
- 9 Make sure the jumper cable's clamps are securely attached. Poor contact can cause sparks or the clamps to loosen during the start attempt.
- 10 Start the engine of the assisting vehicle and let it run for a few minutes at a higher idling speed than normal, about 1500 rpm.
- 11 Start the engine of the vehicle with the dead battery.

The content of this manual represents the status of the user manual at the time of printing and may not be completely valid in future instances. For more information refer to the first page for the complete disclaimer note.

 **Important**

Do not touch the connections between the cable and the vehicle during the start attempt. Risk of sparking.

**12** Remove the jumper cables in the reverse order – first the black cables and then the red cables.

Make sure that none of the clamps of the black jumper cables come into contact with the vehicle's positive charging point, the assisting vehicle's battery's positive terminal, or either of the red jumper cable's connected clamps.

 **Warning**

Mild hybrid vehicles have components that work with 48 V voltage, which can be dangerous if handled incorrectly. Do not touch components that are not clearly described in the Owner's Manual.

- Never use a 48 V support battery to jump-start the vehicle.
- External electrical equipment may not under any circumstance be connected to the 48 V battery.
- Only a workshop may replace or perform service on the 48 V battery – an authorized Volvo workshop is recommended.

 **Warning**

**PROPOSITION 65 WARNING!** Battery posts, terminals, and related accessories contain lead and lead compounds, chemicals known to the state of California to cause cancer and reproductive harm. Wash hands after handling.

 **Warning**

- Batteries generate hydrogen gas, which is flammable and explosive.
- Do not connect the jumper cable to any part of the fuel system or to any moving parts. Avoid touching hot manifolds.
- Battery fluid contains sulfuric acid. Do not allow battery fluid to contact eyes, skin, fabrics or painted surfaces.
- If contact occurs, flush the affected area immediately with water. Obtain medical help immediately if eyes are affected.
- Never expose the battery to open flame or electric spark. Do not smoke near the battery. Failure to follow the instructions for jump starting can lead to injury.

**i Note**

If the starter battery has such a low charge level that the vehicle does not have normal electrical functions and the engine must then be jump-started with an external battery or a battery charger, the Start/Stop function may remain activated. If the Start/Stop function shortly thereafter auto-stops the engine, there is a huge risk that auto-start of the engine will fail since the battery had not had time to recharge sufficiently.

If the vehicle has been jump-started or if there has not been enough time for the battery to be charged with a battery charger, the Start/Stop function should be temporarily deactivated until the battery has been recharged sufficiently. At an ambient temperature of about +15 °C (about 60 °F), the battery must be charged by the vehicle for at least 1 hour. At lower ambient temperatures, the charging time can increase to 3-4 hours. The recommendation is to charge the battery with an external battery charger, if possible.

## 11.1.4. Switching off the vehicle

The vehicle is turned off using the start button.



Location of the start button.

To switch off the vehicle:

- 1 Press the start button.
- The vehicle is switched off.

If the vehicle rolls:

- 1 Press and hold the start button until the vehicle is turned off.

---

## 11.1.5. Ignition modes

The vehicle's ignition can be put in various modes (levels) to make different functions available.

To enable the use of a limited number of functions when the engine is not running, the ignition can be put in one of three different levels: **0**, **I** and **II**. These levels are referred to as "ignition modes" in the Owner's Manual.

The following table shows which functions are available in each ignition mode:

Mode	Functions
0	<ul style="list-style-type: none"><li>• The odometer, clock and temperature gauge are illuminated<sup>[1]</sup>.</li><li>• The power* seats can be adjusted.</li><li>• The center display is activated and can be used<sup>[1]</sup>.</li><li>• The infotainment system can be used<sup>[1]</sup>.</li></ul> <p>In this mode, the functions are available for a limited time and then switch off automatically.</p>
I	<ul style="list-style-type: none"><li>• The panoramic roof, power windows, 12-volt electrical socket in the passenger compartment, Bluetooth, navigation, phone, blower and windshield wipers can be used.</li><li>• The power seats can be adjusted.</li><li>• The 12-volt electrical socket* in the cargo compartment can be used.</li></ul> <p><b>Electrical current will be taken from the battery in this ignition mode.</b></p>
II	<ul style="list-style-type: none"><li>• The headlights illuminate.</li><li>• Warning/indicator lights illuminate for 5 seconds.</li><li>• A number of other systems are activated. However, seat and rear window heating can only be activated when the engine is running.</li></ul> <p><b>This ignition mode uses a lot of current from the battery and should be avoided whenever possible!</b></p>

<sup>[1]</sup> Also activated when the door is opened.

\* Option/accessory.

---

## 11.1.6. Selecting ignition mode

The vehicle's ignition can be put in various modes (levels) to make different functions available.



## Selecting an ignition mode



Location of the start button.

- **Ignition mode 0** – Unlock the vehicle and keep the key in the passenger compartment.

### Note

To set level I or II **without** engine start – do **not** depress the brake pedal when selecting this ignition mode.

- **Ignition mode I** – Press the start button and release.
- **Ignition mode II** – Press the button and hold it in for approx. 5 seconds. Release the button.
- **Back to ignition mode 0** – To return to ignition mode 0 from modes I and II, press the start button.

---

## 11.2. Transmission

### 11.2.1. The kickdown function

Kickdown can be used when maximum acceleration is needed e.g. when passing.

When the accelerator pedal is depressed all the way to the floor (past the normal full accelerator position), the transmission will automatically engage kickdown, i.e. immediately shift down to a lower gear.

If the accelerator pedal is released from the kickdown position, the transmission will automatically shift up again.

#### Safety function

The transmission control module is equipped with a downshift protection feature to help prevent the engine from overheating.

In some conditions, the transmission will prevent downshifting/kickdown if this would lead to such high engine speed (rpm) that the engine could be damaged. If the driver still attempts downshifting or kickdown at a high rpm, nothing will happen and

the original gear will remain selected.

With kickdown, the vehicle can downshift one or more steps at a time depending on the engine speed. The vehicle upshifts when the engine reaches its maximum rpm to prevent engine damage.

---

## 11.2.2. The Launch function\*

Launch can be used to provide maximum acceleration from a standstill.

### Activating Launch

Make sure that the vehicle is stationary and that the wheels are pointing straight ahead.

- 1 Put the gear selector in D position.
- 2 Depress the brake pedal fully.
- 3 Then fully depress the accelerator pedal.
- 4 Release the brake pedal within 2 seconds.

#### Note

If the Launch function does not work, wait a few minutes to let the driveline reach working temperature before trying again.

#### Important

The driveline is exposed to wear when using Launch and the function is therefore only available a limited number of times.

\* Option/accessory.

---

## 11.2.3. Transmission

The transmission is part of the vehicle's driveline (power transmission) between the engine and the drive wheels. The function of the transmission is to change gears depending on speed and power needs.

The vehicle has a seven- or eight-speed automatic transmission. The number of gears allows the engine's torque and power band to be effectively utilized.

**The content of this manual represents the status of the user manual at the time of printing and may not be completely valid in future instances. For more information refer to the first page for the complete disclaimer note.**

Two of the gears are overdrive gears that save fuel when driving at a constant engine speed. The selected gear selector position will be displayed in the instrument panel.

---

## 11.2.4. Gear selector positions

Gear position is selected automatically to make driving as energy efficient as possible. The transmission also has a manual mode.



Overview of gear selector and gear shift pattern in the instrument panel.

The selected gear selector position is displayed in the instrument panel:

P, R, N, D or M.

---

## 11.2.5. Shifting gears with automatic transmission

Change gear position by pushing the spring-loaded gear selector forward or rearward, or to the side for manual shifting.

## Selecting gears

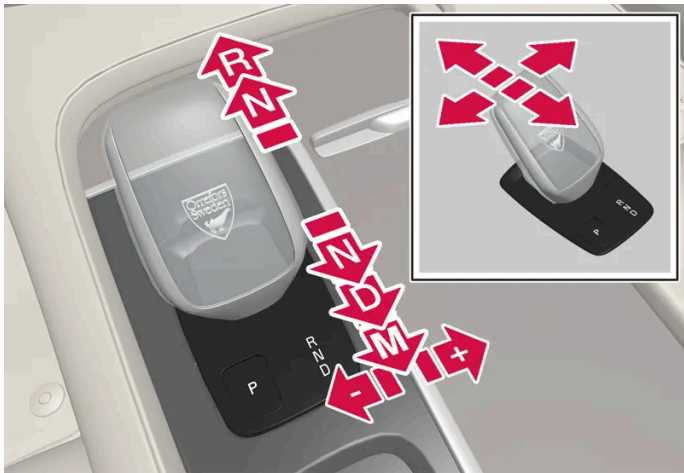

Gear selector and gear selector positions overview.

## Gear selector positions

### Parking – P



Gear selector and P position overview.

Parking is activated using the P button located next to the gear selector.

In the P position, the transmission is mechanically locked.

Select P position when the vehicle is parked. The vehicle can be started when it is in P position. The vehicle must be stationary when P is selected.

When parking – apply the parking brake before shifting to position P.

### **Warning**

Always apply the parking brake when parking on an incline. Selecting a gear or putting the automatic transmission in **P** may not be sufficient to keep the vehicle stationary in all situations.

 **Note**

The gear selector must be in position **P** in order to lock the vehicle and set the alarm.

## Help functions

The system will switch to the **P** position automatically:

- if the ignition is switched off while **D** or **R** is selected and the vehicle is stationary.
- if the vehicle is moving at low speed and the driver unbuckles their seat belt and opens the driver's door without any pedal being depressed.

To park a vehicle with an unbuckled seat belt and open door – end **P** mode by shifting to **R** or **D** again.

If the vehicle is switched off in gear position **N**, it will not automatically switch to the **P** position. This makes it possible to wash the vehicle in an automatic car wash.

### Reverse – **R**

Select **R** when backing up. The vehicle must be stationary when **R** is selected.

### Neutral – **N**

In **N** position, the vehicle can roll freely. The vehicle can be started when it is in **N** position. Apply the parking brake if the vehicle is stationary with the gear selector in the **N** position.

To move to another gear position when **N** is selected, the brake pedal must be depressed and the engine running.

### **D** drive mode

**D** is the normal driving gear position. The transmission shifts up or down automatically depending on acceleration and speed.

The vehicle must be stationary when the gear selector is moved from **R** to **D**.

 **Note**

To facilitate parking and other low-speed maneuvers, the gear selector can be moved between **D** and **R** at very low speeds without depressing the brake pedal.

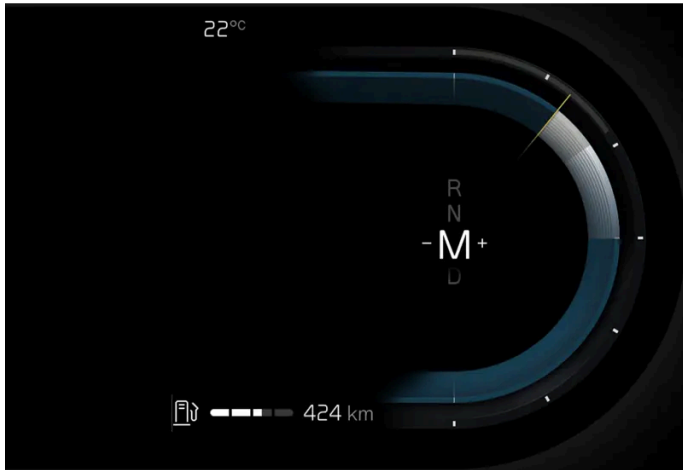

With position M, it is possible to shift gears manually. Engine braking will occur when the accelerator pedal is released.

M position is selected by moving the gear selector rearward from D.

- Push the gear selector to the right toward "+" (plus) and release to shift up one gear.
- Push the gear selector to the left toward "-" (minus) and release to shift down one gear.
- Push the gear selector rearward to return to D mode.



For smooth shifting and engine performance, the transmission will shift down automatically if the vehicle's speed becomes too low for the selected gear.

## 11.2.6. Transmission symbols and messages

If a problem occurs with the transmission, a symbol and a message are displayed in the instrument panel.

### ! Important

Check the operating temperature of the transmission to help avoid damage to any of the drive system components. If there is a risk of overheating, a warning symbol will appear in the instrument panel and a text message will be displayed. Follow the recommendations given.

Symbol	Meaning
	A fault has occurred in the transmission. Read the message in the instrument panel.
	Hot or overheated transmission. Read the message in the instrument panel.
	Temporary fault in driveline. Read the message in the instrument panel.

## 11.2.7. All Wheel Drive (AWD)\*

All-wheel drive (AWD<sup>[1]</sup>), also called four-wheel drive, means that power is distributed to all four wheels, which improves traction.

To achieve the best traction, power is automatically directed to the wheels that have the best grip. The system continuously calculates the need for torque to the rear wheels, and can immediately redistribute up to half of the engine's torque to the rear wheels.

All-wheel drive also has a stabilizing effect at higher speeds. In normal driving conditions, most of the engine's power is directed to the front wheels. When the vehicle is stationary, all-wheel drive is always activated in preparation for maximum traction during acceleration.

All-wheel drive reacts differently depending on which drive mode is selected.

\* Option/accessory.

<sup>[1]</sup> All-wheel drive

---

## 11.2.8. Shiftlock

The automatic transmission's shiftlock function helps prevent inadvertently moving the gear selector between different positions.

### Automatic shiftlock

The automatic shiftlock has a separate safety system.

**From Park – P or Neutral – N**

To move the gear selector from P or N to another gear selector position, the engine must be running, the brake pedal must be depressed and the ignition must be in mode II.

If the gear selector is in N and the vehicle has been stationary for at least 3 seconds (with or without the engine running), the gear selector will be locked in that position.

### Messages in the instrument panel

If the gear selector is locked in position, a message will appear in the instrument panel, e.g. **Press brake pedal to activate gear lever.**

There is no mechanical shiftlock function.<sup>[1]</sup>

<sup>[1]</sup> Applies for vehicles with the small gear selector

---

## 11.3. Brakes

---

### 11.3.1. Foot brake

---

#### 11.3.1.1. Brake Assist System

The brake enhancing system, (BAS<sup>[1]</sup>), helps increase braking force and can thereby reduce braking distance.

The system monitors the driver's braking habits and increases braking force when necessary. Braking force can be increased up to the point at which the ABS intervenes.

 **Note**

When BAS is activated, depress and hold down the brake pedal as long as needed.

<sup>[1]</sup> Brake Assist System

---

#### 11.3.1.2. Braking on salted roads

When driving on salted roads, a layer of salt may form on the brake discs and brake pads.

This could increase stopping distance. Maintain an extra large safety distance to the vehicle ahead. Make sure to also:

- Apply the brakes from time to time to help remove salt. Make sure braking does not pose a risk to any other road users.
  - Gently apply the brakes when you have finished driving and before driving again.
- 

#### 11.3.1.3. Braking on wet roads

Prolonged driving in heavy rain without braking may cause braking effect to be slightly delayed the first time the brakes are applied.

This may also occur after washing the vehicle. It will then be necessary to apply greater pressure to the brake pedal. You should therefore maintain a greater distance to the vehicle ahead.

Firmly apply the brakes after washing the vehicle or driving on wet roads. This helps warm up the brake discs, enabling them to dry more quickly and protecting them against corrosion. Consider the current traffic situation when braking.



---

## 11.3.1.4. Brakes

The brake pedal is used to apply the vehicle's regular brakes, which are part of the brake system.

The vehicle is equipped with two brake circuits. If one brake circuit is damaged, the brake pedal may go down further when depressed. More pressure will then be required from the driver for normal braking effect.

The driver's pressure on the brake pedal is enhanced by a power braking function.



### Warning

Power braking only functions if the vehicle is running.

If the brake pedal is used when the engine is turned off, the pedal will feel stiffer than usual and greater pressure must be applied to brake the vehicle.







In very hilly areas or when driving with a heavy load, engine braking in manual gear should be used to augment the brakes. Engine braking is most effective if the same gear is used both uphill and downhill. Use the **Off-road\*** drive mode to increase the engine braking effect when driving on steep downgrades at low speeds.

### Anti-lock brakes

The vehicle is equipped with an Anti-lock Braking System (ABS<sup>[1]</sup>), which helps prevent the wheels from locking and helps maintain steering control when braking. Vibrations may be felt from the brake pedal when ABS is operating, which is normal.

After the vehicle is started, a brief test of the ABS system is automatically performed when the driver releases the brake pedal. An additional automatic test of the system may be performed when the vehicle is traveling at a low speed. During the test, the brake pedal may feel as though it is pulsating.

### Symbols in the instrument panel

Symbol	Meaning
 [2]  [3]	Check the brake fluid level. If the level is low, fill brake fluid and check to determine the reason for the loss of brake fluid.
 [2]  [3]	Fault in pedal sensor.
 [2]  [3]	Steady glow for 2 seconds after the vehicle is started: Automatic function check. Steady glow for more than 2 seconds: Fault in ABS system. The vehicle's regular brakes will still work, but without the ABS function.
	In the event of the message: <b>Brake pedal characteristics changed Service required</b> The brake pedal must be depressed with greater pressure, past the normal braking position, in order to brake the vehicle.

 **Warning**

If the warning symbols for both brake fault and ABS fault are lit simultaneously, there may be a fault in the brake system.

- If the brake fluid reservoir level is normal when this occurs, drive carefully to the nearest workshop to have the brake system checked - an authorized Volvo workshop is recommended.
- If the brake fluid has fallen below the MIN level in the brake fluid reservoir, the vehicle should not be driven until the brake fluid has been filled. The reason for the brake fluid loss must be checked.

\* Option/accessory.

[1] Anti-lock Braking System

[2] In Canada.

[3] In the US.

## 11.3.1.5. Maintenance of the brake system

Regularly check the brake system components for wear.

To keep the vehicle as safe and reliable as possible, follow the Volvo service schedule specified in the Warranty and Maintenance Records Information booklet. After replacing brake pads and brake discs, braking effect is not adapted until they

The content of this manual represents the status of the user manual at the time of printing and may not be completely valid in future instances. For more information refer to the first page for the complete disclaimer note.

are "broken in" by driving a few hundred kilometers (miles). Compensate for the reduced braking effect by applying greater pressure to the brake pedal. Volvo recommends only using brake pads approved for your Volvo.

**!** Important

The brake system's components should be regularly checked for wear.

Contact a workshop for advice on how to do this or let a workshop perform the inspection - an authorized Volvo workshop is recommended.

---

## 11.3.2. Parking brake

---

### 11.3.2.1. Parking brake

The parking brake helps keep the vehicle stationary by mechanically locking the rear wheels.



The parking brake controls are located in the tunnel console between the seats.

When the electric parking brake is being applied, a faint sound can be heard from the brake's electric motor. This sound can also be heard during the automatic function check of the parking brake.

If the vehicle is stationary when the parking brake is activated, it will only be applied to the rear wheels. If it is activated while the vehicle is moving, the normal brakes will be used on all four wheels. Braking will be transferred to only the rear wheels when the vehicle is almost stopped.

---

### 11.3.2.2. Activating and deactivating the parking brake



Use the parking brake to help keep the vehicle stationary when it is parked.

## Activating the parking brake



- 1 Pull up the control.
  - The symbol in the instrument panel will illuminate when the parking brake is activated.
- 2 Make sure the vehicle is stationary.

### Symbol in the instrument panel

Symbol	Meaning
 [1]	The symbol will be illuminated when the parking brake is activated. A flashing symbol indicates that a fault has been detected. Read the message in the instrument panel.
 [2]	

### Automatic activation

The parking brake is applied automatically

- when the gear selector is moved to P on a steep hill.
- if automatic brake when stationary (Auto Hold) is activated and
  - the vehicle has been stationary for a prolonged period of time (5-10 minutes).
  - the vehicle is switched off.
  - the driver has left the vehicle.

### Emergency braking

In an emergency, the parking brake can be activated when the vehicle is moving by pulling and holding up the control. The brakes will then be applied with force in order to brake the vehicle. The braking process is canceled when the control is released or if the accelerator pedal is depressed.

**i Note**

In case of emergency braking at high speeds, a signal sounds during the brake procedure.

## Deactivating the parking brake



### Deactivating manually

The parking brake can only be deactivated if the engine is running.

- 1 Depress the brake pedal firmly.
  - 2 Press the control down.
- The parking brake will release and the symbol in the instrument panel will go out.

### Deactivating automatically

- 1 Start the vehicle.
  - 2 Depress the brake pedal firmly. Choose gear selector position N, D or R and depress the accelerator pedal.
- The parking brake will release and the symbol in the instrument panel will go out.

**i Note**

For automatic deactivation to be possible, the driver's seat belt must be buckled or the driver's door closed.

[1] Canadian models.

## 11.3.2.3. Parking on a hill

Always activate the parking brake when parking on a hill.

 **Warning**

Always apply the parking brake when parking on an incline. Selecting a gear or putting the automatic transmission in **P** may not be sufficient to keep the vehicle stationary in all situations.

If the vehicle is pointing uphill:

- Turn the front wheels so they are pointing **away from** the curb.

If the vehicle is pointing downhill:

- Turn the front wheels so they are pointing **toward** the curb.

### Heavy load uphill

Heavy loads, such as a trailer, could cause the vehicle to roll backward when the parking brake is released automatically on steep uphill gradients. To help avoid this, pull the control upward while you are driving away. Release the control when the vehicle gains traction.

---

## 11.3.2.4. Parking brake malfunction

If you are unable to deactivate or activate the parking brake after several attempts, contact an authorized Volvo workshop.

A audible warning signal will sound if the parking brake is activated while the vehicle is being driven.

If the vehicle must be parked before the problem is rectified, turn the wheels as when parking on an incline and put the gear selector in P.





### Low battery charge level

If the battery charge level is too low, it will not be possible to activate or deactivate the parking brake. Connect an auxiliary battery to the vehicle if the battery is discharged.

### Replacing brake pads

Due to the design of the electric parking brake, the rear brake pads must be replaced by a workshop. An authorized Volvo workshop is recommended.

## Symbols in the instrument panel

Symbol	Meaning
 [1]	A flashing symbol indicates that a fault has been detected. See the message in the instrument panel.
 [2]	
 [1]	Fault in the brake system. See the message in the instrument panel.
 [2]	
	Information message in the instrument panel.

[1] Canadian models.

[2] US models.

## 11.3.3. Brake fluid specifications

The medium in the hydraulic brake system is called brake fluid and is used to transfer pressure from e.g. a brake pedal via a master brake cylinder, which in turn actuates the brake calipers.

**Recommended grade:** Volvo Original or similar fluid that meets a combination of Dot 4, 5.1 and ISO 4925 class 6.

 **Note**

Changing or filling brake fluid should be entrusted to an authorized Volvo workshop.

---

## 11.3.4. Brake functions

The vehicle's brakes are used to reduce speed or prevent the vehicle from rolling.

In addition to the wheel brakes and parking brakes, the vehicle is also equipped with a number of automatic brake assist functions. These systems provide assistance by e.g. the driver not needing to depress the brake pedal at a traffic light or when starting up a hill.

Depending on how the vehicle is equipped, the following brake assist functions may be included:

- Auto-hold brake function at a standstill (Auto hold)
- Hill Start Assist (Hill Start Assist)
- Braking assist after a collision
- Regenerative braking
- Warning and auto-braking while backing up
- Assistance at risk of collision
- Off-road mode
- Hill Descent Control (Hill Descent Control) \*

\* Option/accessory.

---

## 11.3.5. Auto-hold brakes

With the Auto-hold brake function, the driver can release the brake pedal and the brakes will remain applied, for example, when the vehicle has stopped at a traffic light or intersection.

When the vehicle stops, the brakes are activated automatically. The function can use either the normal brakes or the parking brakes to keep the vehicle stationary and works on flat surfaces or hills. If the driver has their seat belt fastened and/or if the driver's door is closed, the brakes will disengage automatically when the vehicle starts driving.



 **Note**



When braking to a stop on an uphill or downhill gradient, depress the brake pedal with slightly more force than usual before releasing to ensure that the vehicle cannot move at all.

The parking brake is applied automatically

- if the vehicle is switched off
- when the driver removes their seat belt and/or opens the driver's door.
- if the Auto hold (automatic braking at a standstill) function is activated and the vehicle has been stationary for a long period of time (about 5-10 minutes).

Auto hold can also switch over to the parking brake in other situations.

## Symbols in the instrument panel

Symbol	Meaning
	This symbol illuminates when the function is using the normal brakes to keep the vehicle stationary. Note that the normal brakes may be active even if the symbol is not illuminated.
 <small>[1]</small>	This symbol illuminates when the function is using the parking brake to keep the vehicle stationary.
 <small>[2]</small>	

[1] Canadian models.

[2] US models.

---

## 11.3.6. Activating and deactivating Auto-hold at a standstill

The Auto-hold brake function at a standstill is activated with the button in the tunnel console.



- 1 Press the button in the tunnel console to activate or deactivate the function.
  - > The indicator light in the button will illuminate when the function is activated. The function will remain active the next time the vehicle is started.

## When shutting off



If the function is active and holding the vehicle stationary using the normal brakes (A symbol lit in the instrument panel), the brake pedal must be depressed while pressing the button in order to deactivate Auto-hold.

- The function will remain off until it is reactivated.
- When the function is switched off, brake assist will remain active to help prevent the vehicle from rolling backward when starting up a hill.

---

## 11.3.7. Braking assist after a collision

In a collision in which the activation level is reached for the pyrotechnic seat belt tensioners or airbags, or if a collision with a large animal is detected, the vehicle's brakes will be automatically activated. This function is intended to help prevent or reduce the effects of any subsequent collision.

After a serious collision, it may no longer be possible to control and steer the vehicle. In order to avoid or mitigate a possible further collision with a vehicle or an object in the vehicle's path, the brake assist system is activated automatically to help stop the vehicle safely.

The brake lights and hazard warning flashers are activated during braking. When the vehicle has stopped, the hazard warning flashers will continue to flash and the parking brake will be applied.

If braking is not appropriate, e.g. if there is a risk of being hit by passing traffic, the driver can override the system by depressing the accelerator pedal.

This function assumes that the brake system is intact after a collision.

---

## 11.3.8. Regenerative braking\*

The vehicle recovers kinetic energy during braking in order to reduce fuel consumption and emissions.

The function is available in all drive modes together with gear selector position D or M.

### Regeneration using the brake pedal

- 1 Depress the brake pedal.
  - > The vehicle brakes and regenerates energy.

### Symbols in the instrument panel



If the vehicle is a mild hybrid, a battery symbol is shown on the right in the instrument panel.

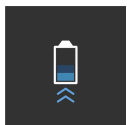

When the battery is charging, for example during regenerative braking, this is indicated by means of this symbol.

\* Option/accessory.

---

## 11.4. Drive modes

---

### 11.4.1. Regenerative braking\*

The vehicle recovers kinetic energy during braking in order to reduce fuel consumption and emissions.

The function is available in all drive modes together with gear selector position D or M.

### Regeneration using the brake pedal

The content of this manual represents the status of the user manual at the time of printing and may not be completely valid in future instances. For more information refer to the first page for the complete disclaimer note.

1 Depress the brake pedal.

> The vehicle brakes and regenerates energy.

#### Symbols in the instrument panel



If the vehicle is a mild hybrid, a battery symbol is shown on the right in the instrument panel.



When the battery is charging, for example during regenerative braking, this is indicated by means of this symbol.

\* Option/accessory.

---

## 11.4.2. Drive modes \*

Adapt the drive mode to the vehicle's current driving situation.

### Available drive modes

Each drive mode is adapted to help optimize driving characteristics in terms of:

- steering
- engine/transmission/all-wheel drive
- brakes
- pneumatic suspension \* and shock absorbers
- instrument panel
- the Start/Stop function
- climate control settings.

## Indication in the instrument panel

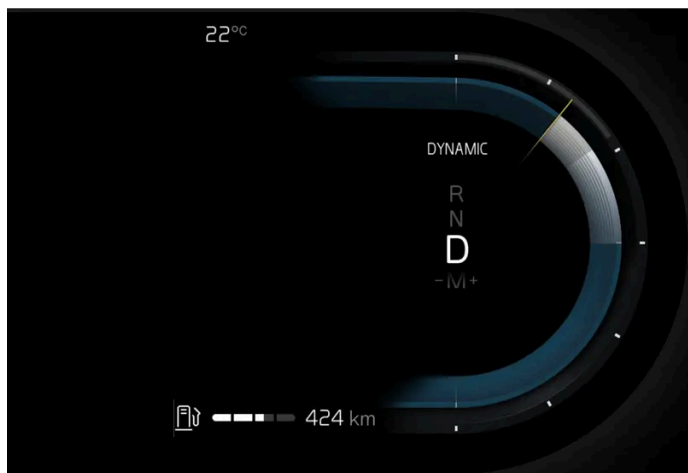

The illustration is generic

The selected drive mode is indicated in the instrument panel.

## Comfort

The vehicle starts in **Comfort** mode. This setting offers driving comfort, light steering and soft suspension. This drive mode is certified for carbon dioxide emissions.

Volvo recommends using **Comfort** mode when driving on freeways, highways, etc.

### To keep in mind when using Comfort mode

- the Start/Stop function is activated at start.

## Polestar Engineered<sup>[1]</sup>

In **Polestar Engineered** mode, gear shifting is faster and more distinct and the transmission prioritizes gears with a higher traction force. Steering response is faster and suspension is stiffer.

Volvo recommends **Polestar Engineered** mode when sportier driving characteristics and faster acceleration response are desired.

### To keep in mind when using Polestar Engineered mode

- ground clearance is lower to reduce body roll when cornering
- the Start/Stop function is deactivated.

## Off-road

In **Off-road** mode, steering is light and all-wheel drive\* and the low-speed function with assistance for driving downhill (Hill Descent Control) are activated.

Volvo recommends using **Off-road** mode when increased traction is desired and when driving in difficult terrain or on poor roads.

### To keep in mind when using Off-road mode

- the Start/Stop function is deactivated
- ground clearance is higher<sup>[2]</sup>
- this drive mode is only available at low speeds
- fuel consumption may increase

 **Note**

This drive mode is not designed to be used for normal street driving.

 **Note**

Due to the increased ground clearance, if the **Off-road** mode was selected when the engine was switched off, the suspension will lower when the engine is restarted.

 **Important**

Do not use the **Off-road** drive mode when towing a trailer without an electrical connection. This could result in damage to the pneumatic suspension system's bellows.

\* Option/accessory.

<sup>[1]</sup> Only available in certain markets.

<sup>[2]</sup> Only vehicles equipped with pneumatic suspension

## 11.4.3. Changing drive mode\*

Select the drive mode that is adapted to the current driving conditions.

Keep in mind that not all drive modes are available in all situations.

Change drive mode in the center display.

- 1 Tap .
- 2 Select **Driving**.
- 3 Select a drive mode.

\* Option/accessory.

---

## 11.4.4. Off-road mode

An adapted mode for low speeds that improves the vehicle's traction and handling in difficult terrain and on steep gradients and poor roads.

Drive mode **Off-road** gives a high ground clearance\*, light steering, extended four wheel drive\* as well as activated low speed function with downhill assistance. This gives increased engine braking that makes it possible to increase or reduce the vehicle's speed on steep gradients with only the accelerator pedal, without using the normal brakes.

The speed is regulated using the accelerator pedal. When the accelerator pedal is released, the vehicle brakes to a very low speed regardless of how steep the hill is and without the brakes needing to be applied.

The brake lights illuminate when the vehicle is braking/speed is reduced. The driver can also depress the brake pedal to reduce creep speed or to stop the vehicle.

Keep in mind that:

- The mode is only available at low speeds, up to 40 km/h (25 mph). If this speed is exceeded, Off-road drive mode switches off.

### Note

Off-road mode is not designed to be used for normal street driving.

## Activating or deactivating Off-road

- 1 Tap  in the center display.
- 2 Select **Driving**.
- 3 Activate or deactivate **Off-road mode**.

The function is deactivated when the vehicle is switched off.

\* Option/accessory.

---

## 11.4.5. The Launch function\*

The content of this manual represents the status of the user manual at the time of printing and may not be completely valid in future instances. For more information refer to the first page for the complete disclaimer note.

Launch can be used to provide maximum acceleration from a standstill.

## Activating Launch

Make sure that the vehicle is stationary and that the wheels are pointing straight ahead.

- 1 Put the gear selector in D position.
- 2 Depress the brake pedal fully.
- 3 Then fully depress the accelerator pedal.
- 4 Release the brake pedal within 2 seconds.

### Note

If the Launch function does not work, wait a few minutes to let the driveline reach working temperature before trying again.

### Important

The driveline is exposed to wear when using Launch and the function is therefore only available a limited number of times.

\* Option/accessory.

---

## 11.4.6. All Wheel Drive (AWD)\*

All-wheel drive (AWD<sup>[1]</sup>), also called four-wheel drive, means that power is distributed to all four wheels, which improves traction.

To achieve the best traction, power is automatically directed to the wheels that have the best grip. The system continuously calculates the need for torque to the rear wheels, and can immediately redistribute up to half of the engine's torque to the rear wheels.

All-wheel drive also has a stabilizing effect at higher speeds. In normal driving conditions, most of the engine's power is directed to the front wheels. When the vehicle is stationary, all-wheel drive is always activated in preparation for maximum traction during acceleration.

All-wheel drive reacts differently depending on which drive mode is selected.

\* Option/accessory.

The content of this manual represents the status of the user manual at the time of printing and may not be completely valid in future instances. For more information refer to the first page for the complete disclaimer note.



## 11.5. Start/stop function

---

### 11.5.1. Start/Stop function

Start/Stop is a function that temporarily switches off the engine when the vehicle has stopped, e.g. at a traffic light or in heavy traffic, and then starts it again automatically when needed.

The Start/Stop function reduces fuel consumption, which can in turn contribute to an environmentally conscious driving style and reduced emissions.

#### To keep in mind when using the Start/Stop function

Certain conditions must be met for Start/Stop to function.

##### The Start/Stop function is not activated

The engine may not switch off/the function may not be activated due to one or more of the following criteria:

- the driver has not fastened their seat belt
- the vehicle has not reached a speed of about 10 km/h (6 mph) after start or after the function has been activated a number of times in succession
- the engine has not reached its normal operating temperature
- windshield heating is activated
- the climate system settings and the actual climate in the passenger compartment differ
- the driver is making large steering wheel movements
- the road gradient is very steep
- the hood is open
- ABS has been activated
- hard braking (even if the ABS system has not been activated)
- the start battery's charge has dropped below the minimum level
- many starts during a short period of time have triggered the starter motor's overheating protection
- the exhaust system's particulate filter is full
- a trailer is connected to the vehicle's electrical system.

 **Note**

High electrical current consumption may cause the battery capacity to drop below the minimum permitted level, which will temporarily limit the Start/Stop function. The engine will then start automatically without the driver lifting their foot from the brake pedal.

**The Start/Stop function is not deactivated**

The engine may not start/the function may not be deactivated due to one or more of the following criteria:

- the driver has not fastened their seat belt
- gear selector position P is engaged and the driver's door is open.

**The Start/Stop function is deactivated without the brake pedal being released**

The function may be deactivated and the engine may start without the driver releasing the brake pedal in the following cases:

- high levels of condensation on the inside of the windows
- the climate system settings and the actual climate in the passenger compartment differ
- the brake pedal is pumped repeatedly
- the hood is open
- the start battery's charge has dropped below the minimum level
  
- the driver's seat belt is unbuckled and the gear selector is in position D or N
- the gear selector is moved from position D to R or M
- the driver's door is open with the gear selector in position D.

 **Warning**

Do not open the hood when the Start/Stop function is active. Switch off the engine normally before raising the hood.

## 11.5.2. Activating and deactivating the Start/Stop function

The Start/Stop function is available when the vehicle is started. When the function is activated, the engine is temporarily switched off. The engine then starts automatically when the function is deactivated or when the vehicle requires this.

## Activating the Start/Stop function

- 1 Depress the brake pedal and hold it down.
  - The Start/Stop function is activated and the engine switches off.

### Note

- In some cases, the Start/Stop function can be activated before the vehicle is completely stationary.
- When Adaptive Cruise Control or Pilot Assist is activated, the Start/Stop function is activated a few seconds after the vehicle is completely stationary.

### Note

All of the vehicle's ordinary systems, such as lighting and radio, function normally even when the Start/Stop function is activated.

However, the function of certain equipment may be temporarily reduced, such as the climate system's blower speed or the volume of the speakers.

## Deactivating the Start/Stop function

- 1 Release the brake pedal or lightly press the accelerator pedal.
  - The Start/Stop function is deactivated and the engine starts.



### Note

When the Start/Stop function is deactivated and:

- the automatic brakes at standstill function (Auto hold) is activated, the engine will not start until the accelerator pedal is depressed
- Adaptive Cruise Control or Pilot Assist is activated, the engine will start when the accelerator pedal is depressed or the  button on the steering wheel's left-side keypad is pressed
- the vehicle is on an uphill gradient, HSA<sup>[1]</sup> will activate to help prevent the vehicle from rolling backward
- the vehicle is on a downhill gradient, release the brake pedal slightly. A slight increase in speed starts the engine.

## Symbols in the instrument panel

The tachometer in the instrument panel indicates when the Start/Stop function is: available, active or not available.

Symbol	Meaning
	White – the function is available.
	Green – the function is activated.
	Gray – the function is not available.

If no symbol is shown in the instrument panel, the function is switched off.

<sup>[1]</sup> Hill Start Assist

---

## 11.6. Driving recommendations

---

### 11.6.1. Towing using a towline

This section refers to one vehicle being towed behind another using a towline.

Before towing another vehicle, check applicable speed limit regulations.

 **Important**

Vehicles with the seven-gear transmission should never be towed behind another vehicle. They must instead be transported with all wheels raised on the bed of a tow truck. Contact a Volvo retailer to determine what applies for your vehicle.

### Preparations and towing

 **Important**

For some transmission variants, it is not possible to shift from P position if the engine is switched off. Contact an authorized Volvo workshop for assistance towing or call a professional towing service.

 **Important**

Note that the vehicle must always be towed with the wheels rolling forward.

- Do not tow a vehicle with automatic transmission at a speed greater than 80 km/h (50 mph) or for a distance greater than 80 km (50 miles).
- Vehicles with the seven-gear transmission should never be towed behind another vehicle. They must instead be transported with all wheels raised on the bed of a tow truck.

 **Warning**

- Ignition mode II must be active – all airbags are deactivated in ignition mode I.
- Always have the key in the vehicle when it is towed.

 **Warning**

The brake and steering servos do not work when the engine is off – it takes about 5 times more pressure on the brake pedal and steering requires much more effort than normal.

- 1 Turn on the hazard warning flashers.
  - 2 Attach the towline to the towing eyelet.
  - 3 Put the vehicle in ignition mode II – without pressing the brake pedal, press and hold the start button for about 4 seconds. Release the button.
  - 4 Move the gear selector to neutral (N) and release the parking brake.  
If the battery charge level is too low, it may not be possible to release the parking brake. Connect an auxiliary battery to the vehicle if the battery is discharged.
- The towing vehicle can now start driving.
- 5 Keep the towline taut when the towing vehicle slows down by applying light pressure to the brake pedal. This will help avoid jarring movements.
  - 6 Be prepared to apply the brakes to stop the vehicle.

## Jump starting

Do not tow the vehicle to start the engine. Use an auxiliary battery if the start battery's charge level is so low that the engine cannot be started.

## 11.6.2. Braking on salted roads

When driving on salted roads, a layer of salt may form on the brake discs and brake pads.

This could increase stopping distance. Maintain an extra large safety distance to the vehicle ahead. Make sure to also:

- Apply the brakes from time to time to help remove salt. Make sure braking does not pose a risk to any other road users.
- Gently apply the brakes when you have finished driving and before driving again.

---

## 11.6.3. Braking on wet roads

Prolonged driving in heavy rain without braking may cause braking effect to be slightly delayed the first time the brakes are applied.

This may also occur after washing the vehicle. It will then be necessary to apply greater pressure to the brake pedal. You should therefore maintain a greater distance to the vehicle ahead.

Firmly apply the brakes after washing the vehicle or driving on wet roads. This helps warm up the brake discs, enabling them to dry more quickly and protecting them against corrosion. Consider the current traffic situation when braking.

---

## 11.6.4. Parking on a hill

Always activate the parking brake when parking on a hill.



### Warning

Always apply the parking brake when parking on an incline. Selecting a gear or putting the automatic transmission in **P** may not be sufficient to keep the vehicle stationary in all situations.

If the vehicle is pointing uphill:

- Turn the front wheels so they are pointing **away from** the curb.

If the vehicle is pointing downhill:

- Turn the front wheels so they are pointing **toward** the curb.

### Heavy load uphill

Heavy loads, such as a trailer, could cause the vehicle to roll backward when the parking brake is released automatically on steep uphill gradients. To help avoid this, pull the control upward while you are driving away. Release the control when the vehicle gains traction.

## 11.6.5. Service stations

You can use the vehicle's navigation system\* to find a route to the nearest service station.

While you are stopped to refuel, it can be a good idea to perform a quick inspection of the vehicle, such as checking tire pressure, lights, wiper blades, filling washer fluid, etc.

\* Option/accessory.

---

## 11.6.6. Preparing for a long trip

It is important to have the vehicle's systems and equipment checked carefully before driving long distances.

Check that

- the engine is running properly and that fuel consumption is normal
  - there are no leaks (fuel, oil or other fluid)
  - the brake pedal is functioning properly
  - all lights work
  - tire tread depth and air pressure are at correct levels. Change to snow tires when driving in areas where there is a risk of snowy or icy roads
  - the start battery is sufficiently charged
  - the wiper blades are in good condition
- 

## 11.6.7. Battery drain

Using a lot of electrical current without allowing the vehicle to charge the start battery results in a low battery level and some electrical functions will be reduced or switched off. If the battery level drops below a certain level, it will no longer be possible to start the vehicle without jump-starting or charging of the start battery with an external charger.

Several measures can be taken to reduce power consumption. Avoid using ignition mode II when the engine is switched off. Instead, use ignition mode I, which uses less electrical current. Do not use functions that use a lot of electrical current when the vehicle is not being driven. Examples of such functions are:

- blower
- headlights
- windshield wipers
- audio system
- accessories plugged into the vehicle.

If the battery level is low, a message is shown in the instrument panel. The vehicle's energy-saving function will then turn off or reduce certain functions, such as the blower and the audio system.

- 1 Charge the start battery by starting the vehicle and letting it run for at least 15 minutes. The start battery is charged more effectively while driving than while idling.

If the battery level is still low after taking these measures, the vehicle should be checked by a workshop – an authorized Volvo workshop is recommended.

 **Note**

High current consumption can lead to low battery level, which temporarily limits the start/stop function. The engine can then start automatically during a stop to charge the battery.

## 11.6.8. Driving through standing water

It may be necessary to drive the vehicle through standing water e.g. deep puddles or flooding on the road. This must be done with great caution.

### When driving through standing water

To help prevent damage to the vehicle when driving through water:

- The vehicle can be driven through water up to a depth of 45 cm (17 in).
- Do not drive faster than walking speed.
- Do not stop the vehicle in the water. Drive carefully forward or back the vehicle out of the water.
- Be particularly careful when driving through flowing water.
- Do not allow the vehicle to stand in water up to the sills any longer than absolutely necessary. This could result in electrical malfunctions.

 **Important**

- Engine damage could occur if water enters the air cleaner.
- If water enters the transmission, the lubricating ability of the oils is reduced and the service life of these systems is shortened.
- Damage to any component, engine, transmission, turbocharger, differential or its internal components caused by flooding, vapor lock or insufficient oil is not covered under warranty.
- If the engine stalls while the vehicle is in water, do not attempt to restart it. Have the vehicle towed out of the water to a workshop. An authorized Volvo workshop is recommended. Risk of engine failure.



 **Important**

Because it can be difficult to determine the water depth, Volvo recommends not driving through standing or running water. The driver is always responsible for operating the vehicle in a safe manner and adhering to all applicable laws and regulations.

**After driving through standing water**

When you have passed the water, press lightly on the brake pedal and check that the brakes are functioning properly. Water, mud, slush, etc. can make the brake linings slippery, resulting in delayed braking effect.

If the vehicle is equipped with contacts for an electric heater or trailer coupling, clean these after driving in water or mud.

---

## 11.6.9. Winter driving

It is important to check the vehicle before driving in cold/snowy conditions to make sure it can be driven safely.

Before the cold season arrives:

- Make sure the engine coolant contains 50% antifreeze. This mixture helps protect the engine from frost erosion down to approx.  $-35^{\circ}\text{C}$  ( $-31^{\circ}\text{F}$ ). Do not mix different types of antifreeze as this could pose a health risk.
- Keep the fuel tank well filled to prevent condensation from forming.
- Check the viscosity of the engine oil. Oil with low viscosity (thinner oil) improves cold-weather starting and reduces fuel consumption when driving with a cold engine.
- Check the condition and charge level of the start battery. Cold weather places greater demands on the start battery and reduces its capacity.
- Check the condition and charge level of the battery. Cold weather places greater demands on the battery and reduces its capacity.
- Use washer fluid containing antifreeze to help prevent ice from forming in the washer fluid reservoir.

See separate section for engine oil recommendations.

### Slippery driving conditions

To help optimize traction and roadholding, Volvo recommends using snow tires on all wheels whenever there is a risk of snow or ice on the road.

 **Note**

Certain countries require use of winter tires by law. Not all countries permit the use of studded tires.

Practice driving on slippery surfaces under controlled conditions to learn how the vehicle reacts.

---

## 11.6.10. Overheating of engine and transmission



In certain driving conditions, such as driving in mountainous areas or hot weather, there is an increased risk of the engine or drive system overheating, especially when carrying heavy loads.

- Engine power may be temporarily limited.
- Remove any auxiliary lights mounted in front of the grille when driving in hot weather.
- If the temperature in the engine's cooling system becomes too high, a warning symbol will appear in the instrument panel along with the message **Stop safely High engine temperature**. Pull over to a safe location and let the engine idle for a few minutes to cool down.
- If the message **Turn off engine High engine temperature** or **Turn off engine Coolant level low** is displayed, stop the vehicle and turn off the engine.
- If the transmission becomes overheated, an integrated safety function is activated. A warning symbol illuminates and the instrument panel displays the message **Reduce speed to lower temperature Transmission warm** or **Stop safely Transmission hot Wait for cooling**. Follow the recommendations given by reducing speed or stopping the vehicle safely and letting the engine idle for a few minutes to let the transmission cool.
- If the vehicle begins to overheat, the air conditioning may be temporarily switched off.
- After a prolonged period of driving in demanding conditions, do not turn off the engine immediately after stopping.

 **Note**

It is normal for the engine's cooling fan to operate for a short time after the engine is switched off.

## Symbols in the instrument panel

Symbol	Meaning
	High engine temperature. Follow the recommendations provided.
	Low coolant level. Follow the recommendations provided.
	Transmission hot/overheated/cooling. Follow the recommendations provided.

---

## 11.7. Trailer hitch and trailer

### 11.7.1. Towing capacity and tongue weight

Towing capacity and tongue weight are shown in the table.

The content of this manual represents the status of the user manual at the time of printing and may not be completely valid in future instances. For more information refer to the first page for the complete disclaimer note.

Category		USA (lbs)	Canada (kg)
Max. trailer weights	Without brakes:	1650	750
	With brakes:	3500	1600
Max. tongue weight	–	350	160

**! Important**

- The maximum trailer weights listed are only applicable for altitudes up to 3280 ft (1,000 m) above sea level. With increasing altitude the engine power and therefore the car's climbing ability are impaired because of the reduced air density, so the maximum trailer weight has to be reduced accordingly. The weight of the car and trailer must be reduced by 10% for every further 3280 ft (1,000 m) (or part thereof).

## 11.7.2. Towbar hitch <sup>[1]</sup> \*

Volvo recommends the use of Volvo towbars that are specially designed for the vehicle.

**i Note**

The optional detachable trailer hitch may not be available in all markets or on all models. Consult your Volvo retailer.

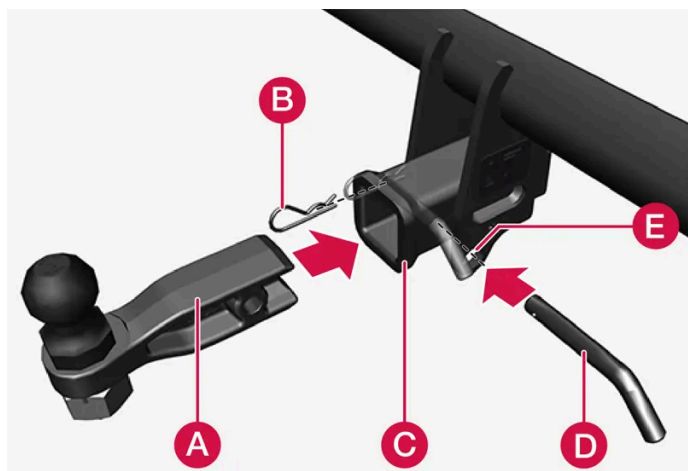

- A** Ball holder
- B** Cotter pin
- C** Towbar assembly
- D** Locking bolt
- E** Safety wire attachment bracket

### Installing the ball holder

- 1 If necessary, remove the cotter pin from the locking bolt and slide the locking bolt out of the towbar assembly.
- 2 Slide the ball holder into the towbar assembly.
- 3 Align the hole in the ball holder with the one in the towbar assembly.
- 4 Slide the locking bolt through the towbar assembly/ball holder.
- 5 Insert the cotter pin in the hole at the end of the locking bolt.

 **Warning**

- Be sure the towbar is securely locked in position before attaching anything to it.
- Always attach the trailer's safety wire securely to the towbar's safety wire attachment bracket.

## Removing the ball holder

- 1 Remove the cotter pin from the locking bolt and slide the locking bolt out of the ball holder/towbar assembly.
- 2 Pull the ball holder out of the towbar assembly.

## Stowing the ball holder

 **Warning**

When not in use, the detachable ball holder should always be properly stowed in the designated location under the floor of the cargo compartment.

[1] The following markets only: USA, Canada, Chile, Mexico, Peru, Puerto Rico, Australia and New Zealand.

\* Option/accessory.

---

## 11.7.3. Driving with a trailer

There are a number of things to consider when towing a trailer, such as the towbar, the trailer and how the load is distributed in the trailer.

Load-carrying capacity is determined by the vehicle's curb weight. The total weight of all passengers and any installed accessories, e.g. towbar, reduces the vehicle's load-carrying capacity by the corresponding amount.

The content of this manual represents the status of the user manual at the time of printing and may not be completely valid in future instances. For more information refer to the first page for the complete disclaimer note.

- Towbars used on the vehicle must be approved for the applicable use.
- Distribute the load on the trailer so that the weight on the towbar complies with the specified maximum towball weight. The tongue weight is calculated as part of the vehicle's payload.
- Increase the tire pressure to the recommended pressure for a full load.
- The engine is subjected to more load than usual when towing a trailer.
- Towing a trailer affects the vehicle's handling, durability and driving economy.
- Do not drive with a heavy trailer when the vehicle is very new. Wait until the mileage has reached at least 1000 km (620 miles).
- Follow applicable regulations regarding permitted speed and weight.
- Drive slowly when towing a trailer up a long and steep incline.
- The maximum trailer weights given only apply to altitudes up to 1000 meters (3280 feet) above sea level. At higher altitudes, engine power (and thus the vehicle's climbing ability) is decreased due to the reduced air density, and the maximum trailer weight must therefore be reduced. The weight of the vehicle and trailer must be decreased by 10% for each additional 1000 m (3280 feet) or part thereof.
- Avoid driving with a trailer on inclines of more than 12%.
- Avoid overloading and other incorrect use.
- The trailer's brakes must be balanced with the vehicle's brakes to help ensure safe stops (follow applicable local regulations).
- Rear Auto Brake should be deactivated before driving with a trailer.

#### Important

- Bumper-attached trailer hitches must not be used on Volvos, nor should safety chains be attached to the bumper.
- Trailer hitches attaching to the vehicle rear axle must not be used.
- Never connect a trailer's hydraulic brake system directly to the vehicle brake system, nor a trailer's lighting system directly to the vehicle lighting system. Consult your nearest authorized Volvo retailer for correct installation.
- When towing a trailer, the trailer's safety chains or wire must be correctly fastened to the attachment points provided in the trailer hitch on the vehicle. The safety chain or wire must never be fastened to or wound around the towing ball.

#### Note

The optional detachable trailer hitch may not be available in all markets or on all models. Consult your Volvo retailer.

#### Note

Extreme weather conditions, towing a trailer, high altitude and lower fuel grade than recommended are factors that can significantly increase the vehicle's fuel consumption.

## Trailer weights

The content of this manual represents the status of the user manual at the time of printing and may not be completely valid in future instances. For more information refer to the first page for the complete disclaimer note.

 **Warning**

Please adhere to the recommendations provided for trailer weight. If the recommendations are not followed, the vehicle and trailer may be difficult to control during evasive maneuvers and braking.

 **Note**

The specified maximum trailer weights are those permitted by Volvo. National vehicle regulations may set additional restrictions on trailer weight and speed. The trailer hitches may be certified for higher towing weights than the vehicle is permitted to tow.

## Self-leveling suspension \*

The vehicle's self-leveling system attempts to keep the vehicle at a constant level, regardless of load (up to the maximum permitted weight). When the vehicle is stationary, the rear end of the vehicle will be slightly lowered, which is normal.

## Driving in mountainous areas

In certain conditions, there is a risk of overheating when driving with a trailer. If overheating of the engine and drive system is detected, a warning symbol will illuminate in the instrument panel and a message will appear.

The automatic transmission adapts the gear for the current load and engine speed.

### Steep inclines

Do not lock the automatic transmission into a higher gear than what the engine can handle – it is not always preferable to drive in high gears at low rpm.

### Parking on a hill

- 1 Depress the brake pedal.
- 2 Apply the parking brake.
- 3 Release the brake pedal.

Put chocks behind the wheels when the vehicle is parked on a hill with a trailer attached.

### Starting on a hill

- 1 Depress the brake pedal.
- 2 Put the gear selector in D.
- 3 Release the parking brake.

4 Release the brake pedal and start driving.

\* Option/accessory.

---

## 11.7.4. Trailer Stability Assist\*

Trailer Stability Assist (TSA<sup>[1]</sup>) is part of the ESC<sup>[2]</sup> stability system and is a function designed to help stabilize a vehicle that is towing a trailer when the vehicle and trailer have begun to sway. The function is added when installing a towbar. Contact a Volvo retailer for more information.

### Reasons for swaying

A vehicle towing a trailer may begin to sway for various reasons. Normally this only occurs at high speeds. However, if the trailer is overloaded or unevenly distributed, e.g. too far back, there is a risk of swaying even at low speeds.

Swaying may be caused by factors such as:

- The vehicle and trailer are hit by a sudden, strong crosswind.
- The vehicle and trailer are traveling on an uneven road or over a bump.
- Sudden movements of the steering wheel.

Once swaying has begun, it can be difficult or impossible to stop it. This makes the vehicle and trailer difficult to control and there is a risk of swerving into oncoming traffic or driving off the road.

### Trailer Stability Assist function

Trailer Stability Assist continuously monitors the vehicle's movements, particularly lateral movements. If swaying is detected, the brakes are applied individually on the front wheels, which has a stabilizing effect on the vehicle and trailer. This is often enough to enable the driver to regain control of the vehicle.

If the Trailer Stability Assist function's first attempt is not adequate to stop the swaying motion, the brakes are applied on all wheels and vehicle power is temporarily reduced. As the swaying motion begins to decrease and the vehicle and trailer have once again become stable, TSA stops regulating the brakes/engine power and the driver regains control of the vehicle.

Trailer Stability Assist may not intervene if the driver tries to compensate for the swaying motion by moving the steering wheel rapidly, because the system will then not be able to determine if it is the trailer or the driver causing the swaying.



When Trailer Stability Assist is activated, the ESC symbol is displayed in the instrument panel.

#### Note

A vehicle software update is required when a towbar is retrofitted. Contact a Volvo retailer.

\* Option/accessory.

<sup>[1]</sup> Trailer Stability Assist

<sup>[2]</sup> Electronic Stability Control



## 11.7.5. Checking trailer lights \*

When connecting a trailer, make sure that the trailer's lights are functioning before starting to drive.

### Checking trailer lights \*

#### Automatic check

When the trailer has been connected to the vehicle's electrical system, its lights can be checked by automatically activating them. This function helps the driver check that the trailer's lights are functioning correctly before starting to drive.

- 1 When a trailer is connected to the towbar, the message **Perform a trailer lamp check?** will appear in the instrument panel.
- 2 Acknowledge the message by pressing the **O** button on the right-side steering wheel keypad.
  - The light check will begin.
- 3 Get out of the vehicle to perform the check.
  - All of the lights on the trailer will begin flashing, and then illuminate separately one at a time.
- 4 Visually check that all of the trailer's lights are functioning correctly.
- 5 After a short time, all of the trailer's lights will start flashing again.
  - The light check is completed.

### Trailer rear fog light

When a trailer is connected, the vehicle's rear fog light may not illuminate and rear fog light functionality is instead transferred to only the trailer. If this is the case, check to see if the trailer is equipped with a rear fog light before activating the vehicle's rear fog light when driving with a trailer to help ensure safe operation.

### Symbols and messages in the instrument panel

If one or more of the turn signals or brake lights on the trailer is not working, a symbol and message will be displayed in the instrument panel. The other lights on the trailer must be checked manually by the driver before the vehicle is driven.

Symbol	Message
	Right trailer turn indicator malfunction Left trailer turn indicator malfunction
	Trailer brake light malfunction

If any of the trailer's turn signal lights is not working, the turn signal symbol in the instrument panel will also flash more quickly than normal.

\* Option/accessory.

---

## 11.8. Fuel

---

### 11.8.1. Fuel gauge

The fuel gauge in the instrument panel shows the fuel level in the tank.

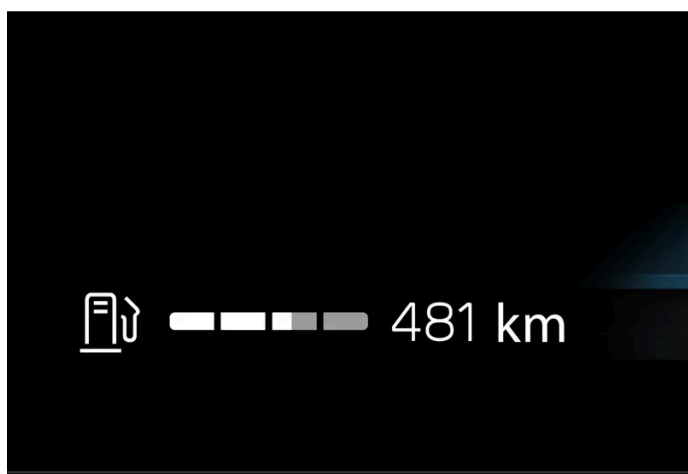

The white area in the fuel gauge indicates the amount of fuel left in the tank.

When the fuel level is low, the fuel pump symbol will illuminate with an amber-colored light. Distance to empty is also indicated in the fuel gauge.

#### Distance to empty tank

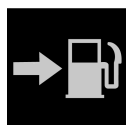

The trip computer calculates how far you can drive on the fuel remaining in the tank.

This calculation is based on average fuel consumption during the last 30 km (20 miles) and the amount of fuel remaining in the tank.

When the gauge displays "----", there is not enough fuel remaining to calculate the remaining mileage. Refuel as soon as possible.

#### Note

The information will change based on your driving style.

An economical driving style will generally increase how far you can drive on a certain amount of fuel.

The content of this manual represents the status of the user manual at the time of printing and may not be completely valid in future instances. For more information refer to the first page for the complete disclaimer note.

---

## 11.8.2. Fuel

Volvo recommends the use of detergent gasoline to control engine deposits.

### Deposit control gasoline (gasoline with detergent additives)

Detergent gasoline is effective in keeping injectors and intake valves clean. Consistent use of deposit control gasolines will help ensure good driveability and fuel economy. If you are not sure whether the gasoline contains deposit control additives, check with the service station operator.

#### Note

Volvo recommends not using external fuel injector cleaning systems, e.g. do not add detergent additives to gasoline before or after refueling.

### Unleaded fuel

All Volvo vehicles have a three-way catalytic converter and must only use unleaded gasoline. US and Canadian regulations require that pumps delivering unleaded gasoline are labeled "UNLEADED". Only the nozzles of these pumps will fit in your vehicle's fuel filler inlet. It is unlawful to dispense leaded fuel into a vehicle labeled "unleaded gasoline only". Leaded gasoline damages the three-way catalytic converter and the heated oxygen sensor system. Repeated use of leaded gasoline will lessen the effectiveness of the emission control system and could result in loss of emission warranty coverage. State and local vehicle inspection programs will make detection of misfueling easier, possibly resulting in emission test failure for misfueled vehicles.

#### Note

Some U.S. and Canadian gasolines contain an octane enhancing additive called methyl-cyclopentadienyl manganese tricarbonyl (MMT). If such fuels are used, your Emission Control System performance may be affected, and the Check Engine Light (malfunction indicator light) located on your instrument panel may light. If this occurs, please return your vehicle to a trained and qualified Volvo service technician for service.

### Gasoline containing alcohol and ethers, "Oxygenated fuels"

Some fuel suppliers sell gasoline containing "oxygenates" which are usually alcohols or ethers. In some areas, state or local laws require that the service pump be marked indicating use of alcohols or ethers. However, there are areas in which the pumps are unmarked. If you are not sure whether there is alcohol or ethers in the gasoline you buy, check with the service station operator. To meet seasonal air quality standards, some areas require the use of "oxygenated" fuel.

Volvo permits the use of the following "oxygenated" fuels. However, the specified octane ratings must still be met.

#### Alcohol - Ethanol

Fuels containing up to 10% ethanol by volume may be used. Ethanol may also be referred to as Ethyl alcohol, or "Gasohol".

Ethers - MTBE/ETBE: Fuels containing up to 22% MTBE/ETBE by volume may be used.

#### Methanol

Do not use gasolines containing methanol (methyl alcohol, wood alcohol). This practice can result in vehicle performance deterioration and can damage critical parts in the fuel system. Such damage may not be covered under the New Vehicle Limited Warranty.

### 11.8.3. Octane rating

Volvo requires premium fuel (91 octane<sup>[1]</sup> or higher) for all B4, B5, B6 and T8 engines, and recommends AKI 93 for optimal performance and fuel economy. See decal examples in illustrations 1 and 2.

#### Minimum octane

##### Decals



Illustration 1: Sample fuel pump octane label<sup>[1]</sup>.



Illustration 2: Decal on the inside of the fuel filler flap on vehicles that require premium fuel<sup>[2]</sup>.

#### TOP TIER Detergent Gasoline

Volvo endorses the use of "TOP TIER Detergent Gasoline" where available to help maintain engine performance and reliability. TOP TIER Detergent Gasoline meets a new standard jointly established by leading automotive manufactures to meet the needs of today's advanced engines. Qualifying gasoline retailers (stations) will, in most cases, identify their gasoline as having met the "TOP TIER Detergent Gasoline" standards.

**Note**

Information about TOP TIER Detergent Gasoline is available at [toptiergas.com](http://toptiergas.com)

 **Note**

When switching to higher octane fuel or changing gasoline brands, it may be necessary to fill the tank more than once before a difference in engine operation is noticeable.

## Fuel Formulations

Do not use gasoline that contains lead or manganese as a knock inhibitor, and do not use lead additives. Besides damaging the exhaust emission control systems on your vehicle, lead has been strongly linked to certain forms of cancer.

Many fuels contain benzene as a solvent. Unburned benzene has been strongly linked to certain forms of cancer. If you live in an area where you must fill your own gas tank, take precautions. These may include:

- standing upwind away from the filler nozzle while refueling
- refueling only at gas stations with vapor recovery systems that fully seal the mouth of the filler neck during refueling
- wearing neoprene gloves while handling a fuel filler nozzle.

## Use of Additives

With the exception of gas line antifreeze during winter months, do not add solvents, thickeners, or other store-bought additives to your vehicle's fuel, cooling, or lubricating systems. Overuse may damage your engine, and some of these additives contain organically volatile chemicals. Do not needlessly expose yourself to these chemicals.

 **Warning**

Never carry a cell phone that is **switched on** while refueling your vehicle. If the phone rings, this may cause a spark that could ignite gasoline fumes, resulting in fire and injury.

 **Warning**

Carbon monoxide is a poisonous, colorless, and odorless gas. It is present in all exhaust gases. If you ever smell exhaust fumes inside the vehicle, make sure the passenger compartment is ventilated, and immediately return the vehicle to a trained and qualified Volvo service technician for correction.

## Demanding driving

In demanding driving conditions, such as when towing a trailer or driving in hot weather or for prolonged periods at high altitudes, it may be a good idea to switch to a higher-octane fuel (AKI<sup>[1]</sup> 91 or higher) or to switch to another brand of gasoline in order to fully utilize the vehicle's engine capacity and optimize traction.

<sup>[1]</sup> AKI (Anti Knock Index) is an average value of RON (Research Octane Number) and MON (Motor Octane Number) -  $(RON) + (MON) / 2$

<sup>[2]</sup> For supplementary information - see the car's Service and Warranty Booklet.

## 11.8.4. Emission controls

### Three-way catalytic converter

- Keep your engine properly tuned. Certain engine malfunctions, particularly involving the electrical, fuel or distributor ignition systems, may cause unusually high three-way catalytic converter temperatures. Do not continue to operate your vehicle if you detect engine misfire, noticeable loss of power or other unusual operating conditions, such as engine overheating or backfiring. A properly tuned engine will help avoid malfunctions that could damage the three-way catalytic converter.
- Do not park your vehicle over combustible materials, such as grass or leaves, which can come into contact with the hot exhaust system and cause such materials to ignite under certain wind and weather conditions.
- Excessive starter cranking (in excess of one minute), or an intermittently firing or flooded engine can cause three-way catalytic converter or exhaust system overheating.
- Remember that tampering or unauthorized modifications to the engine, the Engine Control Module, or the vehicle may be illegal and can cause three-way catalytic converter or exhaust system overheating. This includes: altering fuel injection settings or components, altering emission system components or location or removing components, and/or repeated use of leaded fuel.

 **Note**

Unleaded fuel is required for vehicles with three-way catalytic converters.

### Heated oxygen sensors

The heated oxygen sensors monitor the oxygen content of the exhaust gases. Readings are fed into a control module that continuously monitors engine functions and controls fuel injection. The ratio of fuel to air into the engine is continuously adjusted for efficient combustion to help reduce harmful emissions.

---

## 11.9. Refueling

### 11.9.1. Service stations

You can use the vehicle's navigation system\* to find a route to the nearest service station.

While you are stopped to refuel, it can be a good idea to perform a quick inspection of the vehicle, such as checking tire pressure, lights, wiper blades, filling washer fluid, etc.

\* Option/accessory.

## 11.9.2. Fuel tank volume

The fuel tank's refillable volume is shown in the table below.

	All engines
Liter (approx)	54
US gallons (approx)	14.2

## 11.9.3. Refueling

The fuel tank is equipped with a fuel filling system without a cover.

### Refueling the vehicle at a service station

Instructions for fueling:

- 1 Turn off the engine and open the fuel filler door.
  - 2 Select a fuel approved for use in the vehicle. For more information on approved fuels, see the section on “Fuel”.
  - 3 Insert the pump's nozzle into the fuel filler pipe's opening. There are two flaps just inside the fuel filler pipe and the pump's nozzle must push both of these flaps open before fuel can be added.
  - 4 Avoid overfilling the tank. Do not press the handle on the filler nozzle again after it has initially stopped pumping.
- The fuel tank is now filled.

 **Note**

An over-full tank may overflow in hot weather.

 **Important**

Avoid spilling gasoline during refueling. In addition to causing damage to the environment, gasolines containing alcohol can cause damage to painted surfaces, which may not be covered under the New Vehicle Limited Warranty.

### Refueling from a fuel container

When filling from a fuel container, use the funnel provided in a foam block under the floor hatch in the cargo compartment.

- 1 Open the fuel filler door.

The content of this manual represents the status of the user manual at the time of printing and may not be completely valid in future instances. For more information refer to the first page for the complete disclaimer note.

- 2 Insert the funnel into the fuel filler pipe's opening. There are two flaps just inside the fuel filler pipe and the tube section of the funnel must push both of these flaps open before fuel can be added.



#### Warning

#### California Proposition 65

Operating, servicing and maintaining a passenger vehicle can expose you to chemicals including engine exhaust, carbon monoxide, phthalates, and lead, which are known to the State of California to cause cancer and birth defects or other reproductive harm. To minimize exposure, avoid breathing exhaust, do not idle the engine except as necessary, service your vehicle in a well ventilated area and wear gloves or wash your hands frequently when servicing your vehicle. For more information go to [www.P65Warnings.ca.gov/passenger-vehicle](http://www.P65Warnings.ca.gov/passenger-vehicle) [<https://www.p65warnings.ca.gov/products/passenger-vehicle>].

---

## 11.9.4. Opening/closing the fuel filler door

The vehicle must be unlocked before the fuel filler door can be opened<sup>[1]</sup>.

- 1 After refueling, press the fuel filler door lightly to close it.

\* Option/accessory.

<sup>[1]</sup> Only locking and unlocking using the key, Passive Entry\* or via the Volvo Cars app will affect the status of the fuel filler door.

---

## 11.10. Emission control system

### 11.10.1. Emission controls

#### Three-way catalytic converter

- Keep your engine properly tuned. Certain engine malfunctions, particularly involving the electrical, fuel or distributor ignition systems, may cause unusually high three-way catalytic converter temperatures. Do not continue to operate your vehicle if you detect engine misfire, noticeable loss of power or other unusual operating conditions, such as engine overheating or backfiring. A properly tuned engine will help avoid malfunctions that could damage the three-way catalytic converter.

The content of this manual represents the status of the user manual at the time of printing and may not be completely valid in future instances. For more information refer to the first page for the complete disclaimer note.



- Do not park your vehicle over combustible materials, such as grass or leaves, which can come into contact with the hot exhaust system and cause such materials to ignite under certain wind and weather conditions.
- Excessive starter cranking (in excess of one minute), or an intermittently firing or flooded engine can cause three-way catalytic converter or exhaust system overheating.
- Remember that tampering or unauthorized modifications to the engine, the Engine Control Module, or the vehicle may be illegal and can cause three-way catalytic converter or exhaust system overheating. This includes: altering fuel injection settings or components, altering emission system components or location or removing components, and/or repeated use of leaded fuel.

**Note**

Unleaded fuel is required for vehicles with three-way catalytic converters.

## Heated oxygen sensors

The heated oxygen sensors monitor the oxygen content of the exhaust gases. Readings are fed into a control module that continuously monitors engine functions and controls fuel injection. The ratio of fuel to air into the engine is continuously adjusted for efficient combustion to help reduce harmful emissions.

## 11.11. HomeLink

### 11.11.1. HomeLink<sup>®</sup> \* [1]

HomeLink<sup>®</sup> [2] is a programmable remote control integrated in the vehicle's electrical system. It can remotely control up to three different devices, such as garage door openers or alarm systems, and thereby replace the remote controls for these.

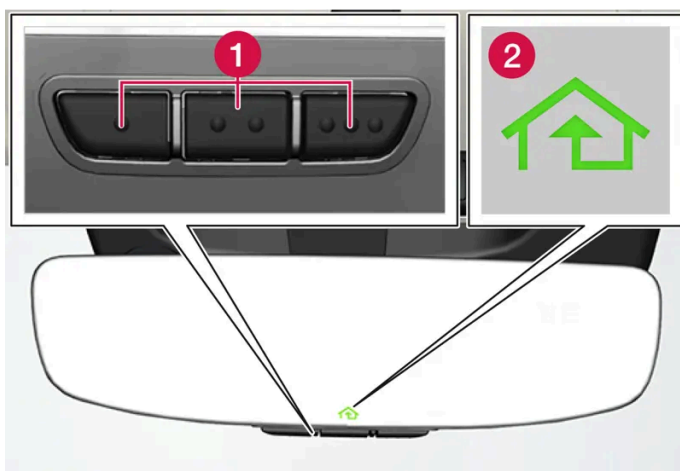

The illustration is generic – the design may vary.

**1** Programmable buttons

## 2 Indicator light

HomeLink<sup>®</sup> is integrated in the rearview mirror and consists of three programmable buttons and an indicator light in the mirror.

### Note

Save the original remote controls for future reprogramming (e.g. for use in another vehicle).

It is also advisable to delete the button programming if the vehicle is sold.

## More information

Visit [homelink.com](http://homelink.com) or call 1-800-355-3515.

\* Option/accessory.

[1] Certain markets only.

[2] HomeLink and the HomeLink house symbol are registered trademarks of Gentex Corporation.

---

## 11.11.2. Using HomeLink<sup>®</sup> \* [1]

Once HomeLink<sup>®</sup> is programmed, it can be used instead of the separate remote controls.

Press and hold the programming button. The garage door, gate, alarm system, etc. will be activated (this may take several seconds). If the button is held down for more than 20 seconds, reprogramming will begin. The indicator light will glow steadily or flash when the button has been pressed. The original remote controls may be used concurrently with HomeLink<sup>®</sup> if desired.

### Note

When the ignition is switched off, HomeLink<sup>®</sup> will be active for at least 7 minutes.

### Note

HomeLink<sup>®</sup> cannot be used if the vehicle is locked and the alarm is armed\* from the outside.

### Warning

- If you use HomeLink<sup>®</sup> to open a garage door or gate, be sure no one is near the gate or door while it is in motion.
- Do not use HomeLink<sup>®</sup> with any garage door opener that lacks safety stop and reverse features as required by U.S. federal safety standards (this includes any garage door opener model manufactured before April 1, 1982). A garage door that cannot detect an object - signaling the door to stop and reverse - does not meet current U.S. federal safety standards. For more information, contact HomeLink at: [homelink.com](http://homelink.com).

\* Option/accessory.

[1] Certain markets only.

---

## 11.11.3. Programming HomeLink® \* [1]

Program HomeLink®, reset programming or reprogram individual buttons.

### Programming

- 1 Point the remote control at the HomeLink® button to be programmed and hold it about 2-8 cm (1-3 inches) from the button. Do not obstruct the HomeLink® indicator light.
- 2 Press and hold both the remote control button and the HomeLink® button to be programmed.
- 3 Do not release the buttons until the indicator light has stopped flashing slowly (about once a second) and either flashes quickly (about 10 times a second) or glows steadily.
  - **If the indicator light glows steadily:** Indication that programming is complete. Press the programmed button twice to activate.
  - If the indicator light flashes quickly:** The device being programmed with HomeLink® may have a security function that requires an extra step. Try pressing the programmed button twice to see whether the programming works. Otherwise, continue with the following steps.

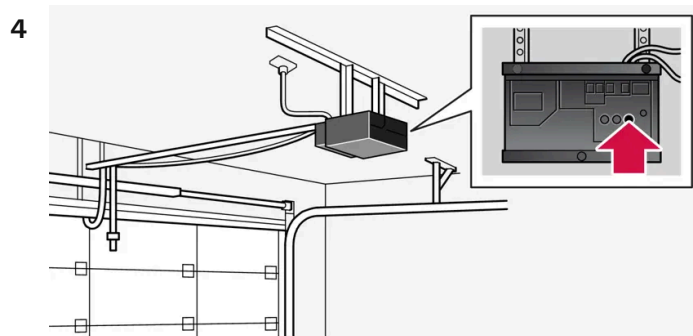

Locate the "training" button [2] on the receiver for the e.g. garage door opener. It is usually located near the antenna bracket on the receiver.

- 5 Press and release the "training" button once.

Programming must be completed within 30 seconds after pressing the button.
- 6 Press and release the HomeLink® button to be programmed. Repeat the press/hold/release sequence a second time. For some receivers, the sequence may need to be repeated a third time.
  - Programming is complete.

 **Note**

Some remote controls are more effective at programming HomeLink® from a distance of about 15-20 cm (6-12 inches).

## Programming individual buttons

- 1 Press and hold the desired button for about 20 seconds.
- 2 When the indicator light on HomeLink® starts flashing slowly, it is possible to program as usual.

 **Note**

If the button you are reprogramming does not program with a new device, it will return to the previously saved programming.

## Resetting the HomeLink® buttons

It is only possible to reset all HomeLink® buttons at once. Individual buttons can only be reprogrammed.

- 1 Press and hold the outer buttons on HomeLink® for about 10 seconds.
  - When the indicator light goes from a steady glow to flashing, the buttons have been reset and are ready for reprogramming.

## Problems programming

Visit [homelink.com](http://homelink.com) or call 1-800-355-3515.

\* Option/accessory.

[1] Certain markets only.

[2] The name and color of the button varies depending on the manufacturer.

---

### 11.11.4. Type approval for HomeLink® \* [1]

Type approval for HomeLink® is provided below.

Country/Area	Type approval
USA and Canada	This device complies with FCC rules part 15 and Industry Canada RSS-210. Operation is subject to the following two conditions: (1) This device may not cause harmful interference, and (2) This device must accept any interference that may be received including interference that may cause undesired operation.
Europe	Gentex Corporation hereby declares that HomeLink <sup>®</sup> Model UAHL5 complies with the Radio equipment directive 2014/53/EU. Wavelengths within which the radio equipment operates: <ul style="list-style-type: none"> <li>• 433.05MHz-434.79MHz &lt;10mW E.R.P.</li> <li>• 868.00MHz-868.60MHz &lt;25mW E.R.P.</li> <li>• 868.70MHz-868.20MHz &lt;25mW E.R.P.</li> <li>• 869.40MHz-869.65MHz &lt;25mW E.R.P.</li> <li>• 869.70MHz-870.00MHz &lt;25mW E.R.P.</li> </ul> Certificate holder address: Gentex Corporation, 600 North Centennial Street, Zeeland MI 49464, USA

 **Warning**

The transmitter has been tested and complies with FCC and IC rules. Changes or modifications not expressly approved by the party responsible for compliance could void the user's authority to operate the device.<sup>[2]</sup>

\* Option/accessory.

<sup>[1]</sup> Certain markets only.

<sup>[2]</sup> The term "IC:" before the certification/registration number only signifies that Industry Canada technical specifications were met.

## 11.12. Towing

### 11.12.1. Towing using a towline

This section refers to one vehicle being towed behind another using a towline.

Before towing another vehicle, check applicable speed limit regulations.

 **Important**

Vehicles with the seven-gear transmission should never be towed behind another vehicle. They must instead be transported with all wheels raised on the bed of a tow truck. Contact a Volvo retailer to determine what applies for your vehicle.

## Preparations and towing

 **Important**

For some transmission variants, it is not possible to shift from P position if the engine is switched off. Contact an authorized Volvo workshop for assistance towing or call a professional towing service.

 **Important**

Note that the vehicle must always be towed with the wheels rolling forward.

- Do not tow a vehicle with automatic transmission at a speed greater than 80 km/h (50 mph) or for a distance greater than 80 km (50 miles).
- Vehicles with the seven-gear transmission should never be towed behind another vehicle. They must instead be transported with all wheels raised on the bed of a tow truck.

 **Warning**

- Ignition mode II must be active – all airbags are deactivated in ignition mode I.
- Always have the key in the vehicle when it is towed.

 **Warning**

The brake and steering servos do not work when the engine is off – it takes about 5 times more pressure on the brake pedal and steering requires much more effort than normal.

- 1 Turn on the hazard warning flashers.
  - 2 Attach the towline to the towing eyelet.
  - 3 Put the vehicle in ignition mode II – without pressing the brake pedal, press and hold the start button for about 4 seconds. Release the button.
  - 4 Move the gear selector to neutral (N) and release the parking brake.  
If the battery charge level is too low, it may not be possible to release the parking brake. Connect an auxiliary battery to the vehicle if the battery is discharged.
- The towing vehicle can now start driving.
- 5 Keep the towline taut when the towing vehicle slows down by applying light pressure to the brake pedal. This will help avoid jarring movements.
  - 6 Be prepared to apply the brakes to stop the vehicle.

## Jump starting

The content of this manual represents the status of the user manual at the time of printing and may not be completely valid in future instances. For more information refer to the first page for the complete disclaimer note.

Do not tow the vehicle to start the engine. Use an auxiliary battery if the start battery's charge level is so low that the engine cannot be started.

---

## 11.12.2. Attaching and removing the towing eyelet

Use the towing eyelet when towing. Screw the towing eyelet securely into place in the threaded outlet behind the cover on the right-hand side of the front and rear bumpers.

### Attaching the towing eyelet

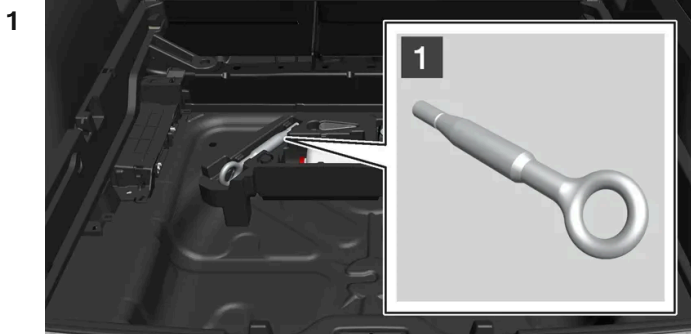

1

Take out the towing eyelet, which is stored in a foam block under the floor in the cargo compartment.

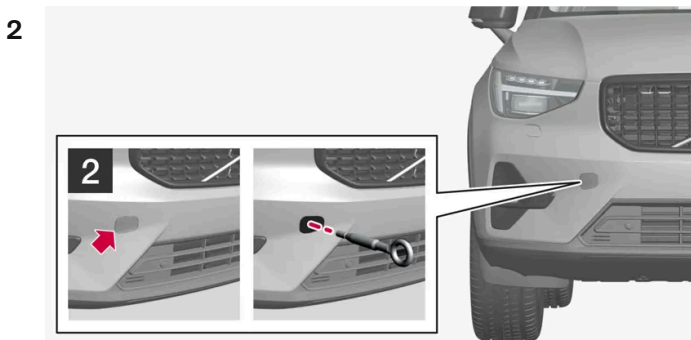

2

Front: Remove the cover by pressing the cover.

- The cover turns along its center line and can then be removed.

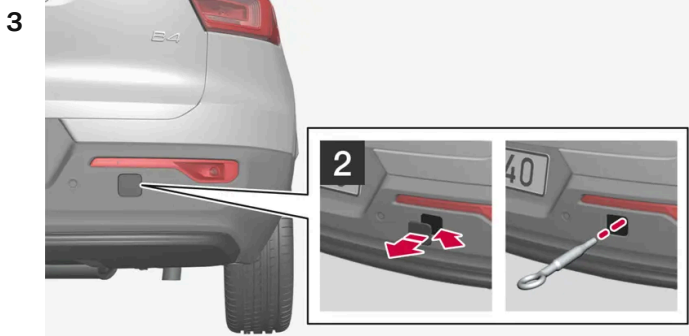

2

Rear: Remove the cover by placing a coin, key or similar at the mark and prying out the cover.

- Fold out the cover completely and remove.

#### 4 Screw the towing eyelet in as far as possible.

Fasten the eyelet securing by, for example, inserting a lug wrench\* through it and using this as a lever.

#### ! Important

It is important that the towing eye is screwed in securely as far as possible.

#### To consider before using the towing eyelet

- In certain conditions, the towing eyelet may be used to pull the vehicle onto a flatbed tow truck. The vehicle's position and ground clearance determines if this is possible.
- If the incline of the tow truck is too steep or if the ground clearance under the vehicle is insufficient, attempting to pull it up using the towing eyelet may result in damage.
- If necessary, lift the vehicle using the tow truck's lifting device instead of using the towing eyelet.

#### ! Warning

No person or object should be behind the tow truck when the vehicle is lifted onto the bed of the truck.

#### ! Important

The towing eyelet is only intended for towing on roads – not for pulling vehicles from ditches or any similar purpose involving severe strain. Call a tow truck for professional assistance.

## Removing the towing eyelet



- 1 Unscrew the towing eyelet after use and return it to the foam block.

Replace the cover on the bumper.

\* Option/accessory.

---

## 11.12.3. Recovery

This section refers to transporting the vehicle with a tow truck or similar vehicle.

Call a professional towing service for assistance.

In certain conditions, the towing eyelet can be used to pull the vehicle onto a flatbed tow truck.

If the vehicle is equipped with pneumatic suspension\*, this feature must be turned off before the vehicle is lifted onto a tow truck. Turning off the function in the center display.

- 1 Tap .
- 2 Select **Driving**.
- 3 Choose to activate or deactivate pneumatic suspension.

The vehicle's location and ground clearance determine if it can be lifted onto a tow truck. If the incline of the tow truck is too steep or if the ground clearance under the vehicle is insufficient, attempting to pull it up may result in damage. In this case, the vehicle should only be lifted with the tow truck's lifting equipment.

### **Warning**

No person or object should be behind the tow truck when the vehicle is lifted onto the bed of the truck.

### **Important**

The towing eyelet is only intended for towing on roads, and must **not** be used to pull vehicles from ditches or any similar purpose involving severe strain. Call a tow truck for professional assistance.

 **Important**

Note that the vehicle must always be towed with the wheels rolling forward.

Never tow a vehicle with all-wheel drive\* with the front wheels lifted at speeds above 70 km/h (40 mph) or for distances longer than 50 km (30 miles).

\* Option/accessory.

---

## 11.12.4. Safety mode

Safety mode is a feature that is triggered after a collision if there is potential damage to an important function in the vehicle, such as the fuel lines, sensors for one of the safety systems, the brake system, etc.

If the vehicle has been involved in a collision, the text **Safety mode See Owner's manual** may appear in the instrument panel along with the warning symbol if the panel is undamaged and the vehicle's electrical system is intact. The message indicates that one or more of the vehicle's functions may be reduced.

 **Warning**

Never attempt to restart the vehicle if you smell fuel fumes when the message **Safety mode See Owner's manual** is displayed in the instrument panel. Leave the vehicle immediately.

If safety mode has been set, it may be possible to reset the system in order to start and move the vehicle a short distance, for example, if it is blocking traffic.

 **Warning**

Never attempt to perform repairs or reset electrical components on your own after the vehicle has been in safety mode. This could result in injury or prevent the vehicle from functioning properly. Volvo recommends having the vehicle inspected and reset to normal operating status by an authorized Volvo workshop after **Safety mode See Owner's manual** has been displayed.

 **Warning**

When the vehicle is in safety mode, it should not be towed behind another vehicle. It should be towed from the site on a tow truck. Volvo recommends towing the vehicle directly to an authorized Volvo workshop.

---

## 11.12.5. Starting and moving the vehicle when it is in safety mode

The content of this manual represents the status of the user manual at the time of printing and may not be completely valid in future instances. For more information refer to the first page for the complete disclaimer note.

If safety mode has been set, it may be possible to reset the system in order to start and move the vehicle a short distance, for example, if it is blocking traffic.

## Resetting and starting the vehicle when it is in safety mode

- 1 Check the vehicle for damage, particularly for fuel leakage. Make sure you do not detect any gasoline fumes.

If the damage to the vehicle is minor and there is no fuel leakage/fumes, you may attempt to start the engine.



### Warning

Never attempt to restart the vehicle if you smell fuel fumes when the message **Safety mode See Owner's manual** is displayed in the instrument panel. Leave the vehicle immediately.

- 2 Switch off the vehicle manually.
  - 3 Then try to start the vehicle.
- The vehicle's electrical system will perform a system check and then attempt to reset to normal operating mode.



### Important

If the message **Safety mode See Owner's manual** is still displayed, the vehicle should not be driven or towed behind another vehicle. If the vehicle needs to be moved, it must be towed on a tow truck. Even if no damage is apparent, there may be hidden damage that could make the vehicle impossible to control.

## Moving the vehicle when it is in safety mode

- 1 If the message **The car is now in normal mode** is displayed after attempting to start the vehicle, the vehicle may be moved carefully from its present position if, for example, it is blocking traffic.
- 2 Do not move the vehicle farther than absolutely necessary.



### Warning

When the vehicle is in safety mode, it should not be towed behind another vehicle. It should be towed from the site on a tow truck. Volvo recommends towing the vehicle directly to an authorized Volvo workshop.

## 12. Audio, media and Internet

---

### 12.1. Radio

---

#### 12.1.1. Sirius XM satellite radio

---

##### 12.1.1.1. SiriusXM<sup>®</sup> Satellite radio\*

The SiriusXM<sup>®</sup> Satellite system broadcasts from a number of high elevation satellites in geosynchronous orbit.

##### Starting SiriusXM

The SiriusXM app can be started via the center display or via voice control.

Via the center display:



Start the SiriusXM app from Home view<sup>[1]</sup> or App view.

- 2 Select the desired station from the list of available stations, favorites or categories.

If no subscription is activated, press station 0 which shows your radio ID. The Now Playing view prompts you to make a call SiriusXM on the screen to activate the subscription you want. The Radio ID can also be found on the settings page for SiriusXM, which also contains subscription status information.

When the subscription has been activated, you can choose to listen to a desired station in the SiriusXM app.

\* Option/accessory.

<sup>[1]</sup> The app is available from Home view if it is among the most recently used apps.

## 12.1.1.2. Using SiriusXM<sup>®</sup> Satellite radio \*

SiriusXM Satellite radio offers several features for finding and listening to music, news, sporting events, etc. being broadcast on satellite radio stations.

### Setting favorites

A SiriusXM station can be added to the list of favorites, which has its own tab in the SiriusXM app.

To save a stations as a favorite:

- 1 Open the SiriusXM app from Home view or app view.
- 2 Tap the star ☆ next to the station you want to add to the list of favorites. The star becomes solid blue to indicate that the selection has been confirmed.
  - The station is added to the list of favorites.

The stations are placed in numerical order.

To remove a station from the list of favorites, tap the star again. The blue color will disappear to confirm that the station has been removed from the list of favorites.

It is also possible to add and remove favorites from the Now-playing view, which can be accessed by expanding the Now-playing field to full-screen view.

### SiriusXM<sup>®</sup> Satellite radio functions

#### Search

Tapping the magnifying glass brings up a search view where you can enter digits using the center display's keyboard and search for a station.

#### Settings

Pressing the gear wheel displays settings for SiriusXM. Here you will find information about your subscription, radio ID and setting for hiding or showing stations in the station list that you can no longer subscribe to.

#### Stations

Tap the station tab to display a complete list of the stations included in your subscription. Tap a station name to listen. If a subscription to a station has expired, its name will be grayed-out on the screen. For quick access to a station that you often listen to, tap the star to the right of the station's name. It will then be added to your list of favorites.

#### Favorites

Tap on the favorites tab to display the stations that you have added to this list. Tap a station to listen.

#### Categories

Tap on the categories tab to display the categories available. Tap a category to display the stations that it contains and then tap a station to listen.

\* Option/accessory.

---

## 12.1.2. Radio\*

It is possible to listen to FM stations.



The radio can be controlled from the center display or the steering wheel keypad, or by using voice control.



Additional radio apps can be downloaded from Google Play.

### Shortcuts

When the app is in use, it can also be controlled via shortcuts in Home view.

### Radio messages<sup>[1]</sup>

Different types of radio messages, such as traffic news and important public announcements, can be adjusted under settings in the radio app.

\* Option/accessory.

<sup>[1]</sup> Certain markets only.

---

## 12.1.3. Starting the radio\*

The radio app can be started via the center display or by using voice control.

### Starting from the center display

1



Start the radio app from Home view<sup>[1]</sup> or App view .

- 2 Select the desired radio station from the list of available radio stations or from favorites.

## Starting using voice control

FM radio can also be started using voice control by saying a frequency<sup>[2]</sup>.

\* Option/accessory.

<sup>[1]</sup> The app is available from Home view if it is among the most recently used apps.

<sup>[2]</sup> Only FM frequencies can be specified using voice control, not names of radio stations.

---

## 12.1.4. RBDS \*

RBDS radio

RBDS (Radio Broadcast Data System) enables certain functionality<sup>[1]</sup>, such as:

- Searches for program types or new broadcasts
- Text information about currently broadcast programs

\* Option/accessory.

<sup>[1]</sup> Certain stations only.

---

## 12.1.5. Storing radio favorites \*

A radio station can be added to the list of favorite radio stations, which has its own tab in the radio app.

### Radio favorites

To save a radio station as a favorite:

- 1 Open the radio app from Home view or App view.
- 2 Tap the star ☆ next to the radio station you want to add to the list of favorite stations. The star becomes solid blue to indicate that the selection has been confirmed.
  - The radio station is added to the list of favorites.

To remove a radio station from the list of favorites, tap the star again. The blue color will disappear to confirm that the radio station has been removed from the list of favorites.

It is also possible to add and remove favorites from the Now-playing view, which can be accessed by expanding the Now-playing field to full-screen view.

\* Option/accessory.

---

## 12.2. Media player

---

### 12.2.1. Bluetooth Media Player

If a phone or another device is connected to the vehicle via Bluetooth, media from the devices can be played in Bluetooth Media Player.



Start the Bluetooth Media Player app from Home view or App view . When the app is in use, it can also be controlled via shortcuts in Home view.



**Note**

To stream media from a phone via Bluetooth, you must first start Bluetooth Media Player.

Other third-party apps for media playback can also be downloaded to the vehicle.

#### Start Bluetooth Media Player via voice control

It is also possible to control the media player using voice control.

---

## 12.3. Phone

---

### 12.3.1. Connecting a phone

---

#### 12.3.1.1. Connecting a phone to the vehicle



The content of this manual represents the status of the user manual at the time of printing and may not be completely valid in future instances. For more information refer to the first page for the complete disclaimer note.



Use Bluetooth to pair a phone with the vehicle to make calls, send and receive text messages and play media.

## Searching for the phone from the vehicle

Activate Bluetooth in the phone and verify in the settings that the phone is visible to other devices.

- 1 If no phone is already paired, tap . Otherwise, go to settings  at the bottom of the center display, and then tap **Connectivity** and **Bluetooth**. If the phone is not already listed under <sup>[1]</sup>, select **Pair new device**.
  - > A list of available Bluetooth devices will be displayed. The list will be updated as new devices are discovered.
- 2 Tap the name of the phone you would like to connect.
- 3 Make sure that the code displayed in the vehicle matches the one in the phone and confirm.
- 4 In the phone, accept or cancel the options for selecting the phone's contacts and text messages.
  - > By default, the phone is connected for use as both phone and media device<sup>[2]</sup>.
- 5 Tap **Done**.

### Note

- The message function must be activated in certain phones.
- If contacts and messages are not shown in the vehicle even when the function is activated, try unplugging the phone and plugging it in again.
- Not all phones are fully compatible and may not be able to display contacts and messages in the vehicle.

### Note

If the phone's operating system is being updated, it is possible that the connection will be interrupted. Delete the phone from the car and reconnect.

<sup>[1]</sup> Previously paired phones will be visible under Bluetooth and can be selected from there.

<sup>[2]</sup> Which device should be used for phone and/or media can be selected later on, for example if a passenger wants to use their phone as media device to play media.

---

## 12.3.1.2. Disconnecting a Bluetooth-connected phone

A Bluetooth-connected phone can be disconnected from the vehicle.

- When the phone is out of range of the vehicle, it will be automatically disconnected. If a call is in progress when the phone is disconnected from the vehicle, the call will be transferred from the vehicle's speakers and microphone to the cellular phone.
- The phone can also be disconnected by manually deactivating Bluetooth.

## Disconnecting via the center display

- 1 Tap  at the bottom of the display.
- 2 Tap **Connectivity**.
- 3 Under **Bluetooth**, tap the row containing the name of the phone to disconnect both phone and media.
  - The phone is no longer connected to the vehicle.

You can also select whether the phone should be connected as only phone or only media device by pressing the relevant icon.

---

### 12.3.1.3. Switch between phones connected via Bluetooth

It is possible to switch between Bluetooth-connected phones.

You can do this by opening the phone app and tapping .

You can also switch between phones by following the steps below.

- 1 Tap  at the bottom of the display.
- 2 Tap **Connectivity**.
- 3 Under **Bluetooth**, tap the name of the phone you would like to connect.
- 4 Select if it should be used as phone, media device, or both.

---

### 12.3.1.4. Disconnecting Bluetooth-connected devices

Phones or other devices in the list of registered Bluetooth devices can be removed.

- 1 Tap  at the bottom of the display.

- 2 Tap **Connectivity**.
  - 3 Under **Bluetooth**, tap the arrow after the name of the phone.
  - 4 Tap **Forget device**.
- The phone is no longer registered in the vehicle.

---

## 12.3.2. Apple CarPlay

---

### 12.3.2.1. Apple<sup>®</sup> CarPlay<sup>®</sup> \*



With CarPlay<sup>[1]</sup>, you can listen to music, make phone calls, get driving instructions, send/receive messages and use Siri<sup>®</sup>, all while remaining focused on driving.

CarPlay works with select iPhone<sup>®</sup><sup>[2]</sup> models. If the vehicle does not already have support for CarPlay, it can be retrofitted. Contact a Volvo retailer to install CarPlay.

Information on supported apps and compatible iPhones can be found on Apple's website: [www.apple.com/ios/carplay/](https://www.apple.com/ios/carplay/) [<https://www.apple.com/ios/carplay/>]. Please note that Volvo is not responsible for the content in CarPlay.

When using map navigation via CarPlay, guidance is shown in the instrument panel. A route description must be active for the map to be shown.

When navigation is started through Apple CarPlay, any current route guidance from the vehicle's own systems will be discontinued.

The CarPlay apps can be controlled via the center display, your iPhone or with the right-side steering wheel keypad. The apps can be voice-controlled using Siri. Press and hold the «» button on the steering wheel to start voice control with Siri. Press briefly to activate the vehicle's own voice control system. If Siri cuts off too soon, press and hold the «» button on the steering wheel.

\* Option/accessory.

<sup>[1]</sup> Availability may vary depending on market.

<sup>[2]</sup> Apple, CarPlay, iPhone and Siri are registered trademarks of Apple Inc.

---

### 12.3.2.2. Using Apple<sup>®</sup> CarPlay<sup>®</sup> \*

To use CarPlay<sup>[1]</sup>, the Siri<sup>®</sup> voice control must be activated in your iPhone<sup>®</sup><sup>[2]</sup>. The device also needs to have an Internet connection for all functions to work.

## Connecting an iPhone and starting CarPlay

### Note

CarPlay can only be used if Bluetooth is disabled in the vehicle. A cell phone or media player connected to the vehicle via Bluetooth will therefore not be available when CarPlay is active.

- 1 Plug an iPhone with support for CarPlay into the USB port with the white frame<sup>[3]</sup>. If CarPlay has been previously used from the phone, CarPlay will open automatically.
- 2 If this is the first time the phone is connected, read and approve the terms and conditions to connect.
  - CarPlay opens and compatible apps are shown.
- 3 Tap the desired app.
  - The app will start up.

CarPlay will run in the background if another app is started. To display CarPlay again, tap the CarPlay app in App view.

\* Option/accessory.

<sup>[1]</sup> Availability may vary depending on market.

<sup>[2]</sup> Apple, CarPlay, iPhone and Siri are registered trademarks of Apple Inc.

<sup>[3]</sup> USB-C to lightning cable required.

---

### 12.3.2.3. Tips for using Apple<sup>®</sup> CarPlay<sup>®</sup> \*

Here are some useful tips for when you use CarPlay<sup>®</sup><sup>[1]</sup>.

- Update your iPhone<sup>®</sup><sup>[2]</sup> with the latest version of the iOS operating system and ensure that the apps have been updated.
- In the event of a problem with CarPlay, unplug your iPhone from the USB port and plug it in again. Otherwise, try to close the app on the device that is not working and then restart the app, or try closing all apps and restart your device.
- You can use Siri<sup>®</sup> to write or dictate messages or have them read aloud. Messages are read aloud and dictated in the language selected in the Siri settings. When a message is written/dictated, it will be displayed in your iPhone, but not in the center display.
- If the device is connected to the vehicle through Bluetooth, the connection will be broken when CarPlay is used.
- CarPlay only works with iPhone.

 **Note**

Availability and functionality can vary depending on market.

\* Option/accessory.

<sup>[1]</sup> Availability may vary depending on market.

<sup>[2]</sup> Apple, CarPlay, iPhone and Siri are registered trademarks of Apple Inc.

---

## 12.3.3. Connecting to the Internet via Bluetooth

Set up an Internet connection via Bluetooth through tethering (personal/portable hotspot) from a phone.

- 1 Make sure that the phone supports Internet sharing (tethering) and that the function is activated.
  - 2 Connect the phone to the vehicle via Bluetooth. Go to settings  at the bottom of the center display and then tap **Connectivity** and select **Bluetooth**.
  - 3 If the phone was previously connected, tap the icon for tethering via Bluetooth for the phone you want to use. Otherwise, select **Pair new device** first.
  - 4 Accept, via the message shown, that connection should be made.
- The vehicle is connected to the Internet.

 **Note**

The cellular phone and network operator must support tethering (sharing of Internet connection) and the subscription must include data traffic.

---

## 12.3.4. Phone

A phone equipped with Bluetooth can be wirelessly connected to the vehicle.

When a phone has been paired and connected to the vehicle, it is possible to make calls, send and receive text messages and play media wirelessly through the vehicle's audio system.

The phone is controlled from the center display and certain functions can also be voice-controlled.

## 12.3.5. Managing contacts

When a phone is connected to the vehicle, contacts can be managed directly in the center display.

When a phone is connected to the vehicle with Bluetooth and selected as phone device, contacts in the phone app will be shown under a separate tab.

Contact sharing must first be accepted in the phone before the contacts can be shown in the vehicle.

Scroll through contacts by swiping up or down.

It is possible to display a phone's favorites in the vehicle.<sup>[1]</sup>

### Contacts not displayed

It may take a moment for the contacts to load. If the contacts are still not shown after a prolonged period of time, try unplugging the phone and plugging it back in.

 **Note**

Not all phones are fully compatible with the vehicle. If the phone is not compatible, contacts cannot be displayed in the vehicle.



<sup>[1]</sup> Some phones are unable to sync favorites. In that case, you can manually add favorites in the vehicle.

---

## 12.3.6. Handling phone calls

You can make and receive calls over the vehicle's speakers when your phone is connected to the vehicle via Bluetooth. The phone must be paired as a phone device.



### Making a call from the phone app

- 1 Open the phone app from Home view or App view .
- 2 Select a contact from **Favorites**, **Recents** or **Contacts**. You can also enter a phone number using the keypad.
- 3 Tap the contact to make a call.
- 4 Tap  to end the call.

It is also possible to make calls using voice control.

### Answering calls

Incoming phone calls are shown and managed via the center display.

- 1 Tap  or  to answer or decline a call.
- 2 Tap  to end the call.

#### Answering a call while another call is in progress

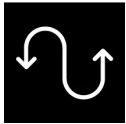

If a new call comes in while you are on another call, you can answer the new call via the center display. The original call will be parked (put on hold) while you answer the incoming call. Switch between the calls by pressing the symbol for that.

### Turning off the microphone



Tap the microphone symbol to turn off the microphone. The person on the phone call will not hear what is said in the vehicle.

### Switching between the vehicle's and phone's speakers

Tap **Car/Phone** to switch the sound between the vehicle's and the phone's speakers.

### Using the keypad during a call

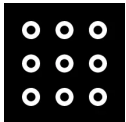

If you need to use the keypad during a call, you can open it by pressing the keypad symbol in the center display. To exit Keypad view and return to Call view, tap the same symbol again.

### Missed calls

Missed calls are shown in Home view, where it is also possible to call back. Missed calls are also shown in Notification view at the top of the center display.

---

## 12.3.7. Handling text messages

SMS text messages can be received and sent via the vehicle when the phone is paired with the vehicle.

To manage text messages in the vehicle, the phone must be connected via Bluetooth <sup>[1]</sup> as phone device and the user must have accepted notification display in the phone's Bluetooth settings.

### Sending text messages

It is possible to dictate a new message by asking the voice control system to send a message to a named contact or phone number.

## Receiving text messages

When the phone is paired with the vehicle, a notification will be displayed at the top of the center display when a new text message comes in. Select whether to play the message by tapping the screen or using voice control.

You can also choose to mute the conversation. In this case, no further notifications for this conversation will be shown during the current trip.

## Answering text messages

When a text message is read aloud, it is possible to dictate a reply<sup>[2]</sup>. Follow the instructions given by the voice control system.

## Text messages are not displayed

If new text messages are shown on the phone but not in the center display, try unplugging the phone and plugging it back in.

<sup>[1]</sup> Text messages can only be handled in the vehicle if the phone is compatible.

<sup>[2]</sup> Only phones with Android or iOS 13 or later.

---

## 12.3.8. Wireless phone charger\*

A charging pad for wireless phone charging is located in the tunnel console.



To be able to charge, the phone must have wireless charging (Qi) capability. Phones not equipped with a wireless charging receiver can often be supplemented with a shell that enables wireless charging.

### Warning

Wireless charging can affect the operation of an implanted pacemaker or other medical devices. If you have one, it is recommended to consult with your doctor before using the wireless charging system.

\* Option/accessory.

---

## 12.3.9. Using the wireless phone charger\*

The rubber pad below the center display can be used to charge a phone without having to connect its cord.

### Activating and deactivating the wireless charger



The factory default setting for the wireless charger is activated. Sometimes it can be helpful to deactivate the charger if, for example, you would like to lay your phone on the rubber pad without charging it. To deactivate and activate:

- 1 Go to settings  at the bottom of the center display and then tap **Controls**.
- 2 Adjust the control next to **Wireless phone charger**.

## Charging a device using the wireless charger



Wireless phone charger in front of gear selector

### **Warning**

Wireless charging can affect the operation of an implanted pacemaker or other medical devices. If you have one, it is recommended to consult with your doctor before using the wireless charging system.

- 1 Make sure that the charger is activated.
  - 2 Remove all other objects from the charger.
  - 3 Place the device to be charged in the center of the charger.
- The device will begin charging and the  symbol will appear at the top of the center display.

### **Important**

Do not store cards or other objects with near-field communication (NFC), e.g. debit cards for contactless payment, together with the device to be charged. This interferes with the charging and could damage these types of objects.





App view provides access to the vehicle's preinstalled and downloaded apps.

Tap the icon for App view  at the bottom of the center display to go to App view and start the radio\*, navigation system, phone or another app<sup>[1]</sup>.



Several basic apps are always available. More apps such as web radio and music services can be downloaded when the car is connected to the Internet.

Some apps can only be used when the vehicle is connected to the Internet.

All apps used should be updated to the latest version. This provides access to the latest updates and functions.

## Apps close down

If an app closes down unexpectedly, try the following:

- open the app again
- check to see if an app update is available:
  - Open App view  and tap Google Play. Press  and select your apps to see if any need to be updated. Update to the latest version.
- restart the system by pressing the home button for approx. 20 seconds
- uninstall and reinstall the app.

\* Option/accessory.

<sup>[1]</sup> The most recently used apps are always available from Home view.

---

## 12.4.2. Download apps

New apps can be downloaded and installed when the vehicle is connected to the Internet.



Google Play contains a number of different apps customized for use in the vehicle.

To download apps, the vehicle must be stationary, i.e. it must be in usage mode Comfort:

- 1 Open App view .
- 2 Tap Google Play.
  - A Google account must be connected to the current user profile in order to open Google Play.
- 3 Search for and select the desired app<sup>[1]</sup>.
- 4 Tap Install.

The content of this manual represents the status of the user manual at the time of printing and may not be completely valid in future instances. For more information refer to the first page for the complete disclaimer note.

- 5 Follow the instructions on the screen to complete the installation.

 **Note**

The app sometimes requires access to certain things, such as the address book or the vehicle's location, in order for the app to function as intended. When such access is required, you will be prompted to accept this.

<sup>[1]</sup> Only vehicle-adapted apps are available.

---

## 12.4.3. Deleting apps

Installed apps <sup>[1]</sup> can be deleted in various ways.

### Deleting apps via App view

- 1 Open App view .
- 2 Press and hold the app you wish to remove until a recycling bin appears at the bottom of the screen.
- 3 Pull the app to the recycling bin and release.
- 4 Confirm the deletion.

### Deleting apps via settings

- 1 Go to settings  at the bottom of the center display.
- 2 Go to **Applications**.
- 3 Select to display all installed apps and then select the app you want to delete.
- 4 Select to uninstall the app and confirm its deletion.

 **Note**

If the app you want to delete is the only app in a tile, it must be uninstalled via settings.

\* Option/accessory.

<sup>[1]</sup> The vehicle's "native" default apps, such as the phone or radio\* apps, cannot be deleted.

---

## 12.4.4. Volvo ID

Volvo ID is a personal ID that gives you access to a range of services using a single username and password.

One example of a service in which a Volvo ID is needed is to check the vehicle via your phone using the Volvo Cars app.

A Volvo ID can be created from the vehicle, at [volvoid.eu.volvocars.com/Account](https://volvoid.eu.volvocars.com/Account) [<https://volvoid.eu.volvocars.com/Account/>] or in the Volvo Cars app.

### Note

The available services can vary over time and depend on equipment level and market.

---

## 12.4.5. Creating a Volvo ID

To use Volvo services connected to the vehicle, such as via the Volvo Cars app, a Volvo ID must be created.

### Creating a Volvo ID with the Volvo Cars app

- 1 Download the latest version of the Volvo Cars app<sup>[1]</sup> to your phone.
  - 2 Choose to create a Volvo ID.
  - 3 The website for creating a Volvo ID will appear.
  - 4 Enter a personal email address or cell phone number.
  - 5 Follow the instructions that will be sent automatically to this email address/cell phone number.
- A Volvo ID is created and ready for use.

### Creating a Volvo ID on the Volvo Cars website

- 1 Go to [volvoid.eu.volvocars.com/Account](https://volvoid.eu.volvocars.com/Account) [<https://volvoid.eu.volvocars.com/Account/>]. Choose to create a Volvo ID.
- 2 Enter a personal email address or cell phone number.

3 Follow the instructions that will be sent automatically to this email address/cell phone number.

➤ A Volvo ID is created and ready for use.

<sup>[1]</sup> Can be downloaded from e.g. the Apple App Store or Google Play.

---

## 12.5. Internet connection

---

### 12.5.1. Internet-based services

---

#### 12.5.1.1. Connected Safety

Connected Safety<sup>[1]</sup> communicates information between your vehicle and other vehicles via a cloud service<sup>[2]</sup>. The function is designed to notify the driver of any hazardous road conditions ahead.

The function can notify the driver if another vehicle further down the road has activated its hazard warning flashers or detected slippery road conditions. You will also be notified if your own vehicle detects slippery road conditions.

Connected Safety can assist the driver with the following:

- Hazard warning flashers alert
- Slippery road alerts

Connected Safety communication between vehicles only works for vehicles equipped with this function. Connected Safety also needs to be approved via **Volvo privacy settings**.

#### Hazard warning flashers alert

If your vehicle's hazard warning flashers are activated, information on this can be sent to other vehicles approaching your location.



When your vehicle approaches a vehicle with its hazard warning flashers on, this symbol will appear in the instrument panel.

## Slippery road alerts



If your vehicle detects reduced friction between the tires and the road, this symbol will be shown in the instrument panel. This information can then be forwarded to vehicles approaching your vehicle's location.



If your vehicle receives information about slippery conditions from another vehicle, this symbol will be shown in the instrument panel.

### **Warning**

- The function is supplementary driver support intended to facilitate driving and help make it safer – it cannot handle all situations in all traffic, weather and road conditions.
- The driver is advised to read all sections in the Owner's Manual about this function to learn of its limitations, which the driver must be aware of before using the function.
- Driver support functions are not a substitute for the driver's attention and judgment. The driver is always responsible for ensuring the vehicle is driven in a safe manner, at the appropriate speed, with an appropriate distance to other vehicles, and in accordance with current traffic rules and regulations.

<sup>[1]</sup> Not available in all markets.

<sup>[2]</sup> There may be a charge for transmitting data over the cloud service, depending on your service plan.

---

## 12.5.1.2. Apps

App view provides access to the vehicle's preinstalled and downloaded apps.

Tap the icon for App view  at the bottom of the center display to go to App view and start the radio\*, navigation system, phone or another app<sup>[1]</sup>.



Several basic apps are always available. More apps such as web radio and music services can be downloaded when the car is connected to the Internet.

Some apps can only be used when the vehicle is connected to the Internet.

All apps used should be updated to the latest version. This provides access to the latest updates and functions.

### Apps close down

If an app closes down unexpectedly, try the following:

- open the app again
- check to see if an app update is available:
  - Open App view  and tap Google Play. Press  and select your apps to see if any need to be updated. Update to the latest version.

The content of this manual represents the status of the user manual at the time of printing and may not be completely valid in future instances. For more information refer to the first page for the complete disclaimer note.



- restart the system by pressing the home button for approx. 20 seconds
- uninstall and reinstall the app.

\* Option/accessory.

<sup>[1]</sup> The most recently used apps are always available from Home view.

---

## 12.5.1.3. Volvo ID

Volvo ID is a personal ID that gives you access to a range of services using a single username and password.

One example of a service in which a Volvo ID is needed is to check the vehicle via your phone using the Volvo Cars app.

A Volvo ID can be created from the vehicle, at [volvoid.eu.volvocars.com/Account](https://volvoid.eu.volvocars.com/Account) [<https://volvoid.eu.volvocars.com/Account/>] or in the Volvo Cars app.

### Note

The available services can vary over time and depend on equipment level and market.

---

## 12.5.1.4. Creating a Volvo ID

To use Volvo services connected to the vehicle, such as via the Volvo Cars app, a Volvo ID must be created.

### Creating a Volvo ID with the Volvo Cars app

- 1 Download the latest version of the Volvo Cars app<sup>[1]</sup> to your phone.
  - 2 Choose to create a Volvo ID.
  - 3 The website for creating a Volvo ID will appear.
  - 4 Enter a personal email address or cell phone number.
  - 5 Follow the instructions that will be sent automatically to this email address/cell phone number.
- A Volvo ID is created and ready for use.

### Creating a Volvo ID on the Volvo Cars website

- 1 Go to [volvoid.eu.volvocars.com/Account](https://volvoid.eu.volvocars.com/Account) [<https://volvoid.eu.volvocars.com/Account/>]. Choose to create a Volvo ID.
  - 2 Enter a personal email address or cell phone number.
  - 3 Follow the instructions that will be sent automatically to this email address/cell phone number.
- A Volvo ID is created and ready for use.

<sup>[1]</sup> Can be downloaded from e.g. the Apple App Store or Google Play.

---

## 12.5.2. Connecting to the Internet via Bluetooth

Set up an Internet connection via Bluetooth through tethering (personal/portable hotspot) from a phone.

- 1 Make sure that the phone supports Internet sharing (tethering) and that the function is activated.
  - 2 Connect the phone to the vehicle via Bluetooth. Go to settings  at the bottom of the center display and then tap **Connectivity** and select **Bluetooth**.
  - 3 If the phone was previously connected, tap the icon for tethering via Bluetooth for the phone you want to use. Otherwise, select **Pair new device** first.
  - 4 Accept, via the message shown, that connection should be made.
- The vehicle is connected to the Internet.

### Note

The cellular phone and network operator must support tethering (sharing of Internet connection) and the subscription must include data traffic.

---

## 12.5.3. Internet connection

When the vehicle is connected to the Internet, you can use apps to listen to web radio, music services, etc.

The vehicle can be connected to the Internet via a Bluetooth-connected phone or a Wi-Fi network. In some markets, the vehicle can also be connected via the vehicle's built-in modem <sup>[1]</sup>. If the vehicle has Internet connections to several different sources at the same time, it will first attempt to connect over Wi-Fi, then Bluetooth and finally via the vehicle's integrated modem.

<sup>[1]</sup> On certain markets, approval of conditions is required for Internet connection via modem.

---

## 12.5.4. Internet connection problems

If the vehicle loses its Internet connection, you can try the following.

### Switching cellular data on and off

If the vehicle's Internet connection suddenly and inexplicably disappears, it may help to switch cellular data on and off.

- 1 Go to settings  at the bottom of the center display and then tap **Connectivity**.
- 2 Switch **Vehicle SIM data**, **Wi-Fi** and **Bluetooth** off and then on again to restart the connection.

### Restarting the system

Restart the system by pressing and holding down the Home button for 20 seconds.

### Problems connecting via a Bluetooth-connected phone

If you are having difficulty connecting a phone to the vehicle via Bluetooth

- Make sure the phone is switched on and that the battery has sufficient charge.
- Make sure Bluetooth is enabled in both the phone and in the vehicle.
- Make sure you have established a Bluetooth connection and connected the vehicle to the phone you want to use.
- If possible, try connecting another phone to the vehicle through Bluetooth to check if the problem is with the device or in the vehicle.

If the problem persists:

1. Delete all previously added phones under the Bluetooth settings in the vehicle.
2. Restart the phone you want to connect.
3. Try connecting the phone again.

### Problems connecting via the vehicle's integrated modem <sup>[1]</sup>

If connection via the vehicle's integrated modem is not working well, e.g. due to poor coverage, try connecting via a Wi-Fi network or Bluetooth-connected phone instead.

 **Note**

If multiple Internet connection sources are used at the same time, for example, if the vehicle has Internet via integrated modem and simultaneously has Internet switched on via a Bluetooth-connected phone, these sources are used according to the following order of priority. First, connection will be attempted via Wi-Fi network, second, via the Bluetooth-connected phone and third, via the vehicle's integrated modem.

<sup>[1]</sup> Connection via integrated modem is only available on some markets.

---

## 12.5.5. Connecting to the Internet via Wi-Fi

The vehicle can be connected to a Wi-Fi network.

If the vehicle is parked outside a building with a Wi-Fi network, for example, or if you are sharing an Internet connection via a cellular phone, you can connect the vehicle to that network.

If you are sharing your phone's Internet connection, remember to first enable tethering (personal/portable hotspot) on the phone.

To connect the vehicle to an external Wi-Fi network:

- 1 Go to settings  at the bottom of the center display and then tap **Connectivity**.
- 2 Tap the **Wi-Fi** row to display a list of available networks. Connection is not permitted for all networks. If the network you want to connect to is not shown in the list of available networks, see details below.
- 3 Choose a network, enter the password, and connect.

 **Note**

Here are the known requirements for making the Wi-Fi access points available for use with Android:

- WPA2 with password (CCMP).
  - A password is required.
- Not permitted/possible:
  - Network without encryption (open network).
  - WPA3.
  - WEP.
  - WPA (with TKIP).
  - WPS (Wi-Fi Protected Setup)-enabled routers. Also applies for WPA2 connections (most home routers are WPS-enabled). If your home router has WPS functionality enabled, it will not be available due to the limited security in WPS access management. To connect to a WPA2 network with WPS, disable WPS in the router.

---

## 12.5.6. Markets with Internet via vehicle modem

Markets offering Internet via the vehicle's integrated modem are listed here.

The markets listed here offer Internet via the vehicle's integrated modem for four years<sup>[1]</sup> from the purchase date of the vehicle. Data roaming works within the EU.

Country
Australia
Belgium
Denmark
Finland
France
Greece
Hong Kong
India
Indonesia
Ireland
Iceland
Italy
Japan
Canada
China
Korea
Luxembourg
Malaysia
Mexico
Netherlands
Norway
New Zealand
Poland
Portugal
Puerto Rico
Romania
Switzerland
Singapore
Slovakia
Spain
United Kingdom
Sweden

Country
Taiwan <sup>[2]</sup>
Thailand <sup>[2]</sup>
Czech Republic
Germany
Hungary
USA
Austria

<sup>[1]</sup> This time may vary depending on market and vehicle model.

<sup>[2]</sup> The Volvo XC40 Recharge Pure Electric model years 2022 and 2023 and the C40 Recharge Pure Electric model year 2023 come with connected services free of charge for four years. For other vehicle models, one year of free connected services is included.

## 12.6. Audio and media

The vehicle's sound system takes into account factors such as listener position and vehicle speed. The center display provides access to radio\* and music apps, and additional third-party music and media apps can be downloaded via Google Play.

Connect a phone or other device via Bluetooth. Select if you would like to use this as media device to play music and/or as phone device to make calls, display contacts, etc.



Audio and media overview

The functions can be controlled using voice commands, the steering wheel keypad or the center display.

Charge devices via the USB ports.

\* Option/accessory.

---

## 12.7. Hard disk storage space

It is possible to view how much space is remaining on the vehicle's hard disk.

To check available space:

- 1 Tap settings  at the bottom of the display.
- 2 Select **System**.
- 3 Proceed to **Storage**.

---

## 12.8. Sound settings

Sound reproduction quality is preset but can also be adjusted.

### Volume

The system's volume is normally adjusted using the volume control below the center display or the right-side steering wheel keypad. This applies, for example, when playing music or the radio\* or during phone calls and active traffic messages.

When the volume is adjusted, an expandable menu will appear in the center display. This menu can be used to change volume settings for incoming phone calls, notifications, the media player and other functions.

For additional sound settings, go to settings  and tap **Sound**.

### Sound reproduction

The audio system is precalibrated using digital signal processing. This calibration takes into account speakers, amplifiers, passenger compartment acoustics, listener location, etc. There is also a dynamic calibration that takes into account the volume control's position and the vehicle's speed.

\* Option/accessory.

---

## 12.9. Playing media

Regardless of which media app is used, a Now-playing field will be shown in the center display.

In the Now-playing field, you can perform operations such as pause, change track, etc. Expand the Now-playing field to full-screen mode to access additional settings.

**The content of this manual represents the status of the user manual at the time of printing and may not be completely valid in future instances. For more information refer to the first page for the complete disclaimer note.**

### Opening the Now-playing view

Tap the arrow in the Now-playing field to expand the field to Now-playing view. This view provides access to additional settings, which could vary depending on which app is used. Minimize the Now-playing view by tapping the arrow again.

---

## 12.10. Connection and entertainment

The vehicle has an intelligent interface and offers Internet connection to the digital world. An intuitive navigation structure offers access to relevant assistance, information and entertainment when it is needed.

It includes all of the solutions in the vehicle related to entertainment, Internet connection and navigation, and serves as the user interface between the driver and the vehicle.

Where Volvo is responsible for the provision of mobile connectivity services to enable use of certain functions, and excluding any separate contract for mobile connectivity services of the owner or any other user of the car that Volvo is not party to, each user understands and agrees that, to the extent permitted by law, it: (1) has no contractual relationship with the underlying wireless service carrier, (2) is not a third party beneficiary of any agreement between the car owner and the underlying carrier, (3) that the underlying carrier has no liability of any kind to the user, whether for breach of contract, warranty, negligence, strict liability in tort or otherwise, (4) that data transmissions and messages may be delayed, deleted or not delivered, and emergency calling may not be completed, (5) the underlying carrier cannot guarantee the security of wireless transmissions and will not be liable for any lack of security relating to the use of the services.

### Fair Use Policy

Your use of connectivity services that are part of your vehicle is subject to this Fair Use Policy.

When using this Service, you agree not to

- submit content that is unlawful, obscene, libelous, threatening, harassing, hateful, racially or ethnically offensive or otherwise inappropriate
- use the Service in breach of any applicable law
- use the Service for commercial purposes.

Your access to the Service is part of a shared access. Volvo reserves the right to suspend your access to or use of the Service if your use involves very high volumes of data, disproportionate to other users. Volvo may also suspend your access for technical reasons or to protect other functions of your vehicle. Your access to the connected Service is subject to the third-party terms and conditions of the mobile network provider.

### Information when it's needed, where it's needed



The vehicle's displays present the right information at the right time. Information is presented in different displays depending on how it should be prioritized by the driver.

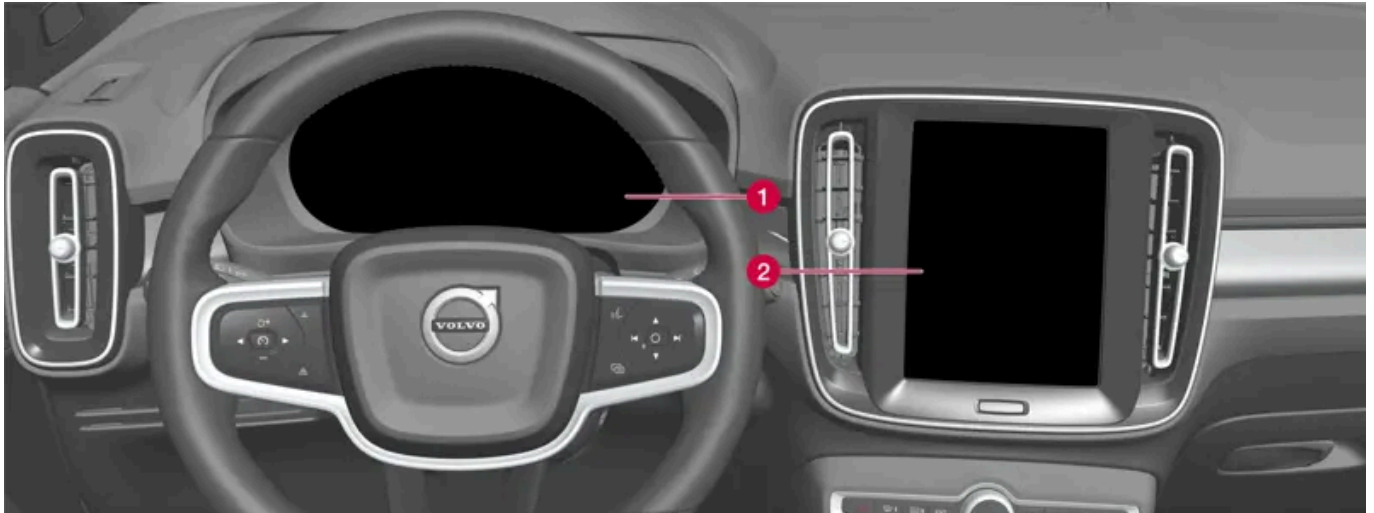

Different types of information are shown in different displays depending on how the information should be prioritized.

- 1 The instrument panel shows information about speed, road sign information, warning and indicator symbols, battery status, etc. The instrument panel can also show incoming calls or information about the current song on the radio. It is controlled using the steering wheel keypads.
- 2 Many of the vehicle's main functions are controlled from the center display, such as the climate control system, the entertainment system and seat positions. The center display also shows navigation and road sign information. The information presented in the center display can be handled by the driver or by someone else in the vehicle.

**Note**

Wearing gloves can limit or prevent touchscreen response.

#### Voice control system

The voice control system enables the driver to control certain vehicle functions without taking their hands off the wheel. The system can understand natural speech. Use voice control to e.g. play a song, make a phone call, increase the temperature in the passenger compartment or have a text message read aloud.

## 12.11. Approval of terms and conditions and data collection

Messages about different terms and conditions and data collection may be shown in the center display. Data is collected, for example, in order to provide better safety, vehicle and app functions.

The first time you use your vehicle, a guide will open in the center display to help you adjust various settings. In connection with the guide, you are also prompted to give your agreement to different types of terms and conditions and the collection of information.

You may also be asked to provide your consent in other situations, such as:

- First use of apps and services

The content of this manual represents the status of the user manual at the time of printing and may not be completely valid in future instances. For more information refer to the first page for the complete disclaimer note.

- New user profiles
- Logging out from and deleting user profiles
- Change of ownership
- Resetting settings

To access privacy settings:

- 1** Tap  in the center display.
- 2** Tap **Privacy**.
- 3** Then select **Volvo privacy settings**, **Data sharing with Google** or **Legal information from Google**.

Certain settings can only be made from a profile with administrative rights.

---

# 13. Volvo Assistance and the Volvo Cars app

---

## 13.1. Volvo Assistance

---

### 13.1.1. Volvo Assistance

The  and SOS buttons in the overhead console can provide extra security and assistance if the vehicle won't start or in the event of a flat tire, accident, etc.



The functions are available via  and the SOS buttons in the overhead console.

In the event of an accident, emergency assistance (ambulance, police, etc.) can be summoned to the vehicle. In less critical situations, e.g. a flat tire, roadside assistance can be called out.

#### Note

The SOS button should only be used in case of accident, illness or if there is an external threat to the vehicle and its passengers. The SOS function is only intended for emergency situations. Misuse could incur extra charges.

The  button can be used for other assistance, e.g. questions about vehicle use or if roadside assistance is needed.

### The Volvo Assistance system

The buttons in the overhead console are connected to the vehicle's safety and alarm systems and to other systems in the vehicle, such as lock and climate systems. The vehicle has an integrated modem for communication with Volvo Assistance and the Volvo Cars app. GNSS (Global Navigation Satellite System) is used to locate the vehicle.

### Personal data processing

The content of this manual represents the status of the user manual at the time of printing and may not be completely valid in future instances. For more information refer to the first page for the complete disclaimer note.

In order to provide you with all the functions of the service, certain information, including personal data, must be processed. Read more about terms and conditions and privacy at [volvocars.com/intl/legal](https://www.volvocars.com/intl/legal) [<https://www.volvocars.com/intl/legal>].

## Contacting Volvo Assistance

To contact Volvo Assistance, use the vehicle's  button or the Volvo Cars app.

### Note

All calls to Volvo Assistance may be recorded.

## 13.1.2. Emergency assistance with Volvo Assistance

In the event of an emergency, press the SOS button to contact Volvo Assistance or an emergency service center.

### Volvo Assistance

To summon assistance in the event of an illness or an external threat to the vehicle or passengers, Volvo Assistance can be alerted manually by pressing and holding the SOS button for at least 2 seconds. The vehicle will contact Volvo Assistance and a message will be sent containing information such as the vehicle's location.

- 1 Volvo Assistance will then attempt to establish voice contact with the driver to determine the extent of the emergency and the need for assistance.
- 2 Volvo Assistance will then contact the appropriate emergency service (police, ambulance, tow truck, etc.).

If voice contact cannot be established, Volvo Assistance will contact emergency services for appropriate action.

### Note

The SOS button should only be used in case of accident, illness or if there is an external threat to the vehicle and its passengers. The SOS function is only intended for emergency situations. Misuse could incur extra charges.

The  button can be used for other assistance, e.g. questions about vehicle use or if roadside assistance is needed.

### Note

If the SOS indicator light is flashing even if you have not pushed the button, this indicates that the vehicle is attempting to find and connect to a cellular network. The flashing will continue until the vehicle has made a connection.

## 13.1.3. Automatic Crash Notification with Volvo Assistance

In the event of a collision, the vehicle can automatically notify Volvo Assistance, or an emergency service center, which can then summon emergency assistance.

### Volvo Assistance

If any of the vehicle's safety systems are triggered, for example in an accident in which the activation level is reached for seat belt tensioners or airbags, the vehicle will automatically contact Volvo Assistance and a message will be sent containing the vehicle's location and other information.

- 1 Volvo Assistance will then attempt to establish voice contact with the driver to determine the extent of the accident and the need for assistance.
- 2 Volvo Assistance will then contact the appropriate emergency service (police, ambulance, tow truck, etc.).

If voice contact cannot be established, Volvo Assistance will contact emergency services for appropriate action.

---

## 13.1.4. Stolen Vehicle Tracking (SVT) with Volvo Assistance

If you suspect the vehicle has been stolen, you can contact Volvo Assistance using the Volvo Cars app for assistance locating the vehicle. <sup>[1]</sup>

If the vehicle has been stolen or otherwise used without permission, the vehicle's owner, police and Volvo Assistance can agree to track the vehicle.

 **Note**

This applies even if the vehicle has been opened and stolen using the associated remote key.

The following needs to be done:

- 1 Contact Volvo Assistance and say that you need help tracking the vehicle. Tracking begins.
- 2 File a police report.
- 3 Contact Volvo Assistance again and give them the police case number.
- 4 Volvo Assistance notifies the police of the vehicle's location.

 **Note**

For the vehicle to be tracked, a police report must be made. Volvo Assistance only gives information to the police.

<sup>[1]</sup> Available services vary depending on market.

---

## 13.1.5. Volvo Assistance help during a trip

If you e.g. get a flat tire, run out of gas or have a dead battery, you can summon assistance using the  button or the Volvo Cars app.

Hold the  button in the overhead console depressed for at least 2 seconds to establish voice contact with Volvo Assistance. They will consult with you to determine what type of assistance is needed. If data sharing for the overhead buttons is activated, a message with the vehicle's position is sent to Volvo Assistance.

 **Note**

The SOS button should only be used in case of accident, illness or if there is an external threat to the vehicle and its passengers. The SOS function is only intended for emergency situations. Misuse could incur extra charges.

The  button can be used for other assistance, e.g. questions about vehicle use or if roadside assistance is needed.

## Roadside Assistance costs

Roadside Assistance costs are included in the first X<sup>[1]</sup> years when buying a new Volvo. After this time has passed, in most of the markets, Roadside Assistance is offered for free providing the car has been serviced regularly at an authorized Volvo workshop. A Volvo retailer can inform you of the status of your Roadside Assistance agreement.

You can get help you get back on the road even if your Roadside Assistance agreement has expired. If this is the case, you will be asked to pay the cost for the service that is sent out to you.

 **Note**

If you do not have a valid roadside assistance agreement, additional recovery costs may apply.

<sup>[1]</sup> Varies depending on market.

---

## 13.1.6. Customer service via Volvo Assistance

The  button can be used to contact Volvo Assistance for questions concerning vehicle usage.

The content of this manual represents the status of the user manual at the time of printing and may not be completely valid in future instances. For more information refer to the first page for the complete disclaimer note.

Operators are available for assistance 24 hours a day.

You can also reach Volvo Assistance via the  tab in the Volvo Cars app.

---

## 13.1.7. Backup battery for Volvo Assistance

If the main battery has no electrical current, a backup battery will take over so that Volvo Assistance can still be used.

The backup battery has a limited lifespan. When the battery requires servicing or replacement, a message (**eCall Service required**) is shown in the instrument panel.

If the message persists, contact an authorized Volvo workshop.

---

## 13.1.8. Volvo Assistance abroad

The assistance services may vary when driving in other countries.

When you push the SOS button, you will always be connected to Volvo Assistance or an emergency service center for the market in which the vehicle is currently located.

When you press the  button, you will always be connected to your home country's Volvo Assistance.

For more information, please contact a Volvo retailer.

---

## 13.2. Volvo Cars app

---

### 13.2.1. Getting started with the Volvo Cars app

Some preparations are needed before using the Volvo Cars app.

#### Exploring the Volvo Cars app

Before picking up the vehicle from the retailer, you should download the free Volvo Cars app and test it in demo mode. Demo mode gives the driver the chance to explore most of the functions and learn how the app is used.

#### Volvo ID and connecting the Volvo Cars app to the vehicle

A Volvo ID is required to use the Volvo Cars app. Once you have created a Volvo ID, the app needs to be connected to the vehicle.

## Purchasing a pre-owned vehicle with digital services

If you have purchased a pre-owned vehicle with digital services, it is important to delete the data from the previous owner and add you own details for the service to work. Visit a Volvo retailer for assistance.

---

### 13.2.2. Devices compatible with the Volvo Cars app

The Volvo Cars app is compatible with a number of mobile devices and operating systems.

The Volvo Cars app is available for iPhone, iPad and Apple Watch as well as Android phones. You can download the app free of charge from Apple App Store or Google Play.

For the Volvo Cars app to work as well as possible, ensure that you have updated the app to the latest version available for your device. More information on technical requirements concerning version as well as operating systems and compatibility for device models is available when downloading apps.



#### Note

Volvo reserves the right to end the maintenance of older versions of apps and remove them from existing app stores at any time.

### Internet connection

Because the app communicates with the vehicle via the Internet, your mobile device must have an Internet connection<sup>[1]</sup> to perform your commands.

<sup>[1]</sup> There may be a charge for transmitting data over the Internet, depending on your service plan.

---

### 13.2.3. Contact between the Volvo Cars app and the vehicle

The vehicle's systems that have contact with the Volvo Cars app are programmed to shut down when the vehicle is not used for extended periods of time.

After a few days, the system switches off to save the battery. Some of the app's functions cannot be used during this time. The system resumes full availability once the vehicle has been started.



 **Warning**

The system's services only work in areas in which Volvo Assistance partners have cellular coverage and where the technology allows.

Just as with cellular phones, atmospheric disturbances or areas with fewer transmitters, e.g. sparsely populated rural areas, can make connection impossible.

---

## 13.2.4. Volvo Cars app

With the Volvo Cars app, you can maintain contact with your vehicle through a number of app functions. <sup>[1]</sup>

You can, for example, lock or unlock the vehicle and start the climate system in the vehicle before departure. <sup>[2]</sup>

### Downloading the Volvo Cars app

The Volvo Cars app can be downloaded free of charge from Apple App Store or Google Play. You can test most of the app functions without connecting to a vehicle by running the app in demo mode.

### Internet connection required

When using the Volvo Cars app, your mobile device will send and receive data via the internet. If you do not have a data plan, then your cell phone carrier may charge you for that data. If you use your app abroad you may incur data roaming charges. For further information, contact your cell phone operator.

 **Note**

Data sharing for the overhead buttons must be activated for remote control of vehicle functions, such as climate and locking, to work.

<sup>[1]</sup> Both the vehicle and the mobile device must have cellular coverage or another Internet connection.

<sup>[2]</sup> Available functions may vary depending on market and vehicle model.

---

## 13.2.5. Connecting the Volvo Cars app to the vehicle

To use the Volvo Cars app's services, the app must first be connected to the vehicle.

Once a main user (administrator) has connected their app to the vehicle, additional vehicle users can be added.

### Connect the Volvo Cars app to the vehicle

Make sure your vehicle is positioned in an area with cellular coverage and that your mobile device has an Internet connection.



Make sure you have your Volvo ID and the vehicle's identification number (VIN). The Volvo ID can be created by logging in to the Volvo Cars app, and the vehicle identification number can be found in the windshield or in the center display.

If you are a main user (administrator), you must have all of the vehicle's keys with you. For other users, one key is sufficient. The first user to link their app with the vehicle must be logged in on the Owner profile and have all of the vehicle's keys with them.

- 1 Sit in the vehicle.
- 2 Log in to the Volvo Cars app using your Volvo ID and follow the instructions in the app. If you already have a connected vehicle in the app and would like to add another, select , **Connected vehicles** and **Add a vehicle**.

 **Note**

For a more customized experience and support, it is recommended that every user create a personal Volvo ID.

- 3 Make sure that data sharing for the Volvo Cars app is activated. In the center display, tap , select **Privacy, Volvo privacy settings** and then **Volvo Cars app**.
- 4 Go to , select **Profiles** and then **Volvo Cars app devices** to access the menu for connecting the app to the vehicle.
- 5 Follow the instructions in the center display and the Volvo Cars app.

## Difference between administrator and non-administrator in the Volvo Cars app

The vehicle's **Owner** profile must be linked with the app before any other profile can be linked. To be allocated the role of administrator, all of the vehicle's keys must be in the vehicle when the app is linked.

A user who is administrator in the app can

- see which phones and other devices are linked with the vehicle
- remove their own and other linked phones/devices from the vehicle

A user who is not administrator in the app can

- see if their own phone/device is linked with the vehicle
- remove their own phone/device.

## Switching between connected vehicles in the Volvo Cars app

If you have multiple vehicles connected to the Volvo Cars app, you can switch between these. To do this:

- 1 Go to the  tab.
- 2 Select **Connected vehicles**.
- 3 Mark the vehicle you want to switch to and select **Switch to this vehicle**.

### Tips when using the Volvo Cars app

If you experience disruptions with the Volvo Cars app, ensure that the vehicle the app is connected to is outdoors in an open area with cellular coverage and that your mobile device has a good Internet connection. If disruptions persist, read the section with frequently asked questions about the Volvo Cars app on [volvocars.com/intl/support](https://www.volvocars.com/intl/support) [<https://www.volvocars.com/intl/support>] or contact Volvo customer care.

If the vehicle was previously owned, however, you should first check whether access to Volvo Assistance is activated in the vehicle.

---

## 13.2.6. Booking service with the Volvo Cars app

Vehicle service can be scheduled using the Volvo Cars app. <sup>[1]</sup>

### Book service

- 1 In the  tab, tap **Maintenance**.
- 2 Select **Book service**.
- 3 Select a workshop to perform the service.
- 4 Select any additional services <sup>[2]</sup> you would like to purchase, e.g. air conditioning check.
- 5 Enter a date and time for service and indicate if you would like a courtesy car <sup>[3]</sup>. Some workshops also offer pick-up and delivery of the vehicle to be serviced.
- 6 Fill in comments, if any, and confirm the booking.
- 7 Select if you would like to add the booking to the calendar.

When a service has been booked, this will be shown under **Maintenance** in the  tab.

Click on the booking to:

- see details about the booking
- save the booking in the calendar (with option to add a reminder)
- cancel the service
- contact the workshop via email or phone.

## Service messages in the Volvo Cars app

When it is time for the vehicle to be serviced, this will be shown in the Volvo Cars app

- with a message in the 🏠 tab
- and under **Maintenance** in the 📧 tab.

While the vehicle is being serviced, the estimated completion time is shown in the Volvo Cars app.

<sup>[1]</sup> Certain markets only.

<sup>[2]</sup> Available services vary depending on workshop.

<sup>[3]</sup> Certain workshops only.

---

## 13.2.7. Remote Start of the vehicle using the Volvo Cars app

With the Volvo Cars app, the vehicle can be started remotely to warm up or cool down the passenger compartment to a comfortable temperature.<sup>[1]</sup>

### Things to bear in mind when using Engine Remote Start

The function can only be used if:

- The vehicle is locked.
- No vehicle keys remain in the vehicle.
- The hood is locked.
- The vehicle is parked and the transmission is in Park.
- The engine is not running.
- The vehicle is under supervision.
- There are no people or animals in or around the vehicle.
- The vehicle is not parked inside a closed room/space without sufficient ventilation.
- There are no risks of anybody being in direct contact with the vehicle (e.g. during service work in a workshop or children playing near the vehicle).
- The function can be used at the specified time according to local law.

In addition, the system will check the following before the vehicle is started:

- Engine status is OK (no critical diagnostic trouble codes).



**The content of this manual represents the status of the user manual at the time of printing and may not be completely valid in future instances. For more information refer to the first page for the complete disclaimer note.**

- Sufficient fuel level (more than 8 liters (2.11 US gallons)).

User recommendations can be found in the Volvo Cars app.

## Remote starting of the car

First, make sure it is permissible under local environmental regulations and laws to start the vehicle in its present location.

- 1 Go to the  tab and tap the  icon.
- 2 Enter when you plan to start driving (in number of minutes, 1-15, from the current time). Confirm that you want to start the vehicle and verify your identify using your phone's unlock method (PIN code, password, pattern, TouchID, FaceID, etc.).

### Note

For safety reasons, the vehicle cannot be driven when it is remote-started via the Volvo Cars app. The function will remain active until you depress the brake pedal and press the start button.

It is possible to activate the function in the Volvo Cars app twice in succession. After that, the vehicle has to be started with the key before you can activate the function via the app again.

If it is cold when the vehicle is started remotely, functions such as seat heating and heated door mirrors and rear window will also be started automatically.

## Remote start of the climate system

You can also start the climate system remotely without starting the vehicle.<sup>[2]</sup> Read more about remote start of the climate system in a separate section.

<sup>[1]</sup> Certain markets only.

<sup>[2]</sup> Applies for plug-in hybrids and vehicles equipped with fuel heaters.

---

## 13.2.8. Locking function in the Volvo Cars app

The Volvo Cars app shows the actual lock status and you can lock and unlock the vehicle remotely.

You can find the lock function in the  tab.

### Note

If an incorrect lock status is shown, open the lock function from the  tab and wait 15-20 seconds.

---

## 13.2.9. Shortcuts to the Volvo Cars app

You can create shortcuts to the functions offered in the Volvo Cars app.

### 3D Touch

Using 3D Touch gives you access to shortcuts to certain features in the Volvo Cars app<sup>[1]</sup>.

A hard press on the App icon in your phone takes you to shortcuts for functions such as Start Climate and Unlock Doors.

### Sharing addresses to the Volvo Cars app

Some third party apps facilitate sharing addresses to the Volvo Cars app<sup>[2]</sup>.



<sup>[1]</sup> Applies to certain iPhone models. See the manufacturer's website for more information.

<sup>[2]</sup> Varies depending on phone model and version of operating system.

## 13.2.10. Remote Start of the climate system using the Volvo Cars app

If the vehicle is equipped with the climate package\*, you can start the climate system immediately or enter a time at which you will use the vehicle.<sup>[1]</sup> If you choose to enter a time, the climate system will start automatically to heat up the passenger compartment before departure.

### Direct-starting the climate system

- 1 Go to the  tab and tap .
  - 2 Tap **Start**.
- The climate system starts and runs for 30 minutes.

For vehicles with automatic transmissions, there is also the option to remote start the vehicle to more quickly reach a comfortable temperature. Read more about Remote Start of the vehicle in the separate section.

### Setting climate system timers

A timer can be set to automatically start the climate system to warm up the passenger compartment before departure. Up to 8 different timers can be set. Each timer can be set by selecting a time and day of the week and indicating whether the setting should be repeated every week.

Timers are set from  in the  tab.

### Other climate settings

Heating of the driver's seat, passenger's seat and steering wheel<sup>[2]</sup> is automatically activated in cold weather.

\* Option/accessory.

<sup>[1]</sup> Certain markets only.

<sup>[2]</sup> Applies to vehicles equipped with steering wheel heating.

---

## 13.2.11. Remote start of air purification using the Volvo Cars app

With the Volvo Cars app, you can start the vehicle's air purification\* remotely to improve the air quality before departure.

Go to the  tab and tap  (air purification).

The content of this manual represents the status of the user manual at the time of printing and may not be completely valid in future instances. For more information refer to the first page for the complete disclaimer note.

- 1
- 2 Tap **Start**.

\* Option/accessory.

---

## 13.2.12. Using the Volvo Cars app with an Apple Watch

You can use an Apple Watch to access certain Volvo Cars app functions, such as starting/stopping the parking climate and locking/unlocking the vehicle.

When the Volvo Cars app is installed on a phone and connected to the vehicle, the app functions will be automatically available in the Apple Watch that is paired with the phone.

Functions that can be controlled from an Apple Watch<sup>[1]</sup>:

- Parking climate (start/stop).
- Remote start of vehicle (start/stop).
- Doors (lock/unlock).
- Find the vehicle by activating the vehicle's horn and/or turn signals for a few seconds.
- View estimated range.
- View the vehicle's location on a map.

### Pairing an Apple Watch with a phone

For instructions on how to pair an Apple Watch with a phone, as well as the technical requirements for this, see Apple's website.

### Technical requirements

Technical requirements for operating systems and information about cell model compatibility can be found on the information page in the relevant app store.

<sup>[1]</sup> Available functions can vary over time.

---

## 13.2.13. Removing the connection between the Volvo Cars app and the vehicle

Before uninstalling the Volvo Cars app, you need to make sure that the connection between the app and the vehicle is removed or that your vehicle ownership is correctly ended in the app. Only deleting the Volvo Cars app may lead to problems connecting to the vehicle in the future.

**The content of this manual represents the status of the user manual at the time of printing and may not be completely valid in future instances. For more information refer to the first page for the complete disclaimer note.**



## Ending ownership in the Volvo Cars app

If you sell your vehicle, you need to end your ownership and remove the link between the Volvo Cars app and the vehicle from the administrator account in the app. If you do not have access to the app, contact your Volvo retailer and explain that you want to sell your vehicle.

To end ownership and remove the link:

- 1 Go to **Connected vehicles** in the  tab.
  - 2 Select the relevant vehicle.
  - 3 Tap **I no longer own this Volvo** and follow the instructions in the app.
- When ownership is ended, user history and other user accounts will be deleted. An automatic factory reset of the vehicle will also be performed, so that profiles, user data, linked keys, personalized settings, etc. are deleted.

The Volvo ID is personal and therefore does not need to be changed or deleted if you sell the vehicle.

Contact your Volvo retailer if you would like to delete your contact information from their system.

## Removing the connection between a paired phone and the vehicle

The connection between a paired phone and the vehicle can be removed either from the Volvo Cars app or from the vehicle's center display. Users with administrator rights can see and disconnect all phones paired with the vehicle. Other users can only see and disconnect their own phone.

### Via the Volvo Cars app

- 1 Go to **Connected vehicles** in the  tab.
- 2 Select the relevant vehicle.
- 3 Tap **Disconnect** next to the device you want to remove and follow the instructions in the app.

### Via the center display

- 1 Go to .
- 2 Select **Profiles**.
- 3 Select **Volvo Cars app devices**.
- 4 Tap the phone you want to remove and select **Unpair this phone**.

---

## **13.2.14. Change of ownership when the Volvo Cars app is connected to the vehicle**

When the vehicle changes owners, there are several steps that need to be carried out to disconnect the previous owner and allow the new owner to connect the Volvo Cars app to the vehicle.

### **Selling a vehicle**

The previous owner needs to remove the link between the vehicle and the Volvo Cars app. Once ownership is ended, an automatic factory reset of the vehicle will be performed, so that profiles, user data, linked keys, personalized settings, etc. are deleted.

### **Purchasing a vehicle**

The new owner will need to connect the Volvo Cars app to the vehicle.

### **Change of ownership to another country**

When a vehicle is purchased and imported to another country, further measures may be necessary. Contact a retailer for information.

---

# 14. Navigation

---

## 14.1. Map updates

---

### 14.1.1. Map downloads

To help ensure access to maps in Google Maps even when the vehicle has a poor or no Internet connection, map data is saved automatically.

Maps automatically downloads maps based on the vehicle's current location and travel patterns. These maps can be used when the vehicle does not have an Internet connection to:

- provide map data to the vehicle's safety and navigation functions
- provide access to Maps in areas with limited or no Internet connection.

A map area can also be selected manually and downloaded.

 **Note**

The above instructions provide a general description and include third-party suppliers. Availability, procedures and functionality may vary or be changed.

---

## 14.2. Google Maps

The Google Maps app contains maps and gives you access to traffic information, route guidance, suitable charging station locations, etc.



Maps can be used both when the vehicle has an Internet connection and when it doesn't, but more services are available when the vehicle is online.

### Same information in the vehicle as on other devices

Connecting your Google account to the active user profile also makes the services more personalized. Destinations given on other devices, such as home, work, favorites and most recent searches, will be shown. If you change something on one device, it will also be changed in Maps if the device and the vehicle are logged in to the same Google account.

## Voice control

Maps can also be voice-controlled using the Google Assistant<sup>[1]</sup>.

### Note

The above instructions provide a general description and include third-party suppliers. Availability, procedures and functionality may vary or be changed.

### Warning

Observe the following:

- Direct all your attention to the road and make sure that your concentration is focused on driving.
- Follow applicable traffic laws and use good judgment while driving.
- Road conditions can be affected by weather or season, which may make certain recommendations less reliable.

<sup>[1]</sup> The Google Assistant is not yet available in all languages.

---

## 14.3. Use Google Maps

Maps is displayed and managed in the center display and in the instrument panel using the steering wheel keypad. Maps can also be managed using voice control.

### Opening and closing Maps



To open Maps, tap its icon in the center display. To close the app, press the Home button.

When the app is open, the map and current traffic information will be shown.

### Shortcuts

There are shortcuts in the navigation tile, each of which initiates a search in Maps. Examples of shortcuts:

- Service stations
- Restaurant

When a route has been entered in Maps, there will be an extra shortcut to stop current guidance.

### Note

The above instructions provide a general description and include third-party suppliers. Availability, procedures and functionality may vary or be changed.

 **Warning**

Observe the following:

- Direct all your attention to the road and make sure that your concentration is focused on driving.
- Follow applicable traffic laws and use good judgment while driving.
- Road conditions can be affected by weather or season, which may make certain recommendations less reliable.

---

## 14.4. Updating Google Maps

Try to keep Maps updated to the latest version.

Updated versions of Maps are available in Google Play. If there are any differences in access rights between the two versions of the app, the system will prompt the user to accept the new terms.

Using the latest version ensures that you have the most recent updates and functions. To update Maps, the vehicle must be connected to the Internet and an active Google account must be connected to the user profile.

When a Maps update is available, you will receive a notification asking if you would like to update.

---

## 14.5. Google Maps settings

The majority of the Maps settings are adjusted directly in the app under settings. Several examples are listed below.

### Voice guidance level

Set the level for voice guidance, for example if you only want to hear traffic information and not the next maneuver.

### Route options

Set, for example, preferences to avoid road tolls and highways in route guidance.

 **Note**

The above instructions provide a general description and include third-party suppliers. Availability, procedures and functionality may vary or be changed.

### Other settings

Voice guidance volume

Turn the volume control below the center display or use the buttons on the steering wheel's right-side keypad. An expandable menu will open in the center display. Set the volume for voice guidance.

#### Language and units

If you would like to change the language or measurement units used in Maps, you can change these settings in App view . Please note that changing this setting will change the language and units used in all of the vehicle's displays, not only Maps.

#### Note

Changing languages in the center display could mean that certain information in the Owner's Manual will not comply with national or local laws and regulations. Do not change to a language you do not speak well, as it can be difficult to find your way back through the menu.

## 14.6. Electric vehicle functions with Google Maps

Some functions in Maps are unique for electric vehicles. Here are some of these, along with brief explanations.

The functions listed are only examples. For up-to-date information on which functions are available and how they work, go to [g.co/mapsincarc](https://g.co/mapsincarc) [<https://g.co/mapsincarc>].

The functions that relate to battery level are based on historic use of the vehicle and can be influenced by factors such as speed, driving style and use of electrical equipment.

### Filter by charging stations

By default, the map only shows compatible charging stations.

### Battery charge level at arrival

Maps can show the estimated battery level at arrival at a destination.

### Estimated minimum charging time

When charging stations are input as waypoints in an itinerary, Maps will indicate the minimum estimated charging time at that charging station to clarify total travel time and ETA <sup>[1]</sup>.

### Suggestions for adding charging stations

If route guidance is started and the system estimates that the vehicle cannot reach its final destination on the current battery level, Maps will suggest adding charging stations at suitable places so that the final destination can be reached.

 **Note**

The above instructions provide a general description and include third-party suppliers. Availability, procedures and functionality may vary or be changed.

[1] Estimated Time of Arrival

---

## 14.7. Google Maps in the instrument panel

Guidance to destinations can be displayed in the instrument panel, along with step-by-step instructions and a map. The map can also be displayed even if no destination has been specified.

Different map and guidance information will be displayed depending on the selected display mode in the instrument panel. Examples of information in the instrument panel:

- Arrows indicating next maneuver
- Distance to maneuver
- Name of next street
- Road number and exit number
- Lane information

Turn-by-Turn guidance points provide clear driving directions on the instrument panel and minimize the need to move your eyes from the road.

---

## 14.8. Destinations in Google Maps

You can enter several types of destinations in Maps.

Various types of destinations can be entered in the search field. In addition to addresses, you can also enter a specific destination, such as a museum, and request route guidance there. You can also perform more general searches, such as for charging stations, restaurants and hotels, and then select one of the search results as a destination and get route guidance there.

If a Google account is connected to the vehicle, destinations given on other devices, such as home, work, favorites and most recent searches, will be shown in Maps.

 **Note**

A poor connection can adversely affect the functions.

## 14.9. Connected functions with Google Maps

For full Maps functionality, the vehicle must be connected to the Internet. The following is a list of some functions that are available when the vehicle is online.

Maps is updated continuously with traffic information and information from parking spots, charging stations and connected Google accounts.

The functions listed are only examples. For up-to-date information on which functions are available and how they work, go to [g.co/mapsincarcar](https://g.co/mapsincarcar) [<https://g.co/mapsincarcar>].

### Traffic information

If traffic is moving slowly, the map will show orange or red lines, depending on traffic speed. If the vehicle loses its Internet connection, the colored lines will disappear after a few minutes because this information will no longer be current. Updated traffic information will be shown again once the connection has been reestablished. The map also shows information about different types of obstacles, such as road construction or accidents.

If any accidents or other obstacles are detected along the current route and another faster route is identified, Maps will suggest an alternative route.

### Alternative route

When a destination is entered, a route will be suggested along with alternative routes. The suggestions are based on system settings, traffic information, estimated range, travel time, etc. To choose an alternative route, select the route in the list of suggested routes or steer the vehicle in the direction of that route, so-called decide by steering.

If you change route during the trip, Google Maps will dynamically redirect you based on current traffic patterns so that you can avoid traffic congestion.

#### Note

The above instructions provide a general description and include third-party suppliers. Availability, procedures and functionality may vary or be changed.

## 14.10. Creating route guidance with Google Maps

Enter the destination in the search field and let Maps create a route.

- 1 Open Maps in Home view or App view .
  - 2 Enter an address or location in the search field.
- A route will be suggested and shown in blue on the map. Alternative routes will be indicated in gray. The available routes for selection may be affected if preferences have been set to, for example, avoid road tolls or highways.



- 3 If another route is preferred, tap the route overview icon and choose an alternative route.
- 4 Start navigation.
  - Instructions in the instrument panel and voice guidance<sup>[1]</sup> will begin.

Maps can also be voice-controlled using the Google Assistant<sup>[2]</sup>.

 **Note**

The above instructions provide a general description and include third-party suppliers. Availability, procedures and functionality may vary or be changed.

For more information, go to [g.co/mapsincar](https://g.co/mapsincar) [<https://g.co/mapsincar>].

 **Warning**

Observe the following:

- Direct all your attention to the road and make sure that your concentration is focused on driving.
- Follow applicable traffic laws and use good judgment while driving.
- Road conditions can be affected by weather or season, which may make certain recommendations less reliable.

#### Adding a waypoint to an existing route

- 1 Select a shortcut.
- 2 Select a waypoint.
  - The route will be recalculated.

## Trip information in the navigation tile

When a route has been entered in Maps, the navigation tile will display the following trip information about the next waypoint along the route:

- Travel time
- Distance to waypoint
- Estimated time of arrival, ETA<sup>[3]</sup>
- Name of next waypoint
- Specific information for electric vehicles, e.g. estimated battery level at arrival.

Current route guidance can be canceled directly from the tile.

The information displayed concerns the next waypoint. The final destination will be shown when there are no more waypoints along the route.

<sup>[1]</sup> Voice guidance can be switched off in settings in the Maps app via the center display.

<sup>[2]</sup> The Google Assistant is not yet available in all languages.

<sup>[3]</sup> Estimated Time of Arrival

---

# 15. Wheels and tires

---

## 15.1. Changing a wheel

---

### 15.1.1. Changing a wheel

Wheel changes must always be carried out correctly. The following instructions show how to remove and install a wheel and what is important to keep in mind. Make sure that the tire dimension is approved for use on the vehicle.

 **Warning**

- If a tire must be changed near passing traffic, make sure all passengers move to a safe location.
- Use a jack\* intended for the vehicle when changing a tire. For any other job, use stands to support the vehicle.
- Never crawl under or allow any part of your body to be extended under a vehicle supported by a jack.
- Never let anyone remain in the vehicle when it is raised on a jack.

 **Important**

If a jack\* is provided with your vehicle, it is intended to be used only in temporary situations such as changing wheels in the event of a flat tire. Only the jack that came with your particular model should be used to lift the vehicle. If the vehicle needs to be lifted more frequently, or for a longer period of time than for a wheel change, a garage jack or hoist is recommended. Always follow this device's instructions for use.

When not in use, the jack should be kept in its storage compartment under the cargo compartment floor. Crank the jack to the correct position so that it fits.

### Removing a wheel

Read through all instructions before starting. Before raising the vehicle using a jack or lift, take out all the tools you will need.

- 1 Turn on the vehicle's hazard warning flashers if a wheel change must be performed in an area with traffic.
- 2 Make sure that the parking brake is engaged and put the gear selector in P position.
- 3 Place chocks in front of and behind the wheels that are still on the ground. For example, use heavy wooden blocks or large stones.

- Using the lug wrench \*, screw the towing eye into place as far as possible.



- Remove the plastic covers from the wheel bolts using the designated tool or pull off the wheel cap.



- With the vehicle still on the ground, use the lug wrench/towing eye to loosen the wheel bolts  $\frac{1}{2}$ -1 turn by pressing downward (counterclockwise). Always start with the locking wheel bolts\*.
- Follow the instructions for safely lifting the vehicle using a jack.
- Raise the vehicle until the wheel to be changed can move freely. Unscrew the wheel bolts and lift off the wheel.

## Installing a wheel

- Clean the contact surfaces between the wheel and the wheel hub.
- Lift the wheel into place. If the vehicle has tires or wheels of different sizes on the front and back, make sure the correct dimensions are used for each position. Tighten the wheel bolts securely.  
Do **not** grease the wheel bolt threads.
- Lower the vehicle so that the wheel cannot rotate.
- Tighten the wheel bolts in a crisscross pattern (as shown in illustration). It is important that the wheel bolts are securely

tightened. Tighten to 140 Nm (103 ft. lbs.). Use a torque wrench to check torque.



5 Depending on tire equipment:

- Replace the wheel cap over the wheel bolts by aligning it with the guide marks and then pressing it into place.
- Press the plastic covers over the wheel bolts.

6 Check the tire inflation pressure and store the new inflation pressure in the tire pressure monitoring system\*.

 **Warning**

The wheel bolts may need to be tightened again several days after a wheel change. Temperature fluctuations and vibrations can cause them to loosen slightly.

 **Note**

- After inflating a tire, always replace the valve cap to help prevent valve damage caused by gravel, dirt, etc.
- Use plastic valve caps only. Metal caps could corrode and become difficult to remove.

\* Option/accessory.

---

## 15.1.2. Jack\*

The jack can be used to lift the vehicle to e.g. change a wheel.



**!** Important

If a jack\* is provided with your vehicle, it is intended to be used only in temporary situations such as changing wheels in the event of a flat tire. Only the jack that came with your particular model should be used to lift the vehicle. If the vehicle needs to be lifted more frequently, or for a longer period of time than for a wheel change, a garage jack or hoist is recommended. Always follow this device's instructions for use.

When not in use, the jack should be kept in its storage compartment under the cargo compartment floor. Crank the jack to the correct position so that it fits.

The jack needs to be cranked together to the correct position in order to fit.

**i** Note

For vehicles with leveling control\*: If the vehicle is equipped with pneumatic suspension, this feature must be turned off before the vehicle is lifted onto a tow truck.

\* Option/accessory.

## 15.1.3. Wheel bolts

The wheel bolts hold the wheel in place on the wheel hub.

Only use rims that have been tested and approved by Volvo and are included in Volvo's original product range.

Use a torque wrench to check that the wheel bolts are tightened correctly.

Do **not** grease the wheel bolt threads.

 **Warning**

The wheel bolts may need to be tightened again several days after a wheel change. Temperature fluctuations and vibrations can cause them to loosen slightly.

 **Important**

The wheel bolts should be tightened to 140 Nm (103 ft. lbs.). Over-tightening or under-tightening could damage the threaded joints.

## Locking wheel bolt kit\*

To loosen or tighten the locking wheel bolts, turn the wrench in the locking bolt until it fully engages in the code grooves. When removing a wheel, always start with the locking wheel bolts. When mounting a wheel, end with the locking bolt.

 **Important**

Make sure you have a solid connection between bolt and wheel bolt key when loosening/tightening the wheel bolts. Applying force at an angle could damage the slots in the wheel bolts and the wheel bolt key and make it impossible to install or remove the wheel.

When the wheel bolt key\* is not being used, stow it in its designated location in the foam block under the cargo compartment floor. This is important to remember so that the tool is available if the vehicle is taken to a workshop. If you lose the key, contact your Volvo retailer.

\* Option/accessory.

---

## 15.1.4. Spare wheel

The spare wheel<sup>[1]</sup> is a Temporary Spare and can be used to temporarily replace one of the vehicle's regular wheels with a punctured tire.

The spare wheel is only intended for temporary use. Replace it with a normal wheel as soon as possible.

The driving characteristics of the vehicle change and ground clearance reduces when the spare wheel is used. Do not wash the vehicle in an automatic car wash while using the Temporary Spare.

The recommended tire pressure must be maintained regardless of at which position the temporary spare wheel is used on the vehicle.

If the spare wheel is damaged, a replacement can be purchased from a Volvo retailer.

 **Warning**

Current legislation prohibits the use of the "Temporary Spare" wheel other than as a temporary replacement for a punctured tire. It must be replaced as soon as possible by a standard tire. Roadholding and handling may be affected with the "Temporary Spare" wheel in use.

 **Warning**

- Never drive faster than 80 km/h (50 mph) with a spare tire mounted on the vehicle.
- The vehicle must never be driven with more than one "Temporary Spare" wheel mounted.
- Driving with a spare wheel may alter the driving characteristics of the vehicle. Replace the spare wheel with a normal wheel as soon as possible.
- The spare wheel is smaller than the normal wheel, which affects the vehicle's ground clearance. Watch for high curbs and do not wash the vehicle in an automatic car wash when a spare wheel is mounted.
- Follow the manufacturer's recommended tire inflation pressure for the spare wheel.
- On all-wheel drive vehicles, the drive on the rear axle can be disconnected.
- If the spare wheel is mounted on the front axle, snow chains must not be used.
- The spare wheel must not be repaired.

 **Important**

The vehicle must not be driven with wheels of different dimensions or with a spare tire other than the one the vehicle is approved for. Using tires of different sizes can seriously damage the vehicle's transmission due to different rolling circumferences.

Vehicles designed for different front and rear tire or wheel dimensions must have the same type and make of tire on the front and rear axles.

<sup>[1]</sup> Not available on all models.

---

## 15.1.5. Handling the spare wheel

Follow these instructions regarding handling the spare wheel<sup>[1]</sup>.



## Accessing the spare wheel



This illustration is generic and appearance may vary.

The spare wheel is located under the cargo compartment floor in the spare wheel well. The spare tire is secured with a bolt that goes through the tire and attaches it to the body. The foam block contains all tools needed to change a wheel.

- 1 Lift the rear edge of the cargo compartment floor.
- 2 Unscrew the retaining bolt.
- 3 Lift out the spare wheel.

## Stowing a flat tire

- 1 Screw the spare tire's retaining bolt back on.

### **Important**

Do not attempt to unscrew the lower part of the retaining bolt if it is attached to the body, as this could cause it to break.

If the retaining bolt becomes dislodged from its lower attachment point in the body under the spare tire, replace it in the hole and turn clockwise to secure it again.

### **Warning**

On vehicles with 48 V batteries, the bolt is attached to the battery box instead of the body. If the lower part of the retaining bolt is not dislodged when the spare tire is taken out, it should be removed to help prevent injury when the flat tire is replaced.

- 2 Put the tools back in their correct positions in the foam block.

- 3 Then lower the trunk/cargo compartment floor and place the punctured tire in the trunk/cargo compartment.

[1] Not available on all models.

## 15.1.6. Snow chains

Using snow chains and/or snow tires can help improve traction in winter driving conditions.

Volvo recommends that snow chains are not used on wheel dimensions larger than 18 inches.

### **Warning**

Use Volvo genuine snow chains or equivalent snow chains that are suitable for the vehicle model and the tire and wheel sizes. Only **one-sided** snow chains are permitted.

If uncertain about snow chains, Volvo recommends contacting an authorized Volvo workshop. Use of the wrong snow chains could cause serious damage to the vehicle and result in an accident.

Using snow chains could result in malfunction of the system for monitoring of tire inflation pressures\* <sup>[1]</sup>.

### **Important**

Snow chains can be used on the vehicle, with the following restrictions:

- Always follow the manufacturer's installation instructions carefully. Install chains as tightly as possible and retighten periodically.
- Only put snow chains on the front wheels (also applies to all-wheel drive vehicles).
- If accessory, aftermarket or "custom" tires and wheels with different dimensions than the original tires and wheels are used, snow chains in some cases may NOT be used. Sufficient distance between the chains and brakes, suspension and body components must be maintained.
- Check local regulations regarding the use of snow chains before installing.
- Never exceed the snow chain manufacturer's specified maximum speed limit. Under no circumstances should you exceed 50 km/h (30 mph).
- Avoid bumps, holes or sharp turns when driving with snow chains.
- Avoid driving on surfaces without snow as this wears out both the snow chains and the tires.
- The handling of the vehicle can be adversely affected when driving with chains. Avoid fast or sharp turns as well as locked wheel braking.
- Some types of strap-on chains affect brake components and therefore must NOT be used.

Consult a Volvo retailer for more information about snow chains.

\* Option/accessory.

<sup>[1]</sup> Tire Pressure Monitoring System (TPMS)

---

## 15.1.7. Snow tires

Snow tires are designed for winter driving conditions.

Volvo recommends snow tires with specific dimensions. The tire dimensions vary depending on engine type. When driving with snow tires, the correct type of tires must be mounted on all four wheels.

### Tips for changing snow tires

When switching between regular tires and snow tires, mark the tires according to which side they were mounted on, e.g. **L** for left and **R** for right.

Contact a Volvo retailer for advice on the most suitable rims and tires.

### Studded tires

Studded tires should be broken in by driving 500–1000 km (300–600 miles) slowly and gently to help the studs settle properly in the tires. This gives the tire, and especially the studs, a longer service life.

#### Note

Legal requirements concerning the use of studded tires may vary. Always follow local laws and regulations.

### Tread depth

Road conditions with ice, slush and low temperatures place considerably higher demands on tires than summer conditions. Volvo therefore recommends not driving on snow tires that have a tread depth of less than 4 mm (0.15 inch).

---

## 15.1.8. Flat tire

Turn on the hazard warning flashers if you get a flat tire near passing traffic.

Move the vehicle out of traffic if this can be done safely. Call road assistance if necessary.

If possible, exit the vehicle on the side with the least traffic.

### Handling a flat tire

The vehicle is equipped with either a tire sealing system for temporarily sealing a tire, or a spare wheel<sup>[1]</sup>. See the relevant section for instructions on use.

<sup>[1]</sup> Not available on all models.

---

## 15.1.9. Tool kit

Tools for e.g. towing or changing wheels are provided in the vehicle's cargo compartment.

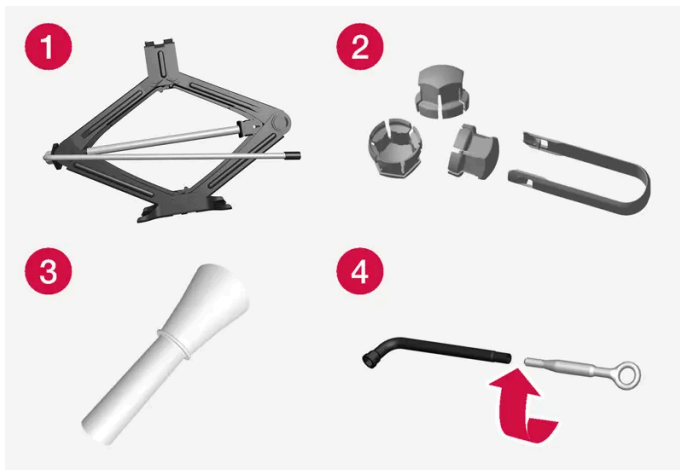

Examples of tools that may be found in the vehicle.

- 1 Jack\*
- 2 Tool for removing the plastic wheel bolt covers
- 3 Funnel for refilling fluids
- 4 Wheel bolt key\* and towing eyelet

If the vehicle is equipped with a spare tire\*<sup>[1]</sup>, a jack and wheel bolt key are provided instead of the tire sealing system.

\* Option/accessory.

<sup>[1]</sup> Not available on all models.

# 15.2. Tires

## 15.2.1. Tire sidewall designations

The following information can be found on a tire's sidewall.



Federal law mandates that tire manufacturers place standardized information on the sidewall of all tires (see the illustration).

The vehicle has been certified with certain combinations of wheels and tires.

The following information is listed on the tire sidewall:

The tire designation:

**Note**

Please be aware that the following tire designation is an **example only** and that this particular tire may not be available on your vehicle.

1. 215: The width of the tire (in millimeters) from sidewall edge to sidewall edge. The larger the number, the wider the tire.
2. 65: The ratio of the tire's height to its width in percent.
3. R: Radial tire (the designation RF and the  symbol indicate that the vehicle is equipped with optional self-supporting run flat tires<sup>[1]</sup>).
4. 15: The diameter of the wheel rim (in inches).
5. 95: The tire's load index. In this example, a load index of 95 equals a maximum load of 1521 lbs (690 kg).
6. H: The tire's speed rating, or the maximum speed at which the tire is designed to be driven for extended periods of time, carrying a permissible load for the vehicle, and with correct inflation pressure. For example, H indicates a speed rating of 210 km/h (130 mph).

**Note**

The tire's load index and speed rating may not appear on the sidewall because they are not required by law.

7. M+S or M/S = Mud and Snow, AT = All Terrain, AS = All Season

The content of this manual represents the status of the user manual at the time of printing and may not be completely valid in future instances. For more information refer to the first page for the complete disclaimer note.

8. U.S. DOT Tire Identification Number (TIN): This begins with the letters "DOT" and indicates that the tire meets all federal standards. The next two numbers are the factory code where the tire was manufactured, the next two are the tire size code and the last four numbers represent the week and year the tire was made. For example, 0717 means that the tire was manufactured during week 7 of 2017. The numbers in between are marketing codes used at the manufacturer's discretion. This information helps a tire manufacturer identify a tire for safety recall purposes.
9. Tire Ply Composition and Material Used: Indicates the number of plies indicates or the number of layers of rubber-coated fabric in the tire tread and sidewall. Tire manufacturers also must indicate the ply materials in the tire and the sidewall, which include steel, nylon, polyester, and others.
10. Maximum Load: Indicates the maximum load in pounds and kilograms that can be carried by the tire. Refer to the vehicle's tire information placard located on the B-Pillar for the correct tire pressure for your vehicle.
11. Treadwear, Traction, and Temperature grades.
12. Maximum permissible inflation pressure: The greatest amount of air pressure that should ever be put in the tire. This limit is set by the tire manufacturer.

## Speed Symbol

A tire's Speed Symbol (SS) indicates the maximum speed for which the tire has been certified and should be at least equivalent to the vehicle's top speed.

Winter tires, with or without studs, are exceptions and may use a lower SS. When winter tires are installed, the vehicle may not be driven faster than the tires' SS.

The vehicle's speed should always be determined by the posted speed limit and traffic and road conditions, not the tire's SS.

The following table indicates the maximum permissible speed for each SS.

M	130 km/h (81 mph)
Q	160 km/h (100 mph)
T	190 km/h (118 mph)
H	210 km/h (130 mph)
V	240 km/h (149 mph)
W	270 km/h (168 mph)
Y	300 km/h (186 mph)

### Warning

- The wheel and tire sizes for your Volvo are specified to meet stringent stability and handling requirements. Unapproved wheel/tire size combinations can negatively affect your vehicle's stability and handling.
- Any damage caused by installation of unapproved wheel/tire size combinations will not be covered by your new vehicle warranty. Volvo assumes no responsibility for death, injury, or expenses that may result from such installations.

<sup>[1]</sup> Self-supporting run flat tires may not be available on all models.

## 15.2.2. Uniform Tire Quality Grading

**ALL PASSENGER VEHICLE TIRES MUST CONFORM TO FEDERAL SAFETY REQUIREMENTS IN ADDITION TO THESE GRADES.**

Quality grades can be found, where applicable, on the tire sidewall between the tread shoulder and maximum section width. For example:

Treadwear 200 Traction AA Temperature A

## TREADWEAR

The treadwear grade is a comparative rating based on the wear rate of the tire when tested under controlled conditions on a specified government test course. For example, a tire graded 150 would wear one and one half (1 ½) times as well on the government course as a tire graded 100. The relative performance of tires depends upon the actual conditions of their use, however, and many depart significantly from the norm due to variation in driving habits, maintenance practices and differences in road characteristics and climate.

## TRACTION

The traction grades, from highest to lowest, are AA, A, B, and C, as measured under controlled conditions on specified government test surfaces of asphalt and concrete. A tire marked C may have poor traction performance.

### Warning

The traction grade assigned to this tire is based on braking (straight-ahead) traction tests and is not a measure of cornering (turning) traction.

## TEMPERATURE

The temperature grades are A (the highest), B, and C, representing the tire's resistance to the generation of heat and its ability to dissipate heat when tested under controlled conditions on a specified indoor laboratory test wheel. Sustained high temperature can cause the material of the tire to degenerate and reduce tire life, and excessive temperature can lead to sudden tire failure. The grade C corresponds to a minimum level of performance that all passenger vehicle tires must meet under the Federal Motor Safety Standard No. 109. Grades B and A represent higher levels of performance on the laboratory test wheel than the minimum required by law.

### Warning

The temperature grade for this tire is established for a tire that is properly inflated and not overloaded. Excessive speed, under-inflation, or excessive loading, either separately or in combination, can cause heat buildup and tire failure.

---

## 15.2.3. Tire terminology

The following is a glossary of tire-related terms.

The tire suppliers may have additional markings, notes or warnings such as standard load, radial tubeless, etc.

- Tire information placard: A placard showing the OE (Original Equipment) tire sizes, recommended inflation pressure, and the maximum weight the vehicle can carry.

- **Tire Identification Number (TIN):** A number on the sidewall of each tire providing information about the tire brand and manufacturing plant, tire size and date of manufacture.
- **Inflation pressure:** A measure of the amount of air in a tire.
- **Standard load:** A class of P-metric or Metric tires designed to carry a maximum load at 35 psi [37 psi (2.5 bar) for Metric tires]. Increasing the inflation pressure beyond this pressure will not increase the tires load carrying capability.
- **Extra load:** A class of P-metric or Metric tires designed to carry a heavier maximum load at 41 psi [43 psi (2.9 bar) for Metric tires]. Increasing the inflation pressure beyond this pressure will not increase the tire's load carrying capability.
- **kPa:** Kilopascal, a metric unit of air pressure.
- **PSI:** Pounds per square inch, a standard unit of air pressure.
- **B-pillar:** The structural member at the side of the vehicle behind the front door.
- **Bead area of the tire:** Area of the tire next to the rim.
- **Sidewall of the tire:** Area between the bead area and the tread.
- **Tread area of the tire:** Area of the perimeter of the tire that contacts the road when mounted on the vehicle.
- **Rim:** The metal support (wheel) for a tire or a tire and tube assembly upon which the tire beads are seated.
- **Maximum load rating:** A figure indicating the maximum load in pounds and kilograms that can be carried by the tire. This rating is established by the tire manufacturer.
- **Maximum permissible inflation pressure:** The greatest amount of air pressure that should ever be put in the tire. This limit is set by the tire manufacturer.
- **Recommended tire inflation pressure:** Inflation pressure, established by Volvo, which is based on the type of tires that are mounted on a vehicle at the factory. This information can be found on the tire inflation placard(s) located on the driver's side B-pillar and in the tire inflation table.
- **Cold tires:** The tires are considered to be cold when they have the same temperature as the surrounding (ambient) air. This temperature is normally reached after the vehicle has been parked for at least 3 hours.

---

## 15.2.4. Approved tire pressure

The following tire pressures are recommended by Volvo for your vehicle. Refer to the tire inflation placard for information specific to the tires installed on your vehicle at the factory.

Tire dimensions	Cold tire pressure for up to five persons	
	Front psi (kPa)	Rear psi (kPa)
235/60 R17 235/55 R18 235/50 R19 245/45 R20	33 (230)	33 (230)
245/40 R21	35 (240)	35 (240)
Temporary spare tire T125/70 R18 T125/80 R18	60 (420)	60 (420)



## 15.2.5. Tire direction of rotation

Tires with tread designed to roll in only one direction are marked with an arrow on the sidewall.

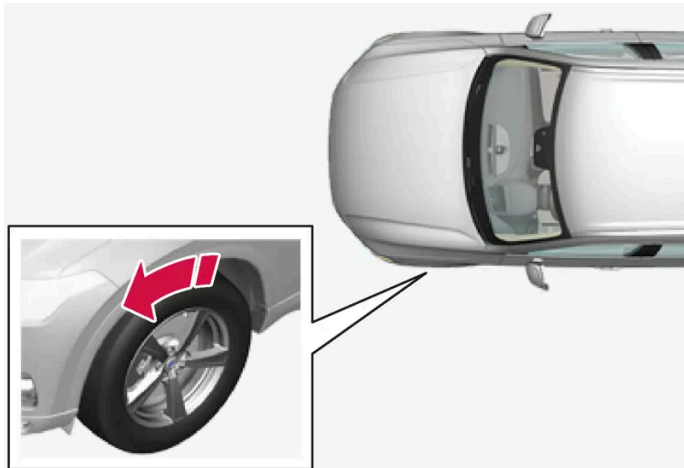

The arrow shows the tire's direction of rotation.

- Tires should maintain the same direction of rotation throughout their service life.
- Tires should only be moved between the front and back, never from right to left or vice versa.
- Incorrectly mounted tires impair the vehicle's braking properties and ability to force aside rain, snow and slush.
- The tires with the most tread should always be mounted on the rear wheels to help reduce the risk of rear-wheel skidding.
- Never switch positions between the front and rear axles on vehicles with different front and rear tire or wheel dimensions.
- To help reduce the risk of rear-wheel skid when driving on wet roads, Volvo recommends that the rear tires do not have significantly less tread than the front tires.

### **i** Note

Make sure to have tires of the same type, dimensions and make on both the front and rear axles.

Vehicles with different front and rear tire dimensions must have the same type and make of tire on the front and rear axles.

## 15.2.6. Tread wear indicator

The tread wear indicator shows the status of the tire's tread.

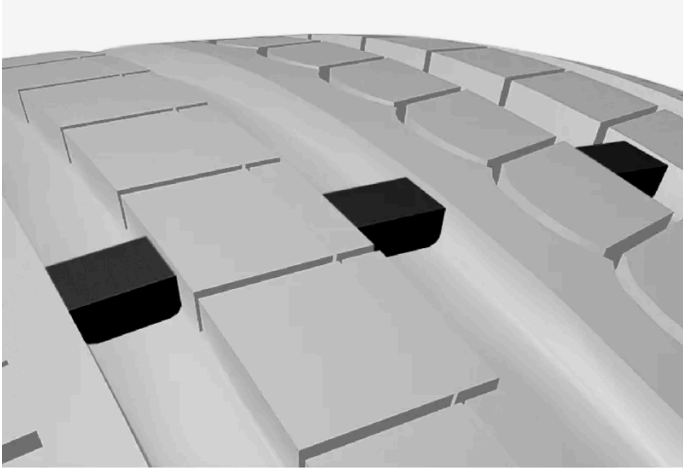

The tread wear indicator is a narrow elevated strip running across the tire's longitudinal tread grooves. The letters TWI (Tread Wear Indicator) are visible on the side of the tire. When approximately 1.6 mm (1/16 inch) is left on the tread, the tread will be at the same height as the tread wear indicator. Replace the tire as soon as possible. Tires with low tread offer very poor traction in rain or snow.

---

## 15.3. Tire inflation pressure

---

### 15.3.1. Tire inflation pressure monitoring

---

#### 15.3.1.1. Tire Pressure Monitoring System \*

The tire pressure monitoring system<sup>[1]</sup> provides a warning symbol in the instrument panel if pressure is too low in one or more tires.



This symbol illuminates to indicate low inflation pressure. Check the inflation pressure in the **Car status** app in the center display.

If there is a system malfunction, the inflation pressure warning symbol will flash for approximately one minute and then glow steadily.

#### System description

The tire pressure monitoring system measures differences in rotational speed between the wheels through the ABS system to determine if the tires are properly inflated. If inflation pressure in a tire is too low, its diameter (and consequently its rotational speed) changes. By comparing the tires with each other, the system can determine if the pressure in one or more tires is too low.

## General information about the tire pressure monitoring system

In the following description, the tire monitoring system is generally referred to as TPMS.

Each tire, including the spare (if provided) <sup>[2]</sup> should be checked monthly when cold and inflated to the inflation pressure recommended by the vehicle manufacturer on the vehicle placard or tire inflation pressure label. (If your vehicle has tires of a different size than the size indicated on the vehicle placard or tire inflation pressure label, you should determine the proper tire inflation pressure for those tires.)

As an added safety feature, your vehicle has been equipped with a tire pressure monitoring system (TPMS) that illuminates a low tire pressure telltale when one or more of your tires is significantly under-inflated. Accordingly, when the low tire pressure telltale illuminates, you should stop and check your tires as soon as possible, and inflate them to the proper pressure.

Driving on a significantly under-inflated tire causes the tire to overheat and can lead to tire failure. Under-inflation also reduces fuel efficiency and tire tread life, and may affect the vehicle's handling and stopping ability. Please note that the TPMS is not a substitute for proper tire maintenance, and it is the driver's responsibility to maintain correct tire pressure, even if under-inflation has not reached the level to trigger illumination of the TPMS low tire pressure telltale.

Your vehicle has also been equipped with a TPMS malfunction indicator to indicate when the system is not operating properly. The TPMS malfunction indicator is combined with the low tire pressure telltale. When the system detects a malfunction, the telltale will flash for approximately one minute and then remain continuously illuminated. This sequence will continue upon subsequent vehicle start-ups as long as the malfunction exists. When the malfunction indicator is illuminated, the system may not be able to detect or signal low tire pressure as intended.

TPMS malfunctions may occur for a variety of reasons, including the installation of replacement or alternate tires or wheels on the vehicle that prevent the TPMS from functioning properly.

Always check the TPMS malfunction telltale after replacing one or more tires or wheels on your vehicle to ensure that the replacement or alternate tires and wheels allow the TPMS to continue to function properly.

## To keep in mind

- Always save the new inflation pressure in the system after changing a tire or adjusting the inflation pressure.
- Using snow chains can affect tire inflation pressure monitoring. This is indicated by a symbol and message in the instrument panel. When the snow chains are removed, all tires should be checked and adjusted to the recommended inflation pressure. The new inflation pressure should then be saved in the tire pressure monitoring system.
- If you switch to a tire of another size than the factory-mounted tires, the system must be reset by storing a new inflation pressure for these tires to avoid false warnings.
- If a spare wheel <sup>[2]</sup> is used, it is possible that the tire pressure monitoring system will not work correctly due to the differences between the wheels.
- The system does not replace the need for regular tire inspection and maintenance.
- It is not possible to deactivate the tire pressure monitoring system.

### Warning

- Incorrect inflation pressure could lead to tire failure, which could cause the driver to lose control of the vehicle.
- The system cannot predict sudden tire damage.

\* Option/accessory.

[1] Tire Pressure Monitoring System (TPMS)

[2] Not available on all models.

---

## 15.3.1.2. Viewing tire pressure status in the center display\*

With the system for tire pressure monitoring<sup>[1]</sup>, tire pressure status can be viewed in the center display.

### Checking status

The vehicle may need to be driven for a few minutes at a speed above 35 km/h (22 mph) to activate the system.

- 1 Tap  in the center display.
- 2 Tap **Car status** to see the tire inflation pressure status.

\* Option/accessory.

[1] Tire Pressure Monitoring System (TPMS)

---

## 15.3.1.3. Action when warned of low tire pressure

When the inflation pressure monitoring system<sup>[1]</sup> detects low inflation pressure in a tire, immediate action is required.



If the system's indicator symbol illuminates and the message about low inflation pressure is displayed, check the tire pressure and inflate if necessary.

- 1 Switch off the ignition.
- 2 Check the inflation pressure on all four tires using a tire pressure gauge.
- 3 Inflate the tire to the correct inflation pressure; see the tire pressure placard on the driver's side B pillar for recommended pressures for factory-mounted tires.
- 4 After the inflation pressure has been adjusted, always save the new inflation pressure in the system via the center display. This can only be done when the vehicle is running and stationary.

Please be aware that the indicator symbol will not go out until the low tire pressure has been corrected and a storing procedure has been started for the new inflation pressure.

The vehicle may need to be driven for a few minutes at a speed above 35 km/h (22 mph) for the system to be able to store the new reference value.

 **Note**

To help prevent incorrect inflation pressure, pressure should be checked when the tires are cold. The tires are considered to be cold when they have reached the same temperature as the ambient temperature (about 3 hours after the vehicle was last driven). After driving for a few kilometers, the tires will warm up and the pressure will increase.

 **Note**

- After inflating a tire, always replace the valve cap to help prevent valve damage caused by gravel, dirt, etc.
- Use plastic valve caps only. Metal caps could corrode and become difficult to remove.

 **Warning**

- Incorrect inflation pressure could lead to tire failure, which could cause the driver to lose control of the vehicle.
- The system cannot predict sudden tire damage.

<sup>[1]</sup> Tire Pressure Monitoring System (TPMS)

---

## 15.3.1.4. Saving new reference values for tire inflation pressure monitoring\*

In order for the tire pressure monitoring system<sup>[1]</sup> to function correctly, tire pressure reference values must be saved correctly. To help ensure that the system can correctly alert the driver of low inflation pressure, this must be done each time the tires are changed or the inflation pressure is adjusted.

To store the new inflation pressure as a reference value in the system:

- 1 Switch off the ignition.
- 2 Inflate the tire to the correct inflation pressure; see the tire pressure placard on the driver's side B pillar for recommended pressures for factory-mounted tires.
- 3 Start the vehicle.
- 4 Tap  in the center display.

Tap **Car status**.

The content of this manual represents the status of the user manual at the time of printing and may not be completely valid in future instances. For more information refer to the first page for the complete disclaimer note.

- 5  
6 Tap **Store pressure**. When the inflation pressure is stored, the vehicle must be on and stationary.

 **Note**

The **Store pressure** button is used to save new reference values for inflation pressure in the tire pressure monitoring system. For safety reasons, it is only available (selectable) when the vehicle is stationary and the engine is running.

- 7 The inflation pressure must be saved after adjusting the inflation pressure or if the tire is replaced. Adjust the inflation pressure to the recommended value and tap **Confirm** to store the inflation pressure.

 **Note**

To prevent the **Store pressure** function from being activated inadvertently, it is necessary to confirm in a second step that the inflation pressure should be saved.

- 8 Drive the vehicle until the new inflation pressure has been saved. The new inflation pressure is stored when the vehicle is driven at speeds over 35 km/h (22 mph).
- > When enough data has been collected for the system to detect low inflation pressure, the animation showing the progress of the procedure for storing a new reference value will disappear from the center display.

If storing cannot be performed, a message will be displayed.

 **Warning**

The exhaust gases contain carbon monoxide, which is invisible and odorless but very poisonous. The procedure for saving a new inflation pressure must therefore always be performed outdoors or in a workshop with exhaust gas extraction.

\* Option/accessory.

<sup>[1]</sup> Tire Pressure Monitoring System (TPMS)

## 15.3.1.5. Messages for tire inflation pressure monitoring\*

A number of messages related to the tire pressure monitoring system<sup>[1]</sup> can be displayed. Several examples are provided below.

Center display: Storing pressure required due to updated software	The software has been updated and the tire inflation pressure must be saved again. Check the tire inflation pressure and fill as needed.

Instrument panel: TPMS unavailable Open Car Status app to Store Pressure	The indicator symbol flashes and changes to a steady glow after about one minute. See "Car status" in the center display for more information.
Instrument panel: Tire pressure low Check Car Status app in center display	The indicator symbol will illuminate to indicate that inflation pressure is low in one or more tires. See "Car status" in the center display for more information.
Instrument panel: Tire pressure system Temporarily unavailable	The indicator symbol will flash for about 1 minute and then glow steadily. The system is temporarily unavailable and will be activated momentarily.
Instrument panel: Tire pressure system Service required	The indicator symbol will flash for about 1 minute and then glow steadily. If the system is not working properly, contact a workshop <sup>[2]</sup> .

\* Option/accessory.

<sup>[1]</sup> Tire Pressure Monitoring System (TPMS)

<sup>[2]</sup> An authorized Volvo workshop is recommended.

## 15.3.2. Checking tire pressure

Correct inflation pressure helps improve driving stability, reduce energy consumption and increase the service life of the tires.

Tire pressure decreases over time, which is normal. Tire pressure also varies depending on the ambient temperature. Driving on under-inflated tires could cause the vehicle to overheat and lead to damage. Tire pressure affects traveling comfort, road noise and driving characteristics.

Check the pressure in the tires every month. Use the recommended inflation pressure for cold tires to help maintain good tire performance. Under-inflated or over-inflated tires could cause uneven tread wear.

Use an air pressure gauge and check the inflation pressure on all the tires, including the spare tire<sup>[1]</sup>, at least once a month and before long trips. Volvo recommends buying a reliable air pressure gauge, as the automatic gauges provided at service stations may be inaccurate.

### Warning

- Under-inflation is the most common cause of tire failure. This can result in severe tire cracking, tread separation, tire blow out or reduced control of the vehicle, which can lead to an increased risk of injury.
- Under-inflated tires reduce the load carrying capacity of your vehicle.

## Cold tires

Inflation pressure should be checked when the tires are cold. The tires are considered to be cold when they have the same temperature as the surrounding (ambient) air. This temperature is normally reached after the vehicle has been parked for at least 3 hours.

After driving for approximately 1.6 km (1 mile), the tires are considered to be warm. If you have to drive farther than that to inflate the tire, check and record your inflation pressure first. Then fill to an appropriate inflation pressure when you arrive at the pump.

When the ambient temperature changes, so does the inflation pressure. A 10-degree temperature drop causes a corresponding drop in inflation pressure of 7 kPa (1 psi). Check the inflation pressure of the tires regularly and adjust to the correct pressure, which can be found on the vehicle's tire information decal or certification label.

If you check inflation pressure when the tires are warm, you should never release air. The tires become warm after driving and it is normal for warm tires to have an inflation pressure above the recommended pressure for cold tires. A warm tire with an inflation pressure equal to or under the recommended pressure for cold tires could be significantly under-inflated.

<sup>[1]</sup> Not available in all models.

---

## 15.3.3. Adjusting tire pressure

Tire pressure decreases over time, which is normal. The tire pressure must therefore be adjusted to maintain the recommended tire pressure.

Use the recommended inflation pressure for cold tires to help maintain good tire performance and even wear.

### Note

To help prevent incorrect inflation pressure, pressure should be checked when the tires are cold. The tires are considered to be cold when they have reached the same temperature as the ambient temperature (about 3 hours after the vehicle was last driven). After driving for a few kilometers, the tires will warm up and the pressure will increase.

- 1 Remove the valve cap from the tire and press the air pressure gauge firmly onto the valve.
- 2 Inflate the tire to the correct inflation pressure; see the tire pressure placard on the driver's side B pillar for recommended pressures for factory-mounted tires.
- 3 Screw the valve cap back on.

### Note

- After inflating a tire, always replace the valve cap to help prevent valve damage caused by gravel, dirt, etc.
- Use plastic valve caps only. Metal caps could corrode and become difficult to remove.

- 4 Visually inspect the tire to make sure there are no nails or other embedded objects that could puncture the tire and cause air leakage.
- 5 Check the sidewalls to make sure there are no gouges, cuts, bulges or other irregularities.
- 6 Repeat this procedure for each tire, including the spare tire <sup>[1]</sup>.



**Note**

If you have overfilled the tire, release air by pushing on the metal stem in the center of the valve. Then recheck the pressure with your tire gauge.

Some spare tires require higher inflation pressure than the other tires. Consult the tire inflation pressure table or the inflation pressure decal.

[1] Not available on all models.

## 15.3.4. Location of tire pressure decal

The tire pressure placard on the driver's side B pillar (between the front and the rear door) indicates tire pressure for different loads and speed conditions.



Tire pressure decal

The decal specifies the designation for the factory-mounted tires on the vehicle, as well as load limits and inflation pressures.

**Note**

The decals shown in the Owner's Manual do not claim to be exact reproductions of those found in the vehicle. The purpose is to show approximately how they look and about where they are located on the vehicle. The information that applies for your vehicle in particular is found on the decal on the vehicle.

## 15.4. Temporary tire sealing

## 15.4.1. Tire sealing system

The temporary tire sealing system<sup>[1]</sup> (TMK) can be used to seal a puncture hole in a tire or to check and adjust the inflation pressure in the tire.

Models equipped with a spare wheel<sup>[2]</sup> do not have the tire sealing system.

### **Warning**

#### California Proposition 65

Operating, servicing and maintaining a passenger vehicle can expose you to chemicals including engine exhaust, carbon monoxide, phthalates, and lead, which are known to the State of California to cause cancer and birth defects or other reproductive harm. To minimize exposure, avoid breathing exhaust, do not idle the engine except as necessary, service your vehicle in a well ventilated area and wear gloves or wash your hands frequently when servicing your vehicle. For more information go to [www.P65Warnings.ca.gov/passenger-vehicle](http://www.P65Warnings.ca.gov/passenger-vehicle) [<https://www.p65warnings.ca.gov/products/passenger-vehicle>].

The tire sealing system consists of a compressor and a bottle containing sealing compound. The sealing functions as a temporary repair.

### **Note**

The sealing compound effectively seals tires with punctures in the tread but may not be able to fully seal tires with punctures in the sidewall. Do not use the tire sealing system on tires with large tears, cracks or similar damage.

### **Note**

The compressor is intended for temporary tire sealing and is approved by Volvo.

## Location

The tire sealing system is located in a foam block under the floor of the cargo compartment.



## Sealing compound expiration date

The content of this manual represents the status of the user manual at the time of printing and may not be completely valid in future instances. For more information refer to the first page for the complete disclaimer note.

The sealing compound bottle must be replaced if its expiration date has passed (see the decal on the bottle). Handle the old bottle as hazardous waste.

<sup>[1]</sup> Certain models only.

<sup>[2]</sup> Not available on all models.

---

## 15.4.2. Inflating tires using the compressor included in the tire sealing system

The vehicle's original tires can be inflated using the compressor in the tire sealing system.

- 1 The compressor must be switched off. Make sure that the switch is in the 0 (Off) position and take out the electrical cable and the hose.
- 2 Attach the hose directly in the compressor's bottle holder and then turn clockwise 90 degrees.  
Move the warning sticker to the side of the compressor; it doesn't need to be affixed to the wheel side if the sealing compound is not used.
- 3 Unscrew the tire's valve cap and screw the hose's valve connector as far as possible onto the valve.
- 4 Connect the electrical cable to the nearest 12 V outlet and start the vehicle.

 **Warning**

Inhaling exhaust fumes could lead to serious injury. Never leave the engine running in an enclosed space or a space without sufficient ventilation.

 **Warning**

Never leave children unattended in the vehicle while the vehicle is running.

- 5 Start the compressor by moving the switch to the I (On) position.

6  **Important**

Risk of overheating. The compressor should not be running for longer than 10 minutes at a time.

Inflate the tire to the pressure specified on the tire pressure decal on the driver's side door pillar. If the inflation pressure is too high, use the air release valve to release air.

- 7 Switch off the compressor. Remove the hose and the electrical cable.

- 8 Screw the valve cap back onto the tire.
- 9 If needed, save the new tire pressure in the tire pressure monitoring system.\*

**Note**

- After inflating a tire, always replace the valve cap to help prevent valve damage caused by gravel, dirt, etc.
- Use plastic valve caps only. Metal caps could corrode and become difficult to remove.

**Note**

The compressor is an electric device. Follow local regulations for disposal.

\* Option/accessory.

## 15.4.3. Using the tire sealing system

The temporary tire sealing system (TMK<sup>[1]</sup>) can be used to seal a puncture in a tire. Read through all the instructions before use.

### Overview

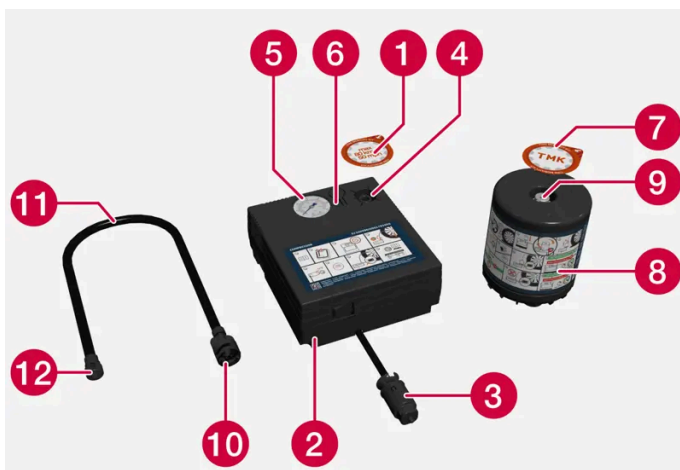

- 1 Speed limit sticker
- 2 Switch
- 3 Electrical cable
- 4 Bottle holder
- 5 Air pressure gauge
- 6 Air release valve

The content of this manual represents the status of the user manual at the time of printing and may not be completely valid in future instances. For more information refer to the first page for the complete disclaimer note.

- 7 Decal, wheel-side warning
- 8 Sealing compound bottle
- 9 Bottle opening
- 10 Connection for bottle
- 11 Hose
- 12 Connection valve

## Connecting



### **Warning**

Please keep the following points in mind when using the tire sealing system:

- The sealing compound bottle contains natural rubber latex. These substances are harmful if swallowed.
- The contents of this bottle may cause allergic skin reactions or otherwise be potentially harmful to the respiratory tract, the skin, the central nervous system, and the eyes.

Precautions:

- Keep out of reach of children.
- Do not ingest the contents.
- Avoid prolonged or repeated contact with the skin. Remove any clothing that has come into contact with sealant.
- Wash thoroughly after handling.

First aid:

- Skin: Wash affected areas of the skin with soap and water. Get medical attention if symptoms occur.
- Eyes: Flush with plenty of water for least 15 minutes, occasionally lifting the upper and lower eyelids. Get medical attention if symptoms occur.
- Inhalation: Move the exposed person to fresh air. If irritation persists, get medical attention.
- Ingestion: Get medical attention.
- Disposal: Dispose of this material and its container at a hazardous or special waste collection point. Always follow federal and local environmental regulations.

 **Warning**

Do not remove the bottle or the hose while the tire sealing system is being used.

 **Note**

If the puncture was caused by a nail or similar object, do not remove it from the tire. It will help to seal the hole.

## 1 Preparations

Turn on the vehicle's hazard warning flashers if the tire sealing system is to be used in an area with traffic.

- 2 Peel off the speed limit sticker from the side of the compressor. Affix the decal to a clearly visible location on the windshield to remind the driver not to exceed this speed limit. Do not drive faster than 80 km/h (50 mph) while using a tire that has been temporarily repaired with the tire sealing system.

Also peel off the warning decal and affix it securely to the side of the wheel.

- 3 Make sure the switch is in the 0 (Off) position and take out the electric cable and the hose.
- 4 Attach the sealing compound bottle to the compressor and then turn clockwise 90 degrees.  
The bottle is equipped with a check valve that prevents fluid leakage when the bottle is not connected to the compressor.
- 5 Attach the hose in the bottle opening and turn clockwise 90 degrees.
- 6 Unscrew the tire's valve cap and screw the hose's valve connector as far as possible onto the valve.

## 7 Begin tire sealing

Connect the electrical cable to the nearest 12 V outlet and start the vehicle.

 **Note**

Make sure that none of the vehicle's other 12 V sockets are used while the compressor is running.

 **Warning**

Never leave children unattended in the vehicle while the vehicle is running.

 **Warning**

Inhaling exhaust fumes could lead to serious injury. Never leave the engine running in an enclosed space or a space without sufficient ventilation.

- 8 Start the compressor by moving the switch to the I (On) position.

When the compressor starts, the pressure can increase up to 7 bar (102 psi), but the pressure will decrease after approx. 30 seconds.

 **Warning**

Never stand next to a tire being inflated with the compressor. If cracks, bulges, etc. form on the tire, switch off the compressor immediately. The vehicle should not be driven. Call roadside assistance to have the vehicle towed to a workshop for inspection/replacement of the tire. Volvo recommends an authorized workshop.

**9** Inflate the tire for 7 minutes.

 **Important**

To help avoid overheating, the compressor should never be used for more than 10 minutes at a time.

**10** Switch off the compressor and check the inflation pressure using the air pressure gauge. The inflation pressure should be between 1.8 bar (26 psi) and 2.5 bar (36 psi). If the inflation pressure is too high, use the air release valve to release air.

The sealing compound bottle must be removed in order to access the air release valve. Remove the bottle in the following order:

1. Remove the hose from the tire's valve.
2. Remove the hose from the bottle.
3. Remove the bottle from the compressor.
4. Reconnect the hose directly to the compressor.
5. Screw the hose back on to the tire's valve.
6. Release air by pressing the air release valve.

 **Warning**

If pressure falls below 1.8 bar (26 psi), the hole in the tire may be too large. The vehicle should not be driven. Call roadside assistance to have the vehicle towed to a workshop for inspection/replacement of the tire. Volvo recommends an authorized workshop.

**11** Switch off the compressor and remove the electrical cable.

**12** Unscrew the hose from the tire's valve and screw the valve cap back on.

 **Note**

- After inflating a tire, always replace the valve cap to help prevent valve damage caused by gravel, dirt, etc.
- Use plastic valve caps only. Metal caps could corrode and become difficult to remove.

**13** Clean the hose before stowing it and make sure that no sealing compound is leaking out.

**14** Immediately drive the vehicle at least 3 km (2 miles) at a maximum speed of 80 km/h (50 mph) to allow the sealing compound to seal the tire, and then recheck the inflation pressure.

 **Warning**

During the tire's first revolution, some sealing compound may spray out of the puncture hole. Before driving away, make sure that no one is near the vehicle who could be sprayed with sealing compound. Make sure no one is within 2 meters (7 feet) of the vehicle.

## 15 Rechecking the inflation pressure

Connect the hose to the tire's valve and screw the hose connector onto the valve as far as possible. The compressor must be switched off.

### 16 Check the inflation pressure on the air pressure gauge.

- If the pressure is under 1.3 bar (19 psi), the tire is not sufficiently sealed. The vehicle should not be driven. Call roadside assistance to have the vehicle towed.
- If the inflation pressure is higher than 1.3 bar (19 psi), the tire must be inflated to the inflation pressure specified on the tire pressure decal on the driver's side door pillar (1 bar = 100 kPa = 14.5 psi). If the inflation pressure is too high, use the air release valve to release air.

 **Warning**

Check inflation pressure regularly.

Volvo recommends driving to the nearest authorized Volvo workshop to have the tire replaced/repaired. Inform the workshop that the tire contains sealing compound.

The sealing compound bottle and the hose must be replaced after use. Volvo recommends contacting an authorized Volvo workshop for replacement.

 **Warning**

After using the tire sealing system, the vehicle should not be driven farther than approximately 200 km (120 miles).

 **Note**

The compressor is an electric device. Follow local regulations for disposal.

<sup>[1]</sup> Temporary Mobility Kit

## 15.5. Driving in winter



## 15.5.1. Snow chains

Using snow chains and/or snow tires can help improve traction in winter driving conditions.

Volvo recommends that snow chains are not used on wheel dimensions larger than 18 inches.

### Warning

Use Volvo genuine snow chains or equivalent snow chains that are suitable for the vehicle model and the tire and wheel sizes. Only **one-sided** snow chains are permitted.

If uncertain about snow chains, Volvo recommends contacting an authorized Volvo workshop. Use of the wrong snow chains could cause serious damage to the vehicle and result in an accident.

Using snow chains could result in malfunction of the system for monitoring of tire inflation pressures\* <sup>[1]</sup>.

### Important

Snow chains can be used on the vehicle, with the following restrictions:

- Always follow the manufacturer's installation instructions carefully. Install chains as tightly as possible and retighten periodically.
- Only put snow chains on the front wheels (also applies to all-wheel drive vehicles).
- If accessory, aftermarket or "custom" tires and wheels with different dimensions than the original tires and wheels are used, snow chains in some cases may NOT be used. Sufficient distance between the chains and brakes, suspension and body components must be maintained.
- Check local regulations regarding the use of snow chains before installing.
- Never exceed the snow chain manufacturer's specified maximum speed limit. Under no circumstances should you exceed 50 km/h (30 mph).
- Avoid bumps, holes or sharp turns when driving with snow chains.
- Avoid driving on surfaces without snow as this wears out both the snow chains and the tires.
- The handling of the vehicle can be adversely affected when driving with chains. Avoid fast or sharp turns as well as locked wheel braking.
- Some types of strap-on chains affect brake components and therefore must NOT be used.

Consult a Volvo retailer for more information about snow chains.

\* Option/accessory.

<sup>[1]</sup> Tire Pressure Monitoring System (TPMS)

---

## 15.5.2. Snow tires

Snow tires are designed for winter driving conditions.

The content of this manual represents the status of the user manual at the time of printing and may not be completely valid in future instances. For more information refer to the first page for the complete disclaimer note.

Volvo recommends snow tires with specific dimensions. The tire dimensions vary depending on engine type. When driving with snow tires, the correct type of tires must be mounted on all four wheels.

## Tips for changing snow tires

When switching between regular tires and snow tires, mark the tires according to which side they were mounted on, e.g. **L** for left and **R** for right.

Contact a Volvo retailer for advice on the most suitable rims and tires.

## Studded tires

Studded tires should be broken in by driving 500–1000 km (300–600 miles) slowly and gently to help the studs settle properly in the tires. This gives the tire, and especially the studs, a longer service life.

### Note

Legal requirements concerning the use of studded tires may vary. Always follow local laws and regulations.

## Tread depth

Road conditions with ice, slush and low temperatures place considerably higher demands on tires than summer conditions. Volvo therefore recommends not driving on snow tires that have a tread depth of less than 4 mm (0.15 inch).

---

## 15.5.3. Preparing for a long trip

It is important to have the vehicle's systems and equipment checked carefully before driving long distances.

Check that

- the engine is running properly and that fuel consumption is normal
- there are no leaks (fuel, oil or other fluid)
- the brake pedal is functioning properly
- all lights work
- tire tread depth and air pressure are at correct levels. Change to snow tires when driving in areas where there is a risk of snowy or icy roads
- the start battery is sufficiently charged
- the wiper blades are in good condition

---

## 15.5.4. Winter driving

It is important to check the vehicle before driving in cold/snowy conditions to make sure it can be driven safely.

Before the cold season arrives:

- Make sure the engine coolant contains 50% antifreeze. This mixture helps protect the engine from frost erosion down to approx.  $-35\text{ }^{\circ}\text{C}$  ( $-31\text{ }^{\circ}\text{F}$ ). Do not mix different types of antifreeze as this could pose a health risk.
- Keep the fuel tank well filled to prevent condensation from forming.
- Check the viscosity of the engine oil. Oil with low viscosity (thinner oil) improves cold-weather starting and reduces fuel consumption when driving with a cold engine.
- Check the condition and charge level of the start battery. Cold weather places greater demands on the start battery and reduces its capacity.
- Check the condition and charge level of the battery. Cold weather places greater demands on the battery and reduces its capacity.
- Use washer fluid containing antifreeze to help prevent ice from forming in the washer fluid reservoir.

See separate section for engine oil recommendations.

## Slippery driving conditions

To help optimize traction and roadholding, Volvo recommends using snow tires on all wheels whenever there is a risk of snow or ice on the road.

### Note

Certain countries require use of winter tires by law. Not all countries permit the use of studded tires.

Practice driving on slippery surfaces under controlled conditions to learn how the vehicle reacts.

---

## 15.6. Tires

The function of the tires is to carry loads, provide traction on road surfaces, reduce vibrations and protect the wheels from wear.

The tires significantly influence the vehicle's driving characteristics. The type, dimensions, tire pressure and speed rating have a considerable impact on how the vehicle performs.

Your vehicle is equipped with tires according to the vehicle's tire information placard on the B-pillar (the structural member at the side of the vehicle, at the rear of the driver's door opening).

### Warning

A damaged tire could cause the driver to lose control of the vehicle.

**!** Important

Some Volvo models are equipped with an Ultra High Performance tire and wheel combination designed to provide maximum dry pavement performance with consideration for hydroplaning resistance. They may be more susceptible to road hazard damage and, depending on driving conditions, may achieve a tread life of less than 30,000 km (20,000 miles). Even if this vehicle is equipped with Volvo's advanced AWD or stability system, these tires are not designed for winter driving, and should be replaced with winter tires when weather conditions dictate.

The tires have good road holding characteristics and offer good handling on dry and wet surfaces. It should be noted however that the tires have been developed to give these features on snow/ice-free surfaces.

Most models are equipped with "all-season" tires, which provide a somewhat higher degree of roadholding on slippery road surfaces than tires without the "all-season" rating. However, Volvo recommends using snow tires on all four wheels for good roadholding on icy or snow-covered roads.

When replacing tires, be sure that the new tires are the same size designation, type (radial) and preferably from the same manufacturer, on all four wheels. Otherwise there is a risk of altering the vehicle's roadholding and handling characteristics.

## Recommended tires

On delivery, the car is equipped with Volvo original tires that have the VOL<sup>[1]</sup> marking on the side of the tires. These tires have been designed specifically for your vehicle. It is therefore important when replacing tires that the new tires have this same marking to help maintain the vehicle's driving characteristics, comfort and energy consumption.

## New tires

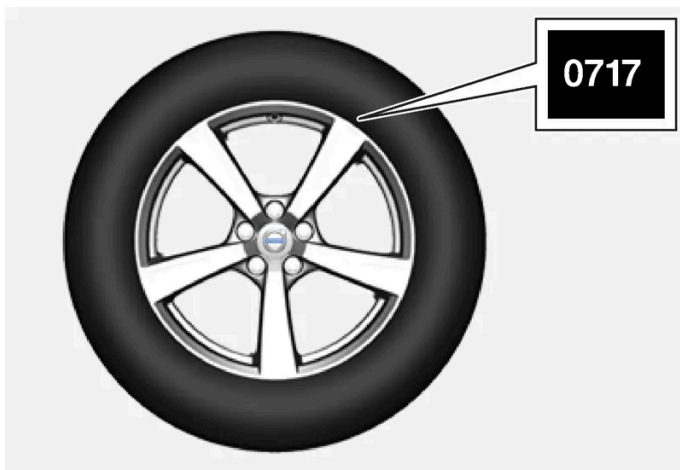

Tires are perishable goods. After a few years, they will begin to harden and their friction properties will gradually deteriorate. Always replace tires with the freshest tires possible. This is particularly important for snow tires. A series of numbers is imprinted on the sidewall of the tire. The last four digits in the series is the Department of Transportation (DOT) stamp and indicates the week and year the tire was manufactured. The tire in the illustration has 0717 as the last four digits, which means it was manufactured week 7 of 2017.

## Tire age

Tires degrade over time, even when they are not being used. It is recommended that tires generally be replaced after 6 years of normal service. Heat caused by hot climates, frequent high loading conditions or Ultra Violet (U.V.) exposure can accelerate the

aging process. The temporary spare <sup>[2]</sup> should also be replaced at 6-year intervals, even if it has never been used. A tire with e.g., visible cracks or discoloration should be replaced immediately.

## Tire economy

- Maintain correct tire pressure.
- Avoid fast starts, hard braking and tire screeching.
- Tire wear increases with speed.
- Correct front wheel alignment is very important.
- Unbalanced wheels impair tire economy and driving comfort.
- Tires should maintain the same direction of rotation throughout their lifetime.
- When you change tires, the tires with the most tread should be mounted on the rear axle to reduce the risk of rear wheel skid during hydroplaning, turning or hard braking on wet roads.
- Hitting curbs or potholes can damage the tires and/or wheels permanently.
- Never switch positions between the front and rear axles on vehicles with different front and rear tire or wheel dimensions.

## Tire rotation

Driving style, tire pressure, climate and road conditions affect how quickly the tires age and exhibit signs of wear. Maintaining the correct tire pressure helps keep tread wear evenly distributed.

To help prevent major differences in tread depth and wear patterns forming on the tires, the front and rear wheels can be rotated, i.e. the front tires moved to the rear and the rear tires moved to the front. Ideally, tire rotation should be done the first time after approximately 5000 km (approx. 3100 miles) and thereafter at 10,000 km (approx. 6200 miles) intervals.

If you have any questions regarding tread depth, Volvo recommends consulting an authorized Volvo workshop. If significant differences in wear (> 1 mm difference in tread depth) between the tires have already occurred, the least worn tires should be mounted on the rear wheels. A front wheel skid is usually easier to control than a rear-wheel skid. It is therefore important that the rear wheels do not lose grip before the front wheels.

### Important

Vehicles with different tire or wheel dimensions on the front and rear axles must always have the wider tires and/or wheels on the rear axle. Switching between front and rear wheels, e.g. to obtain more even tire wear between the front and rear tires, is not allowed.

## Storing wheels and tires

When storing complete wheels (tires mounted on rims), they should be suspended off the floor or placed on their sides on the floor.

Tires not mounted on rims should be stored on their sides or standing upright, but should not be suspended.

### Important

Tires should be stored in a cool, dry and dark location. They should never be stored near solvents, gasoline, oil, etc.

 **Warning**

- The wheel and tire sizes for your Volvo are specified to meet stringent stability and handling requirements. Unapproved wheel/tire size combinations can negatively affect your vehicle's stability and handling.
- Any damage caused by installation of unapproved wheel/tire size combinations will not be covered by your new vehicle warranty. Volvo assumes no responsibility for death, injury, or expenses that may result from such installations.

<sup>[1]</sup> This may vary for certain tire dimensions.

<sup>[2]</sup> Not available on all models.

---

## 15.7. Determining the vehicle's permitted weight

Properly loading your vehicle will provide maximum return of vehicle design performance.

### Weight designations

Before loading your vehicle, familiarize yourself with the following terms for determining your vehicle's weight ratings, with or without a trailer, from the vehicle's Federal/Canadian Motor Vehicle Safety Standards (FMVSS/CMVSS) label, and the vehicle's tire information placard:

#### Curb weight

The weight of the vehicle including a full tank of fuel and all standard equipment. It does not include passengers, cargo, or optional equipment.

#### Capacity weight

All weight added to the curb weight, including cargo and optional equipment. When towing, towbar weight is also part of cargo weight.

#### Permissible axle weight

The maximum allowable weight that can be carried by a single axle (front or rear). These numbers are shown on the Federal/Canadian Motor Vehicle Safety Standards (FMVSS/CMVSS) label. The total load on each axle must never exceed its maximum permissible weight.

#### Gross vehicle weight (GVW)

The vehicle's curb weight + cargo + passengers.

### Steps for Determining Correct Load Limit

- 1 Locate the statement "the combined weight of occupants and cargo should never exceed XXX kg or XXX lbs." on your vehicle's placard.

The content of this manual represents the status of the user manual at the time of printing and may not be completely valid in future instances. For more information refer to the first page for the complete disclaimer note.

- 2 Determine the combined weight of the driver and passengers that will be riding in your vehicle.
- 3 Subtract the combined weight of the driver and passengers from XXX kg or XXX lbs.
- 4 The resulting figure equals the available amount of cargo and luggage load capacity. For example, if the "XXX" amount equals 1400 lbs. and there will be five 150 lb. passengers in your vehicle, the amount of available cargo and luggage load capacity is 650 lbs. (1400 - 750 (5 × 150) = 650 lbs.)
- 5 Determine the combined weight of luggage and cargo being loaded on the vehicle. That weight may not safely exceed the available cargo and luggage load capacity calculated in Step 4.
- 6 If your vehicle will be towing a trailer, load from your trailer will be transferred to your vehicle. Consult this manual to determine how this reduces the available cargo and luggage load capacity of your vehicle.

 **Warning**

- Exceeding the permissible axle weight, gross vehicle weight, or any other weight rating limits can cause tire overheating resulting in permanent deformation or catastrophic failure.
- Do not use replacement tires with lower load carrying capacities than the tires that were original equipment on the vehicle because this will lower the vehicle's GVW rating. Use only tires with the correct load carrying capacity. Consult your Volvo retailer for information.

# 16. Loading, storage and passenger compartment

---

## 16.1. Loading

---

### 16.1.1. Loading recommendations

There are a number of things that are important to consider when carrying loads in or on the vehicle.

Load-carrying capacity is determined by the vehicle's curb weight. The total weight of all passengers and any installed accessories reduces the vehicle's load-carrying capacity by the corresponding amount.



#### Warning

The vehicle's driving characteristics change depending on the weight and position of the load.

### Loading the cargo compartment/trunk

Keep the following in mind when loading:

- Position objects so they are pressing against the rear seat backrests.
- Heavy objects should be positioned as low as possible. Avoid placing heavy objects on folded-down seat backrests.
- Cover sharp corners with a soft cloth or similar to help prevent damage to the upholstery.
- Use the load anchoring eyelets and tensioning straps or similar to secure all objects.



#### Warning

In a head-on collision at a speed of 50 km/h (30 mph), an unsecured object weighing 20 kg (44 pounds) can reach a projectile weight equivalent to 1000 kg (2200 pounds).



#### Warning

If objects are loaded higher than the upper edge of the side windows, leave a 10 cm (4 in.) space between the objects and the window. Objects placed closer to this could impede the function of the inflatable curtain concealed inside the headlining.



 **Warning**

Always secure the load. Otherwise, it may shift during heavy braking and injure people in the vehicle.

Cover sharp edges and sharp corners with something soft.

Turn off the engine and apply the parking brake when loading/unloading long objects. Otherwise, it is possible for the load to reach the gear lever or gear selector and move it to a drive position – which could cause the vehicle to begin rolling.

#### **Extra cargo space**

The rear seat backrests can be folded down to increase cargo space in the cargo compartment/trunk and simplify loading. If the rear seat backrests are folded down, make sure that no objects loaded into the vehicle prevent the WHIPS system for the front seats from functioning correctly.

The ski hatch\* in the rear seat can be folded down to carry skis or other long, thin objects.

\* Option/accessory.

---

## **16.1.2. Determining the vehicle's permitted weight**

Properly loading your vehicle will provide maximum return of vehicle design performance.

### **Weight designations**

Before loading your vehicle, familiarize yourself with the following terms for determining your vehicle's weight ratings, with or without a trailer, from the vehicle's Federal/Canadian Motor Vehicle Safety Standards (FMVSS/CMVSS) label, and the vehicle's tire information placard:

#### **Curb weight**

The weight of the vehicle including a full tank of fuel and all standard equipment. It does not include passengers, cargo, or optional equipment.

#### **Capacity weight**

All weight added to the curb weight, including cargo and optional equipment. When towing, towbar weight is also part of cargo weight.

#### **Permissible axle weight**

The maximum allowable weight that can be carried by a single axle (front or rear). These numbers are shown on the Federal/Canadian Motor Vehicle Safety Standards (FMVSS/CMVSS) label. The total load on each axle must never exceed its maximum permissible weight.

#### **Gross vehicle weight (GVW)**

The vehicle's curb weight + cargo + passengers.

## Steps for Determining Correct Load Limit

- 1 Locate the statement "the combined weight of occupants and cargo should never exceed XXX kg or XXX lbs." on your vehicle's placard.
- 2 Determine the combined weight of the driver and passengers that will be riding in your vehicle.
- 3 Subtract the combined weight of the driver and passengers from XXX kg or XXX lbs.
- 4 The resulting figure equals the available amount of cargo and luggage load capacity. For example, if the "XXX" amount equals 1400 lbs. and there will be five 150 lb. passengers in your vehicle, the amount of available cargo and luggage load capacity is 650 lbs. (1400 - 750 (5 × 150) = 650 lbs.)
- 5 Determine the combined weight of luggage and cargo being loaded on the vehicle. That weight may not safely exceed the available cargo and luggage load capacity calculated in Step 4.
- 6 If your vehicle will be towing a trailer, load from your trailer will be transferred to your vehicle. Consult this manual to determine how this reduces the available cargo and luggage load capacity of your vehicle.

### Warning

- Exceeding the permissible axle weight, gross vehicle weight, or any other weight rating limits can cause tire overheating resulting in permanent deformation or catastrophic failure.
- Do not use replacement tires with lower load carrying capacities than the tires that were original equipment on the vehicle because this will lower the vehicle's GVW rating. Use only tires with the correct load carrying capacity. Consult your Volvo retailer for information.

## 16.1.3. Grocery bag holders

Grocery bag holders (hooks) help keep shopping bags in place and prevent them from falling over and spilling their contents in the cargo compartment.

## On the sides of the cargo compartment



There is a grocery bag holder in the side panel on each side of the cargo compartment.

There are two grocery bag holders in the side panel on each side of the cargo compartment.

### Important

The grocery bag holders are only intended to hold weights up to 5 kg (11 lbs).

## Under the floor hatch \*



- 1 Lift the handle in the center of the load compartment floor and fold up the floor.
  - 2 Move the load compartment floor to the upright position and place it in the adjustment track on each side.
- It is now possible to hang grocery bags with handles at a suitable height on the hooks.

## In the glove compartment

The content of this manual represents the status of the user manual at the time of printing and may not be completely valid in future instances. For more information refer to the first page for the complete disclaimer note.

There is also a fold-out hook in the glove compartment that can be used to hang a shopping bag.

\* Option/accessory.

---

## 16.1.4. Cargo anchoring eyelets

The load anchoring eyelets in the cargo compartment can be used to secure objects with straps, a net, etc.

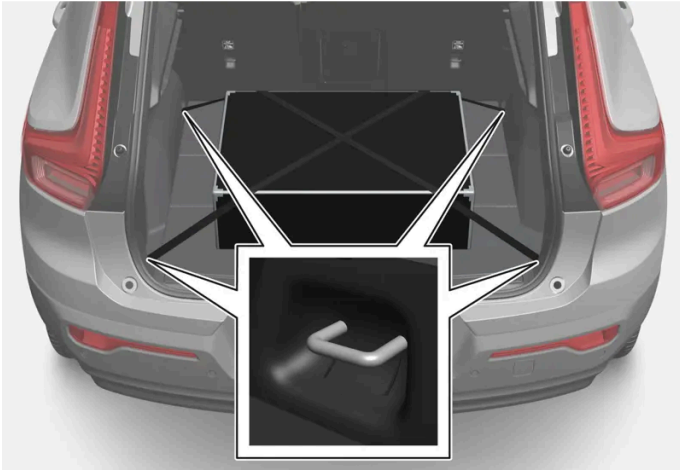

### **Warning**

Hard, sharp and heavy objects in or protruding from the vehicle can cause injury in the event of hard braking.

Always secure large and heavy objects with a seat belt or cargo retaining straps.

---

## 16.1.5. Installing and removing the cargo net\*

The cargo net helps prevent objects in the cargo compartment from entering the passenger compartment in the event of a sudden stop or hard braking.

The cargo net is attached at four points.

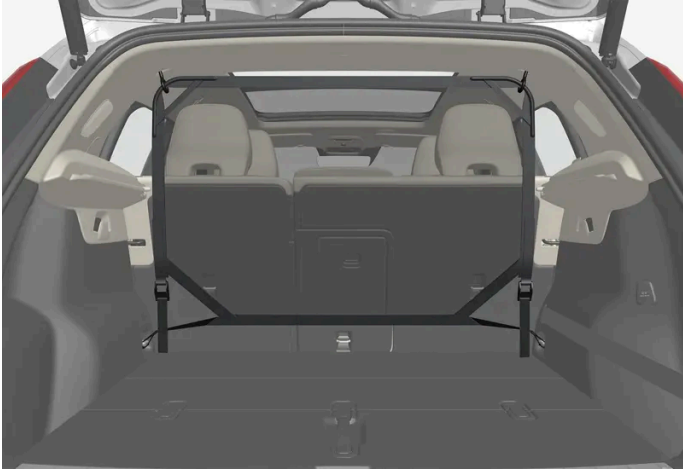

For safety reasons, the cargo net must always be mounted and secured according to the following description.

The net is made of strong nylon weave and can be attached in two different locations in the vehicle:

- Front mounting – behind the front seats.
- Rear mounting – behind the rear seats.

 **Warning**

Objects in the cargo compartment must always be securely anchored, even with a correctly installed cargo net.

## Installing the cargo net

 **Warning**

Make sure that the cargo net's upper attachments are correctly mounted and that the straps are hooked securely into place.

Never use the net if it is damaged.

 **Note**

With front mounting, the cargo net is most easily installed via the rear doors.

- 1 Fold out the cargo net with the upper hooks facing upwards.
- 2 Insert one of the net's hooks into the front or rear ceiling bracket with the strap lock facing you.
- 3 Insert the net's other upper hook into the ceiling bracket on the opposite side.

Make sure that the net's hooks are pushed forward as far as possible into their respective ceiling brackets.

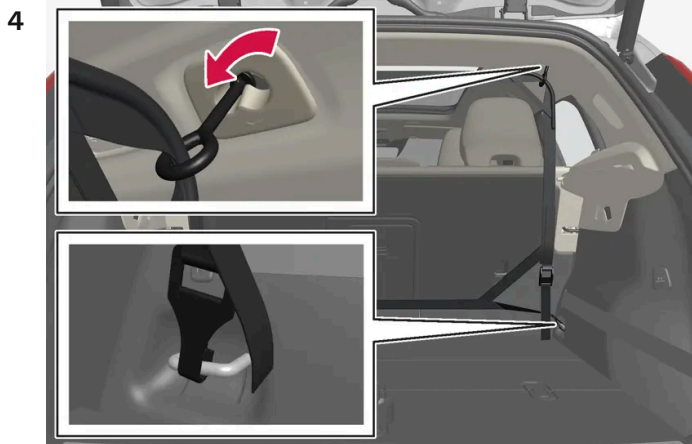

Rear mounting.

For rear mounting:

With the cargo net hooked into the rear ceiling brackets, attach the net's straps into the front cargo anchoring eyelets in the cargo compartment.

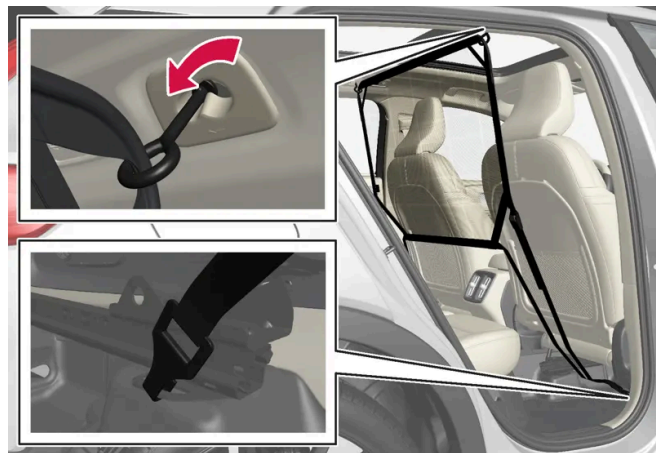

Front mounting.

For front mounting:

With the net mounted in the front ceiling brackets, hook the straps into the outer eyelets on the front seat rails behind the seats. Attaching the net is easier if the seat backrests are upright and the seats are moved slightly forward.

When moving the seat and backrest back again, make sure to not apply too much pressure against the net. Move the seat or backrest only until it touches the net.

 **Important**

If a seat or backrest is pressed with too much force back against the cargo net, the net and its ceiling brackets could be damaged.

5 Pull the straps until the cargo net is taut.

## Removing the cargo net

The cargo net can be easily removed and folded up.

- 1 Loosen the cargo net by pressing the button on the strap locks on each side and pulling to allow some slack.
- 2 Press in the catches and release both of the strap hooks.
- 3 Unhook the upper hooks and remove the net from the ceiling brackets.
- 4 Fold up the net and store it in its case.  
Replace clothing hooks, if desired.

\* Option/accessory.

---

## 16.1.6. Roof loads and load carriers

Volvo-developed load carriers are recommended for carrying loads on the roof of the vehicle.

These load carriers are specially designed to help prevent damage to your vehicle. Volvo load carriers are available from authorized Volvo retailers.

Carefully follow the installation instructions provided with the load carriers.

- Distribute the load evenly throughout the load carriers. Place heavier cargo at the bottom of the load.
- Check periodically to ensure that the load carriers and load are properly secured. Secure the load firmly using tie straps or similar.
- If the load is longer than the vehicle, such as a canoe or kayak, attach the towing eyelet in its front outlet and secure the tie straps in it.
- The vehicle's wind resistance and fuel consumption increase with the size of the load.
- Drive smoothly. Avoid rapid acceleration, hard braking and fast cornering.

### **Warning**

The vehicle's center of gravity and driving characteristics are altered by roof loads.

Follow the vehicle's specifications regarding weights and maximum permitted load.

---

## 16.2. Cargo compartment

---

## 16.2.1. Cargo net, steel cargo grid and cargo compartment cover

### 16.2.1.1. Installing and removing the cargo net \*

The cargo net helps prevent objects in the cargo compartment from entering the passenger compartment in the event of a sudden stop or hard braking.

The cargo net is attached at four points.

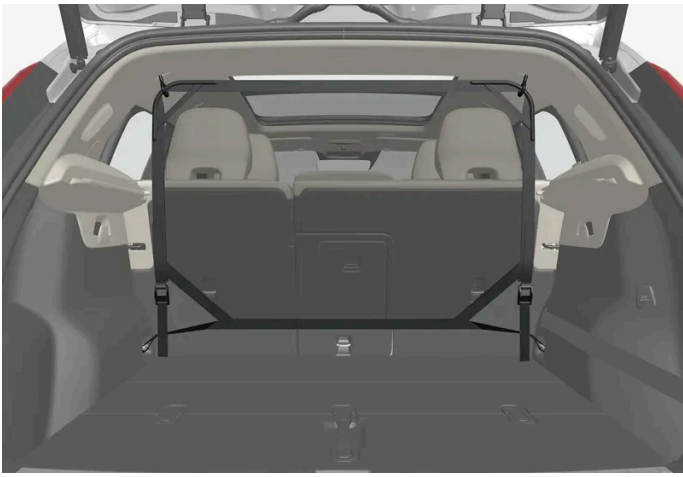

For safety reasons, the cargo net must always be mounted and secured according to the following description.

The net is made of strong nylon weave and can be attached in two different locations in the vehicle:

- Front mounting – behind the front seats.
- Rear mounting – behind the rear seats.

#### **Warning**

Objects in the cargo compartment must always be securely anchored, even with a correctly installed cargo net.

### Installing the cargo net

#### **Warning**

Make sure that the cargo net's upper attachments are correctly mounted and that the straps are hooked securely into place.

Never use the net if it is damaged.



**Note**

With front mounting, the cargo net is most easily installed via the rear doors.

- 1 Fold out the cargo net with the upper hooks facing upwards.
- 2 Insert one of the net's hooks into the front or rear ceiling bracket with the strap lock facing you.
- 3 Insert the net's other upper hook into the ceiling bracket on the opposite side.  
Make sure that the net's hooks are pushed forward as far as possible into their respective ceiling brackets.

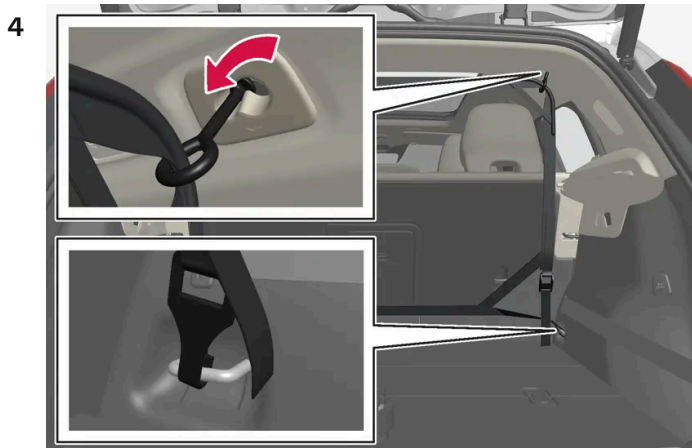

Rear mounting.

For rear mounting:

With the cargo net hooked into the rear ceiling brackets, attach the net's straps into the front cargo anchoring eyelets in the cargo compartment.

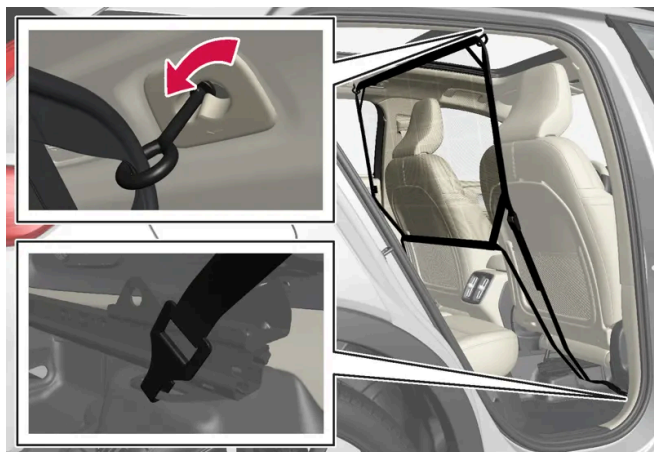

Front mounting.

For front mounting:

With the net mounted in the front ceiling brackets, hook the straps into the outer eyelets on the front seat rails behind the seats. Attaching the net is easier if the seat backrests are upright and the seats are moved slightly forward.

When moving the seat and backrest back again, make sure to not apply too much pressure against the net. Move the seat or backrest only until it touches the net.

 **Important**

If a seat or backrest is pressed with too much force back against the cargo net, the net and its ceiling brackets could be damaged.

- 5 Pull the straps until the cargo net is taut.

## Removing the cargo net

The cargo net can be easily removed and folded up.

- 1 Loosen the cargo net by pressing the button on the strap locks on each side and pulling to allow some slack.
- 2 Press in the catches and release both of the strap hooks.
- 3 Unhook the upper hooks and remove the net from the ceiling brackets.
- 4 Fold up the net and store it in its case.  
Replace clothing hooks, if desired.

\* Option/accessory.

---

## 16.2.2. Cargo compartment

The vehicle has a flexible cargo compartment that makes it possible to carry and secure large objects.

The cargo capacity of the vehicle can be considerably increased by folding down the rear seat backrests. Use load anchoring eyelets or grocery bag holders to help secure objects in place. In order to accommodate bulky loads, the parcel shelf is easy to remove and store under the load compartment floor.

The towing eyelet and tire sealing system, or the temporary spare tire\*, are located under the cargo compartment floor.

\* Option/accessory.

---

## 16.2.3. Grocery bag holders

Grocery bag holders (hooks) help keep shopping bags in place and prevent them from falling over and spilling their contents in the cargo compartment.

## On the sides of the cargo compartment



There is a grocery bag holder in the side panel on each side of the cargo compartment.

There are two grocery bag holders in the side panel on each side of the cargo compartment.

 **Important**

The grocery bag holders are only intended to hold weights up to 5 kg (11 lbs).

## Under the floor hatch \*

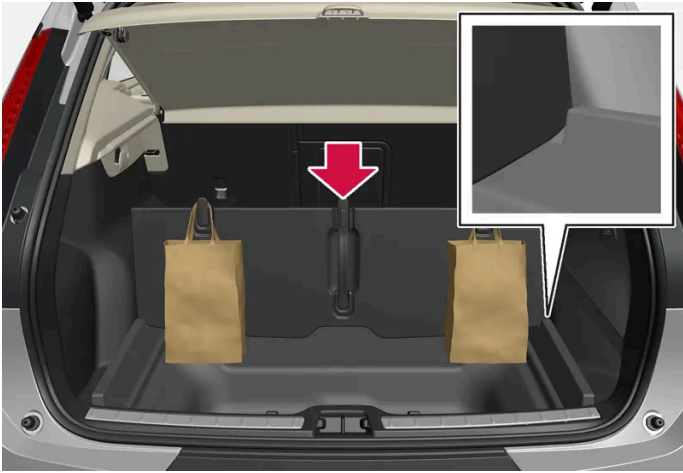

- 1 Lift the handle in the center of the load compartment floor and fold up the floor.
  - 2 Move the load compartment floor to the upright position and place it in the adjustment track on each side.
- It is now possible to hang grocery bags with handles at a suitable height on the hooks.

## In the glove compartment

There is also a fold-out hook in the glove compartment that can be used to hang a shopping bag.

\* Option/accessory.



---

## 16.2.4. Removing and storing the parcel shelf

The parcel shelf can be removed to increase the cargo space.

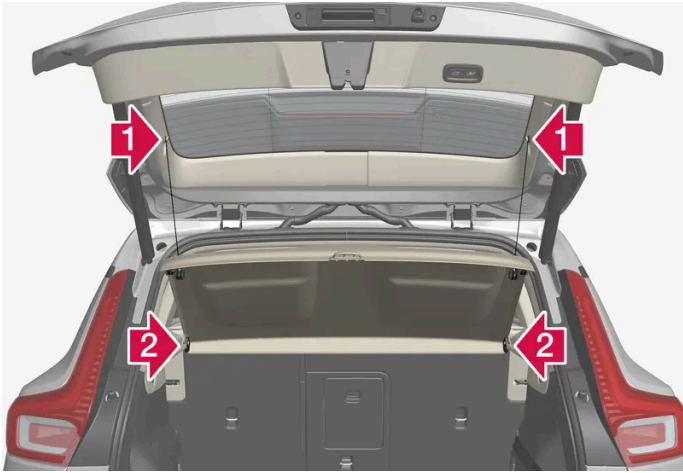
## Removing the parcel shelf



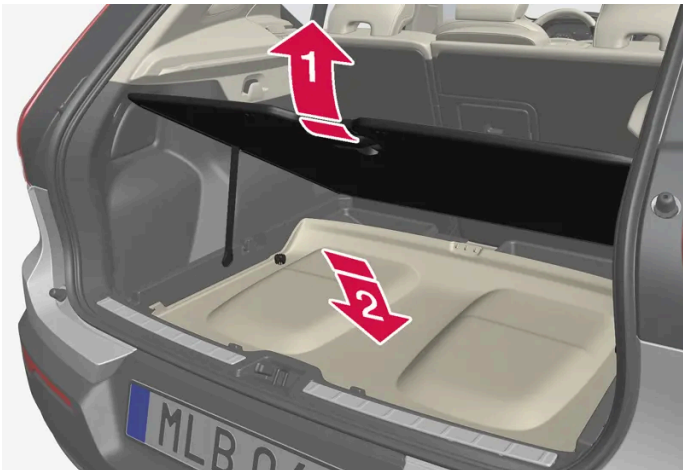

- 1**  Detach the parcel shelf lifting eyes on both sides.
- 2**  Unhook the front edge of the parcel shelf and remove it.

## Storing the parcel shelf under the cargo floor



Once removed, the parcel shelf can be stored under the cargo compartment floor.

- 1**  Fold up the cargo compartment floor and secure it with the support arm.
- 2**  Position the parcel shelf with its top facing down and place it in the space with the rear part facing forward.

With folding cargo compartment floor\* :

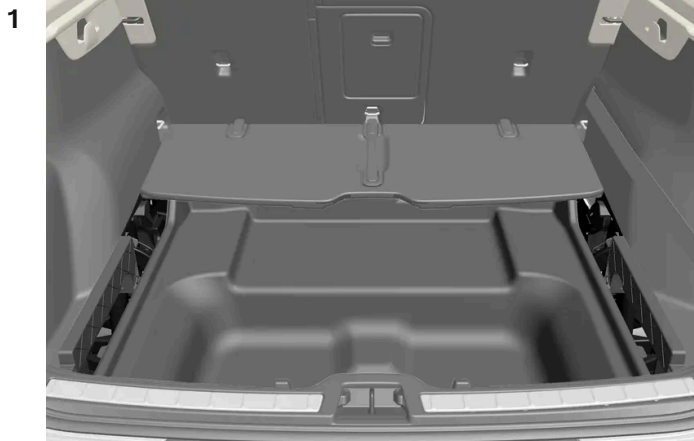

Fold the cargo compartment floor forward to position the parcel shelf with its top facing down and its rear part facing forward.

- 2 Restore the cargo compartment floor to a flat position.

\* Option/accessory.

---

## 16.2.5. Folding up the cargo compartment floor

The cargo compartment floor can be secured in the raised position using the support arm.

- 1 Grasp the handle to fold up the cargo compartment floor.
  - 2 Raise the support arm and insert the end in the recess on the underside of the cargo compartment floor.
- The cargo compartment floor will then be held in the raised position.

## With folding cargo compartment floor\*



- 1 Lift the handle in the middle of the folding cargo compartment floor and push it forward so that it folds together.

\* Option/accessory.

---

## 16.2.6. Cargo anchoring eyelets

The load anchoring eyelets in the cargo compartment can be used to secure objects with straps, a net, etc.

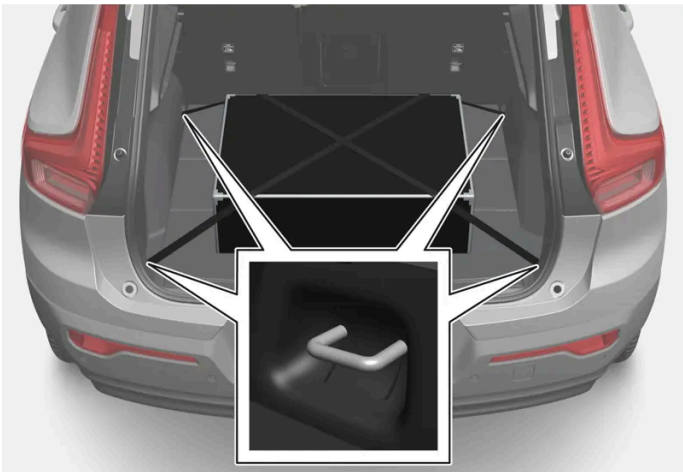

### **Warning**

Hard, sharp and heavy objects in or protruding from the vehicle can cause injury in the event of hard braking.

Always secure large and heavy objects with a seat belt or cargo retaining straps.

## 16.2.7. Removing the folding cargo compartment floor\*

The folding cargo compartment floor can be removed for easier access to the storage space underneath.



Push the folding cargo compartment floor forward so that it folds together.

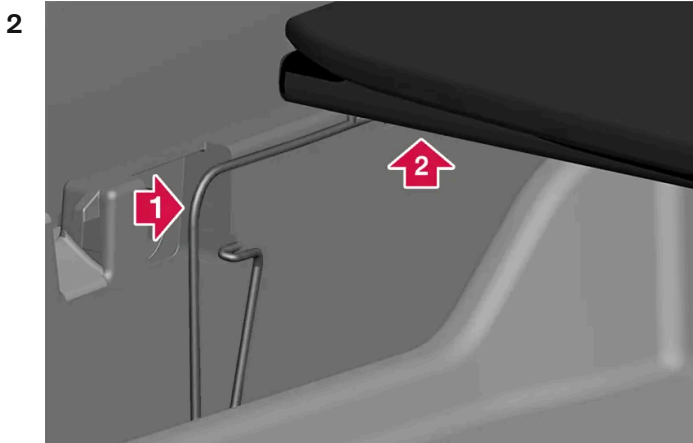

1 Press the locking clip at the location shown by the arrow until it stops. Maintain pressure on the locking clip.

2 At the same time, lift the cargo compartment floor slightly upward.

3 Release pressure on the locking clip, but keep holding the cargo compartment floor up.

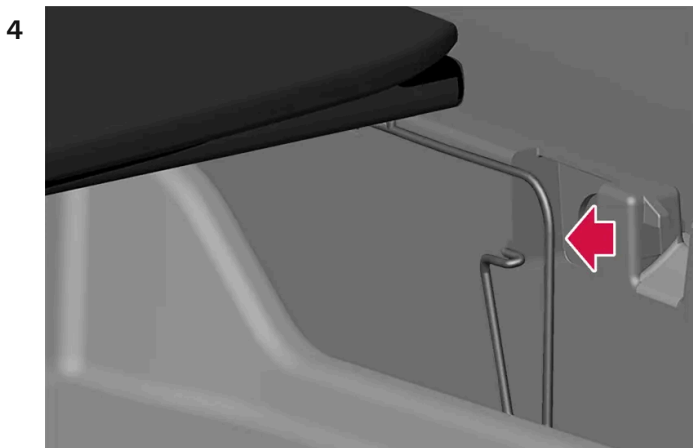



While continuing to hold the cargo compartment floor up, press the locking clip on the other side, as shown by the arrow.

- If the procedures in step 2 have been performed correctly, the cargo compartment floor should now be released from its side attachment points.

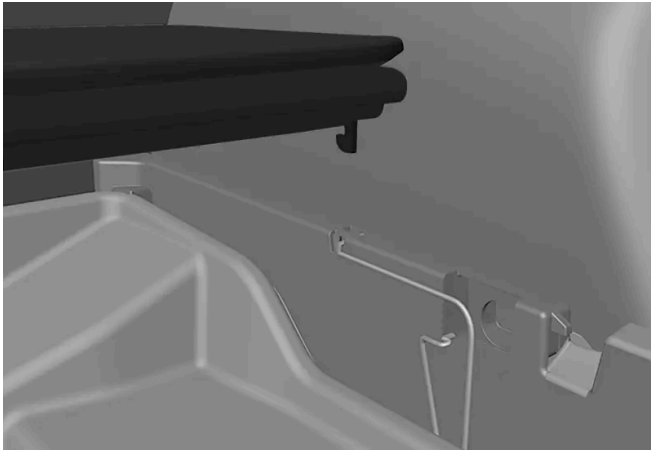

The cargo compartment floor can be carefully placed back on top of the locking clips without it locking into place.

**Note**

The cargo compartment floor is also secured in the front hinge.

Volvo recommends that the cargo compartment floor remains secured in its front hinge.

- 5 Press the cargo compartment floor downward to lock it into its attachment points again.

\* Option/accessory.

---

## 16.2.8. Unlocking the tailgate using the key button

There is a button on the key for unlocking only the tailgate.

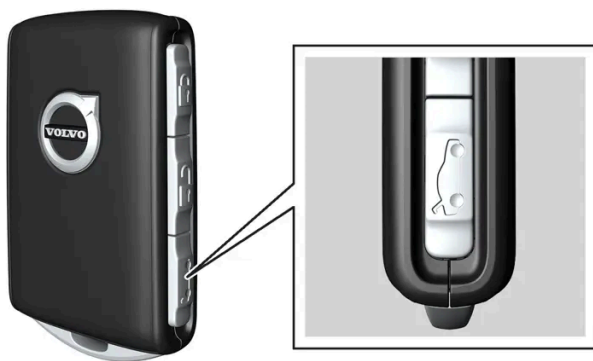

1 Press the  button on the key.

> The tailgate will be unlocked but remain closed.

The side doors remain locked and armed. The lock and alarm indicator on the dashboard will go out to indicate that the vehicle is no longer fully locked.

The tailgate can be opened by grasping the rubberized button under the lower edge of the trunk lid.

If the tailgate is not opened within 2 minutes, it will be relocked and the alarm armed.

#### Power tailgate\*

1 Press and hold the key's  button for a few seconds.

> The tailgate will unlock and open. However, the side doors will remain locked and armed.

#### Note

If the power tailgate system\* has been working continuously for too long, it will be switched off to help prevent overheating. It can be used again after a few minutes.

\* Option/accessory.

---

## 16.2.9. Setting maximum opening height for the power tailgate\*

The tailgate can be set to stop opening at a certain height, for example if the vehicle is parked in a garage with a low ceiling.

### Setting maximum opening height

1 Open the tailgate manually to the desired opening height.

2 Press the  button on the lower edge of the tailgate and hold it for about 3 seconds.

> Two audio signals will sound to indicate that the position has been stored.

**Note**

It is not possible to program an opening position lower than half-open tailgate.

## Resetting maximum opening position

- 1 Open the tailgate manually to the fully open position.
  - 2 Press the \* button on the lower edge of the tailgate and hold it for about 3 seconds.
- Two audio signals will sound to indicate that the stored position has been erased.

\* Option/accessory.

## 16.2.10. Operating the tailgate with a foot movement\*

The tailgate can be opened and closed by making a foot movement\* under the rear bumper. This function makes it easy to access the cargo compartment when your hands are full.

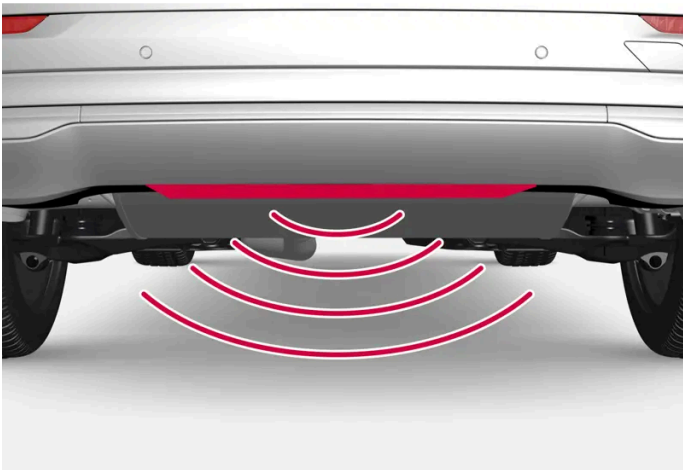

The sensor is located in the center under the bumper.

One of the vehicle's keys must be within range behind the vehicle, approx. 1 meter (3 feet) for opening and closing to be possible. This applies even if the vehicle is unlocked in order to prevent the trunk lid from inadvertently opening e.g. at a car wash.

## Foot movement operation

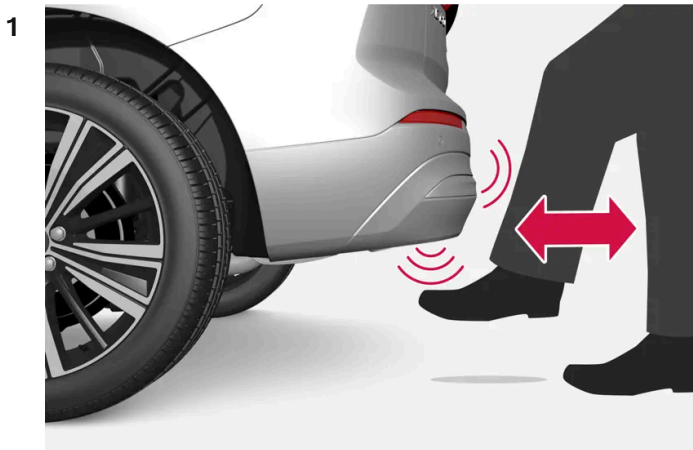

Make **one** forward kicking motion with your foot under the sensor area under the rear bumper. Then take a step back. Do not touch the bumper.

- A brief audible signal will be heard when opening or closing is activated - the tailgate will open/close.

If several opening attempts have been made without a key in range behind the vehicle, foot movement operation will not be available for a short period of time.

Do not hold your foot under the vehicle in a kicking motion – this can cause the activation to fail.

### Interrupting opening or closing with a foot movement

- 1 Make **one** forward kicking motion during opening or closing.
- The tailgate will stop opening or closing.

The key does not need to be within range of the vehicle to interrupt opening or closing of the tailgate.

If the tailgate stops near the closed position, it will open the next time it is activated.

#### *i* Note

Keep the area around the foot movement sensor clean. The accumulation of dirt, ice or snow may interfere with its functioning.

#### *i* Note

Please note that the system could be inadvertently activated in a car wash if the key is within range.

\* Option/accessory.

---

## 16.2.11. Unlocking the tailgate from inside the vehicle

The tailgate can be unlocked from inside the vehicle by pressing the button on the dashboard, to the side of the steering wheel.



- 1 Press the  button on the dashboard.
  - > The tailgate is unlocked and can be opened from the outside.

With the optional power tailgate\* :

- 1 Press and hold the  button on the dashboard for a few seconds.
  - > The tailgate will open.  
The same button can then be used to close the tailgate.

### Note

If the power tailgate system \* has been working continuously for too long, it will be switched off to help prevent overheating. It can be used again after a few minutes.

\* Option/accessory.

---

## 16.2.12. Keyless unlocking of the tailgate \*

With keyless locking and unlocking, the tailgate can be unlocked by lightly touching the rubberized button under the tailgate handle.

 **Note**

One of the vehicle's keys must be within range behind the vehicle for unlocking to be possible.

The tailgate is held closed by an electronic locking mechanism.

To open:

- 1 Lightly press the rubberized pressure plate on the underside of the tailgate handle.
  - The lock will disengage.
- 2 Lift the outer handle to open the tailgate.

 **Important**

- Handle the rubber plate carefully to help prevent damage to its electrical connections. Very little force is needed for activation.
- Use the handle to lift – do not apply force to the rubberized pressure plate.

The tailgate can also be unlocked by making a foot movement\* under the rear bumper; see the separate section.

 **Warning**

Do not drive with the tailgate open. Toxic exhaust fumes can be sucked into the vehicle through the cargo compartment.

\* Option/accessory.

---

## 16.3. Storage and passenger compartment

---

### 16.3.1. Passenger compartment interior

Overview of the passenger compartment interior and storage spaces.

#### Front seats

#### Rear seat

 **Warning**

Store loose objects, such as a phone, camera, remote control for extra equipment, etc., in the glove compartment or another compartment. Otherwise, these could injure people in the vehicle in the event of hard braking or a collision.

 **Important**

Keep in mind that glossy surfaces can be easily scratched by e.g. metal objects. Do not place keys, phones or similar items on sensitive surfaces.

## 16.3.2. Electrical outlets

There is a 12 V electrical outlet in the tunnel console and a 12 V electrical outlet\* in the trunk/cargo compartment.

If a problem occurs with an electrical socket, contact a workshop - an authorized Volvo workshop is recommended.

### 12 V outlets



12 V outlet in the tunnel console, front seat.

The 12 V outlets can be used for devices intended for this such as MP3 players, coolers and cellular phones.

\* Option/accessory.

## 16.3.3. Using the electrical outlets

The 12 V outlet can be used for devices intended for this such as MP3 players, coolers and cellular phones.

The ignition must be in at least mode I for the outlets to supply current. The outlets will then be active as long as there is sufficient charge in the start battery.

If the engine is turned off and the vehicle is locked, the outlets will be deactivated. If the engine is turned off and the vehicle remains unlocked, the sockets will remain active for up to 7 minutes.

 **Note**

Bear in mind that using the electrical outlets when the engine is off could cause the starter battery to have too low of a charge level, which could limit other functionality.

Accessories connected to the electrical outlets can be activated even when the vehicle electrical system is off or if preconditioning is used. For this reason, disconnect plugs when they are not in use to prevent the starter battery from becoming discharged.

 **Warning**

- Do not use accessories with large or heavy plugs – they could damage the outlet or come loose while you are driving.
- Do not use accessories that could cause disruptions to e.g. the vehicle's radio receiver or electrical system.
- Position the accessory so that there is no risk of it injuring the driver or passengers in the event of heavy braking or a collision.
- Pay attention to connected accessories as they can generate heat that could burn passengers or the interior.

## Using 12 V outlets

- 1 Remove the stopper (tunnel console) or fold down the cover (trunk/cargo compartment) over the outlet and plug in the device.
- 2 Unplug the device and put the stopper back in (tunnel console) or fold up the cover (trunk/cargo compartment) when the outlet is not in use or left unattended.

 **Important**

The maximum power is 120 W (10 A) per outlet.

## 16.3.4. Using the glove compartment



The glove compartment is located on the passenger side. The glove compartment can be used to store the vehicle's printed owner's information and other items. There is also room for a pen and a card holder.



Glove compartment with fold-out hook.

The hook on the glove compartment can be folded out when the glove compartment is open. Once folded out, it can be used when the glove compartment is closed.

**!** Important

The hook must be either fully retracted or fully extended so that it doesn't break when the glove compartment is closed.

## 16.3.5. Sun visors

In the ceiling in front of the driver's and front passenger's seats, there are sun visors that can be lowered and angled to the side as necessary.



The illustration is generic – the design may vary.

The mirror lighting\* comes on automatically when the visor is lifted up.

The mirror frame has a holder for e.g. cards or tickets.

\* Option/accessory.

---

## 16.3.6. Tunnel console

The tunnel console is located between the front seats.

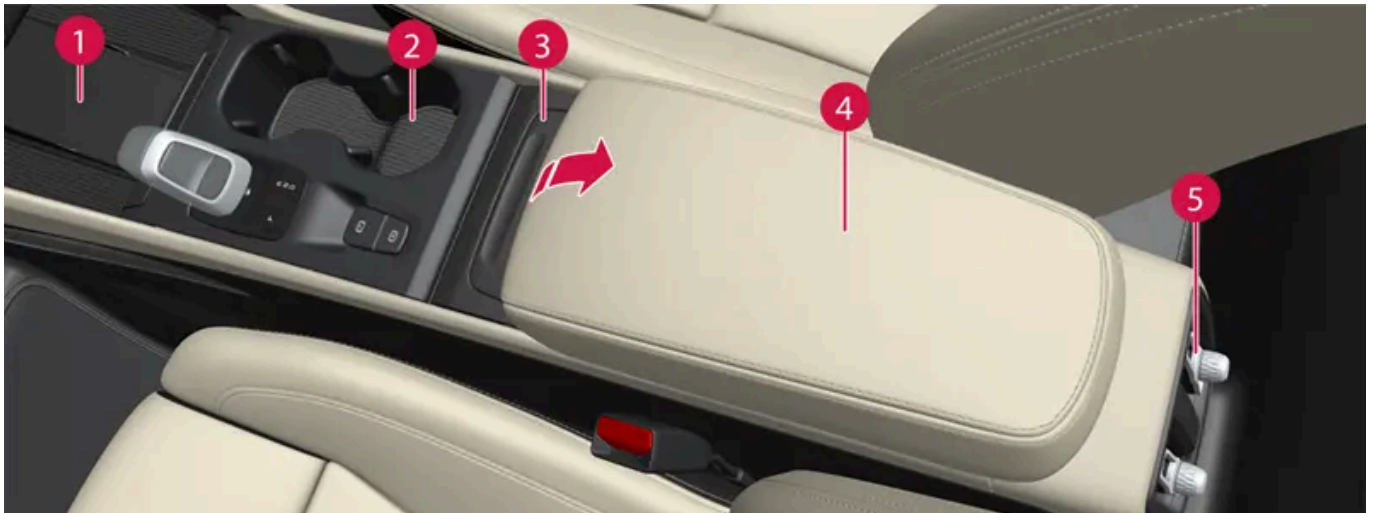

- 1 Wireless phone charger\*
- 2 Storage compartment with cup holder.
- 3 Waste bin\* <sup>[1]</sup> that can be taken out and emptied.
- 4 Storage compartment under the armrest.
- 5 Climate control panel for the rear seats\* or storage compartment. There are also USB ports underneath.

 **Warning**

Store loose objects, such as a phone, camera, remote control for extra equipment, etc., in the glove compartment or another compartment. Otherwise, these could injure people in the vehicle in the event of hard braking or a collision.

 **Important**

Keep in mind that glossy surfaces can be easily scratched by e.g. metal objects. Do not place keys, phones or similar items on sensitive surfaces.

 **Note**

One of the sensors for the alarm\* is located under the cup holder in the center console. Avoid placing coins, keys and other metal objects in the cup holder as this could trigger the alarm.

 **Note**

The USB ports can be used to e.g. charge a phone or tablet. Only the front USB port can be used to play media through the vehicle's speakers.

\* Option/accessory.

[1] Only in vehicles with automatic transmission.

---

## 16.3.7. USB ports

There are two USB ports (type C) under the center display. There are also two USB ports (type C) in the rear section of the tunnel console.



USB ports (type C), front seat.

The USB ports can be used to charge a device such as a phone or tablet.

---

## 16.3.8. Charging devices via USB ports

The USB ports can be used to charge a device such as a phone or tablet.

The USB ports can be used when the vehicle is in Comfort or Drive mode.

The ports will switch off automatically when the driver exits the vehicle. If the vehicle remains unlocked, the ports will remain active for about 10 minutes longer.

### Note

Accessories connected to the ports can be activated even when the vehicle's electrical system is off or if preconditioning is used. For this reason, unplug accessories when they are not being used.

Some devices may become warm during charging. This is normal.

### Warning

Position the accessory so that there is no risk of it injuring the driver or passengers in the event of heavy braking or a collision.

## Charging devices via the USB ports

- 1 Fold down the cover in front of the port and plug in the device.
- 2 Unplug the device and fold up the cover when the port is not in use or left unattended.

## Technical specifications for the USB-C port

- Type C port
  - Version 3.1
  - Voltage 5 V
  - Max. current 3.0 A
- 

## 16.3.9. Fuses under the left front seat

Fuses under the left front seat provide protection for e.g. electrical outlets, displays and door modules.

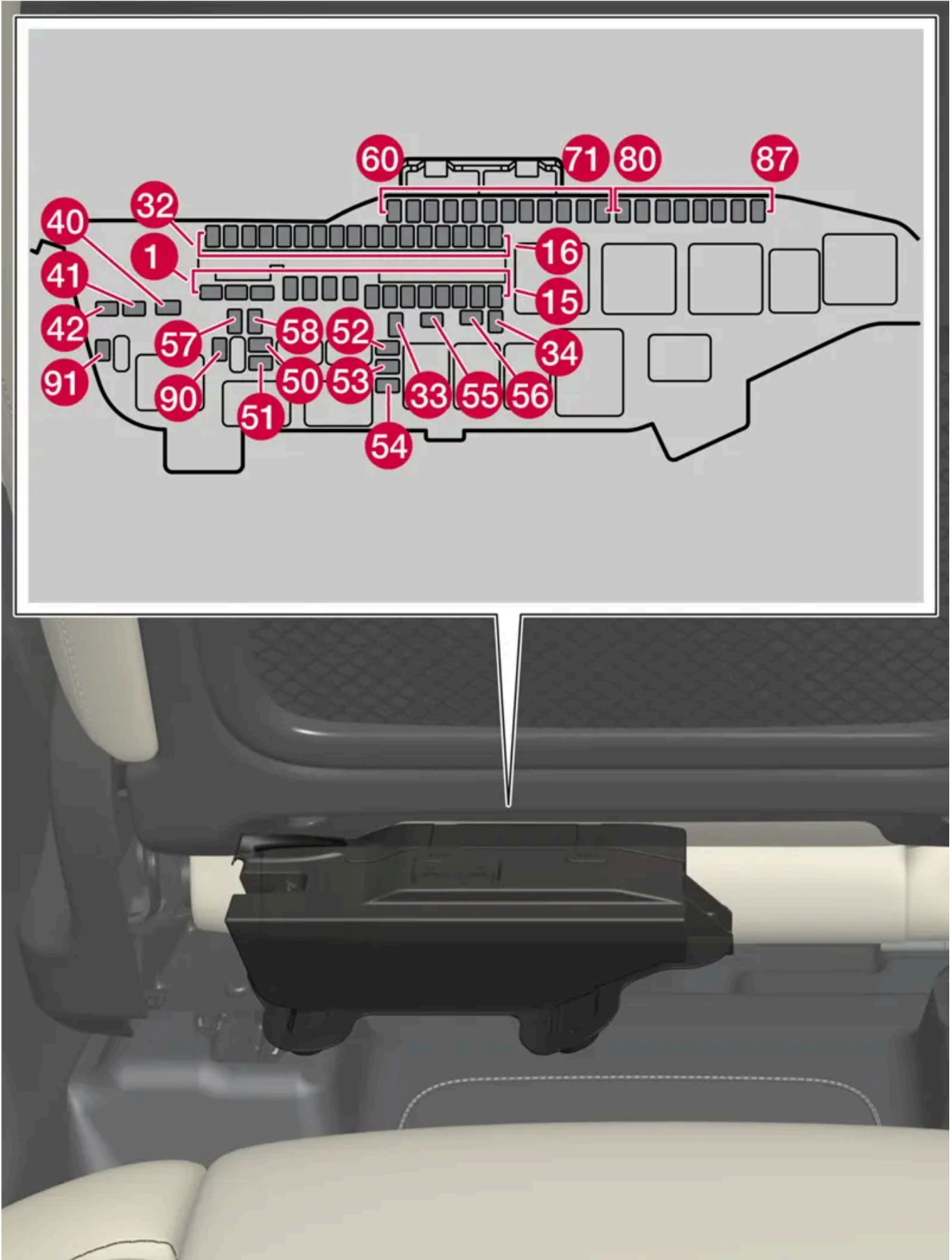

There are spaces for several extra fuses in the **distribution box in the engine compartment.**

## Positions

The location of the fuses is shown on the inside of the cover. Functions and components in the fuse table cover several different models and engine variants. Therefore, a described fuse may apply to fewer components than those in the table, or be missing completely, depending on how the vehicle is equipped.

If a position has several values in the table, the value depends on variations in equipment level. If this is the case, follow the value on the replaced fuse. In the event of uncertainty, contact a workshop. An authorized Volvo workshop is recommended.

	Function	Ampere	Type
1	Audio control module	40	MCaSe+ HT <sup>[1]</sup>
2	Central Electric Module A: Sensors, radar sensors, power seats*	40	MCaSe+ HT <sup>[1]</sup>
3	Central Electric Module B: Sensors, radar sensors, power seats*	40	MCaSe+ HT <sup>[1]</sup>
4	Climate system blower module (front)	40	MCaSe+ HT <sup>[1]</sup>
5	Power tailgate*	25	MCaSe+ <sup>[1]</sup>
6	Power seat*, right	20	MCaSe+ <sup>[1]</sup>
7	Parking heater*	25	MCaSe+ <sup>[1]</sup>
8	–	–	MCaSe+ <sup>[1]</sup>
9	Door module, right side, rear	20	Micro
10	Door module, left side, rear	20	Micro
11	Door module, left side, front	20	Micro
12	Safety module (ASDM)	5	Micro
13	Door module, right side, front	20	Micro
14	Seat heating, rear*	15	Micro
15	48 V battery control module	5	Micro
16	Calculation module	5	Micro
17	Sun sensor	5	Micro
18	–	–	Micro
19	Climate system control module	7,5	Micro
20	Interior movement sensors*	5	Micro
21	Instrument panel	5	Micro
22	Center console buttons	5	Micro
23	Steering wheel module	5	Micro
24	Start knob module Electronic shifting module Electronic parking brake	5	Micro
25	Center display	5	Micro
26	Connected services control module	5	Micro
27	Multiband antenna module Antenna module telematics	5	Micro
28	Relay coils	5	Micro
29	Opening tailgate with foot movement*	5	Micro
30	Sensus control module TV*	15	Micro

	Function	Ampere	Type
31	OBD-II diagnostic port	10	Micro
32	–	–	Micro
33	Lock motor for rear seat head restraint, left side	15	Micro
34	Lock motor for rear seat head restraint, right side	15	Micro
40	Heated rear window	30	MCASE+ <sup>[1]</sup>
41	Seat belt tensioner, left	40	MCASE+ HT <sup>[1]</sup>
42	Seat belt tensioner, right	40	MCASE+ HT <sup>[1]</sup>
50	Humidity sensor 48 V generator and voltage converter	5	Micro
51	Fuel pump control module	20	Micro
52	Coolant pump	7.5	Micro
53	Heated steering wheel*	15	Micro
54	Air humidity sensors Air particulate matter sensor	5	Micro
55	Headlight washers*	25	MCASE+ <sup>[1]</sup>
56	Windshield and tailgate window washers	25	MCASE+ <sup>[1]</sup>
57	–	–	MCASE <sup>[1]</sup>
58	–	–	MCASE <sup>[1]</sup>
59	–	–	Micro
60	–	–	Micro
61	–	–	Micro
62	–	–	Micro
63	Seat belt tensioners	5	Micro
64	Blind Spot Information (BLIS) *	5	Micro
65	–	–	Micro
66	Radar, front	5	Micro
67	All Wheel Drive (AWD) control module *	15	Micro
68	Exhaust system	5	Micro
69	Park Assist Camera *	5	Micro
70	–	–	Micro
71	Control module for airbags and seat belt tensioners	5	Micro
80	Rear window wiper	15	Micro
81	Roof console for panoramic roof*	20	Micro
82	–	–	Micro
83	Courtesy lighting Rearview mirror auto-dim* Rain and light sensor* Control panels in rear doors and cargo compartment	7.5	Micro
84	Wireless phone charger*	5	Micro
85	Driver support functions control module	5	Micro
86	–	–	Micro
87	USB port	5	Micro

The content of this manual represents the status of the user manual at the time of printing and may not be completely valid in future instances. For more information refer to the first page for the complete disclaimer note.



	Function	Ampere	Type
90	–	–	Micro
91	–	–	Micro

[1] This type of fuse should be replaced by a workshop. An authorized Volvo workshop is recommended.

\* Option/accessory.

---

## 16.4. Rear seat ski hatch\*

The hatch in the rear seat backrest can be opened to transport long, narrow objects such as skis.

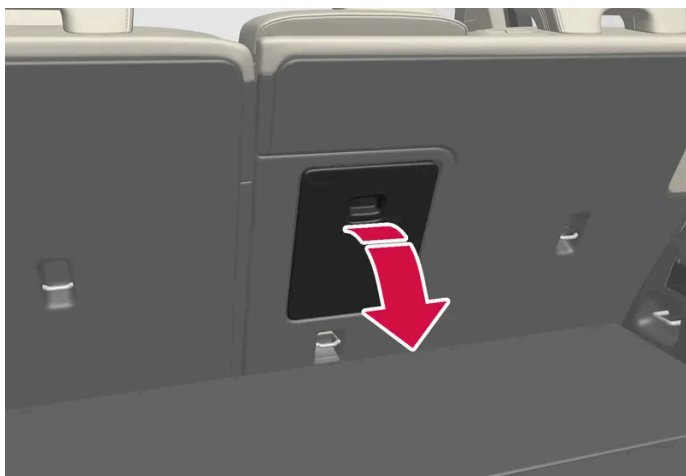

- 1 In the cargo compartment, grasp the ski hatch handle and pull it down.
- 2 Fold down the armrest in the rear seat.
- 3 Adjust the center seat head restraint upwards so the steel tubes do not block the opening.

\* Option/accessory.

---

# 17. Maintenance and service

---

## 17.1. Vehicle care

---

### 17.1.1. Interior cleaning

---

#### 17.1.1.1. Cleaning the center display

Marks, stains, finger smudges etc. on the center display may affect its performance and readability. Clean the screen regularly with a microfiber cloth.

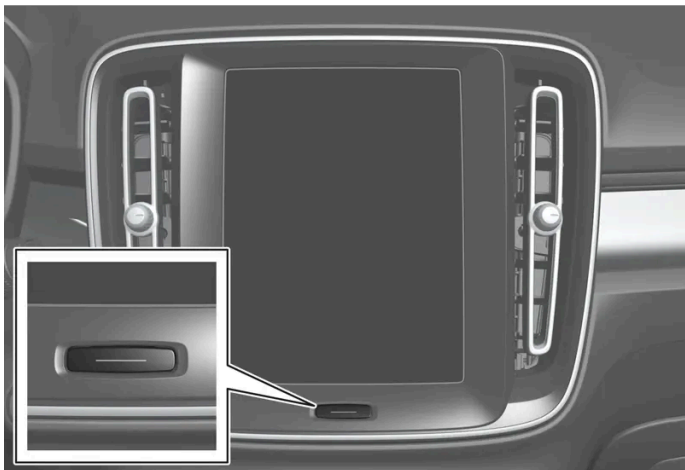

- 1 Turn off the center display by pressing and holding the Home button.
- 2 Wipe the screen with a clean, dry microfiber cloth using small, circular motions. If necessary, moisten the cloth slightly.
- 3 Reactivate the display by pressing the Home button briefly.

 **Important**

The microfiber cloth must be free of sand and dirt when cleaning the center display.

 **Important**

When cleaning the center display, apply only light pressure to the screen. Pressing too hard could damage the screen.

 **Important**

Do not spray liquid or corrosive chemicals directly onto the center display. Do not use window cleaners, cleaning agents, aerosol sprays, solvents, alcohol, ammonia or detergents that contain abrasives.

Never use abrasive cloths, paper towels or tissue paper, as these may scratch the center display.

---

## 17.1.1.2. Cleaning the instrument panel

Carefully wipe the glass covering the head-up display unit with a clean and dry microfiber cloth. If necessary, the cloth may be slightly moistened.

Never use cleaning agents. For difficult cleaning conditions, a special cleaning agent can be purchased at a Volvo retailer.

---

## 17.1.1.3. Cleaning the leather steering wheel

Use cleaning agents and car care products recommended by Volvo. Clean regularly and treat stains immediately. It is important to vacuum before using a cleaning agent.

Leather needs to breathe. Never cover the leather steering wheel with a plastic protector. Volvo Leather Care Kit 951 0251 and Leather Softener 943 7429 are recommended for cleaning the leather steering wheel. First, remove dirt, dust, etc. with a damp sponge or cloth.

 **Important**

Sharp objects such as rings could damage the leather on the steering wheel.

### Treating stains on the steering wheel:

**Type 1** (ink, wine, coffee, milk, sweat or blood)

- 1 Use a soft cloth or sponge. Wipe the steering wheel using a solution of 5% ammonia. For blood stains, mix approximately 2 dl (1 cup) of water with 25 g (one ounce) of salt and wipe the stain.

**Type 2** (grease, oil, sauces or chocolate)

- 1 Same procedure as for Type 1 stains.
- 2 Finish by wiping the wheel with an absorbent paper or towel.

**Type 3** (dry dirt or dust)

- 1 Remove the dirt/dust using a soft brush.
- 2 Same procedure as for Type 1 stains.

---

## 17.1.1.4. Cleaning the seat belt

Use cleaning agents and car care products recommended by Volvo. Clean regularly and treat stains immediately. It is important to vacuum before using a cleaning agent.

Use water and a synthetic soap solution. Specially designed textile cleaning agents are available for purchase at Volvo retailers. Make sure the belt is dry before it is retracted.

---

## 17.1.1.5. Cleaning the interior

Use cleaning agents and car care products recommended by Volvo. Clean regularly and treat stains immediately. It is important to vacuum before using a cleaning agent.

 **Important**

- Some colored clothing (for example, dark jeans and suede garments) may stain the upholstery. If this occurs, it is important to clean and treat these parts of the upholstery as soon as possible.
- Never use strong solvents such as washer fluid, gasoline, mineral spirit or concentrated alcohol to clean the interior as this can damage the upholstery as well as other interior materials.
- Never spray cleaning agent directly onto components that have electrical buttons and controls. Wipe instead with a damp cloth with cleaning agent.
- Sharp objects and Velcro can damage the car's textile upholstery.
- Only use cleaning agent on the type of material it is intended for.

## 17.1.1.6. Cleaning textile floor and inlay mats

Use of textile cleaner is recommended when cleaning textile mats. Clean regularly and treat stains immediately. It is important to vacuum before using a cleaning agent.

Remove the inlay mats to clean the floor mats and inlay mats separately. Each inlay mat is secured into place with pins.

- 1 Remove the inlay mat by grasping the inlay mat at each pin and lifting the mat straight up.
- 2 Use a vacuum to remove dust and dirt.

 **Note**

Do not swing or strike the inlay mats violently against another object to remove dirt as this could damage the mats.

- 3 After vacuuming, a specially designed textile cleaning agent should be used to remove stains on floor mats.
- 4 After cleaning, put the inlay mat back into place by pressing it in at each pin.

 **Warning**

- Never use more than one inlay mat at a time on the driver's floor. If any other type of floor mat is used, remove the original mat from the driver's seat floor before driving. All types of mats must be securely anchored in the attachment points in the floor. Make sure the floor mat does not impede the movement of the brake pedal or accelerator pedal in any way, as this could be a serious safety hazard.
- Volvo's floor mats are specially manufactured for your vehicle. They must be properly secured in the attachment points in the floor to help ensure they cannot slide and become trapped under the pedals.

## 17.1.1.7. Cleaning interior plastic, metal and wood surfaces

Use cleaning agents and car care products recommended by Volvo. Clean regularly and treat stains immediately.

A lightly dampened microfiber cloth is recommended for cleaning interior details and surfaces. These cloths are available for purchase at Volvo retailers.

Never scrape or rub a stain. Never use strong stain removers.

 **Important**

Do not use solvent containing alcohol to clean the instrument panel glass.

 **Important**

Keep in mind that glossy surfaces can be easily scratched. Wipe these surfaces with a clean and dry microfiber cloth using small, circular motions. If necessary, moisten the cloth lightly with clean water.

## 17.1.1.8. Cleaning leather upholstery\*

Use cleaning agents and car care products recommended by Volvo. Clean regularly and treat stains immediately. It is important to vacuum before using a cleaning agent.

Volvo's leather upholstery\* is treated to protect its original appearance. Over time, sunlight, grease, dirt, etc. could break down the protective layer. This could result in scratches and cracking.

Leather upholstery\* is a natural product that changes and acquires a beautiful patina over time. Regular cleaning and treatments are required to preserve the qualities and color of the leather. Volvo offers a comprehensive product, Volvo Leather Care Kit/Wipes, for cleaning and treating leather upholstery. When used as directed, it helps preserve the leather's protective coating.

For optimal results, Volvo recommends cleaning and applying protective cream one to four times a year (or more often as needed). Volvo Leather Care Kit and Volvo Leather Softener are available for purchase at Volvo retailers.

### Cleaning the leather upholstery

- 1 Apply the leather cleaner to a damp sponge and squeeze it until the cleaner foams.
- 2 Move the sponge in circular motions to apply the foam to the stain.
- 3 Dampen the stain thoroughly with the sponge. Let the sponge absorb the stain and do not rub.
- 4 Dry the stain using a soft towel and let the leather dry completely.

### Protecting the leather upholstery

- 1 Apply a small amount of leather protector to a cloth and then apply the protector to the leather using light circular movements.
  - 2 Let it dry for approximately 20 minutes.
- Protecting the leather upholstery makes it better able to withstand sunlight's harmful UV rays.

\* Option/accessory.

---

## 17.1.1.9. Cleaning Microtech upholstery\*

Volvo's Microtech upholstery is treated to maintain its original appearance.

Over time, sunlight, grease, dirt, etc. could break down the protective layer, which could result in scratches or cracking. Regular cleaning and immediate treatment of stains are required to preserve the qualities and color of the leather. Vacuuming is recommended before cleaning with cleaning agents.

### Cleaning Microtech upholstery

- 1 Vacuum the upholstery.
- 2 Apply a mild, alcohol-free detergent to a moistened sponge and squeeze until the detergent foams.
- 3 Move the sponge in a circular motion over the stain. Dampen the stain thoroughly with the sponge. Let the sponge absorb the stain and do not rub.
- 4 Wipe with a soft cloth or towel and then let the upholstery dry completely.

 **Important**

Certain dark dyed clothing, such as denim or suede, may stain the Microtech upholstery.

\* Option/accessory.

---

## 17.1.1.10. Cleaning fabric upholstery and headliner

Use of textile cleaner is recommended when cleaning textile and nubuck textile materials. Clean as needed and treat stains immediately.

 **Important**

Never scrape or rub a stain because this may damage the upholstery.

 **Important**

Never use stain removers or strong solvents because these may damage the upholstery.

## Cleaning textile upholstery

1. Start by vacuuming the upholstery.
2. Follow the instructions for the textile cleaner.
3. When cleaning upholstery, a spray extraction cleaner is recommended for sucking up cleaning fluids and rinse water.

### Important

Certain dyed clothing (such as denim and suede garments) may stain the upholstery. Difficult stains, like oil, can be difficult to remove.

### Important

Always clean all of the upholstery, even if it only has isolated stains. This helps to prevent permanent water rings.

### Note

Do not remove the upholstery when cleaning.

## Cleaning the headliner

1. Carefully brush the headliner using a soft brush.
2. Follow the instructions for the textile cleaner.
3. Then use a soft, lint-free cloth to wipe the headliner.

### Important

Careless cleaning could damage the headliner.

---

## 17.1.2. Exterior cleaning

### 17.1.2.1. Cleaning exterior lights

Dirty lights do not work as well. Clean them regularly, e.g. when refueling.

Wash exterior lights, such as headlights and taillights, using a soft and clean sponge, mild soap and lukewarm water.



It is normal for condensation to form temporarily on the inside of the glass during washing. All outer lights are designed to withstand this. Condensation is normally ventilated out of the light housing once the light has been illuminated for a short period of time.

 **Important**

Do not use strong detergents or chemicals to clean the lights. These types of products, such as those containing alcohol, may cause cracks in the glass.

 **Important**

Do not rub with a dry sponge or rag as this could cause electric discharge and damage the components in the light.

---

## 17.1.2.2. Cleaning the wiper blades

The vehicle should be washed as soon as it becomes dirty. The longer the dirt remains, the more difficult it will be to keep the vehicle clean. It could also lead to paint damage. Wash the vehicle in a car wash or garage with an oil separator. Use a car washing detergent recommended by Volvo.

Asphalt, dust and salt residue on wiper blades, as well as insects, ice etc. on the windshield, shorten the service life of wiper blades.

When cleaning, put the wiper blades in the service position.

 **Note**

Wash the wiper blades and windshield regularly with a lukewarm soap solution or vehicle shampoo. Do not use strong solvents.

---

## 17.1.2.3. Paintwork

The paintwork consists of multiple layers. It is an important part of the vehicle's corrosion protection and therefore needs to be checked regularly.

The most common types of paint damage are minor stone chips, scratches and damage to e.g. the edges of fenders, doors and bumpers. To help prevent corrosion, paint damage should be rectified immediately.

---

## 17.1.2.4. Color codes

The color code decal is placed on the vehicle's left-side door pillar (B-pillar) between the front and rear doors and is visible when the left front door is open.

## Color code

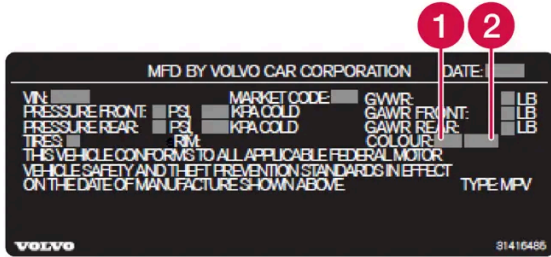

Sample color code (1): US models.

- 1 Exterior color code
- 2 Secondary exterior color code (if applicable)

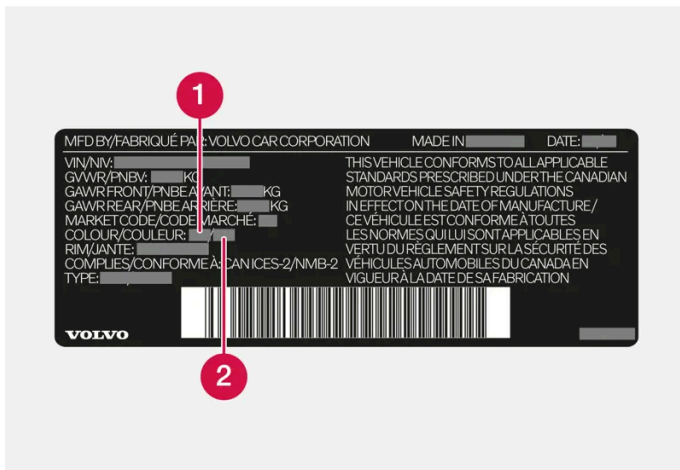

Sample color code (1): Canadian models.

- 1 Exterior color code
- 2 Secondary exterior color code (if applicable)

---

## 17.1.2.5. Touching up minor paint damage

The paintwork is an important part of the vehicle's corrosion protection and therefore needs to be checked regularly. The most common types of paint damage are minor stone chips, scratches and damage to e.g. the edges of fenders, doors and bumpers.

To help prevent corrosion, paint damage should be rectified immediately.

**Note**

Make sure the surface is clean and dry before performing any touch-ups to the paint. The surface temperature should be at least 15 °C (59 °F).

**Materials that might be needed**

- Primer – special adhesive primer is available in a spray can for e.g. plastic-covered bumpers.
- Base coat and clear coat – available in spray cans or as a touch-up pen/stick<sup>[1]</sup>.
- Masking tape.
- Fine-grain sandpaper.

## Applying touch-up paint to a damaged surface

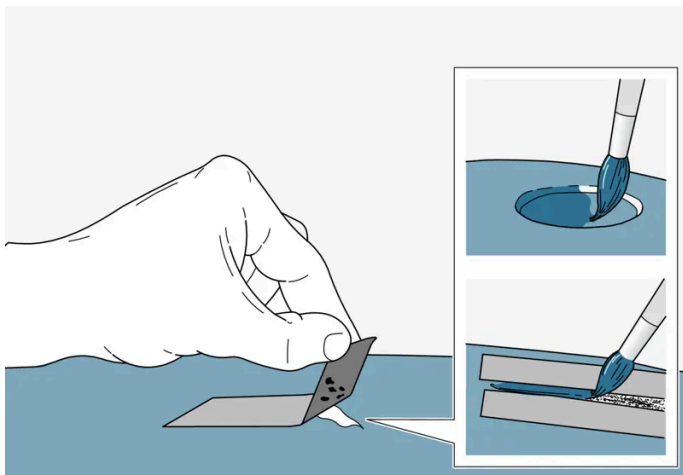

If the damage has not reached all the way down to the metal, then touch-up paint can be applied immediately after the surface has been cleaned.

- 1** Place a strip of masking tape over the damaged surface. Pull the tape off so that any loose flakes of paint adhere to it.  
If the damage goes down to the bare metal, you may need to use primer first. If the paint damage is on a plastic surface, an adhesive primer should be used for better results. Spray the primer into the lid of the spray can and brush on thinly.
- 2** Light sanding with a very fine-grained abrasive cloth or similar may be required before painting (e.g. if there are uneven edges). Clean the area carefully to remove dirt, grease, salts, etc. and let it dry.
- 3** Thoroughly mix the primer and apply it with a small brush, toothpick or similar. When the primer is dry, apply one or more coats of paint and then a clear coat, letting the paint dry between each application.

If there is a longer scratch, follow the same procedure as above, but first mask off the surrounding area to protect the undamaged paint.

Touch-up pens/sticks and spray paint are available at Volvo retailers.

 **Note**

If the stone chip has not gone down to the bare metal and an undamaged coat of paint remains, apply base coat and clear coat immediately after cleaning the surface.

<sup>[1]</sup> Follow the instructions on the packaging for the touch-up pen/stick carefully.

---

## 17.1.2.6. Cleaning the exterior

The vehicle should be washed as soon as it becomes dirty. This makes the vehicle easier to clean because dirt does not attach as strongly. It also reduces the risk of scratches and keeps the vehicle looking new. Wash the vehicle in a car wash or garage with an oil separator and use car washing detergent. Use cleaning agents and car care products recommended by Volvo.

### Important to keep in mind when washing your vehicle

- Avoid washing the vehicle in direct sunlight<sup>[1]</sup>. This could cause the detergent or wax to dry out and become abrasive.
- Remove bird droppings and tree sap and resin from the paint as soon as possible. They can contain substances that affect and discolor the paint very quickly. Use e.g. soft paper or a sponge soaked in lots of water. Consult an authorized Volvo workshop for assistance removing discoloration.
- In areas with heavy industrial emissions, more frequent washing of the vehicle's exterior is recommended.
- After the car has been washed, tar from asphalt may remain. Use the tar remover recommended by Volvo to remove the final stains.

<sup>[1]</sup> Does not apply to washing in an automatic car wash.

---

## 17.1.2.7. Corrosion protection

Your vehicle is constructed with protection against corrosion.

Corrosion protection for the body consists of modern metallic protective coatings on the sheet metal, a high-quality painting process, corrosion-protected and minimized metal overlap, and shielding plastic components, abrasion protection and supplemental rust inhibitor in exposed areas. In the chassis, exposed components of the wheel suspension are made of corrosion-resistant cast aluminum.

### Inspection and maintenance

The corrosion protection does not normally require maintenance, but keeping the vehicle clean helps reduce the risk of corrosion. The use of strong alkaline or acidic cleaning fluids should be avoided on shiny body components. Any stone chips in the paint should be touched up as soon as they are discovered.

## 17.1.2.8. Automatic car washes

It is important to prepare the vehicle before washing it in an automatic car wash. Carefully follow the instructions for vehicle handling before and during the car wash.

Automatic car washes can be a fast and easy way to clean the vehicle, but they do not reach all the parts of the vehicle that need regular cleaning. Volvo recommends supplementing automatic car washing with hand-washing.

### Note

Avoid washing a brand new vehicle in automatic car washes for the first few months after it leaves the factory. This will allow the paintwork to fully set.

### Preparations before washing

In automatic car washes in which the vehicle is pulled through the car wash, it is important to switch off functions that prevent the vehicle from rolling freely.

- Secure or remove protruding exterior parts such as retrofitted auxiliary lights, antennas, etc.
- Make sure that the automatic rain sensor function is switched off. The windshield wipers must be switched off throughout the car wash to avoid the risk of damage.
- Use the  button in the tunnel console to turn off the Auto-hold brake function.
- Switch off the warning and auto-braking when backing up functions in the center display's Park Assist Camera view. They may be reactivated if the vehicle is restarted, and must then be deactivated again.

### During the car wash

### Important

Keep the vehicle's windows, doors and tailgate closed throughout the car wash.

If the vehicle is equipped with keyless locking and unlocking\*:

Take out the key and place it in the open in the front section of the vehicle during the car wash. This minimizes the risk of unintentionally pressing the button that opens the tailgate, or of the key being incorrectly detected outside of the vehicle.

- 1 Drive into the car wash and stop at the designated place.
- 2 Put the gear selector in N.
- 3 Turn the start knob in the tunnel console clockwise and hold it for a few seconds to put the vehicle in ignition mode 0.
  - The motor is switched off, while the vehicle can roll freely.
- 4 The vehicle goes through the automatic car wash.
  - Keep your seat belt buckled for the entire car wash.

- Don't forget to reset the adjustments made before the car wash.

#### After the car wash

Depress the brake pedal lightly for a short time while driving after the brake pads have been exposed to moisture. The friction will heat up the brakes so that they will dry more quickly, reducing the risk of corrosion.



#### Warning

Always test the foot brake and parking brake after washing the vehicle to ensure they are functioning properly.

\* Option/accessory.

---

## 17.1.2.9. Cleaning exterior plastic, rubber and trim components

The vehicle should be washed as soon as it becomes dirty. The longer the dirt remains, the more difficult it will be to keep the vehicle clean. It could also lead to paint damage. Use a car washing detergent recommended by Volvo.

A special cleaning agent available from Volvo retailers is recommended for the cleaning and care of colored plastic parts, rubber and trim components, e.g. glossy trim. Follow the usage instructions for the cleaning agent carefully.

Avoid using car washing detergents with a pH value lower than 3.5 or higher than 11.5. Doing so could result in the discoloring of anodized aluminum surfaces\* (as shown in the illustrations below). Abrasive polishing agents are not recommended for these areas (as shown in the illustrations below).



Components that should be washed with a cleaning product with a pH value between 3.5 and 11.5.

 **Important**

Avoid waxing and polishing plastic and rubber.

If using degreaser on plastic and rubber, only rub (if necessary) with slight pressure. Use a soft sponge.

Polishing glossy trim moldings can wear away or damage the glossy surface layer.

Polish containing abrasives must not be used.

 **Important**

Avoid washing the vehicle with cleaner with a pH value below 3.5 or above 11.5. This could cause discoloration of anodized aluminum components like the roof rail and around the side windows.

Never use metal polishing agent on anodized aluminum components. This could cause discoloration and destroy the surface treatment.

\* Option/accessory.

---

## 17.1.2.10. Cleaning rims

The vehicle should be washed as soon as it becomes dirty. The longer the dirt remains, the more difficult it will be to keep the vehicle clean. It could also lead to paint damage. Wash the rims at a car wash or garage with an oil separator. Use a car washing detergent recommended by Volvo.

Use a rim cleaning agent recommended by Volvo.

Strong rim cleaning agents could damage the surface and stain the chromed aluminum rims.

---

## 17.1.2.11. Hand washing

The vehicle should be washed as soon as it becomes dirty. This makes the vehicle easier to clean because dirt does not attach as strongly. It also reduces the risk of scratches and keeps the vehicle looking new. Wash the vehicle in a car wash or garage with an oil separator and use car washing detergent. Use cleaning agents and car care products recommended by Volvo.

### Important to keep in mind when handwashing your vehicle

- Hose down the underbody, including the wheel housings and bumper.
- Hose down the entire vehicle and remove any loose dirt, droppings etc. to reduce the risk of scratches from washing. Do not spray directly onto locks.

- If necessary, use cold degreaser on heavily soiled surfaces. Note that in such cases the surfaces must not be hot from the sun.
- Wash using a sponge, car washing detergent and plenty of lukewarm water. Make sure that the sponge is clean. A dirty sponge can scratch the paint.
- Clean the wiper blades with lukewarm soap solution or car washing detergent.
- Dry the vehicle using a clean, soft chamois or a squeegee. Try not to let drops of water dry in strong sunlight. This could cause water drying stains that may need to be polished out.

 **Warning**

Always entrust engine washing to a workshop. If the engine is hot, there is a risk of fire.

 **Important**

Dirty headlights do not work as well. Clean them regularly, e.g. when refueling.

Do not use corrosive cleaners. Use water and a non-abrasive sponge. See separate section for more information.

 **Note**

Exterior lighting such as headlights and taillights may develop temporary condensation on the inside of the lens. This is normal. All exterior lighting is designed to resist this. Condensation is normally vented out of the lamp housing once the light has been lit for some period of time.

 **Important**

- Make sure that the panoramic roof\* and sun shade are closed before washing the vehicle.
- Never use abrasive polishing agents on the panoramic roof.
- Never use wax on the rubber seals around the panoramic roof.

 **Important**

Remember to remove dirt from the drain holes in the doors, sills and panoramic roof after washing the vehicle.

\* Option/accessory.

## 17.1.2.12. High-pressure washing



The vehicle should be washed as soon as it becomes dirty. The longer the dirt remains, the more difficult it will be to keep the vehicle clean. It could also lead to paint damage. Wash the vehicle in a car wash or garage with an oil separator. Use a car washing detergent recommended by Volvo.

If washing the vehicle with a high-pressure wash, use sweeping movements and keep the nozzle at least 30 cm (13 in.) from the vehicle. Do not spray directly on the lock or on the inside of the fuel filler door.

 **Important**

Do not use water hotter than 60 °C (140 °F) on the exterior lights, such as headlights and taillights. See separate section for more information.

## 17.1.2.13. Polishing and waxing

Polish and wax the vehicle when the paint is dull or to provide extra protection. The vehicle does not need to be polished until it is at least a year old. However, it can be waxed during the first year. Do not polish or wax the vehicle in direct sunlight. The surface of the vehicle should not be warmer than 45 °C (113 °F).

- Wash and dry the vehicle very carefully before polishing or waxing. Remove asphalt and tar stains with asphalt remover or paint thinner. More stubborn stains can be removed with a grinding paste designed for vehicle paint. Use cleaning agents recommended by Volvo.
- Use polish first and then liquid or paste wax. Follow the instructions on the package carefully. Many products contain both polish and wax.

 **Important**

Never polish or wax initially matte exterior details on the vehicle. This could destroy the matte effect and make the surface permanently shiny.

 **Important**

Avoid waxing and polishing plastic and rubber.

If using degreaser on plastic and rubber, only rub (if necessary) with slight pressure. Use a soft sponge.

Polishing glossy trim moldings can wear away or damage the glossy surface layer.

Polish containing abrasives must not be used.

 **Important**

Use cleaning agents recommended by Volvo. Other treatments, such as preservation, sealing, protection, luster sealing or similar, could damage the paintwork. Paintwork damage caused by such treatments are not covered by Volvo's warranty.

---

## 17.2. Wiper blades and washer fluid

---

### 17.2.1. Wiper blades and washer fluid

The wipers and the washer fluid are designed to improve visibility and the headlight pattern.

The washer nozzles are heated\* automatically in cold weather to prevent the washer fluid from freezing.

When there is approximately 1 liter (1 qt) of washer fluid remaining, a message to refill will appear in the instrument panel.

\* Option/accessory.

---

### 17.2.2. Putting the wiper blades in service position

The windshield wiper blades must be in the service (vertical) position for certain operations, e.g. replacing the blades.



Windshield wipers in the service position.

The windshield wipers must be in the service position when replacing, washing or lifting the blades (e.g. to scrape ice or snow from the windshield).

**!** Important

Before placing the wipers in service position, ensure that they have not frozen to the windshield.

### Activating/deactivating service position

The content of this manual represents the status of the user manual at the time of printing and may not be completely valid in future instances. For more information refer to the first page for the complete disclaimer note.

The service position can be activated/deactivated when the vehicle is stationary and the windshield wipers are switched off. Activating/deactivating the service position in the center display:

- 1 Tap  in the center display.
- 2 Then tap **Controls** and activate/deactivate service position for the wiper blades.

The wiper blades will also move out of the service position if:

- The windshield wipers are turned on.
- The windshield washers are turned on.
- The rain sensor is activated.
- The vehicle begins moving.

 **Important**

If the wiper arms in service position are raised from the windshield, they must be folded back against the windscreen before activating wiping, washing or rain sensor as well as before departure. This is to prevent scratching the paint on the hood.

## 17.2.3. Refilling washer fluid

Washer fluid is used to keep the headlights, windshield and rear window clean. Washer fluid containing anti-freeze should be used in very cold weather (below-freezing temperatures).

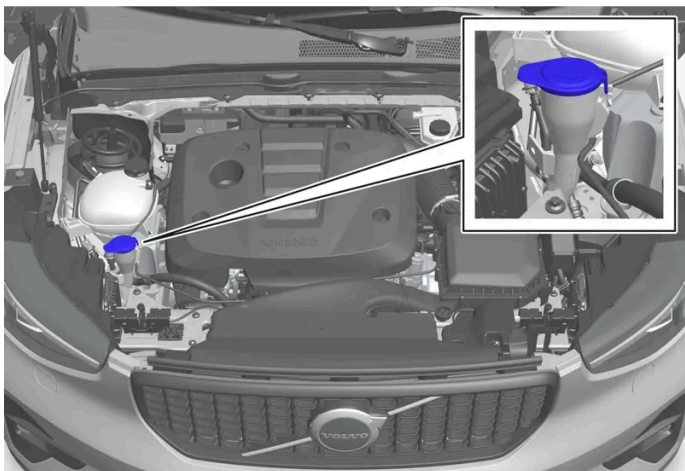

 **Note**

When there is approximately 1 liter (1 qt) of washer fluid remaining, the message **Refill washer fluid, level low** and the  symbol will be displayed in the instrument panel.

When the message **Refill washer fluid, level low** along with the symbol  is shown in the instrument panel, it is time to refill washer fluid.

- 1 Open the hood by first using the handle in the passenger compartment and then the handle under the front edge of the hood.
- 2 Open the cover on the washer fluid reservoir.  
Fill washer fluid into the reservoir with the blue cover. The reservoir is used for the windshield washer, tailgate window washer and headlight washer\*.
- 3 Pour in washer fluid until it is full.
- 4 Close the cover on the washer fluid reservoir and then close the hood.

**Recommended grade:** Washer fluid recommended by Volvo, with frost protection during cold weather and temperatures below the freezing point.

 **Important**

Use Volvo's original washer fluid or an equivalent fluid with the recommended pH value between 6 and 8, diluted as recommended, e.g. in a 1:1 solution with pH-neutral water.

 **Important**

Use washer fluid with anti-freeze when temperatures are below the freezing point to help keep the pump, reservoir and hoses from freezing.

**Volume:**

- Vehicles **with** headlight washing: 5.5 liters (5.8 qts).
- Vehicles **without** headlight washing: 3.5 liters (3.7 qts).

\* Option/accessory.

---

## 17.2.4. Changing rear window wipers

The content of this manual represents the status of the user manual at the time of printing and may not be completely valid in future instances. For more information refer to the first page for the complete disclaimer note.

The wiper blades help remove water from the windshield and rear window. Along with the washer fluid, they are designed to clean the glass and help improve visibility while driving. The windshield and rear window wiper blades can be replaced.

## Changing rear window wipers

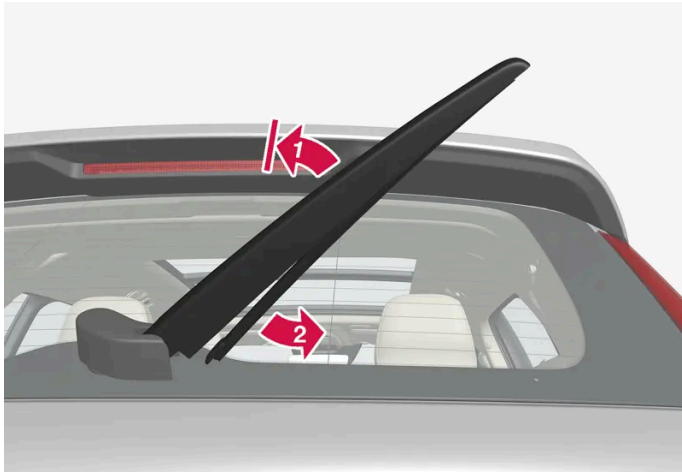

Lift the wiper arm from the window and pull the lower section of the blade to the right.

1 

Grasp the center of the wiper blade and lift it from the window to the stop position.

### Note

When the wiper arm is about halfway extended, resistance may be felt as the wiper stops in the stop position. This stop helps prevent the wiper arm from falling back onto the rear window. The wiper arm must be pulled past the locking position stop in order to change the wiper blade.

2 

Grip the lower part of the blade and pull to the right until the blade loosens from the arm.

3 Press the new wiper blade until it clicks into place. Check to make sure the blade is securely in place.

4 Fold the wiper arm back toward the window.

### Important

Check the blades regularly. Neglected maintenance shortens the life of the blades.

## 17.2.5. Replacing windshield wiper blades

The wiper blades help remove water from the windshield and rear window. Along with the washer fluid, they are designed to clean the glass and help improve visibility while driving. The windshield and rear window wiper blades can be replaced.

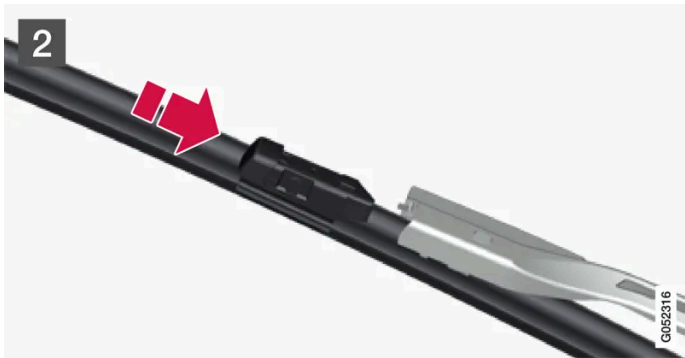
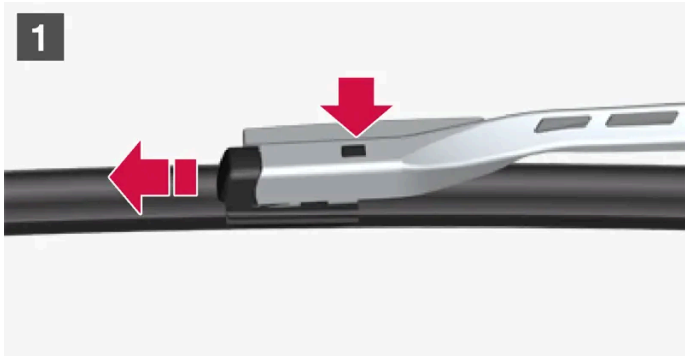

- 1** **1** Raise the wiper arms to the service position. Service position is activated/deactivated via the center display when the vehicle is stationary and the windshield wipers are not on. Press the button on the wiper blade attachment and pull the wiper blade straight out, parallel with the wiper arm.
- 2** **2** Slide in a new wiper blade until it clicks into place.
- 3** Check to make sure the blade is securely in place.
- 4** Press the wiper blade back against the windshield.

## Wiper blades come in varying lengths

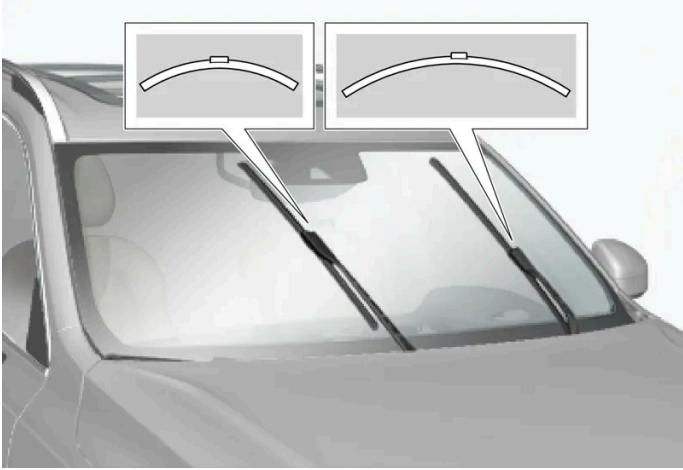

### **i** Note

When changing wiper blades, make sure that the blades are of different lengths. The blade on the driver's side is longer than the one on the passenger side.

## 17.3. Replacing bulbs

### 17.3.1. Replacing rear turn signal bulbs

The rear turn signal bulbs are located behind the panel in the side of the cargo compartment.

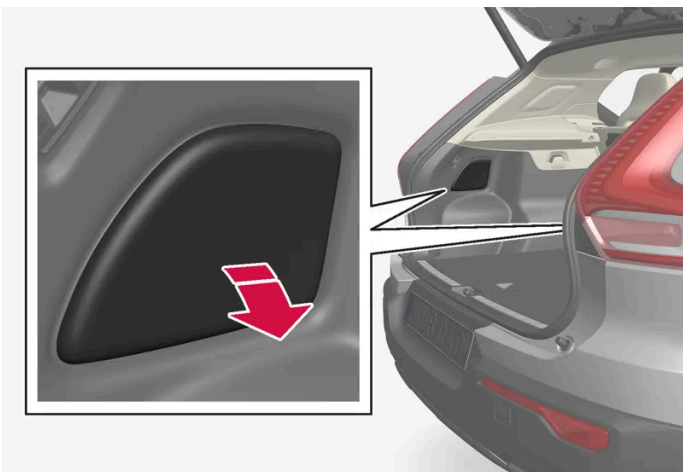

1. Press in the top edge of the panel cover to remove it.

2. Move aside the insulation to access the support bridge.

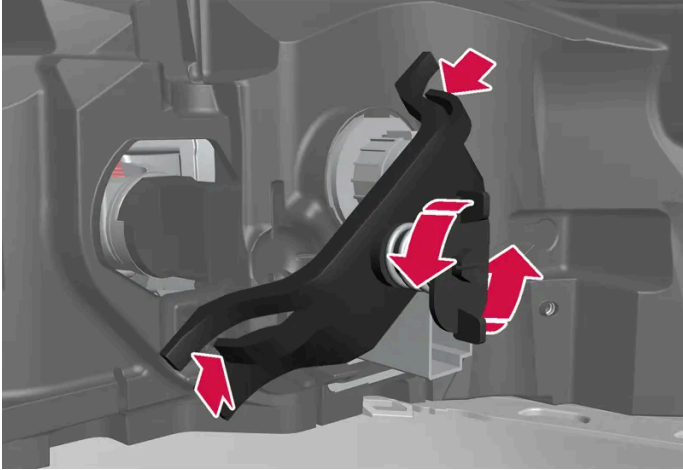

3. Unscrew the spring screw by turning counterclockwise, press the clips into the sides and remove the support bridge. It is simplest to leave one screw in place in the support bridge.

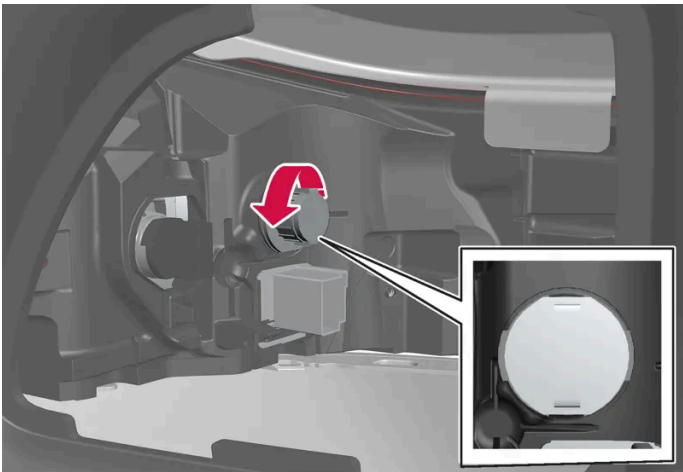

4. Remove the gray bulb holder by turning it counterclockwise and pulling it out.

5. Remove the bulb by pressing it in and turning it counterclockwise.

6. Insert the new bulb by pressing it in and turning it clockwise.

7. Put the panel back in place and turn it clockwise.

8. Install the support bridge using the supplied spring screw and make sure that the clip is positioned correctly. Tighten the spring screw until it stops, max. 2 Nm (1.5 ft lbs).

9. Reposition the insulation, hook the panel and then press it back into place.

 **Important**

Never touch the bulb glass with your bare fingers. Grease and oils from your fingers vaporize in the heat and will leave a deposit on the reflector, which may damage it.



**Note**

Exterior lighting such as headlights and taillights may develop temporary condensation on the inside of the lens. This is normal, and all exterior lighting is designed to resist this. Condensation is normally vented out of the lamp housing once the light has been lit for some period of time.

## 17.3.2. Replacing the brake light bulb

The brake light bulbs are located behind the panel in the side of the cargo compartment.

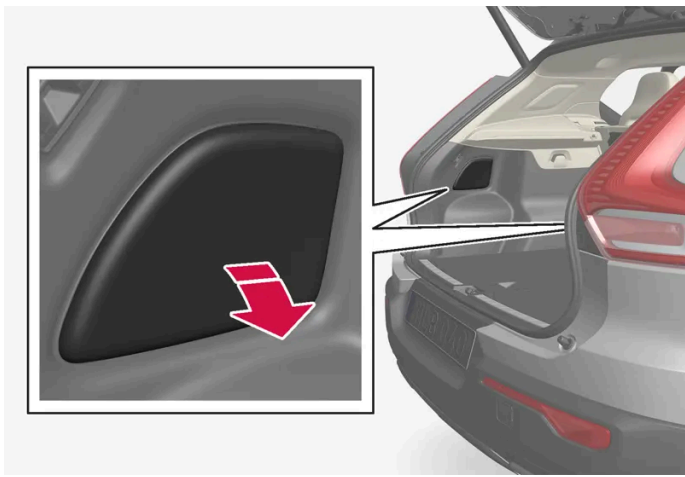

1. Press in the top edge of the panel cover to remove it.
2. Move aside the insulation to access the brake light bulb.

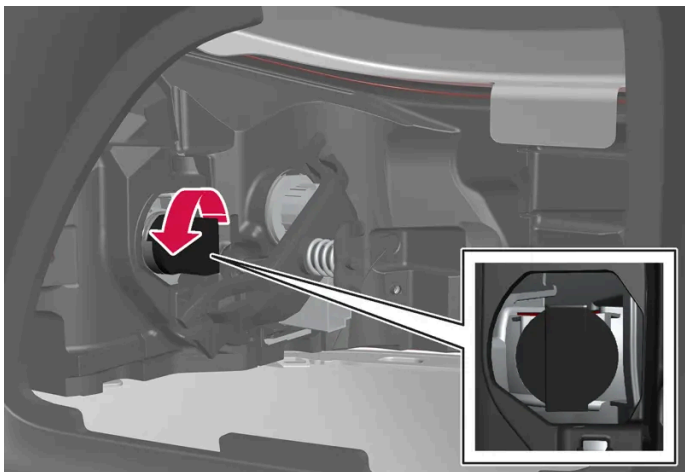

3. Remove the black bulb holder by turning it counterclockwise and pulling it out.
4. Remove the bulb by pressing it in and turning it counterclockwise
5. Insert the new bulb by pressing it in and turning it clockwise.
6. Put the panel back in place and turn it clockwise.
7. Reposition the insulation, hook the panel and then press it back into place.

 **Important**

Never touch the bulb glass with your bare fingers. Grease and oils from your fingers vaporize in the heat and will leave a deposit on the reflector, which may damage it.

 **Note**

Exterior lighting such as headlights and taillights may develop temporary condensation on the inside of the lens. This is normal, and all exterior lighting is designed to resist this. Condensation is normally vented out of the lamp housing once the light has been lit for some period of time.

---

### 17.3.3. Replacing the rear fog light bulb

The rear fog light is located in the rear bumper on the driver's side.

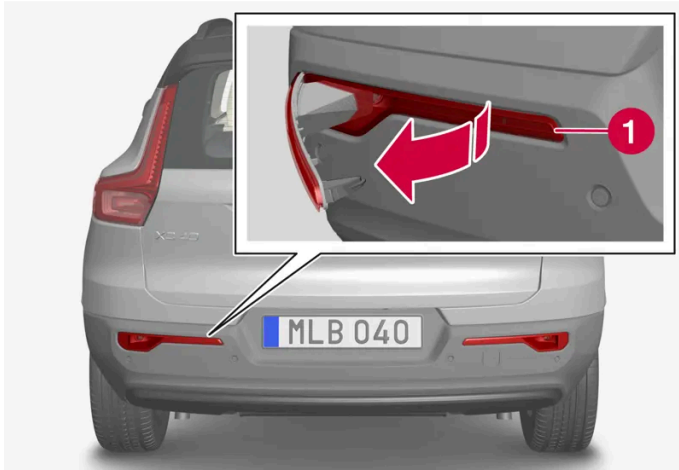

The rear fog light is only located on the driver's side.

- 1 Remove the fog light unit on the driver's side by inserting a flat object (e.g. a screwdriver) behind the light kit's narrower short side and prying out the fog light unit.
- 2 Unplug the connector.
- 3 Remove the bulb holder by turning it counterclockwise and pulling it out.
- 4 Remove the bulb by pressing it in and turning it counterclockwise.
- 5 Insert the new bulb by pressing it in and turning it clockwise.
- 6 Put the panel back in place and turn it clockwise.
- 7 Plug in the connector.
- 8 Insert the hook on the wide part of the fog light unit in the rear bumper and rotate the unit until the clips fasten into place.

**Note**

Exterior lighting such as headlights and taillights may develop temporary condensation on the inside of the lens. This is normal, and all exterior lighting is designed to resist this. Condensation is normally vented out of the lamp housing once the light has been lit for some period of time.

## 17.3.4. Replacing bulbs

Bulb types vary depending on model and equipment level. If a light bulb<sup>[1]</sup> breaks, it can be replaced by following the procedure shown in the Owner's Manual.

If you are experiencing problems with any lights other than light bulbs, contact a workshop<sup>[2]</sup>.

If there is a problem with an LED<sup>[3]</sup> light, the entire lamp unit will normally need to be replaced.

The content of this manual represents the status of the user manual at the time of printing and may not be completely valid in future instances. For more information refer to the first page for the complete disclaimer note.

 **Note**

For information on lights not mentioned in the Owner's Manual, contact a Volvo retailer or an authorized Volvo workshop.

 **Warning**

The vehicle electrical system must be in ignition mode 0 when bulbs are replaced.

 **Important**

Never touch the bulb glass with your bare fingers. Grease and oils from your fingers vaporize in the heat and will leave a deposit on the reflector, which may damage it.

 **Note**

If the error message persists after the defective bulb has been replaced, we recommend a visit to an authorized Volvo workshop.

 **Note**

Exterior lighting such as headlights and taillights may develop temporary condensation on the inside of the lens. This is normal, and all exterior lighting is designed to resist this. Condensation is normally vented out of the lamp housing once the light has been lit for some period of time.

<sup>[1]</sup> Some vehicles do not have any light bulbs.

<sup>[2]</sup> An authorized Volvo workshop is recommended.

<sup>[3]</sup> LED (Light Emitting Diode)

---

## 17.3.5. Location of exterior lights

The vehicle's exterior lighting consists of several different bulbs. LED<sup>[1]</sup> bulbs must be replaced by a workshop. An authorized Volvo workshop is recommended.

## Front lights

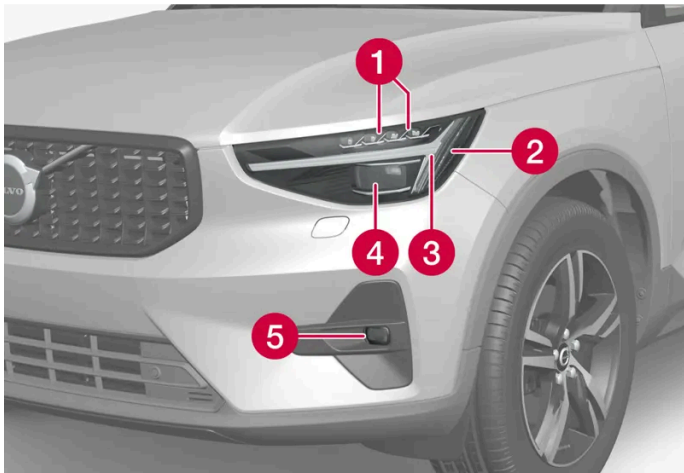

- 1 High beams/low beams (LED)
- 2 Side marker lights (LED)
- 3 Daytime running lights/position lamps/direction indicators (LED)
- 4 Pixel module\* for high and low beams (LED)
- 5 Front fog light/cornering illumination\* (LED)

## Rear bulbs



- 1 Brake light – central, high-mounted (LED)
- 2 Fog light
- 3 Parking light (LED)
- 4 Turn signals
- 5 Brake lights
- 6 Backup light (LED)

[1] LED (Light Emitting Diode)

\* Option/accessory.

---

## 17.3.6. Bulb specifications

Specifications for replaceable light bulbs.

If you are experiencing problems with any lights other than light bulbs, contact a workshop<sup>[1]</sup>. If there is a problem with an LED<sup>[2]</sup> light, the entire lamp unit will normally need to be replaced.

Function	W <sup>[3]</sup>	Type
Rear turn signals	21	PY21W
Brake lights	21	H21W LL
Rear fog light	21	H21W LL

<sup>[1]</sup> An authorized Volvo workshop is recommended.

<sup>[2]</sup> LED (Light Emitting Diode)

<sup>[3]</sup> Watt

---

## 17.3.7. Checking trailer lights \*

When connecting a trailer, make sure that the trailer's lights are functioning before starting to drive.

### Checking trailer lights \*

#### Automatic check

When the trailer has been connected to the vehicle's electrical system, its lights can be checked by automatically activating them. This function helps the driver check that the trailer's lights are functioning correctly before starting to drive.

- 1 When a trailer is connected to the towbar, the message **Perform a trailer lamp check?** will appear in the instrument panel.
- 2 Acknowledge the message by pressing the **O** button on the right-side steering wheel keypad.
  - The light check will begin.
- 3 Get out of the vehicle to perform the check.
  - All of the lights on the trailer will begin flashing, and then illuminate separately one at a time.
- 4 Visually check that all of the trailer's lights are functioning correctly.
- 5 After a short time, all of the trailer's lights will start flashing again.
  - The light check is completed.

## Trailer rear fog light

When a trailer is connected, the vehicle's rear fog light may not illuminate and rear fog light functionality is instead transferred to only the trailer. If this is the case, check to see if the trailer is equipped with a rear fog light before activating the vehicle's rear fog light when driving with a trailer to help ensure safe operation.

## Symbols and messages in the instrument panel

If one or more of the turn signals or brake lights on the trailer is not working, a symbol and message will be displayed in the instrument panel. The other lights on the trailer must be checked manually by the driver before the vehicle is driven.

Symbol	Message
	Right trailer turn indicator malfunction Left trailer turn indicator malfunction
	Trailer brake light malfunction

If any of the trailer's turn signal lights is not working, the turn signal symbol in the instrument panel will also flash more quickly than normal.

\* Option/accessory.

---

## 17.4. Engine compartment

### 17.4.1. Refilling washer fluid

Washer fluid is used to keep the headlights, windshield and rear window clean. Washer fluid containing anti-freeze should be used in very cold weather (below-freezing temperatures).

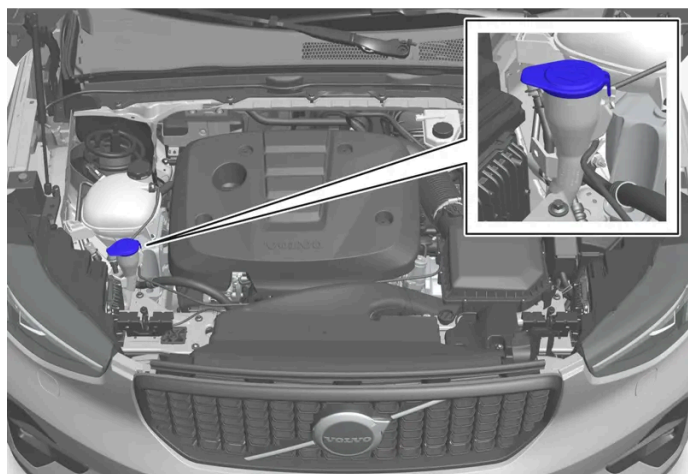

 **Note**

When there is approximately 1 liter (1 qt) of washer fluid remaining, the message **Refill washer fluid, level low** and the  symbol will be displayed in the instrument panel.

When the message **Refill washer fluid, level low** along with the symbol  is shown in the instrument panel, it is time to refill washer fluid.

- 1 Open the hood by first using the handle in the passenger compartment and then the handle under the front edge of the hood.
- 2 Open the cover on the washer fluid reservoir.  
Fill washer fluid into the reservoir with the blue cover. The reservoir is used for the windshield washer, tailgate window washer and headlight washer\*.
- 3 Pour in washer fluid until it is full.
- 4 Close the cover on the washer fluid reservoir and then close the hood.

**Recommended grade:** Washer fluid recommended by Volvo, with frost protection during cold weather and temperatures below the freezing point.

 **Important**

Use Volvo's original washer fluid or an equivalent fluid with the recommended pH value between 6 and 8, diluted as recommended, e.g. in a 1:1 solution with pH-neutral water.

 **Important**

Use washer fluid with anti-freeze when temperatures are below the freezing point to help keep the pump, reservoir and hoses from freezing.

**Volume:**

- Vehicles **with** headlight washing: 5.5 liters (5.8 qts).
- Vehicles **without** headlight washing: 3.5 liters (3.7 qts).

\* Option/accessory.

---

## 17.4.2. Brake fluid specifications

The content of this manual represents the status of the user manual at the time of printing and may not be completely valid in future instances. For more information refer to the first page for the complete disclaimer note.



The medium in the hydraulic brake system is called brake fluid and is used to transfer pressure from e.g. a brake pedal via a master brake cylinder, which in turn actuates the brake calipers.

**Recommended grade:** Volvo Original or similar fluid that meets a combination of Dot 4, 5.1 and ISO 4925 class 6.

**Note**

Changing or filling brake fluid should be entrusted to an authorized Volvo workshop.

### 17.4.3. Opening and closing the hood

To open the hood, pull the lever in the passenger compartment and then turn the handle under the front edge of the hood. It is important to follow the instructions for closing and check to make sure the hood is closed completely if it has been open.

#### Opening the hood

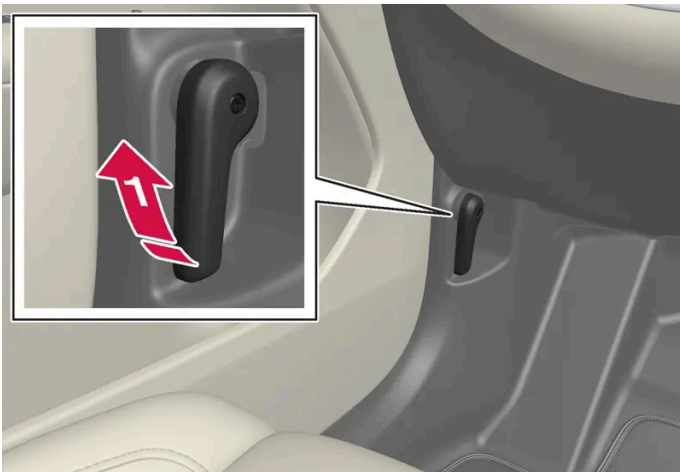

**➔** Pull the lever next to the pedals to release the hood from its fully closed position.



➡ Move the handle under the hood upwards to release the catch and lift the hood.

## Warning - hood not closed



An open hood is indicated by a warning symbol and graphic in the instrument panel as well as an audible signal.

### Note

If the vehicle indicates that the hood is open even though it is completely closed, open the hood and follow the instructions for closing it. Consult a workshop if the problem persists – an authorized Volvo workshop is recommended.

## Closing the hood

### Warning

To help prevent injury, make sure that there is nothing in the closing path of the hood.

- 1 Lower the hood until it reaches the lock catch.

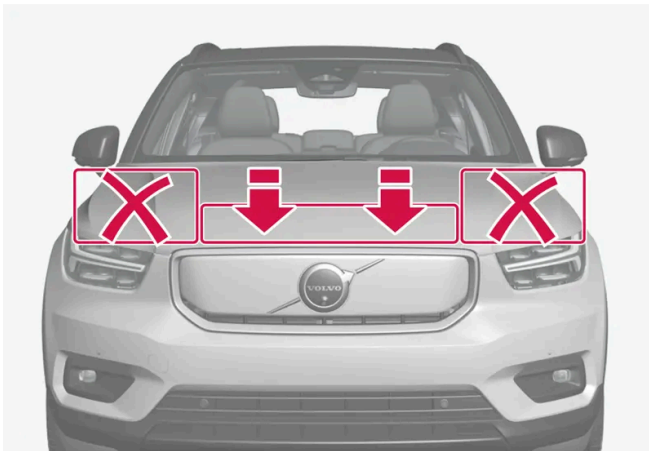

- 2 Press the hood down using both hands to close it completely. Only push on the front part of the hood above the grille plate. Do **not** push on the sides of the hood.
  - The hood must audibly lock into place on both sides.
- 3 Make sure that the hood locks securely into place without any gaps.

 **Warning**

Never drive with the hood open.

Check carefully to ensure that the hood closes completely after it has been open.

If the vehicle warns or indicates that the hood is open, or if anything indicates that it is not completely closed, stop immediately and close it properly.

## 17.4.4. Engine compartment overview

There are several service-related parts in the engine compartment.

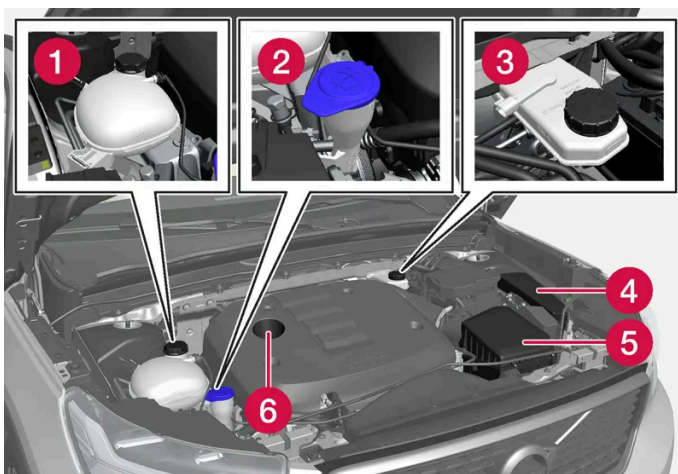

The layout of the engine compartment may vary depending on model and engine variant.

- 1 Coolant expansion tank
- 2 Washer fluid filler pipe
- 3 Brake fluid reservoir (located on the driver's side)
- 4 Fusebox
- 5 Air filter
- 6 Engine oil filler pipe

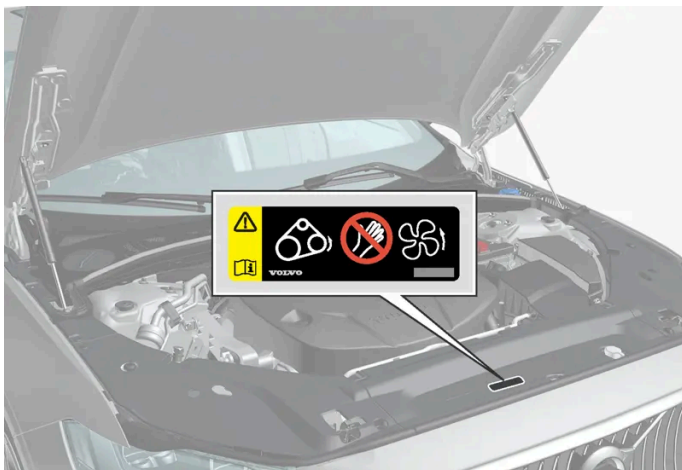

Location of warning decal for the engine compartment. The layout of the engine compartment may vary depending on model and engine variant.

 **Note**

The decals shown in the Owner's Manual do not claim to be exact reproductions of those found in the vehicle. The purpose is to show approximately how they look and about where they are located on the vehicle. The information that applies for your vehicle in particular is found on the decal on the vehicle.

 **Warning**

Bear in mind that the cooling fan (located at the front of the engine compartment behind the radiator) may start or continue running automatically up to about 6 minutes after the engine is turned off.

Always entrust engine washing to a workshop – an authorized Volvo workshop is recommended. If the engine is hot, there is a risk of fire.

 **Warning**

The ignition system works with extremely high and dangerous voltages. The vehicle electrical system should always be in ignition mode 0 when work is being performed in the engine compartment.

Do not touch any spark plugs or ignition coils when the vehicle electrical system is in ignition mode II or when the engine is warm.

## 17.4.5. Coolant

Coolant helps keep the combustion engine at the right operating temperature. Excess heat can be used to heat the passenger compartment.

**Recommended grade:**

Premixed coolant approved by Volvo.

If concentrated coolant is used, mix with 50% clean water. The purity level must meet Volvo's requirements. Consult a Volvo retailer if you have any questions.

To help prevent deterioration of the cooling system's function, which can lead to engine trouble and other issues, Volvo recommends using only Volvo-approved coolant.

 **Warning**

Never ingest coolant. It can damage kidneys and other organs. The product contains ethylene glycol, inhibitor, water, etc.

## 17.4.6. Refilling coolant

Follow the instructions on the coolant package when refilling. Never fill the cooling system with only water. The risk of freezing is increased with too low or too high amounts of coolant.

If there are any signs of leakage from the cooling system, do not start the vehicle and have it towed to help prevent engine damage. Signs of leakage include coolant under the vehicle, steam from the coolant system, or if more than 2 liters (about 2 quarts) are needed when refilling.

### Warning

The coolant can be very hot when the engine has been running. Always let the coolant cool off before unscrewing the cap to refill.

When refilling – carefully unscrew the cap to release any excess pressure.

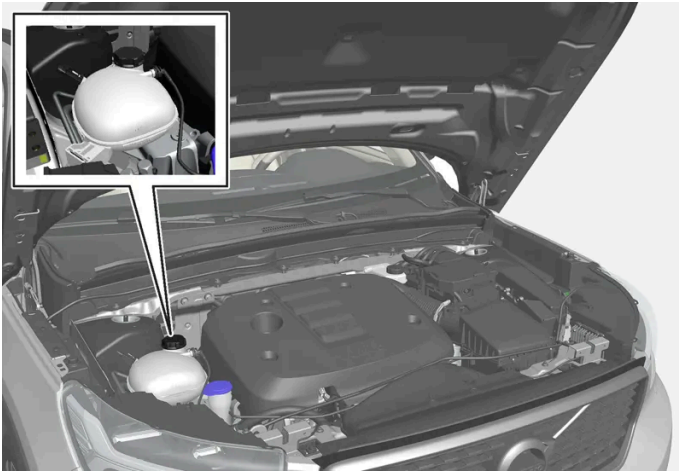

Coolant expansion tank

- 1 Unscrew the expansion tank cap and fill coolant as needed. The level should be between the MIN and MAX marks on the expansion tank.

**!** Important

- Coolant is harmful if swallowed and may cause damage to organs.
- Only use coolant of a grade approved by Volvo. If concentrated coolant is used, make sure that the coolant mixture is 50% coolant and 50% water of acceptable quality.
- Hard water and water with high levels of chlorine, chlorides and other salts or contaminants may cause corrosion in the cooling system.
- Do not mix different types of coolant.
- When replacing larger components in the cooling system, always replace all coolant with new coolant.
- Only operate the engine when the cooling system is filled to the correct level. A too-low coolant level can lead to overheating and engine damage.

## 17.4.7. Engine oil

Only use engine oil of the prescribed grade. This is a requirement for the recommended service intervals and warranties to apply.

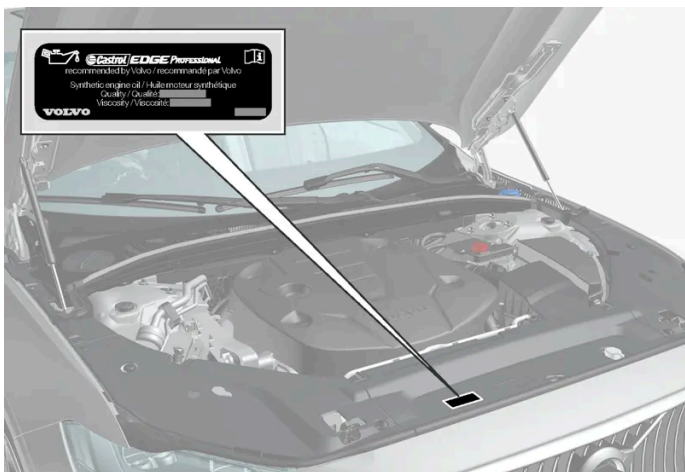

Location of warning decal for the engine compartment. The layout of the engine compartment may vary depending on model and engine variant.

Volvo recommends:



If the engine oil is not checked regularly and the level becomes low, this could cause serious engine damage.

 **Note**

The decals shown in the Owner's Manual do not claim to be exact reproductions of those found in the vehicle. The purpose is to show approximately how they look and about where they are located on the vehicle. The information that applies for your vehicle in particular is found on the decal on the vehicle.

 **Important**



To satisfy the requirements for the engine's service intervals, all engines are factory-filled with a specially adapted synthetic engine oil. Great care has been put into the choice of oil, with consideration given to service life, startability, fuel consumption and environmental impact.

For the recommended service intervals to apply, an approved engine oil must be used. Only use the prescribed oil grade to top off or change the oil. Otherwise, there is a risk of the vehicle's service life, startability, fuel consumption and environmental impact being affected.

Failure to use engine oil of the prescribed grade and viscosity could cause damage to engine-related components. Volvo disclaims warranty liability for such type of damage.

Volvo recommends entrusting oil changes to an authorized Volvo workshop.

## Symbols for low oil level

Volvo uses different systems to alert the driver of oil level or low oil pressure. Low oil pressure is indicated by a warning symbol  in the instrument panel. Warnings or information about the vehicle's oil level can be indicated by the warning symbol  in the instrument panel and messages. Contact a Volvo retailer for more information.

Change the engine oil and oil filter according to the schedule specified in the Warranty and Service Records Information booklet.

## 17.4.8. Checking and filling engine oil

The engine oil level is monitored by an electronic oil level sensor.

### Viewing oil level in the center display

The oil level can be shown in the center display when the vehicle is started. It should be checked regularly.

- 1 Tap  in the center display.
  - 2 Select **Car status**.
- Different types of information about the vehicle can be shown, including the oil level.

**Note**

The system cannot directly detect changes when the oil is filled or drained. The vehicle must have been driven approximately 30 km (20 miles) and have been stationary 5 minutes on a level surface and with the engine off before the correct oil level will be displayed.

**Note**

If the conditions for measuring oil level are not properly fulfilled (time after engine shutdown, vehicle inclination, ambient temperature, etc.) the message **No value available** will be shown in the center display. This does **not** mean that anything is wrong in the vehicle systems.

**Important**



If this symbol is shown, the oil pressure may be too low. Stop the vehicle as soon as possible and have it towed to a workshop – an authorized Volvo workshop is recommended.

## Filling engine oil

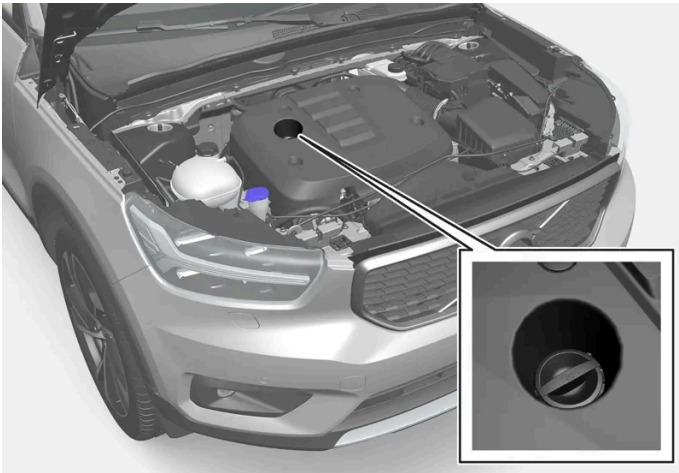

Filler pipe<sup>[1]</sup>, <sup>[2]</sup>

It may be necessary to top up engine oil between regularly scheduled services. No action is necessary with regard to engine oil level until a message appears in the instrument panel.

**Warning**

If the message **Engine oil level Service required** is displayed, the oil level may be too high. Drive to a workshop – an authorized Volvo workshop is recommended.



 **Warning**

Be careful not to spill oil in the engine compartment. This could lead to fire if the oil comes in contact with hot parts.

 **Important**

If a message appears to fill engine oil, add only the specified amount. A too-high level can lead to malfunction.

<sup>[1]</sup> Engines with an electronic oil level sensor do not have a dipstick.

<sup>[2]</sup> The layout of the engine compartment may vary depending on model and engine variant.

---

## 17.4.9. Engine oil specifications

Engine oil of type VCC RBS0-2AE 0W-20 must be used<sup>[1]</sup>. Lower oil grades may not offer the same fuel economy, engine performance or engine protection.

Volvo recommends:



### General

See the Service and warranty booklet for information about oil change intervals.

 **Note**

This vehicle is delivered from the factory with synthetic oil.

**Do not use oil additives.**

### Oil viscosity

The wrong oil viscosity can shorten engine service life during normal use. VCC RBS0-2AE 0W-20 provides good fuel economy and engine protection. See the viscosity chart.

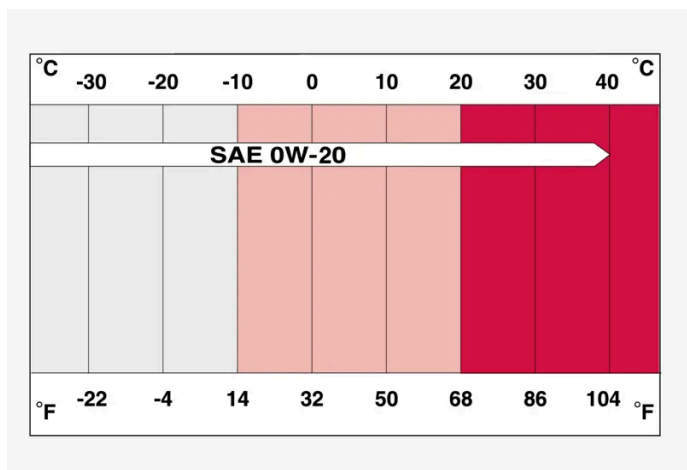

Viscosity chart

## Oil volume

Engine oil volumes (including oil filter) are shown in the table.

Liter (approx)	6.1
US qts (approx)	6.4

[1] 0W-30 or 5W-30 ACEA A5/B5 engine oil can also be used if VCC RBS0 2AE 0W-20 oil is not available.

## 17.4.10. Fuses in the engine compartment

The fuses in the engine compartment help protect electrical components such as engine and brake functions.

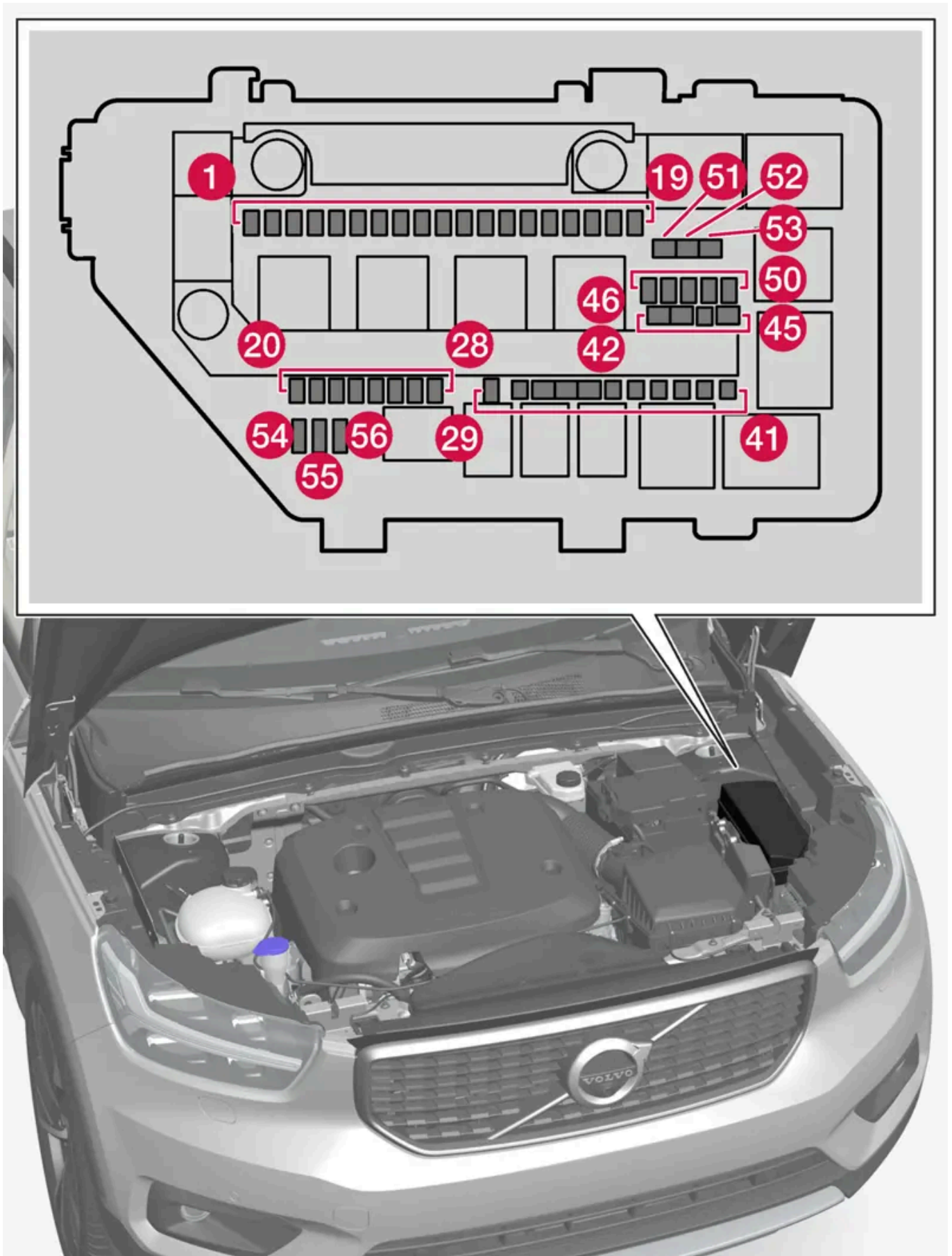

There are spaces for several extra fuses in the fuse box.

## Positions

The location of the fuses is shown on the inside of the cover. Functions and components in the fuse table cover several different models and engine variants. Therefore, a described fuse may apply to fewer components than those in the table, or be missing completely, depending on how the vehicle is equipped.

If a position has several values in the table, the value depends on variations in equipment level. If this is the case, follow the value on the replaced fuse. In the event of uncertainty, contact a workshop. An authorized Volvo workshop is recommended.

	Function	Ampere	Type
1	USB port in tunnel console, rear*	5	Micro
2	12 V outlet tunnel console, front	15	Micro
3	–	–	Micro
4	12 V outlet in trunk/cargo compartment*	15	Micro
5	Engine control module	20	Micro
6	Spark plug/ignition coils	15	Micro
7	Engine control module Fuel evaporation valve (EVAP)	15	Micro
8	Spoiler damper control module Cooler damper control module Engine oil pump solenoid A/C compressor solenoid Fuel leakage control pump Engine component group (Components related to engine function, including turbo/compressor and cooling/temperature regulation of driveline. Content depends on engine variant.)	15	Micro
9	Heated oxygen sensor group	15	Micro
10	–	–	Micro
11	Coolant pump	20	Micro
12	Headlight, right	20	Micro
13	Headlight, left	20	Micro
14	Airbags	5	Micro
15	Accelerator pedal sensor	5	Micro
16	Fed when ignition is on: engine control module, transmission components, electrical power steering, central electrical module, brake system control module	5	Micro
17	Auxiliary electric heater* Firewall module diagnostic port	5	Micro
18	–	–	Micro
19	–	–	Micro
20	Internal relay windings	5	Micro
21	–	–	Micro
22	Brake pedal sensor	5	Micro
23	Calculation module	5	Micro
24	Transmission actuator Clutch actuator	25	Micro
25	Transmission control module Clutch actuator	15 25	Micro Micro
26	Engine control module	5	Micro

The content of this manual represents the status of the user manual at the time of printing and may not be completely valid in future instances. For more information refer to the first page for the complete disclaimer note.

Function	Ampere	Type
27 Battery charger control module	5	Micro
28 Hybrid battery control module High-voltage converter high-voltage generator	5	Micro
29 Horn (honk)	20	Micro
30 Alarm siren*	5	Micro
31 Wipers	30	MCase+ <sup>[1]</sup>
32 Brake system control module (valves, parking brake)	40	MCase+ HT <sup>[1]</sup>
33 Brake system control module (ABS pump)	40	MCase+ HT <sup>[1]</sup>
34 Brake Assist System module	40	MCase+ HT <sup>[1]</sup>
35 Transmission actuator Transmission control module	30	MCase+ <sup>[1]</sup>
36 Transmission control module	30	MCase+ <sup>[1]</sup>
38 Headlights	30	MCase+ <sup>[1]</sup>
39 Brake assist control module	30	MCase+ <sup>[1]</sup>
40 Starter solenoid	30	MCase+ <sup>[1]</sup>
41 Towbar* control module	25	MCase+ <sup>[1]</sup>
42 Towbar* control module	40	MCase+ HT <sup>[1]</sup>
43 –	–	MCase+ HT <sup>[1]</sup>
44 Power driver seat*	20	MCase+ <sup>[1]</sup>
45 –	–	MCase <sup>[1]</sup>
46 –	–	Micro
47 Air conditioning Coolant heating control module	5	Micro
48 Hybrid battery control module High-voltage converter high-voltage generator	5	Micro
49 Shut-off valve, hybrid battery cooling Hybrid battery coolant pump	15	Micro
50 Electric drive system coolant pump	15	Micro
51 –	–	MCase+ <sup>[1]</sup>
52 –	–	MCase+ HT <sup>[1]</sup>
53 –	–	MCase+ HT <sup>[1]</sup>
54 Voltage check support battery	5	Micro
55 Headlight, left	20	Micro
56 Headlight, right	20	Micro

\* Option/accessory.

<sup>[1]</sup> This type of fuse should be replaced by a workshop. An authorized Volvo workshop is recommended.

---

## 17.5. Tools and accessories

---

### 17.5.1. Jack\*

The jack can be used to lift the vehicle to e.g. change a wheel.



#### Important

If a jack\* is provided with your vehicle, it is intended to be used only in temporary situations such as changing wheels in the event of a flat tire. Only the jack that came with your particular model should be used to lift the vehicle. If the vehicle needs to be lifted more frequently, or for a longer period of time than for a wheel change, a garage jack or hoist is recommended. Always follow this device's instructions for use.

When not in use, the jack should be kept in its storage compartment under the cargo compartment floor. Crank the jack to the correct position so that it fits.

The jack needs to be cranked together to the correct position in order to fit.

#### Note

For vehicles with leveling control\*: If the vehicle is equipped with pneumatic suspension, this feature must be turned off before the vehicle is lifted onto a tow truck.

\* Option/accessory.

---

### 17.5.2. Tire sealing system

The content of this manual represents the status of the user manual at the time of printing and may not be completely valid in future instances. For more information refer to the first page for the complete disclaimer note.

The temporary tire sealing system<sup>[1]</sup> (TMK) can be used to seal a puncture hole in a tire or to check and adjust the inflation pressure in the tire.

Models equipped with a spare wheel<sup>[2]</sup> do not have the tire sealing system.

 **Warning**

**California Proposition 65**

Operating, servicing and maintaining a passenger vehicle can expose you to chemicals including engine exhaust, carbon monoxide, phthalates, and lead, which are known to the State of California to cause cancer and birth defects or other reproductive harm. To minimize exposure, avoid breathing exhaust, do not idle the engine except as necessary, service your vehicle in a well ventilated area and wear gloves or wash your hands frequently when servicing your vehicle. For more information go to [www.P65Warnings.ca.gov/passenger-vehicle](http://www.P65Warnings.ca.gov/passenger-vehicle) [<https://www.p65warnings.ca.gov/products/passenger-vehicle>].

The tire sealing system consists of a compressor and a bottle containing sealing compound. The sealing functions as a temporary repair.

 **Note**

The sealing compound effectively seals tires with punctures in the tread but may not be able to fully seal tires with punctures in the sidewall. Do not use the tire sealing system on tires with large tears, cracks or similar damage.

 **Note**

The compressor is intended for temporary tire sealing and is approved by Volvo.

## Location

The tire sealing system is located in a foam block under the floor of the cargo compartment.



## Sealing compound expiration date

The sealing compound bottle must be replaced if its expiration date has passed (see the decal on the bottle). Handle the old bottle as hazardous waste.

The content of this manual represents the status of the user manual at the time of printing and may not be completely valid in future instances. For more information refer to the first page for the complete disclaimer note.

[1] Certain models only.

[2] Not available on all models.

---

## 17.5.3. Tool kit

Tools for e.g. towing or changing wheels are provided in the vehicle's cargo compartment.



Examples of tools that may be found in the vehicle.

- 1 Jack\*
- 2 Tool for removing the plastic wheel bolt covers
- 3 Funnel for refilling fluids
- 4 Wheel bolt key\* and towing eyelet

If the vehicle is equipped with a spare tire\* [1], a jack and wheel bolt key are provided instead of the tire sealing system.

\* Option/accessory.

[1] Not available on all models.

---

## 17.6. Fuses

### 17.6.1. Fuses and fuseboxes

Electrical functions and components are protected by a number of fuses in order to protect the vehicle's electrical system from damage by short circuiting or overloading. Fuses are located in the vehicle's fuse

The content of this manual represents the status of the user manual at the time of printing and may not be completely valid in future instances. For more information refer to the first page for the complete disclaimer note.



boxes.

 **Warning**

Never replace a fuse with a foreign object or a fuse with higher amperage. This could damage the electrical system and lead to fire.

Contact an authorized Volvo workshop for assistance replacing fuses not described in the Owner's Manual.

If any electrical component or function is not responding, the component's fuse may be overloaded and must then be replaced. If the same fuse is repeatedly overloaded, there may be a problem with the component. Volvo recommends contacting an authorized Volvo workshop to have the component checked.

## Location of fuseboxes



- 1 Engine compartment
- 2 Under the left front seat

## 17.6.2. Replacing fuses

An overloaded fuse needs to be replaced to restore function to the electrical component it protects.

- 1 Locate the correct fuse in the fuse diagrams for the different fuse boxes.
- 2 Pull out the fuse and examine it from the side to determine if the curved metal wire in the fuse is intact.
- 3 If the wire is broken, replace the fuse with a new fuse of the same color and amperage.

 **Note**

Some fuse boxes contain special pliers to make it easier to grip the fuse.

 **Warning**

Never replace a fuse with a foreign object or a fuse with higher amperage. This could damage the electrical system and lead to fire.

Contact an authorized Volvo workshop for assistance replacing fuses not described in the Owner's Manual.

 **Warning**

Contact an authorized Volvo workshop for assistance replacing fuses not described in the Owner's Manual.

---

## 17.6.3. Fuses under the left front seat

Fuses under the left front seat provide protection for e.g. electrical outlets, displays and door modules.

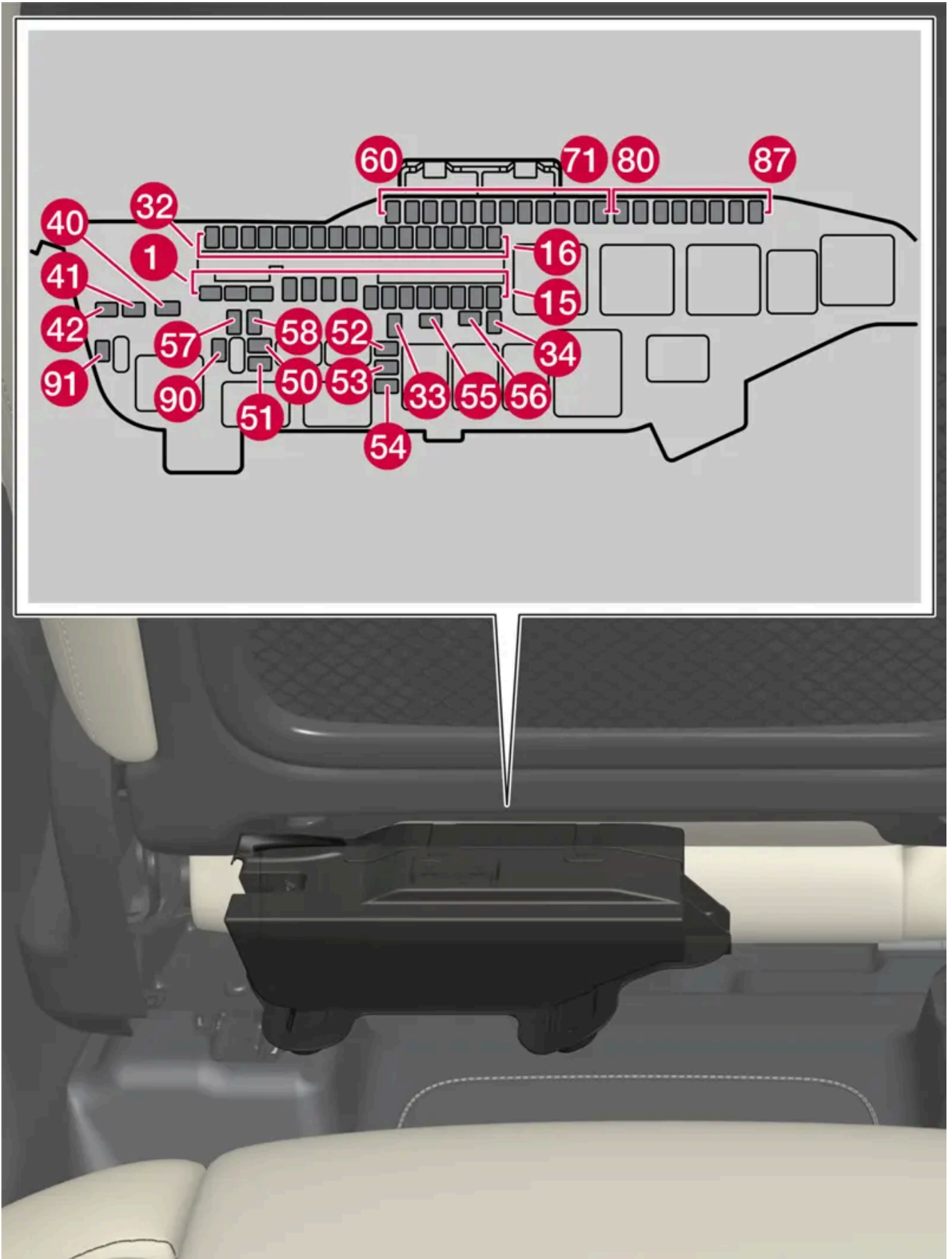

There are spaces for several extra fuses in the **distribution box in the engine compartment**.

## Positions

The location of the fuses is shown on the inside of the cover. Functions and components in the fuse table cover several different models and engine variants. Therefore, a described fuse may apply to fewer components than those in the table, or be missing completely, depending on how the vehicle is equipped.

If a position has several values in the table, the value depends on variations in equipment level. If this is the case, follow the value on the replaced fuse. In the event of uncertainty, contact a workshop. An authorized Volvo workshop is recommended.

	Function	Ampere	Type
1	Audio control module	40	MCaSe+ HT <sup>[1]</sup>
2	Central Electric Module A: Sensors, radar sensors, power seats*	40	MCaSe+ HT <sup>[1]</sup>
3	Central Electric Module B: Sensors, radar sensors, power seats*	40	MCaSe+ HT <sup>[1]</sup>
4	Climate system blower module (front)	40	MCaSe+ HT <sup>[1]</sup>
5	Power tailgate*	25	MCaSe+ <sup>[1]</sup>
6	Power seat*, right	20	MCaSe+ <sup>[1]</sup>
7	Parking heater*	25	MCaSe+ <sup>[1]</sup>
8	–	–	MCaSe+ <sup>[1]</sup>
9	Door module, right side, rear	20	Micro
10	Door module, left side, rear	20	Micro
11	Door module, left side, front	20	Micro
12	Safety module (ASDM)	5	Micro
13	Door module, right side, front	20	Micro
14	Seat heating, rear*	15	Micro
15	48 V battery control module	5	Micro
16	Calculation module	5	Micro
17	Sun sensor	5	Micro
18	–	–	Micro
19	Climate system control module	7,5	Micro
20	Interior movement sensors*	5	Micro
21	Instrument panel	5	Micro
22	Center console buttons	5	Micro
23	Steering wheel module	5	Micro
24	Start knob module Electronic shifting module Electronic parking brake	5	Micro
25	Center display	5	Micro
26	Connected services control module	5	Micro
27	Multiband antenna module Antenna module telematics	5	Micro
28	Relay coils	5	Micro
29	Opening tailgate with foot movement*	5	Micro
30	Sensus control module TV*	15	Micro

	Function	Ampere	Type
31	OBD-II diagnostic port	10	Micro
32	–	–	Micro
33	Lock motor for rear seat head restraint, left side	15	Micro
34	Lock motor for rear seat head restraint, right side	15	Micro
40	Heated rear window	30	MCASE+ <sup>[1]</sup>
41	Seat belt tensioner, left	40	MCASE+ HT <sup>[1]</sup>
42	Seat belt tensioner, right	40	MCASE+ HT <sup>[1]</sup>
50	Humidity sensor 48 V generator and voltage converter	5	Micro
51	Fuel pump control module	20	Micro
52	Coolant pump	7.5	Micro
53	Heated steering wheel*	15	Micro
54	Air humidity sensors Air particulate matter sensor	5	Micro
55	Headlight washers*	25	MCASE+ <sup>[1]</sup>
56	Windshield and tailgate window washers	25	MCASE+ <sup>[1]</sup>
57	–	–	MCASE <sup>[1]</sup>
58	–	–	MCASE <sup>[1]</sup>
59	–	–	Micro
60	–	–	Micro
61	–	–	Micro
62	–	–	Micro
63	Seat belt tensioners	5	Micro
64	Blind Spot Information (BLIS) *	5	Micro
65	–	–	Micro
66	Radar, front	5	Micro
67	All Wheel Drive (AWD) control module *	15	Micro
68	Exhaust system	5	Micro
69	Park Assist Camera *	5	Micro
70	–	–	Micro
71	Control module for airbags and seat belt tensioners	5	Micro
80	Rear window wiper	15	Micro
81	Roof console for panoramic roof*	2.0	Micro
82	–	–	Micro
83	Courtesy lighting Rearview mirror auto-dim* Rain and light sensor* Control panels in rear doors and cargo compartment	7.5	Micro
84	Wireless phone charger*	5	Micro
85	Driver support functions control module	5	Micro
86	–	–	Micro
87	USB port	5	Micro

The content of this manual represents the status of the user manual at the time of printing and may not be completely valid in future instances. For more information refer to the first page for the complete disclaimer note.

	Function	Ampere	Type
90	–	–	Micro
91	–	–	Micro

[1] This type of fuse should be replaced by a workshop. An authorized Volvo workshop is recommended.

\* Option/accessory.

---

## 17.6.4. Fuses in the engine compartment

The fuses in the engine compartment help protect electrical components such as engine and brake functions.

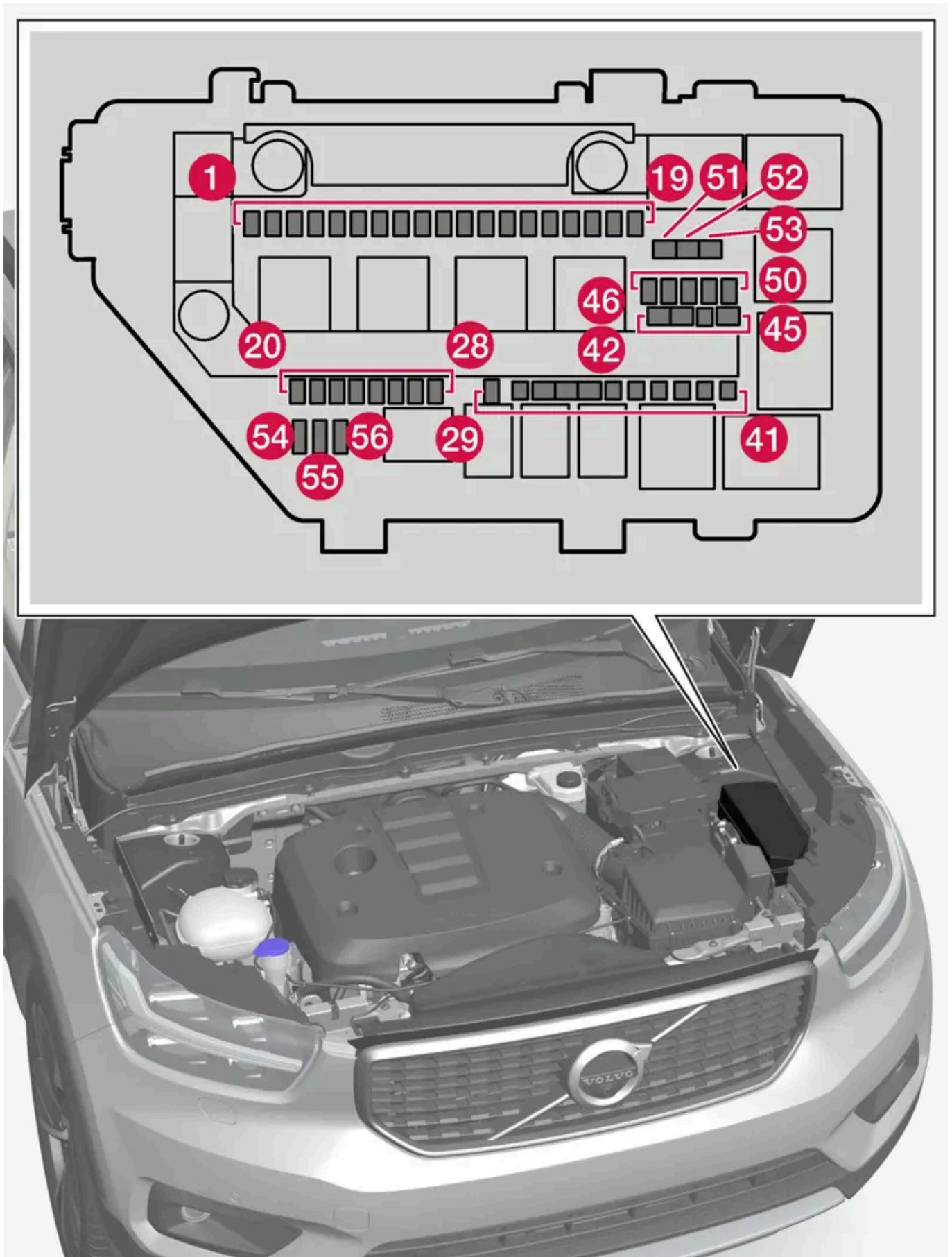

There are spaces for several extra fuses in the fuse box.

## Positions

The location of the fuses is shown on the inside of the cover. Functions and components in the fuse table cover several different models and engine variants. Therefore, a described fuse may apply to fewer components than those in the table, or be missing completely, depending on how the vehicle is equipped.

If a position has several values in the table, the value depends on variations in equipment level. If this is the case, follow the value on the replaced fuse. In the event of uncertainty, contact a workshop. An authorized Volvo workshop is recommended.

	Function	Ampere	Type
1	USB port in tunnel console, rear*	5	Micro
2	12 V outlet tunnel console, front	15	Micro
3	–	–	Micro
4	12 V outlet in trunk/cargo compartment*	15	Micro
5	Engine control module	20	Micro
6	Spark plug/ignition coils	15	Micro
7	Engine control module Fuel evaporation valve (EVAP)	15	Micro
8	Spoiler damper control module Cooler damper control module Engine oil pump solenoid A/C compressor solenoid Fuel leakage control pump Engine component group (Components related to engine function, including turbo/compressor and cooling/temperature regulation of driveline. Content depends on engine variant.)	15	Micro
9	Heated oxygen sensor group	15	Micro
10	–	–	Micro
11	Coolant pump	20	Micro
12	Headlight, right	20	Micro
13	Headlight, left	20	Micro
14	Airbags	5	Micro
15	Accelerator pedal sensor	5	Micro
16	Fed when ignition is on: engine control module, transmission components, electrical power steering, central electrical module, brake system control module	5	Micro
17	Auxiliary electric heater* Firewall module diagnostic port	5	Micro
18	–	–	Micro
19	–	–	Micro
20	Internal relay windings	5	Micro
21	–	–	Micro
22	Brake pedal sensor	5	Micro
23	Calculation module	5	Micro
24	Transmission actuator Clutch actuator	25	Micro
25	Transmission control module Clutch actuator	15 25	Micro Micro
26	Engine control module	5	Micro

The content of this manual represents the status of the user manual at the time of printing and may not be completely valid in future instances. For more information refer to the first page for the complete disclaimer note.



Function	Ampere	Type
27 Battery charger control module	5	Micro
28 Hybrid battery control module High-voltage converter high-voltage generator	5	Micro
29 Horn (honk)	20	Micro
30 Alarm siren*	5	Micro
31 Wipers	30	MCase+ <sup>[1]</sup>
32 Brake system control module (valves, parking brake)	40	MCase+ HT <sup>[1]</sup>
33 Brake system control module (ABS pump)	40	MCase+ HT <sup>[1]</sup>
34 Brake Assist System module	40	MCase+ HT <sup>[1]</sup>
35 Transmission actuator Transmission control module	30	MCase+ <sup>[1]</sup>
36 Transmission control module	30	MCase+ <sup>[1]</sup>
38 Headlights	30	MCase+ <sup>[1]</sup>
39 Brake assist control module	30	MCase+ <sup>[1]</sup>
40 Starter solenoid	30	MCase+ <sup>[1]</sup>
41 Towbar* control module	25	MCase+ <sup>[1]</sup>
42 Towbar* control module	40	MCase+ HT <sup>[1]</sup>
43 –	–	MCase+ HT <sup>[1]</sup>
44 Power driver seat*	20	MCase+ <sup>[1]</sup>
45 –	–	MCase <sup>[1]</sup>
46 –	–	Micro
47 Air conditioning Coolant heating control module	5	Micro
48 Hybrid battery control module High-voltage converter high-voltage generator	5	Micro
49 Shut-off valve, hybrid battery cooling Hybrid battery coolant pump	15	Micro
50 Electric drive system coolant pump	15	Micro
51 –	–	MCase+ <sup>[1]</sup>
52 –	–	MCase+ HT <sup>[1]</sup>
53 –	–	MCase+ HT <sup>[1]</sup>
54 Voltage check support battery	5	Micro
55 Headlight, left	20	Micro
56 Headlight, right	20	Micro

\* Option/accessory.

<sup>[1]</sup> This type of fuse should be replaced by a workshop. An authorized Volvo workshop is recommended.

---

## 17.7. Battery

---

### 17.7.1. Replacing the key's battery

The battery in the key can be replaced when it is discharged. Battery life depends on how much the key is used. The battery for the buttonless key (Key Tag)\* cannot be replaced.

 **Note**

All batteries have a limited service life and must eventually be replaced (does not apply for Key Tag). The battery's service life varies depending on how often the vehicle/key is used.



When the information icon illuminates and the message **The car key battery is low. See Owner's Manual for replacement.** appears in the instrument panel, the key's battery needs to be replaced.

Reduced key range is another sign that the battery level is low.

The battery in the buttonless key (Key Tag)\* cannot be replaced. When the battery is discharged, a new buttonless key can be ordered from an authorized Volvo workshop.

 **Important**

Hand in used Key Tags to an authorized Volvo workshop, where the key can be deleted from the vehicle's system. The key can still be used even if the battery is discharged to start the vehicle via a back-up start.

### Opening the key and replacing its battery

 **Important**

Do not touch the contact surfaces of new batteries. This impairs the battery's function.

Hold the key with the front side (with the Volvo logo) facing up, and the key ring bracket facing you.

There should be a catch to the left of the key ring bracket. If this catch is on the wrong side, the front and back sides have been switched during a previous battery change.

1 **1**



Move the catch next to the key ring bracket to the side and slide the front cover away from the bracket.

- The cover comes loose and can be lifted off.  
There is an additional catch under the front cover for removing the back cover.

2 **2**



Move the catch behind the front cover to the side and slide the rear cover away from the key ring bracket.

- The cover comes loose and can be lifted off.  
Under the rear cover is a battery cover.

3 **3**



Turn the battery cover counterclockwise to the OPEN position. Use a screwdriver, coin or similar.

Remove the battery cover. If it is difficult to remove, use a narrow object to carefully pry it up.

4 **4**



The battery's positive side (+) faces upward. Remove the battery by pressing its edge and then lifting it out.

5 **5**



Insert a new battery with the positive side (+) facing upward. Do not touch the contact surfaces of the key battery.

Place the edge of the battery under the two lower plastic catches.

Then push the battery down so that it is held in place by the upper plastic catch.

**i** Note

Use batteries with the designation CR2032, 3 V.

**i** Note

Volvo recommends that replacement batteries for the key meet the UN Manual of Test and Criteria, Part III, sub-section 38.3. The supplied batteries or batteries replaced by an authorized Volvo workshop meet the same criteria.

6 **6**



Put the battery cover back into place and turn it clockwise to the CLOSE position.

7 **7**



Put the back cover on in the reverse order it was removed. The back cover does not have a logo. Press the cover down until it clicks and then push it the last few millimeters back to its original position.

- A second click indicates that the cover is correctly positioned and locked into place. There should not be any gaps.

8 **8**



Turn the key and put the front cover back on in the same way as the back cover.

 **Warning**

Make sure the battery is positioned correctly with the right polarity. If the key will not be used for a prolonged period of time, remove the battery to avoid battery leakage and damage. Wear protective gloves when handling damaged batteries, as batteries that are damaged or leaking can cause corrosive damage in contact with the skin.

- Keep batteries out of the reach of children.
- Do not leave batteries lying out where they could be swallowed by children or pets.
- Never disassemble, short-circuit or place a battery into open fire.
- Do not charge non-chargeable batteries. They could explode.
- Check products with batteries regularly for signs of damage.

Do not use the key if there is anything to suggest that the key or its battery has been damaged or is beginning to leak. Keep defective products out of the reach of children.

 **Important**

Batteries must be recycled in an environmentally sound manner at the end of their service life.



### Warning

#### California Proposition 65

Operating, servicing and maintaining a passenger vehicle can expose you to chemicals including engine exhaust, carbon monoxide, phthalates, and lead, which are known to the State of California to cause cancer and birth defects or other reproductive harm. To minimize exposure, avoid breathing exhaust, do not idle the engine except as necessary, service your vehicle in a well ventilated area and wear gloves or wash your hands frequently when servicing your vehicle. For more information go to [www.P65Warnings.ca.gov/passenger-vehicle](http://www.P65Warnings.ca.gov/passenger-vehicle) [<https://www.p65warnings.ca.gov/products/passenger-vehicle>].

\* Option/accessory.

---

## 17.7.2. Battery drain

Using a lot of electrical current without allowing the vehicle to charge the start battery results in a low battery level and some electrical functions will be reduced or switched off. If the battery level drops below a certain level, it will no longer be possible to start the vehicle without jump-starting or charging of the start battery with an external charger.

Several measures can be taken to reduce power consumption. Avoid using ignition mode II when the engine is switched off. Instead, use ignition mode I, which uses less electrical current. Do not use functions that use a lot of electrical current when the vehicle is not being driven. Examples of such functions are:

- blower
- headlights
- windshield wipers
- audio system
- accessories plugged into the vehicle.

If the battery level is low, a message is shown in the instrument panel. The vehicle's energy-saving function will then turn off or reduce certain functions, such as the blower and the audio system.

- 1 Charge the start battery by starting the vehicle and letting it run for at least 15 minutes. The start battery is charged more effectively while driving than while idling.

If the battery level is still low after taking these measures, the vehicle should be checked by a workshop – an authorized Volvo workshop is recommended.

**Note**

High current consumption can lead to low battery level, which temporarily limits the start/stop function. The engine can then start automatically during a stop to charge the battery.

## 17.7.3. Jump starting using another battery

If the start battery is discharged, current from another battery can be used to start the vehicle.

Jump-starting requires access to another vehicle's 12 V battery and jumper cables.

**Important**

The charging points in mild hybrid vehicles are only intended for jump-starting your own vehicle. Don't use the charging points on mild hybrid vehicles to start other vehicles – the charging circuit's fuse could be overloaded and stop working.

In mild hybrid vehicles, a discharged start battery can be caused by an overloaded fuse that is preventing charging. If the fuse has blown, **12 V battery fuse failure Service required** will be displayed in the instrument panel. Volvo recommends contacting an authorized Volvo workshop.

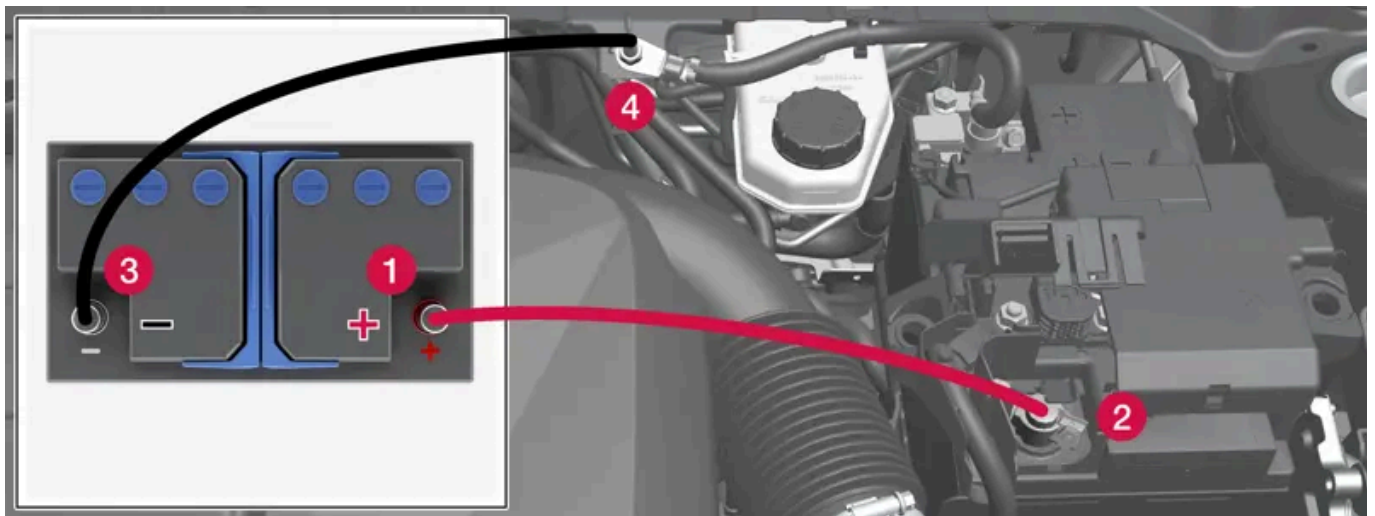

Jumper cable charging points. Engine compartment appearance may vary depending on vehicle model and equipment level.

To avoid short circuits or other damage, the following steps are recommended when jump starting the battery using another battery:

- 1 Put the ignition in mode 0.
- 2 Make sure that the assisting battery has a voltage of 12 V.
- 3 If the battery is in another vehicle, turn off that vehicle's engine and make sure that the vehicles are not touching each other.

- 4 Clamp one end of the red jumper cable to the assisting battery's positive terminal (1).

 **Important**

Connect the jumper cable carefully to prevent short circuit and contact with other components in the engine compartment.

- 5 Fold back the cover over your vehicle's positive charging point (2).
- 6 Clamp the other end of the red jumper cable to your vehicle's positive charging point (2).
- 7 Clamp one end of the black jumper cable to the assisting battery's negative terminal (3).
- 8 Clamp the other end of the black jumper cable to your vehicle's negative charging point (4).
- 9 Make sure the jumper cable's clamps are securely attached. Poor contact can cause sparks or the clamps to loosen during the start attempt.
- 10 Start the engine of the assisting vehicle and let it run for a few minutes at a higher idling speed than normal, about 1500 rpm.
- 11 Start the engine of the vehicle with the dead battery.

 **Important**

Do not touch the connections between the cable and the vehicle during the start attempt. Risk of sparking.

- 12 Remove the jumper cables in the reverse order – first the black cables and then the red cables.

Make sure that none of the clamps of the black jumper cables come into contact with the vehicle's positive charging point, the assisting vehicle's battery's positive terminal, or either of the red jumper cable's connected clamps.

 **Warning**

Mild hybrid vehicles have components that work with 48 V voltage, which can be dangerous if handled incorrectly. Do not touch components that are not clearly described in the Owner's Manual.

- Never use a 48 V support battery to jump-start the vehicle.
- External electrical equipment may not under any circumstance be connected to the 48 V battery.
- Only a workshop may replace or perform service on the 48 V battery – an authorized Volvo workshop is recommended.

 **Warning**

**PROPOSITION 65 WARNING!** Battery posts, terminals, and related accessories contain lead and lead compounds, chemicals known to the state of California to cause cancer and reproductive harm. Wash hands after handling.



 **Warning**

- Batteries generate hydrogen gas, which is flammable and explosive.
- Do not connect the jumper cable to any part of the fuel system or to any moving parts. Avoid touching hot manifolds.
- Battery fluid contains sulfuric acid. Do not allow battery fluid to contact eyes, skin, fabrics or painted surfaces.
- If contact occurs, flush the affected area immediately with water. Obtain medical help immediately if eyes are affected.
- Never expose the battery to open flame or electric spark. Do not smoke near the battery. Failure to follow the instructions for jump starting can lead to injury.

 **Note**

If the starter battery has such a low charge level that the vehicle does not have normal electrical functions and the engine must then be jump-started with an external battery or a battery charger, the Start/Stop function may remain activated. If the Start/Stop function shortly thereafter auto-stops the engine, there is a huge risk that auto-start of the engine will fail since the battery had not had time to recharge sufficiently.

If the vehicle has been jump-started or if there has not been enough time for the battery to be charged with a battery charger, the Start/Stop function should be temporarily deactivated until the battery has been recharged sufficiently. At an ambient temperature of about +15 °C (about 60 °F), the battery must be charged by the vehicle for at least 1 hour. At lower ambient temperatures, the charging time can increase to 3-4 hours. The recommendation is to charge the battery with an external battery charger, if possible.

## 17.7.4. Batteries and power supply

The vehicle's own power is supplied by different batteries and components. These enable the vehicle's electric functions.

The vehicle's primary electrical system operates with 12 V voltage and powers electrical equipment.

Mild hybrid\* vehicles are equipped with a 48 V system in addition to the primary electrical system.

### Batteries

To supply power to various components, your vehicle is equipped with:

- a 12 V start battery that powers the vehicle's primary electrical system
- a support battery that helps during the Start/Stop function's start sequence. The battery is either a 12 V battery or, if the vehicle is a mild hybrid\*, a 48 V battery that also enables regenerative braking while driving.

 **Warning**

Mild hybrid vehicles have components that work with 48 V voltage, which can be dangerous if handled incorrectly. Do not touch components that are not clearly described in the Owner's Manual.

- Never use a 48 V support battery to jump-start the vehicle.
- External electrical equipment may not under any circumstance be connected to the 48 V battery.
- Only a workshop may replace or perform service on the 48 V battery – an authorized Volvo workshop is recommended.

\* Option/accessory.

---

## 17.7.5. Recycling of batteries

Batteries must be recycled in an environmentally sound manner at the end of their service life.







Consult a workshop if you are uncertain of how to dispose of this type of waste – an authorized Volvo workshop is recommended. 48 V batteries in mild hybrid vehicles\* may only be handled by authorized workshop personnel.

\* Option/accessory.

---

## 17.7.6. Battery symbols

There are warning symbols and information on the batteries.

	Wear protective goggles.
	See the Owner's Manual for additional information.
	Keep batteries away from children.
	Batteries contain corrosive acid.
	Avoid smoking, open flames, and/or sparks.
	Risk of explosion.



Recycle properly.

## 17.7.7. Start battery

The start battery powers the vehicle's primary electrical system, which includes electrical equipment and engine start. If the vehicle is a mild hybrid\*, the engine is instead started by the support battery.

The start battery is a 12 V battery that is dimensioned to power the vehicle's specific electrical systems and functions.

- Never disconnect the start battery while the engine is running.
- Make sure the cables to the start battery are correctly connected and the clamps are securely tightened.

### Important

On certain models, the battery is secured with a tensioning strap. Make sure that the tensioning strap is always securely tightened.

### Important

If replacing the battery, make sure you replace it with a battery of the same size, cold start capacity and type as the original battery (see the decal on the battery). Volvo recommends having an authorized Volvo workshop change batteries.

### Warning

If the starter battery is disconnected, the function for automatic opening and closing must be reset to function correctly. A reset is required in order for the pinch protection to work.

### Warning

- Batteries generate hydrogen gas, which is flammable and explosive.
- Do not connect the jumper cable to any part of the fuel system or to any moving parts. Avoid touching hot manifolds.
- Battery fluid contains sulfuric acid. Do not allow battery fluid to contact eyes, skin, fabrics or painted surfaces.
- If contact occurs, flush the affected area immediately with water. Obtain medical help immediately if eyes are affected.
- Never expose the battery to open flame or electric spark. Do not smoke near the battery. Failure to follow the instructions for jump starting can lead to injury.

## Start battery service life, capacity and long-term storage

The content of this manual represents the status of the user manual at the time of printing and may not be completely valid in future instances. For more information refer to the first page for the complete disclaimer note.

The service life of the start battery is influenced by a number of factors, including the number of starts, discharges, driving style, driving conditions and climate conditions. The battery's starting capacity decreases over time. Severe cold further limits starting capacity.

The battery level can become low if the vehicle is not used for a prolonged period of time or if it is only driven short distances.

To keep the start battery in good condition, drive the vehicle at least 15 minutes a week or connect the battery to a battery charger with automatic maintenance charging. A starter battery that is always kept fully charged has the maximum service life.

## Location

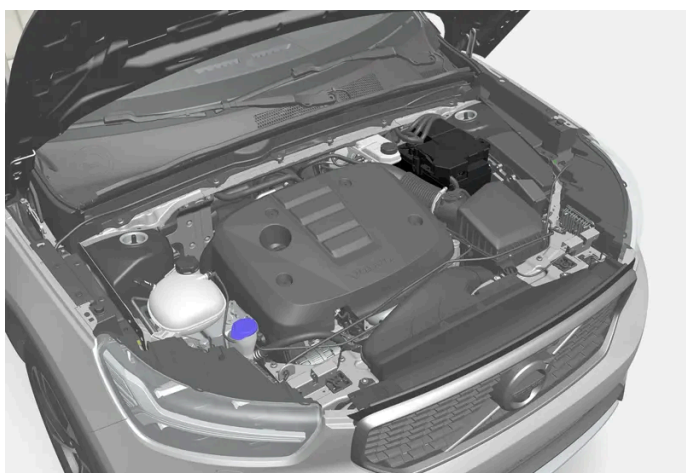

The start battery is located in the engine compartment.

## Specifications for start battery

Battery type	H6 EFB <sup>[1]</sup>	H6 EFB <sup>[1]</sup>
Voltage (V)	12	12
Cold start capacity <sup>[2]</sup> - CCA <sup>[3]</sup> (A)	680	720
Dimensions, L×W×H	278×175×190 mm (10.9×6.9×7.5 inches)	278×175×190 mm (10.9×6.9×7.5 inches)
Capacity (Ah)	70	70

\* Option/accessory.

<sup>[1]</sup> Available in certain markets.

<sup>[2]</sup> According to EN standard.

<sup>[3]</sup> Cold Cranking Amperes.

---

## 17.7.8. Support battery

The vehicle is equipped with a support battery that helps during the Start/Stop function's start sequence.

The battery is either a 12 V battery or, if the vehicle is a mild hybrid \*, a 48 V battery that also enables regenerative braking while driving.

The content of this manual represents the status of the user manual at the time of printing and may not be completely valid in future instances. For more information refer to the first page for the complete disclaimer note.

## Location

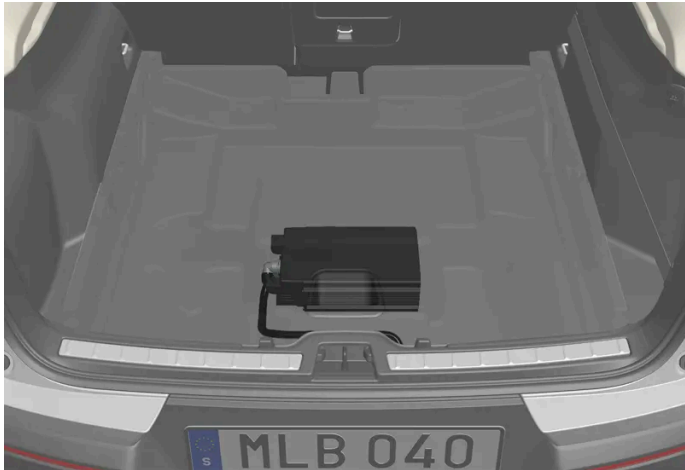

Mild hybrid vehicles have a 48 V support battery under the cargo compartment. The battery may only be handled by authorized workshop personnel.

## Maintenance of support battery

The support battery does not normally require more service than the start battery. If you have any questions or concerns, consult a workshop – an authorized Volvo workshop is recommended.

### Important

If replacing the 12 V battery, make sure you replace it with a battery of the same size, cold start capacity and type as the original battery. Volvo recommends having an authorized Volvo workshop change batteries.

### Warning

Mild hybrid vehicles have components that work with 48 V voltage, which can be dangerous if handled incorrectly. Do not touch components that are not clearly described in the Owner's Manual.

- Never use a 48 V support battery to jump-start the vehicle.
- External electrical equipment may not under any circumstance be connected to the 48 V battery.
- Only a workshop may replace or perform service on the 48 V battery – an authorized Volvo workshop is recommended.

## Specifications for support battery

If the vehicle is a mild hybrid\*, the support battery is a 48 V lithium-ion battery.

\* Option/accessory.

## 17.8. Service

---

### 17.8.1. Climate control system service

Service and repairs on the air conditioning system should only be done by an authorized workshop.

#### Troubleshooting and repairs

The air conditioning system contains a fluorescent tracer substance. Ultraviolet light is used to search for leaks.

Volvo recommends contacting an authorized Volvo workshop.

The climate system in the vehicle uses a freon-free R1234yf refrigerant. For information regarding the refrigerant, refer to the decal located on the inside of the hood.

#### Warning

The air conditioning system contains the refrigerant R1234yf under pressure. In accordance with SAE J2845 (Technician Training for Safe Service and Containment of Refrigerants Used in Mobile A/C System), service and repairs to the refrigerant system may only be performed by trained and certified technicians in order to ensure the safety of the system.

### 17.8.2. Volvo's service program

To keep the vehicle as safe and reliable as possible, follow the Volvo service schedule specified in the Warranty and Maintenance Records Information booklet.

#### Warning

##### California Proposition 65

Operating, servicing and maintaining a passenger vehicle can expose you to chemicals including engine exhaust, carbon monoxide, phthalates, and lead, which are known to the State of California to cause cancer and birth defects or other reproductive harm. To minimize exposure, avoid breathing exhaust, do not idle the engine except as necessary, service your vehicle in a well ventilated area and wear gloves or wash your hands frequently when servicing your vehicle. For more information go to [www.P65Warnings.ca.gov/passenger-vehicle](http://www.P65Warnings.ca.gov/passenger-vehicle) [<https://www.p65warnings.ca.gov/products/passenger-vehicle>].

Volvo recommends having an authorized Volvo workshop perform service and maintenance. Volvo workshops have the staff, service literature and special tools that can provide the highest quality of service.

#### Important

To ensure the Volvo warranty is not invalidated, check and follow the Warranty and Service Records Information booklet.

## Introduction

The maintenance services contain several checks that require special instruments and tools and therefore must be performed by a qualified technician. To keep your Volvo in top condition, specify time-tested and proven Genuine Volvo Parts and Accessories.

### The Federal Clean Air Act - U.S.

The Federal Clean Air Act requires vehicle manufacturers to furnish written instructions to the ultimate purchaser to assure the proper servicing and function of the components that control emissions. These services, which are listed in the "Warranty and Service Records Information" booklet, are not covered by the warranty. You will be required to pay for labor and material used.

### Maintenance

Your Volvo passed several major inspections before it was delivered to you, in accordance with Volvo specifications. The maintenance procedures outlined in the Warranty and Service Records Information booklet, many of which will positively affect your vehicle's emissions, should be performed as indicated. It is recommended that receipts for vehicle emission maintenance be retained in case questions arise concerning maintenance. Inspection and maintenance should also be performed anytime a malfunction is observed or suspected.

### Applicable warranties - U.S./Canada

In accordance with applicable U.S. and Canadian regulations, the following list of warranties is provided.

- New Vehicle Limited Warranty
- Parts and Accessories Limited Warranty
- Corrosion Protection Limited Warranty
- Seat Belt and Supplemental Restraint Systems Limited Warranty
- Emission Design and Defect Warranty
- Emission Performance Warranty

These are federal warranties; other warranties are provided as required by state/provincial law. Refer to your separate Warranty and Service Records Information booklet for detailed information concerning each of the warranties.

### Periodic maintenance helps minimize emissions

#### Note

- Refer to your Service and Warranty Booklet for a comprehensive service and maintenance schedule up to 240,000 km (150,000 miles). This program contains inspections and services necessary for the proper function of your vehicle and includes components that affect vehicle emissions.
- The Warranty and Service Records Information booklet also contains detailed information concerning the warranties that apply to your vehicle.

## On-board Diagnostic System

OBD II is part of your vehicle's computerized engine management system. It stores diagnostic information about your vehicle's emission controls. It can light the Check Engine light (MIL) if it detects an emission control "fault." A "fault" is a component or

system that is not performing within an expected range. A fault may be permanent or temporary. OBD II will store a message about any fault.

## Emission inspection readiness

### How do states use OBD II for emission inspections?

Many states connect a computer directly to a vehicle's OBD II system. The inspector can then read "faults." In some states, this type of inspection has replaced the tailpipe emission test.

### How can my vehicle fail OBD II emission inspection?

Your vehicle can fail OBD II emission inspection for any of the following reasons:

- If your Check Engine (MIL) light is lit, your vehicle may fail inspection.
- If your vehicle's Check Engine light was lit, but went out without any action on your part, OBD II will still have a recorded fault. Your vehicle may pass or fail, depending on the inspection practices in your area.
- If you had recent service that required disconnecting the battery, OBD II diagnostic information may be incomplete and "not ready" for inspection. A vehicle that is not ready may fail inspection.

### How can I prepare for my next OBD II emission inspection?

- If your Check Engine (MIL) light is lit or was lit but went out without service, have your vehicle diagnosed and, if necessary, serviced by a qualified Volvo technician.
- If you recently had service for a lit Check Engine light, or if you had service that required disconnecting the battery, a period of driving is necessary to bring the OBD II system to "ready" for inspection. Two half-hour trips of mixed stop-and-go/highway driving are typically needed to allow OBD II to reach readiness. Your Volvo retailer can provide you with more information on planning a trip.
- Maintain your vehicle in accordance with your vehicle's maintenance schedule.

## Owner maintenance

Periodic maintenance requirements and intervals are described in your vehicle's Warranty and Service Records Information booklet.

The following points can be carried out between the normally scheduled maintenance services.

### Each time the vehicle is refueled:

- Check the engine oil level.
- Clean the windshield, windshield wipers, headlights, and taillights.

### Monthly:

- Check cold tire pressure in all tires. Inspect the tires for wear.
- Check that engine coolant and other fluid levels are between the indicated "min" and "max" markings.
- Clean interior glass surfaces with a glass cleaner and soft paper towels.
- Wipe driver information displays with a soft cloth.



- Visually inspect battery terminals for corrosion. Corrosion may indicate a loose terminal connector, or a battery near the end of its useful service life. Consult your Volvo retailer for additional information.

**As needed:**

Wash the vehicle, including the undercarriage, to reduce wear that can be caused by a buildup of dirt, and corrosion that can be caused by salt residues.

Clean leaves and twigs from air intake vents at the base of the windshield, and from other places where they may collect.

**Note**

Complete service information for qualified technicians is available online for purchase or subscription at [www.volvotechinfo.com](http://www.volvotechinfo.com).

## 17.9. Recommended maintenance for the camera, sensor and radar units

In order for the cameras, parking sensors and radar units to function properly, they must be kept free of dirt, ice, snow, etc. and should be washed regularly with water and car washing detergent.

- Do not attach any items, tape or decals in the areas described below.
- Clean the camera lenses regularly using lukewarm water and car washing detergent. Wash gently to avoid scratching the lens.
- Avoid mounting extra lights or similar in the grille, as this could affect the front radar unit's performance.
- To help ensure proper functioning of the front radar unit, use only the Volvo original emblem in the grille in front of the front radar unit.

### Location of the radar units

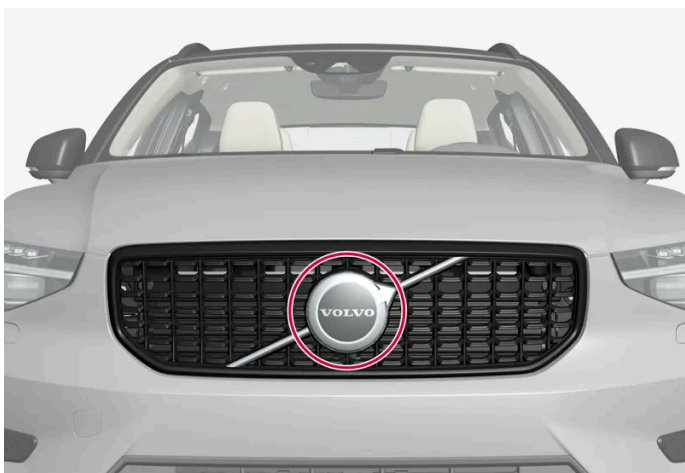

Location of the front radar sensor



Location of rear radar sensors

### Location of the Park Assist sensors



Location of the parking sensors around the vehicle

**i Note**

Dirt, ice and snow covering the sensors could cause false warnings, reduced function, or no function.

## Location of the camera



Location of the camera

### ! Important

Only a workshop may perform maintenance on driver support components – an authorized Volvo workshop is recommended.

## 17.10. Software Updates

The vehicle's software is updated through its connection to the cellular network via OTA (over-the-air) updates.

When a new software update is available, it will be shown in Notifications view. Once it has been downloaded, you can choose when it should be installed. Update the vehicle's software as soon as possible when an update is available.

### Downloading

#### i Note

The software in declared ordinary software release windows does not affect certification, safety, emissions or non-compliance.

The download takes place in the background over the cellular network<sup>[1]</sup>. Depending on the size of the update and connection speed, this may take several hours.

To download updates:

- the vehicle must be connected to the Internet<sup>[2]</sup>.
- use of connected services must be approved.

 **Note**

Depending on software version, downloads can take place automatically or be started via a notification of an available software update.

## Installing updates

 **Note**

Do not use the data link connector when installing a software update as this may affect the installation process and the vehicle's systems.

When a software update has been downloaded and is ready to be installed, this will be indicated in Notifications view and via a message when the vehicle is started. You can choose to install the update immediately or be reminded again at a later time.

You can access the updates view by tapping , **System, System details, Software update**. You can also see the vehicle's current software version number there.

 **Note**

Installation of the software update may take up to 90 minutes. During this time, the vehicle is locked and its functions are unavailable. Keep this in mind when choosing a time for the update.

Before installation:

- 1 When an update is ready to be installed, this will be shown in Notifications view. Open the notification and follow the instructions in the center display.
- 2 Exit the vehicle, close all doors and lock the vehicle.
  - Installation will begin. The vehicle must be locked within a few minutes or installation will be canceled.
- 3 Wait until the installation is finished.
  - The installation can take up to 90 minutes. When the installation is finished, the vehicle can be operated as usual.

 **Note**

- If possible, avoid handling the vehicle and its functions during installation.
- If you need to get into the vehicle while installation is in progress, you must use the key blade.
- To avoid false alarms, the vehicle's burglary alarm will be deactivated during installation.

Always read through the contents of the update so that you know how the vehicle and its functions will be affected.

If the installation fails, the vehicle's systems will reset to the last installed version.

**The content of this manual represents the status of the user manual at the time of printing and may not be completely valid in future instances. For more information refer to the first page for the complete disclaimer note.**

 **Note**

It is important to install software updates as soon as possible to avoid risks that may be associated with older software. If you experience any problems with the update, contact your Volvo retailer.

## Information on contents

You can tap the information icon in the center display to see more information about the content of the software update.

 **Note**

Functionality after updating may vary depending on market, model, model year and options.

<sup>[1]</sup> Applies for vehicles with software version 2.9 or later. For vehicles with older software, the download can only be done while the vehicle is being driven. It may therefore take several driving cycles before the software is fully downloaded.

<sup>[2]</sup> There may be a charge for transmitting data over the Internet, depending on your service plan. Volvo covers data traffic charges for system updates if no personal SIM card is installed.

---

## 17.11. Maintenance of the brake system

Regularly check the brake system components for wear.

To keep the vehicle as safe and reliable as possible, follow the Volvo service schedule specified in the Warranty and Maintenance Records Information booklet. After replacing brake pads and brake discs, braking effect is not adapted until they are "broken in" by driving a few hundred kilometers (miles). Compensate for the reduced braking effect by applying greater pressure to the brake pedal. Volvo recommends only using brake pads approved for your Volvo.

 **Important**

The brake system's components should be regularly checked for wear.

Contact a workshop for advice on how to do this or let a workshop perform the inspection - an authorized Volvo workshop is recommended.

---

## 17.12. Data transfer between vehicle and workshop over Wi-Fi

Volvo workshops have a designated Wi-Fi network for data transfer between the vehicle and the workshop. The key buttons are used to connect the vehicle to the Internet, so it is important to bring a key with buttons to workshop visits.

The content of this manual represents the status of the user manual at the time of printing and may not be completely valid in future instances. For more information refer to the first page for the complete disclaimer note.

During workshop visits, service technicians perform troubleshooting and update software via the network.

## Connecting to the Internet using the key

Pressing the lock button on the key three times will connect the vehicle to the workshop's network. Connection to the Internet is usually performed by the service technician.

When the car is connected to a Wi-Fi network, the  symbol appears in the center display.

The key cannot be used to connect to other Wi-Fi networks.



### Warning

The vehicle may not be driven when it is connected to the workshop's networks and systems.

## 17.13. Hoisting the vehicle

When lifting the vehicle using a jack\*, it is important to use the correct lifting points on the chassis. There are different lifting points depending on which lifting equipment is used. Read through all instructions before lifting.

The vehicle can be lifted with a jack designed for occasional lifts, with a garage hoist if regular lifts are required, or by authorized workshop personnel who have access to larger lifting devices.



### Note

Volvo recommends only using the jack intended for your specific vehicle model. If another jack must be used, follow the instructions supplied with it.

The vehicle's ordinary jack\* is only intended to be used in temporary situations for short periods of time, such as when changing wheels in the event of a flat tire. If the vehicle needs to be lifted more frequently, or for a longer period of time than for a wheel change, a garage hoist is recommended. In this case, follow the instructions supplied with the hoist.

 **Warning**

- The vehicle must not be able to roll when it is lifted. Put on the parking brake and select parking mode (P).
- Chock the wheels standing on the ground, using rigid wooden blocks or large stones, both in front of and behind the wheels.
- Use a jack designed for your vehicle model when changing a tire. For any other job, also use stands to support the vehicle.
- Do not use a jack that is in poor condition. Make sure that the threads are lubricated and that it is free of damage and dirt.
- Make sure the jack is stable. The surface must be solid, level and not slippery.
- No objects should be placed between the base of jack and the ground, or between the jack and the lifting point on the vehicle.
- Never let anyone remain in the vehicle while it is raised on a jack. Make sure that passengers stand in a safe place away from the vehicle if the tire needs to be changed in an area with traffic.
- Do not allow any part of your body to be extended under a vehicle supported with a jack.

### Lifting points

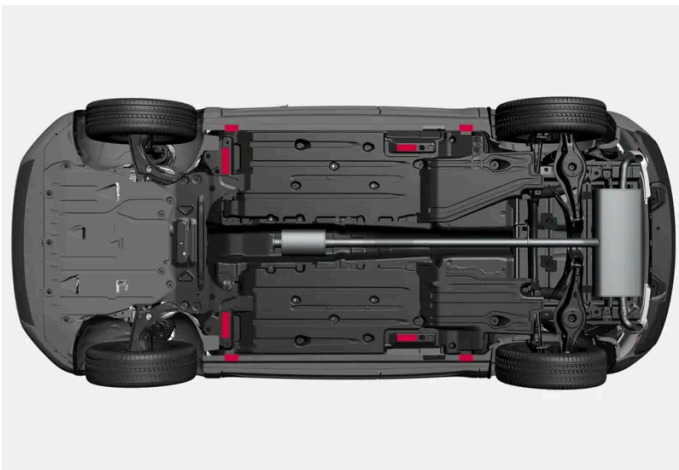

The vehicle has outer lifting points for smaller lifts, and inner lifting points for larger lifts with a garage hoist, lifting arms, etc.

 **Warning**

If the vehicle is lifted using a workshop hoist, the hoist must be placed under the inner lifting points. Follow the instructions provided with the workshop jack. Be precise when positioning the jack to ensure that the vehicle cannot slip off while lifting. Make sure the top of the jack is equipped with a rubber pad to help keep the vehicle stable and prevent damage. Use axle stands or similar when the vehicle is raised.

### Lifting a wheel with a jack

Read through all instructions before starting. Before raising the vehicle using a jack or lift, take out all the tools you will need.

- 1 Activate the hazard warning flashers if the vehicle needs to be lifted in an area with traffic.

- 2 Apply the parking brake. Put the gear selector in P.
- 3 Place chocks in front of and behind the wheels that are still on the ground. For example, use heavy wooden blocks or large stones.
- 4 Place the jack under one of the vehicle's lifting points, with the crank handle pointing straight out from the side of the vehicle.

The locations of the outer lifting points are marked with triangular arrows along the lower edge of the side of the vehicle. There are special grooves for the jack behind these markings.

- 5 Make sure that the jack is stably positioned on level, solid ground and that the surface is not slippery.
- 6 Raise the jack until it is touching the vehicle's lifting point. Make sure that the edge of the lifting point fits in the notch on the top of the jack.

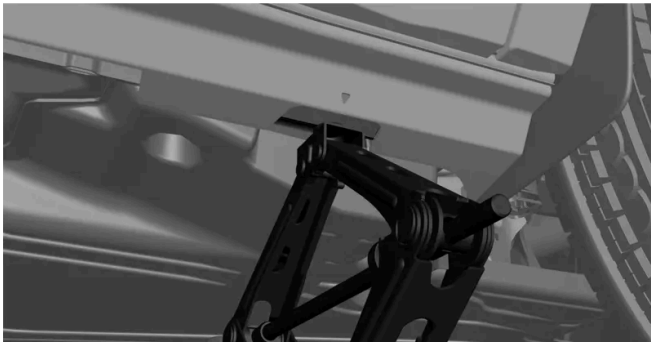

- 7 Make sure that the jack is completely level and perpendicular to the side of the vehicle.
  - The vehicle is now ready to be lifted.
- 8 Only raise the vehicle as high as needed for the work you will carry out.

Lower the vehicle using the jack immediately after the work has been performed.

When the jack\* is not being used, it is recommended that it is stored in the vehicle, protected from moisture and dirt.

\* Option/accessory.



# 18. Specifications

---

## 18.1. Dimensions and weights

---

### 18.1.1. Towing capacity and tongue weight

Towing capacity and tongue weight are shown in the table.

Category		USA (lbs)	Canada (kg)
Max. trailer weights	Without brakes:	1650	750
	With brakes:	3500	1600
Max. tongue weight	–	350	160

 **Important**

- The maximum trailer weights listed are only applicable for altitudes up to 3280 ft (1,000 m) above sea level. With increasing altitude the engine power and therefore the car's climbing ability are impaired because of the reduced air density, so the maximum trailer weight has to be reduced accordingly. The weight of the car and trailer must be reduced by 10% for every further 3280 ft (1,000 m) (or part thereof).

### 18.1.2. Dimensions

---

The vehicle's length, height, etc. are shown in the table.

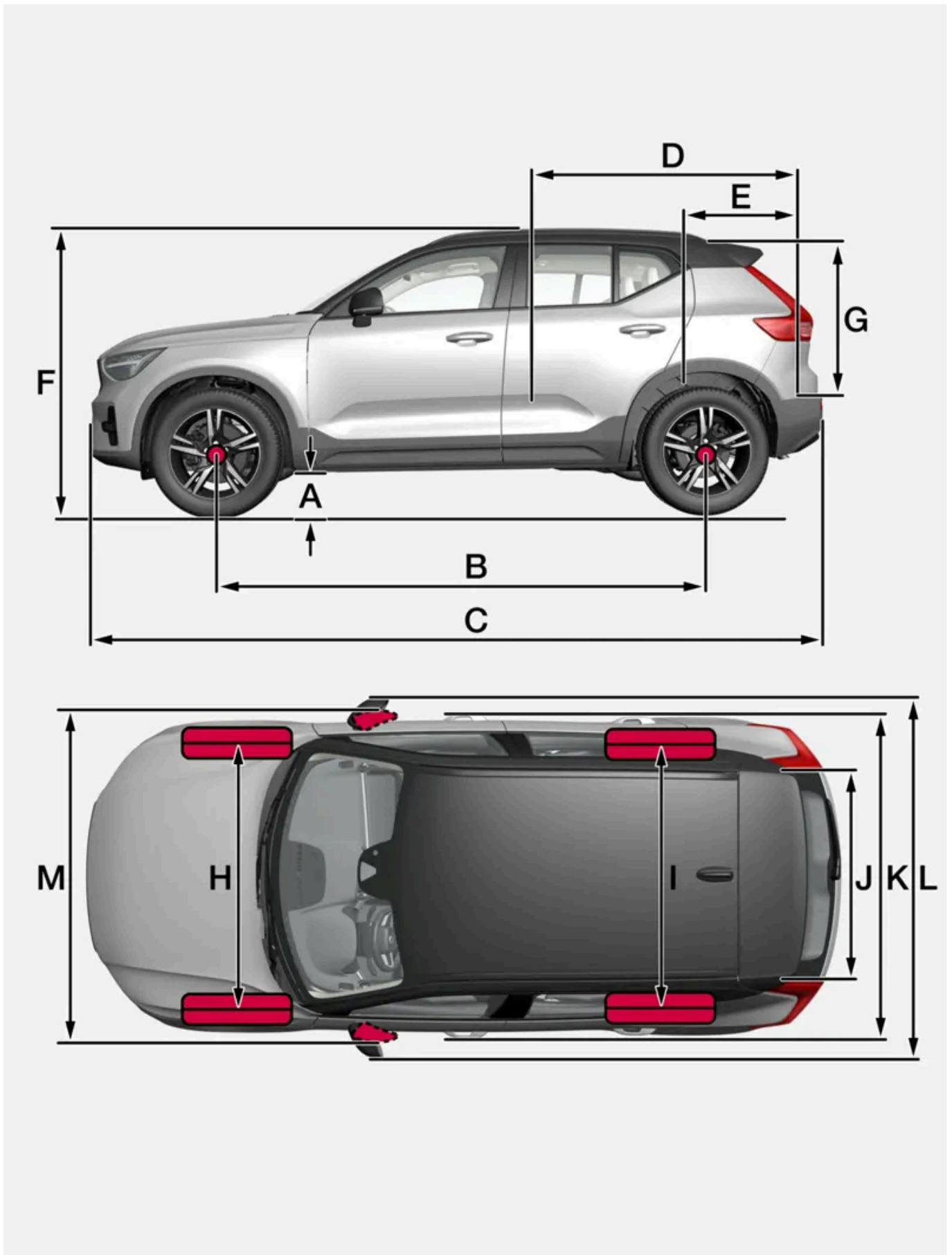

Dimensions		mm	inches
A	Ground clearance <sup>[1]</sup>	205	8.1
B	Wheelbase	2702	106.4
C	Length	4440	174.8
D	Load length, floor, folded backrest	1670	65.7
E	Load length, floor	887	34.9
F	Height <sup>[2]</sup>	1652	65.0
G	Load height	733	28.9
H	Wheel track, front	1601	63.0
I	Wheel track, rear	1626	64.0
J	Load width, floor	1059	41.7
K	Width	1873 (1863 <sup>[3]</sup> )	73.7 (73.3 <sup>[3]</sup> )
L	Width incl. folded-out rearview mirrors	2034	80.1
M	Width incl. folded rearview mirrors	1910	75.2

<sup>[1]</sup> For curb weight plus 1 person. (Varies slightly depending on tire dimensions, chassis variant, etc.).

<sup>[2]</sup> Including roof antenna, for curb weight plus 1 person.

<sup>[3]</sup> Chassis width.

## 18.1.3. Weights

The following table lists important weight data for your vehicle.

Category	Engine	USA (lbs)	Canada (kg)
Gross vehicle weight	B4 AWD	–	2280
	B4	4915	–
	B5 AWD	5025	2280
Capacity weight	–	925	420
Permissible axle weights, front	B4 AWD	–	1200
	B4	2620	–
	B5 AWD	2645	1200
Permissible axle weights, rear	B4 AWD	–	1130
	B4	2400	–
	B5 AWD	2490	1130
Curb weight	–	3700–3940	1730–1790
Max. roof load	–	165	75

**!** Important

- When loading the vehicle, the maximum gross vehicle weight and permissible axle weights may not be exceeded.

## 18.2. Engine specifications

### 18.2.1. Engine specifications

Engine specifications (output, etc.) for each engine variant are shown in the table below. The specifications for Special Edition vehicles may vary.

**i** Note

Not all engines are available on all markets.

Engine	Engine code <sup>[1]</sup>	Output (kW/rps)	Output (hp/rpm)	Torque (Nm/rps)	Torque (ft. lbs./rpm)	Number of cylinders
B4 / B4 AWD	B420T6	145/80–90	194/4800–5400	300/25–70	221/1500–4200	4
B5 AWD	B420T2	184/90–95	247/5400–5700	350/30-80	258/1800-4800	4

<sup>[1]</sup> The engine code, component and manufacturer serial numbers can be found on the engine.

### 18.2.2. Engine oil specifications

Engine oil of type VCC RBS0-2AE 0W-20 must be used<sup>[1]</sup>. Lower oil grades may not offer the same fuel economy, engine performance or engine protection.

Volvo recommends:



#### General

See the Service and warranty booklet for information about oil change intervals.

The content of this manual represents the status of the user manual at the time of printing and may not be completely valid in future instances. For more information refer to the first page for the complete disclaimer note.

**Note**

This vehicle is delivered from the factory with synthetic oil.

**Do not use oil additives.**

## Oil viscosity

The wrong oil viscosity can shorten engine service life during normal use. VCC RBS0-2AE 0W-20 provides good fuel economy and engine protection. See the viscosity chart.

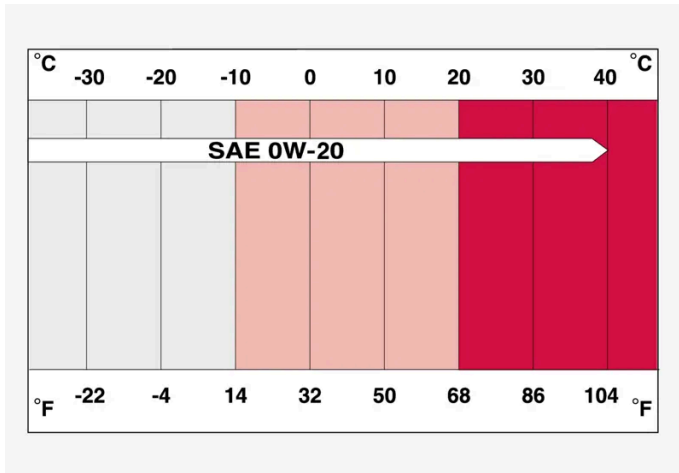

Viscosity chart

## Oil volume

Engine oil volumes (including oil filter) are shown in the table.

Liter (approx)	6.1
US qts (approx)	6.4

<sup>[1]</sup> 0W-30 or 5W-30 ACEA A5/B5 engine oil can also be used if VCC RBS0 2AE 0W-20 oil is not available.

## 18.3. Specifications for fluids and lubricants

### 18.3.1. Refilling washer fluid

Washer fluid is used to keep the headlights, windshield and rear window clean. Washer fluid containing anti-freeze should be used in very cold weather (below-freezing temperatures).

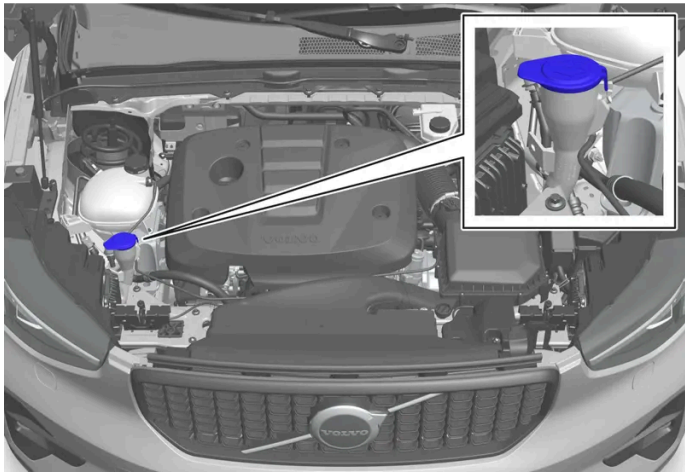

**Note**

When there is approximately 1 liter (1 qt) of washer fluid remaining, the message **Refill washer fluid, level low** and the  symbol will be displayed in the instrument panel.

When the message **Refill washer fluid, level low** along with the symbol  is shown in the instrument panel, it is time to refill washer fluid.

- 1 Open the hood by first using the handle in the passenger compartment and then the handle under the front edge of the hood.
- 2 Open the cover on the washer fluid reservoir.  
Fill washer fluid into the reservoir with the blue cover. The reservoir is used for the windshield washer, tailgate window washer and headlight washer\*.
- 3 Pour in washer fluid until it is full.
- 4 Close the cover on the washer fluid reservoir and then close the hood.

**Recommended grade:** Washer fluid recommended by Volvo, with frost protection during cold weather and temperatures below the freezing point.

**Important**

Use Volvo's original washer fluid or an equivalent fluid with the recommended pH value between 6 and 8, diluted as recommended, e.g. in a 1:1 solution with pH-neutral water.

 **Important**

Use washer fluid with anti-freeze when temperatures are below the freezing point to help keep the pump, reservoir and hoses from freezing.

**Volume:**

- Vehicles **with** headlight washing: 5.5 liters (5.8 qts).
- Vehicles **without** headlight washing: 3.5 liters (3.7 qts).

\* Option/accessory.

## 18.3.2. Air conditioning specifications

The climate system in the vehicle uses a freon-free R1234yf refrigerant. For information regarding the refrigerant, refer to the decal located on the underside of the hood.





Refrigerant and compressor oil are used in the air conditioning system. Information about the refrigerant decals, including amounts, is shown below. The table shows the prescribed grade and volume of the compressor oil.

### A/C Decal

Decal for R1234yf



Explanation of symbols for R1234yf

Symbol	Explanation
	Caution
	Mobile air condition system (MAC)
	Lubricant
	Only a trained and certified technician can perform service on the mobile air conditioning system (MAC)
	Flammable refrigerant

## Refrigerant

The refrigerant amount (charge level) is printed on a decal on the underside of the hood.

### Vehicles with R1234yf refrigerant

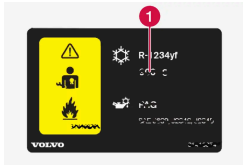

1 Refrigerant amount.

#### Warning

The air conditioning system contains the refrigerant R1234yf under pressure. In accordance with SAE J2845 (Technician Training for Safe Service and Containment of Refrigerants Used in Mobile A/C System), service and repairs to the refrigerant system may only be performed by trained and certified technicians in order to ensure the safety of the system.

## Compressor oil

Volume	Prescribed grade
130 ml (4.40 fl. oz.)	PAG SP-A2

## Evaporator

#### Important

The A/C system evaporator must never be repaired or replaced with a previously used evaporator. The new evaporator must be certified and labeled in accordance with SAE J2842.

## 18.3.3. Brake fluid specifications

The medium in the hydraulic brake system is called brake fluid and is used to transfer pressure from e.g. a brake pedal via a master brake cylinder, which in turn actuates the brake calipers.

**Recommended grade:** Volvo Original or similar fluid that meets a combination of Dot 4, 5.1 and ISO 4925 class 6.

#### Note

Changing or filling brake fluid should be entrusted to an authorized Volvo workshop.



## 18.3.4. Transmission fluid specifications

Under normal driving conditions, the transmission fluid will not need to be changed during the transmission's service life. However, it may need to be changed if the vehicle is driven frequently in adverse driving conditions.

### Automatic transmission

Prescribed transmission fluid:	AW-2
--------------------------------	------

**Note**

Check with your Volvo retailer if you are unsure which variant your vehicle is equipped with.

## 18.3.5. Fuel tank volume

The fuel tank's refillable volume is shown in the table below.

	All engines
Liter (approx)	54
US gallons (approx)	14.2

## 18.3.6. Engine oil specifications

Engine oil of type VCC RBS0-2AE 0W-20 must be used<sup>[1]</sup>. Lower oil grades may not offer the same fuel economy, engine performance or engine protection.

Volvo recommends:



### General

See the Service and warranty booklet for information about oil change intervals.

**Note**

This vehicle is delivered from the factory with synthetic oil.

**Do not use oil additives.**

## Oil viscosity

The wrong oil viscosity can shorten engine service life during normal use. VCC RBS0-2AE 0W-20 provides good fuel economy and engine protection. See the viscosity chart.

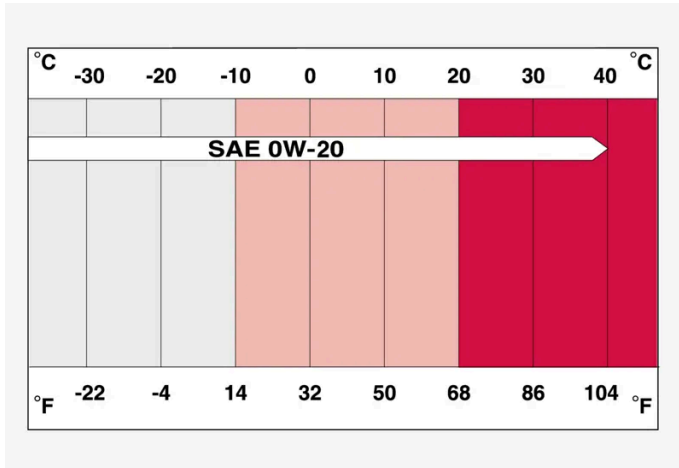

Viscosity chart

## Oil volume

Engine oil volumes (including oil filter) are shown in the table.

Liter (approx)	6.1
US qts (approx)	6.4

[1] 0W-30 or 5W-30 ACEA A5/B5 engine oil can also be used if VCC RBS0 2AE 0W-20 oil is not available.

## 18.4. Specifications for wheels and tires

### 18.4.1. Approved tire pressure

The following tire pressures are recommended by Volvo for your vehicle. Refer to the tire inflation placard for information specific to the tires installed on your vehicle at the factory.

Tire dimensions	Cold tire pressure for up to five persons	
	Front psi (kPa)	Rear psi (kPa)
235/60 R17 235/55 R18 235/50 R19 245/45 R20	33 (230)	33 (230)
245/40 R21	35 (240)	35 (240)
Temporary spare tire T125/70 R18 T125/80 R18	60 (420)	60 (420)

## 18.5. Bulb specifications

Specifications for replaceable light bulbs.

If you are experiencing problems with any lights other than light bulbs, contact a workshop <sup>[1]</sup>. If there is a problem with an LED <sup>[2]</sup> light, the entire lamp unit will normally need to be replaced.

Function	W <sup>[3]</sup>	Type
Rear turn signals	21	PY21W
Brake lights	21	H21W LL
Rear fog light	21	H21W LL

<sup>[1]</sup> An authorized Volvo workshop is recommended.

<sup>[2]</sup> LED (Light Emitting Diode)

<sup>[3]</sup> Watt

## 18.6. Type designations

The decals in the vehicle contain information such as chassis number, type designation, color code, etc.

## Location of decals

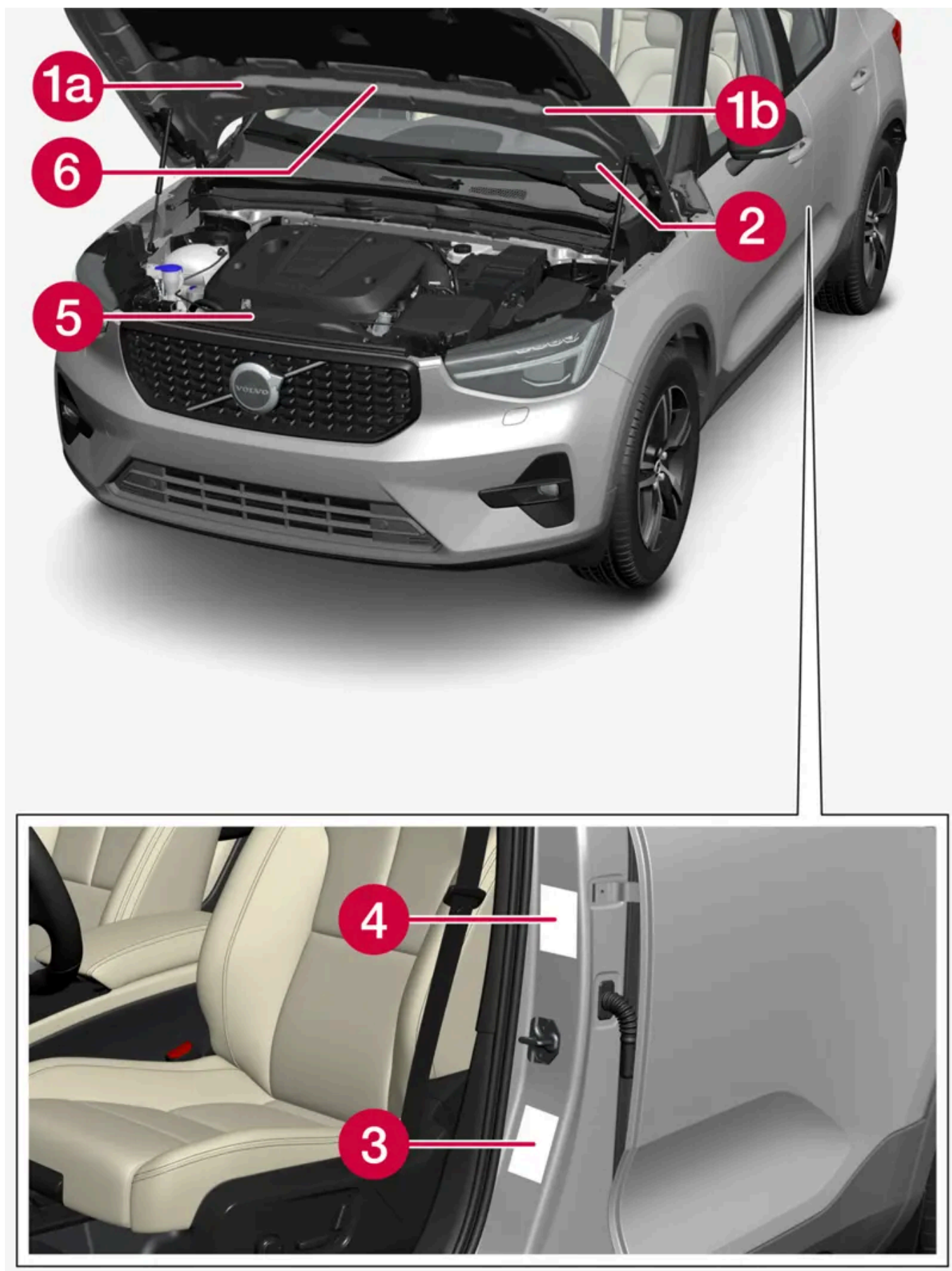

The illustration is generic - details may vary according to market and model.



**1a Vehicle Emission Control Information. US models.** Your Volvo is designed to meet all applicable emission standards, as evidenced by the certification label on the underside of the hood. For further information regarding these regulations, please consult your Volvo retailer.



**1b Vehicle Emission Control Information. Canadian models.** Your Volvo is designed to meet all applicable emission standards, as evidenced by the certification label on the underside of the hood. For further information regarding these regulations, please consult your Volvo retailer.



**2 Vehicle Identification Number (VIN).** The VIN plate is located on the top left surface of the dashboard. The Vehicle Identification Number (VIN) should always be quoted in all correspondence concerning your vehicle with the retailer and when ordering parts.



**3 Tire inflation pressures.** This label indicates the correct inflation pressures for the tires that were on the vehicle when it left the factory.



**4 Federal Motor Vehicle Safety Standards (FMVSS) specifications (USA) and Ministry of Transport (CMVSS) standards (Canada).** Your Volvo is designed to meet all applicable safety standards, as evidenced by the certification label on the driver's side B-pillar (the structural member at the side of the vehicle, at the rear of the driver's door opening). This label also includes codes for paint color, etc. For further information regarding these regulations, please consult your Volvo retailer. U.S. models have the upper decal; Canadian models have the lower one.



**5 Engine oil.** This label contains the recommended engine oil specifications.



**6 Decal A/C.** Refrigerant R1234yf. The decal is affixed to the underside of the hood.

**i Note**

The decals shown in the Owner's Manual do not claim to be exact reproductions of those found in the vehicle. The purpose is to show approximately how they look and about where they are located on the vehicle. The information that applies for your vehicle in particular is found on the decal on the vehicle.