

EX30 Cross Country 2026 (25w17) User Manual

Version 2026-05-27

Disclaimer

Due to the dynamic nature of our software-based product, the content of this PDF represents the most up-to-date version of the user manual as of the time of printing. As we continuously update and improve our product, certain content may not reflect the most up-to-date information in a future instance. Therefore, we strongly recommend utilising the digital user manual app in your car's centre display for the most accurate and up-to-date information. You can also access information in the Volvo Cars mobile app.

Please note that if you choose to print the manual, we cannot guarantee the validity of the information in future instances, as updates may have occurred since the time of printing. To ensure the highest level of safety and optimal product usage, we strongly advise relying on the digital user manual, which can be easily accessed through your car's centre display.

This printable version is generic and does not correspond to your car. If there are discrepancies between this printable manual and the manual you see in your car's centre display, the latter takes precedence.

Contents

1. [Consumer information](#)
 - 1.1 [About the user manual](#)
 - 1.1.1 [Reading the user manual](#)
 - 1.2 [Customer support and contact information](#)
 - 1.3 [Driver responsibility](#)
 - 1.4 [Modifications, repairs and accessory installations](#)
 - 1.5 [Finding the vehicle identification number](#)
 - 1.6 [Approval of terms and conditions and data collection](#)
 - 1.7 [Handling of recorded and collected data](#)
 - 1.8 [About connected services and fair use policy](#)
 - 1.9 [Changing ownership of the car](#)
 - 1.10 [Resetting user data](#)
 - 1.11 [Recommendations when changing regions](#)
2. [User accounts, profiles and services](#)
 - 2.1 [Setting up your car for the first time](#)
 - 2.2 [Volvo ID](#)
 - 2.2.1 [Creating a Volvo ID](#)
 - 2.3 [Volvo Cars app](#)
 - 2.4 [Getting started with Google services](#)
 - 2.5 [Customisation and settings](#)
 - 2.6 [Car user profiles](#)
 - 2.6.1 [Switching profiles](#)
 - 2.6.2 [Adding a profile](#)
 - 2.6.3 [Removing a profile](#)
 - 2.6.4 [Assigning a key to profile](#)
 - 2.6.5 [Managing keys assigned to profiles](#)
 - 2.6.6 [Restricting access to a profile](#)
 - 2.6.7 [Adding an account to a profile](#)
 - 2.7 [Volvo Assistance](#)
 - 2.7.1 [Calling Volvo Assistance for roadside assistance](#)
 - 2.8 [Emergency assistance](#)

The content of this manual represents the status of the user manual at the time of printing and may not be completely valid in future instances. For more information, refer to the first page for the complete disclaimer note.

- 2.8.1 Calling emergency services with SOS button
- 3. Display, software and phone
 - 3.1 Display
 - 3.1.1 Main area of the display
 - 3.1.1.1 Display views
 - 3.1.1.2 Status symbols in the display
 - 3.1.1.3 Keyboard
 - 3.1.1.3.1 Changing keyboard language
 - 3.1.1.3.2 Adding and removing keyboard languages
 - 3.1.2 Driver information area of the display
 - 3.1.2.1 Warning and indicator symbols
 - 3.1.2.2 Battery meter
 - 3.1.3 System settings
 - 3.1.3.1 Changing date and time
 - 3.1.3.2 Changing system language
 - 3.1.3.3 Changing system units
 - 3.1.4 Restarting the display
 - 3.2 Phone
 - 3.2.1 Connecting your phone to the car
 - 3.2.2 Using your phone in the car
 - 3.2.3 Switching between paired phones
 - 3.2.4 Apple CarPlay
 - 3.2.4.1 Connecting your iPhone to Apple CarPlay
 - 3.2.5 Android Auto™
 - 3.3 Sound and media
 - 3.3.1 Radio
 - 3.3.1.1 Adding radio favourites
 - 3.3.1.2 Linking DAB and FM stations
 - 3.3.2 Sound settings
 - 3.3.3 Media players
 - 3.4 In-car apps
 - 3.4.1 Downloading apps
 - 3.4.2 Uninstalling apps
 - 3.5 Connectivity and software
 - 3.5.1 Internet connection
 - 3.5.1.1 Connecting to the internet via Wi-Fi
 - 3.5.2 Over-the-air updates
 - 3.6 Voice control
 - 3.6.1 Using voice control
- 4. Interior comfort and climate
 - 4.1 Interior
 - 4.1.1 Using the wireless charger
 - 4.1.2 USB ports
 - 4.1.3 12 V socket
 - 4.1.4 Sun visors
 - 4.2 Comfort
 - 4.2.1 Activating refresh mode
 - 4.2.2 Activating relax mode
 - 4.3 Climate
 - 4.3.1 Climate controls
 - 4.3.1.1 Activating seat heating
 - 4.3.1.2 Activating the steering wheel heating

- 4.3.2 Climate settings
- 4.3.3 Temperature and air conditioning
 - 4.3.3.1 Activating air conditioning
 - 4.3.3.2 Setting temperature
 - 4.3.3.3 Synchronising temperature
 - 4.3.3.4 Activating eco climate
- 4.3.4 Air distribution and climate modes
 - 4.3.4.1 Adjusting air vents
 - 4.3.4.2 Activating auto climate mode
 - 4.3.4.3 Activating manual climate mode
- 4.3.5 Ice, condensation and defrosters
 - 4.3.5.1 Activating max defroster
 - 4.3.5.2 Activating rear windscreen and wing mirror heating
- 4.3.6 Interior climate when parked
 - 4.3.6.1 Setting the preconditioning timer
 - 4.3.6.2 Activating parking comfort
- 4.3.7 Air quality
 - 4.3.7.1 Air quality indication
 - 4.3.7.2 Activating air recirculation
- 4.3.8 Climate system
 - 4.3.8.1 Climate zones
 - 4.3.8.2 Perceived and actual temperature
 - 4.3.8.3 Climate sensors
 - 4.3.8.4 Heaters
- 4.4 Windows and glass panes
 - 4.4.1 Operating the windows
 - 4.4.1.1 Locking the rear windows
 - 4.4.2 Pinch protection
 - 4.4.3 Resetting windows
- 4.5 Seats
 - 4.5.1 Front seats
 - 4.5.1.1 Adjusting front seats
 - 4.5.2 Rear seats
 - 4.5.2.1 Adjusting rear seat headrests
 - 4.5.2.2 Removing rear seat headrests
 - 4.5.2.3 Folding down the rear seats
- 4.6 Interior lighting
 - 4.6.1 Adjusting the reading lights
 - 4.6.2 Adjusting interior lights
 - 4.6.3 Adjusting ambience lighting
- 5. Safety
 - 5.1 Collision response
 - 5.2 Occupant detection
 - 5.3 Proper seating
 - 5.4 Seatbelts
 - 5.4.1 Fastening and adjusting seatbelt
 - 5.4.2 Seatbelt reminder
 - 5.5 Airbags
 - 5.5.1 Airbag deployment
 - 5.5.2 Front airbags
 - 5.5.2.1 Disabling and enabling front passenger airbag
 - 5.5.3 Side airbags

- 5.5.4 Inflatable curtains
- 5.5.5 Airbag maintenance and servicing
- 5.5.6 Airbag labels
- 5.6 Child safety
 - 5.6.1 Child restraints
 - 5.6.1.1 Installing child restraints
 - 5.6.1.1.1 Installing child restraints on the outer rear seats
 - 5.6.1.1.2 Installing child restraints on the centre rear seat
 - 5.6.1.1.3 Installing child restraints on the front passenger seat
 - 5.6.1.2 Child restraint anchorage points
 - 5.6.1.2.1 ISOFIX anchorage points
 - 5.6.1.2.2 Top tether anchorage points
 - 5.6.1.2.3 Lower tether anchorage points
 - 5.6.1.3 Recommended child restraints
 - 5.6.1.4 Overview table of suitable locations for child restraints
- 6. Entry and security
 - 6.1 Keys
 - 6.1.1 Key tag
 - 6.1.1.1 Replacing the key tag battery
 - 6.1.2 Key card
 - 6.1.3 Digital key
 - 6.1.3.1 Creating a digital key
 - 6.1.3.2 Deleting a digital key
 - 6.1.4 Key reading locations
 - 6.2 Opening and closing
 - 6.2.1 Opening the bonnet
 - 6.2.2 Closing the bonnet
 - 6.2.3 Boot access
 - 6.2.3.1 Adjusting boot opening height
 - 6.3 Locking and unlocking
 - 6.3.1 Activating child lock
 - 6.3.2 Settings for locking and unlocking
 - 6.3.2.1 Adjusting locking and unlocking settings
 - 6.3.3 Unresponsive lock
 - 6.4 Anti-theft
 - 6.4.1 Alarm
 - 6.4.1.1 Reducing the alarm sensitivity
- 7. Charging your car
 - 7.1 Charging types
 - 7.1.1 Charging cables
 - 7.2 Charging view and settings
 - 7.2.1 Setting a target battery level for charging
 - 7.2.2 Setting the amperage limit for charging
 - 7.2.3 Adding and managing charging schedules
 - 7.3 Start and stop charging
 - 7.3.1 Starting AC charging
 - 7.3.2 Starting DC charging
 - 7.3.3 Stopping AC charging
 - 7.3.4 Stopping DC charging
 - 7.3.5 Releasing the charging cable
 - 7.3.5.1 Manually releasing the charging cable
 - 7.4 Charging time and statuses

- 7.4.1 Charging times
- 7.4.2 Charging status
 - 7.4.2.1 Charging status in the charging port
 - 7.4.2.2 Charging status in the display
- 8. Driving
 - 8.1 A typical driving cycle
 - 8.2 Trips app
 - 8.3 Starting the car
 - 8.3.1 Start-up checks
 - 8.3.2 Alcohol lock
 - 8.4 Turning the car off
 - 8.5 Driving characteristics
 - 8.5.1 Drive modes
 - 8.5.1.1 Selecting a drive mode
 - 8.5.2 One pedal drive
 - 8.5.2.1 Adjusting One pedal drive
 - 8.5.3 Enabling automatic creeping
 - 8.5.4 Activating hill descent
 - 8.5.5 Stability control
 - 8.5.5.1 Disabling electronic stability control
 - 8.5.6 Suspension
 - 8.6 Range
 - 8.6.1 Trip information
 - 8.6.1.1 Resetting the trip meter
 - 8.7 Steering
 - 8.7.1 Steering wheel
 - 8.7.1.1 Steering wheel controls
 - 8.7.1.1.1 Assigning an action to the customisable button
 - 8.7.1.2 Adjusting the steering wheel position
 - 8.7.2 Adjusting steering feel
 - 8.8 Brakes
 - 8.8.1 Foot brake
 - 8.8.2 Parking brake
 - 8.8.2.1 Engaging the parking brake
 - 8.8.3 Auto hold
 - 8.8.4 Post-impact braking
 - 8.9 Selecting gear
- 9. Visibility, mirrors and exterior lights
 - 9.1 Exterior lights
 - 9.1.1 Driving lights
 - 9.1.1.1 Selecting a primary lighting mode
 - 9.1.1.2 High beam
 - 9.1.1.2.1 Operating the high beam
 - 9.1.1.3 Operating the direction indicators
 - 9.1.1.4 Activating the rear fog light
 - 9.1.1.5 Adjusting headlights height
 - 9.1.1.6 Hazard warning lights
 - 9.1.1.6.1 Activating the hazard warning lights
 - 9.1.2 Exterior convenience lights
 - 9.1.2.1 Enabling the guidance light
 - 9.1.2.2 Enabling the welcome lights
 - 9.2 Mirrors

- 9.2.1 Adjusting wing mirrors
- 9.3 Wipers and washers
 - 9.3.1 Controlling front wipers
 - 9.3.2 Controlling rear wiper
 - 9.3.3 Activating washers
- 10. Driver support and navigation
 - 10.1 Navigation
 - 10.1.1 Finding and selecting a navigation destination
 - 10.2 Detection of surroundings and traffic
 - 10.2.1 Locations of cameras, sensors and radars
 - 10.2.2 Camera detection and limitations
 - 10.2.3 Radar detection and limitations
 - 10.2.4 Parking sensor detection and limitations
 - 10.3 Safety interventions and warnings
 - 10.3.1 Collision warnings and mitigation
 - 10.3.1.1 Adjusting the sensitivity for forward collision warnings
 - 10.3.1.2 Enabling and disabling rear collision warnings
 - 10.3.2 Interventions and warnings when reversing
 - 10.3.2.1 Alerts about traffic crossing behind the car
 - 10.3.2.1.1 Disabling rear cross traffic alert
 - 10.3.2.2 Disabling automatic braking when reversing
 - 10.3.3 Lane keeping aid
 - 10.3.3.1 Disabling lane keeping aid
 - 10.3.3.2 Disabling lane departure warnings
 - 10.3.4 Blind spot information
 - 10.3.4.1 Enabling blind spot alerts
 - 10.3.5 Door opening alerts
 - 10.3.5.1 Enabling door opening alerts
 - 10.3.6 Driver alert
 - 10.3.6.1 Disabling driver alerts
 - 10.4 Assisted driving
 - 10.4.1 Road signs and speeding response
 - 10.4.1.1 Speed limiter
 - 10.4.1.1.1 Activating the speed limiter
 - 10.4.1.1.2 Deactivating the speed limiter
 - 10.4.1.1.3 Adjusting the speed limiter value
 - 10.4.1.1.4 Enabling the speed limiter in settings
 - 10.4.1.2 Speed limit warnings
 - 10.4.1.2.1 Disabling speed limit warnings
 - 10.4.1.3 Disabling sound alerts for speed limit changes
 - 10.4.1.4 Road sign information
 - 10.4.2 Pilot Assist
 - 10.4.2.1 Pilot Assist communication and status
 - 10.4.2.2 Activating Pilot Assist
 - 10.4.2.3 Deactivating Pilot Assist
 - 10.4.2.4 Adjusting the target speed for Pilot Assist
 - 10.4.2.5 Enabling and disabling steering assistance when driving
 - 10.4.2.6 Changing lanes with Pilot Assist
 - 10.4.2.7 Enabling Pilot Assist in settings
 - 10.4.2.8 Adjusting Pilot Assist settings
 - 10.4.2.9 Pilot Assist conditions and limitations
 - 10.5 Assisted parking

- 10.5.1 Parking view
- 10.5.2 Park Pilot Assist
 - 10.5.2.1 Parking using Park Pilot Assist
 - 10.5.2.2 Leaving a parking space using Park Pilot Assist
- 11. Scenarios and driving recommendations
 - 11.1 Cold conditions
 - 11.1.1 Winter driving recommendations
 - 11.2 Wading recommendations
 - 11.3 Preparations for a long trip
 - 11.4 Long-term parking
- 12. Storage, stowing and towing
 - 12.1 Passenger compartment storage
 - 12.1.1 Glove box
 - 12.1.1.1 Locking the glove box
 - 12.2 Boot space and storage
 - 12.2.1 Parcel shelf
 - 12.2.1.1 Removing the parcel shelf
 - 12.2.2 Removing the cargo hatch
 - 12.2.3 Stowing cargo in the boot
 - 12.2.3.1 Accessing the cargo hold
 - 12.3 Storage under the bonnet
 - 12.4 Towing a trailer
 - 12.5 Recommendations for loading
- 13. Care and maintenance
 - 13.1 Car status
 - 13.1.1 Battery status and health
 - 13.2 Exterior cleaning and care
 - 13.2.1 Washing the exterior by hand
 - 13.2.2 Washing the car in an automatic car wash
 - 13.2.2.1 Activating car wash mode
 - 13.2.3 Polishing and waxing
 - 13.2.4 Touching up paintwork damage
 - 13.2.4.1 Finding the paint colour code
 - 13.2.5 Windscreen damage
 - 13.2.6 Refilling washer fluid
 - 13.2.7 Cleaning wipers
 - 13.2.8 Replacing front wiper blades
 - 13.2.9 Replacing the rear wiper blade
 - 13.2.10 Activating the wiper service position
 - 13.2.11 Corrosion protection
 - 13.3 Interior cleaning and care
 - 13.3.1 Cleaning fabrics and textiles
 - 13.3.2 Cleaning glass and glossy surfaces
 - 13.3.2.1 Activating display cleaning mode
 - 13.3.3 Cleaning interior plastic and metal components
 - 13.3.4 Cleaning mats
 - 13.4 Wheels and tyres
 - 13.4.1 Wheel and tyre recommendations
 - 13.4.1.1 Tyres and wheel storage
 - 13.4.1.2 Tyre economy
 - 13.4.2 Designations on tyre sidewall

- 13.4.2.1 Tyre tread wear indicators
 - 13.4.3 Changing wheels
 - 13.4.3.1 Spare wheel
 - 13.4.3.2 Winter tyres
 - 13.4.3.3 Using snow chains
 - 13.4.4 Punctures
 - 13.4.4.1 Temporary puncture repair
 - 13.4.4.1.1 Using the temporary puncture repair kit
 - 13.4.4.1.2 Inflating tyre with the puncture repair compressor
 - 13.4.5 Tyre pressure
 - 13.4.5.1 Tyre pressure monitoring
 - 13.4.5.1.1 Limitations of tyre pressure monitoring
 - 13.4.5.2 Adjusting tyre pressure
 - 13.5 Car electrics and batteries
 - 13.5.1 Traction battery
 - 13.5.1.1 Managing battery health and performance
 - 13.5.1.2 Powertrain cooling system
 - 13.5.2 12 V battery
 - 13.5.2.1 Battery labels
 - 13.5.3 Battery recycling
 - 13.5.4 Fuses
 - 13.6 Tools and equipment
 - 13.6.1 Using a warning triangle
 - 13.6.2 Attaching the towing eye
 - 13.7 Raising the car
 - 13.8 Servicing and repairs
 - 13.8.1 Booking servicing or repairs
 - 13.8.2 On-board diagnostic port
14. Immobilised car and recovery
- 14.1 Damaged car
 - 14.2 Malfunction
 - 14.3 Powerless or unresponsive car
 - 14.4 Recovery
 - 14.5 Safety mode
 - 14.6 Having your car towed
 - 14.6.1 Activating tow mode
15. Specifications
- 15.1 General car characteristics
 - 15.1.1 Car dimensions
 - 15.1.2 Weights
 - 15.1.3 Towing specifications and capabilities
 - 15.1.4 Towbar specifications
 - 15.1.5 Type designations
 - 15.2 Powertrain specifications
 - 15.2.1 Electric motor specifications
 - 15.2.2 Performance
 - 15.2.3 The car's certified values for range and electricity consumption
 - 15.2.4 Charging cable specifications
 - 15.2.5 Charging port labels and identifiers
 - 15.3 Wheel and tyre specifications
 - 15.3.1 Approved tyre pressures
 - 15.3.2 Approved wheel and tyre sizes

- 15.3.3 Minimum permitted load index and speed rating for tyres
- 15.4 Fluid specifications
 - 15.4.1 Brake fluid specifications
 - 15.4.2 Climate system specifications
- 15.5 Certificates and type approvals
 - 15.5.1 Detailed child restraint information
 - 15.5.2 Radar type approvals
 - 15.5.3 Type approval for TPMS radio frequency
 - 15.5.4 Type approvals for Wireless charger and NFC
 - 15.5.5 Key system certification
 - 15.5.6 Candidate List Substance Information (CL) in accordance with the REACH Regulation, Article 33.1
- 15.6 Labels

1. Consumer information

There's a lot to learn about your Volvo. This section covers some essential topics, such as where you can find support if you need it and information about certain consumer rights and responsibilities.



Tip

Where to start?

Technically, the whole manual is recommended reading for anyone new to the car. However, you can start by reading the information about how this user manual works so you know how to find what you need.

Driver responsibility

The information about driver responsibility is also a good place to start reading. It covers some general principles for safe use of the car and its features.

1.1. About the user manual

Learn about how the user manual applies to your car's use, where you can find it and how to navigate its content.

An important part of your car

Your car is a highly advanced product. However, as a well-designed product, advanced doesn't have to mean it's difficult to use. The aim here is to give you an intuitive experience, with natural interactions that work for both driver and passenger alike. This manual is designed to be a part of the car, giving you information for safe and effective use. It's your resource on the car's functions and features.



Tip

New user

If you are new to this car, take some time to explore the different areas in the manual. Knowing the car's capabilities and limitations is your responsibility and a necessity for safe and effective use.

Keep the manual up to date

Make sure that you keep the manual up to date by always having the latest version. Take a look any time a software update introduces changes or new features.

A guide to your car's intended use

The user manual establishes the car's intended use, as defined by Volvo. Whenever you are directed to the manual, consider it an instruction to make sure that you are using the car as intended. This is recommended, as both the descriptive and prescriptive parts of the user manual provide important knowledge that contributes to safe and effective use.

The content of this manual represents the status of the user manual at the time of printing and may not be completely valid in future instances. For more information, refer to the first page for the complete disclaimer note.

i Note

Intended use

If you use the car in a manner which Volvo has not intended, it can negatively affect how it works. This includes shortening the car's service life and limiting your ability to use the car safely and effectively. It may also affect the validity of the vehicle warranty.

Volvo is not the only authority that defines proper use of the car. It is your responsibility to use the car in accordance with local laws and restrictions.

Accuracy in representing your car

The primary goal is that this manual accurately describes how your car works. However, certain differences between produced cars are not reflected in the manual, such as the colours, materials and certain equipment.

i Note

Cars are equipped and adapted to meet specific market needs as well as local legislation and requirements. Certain regional variations in configuration may not be reflected in the user manual's content.

Where to find the user manual

Your car's user manual is available as an app in the car's display, via the mobile app for the car and at [volvocars.com/intl/support](https://www.volvocars.com/intl/support) [<https://www.volvocars.com/intl/support>].

i Note

Volvo's support site

The version of the user manual on Volvo's support site is for a fully-equipped car with all of the available options, functions and features. Therefore, it may differ from this user manual due to what's available in your car.^[1]

Printed supplements

The user manual is fully digital, but a selection of its content may be included with your car as a printed supplement. The inclusion of printed supplements depends on region and how your car is configured.

Applicability

 **Important**

- Maintain and handle the car according to Volvo's recommendations in the user manual. Volvo accepts no responsibility for damage or accidents if you disregard the instructions in this manual.
- It is recommended that you read all the user information before you drive for the first time.
- If you find information through other channels, such as the Volvo website, that differs from the information in your car, it is always the user information in the car's display that is valid.
- Volvo works continuously to improve the quality of the user information and make it more accessible and useful. This means that descriptions and illustrations may change. Volvo reserves the right to make changes without prior notice.
- The original version of this user manual is written in British English. Therefore, there may be certain differences between the descriptions in the manual and the actual car.
- The descriptions in this manual are based on general usage conditions. Remember that they can change depending on location, environment and driving behaviour.
- No illustrations or texts in this manual may be copied without permission from Volvo.

^[1] Availability may vary between regions and equipment levels.

1.1.1. Reading the user manual

Learn how this manual's content is organised so that you can find what you need when you need it.

Your car's user manual is designed to guide you, both when you're looking for a specific piece of information and when you're simply exploring to learn more about your car.

Structure

This user manual is a large network of informational pages. Each page has its own content and a list of links that take you to related pages. The links can take you to subsections of the one you're in or to other sections with a connection to what you're currently reading.

 **Tip**

Find the right level of information

Sometimes the answer to what you're looking for might not lie in the details. Moving up a level or two in the structure might provide the context and perspective you need, or just a better idea of where to look.

Search for information

You can use the search field for quicker access to what you are looking for.

All main areas

To get you started, the related information links on this page include all main sections in this manual.

Navigate through interactive images

Some of the manual's pages have images with interactive markers. You can tap these markers to reveal links to relevant parts of the manual. These interactive markers allow you to explore the manual in a more visual way.



Tip

Animated introductions

Some pages show a short animation as an introduction. This provides you with a few visual hints of what you can expect to find in that part of the manual.

Images and videos

Images in the user manual are sometimes schematic and intended to give an overview or an example. Images can differ from your car due to equipment level or market requirements.

Highlighted content

Throughout this manual, you can find content that is highlighted in various ways.



Warning

Content highlighted like this primarily informs of conditions or use with obvious potential to cause severe harm to health.



Important

Content highlighted like this primarily informs of conditions or use with a clear potential to cause material damage.



Note

Content highlighted like this primarily contains information that can help avoid incorrect use, or information that is easily missed or misunderstood.



Tip

Content highlighted like this primarily provides tips for use or where to find related content.

Equipment, accessories and features

Some equipment, accessories and features might be limited or only available for certain car configurations or markets. Even if the information is available to you, it does not guarantee that the specific equipment, accessory or feature described is available in your car.

 **Note**

There may be differences in terminology between the user manual and materials for marketing, sales and advertisements.

For more information on standard and optional equipment, contact a Volvo dealer.

1.2. Customer support and contact information

Should you have any questions regarding your car, you can find answers or solutions in a number of places. In addition to searching the user manual you are reading now, you can visit Volvo's website, Volvo's support site or contact Volvo Assistance.

Website and support site

Volvo's website [volvocars.com](https://www.volvocars.com) [<https://www.volvocars.com>] has several customer support resources.

The support section [volvocars.com/intl/support](https://www.volvocars.com/intl/support) [<https://www.volvocars.com/intl/support>] provides contact information, software news and answers to frequently asked questions. You can also find your closest Volvo dealer or contact Volvo via phone or chat.

Volvo Assistance

Volvo Assistance can offer help in the event of a breakdown or if your car unexpectedly becomes immobilised. This includes roadside assistance. Volvo Assistance is available 24 hours a day, 7 days a week.

Press the assist button  in the car's ceiling or use the mobile app for the car to contact Volvo Assistance.

1.3. Driver responsibility

As a driver, you are responsible for doing everything possible to ensure your own safety as well as that of your passengers and other road users.

Your knowledge, decisions and actions determine how safely you drive. Your car has features that, in certain situations, can compensate for mistakes and lapses in judgement. However, they do not change where the responsibility lies. They are a supplement to good driver practices, which you are responsible for as a driver.

You have likely studied and trained to ensure you have the necessary knowledge and abilities to be a safe driver. This section covers a few essentials you may recognise, such as:

- Driving and using driver support functions
- Knowing the car's capabilities and limitations
- Driver distraction
- Driver fatigue
- Laws and regulations

The content of this manual represents the status of the user manual at the time of printing and may not be completely valid in future instances. For more information, refer to the first page for the complete disclaimer note.

Driving

You are responsible for adapting your driving to the current conditions, even when using driver support functions. This includes adapting your distance to other vehicles and speed as well as being ready to react to traffic and road hazards. The car's safety interventions and warnings rely on accurate detection and identification of surrounding traffic and road conditions. The detection systems cannot handle all driving, traffic, weather and road conditions.

Note

Driver support

Driver support functions can assist you with certain driving tasks and improve driving awareness. When used correctly, they can improve safety and convenience, but they are not a replacement for safe driving practices. Drive the car with the same attention to safety as required by a car without these functions.

Knowing the car's capabilities and limitations

Before driving, all drivers are recommended to familiarise themselves with the car and any functions and features they might use. The driver has a responsibility to ensure they have sufficient knowledge of the car to use it safely.

If you are uncertain about any of the car's functions or have questions about its intended use, consult the manual. If you can't find the information you need, contact Volvo support.

Driver distraction

Distractions reduce your attentiveness and focus when driving. As a driver, you are always responsible for assessing whether a task is safe to perform. Your assessment should take the situation as a whole into account, as well as specific conditions and circumstances that can cause distraction. It might be safe to adjust the volume when you're driving on a straight empty road, but not in more demanding situations such as when overtaking.

Warning

Avoid distractions

Any task that prevents you from keeping your attention on the road and surrounding traffic should only be performed when the car is parked. The following are some examples of tasks you should not do while driving:

- Do not hold your phone while driving. Local laws often restrict or forbid phone use while driving.
- Do not manually change the navigation route while driving.
- Do not change detailed sound settings while driving.

Driver responsibility and safety features

Your car has several safety features designed to reduce the risk of an accident. They do not reduce the driver's responsibility to remain attentive, nor the need to operate the car as safely as possible.



Tip

Help from passengers

Tasks that risk distracting the driver can often be done by a passenger instead. However, certain actions are simply not available in the car when driving, such as reading this manual in the display. For these actions, you need to be parked.

Voice control

Voice commands can, in some situations, be less distracting than manually doing the same task.

Driver fatigue

The driver is always responsible for being well-rested. Your car has some functions with abilities to warn you if you show signs of fatigue. It's important to always stop and take a break at the slightest feeling of fatigue, regardless of whether a function has given you a warning.

Laws and regulations

The driver is always responsible for knowing and following local laws and regulations. If you drive to a region with other traffic laws, make sure that the car is equipped as required and read up on which traffic laws differ from what you're used to.

1.4. Modifications, repairs and accessory installations

Modifications^[1], repairs and installation of accessories or extra equipment require proper knowledge and quality of both work and parts. Otherwise, they risk impairing your car's functionality and safety. Contact a Volvo dealer before making any alterations to your car.

For any alterations^[2] to the car, Volvo strongly recommends that:

- you seek prior advice of a trained and qualified Volvo service technician.
- work is only carried out by trained and qualified Volvo service technicians.
- installed parts and accessories are approved by Volvo.^[3]
- parts and accessories are fitted according to their installation instructions.
- they comply with local laws and regulations.^[4]

Contact a Volvo dealer for more information.

 **Warning**

Systems can be negatively affected

Unapproved or incorrectly installed accessories can negatively affect your car's performance, communication and safety systems. Certain accessories only work with associated software that needs to be installed in the car.

Electrical installations

For additional electrical installations, it is essential that appropriate connection points are used to ensure the integrity of the car's electrical system. The car has a specific ground attachment point designated for aftermarket installations, which is separate from those reserved for critical components. Volvo recommends an authorised Volvo workshop for any electrical installations.

End-of-life handling

Some parts of the car are dangerous to handle. Special handling is required when servicing, or scrapping after the car has reached its end-of-life.

- Electrical components in the car^[5] may contain harmful substances and can deliver lethal electrical currents if handled incorrectly.
- Components such as airbag modules, seatbelt tensioners, adaptable steering columns and button cell batteries may contain perchlorate materials.

 **Note**

Non-approved changes and liability

Volvo does not accept any liability for damage, incurred cost, personal injury or fatality that is caused by changes to the car^[6] not approved by Volvo.

^[1] Modifications include changes to the car's software, including but not limited to tuning.

^[2] Meaning modifications, repairs and installation of accessories and extra equipment.

^[3] Accessories that are not approved by Volvo may not have been specifically tested for use with your car.

^[4] Applies to both the act of making the alteration and subsequent use of the altered car.

^[5] Such as batteries

^[6] Including but not limited to modification, repair and installation of accessories or extra equipment.

1.5. Finding the vehicle identification number

There are several ways to find your car's unique vehicle identification number.^[1] You might need your car's VIN if you contact Volvo about any questions or problems regarding your car.

Find the number in one of the following ways:

- In the display.

The content of this manual represents the status of the user manual at the time of printing and may not be completely valid in future instances. For more information, refer to the first page for the complete disclaimer note.

- On a label on the dashboard close to the windscreen's lower edge. It can typically be read from outside the car.
- In the car's registration documentation.
- By contacting a service technician who can retrieve it through the on-board diagnostics socket.

In the display

1. Press the car symbol  in the bottom bar and go to **Settings**.
2. Go to **System** → **About** → **VIN number**.

^[1] VIN

1.6. Approval of terms and conditions and data collection

You will see messages about different terms and conditions and data collection ^[1] in the display. Your agreement is necessary for certain apps and services to work properly.

The first time you use your car, a guide opens in the display to assist you in choosing various settings. In connection with the guide, you are prompted to give your agreement to different types of terms and conditions as well as data collection. You can do this later in privacy settings as well.

You may also need to give your consent, such as when you:

- Use an app or service for the first time
- Add a new profile
- Sign out from and delete a profile
- Change the ownership
- Reset the settings

Accept privacy settings

1. Press the car symbol  in the bottom bar and go to **Settings**.
2. Go to **Privacy**.



Tip

You can also find the privacy settings in profile settings.

3. Select the privacy setting you want to change and follow the instructions in the display.



Note

Before using the internet

The terms of use must be accepted once per car in order to use the internet.

Volvo services

You can manage your consent to data sharing with Volvo here.

Car location sharing

Give your consent for the car to be able to share its location. This is necessary if you want to use certain apps and functions. For example, location sharing is required for remote vehicle services via Volvo Assistance and the mobile app for the car, such as Find my car and the Trips app.^[2]

Vehicle Analytics & Improvement

Vehicle Analytics & Improvement can improve aftermarket services such as customer support, service planning and workshop visits. For this to work, you need to give your consent in the display.

^[1] Data is collected to provide better car, safety and app functions.

^[2] The Trips app can then collect data such as the car's position, speed, mileage and power consumption.

1.7. Handling of recorded and collected data

Certain information about the car's status and operation is recorded and collected for quality and safety reasons. This can provide an understanding of the circumstances around traffic accidents involving the car and other usage scenarios.

Event Data Recorder (EDR)

This vehicle is equipped with an Event Data Recorder. Its primary purpose is to register and record data related to traffic accidents or collision-like situations, such as times when the airbag deploys or the vehicle strikes an obstacle in the road. The data is recorded in order to increase understanding of how vehicle systems work in these types of situations. The EDR is designed to record data related to vehicle dynamics and safety systems for a short time, usually 30 seconds or less.

The EDR in this car is designed to record data related to the following in the event of traffic accidents or collision-like situations:

- How the various systems in the car worked.
- Whether the driver and passenger seatbelts were fastened or tensioned.
- The driver's use of the accelerator or brake pedal.
- The travel speed of the car.

This creates a better understanding about the circumstances in which traffic accidents, injuries and damage occur. The EDR only records data when a non-trivial collision situation occurs. The EDR does not record any data during normal driving condi-

tions. Similarly, the system never registers who is driving the vehicle, or the geographic location of the accident or near-miss situation. However, other parties, such as the police, could use the recorded data in combination with the type of personally identifiable information routinely collected after a traffic accident. Special equipment and access to either the car or the EDR is required to be able to interpret the registered data.

Additional recorded data

In addition to the EDR, the car is equipped with a number of computers designed to continually check and monitor the function of the car. They can record data during normal driving conditions, but in particular register faults affecting the vehicle's operation and functionality, or upon activation of the vehicle's active driver support function.

Some of the recorded data is required to enable service and maintenance technicians to diagnose and remedy any faults that occurred in the vehicle. The registered information is also needed to enable Volvo to satisfy legal requirements laid out in laws and by government authorities. Information registered in the vehicle is stored in its computer until the vehicle is serviced or repaired.

In addition to the above, the registered information can be used in combined form for research and product development with the aim of continuously improving the safety and quality of Volvo cars.

Volvo will not contribute to the above-described information being disclosed to third parties without the vehicle owner's consent. To comply with national legislation and regulations, Volvo may be forced to disclose information of this nature to the police or other authorities who may assert a legal right to access such information. Special technical equipment which Volvo and workshops that have entered into agreements with Volvo have access to is required to be able to read and interpret the recorded data. Volvo is responsible for ensuring that the information, which is transferred to Volvo during servicing and maintenance, is securely stored and managed and that its management complies with relevant legal requirements. For further information, contact a Volvo dealer.

1.8. About connected services and fair use policy

Use of your car's connected services is subject to certain conditions.

Fair use policy

Your use of connectivity services which are part of your car is subject to this fair use policy.

When using these services you agree not to:

- submit content that is unlawful, obscene, libellous, threatening, harassing, hateful, racially or ethnically offensive or otherwise inappropriate.
- use the services in breach of any applicable law.
- use the services for commercial purposes.

Your access to these services is part of a shared access. Volvo Cars reserves the right to suspend your access to or use of the services if your use involves very high volumes of data, disproportionate to other users. Volvo Cars may also suspend your access for technical reasons or to protect other functions of your car.

1.9. Changing ownership of the car

The driver of the car must be registered with Volvo to use all available functions and services. Therefore, in connection with a change of ownership, the current owner needs to be removed to give the new owner access.

The current owner needs to remove the link between the mobile app and the car. The new owner then needs to link their mobile app to the car before using it.

Note

Reset the car

When the current owner has ended the ownership, an automatic factory reset of the car takes place. This means that profiles, user data and other individual settings are removed.

1.10. Resetting user data

You can reset the system settings and user data in the display.

You can reset app settings or network settings to their standard values or do a complete factory reset by resetting the car. If you reset the car, you will delete all of the car's data including profiles, accounts and other customised settings.

Note

Only the owner can reset the car.

1. Press the car symbol  in the bottom bar and go to **Settings**.
2. Go to **System** → **Reset options**.
3. Select what you want to reset and follow the instructions in the display.

After resetting the car, the setup guide will automatically start to set up a new owner profile.

1.11. Recommendations when changing regions

When relocating or importing your car to a new region, you need to register your car and Volvo ID there.

To get help registering your car in a new region, contact Volvo support.

 **Note**

Available services can vary over time and depend on region. This may also have an effect when you're visiting another region temporarily.

2. User accounts, profiles and services

Get more out of your car by customising it using profiles and connecting it to the phone app. This gives you access to more features and services, such as support if you're having issues on the road.

Note

Many of the services available for your car require a registered personal account, such as your Volvo ID.

To get the most out of your car experience:

- Connect your Volvo ID
- Download the mobile app for this car to your phone
- Set up your user profile and customise the car's settings
- Sign in with your Google account

2.1. Setting up your car for the first time

There is a guide that helps you set up your car the first time you use it.

The setup guide for your car automatically starts in the display. It guides you through profile creation and other essential settings.

Tip

Before getting your car

Before you start, you will need to create a Volvo ID and download the mobile app for the car. This makes the in-car setup faster.

The setup guide covers the following:

- Important settings, such as your car's system language
- Setting up user profiles
- Connecting a key
- Consent to terms and conditions for various car services and other third-party services
- Connecting the car to the mobile app

i Note

Stay parked during setup

The car needs to be stationary and in P when you go through the setup guide.

Complete setup

It's advisable to complete the setup before driving the car. If you exit the guide before going through the necessary steps, certain features will be unavailable until you go back and complete the process. You will also be reminded about the setup the next time you drive the car.

No guide?

If the car has already been set up by someone else, such as a previous owner, you can reset the car to access the setup guide again.

2.2. Volvo ID

Your Volvo ID is a personal account that gives you access to various services connected to your car.

You will need your Volvo ID when you use remote features via the mobile app for the car.

i Note

Available services can vary over time and depend on both region and equipment level.

2.2.1. Creating a Volvo ID

Create your Volvo ID in the mobile app for the car or on Volvo's website.

If you want to use the mobile app to create your Volvo ID, make sure that you have the latest version installed on your phone.

1. Open the app on your phone or go to [volvocars.com](https://www.volvocars.com) [<https://www.volvocars.com>].

i Note

If you use the website, make sure that you are signed in.

2. Select the option to create a new Volvo ID and follow the instructions.

i Note

After creating your Volvo ID, you may need to confirm your email address to fully activate your account.

2.3. Volvo Cars app

The Volvo Cars app allows you to control certain functions and interact with the car via your phone.

The Volvo Cars app is available for iPhone and Android phones. You can download it for free from your phone's app store. The app is updated regularly, so make sure that you have the latest version on your phone.

i Note

The Volvo Cars app and your car need to be connected to the internet for all services to work properly.

Here are a few things you can do in the Volvo Cars app:

- Lock and unlock doors
- Control climate features when parked
- Check the battery level, lock status, window status and other car statuses

i Note

Available services can vary over time and depend on region.

2.4. Getting started with Google services

Signing in with your Google account gives you a personalised experience when using Google services and apps such as Maps.

To sign in to your Google account and take full advantage of Google services, the car needs to be connected to the internet.

1. If you don't already have a Google account, go to accounts.google.com/signup and create one.
2. Sign in using your Google account via the car's display and follow the instructions.

2.5. Customisation and settings

You can customise many of your car's features and behaviours by accessing its settings.

Where to find settings

Settings and adjustments are available in the following places:

- The settings tab in the display contains most of your car's settings and adjustments. To access it, press the car symbol  in the bottom bar and go to **Settings**. There are several categories to explore within the tab.
- Some views and in-car apps have their own settings sections. Open the app or view and look around to find available customisation options.
- The mobile app for the car has settings related to remote and connected features.

Setting types

Your car's settings apply differently depending on their type. Most settings are specific to a user profile, but some apply to all users of the car. A few settings are only available to adjust when the owner profile, which has administrative privileges, is in use.



Tip

Customised experience

Set up user profiles for all drivers to get a customised experience. There are many profile-specific settings that are applied automatically when you select your profile.

Some settings apply indefinitely from the moment you change them, while others may only be temporarily applied, such as until the end of the current drive.

2.6. Car user profiles

For a more customised experience, you can set up user profiles for different drivers.

To access all of your car's features, you need to set up the owner profile. You can then add co-driver profiles for more users. Having individual user profiles allows each driver to save customised settings and adjustments which are automatically applied when their profile is selected.

Profile type	Who uses it?
Owner	The permanent user profile for the owner of the car.
Guest	A guest user profile that's available for temporary users of the car.
Co-driver	Up to four additional user profiles for regular users of the car.

The owner has all the administrative privileges while the co-drivers have some of them. The guest can make some adjustments but that profile resets after every driving cycle.

You can find the profile settings in settings, where you can do the following:

- Switch profiles
- Change your profile name
- Add an account to your profile
- Connect a key to your profile
- Enable profile lock
- View and change your privacy settings
- Connect the mobile app for the car to your car
- Remove your profile

 **Note**

The owner can also manage other profiles in their profile settings.

2.6.1. Switching profiles

You can switch between profiles in the display.

 **Note**

Only available while stationary

You can only switch profiles when the car is stationary and in P. It's also unavailable during certain tasks.

Locked profile?

You might need a PIN, pattern or password to unlock a profile before using it.

1. Press the car symbol  in the bottom bar and go to **Settings**.
 2. Go to **Profiles** → **Switch profile**.
 3. Select your profile from the profile picker.
- > The car switches to your profile.

2.6.2. Adding a profile

You can add different profiles in the car's display.

In the setup guide

The setup guide in the display has instructions for how to add the owner profile. You can also add other co-driver profiles later in profile settings.

 **Note**

If you don't complete the setup guide, some features and services are unavailable.

Add a profile in profile settings

1. Press the car symbol  in the bottom bar and go to **Settings**.
2. Go to **Profiles** → **Switch profile**.
3. Press **Add new profile** and follow the instructions in the display.

2.6.3. Removing a profile

Find out how to remove a profile in the display.

Note

Guest profile

You cannot remove the guest profile.

Removing the owner profile

You can only remove the owner profile by resetting the car.

1. Press the car symbol  in the bottom bar and go to **Settings**.
2. Go to **Profiles** → **Manage profile** → **Remove profile**.
3. Select **Remove**.

Tip

The owner can remove other profiles if they have access to them.

When you have removed a profile, the car will automatically go to the guest profile.

2.6.4. Assigning a key to profile

You can only assign one key to your profile. Choose distance-capable key or a key card.

In the setup guide

You can assign your key to the owner profile in the setup guide. When it's time, place your key on the NFC reader and follow the instructions in the display. You can also do it later in profile settings.

Assigning a key to a profile in profile settings

1. Press the car symbol  in the bottom bar and go to **Settings**.
2. Go to **Profiles** → **Access and privacy** → **Connect key to profile**.
3. Press **Connect** and follow the instructions in the display.

2.6.5. Managing keys assigned to profiles

You can only assign one key to your profile. If you want to assign another key, you need to remove the connected key first.

1. Press the car symbol  in the bottom bar and go to **Settings**.
2. Go to **Profiles** → **Access and privacy** → **Connected key**.
3. Press **Remove**.

2.6.6. Restricting access to a profile

You can restrict access to a profile by adding a profile lock. When a profile lock is active, you need a PIN, pattern or password to unlock the profile.

1. Press the car symbol  in the bottom bar and go to **Settings**.
2. Go to **Profiles** → **Access and privacy** → **Enable profile lock**.
3. Press **Enable**.
4. Select your preferred lock type and follow the instructions in the display.

If you want to change the profile lock, press **Edit**.

2.6.7. Adding an account to a profile

You can add different accounts to your profile. This includes accounts from third-party apps.

1. Press the car symbol  in the bottom bar and go to **Settings**.
 2. Go to **Profiles** → **Accounts** → **Add new account**.
 3. Press **Add**.
- > You will see a list of possible accounts to add.

4. Select the account you want to add and follow the instructions in the display.

If you want to remove an account from your profile, select the account under **Accounts** and press **Remove**.

2.7. Volvo Assistance

Volvo Assistance is a service that provides assistance and remote access to certain car features. You can contact a Volvo Assistance service centre at any time for assistance.

If you experience any unpredictable problems on the road, you can call Volvo Assistance. This includes if:

- your car's battery runs out of charge
- your car breaks down
- you get a puncture.

Volvo Assistance is available in the mobile app for the car and by pressing the assist button  in the car's ceiling.

Note

Not for emergencies

If you need assistance in an emergency situation, press the SOS button instead. Situations that could require immediate emergency assistance include traffic accidents, acute illness and external threats.

An included service

Volvo Assistance is included with new Volvo cars for the first few years of ownership.^[1] For more information regarding your car, contact Volvo support or a Volvo dealer.

Note

If you don't have a Volvo Assistance agreement, you will still be able to use the service for an extra cost.

Terms and conditions

Volvo Assistance is intended to be active for as long as the car is used and the technology it relies on is supported, such as the car's mobile network connectivity.

Certain information, including personal data, needs to be shared with Volvo in order to use Volvo Assistance. Read more about data handling at [volvocars.com/intl/legal/privacy](https://www.volvocars.com/intl/legal/privacy) [<https://www.volvocars.com/intl/legal/privacy>].

Note

Volvo reserves the right to reduce Volvo Assistance functionality that it deems no longer practically possible to maintain. If a car remains unused for more than one year, it is considered no longer in use.

If you need any help or have any questions regarding Volvo Assistance, contact Volvo support.

^[1] Availability and inclusion with new cars varies between regions.

2.7.1. Calling Volvo Assistance for roadside assistance

You can press the assist button in the car's ceiling to contact Volvo Assistance for roadside assistance.^[1] For example, if you experience any unpredictable problems on the road, such as if your car's battery runs out of charge, your car breaks down or you get a puncture.

Note

Not for emergencies

If you need assistance in an emergency situation, press the SOS button instead. Situations that could require immediate emergency assistance include traffic accidents, acute illness and external threats.

Using Volvo Assistance abroad

If you press the assist button  when you are abroad, you will reach Volvo Assistance in your home country.

Tip

You can also use the mobile app for the car to contact Volvo Assistance.



The assist button is located in the ceiling, on the right side of the overhead console.

1. Press and hold the assist button for at least 2 seconds.



- > The car makes a voice call to Volvo Assistance. It also sends information such as its location and status. The Volvo Assistance call centre tries to communicate with the people in the car to find out what kind of help you need.



If you leave the call view during the voice call, you can always press the phone widget to return to the call view again. You can also end the voice call in the call view.

If the voice call fails, the Volvo Assistance call centre has the ability to respond based on information sent by the car.

^[1] Availability depends on region.

2.8. Emergency assistance

In an emergency, the car can connect you to an emergency call centre. This is done automatically in response to severe collisions or manually by pressing the SOS button in the ceiling.^[1]



Strictly for emergencies

Situations that could require immediate emergency assistance include traffic accidents, acute illness and external threats.

Built to work after a collision

Calling an emergency call centre after a collision requires that the system is not critically damaged. The system is designed to survive severe collisions and has its own backup battery in case the regular power supply fails.

When an emergency call is made, the following happens:

1. The car makes a voice call to an emergency call centre. It also sends information such as its location and status.
2. The emergency call centre tries to communicate with the people in the car to find out what kind of help you need.
3. If the voice call fails, the emergency call centre has the ability to respond based on information sent by the car.

Automatic emergency response

The car automatically attempts to contact an emergency call centre if it registers a collision above a certain level of severity.^[2]

Note

Not an emergency?

If you need help on the road but aren't in an emergency situation, press the assist button  to call Volvo Assistance instead. Volvo Assistance can help you in certain situations, such as if your car's battery runs out of charge, your car breaks down or you get a puncture.

^[1] Availability varies between regions. Contact Volvo support for more information.

^[2] For example, when safety features such as airbags or seatbelt pretensioners have deployed.

2.8.1. Calling emergency services with SOS button

A long press of the SOS button in the car's ceiling connects you to an emergency call centre.^[1]

Note

Strictly for emergencies

Situations that could require immediate emergency assistance include traffic accidents, acute illness and external threats.

Not an emergency?

If you need help on the road but aren't in an emergency situation, press the assist button  to call Volvo Assistance instead. Volvo Assistance can help you in certain situations, such as if your car's battery runs out of charge, your car breaks down or you get a puncture.



The SOS button is located in the ceiling, on the left side of the overhead console.

1. Press and hold the SOS button for at least 2 seconds.



- > The car makes a voice call to an emergency call centre. It also sends information such as its location and status. The emergency call centre tries to communicate with the people in the car to find out what kind of help you need.

 **Tip**

If you leave the call view during the voice call, you can always press the phone widget to return to the call view again. You can also end the voice call in the call view.

If the voice call fails, the emergency call centre has the ability to respond based on information sent by the car.

 **Note**

If you press the SOS button for too long, you will restart the system.

^[1] Availability may vary between regions.

3. Display, software and phone

Explore how to interact with your car. Here's where you can find more information on your car's display, connectivity features, sound and media, in-car apps, software and voice control.



You can access most of your car's functions via its display, but there's also plenty you can do by using your phone.

An internet-connected car makes remote access possible and keeps the car up to date by downloading software updates. Learn how it's all connected.

3.1. Display

The different areas of the display show you information related to the car and your driving. You can also control many of the car's functions by interacting with the display.



The display is divided up into two areas.

- ① The driver information area, which is always at the top of the display.
- ② The main area, which takes up most of the display.

The display sits in the middle of the dashboard.

 **Warning**

If the driver information area turns off, doesn't turn on or is only partially legible, you must not use the car. This is because the driver will not receive warnings and car status information shown in the driver information area, such as warnings and information relating to brakes, airbags or other safety systems. If there is an issue with the driver information area, contact an authorised Volvo workshop.

 **Important**

Do not use sharp objects on the display as they may cause damage.

 **Tip**

You can change the theme and brightness of the display in settings.

3.1.1. Main area of the display

The content of this manual represents the status of the user manual at the time of printing and may not be completely valid in future instances. For more information, refer to the first page for the complete disclaimer note.

You can control many of the car's functions and view detailed information and notifications in the main area of the display.



The main area takes up the majority of the display and you interact with it by touching the display.

Frequently used features such as climate, the car overview and the app library are available at the bottom of the main area.

Examples of functions that can be viewed and controlled via the display's main area are:

- Navigation
- Media players
- In-car apps
- Phone

3.1.1.1. Display views

Learn about some of the views that you can see in the main area of the display.

The different bars provide status information, display shortcuts to apps or quick controls, and allow you to navigate around the display views. The main views let you use and access navigation information, in-car apps, climate, car status and settings. There are also some specialised views for managing specific car functions.

Display bars







The status bar is located at the top of the main area of the display, underneath the driver information area. It shows you symbols relating to the car's status and apps, along with the time and outside temperature. You can press the right-hand side of the status bar to access some quick controls for a selection of system settings as well as get to the profile picker and settings view.

The bottom bar is your main way of navigating around the display views. By pressing the symbols, you can get to other views and functions as well as access the comfort view and activate the hazard warning lights. The status bar and bottom bar are always visible, regardless of which view you are looking at.

In some views, you will see the contextual bar appear above the bottom bar. This bar contains shortcuts to recently used functions or apps that only appear when you can use them. Sometimes these shortcuts are replaced by quick controls which allow you to control ongoing phone calls and media when the associated views or widgets aren't visible.

Main views

The following list contains the main views that you will see and use in the main area of the display.

Welcome view	The welcome view gives you quick access to some of the car's functions and the profile picker when you get into the car. It disappears when you start the car.
Home view	The home view shows a large navigation map and so it also works as the navigation view. There are widgets with quick controls for media and phone underneath the map. You can hide these widgets by pressing the home symbol and bring them back by pressing the symbol again. The home view is accessed from other views by pressing the home symbol  in the bottom bar.
App library	You can access in-car apps and the app store in this view. To get to this view, press the app library symbol  in the bottom bar.
Climate view	You can change a variety of climate settings in this view, such as activating or deactivating defrosters and adjusting settings for air conditioning. The climate view is opened by pressing the fan symbol  in the bottom bar.
Car overview	This view gives you access to quick controls, the car status and settings views as well as user profiles. These come together to give you an overview of the car. You can get to the car overview by pressing the car symbol  in the bottom bar.
Quick controls view	This view gives you quick and easy access to some of the car's functions, such as exterior lights and wing mirror adjustments. You can get to the quick controls view by pressing the car symbol  in the bottom bar.
Car status view	This view shows you important information relating to your car's status, such as issues that need resolving and the severity of them. You can also access the user manual as well as see the total distance driven in the car and when a service is due. The car status view can be accessed by pressing the car symbol  in the bottom bar.
Settings view	This view is where you can access all of the different settings tabs and views for your car. You can get to the settings view by pressing the car symbol  in the bottom bar.

Specialised views

The following views are related to specific functions in the car.

Comfort view	The comfort view appears when you press the temperature displayed in the bottom bar. This view gives you quick access to some essential climate and comfort settings, such as temperature control.
Volume view	You can adjust the volume for many types of sound in this view. To get to it, press the volume symbol  in the bottom bar.
Parking view	The parking view contains features that help you park. When shown, it takes up most of the main area of the display. If the parking view doesn't automatically appear when you need it to, you can open it yourself by pressing the camera symbol in the contextual bar above the bottom bar.

Note

Driver distraction overlay

What you can see and do in the main area of the display sometimes depends on whether the car is moving or not. To minimise driver distraction while the car is moving, some views become unavailable, such as certain settings. When this happens, the display shows the driver distraction overlay. When the car stops moving, the overlay disappears and you can interact with the view again.

3.1.1.2. Status symbols in the display

The content of this manual represents the status of the user manual at the time of printing and may not be completely valid in future instances. For more information, refer to the first page for the complete disclaimer note.

Status symbols are shown in the status bar at the top of the main area of the display. The symbols tell you important information about your car's system status.











Symbol types

Some status symbols, such as the clock and temperature, will always be visible in the status bar. Others are only visible when that particular function is active, such as wireless charging, or even disabled.

 **Note**

Make sure you look up any status symbols that you are unfamiliar with. They might not appear with any extra information or notifications.

This is a list of some status symbols that can appear in the status bar. It is not an exhaustive list and you might also see status symbols in the status bar from third-party apps.

	Clock	The clock shows you the current time. You can choose whether to display the time in the 12-hour or 24-hour format.
12:31		
	Outside temperature	This is the current ambient temperature outside of the car. You can choose to have the temperature displayed in degrees Celsius or Fahrenheit in the car's system settings.
8°C		
	Outside temperature with snowflake	This is the current ambient temperature outside of the car. The snowflake appears when the outside temperature is low.
-8°C *		
	Microphone is listening	The car's microphone is active and recording.
	Microphone is not listening	The car's microphone is not recording.
	New notification	There is a new notification in the notification centre.
	Wireless charging active	A device is charging on the wireless charger.
	Bluetooth connected	Bluetooth is enabled and a device is connected to the car.
	Location	Your location is being shared.
	Wi-Fi signal	Wi-Fi is enabled and active. The number of bars indicates the signal strength. If no bars are shown, this indicates that a Wi-Fi connection is active but there is no signal.
	Mobile internet signal	Mobile internet is active and being used by the car. The number of bars indicates the signal strength.
5G	5G internet	A 5G internet connection is active.

3.1.1.3. Keyboard

The display's keyboard appears when you can write text or numbers. You can customise many of its features in settings.

You can use the on-screen keyboard to write text or numbers. For example, when searching for a destination in the navigation app or putting the password in for a Wi-Fi network.

The keyboard's layout can change depending on the type of input field you are writing in.

The keyboard supports some alternative ways of inputting text. These include:

- Glide typing
- Speech to text
- Handwriting



Tip

You can download other keyboards to use by going to the app store in the app library.

3.1.1.3.1. Changing keyboard language

You can change the language for the display's keyboard on the keyboard itself.

Change the keyboard language when you want to write text in a different language. This can be useful when you are driving abroad and need to search for a destination or address in the local language.

Note

To be able to change the keyboard language, you need to have more than one language available for the keyboard. If you only have one language available, the languages symbol won't be shown on the keyboard.

Changing language to the next available language

1. Press the languages symbol  at the bottom of the keyboard.
 - > The keyboard language switches to the next one in the available languages list.

Changing language to any available language

2. Press and hold the languages symbol  at the bottom of the keyboard.
 - > A list of available languages appears.
3. Select the language you want to use.
 - > The keyboard language changes to the one you selected.

3.1.1.3.2. Adding and removing keyboard languages

You can add and remove keyboard languages in settings.

You can add languages to the display's on-screen keyboard if you want to write in a language that isn't already available. Languages can also be removed from the keyboard if you find that you no longer need them.

1. Press the car symbol  in the bottom bar and go to **Settings**.
2. Go to **System** → **Language and input** → **Keyboard**.
3. Choose the keyboard you want to make changes to.
4. Select **Languages**.

Adding a language

5. Press the add symbol  above the currently available languages and search for your desired language.

The content of this manual represents the status of the user manual at the time of printing and may not be completely valid in future instances. For more information, refer to the first page for the complete disclaimer note.

6. Select the language you want to add, then press the download symbol .

> The language is added to the list of languages available to use on your keyboard.

Removing a language

7. Press the edit symbol  above the list of currently available languages.

8. Select the language you want to remove from the list of available languages, then press the rubbish bin symbol .

> The language is removed from the list of languages available to use on your keyboard.

3.1.2. Driver information area of the display

The driver information area of the display shows you information related to your driving and the car itself.



The driver information area is not touch sensitive, so you can't interact with it via the display's surface. You can interact with the driver information area using the steering wheel buttons.

Examples of information that can be shown in the driver information area are:

- Warning and indicator symbols
- Speed
- Road sign information
- Notification messages
- Battery meter
- Power meter

Driver information area display modes

While driving, there are two display modes you can choose from: calm and surround. If the customisable button  on the steering wheel has the display mode switching function assigned to it, press the button to change display mode. You can read more about the steering wheel's customisable button in a separate section of the manual.

Calm This displays essential information, such as speed, battery level and range, as well as warning and indicator symbols.

Surround In this mode, you can see a depiction of the car, its positioning on the road and other vehicles. The same essential information as calm mode is also displayed.

Important

Using surround mode

Surround mode cannot perfectly depict what is really happening on the road around you, so do not rely on it when you are driving.

3.1.2.1. Warning and indicator symbols

The symbols in the driver information area tell you the status of different systems in your car. Some indicate whether a system is active and operating as it should, and others alert you to important information or detected faults.

Symbol types and colours

Some symbols are warnings that require immediate action, while others indicate the current status of specific functions. The symbol colour roughly signifies the level of importance. Red symbols are the most critical while amber symbols represent less urgent warnings and alerts. Symbols of other colours typically convey status information about the car's functions.

Tip

Be sure to look up the meaning of symbols you are unfamiliar with. Many symbols will appear with a notification providing more information.



Brake system warning

A fault is detected in the brake system. Take immediate action and contact an authorised Volvo workshop.

BRAKE

Brake system warning

A fault is detected in the brake system. Take immediate action and contact an authorised Volvo workshop.



Parking brake warning

Continuous illumination indicates that the parking brake is engaged. Flashing indicates a parking brake fault.

PARK

Parking brake warning

Continuous illumination indicates that the parking brake is engaged. Flashing indicates a parking brake fault.

























Low battery voltage warning



















The car's battery has a low voltage. Charge it as soon as possible.



Power system failure warning

A fault is detected in the car's power system. Take immediate action and contact an authorised Volvo workshop.

	Seatbelt reminder	Someone in the car isn't wearing their seatbelt.
	SRS warning	A fault is detected with the airbags or related safety systems.
	Charging cable connected	The charging cable is still connected to the car.
	Power steering failure	The power steering system no longer works due to a fault. Stop driving as soon as it is safe to do so.
	Driver alert warning	Flashing indicates that the Driver alert function senses you are tired and should take a break as soon as possible. A constant illumination indicates that there is a fault detected with the Driver alert system.
	Car status warning	There is at least one critical level notification in the car status view. Go to the car status view to see what the issue is and resolve it as soon as possible.
	Evasive manoeuvre warning	Steering is temporarily enhanced during an evasive manoeuvre.
	Rear auto brake failure	There is a fault with the rear auto brake.
	Artificial external sound error	There is an issue with the car's artificial external sound.
	Rear radar system failure	There is a fault with the rear radar system. If the symbol flashes, it means that there is a calibration failure.
	Rear collision avoidance system failure	There is an issue with the collision avoidance system at the rear of the car.
	Lane keeping aid failure	There is an issue with the lane keeping aid function.
	Front wiper failure	A fault is detected with the front wipers.
	Brake system warning	A fault is detected in the brake system.
	Brake system warning	A fault is detected in the brake system.
	Anti-lock braking system warning	The anti-lock braking system is disengaged. The friction brakes still function but without anti-lock braking.
	Anti-lock braking system warning	The anti-lock braking system is disengaged. The friction brakes still function but without anti-lock braking.
	Forward collision avoidance system warning	There is an issue with the collision avoidance system at the front of the car.
	Tyre pressure warning	Constant illumination indicates low tyre pressure. If there is a system fault, the symbol will flash for a short while and then be constantly illuminated.
	Electronic stability control alert	Constant illumination indicates that there is a problem with electronic stability control. Flashing indicates that electronic stability control is intervening.
	Electronic stability control off	Electronic stability control is turned off.
	Interior presence detection off	The interior presence detection function is turned off.

	Reduced performance alert	The car's performance is reduced.
	Rear fog light	The rear fog light is on.
	Driver alert system limitation	Something is blocking the driver monitoring camera's view.
	Power steering fault	There is a fault with the power steering. The power steering system is working with reduced effect.
	Car status warning	There is an important car status notification. Go to the car status view to see what the issue is and resolve it as soon as possible.
	High speed warning	You are driving over the maximum speed limit. Slow the car down.
	Hill descent control warning	There is an issue with the hill descent control function and it is currently unavailable.
	Lane keeping aid failure	There is an issue with the lane keeping aid function.
	Lane keeping aid off	Lane keeping aid is turned off and lane keeping assistance is not provided.
	Manual levelling failure	There is an issue with the manual levelling of the lights.
	Position lights failure	There is an issue with the position lights.
	Passing beam failure	There is an issue with the passing beam.
	Automatic high beam failure	There is an issue with the automatic high beam.
	Manual high beam failure	There is an issue with the manual high beam.
	Automatic high beam on	The automatic high beam is on.
	Manual high beam	The manual high beam is on.
	Left-hand direction indicator	The left direction indicator is active and indicating a left turn. When there is a fault with the direction indicator, the symbol flashes twice as fast.
	Right-hand direction indicator	The right direction indicator is active and indicating a right turn. When there is a fault with the direction indicator, the symbol flashes twice as fast.
	Position lights	The position lights are on.
	Passing beam is active	The passing beam is on.
	Automatic hold is active	The automatic hold braking function is active. The car automatically brakes while stationary.
	Hill descent control is active	The hill descent control function is active and working.



Rear radar system active and working The rear radar system is active and working normally.

READY

Ready The ready symbol appears when you put the car in a driving gear. It disappears when the car's speed exceeds walking pace. It reappears whenever the car slows down below the same threshold.



Automatic high beam enabled The automatic high beam is enabled and available to use.

[1]



Rain sensor The rain sensor is active and the front wipers are in auto mode.

[1]



Driver alert The Driver alert function senses you are tired and should take a break.

[1]



Towbar unlocked The towbar is unlocked.

[1]



Hill descent control enabled The hill descent control function is enabled but not currently active.

[1]



Trailer fault There is a fault with the trailer.

[1]



Trailer light fault A fault was detected with the trailer lights during the trailer light check.

[1]

[1] Depending on the car's current theme, this symbol can be a different colour.

3.1.2.2. Battery meter

The battery meter shows the charge level percentage and estimated range of your car.

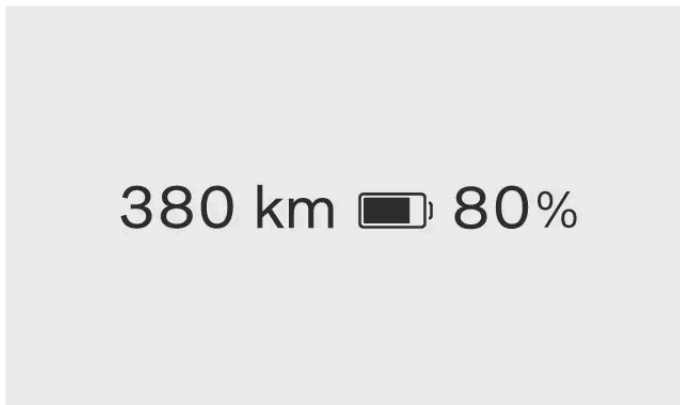

The battery meter is shown in the driver information area at all times. The battery symbol's colour changes depending on the level of remaining charge in the battery.

Remaining battery

The battery percentage indicates the level of charge left in your car's battery. The estimated range tells you how far you can drive with the battery's current charge level.

Note

Driving style and external factors, such as outside temperatures and driving for prolonged periods at high speeds, can have different effects on the estimated battery range.

Cold battery indicator

When the car has a cold battery, a snowflake ❄️ appears next to the battery icon. This indicates that the battery's charge capacity and range are reduced compared to normal conditions.

When the battery warms up, for example when driving, the snowflake disappears from the driver information area of the display.

3.1.3. System settings

You can change the system settings so that the car displays information in a way that suits you.

There are a number of system settings that you can change, including:

- System language
- Date and time
- Units of measurement
- Keyboard languages

3.1.3.1. Changing date and time

You can manually change the date, time and local time zone in settings.

By default, your car uses information from the internet to automatically change the date, time and local time zone for you. You can also manually change these yourself as well as the time format in settings.

1. Press the car symbol  in the bottom bar and go to **Settings**.
2. Go to **System** → **Date and time**.
3. If **Automatic date and time** and **Automatic time zone** are enabled, turn them off.
4. Select your desired setting and make any changes.

- > The changes are shown in the display.
The clock in the status bar updates if you made changes to the time setting.



Tip

To change the time format, turn it on for 24-hour format or off for 12-hour format.

3.1.3.2. Changing system language

You can change the language of the car's system in settings.

If you want the car's system to be in a language that is different from the current language, you need to change the system language.



Important

Only select a system language that you can fully understand. The car communicates safety-critical information and notifications to you through messages, so you need to be able to understand them at all times.

1. Press the car symbol  in the bottom bar and go to **Settings**.
 2. Go to **System** → **Language and input** → **Language**.
 3. Choose the language you want to change to.
- > The new language is shown in the display.

3.1.3.3. Changing system units

You can change the units of measurement, such as for speed and distance, in settings.



Tip

When driving abroad, it can be useful to change the car's units of measurement to match the local ones. It can be especially helpful if road signs display distances and speeds in units that are different to those currently displayed in your car.



1. Press the car symbol  in the bottom bar and go to **Settings**.
 2. Go to **System** → **Units**.
 3. Select the units of measurement you want the car to display.
- > The car displays units in the new format.
-

3.1.4. Restarting the display

You can restart the display using specific buttons on the steering wheel.

If you are having problems with the display, such as it freezing or the car not being able to connect to the internet, restarting it might be a way to resolve these issues.

To restart the display, the car must be at a standstill with the parking brake applied.

1. Simultaneously press and hold the decrease set speed  and decrease volume  buttons on the steering wheel until the display changes.
- > The display restarts.
-

3.2. Phone

Connect your phone to the car via Bluetooth to be able to use it while driving. When you are away from your car, you can also use your phone to read the manual or use some car features remotely via the mobile app for the car.

Connect your phone to your car

Connecting your phone to the car via Bluetooth allows you to use it through the car's interface. You can also stream media directly from your phone to the car.

You can use voice control or the display to search for your contacts, make and receive phone calls, and respond to text messages without even touching your phone.

Other uses for your phone

Using your phone with your car isn't limited to just when you're inside the car. Download the mobile app to remotely use certain car functions or read the user manual when you're away from the car.

3.2.1. Connecting your phone to the car

Connect your phone to the car via Bluetooth to use your phone through the car's interface.

Bluetooth must be enabled for both the car and your phone for them to be able to pair. You can turn Bluetooth on in settings. Make sure that your phone is set as discoverable so that the car can find it when pairing.

1. Press the car symbol  in the bottom bar and go to **Settings**.
 2. Go to **Connectivity** → **Bluetooth**.
 3. Select **Add** to start the pairing process.
 4. Choose the device you want to pair the car with from the list of available devices.
 5. Check that the confirmation code in the display matches the one shown on your phone.
 6. Select your preferred services, then press **Save**.
 7. Grant the car permission to access your phone in your phone's Bluetooth settings and via the display.^[1]
- > Your phone is now connected to the car. It will automatically connect next time, as long as Bluetooth is enabled on your phone.

Note

You can have multiple phones paired with the car, but only one can be connected to the car at a time. To change the active phone, select it from the list of paired devices or add a new device.

^[1] You can still connect your phone to the car even if you don't allow the car to access your contacts, but there will be reduced functionality.

3.2.2. Using your phone in the car

You can use your phone via the display and voice control.

Important

Make sure that you comply with all local laws and regulations regarding mobile phone use while driving.

 **Note**





You need to connect your phone to the car via Bluetooth and accept the corresponding phone settings permissions to be able to use these features.

Calling

There are some different ways you can make and receive phone calls while in your car. You can:

- accept and reject incoming calls using the display
- call someone while driving by asking the digital assistant to make the call for you
- use the in-car phone app via the display to call contacts or type a phone number in using the on-screen keypad.

When you have an ongoing call, it will be shown in the display. If you open the in-car phone app when you have an ongoing call, you can:

- mute and unmute your microphone 
- change the sound input and output, such as through the car or your mobile phone's microphone and speakers 
- end the call 
- use the keypad to input numbers, such as when asked to select an option in a service menu .

If you receive a second phone call while in the middle of an ongoing call, answering the second phone call automatically puts the first one on hold. However, you can switch between the two calls .

Messaging

You can write and send text messages via the digital assistant using voice control^[1]. If you receive a text message, a notification will appear in the display with the following options:

- **Play** to hear the digital assistant read the message out loud.
- **Mute** to stop receiving new message notifications from this specific conversation for the rest of the time you are in the car.

You can also ignore the notification and view it later in the notification centre.

Looking through and searching for your contacts

Use the in-car phone app to search for a specific contact by:

- pressing the search symbol 
- going to the contacts tab and typing their name
- going to the keypad tab and putting their number in.

You can also just ask the digital assistant to find the contact you are looking for.

^[1] Only applies to Android phones or phones with iOS 13 or later.

3.2.3. Switching between paired phones

You can change which Bluetooth-paired phone the car is connected to in settings.

The car can connect to and remember multiple phones, but it can only be actively connected to one phone at a time.

If you want to switch the Bluetooth connection to a new device, you need to pair it with the car first. You can do this in settings.

Before trying to switch to a different paired device, make sure that Bluetooth is enabled on the device you want to switch to.

1. Press the car symbol  in the bottom bar and go to **Settings**.
 2. Go to **Connectivity** → **Bluetooth** → **Saved devices**.
 3. Press the name of the phone you want to connect to.
- > If the connection is successful, the phone's name moves to the top of the saved devices list.

If you can't see the device you want to switch to in the saved devices list, try pairing it with the car again.

3.2.4. Apple CarPlay

Activate Apple CarPlay to use your iPhone wirelessly via the car.

Apple CarPlay gives you another way of using your iPhone via the car's interface. You can use certain communication, navigation and media apps on your iPhone via the main area of the display as well as voice control.

Important

Local laws and regulations

Make sure that you comply with all local laws and regulations regarding mobile phone use while driving.

CarPlay content

Volvo does not accept responsibility for the content available in Apple CarPlay.

Note

Phone compatibility and supported apps

Apple CarPlay only works with iPhones but it doesn't work with all iPhone models. To find out if your iPhone is compatible or to learn more about which apps are supported, go to Apple's website www.apple.com/ios/carplay [<https://www.apple.com/ios/carplay>].



Tip

Keep your iPhone and apps updated to the latest versions.

Connect your iPhone and start CarPlay

Connect your iPhone to the car via Bluetooth and activate Apple CarPlay. After setting up CarPlay for the first time, it automatically starts when you connect your phone via Bluetooth again.

CarPlay view

You can access the CarPlay view by opening the CarPlay app in the app library. If the CarPlay symbol  is shown in the contextual bar, you can also access the view by pressing this symbol.

Once active, the CarPlay view takes up the whole of the main area of the display. However, the bottom bar, contextual bar and status bar will still be visible at all times if you want to return to the car's own system.

Navigation with CarPlay

You can use navigation apps on your iPhone via Apple CarPlay. If you start a navigation route via CarPlay, you can see the guidance in the display's CarPlay view.

Using Siri

If you want to use Siri instead of the car's in-built digital assistant, press and hold the voice control button  on the steering wheel while CarPlay is active.

You can use Siri to read out, write and send messages. Siri will read and write messages in the language selected in the Siri settings on your iPhone. If you write a message via Siri, the car's display won't show you your message but it will be displayed on your iPhone.

3.2.4.1. Connecting your iPhone to Apple CarPlay

Connect your iPhone to the car via Bluetooth to start using Apple CarPlay.

Bluetooth must be enabled for both the car and your phone for them to be able to pair. You can turn Bluetooth on in settings. Make sure that your phone is set as discoverable so that the car can find it when pairing.

To be able to use CarPlay, you need to activate Siri on your iPhone and have an active internet connection. You also need to turn the car's Wi-Fi off as CarPlay can't be active while Wi-Fi is enabled.

1. Press the car symbol  in the bottom bar and go to **Settings**.
2. Go to **Connectivity** → **Bluetooth** → **Add new device**.

3. Press **Add** to search for your iPhone.
 4. Select your iPhone from the list of discovered devices.
 5. Check that the confirmation code in the display matches the one shown on your phone.
 6. On your iPhone, consent to using CarPlay.
 7. In the car's display, read and accept CarPlay's terms and conditions.
- > Your iPhone connects to CarPlay and the CarPlay view opens in the car's display. A CarPlay symbol  also appears in the status bar to indicate that CarPlay is active.

CarPlay automatically starts the next time you connect your iPhone via Bluetooth.



Tip

You can disconnect from CarPlay but keep your iPhone connected to the car by pressing the CarPlay symbol  next to your device's name in the car's Bluetooth settings.

3.2.5. Android Auto™

Connect your phone via Bluetooth and activate Android Auto™ to use your Android™ phone via the car.

Android Auto gives you another way of using your Android phone via the car's interface. With Android Auto, you can safely access your phone's communication, navigation and media apps via the display as well as the steering wheel buttons.



Important

Local laws and regulations

Make sure that you comply with all local laws and regulations regarding mobile phone use while driving.

Android Auto content

Volvo does not accept responsibility for the content available in Android Auto.

 **Note**

Phone compatibility and supported apps

Android Auto only works with Android phones but it doesn't work with all phone models. To find out if your phone is compatible or to learn more about which apps are supported, go to Android Auto's website www.android.com/auto/ [<https://www.android.com/auto/>].

Google Trademarks and compatibility

Google, Android and Android Auto are trademarks of Google LLC. Compatible Android phone and compatible active data plan required.

 **Tip**

Keep your phone updated

Keep your phone and apps updated to the latest versions.

Connect your phone and start Android Auto

 **Note**

Install Android Auto on your phone and have an active internet connection

To be able to use Android Auto, you need to have the Android Auto app installed on your phone and an active internet connection.

Connect your phone to the car via Bluetooth. If you are using Android Auto for the first time, you need to accept the terms and conditions in the display, then Android Auto will start. If you have used Android Auto before, it will automatically start when you connect your phone to the car.

Android Auto view

You can access the Android Auto view by opening the Android Auto app in the app library. If the Android Auto symbol  is shown in the contextual bar, you can also access the view by pressing this symbol.

Once active, the Android Auto view takes up the whole of the main area of the display. However, the bottom bar, contextual bar and status bar will still be visible at all times if you want to return to the car's own system.

Navigation with Android Auto

You can use navigation apps on your phone via Android Auto. If you start a navigation route via Android Auto, you can see the guidance in the main area of the display's Android Auto view. If you are following a navigation route in the car's own navigation app and then start another navigation route in Android Auto, the navigation for the car's own app will end.

Using Google Assistant

Talk to Google Assistant on Android Auto to carry out tasks with your voice so that you can keep your focus on driving. To use Google Assistant, just say "Ok Google" or press and hold the voice control button  on the steering wheel while Android

The content of this manual represents the status of the user manual at the time of printing and may not be completely valid in future instances. For more information, refer to the first page for the complete disclaimer note.

Auto is active.

You can use Google Assistant to carry out tasks such as sending messages, getting directions or controlling media.

3.3. Sound and media

Listen to music and media through the car's sound system. You can adjust how it sounds in settings.

Sound settings

The sound settings allow you to change and adjust a variety of sound options.

Radio and media players

You can listen to live radio via the pre-installed radio app and stream media from your phone to the car via the Bluetooth media player.



Tip

You can find and download more third-party media apps via the car's app store.

Controlling media playback

You can control media playback in a number of ways by using:

- media playback controls in the display
- the steering wheel buttons
- voice control.

3.3.1. Radio

Use the pre-installed radio app to listen to live radio in your car.

Link DAB and FM radio stations

DAB and FM linking allows the car to automatically select the strongest reception between the DAB or FM sources of linked stations. Your car comes with this already enabled but you can turn it off in the radio app settings.

Radio announcements

When listening to the radio, you might hear some announcements which interrupt what you're listening to. The announcements can be alarms, warnings, news or about the traffic, and are accompanied by a notification in the display. You can stop the announcement and continue listening to the radio by dismissing the notification.

You can choose which radio announcements you want to hear in radio settings. Press the settings symbol  at the top of the radio app, then turn the announcements on or off. By default, alarm announcements are turned on but warnings, news and traffic announcements are turned off.

Radio favourites

You can add stations to your radio favourites list for quicker access.





Tip

You can find and download other radio apps via the app store.

3.3.1.1. Adding radio favourites

You can add radio stations to the favourites list in the radio app.

Add the radio stations you listen to frequently to the favourites list for quicker access. You can add up to 50 radio stations to the list.

1. Press the app library symbol  in the bottom bar and open the radio app.
 2. Find the station you want to add as a favourite from the list of currently available radio stations.
 3. Press the star symbol  to the right of the station name.
- > The appearance of the station's star symbol changes and the radio station appears in the favourites list.

If you want to remove a station from the favourites list, just press the star next to its name.

3.3.1.2. Linking DAB and FM stations

Turn DAB and FM linking on or off in the radio app settings.

When an FM station has a corresponding DAB station, and vice versa, they can often be linked in the radio app. Linking the two radio sources allows the car to automatically switch between the DAB and FM stations to play the source with the strongest reception.

1. Press the app library symbol  in the bottom bar and open the radio app.

2. Press the settings symbol  to go to radio settings.

3. Turn DAB and FM linking on or off.

> When turned on, the radio app shows one radio station tab. All linked stations in the list have the link symbol  underneath their names.

When turned off, the radio app shows separate DAB and FM station tabs. There is no link symbol underneath the station names.



Note

It might not be possible to link some corresponding DAB and FM stations, so these will appear as separate stations.

3.3.2. Sound settings

You can change and adjust a variety of sound options in settings.

The sound settings view has two tabs: audio and volume.

Audio tab

- | | |
|------------------------------|--|
| Sound focus | You can choose from three sound focus settings: all, driver and rear. All is the default setting and doesn't focus the sound in a particular direction. It provides a neutral sound focus where occupants in the front and rear seats have the same sound experience. The driver setting focuses the sound towards the driver whereas the rear setting focuses sound towards the rear seats. |
| QuantumLogic surround | QuantumLogic surround gives you a surround sound experience. You can choose QuantumLogic surround to be low, medium or high, or simply turn it off. |
| Equaliser | Access the equaliser settings in the audio tab by pressing Equaliser. You can change the tone of the in-car sound using the six adjustment levels as well as adjust the subwoofer. There are also four EQ presets available to choose from: Dynamic, Soft, Voice and Custom. When Custom is selected, you can reset the equaliser values back to 0 by pressing Reset custom. |

Volume tab

In this tab, you can adjust the volume for the following:

- Media
- Ringtone
- Call
- Voice assistant
- Navigation
- Notifications
- Parking assistance

The noise compensation setting automatically adjusts the sound volume inside the car according to the level of noise outside the car. You can select low, medium and high compensation levels or turn the feature on or off.

You can also turn display touch sounds on or off in this tab.

3.3.3. Media players

Your car comes with a pre-installed media player. You can download more third-party media apps from Google Play in the app library.

Your car comes with the Bluetooth media player pre-installed in the app library.

Use the Bluetooth media app to stream media from a Bluetooth-connected device straight to the car.

3.4. In-car apps

All of the car's apps can be found in the app library.

You can access the app library by pressing its symbol in the bottom bar.



App library symbol

The apps in the library are shown in chronological order, starting with the app installed first and ending with the most recently installed app.

Some apps are pre-installed, such as Bluetooth media, Google Maps and Google Assistant. You can search for and download new apps via Google Play, which can be accessed in the app library.

3.4.1. Downloading apps

Download more apps to your car from the app store in the app library.

Your car comes with some apps pre-installed, but you can find and download more in the app store.

1. Press the app library symbol  in the bottom bar.
2. Press **Get apps** to go to the app store.
3. Search for the app you want to download.
4. Download and install your desired app.

> If the app is successfully downloaded and installed, it appears in the app library.

3.4.2. Uninstalling apps

You can uninstall apps you no longer want or use in the app library.

 **Note**

Pre-installed apps, such as phone and radio, can't be uninstalled.

1. Press the app library symbol  in the bottom bar.
 2. Find the app you want to uninstall, then press and hold the app until a menu appears.
 3. Select **Uninstall** from the menu.
 4. Press **OK** to continue uninstalling the app.
- > The app is uninstalled and it disappears from the app library.
-

3.5. Connectivity and software

Connect your car to the internet to get more from your car and receive over-the-air software updates.

Internet connectivity

Connect your car to the internet via Wi-Fi or the car's in-built mobile network connection.

Software updates

Over-the-air updates keep your car's software up to date.

3.5.1. Internet connection

Connecting your car to the internet gives you access to more features and over-the-air software updates.

There are a few ways to connect your car to the internet. When the car can access the internet in more than one way, it prioritises them in the following order:

- Wi-Fi network
- Mobile network

Wi-Fi

You can connect the car to a Wi-Fi network for internet access. The car can automatically connect to the network whenever it's within range.

Mobile network

Your car has a built-in modem for connecting to a mobile network. As long as the car has an active mobile network service plan and it's in an area with network reception, it can connect to the internet. Contact an authorised Volvo workshop for information about mobile connectivity services for your car.

The car supports mobile networks up to, and including, 5G. The available mobile network speeds depend on the SIM card installed in your car.

Note

Mobile network connectivity conditions and limitations

- The car needs to be in an area with mobile network reception.
- Mobile connectivity services must be active for the region in which the car is located.
- Obstacles such as buildings, hills and mountains can weaken or block the mobile network signal.

Internet connection settings

You can find the connectivity settings in the display.

3.5.1.1. Connecting to the internet via Wi-Fi

Connect your car to a Wi-Fi network for internet access.

1. Press the car symbol  in the bottom bar and go to **Settings**.
 2. Go to **Connectivity** → **Wi-Fi**.
 3. Enable Wi-Fi if it is disabled.
 4. Select the Wi-Fi network you want to connect to.
 5. Enter the Wi-Fi network password using the display's keyboard and press **Connect**.
- > The car connects to the Wi-Fi network.

3.5.2. Over-the-air updates

Over-the-air updates keep your car's software up to date.

Note

To enable over-the-air^[1] updates, you must accept the OTA consent in the mobile app for the car during onboarding or in the app's privacy settings. You cannot enable the updates or consent to them via the car's display.

When your car is connected to the internet, it can receive over-the-air updates to keep the car's software up to date. When you have enabled software updates in the mobile app, the car will automatically download the updates and tell you when they can be installed. You will get installation notifications via the app and the car's display.

You can also check for new software updates by going to **System** → **Software update** in settings.

Installing software updates

When a new software update is available, the car will automatically download the update but it won't install it for you. You need to start the installation yourself, either via the mobile app for the car, a notification in the display or in the software update view. The notification only appears in the display when you put the car into P and unbuckle your seatbelt. You can cancel the installation after confirming it if you change your mind about installing the update.

You can't access or use your car while a software update is installing. Therefore, make sure that there is approximately 50% battery charge remaining and that you don't need to use your car during the installation process. The car will give you an estimation for how long it will take to install the update.

 **Important**

There might be updates that you can't install yourself. If this happens, contact an authorised Volvo workshop to book a service.

If there is a critical update failure, avoid driving the car and call roadside assistance to take you to an authorised Volvo workshop.

 **Note**

You can't install software updates while the reduced alarm sensitivity setting is active.

When the software update is complete, your car may appear as offline in the Volvo Cars app. The car will reconnect to the app the next time your car is driven.

Scheduling updates

If you want to install an update at a later time, you can schedule the installation in both the mobile app and the display. Scheduling an update sets a timer for when you want the car to attempt to install the update, for example in 4 hours' time. The maximum amount of time you can schedule an update for is 24 hours.

^[1] OTA

3.6. Voice control

Keep your hands on the wheel and use your voice to interact with the car via the digital assistant.

With the help of the digital assistant, you can use voice control to carry out tasks, such as searching the internet and getting weather forecasts. You can also use your voice to interact with the car and control a number of its functions, including:

- Media player
- Phone
- Navigation
- Climate

Speaking to the digital assistant

The assistant understands everyday speech, so you don't need to know any specific voice commands to use it. You can ask the assistant anything and it responds by confirming what you said, then doing what you asked. It will let you know if it doesn't understand you.

 **Note**

- The voice control feature is from a third-party supplier. Availability, how to use it and how it works may vary over time and between regions.
- A poor internet connection may limit the number of available functions.

3.6.1. Using voice control

Use your voice to control and interact with a number of the car's functions via the digital assistant.

The only time you need to use specific voice commands to interact with the digital assistant is when you activate it. After activating the assistant, just speak or give instructions to it using everyday phrases.

 **Note**

Google Assistant isn't available in every language yet. Find out more at support.google.com [<https://support.google.com>] or try to use another language if you can.

1. Say "Ok Google" or "Hey Google" to activate Google Assistant.

> The assistant confirms that it's listening.
2. Speak or give instructions to the digital assistant using everyday phrases.

 **Tip**

Other ways to activate

You can also activate the digital assistant by pressing the microphone button  on the right-hand side of the steering wheel and via the display.

Sign in to your Google account

If you sign in with a Google account, Google Assistant will be more personalised when the car is online. For example, you can easily call contacts stored in your Google contacts or check what's in your Google Calendar.

4. Interior comfort and climate

Get familiar with your car's interior and the controls for seat adjustment, climate and windows.



Your car is equipped with multiple features to assist you in your driving. While some features are mainly for comfort, others improve visibility. Reading this section of the manual can assist in making your driving experience more comfortable.

4.1. Interior

Get to know the interior's layout and its practical features, such as cup holders and charging ports for your devices.



Interior walk-through

There are a few places and components whose names and locations are good to know, as they are referenced throughout the manual.

Passenger compartment	The passenger compartment is divided into the front and rear passenger compartment.
Boot	The boot, or cargo area, is the space behind the rear seats, which you typically access from behind the car.
Dashboard	The dashboard refers to the whole set of panels and components in front of the driver and front passenger. It has some of your car's main interaction areas, such as the display, steering wheel, USB ports, air vents and glove box.
Centre armrest	The centre armrest sits between the front seats, above the tunnel console. It's where you find the controls for windows and locks, storage compartments, a cup holder and a rearward-facing utility panel.
Overhead console	The overhead console sits in the ceiling against the windscreen. It provides easy access to certain important functions and status indicators.

Note

Using the cup holder

To access the cup holder, push the lower front section of the centre armrest and let go. The cup holder will slide out fully.

The cup holder tray needs to be handled carefully to avoid damaging it. It retracts in two steps, one for each cup hole. It's important to slide it back one cup hole at a time. Do not try to force the tray back in one motion.

4.1.1. Using the wireless charger

Use the wireless charger to charge Qi-certified devices, such as a phone.



The wireless charger under the display

To use the wireless charger, your device should be certified to the Qi wireless charging standard. Also make sure that wireless charging is enabled on the device^[1] you want to charge.

 **Warning**

Wireless charging may affect the operation of a pacemaker or other implanted medical devices. If you have one, consult your doctor before using the wireless charging system.

 **Important**

Signal disturbances

The car uses electromagnetic fields, Bluetooth and NFC^[2]. These signals may cause disturbances in other devices at certain distances. Make sure you are aware of what these issues may be. You can read more about different specifications in their separate sections in this manual.

NFC cards and charging

Avoid storing cards or keys with NFC near the wireless charger when using the charging function as this could damage them.

Before charging a device, make sure there are no other objects on the charger.

1. Place the device in the middle of the charger.
- > The device starts charging.

 **Warning**

Never leave your phone on the wireless charger when you leave the car.

 **Note**

- You may experience differing results when charging different devices. For example, the time it takes before charging starts and how quickly a device is fully charged.
- Your device might get hot during charging. This is normal and nothing to worry about. If the device's battery temperature becomes too high, charging is deactivated.

If the device doesn't charge

If your device doesn't charge when placed on the charger, there are some steps you can try:

- Make sure there are no items on the charger apart from the device you want to charge.
- Lift the device and then place it back in the middle of the charger.
- Remove any cases or covers from the device.

[1] Many Qi-certified devices are always enabled

[2] Near Field Communication

4.1.2. USB ports

You can use your car's USB ports to charge a phone, tablet or other device.

Location of the USB ports



USB port locations.

There are two USB ports [1] under the display.

There are also two USB ports [1] in the rear part of the tunnel console.

Using the USB ports

Always disconnect devices from the ports when not in use.

Some devices may become hot during charging. This is normal.

The car turns off power to the USB ports automatically when you leave the car. If you leave the car unlocked, the socket remains active for a while longer before turning off.

Tip

If you would like to keep the USB ports active while parked, read about parking comfort in this manual. When this function is on, the USB ports will continue to provide power even if the car is locked.

USB port specifications

- Type C socket
- Version 3.0
- Normal charge
 - Voltage supply 5 V
 - Current supply max. 3.0 A
- Quick charge
 - Voltage supply 9 V
 - Current supply max. 2.0 A

[\[1\]](#) type C

4.1.3. 12 V socket

You can use the 12 V socket to power various electrical devices, such as a cool box.

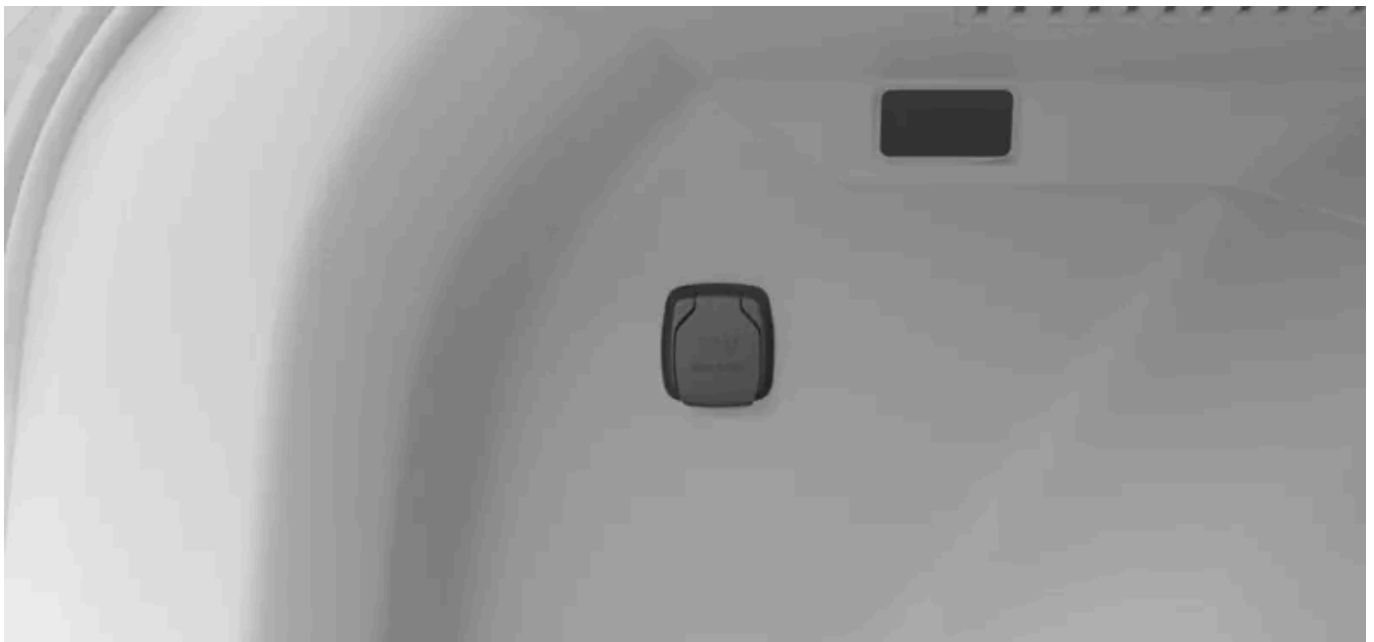

12 V socket.

The 12 V electrical socket is on the left-hand side in the boot.

The car turns off power to the socket automatically when you leave the car. If you leave the car unlocked, the socket remains active for a while longer before turning off.

 **Tip**

If you would like to keep the 12 V socket active while parked, read about parking comfort in this manual. When this function is on, the 12 V socket will continue to provide power even if the car is locked.

Always disconnect devices from the socket and close the cover when not in use.

Some devices may become hot when charged through the 12 V socket. This is normal for many devices.

 **Warning**

Failure to observe the following instructions could cause damage or personal injury.

- Do not use electrical devices with large, heavy plugs. They can damage the socket or come loose while driving.
- Do not use electrical devices that could interfere with the car's systems, such as the radio receiver.
- Only connect undamaged and fully working devices that meet all relevant safety standards^[1].
- Keep an eye on connected devices to prevent damage or injury if they malfunction.
- Do not connect adaptors or extension cables to the 12 V socket as these can override the socket's safety features.
- Do not expose the socket, connectors or connected devices to water or other liquids.
- Do not touch or use the socket if it appears to be damaged or has come into contact with water or other liquids.

Power rating

 **Important**

The maximum power draw is 120 W (10 A).

^[1] CE marking, UL marking or similar compliance marking

4.1.4. Sun visors

There are sun visors overhead in front of the driver's seat and the front passenger seat.



You can fold the visors down and angle them to the side to block the sunlight coming from the side of the car.

There is also a mirror in the sun visor with a protective cover.

4.2. Comfort

Your car has several features designed to enhance your comfort while driving or parked.

While many of your car's features are designed to enable safe driving practices, others are more focused towards enhancing your comfort. This includes certain climate features and comfort modes.

Climate

Your car has the ability to provide a comfortable climate in the passenger compartment. It can cool, heat and dehumidify the air for you when needed. There are also built-in features for providing good air quality.

Many of the climate features are automatic whereas others can be adjusted manually.

Seats

The front seats of your car are adjustable. While a good driving posture is necessary for visibility and safe driving practices, adjusting your seat also enables better comfort while driving or parked.

In colder temperatures, it's nice to heat your seat for a more comfortable driving experience. You can activate and adjust the seat heating via the centre display.

Heated steering wheel

The steering wheel has built-in heating, which can provide comfort in colder temperatures. You can activate and adjust the steering wheel heating via the display.

Refresh mode

When you turn on refresh mode, the air conditioning starts and quickly refreshes the air in the passenger compartment. This can be especially nice on longer drives.

Relax mode

Relax mode can be activated to create a relaxing atmosphere in the car while parked. When you activate this mode, the driver seat reclines, the interior lights dim or turn off, and your car locks. You can activate relax mode in the display.

Parking comfort

Parking comfort allows you to maintain a comfortable interior climate in your car while parked. This includes keeping the climate functions and the entertainment system on. You can activate the parking comfort function via the display. Just be aware that the car's range can be affected if you leave this setting on for too long.

4.2.1. Activating refresh mode

You can turn on refresh mode to quickly cool the air in the car.

When you turn on refresh mode, the air conditioning starts and quickly refreshes the air in the passenger compartment. This can be especially nice on longer drives.

1. Press the car symbol  in the bottom bar and go to **Settings**.
2. Go to **Controls** → **Car modes** → **Comfort**.
3. Go to **Refresh** and press **Start**.

The refresh mode will automatically turn off when the maximum running time is reached. You can also turn it off manually via the display by pressing **End**.

4.2.2. Activating relax mode

Activate relax mode to create a relaxing atmosphere when parked. You can do this via the display.

When you activate relax mode:

- the driver seat position adjusts and the back reclines

- the interior lights are dimmed down
- all closed doors are locked
- the windows close.



Tip

Customise your relaxing experience

You can adjust your seat position and how much it reclines while relax mode is active using the seat adjustment controls. Your settings are saved and applied the next time you activate relax mode.



Warning

Never leave a child or pet unattended in your car. You are responsible for their safety and well-being.

Before activating relax mode, make sure that the back seats are free from items or passengers so that the front seats can safely tilt back.

1. Press the car symbol  in the bottom bar and go to **Settings**.
 2. Go to **Controls** → **Car modes** → **Comfort** → **Relax**.
 3. Set the timer for how long you want relax mode to stay on.
 4. Press **Start**.
- > Relax mode is activated.

Relax mode turns off automatically when the set time limit is reached, when you start to drive or when your car's battery level reaches 20%. You can also turn it off manually via the display by pressing **End**.

4.3. Climate

Your car has the ability to provide a comfortable climate in the passenger compartment. It will cool, heat and dehumidify the air for you when needed. There are also built-in features which will provide good air quality.



This section of the manual covers the various climate features in your car, such as air conditioning, climate modes and heating options.

4.3.1. Climate controls

You can control the car's interior climate through various means, from both inside the car as well as from your phone.

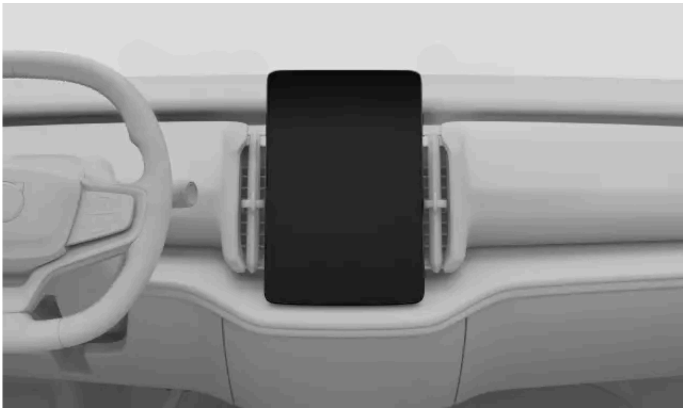



Defroster button in the overhead console



The mobile app

You can control the car's interior climate here:

- The display
- The overhead console
- The mobile app for the car.

Most of your car's climate settings can be found in the display. There is, however, one physical button in the overhead console which controls the defroster.



Tip

Use the mobile app for the car to remotely precondition your car. That way, you can ensure a comfortable interior climate when it's time to go for a drive.

4.3.1.1. Activating seat heating

You can activate the seat heating function via the comfort view in the display.

In colder temperatures, it's nice to heat your seat for a more comfortable driving experience. You can activate and adjust the seat heating via the display.

 **Warning**

Seat heating should not be used by individuals who:

- have difficulties sensing temperature shifts due to sensory loss.
- have trouble controlling the seat heating settings.

1. Press the temperature symbol in the bottom bar.
2. Select your preferred seat heating level.

To close the comfort view, press the downward arrowhead symbol in the bottom bar.

 **Tip**

Automatic seat heating

You can select automatic seat heating in the comfort view. This means your seat heating adjusts automatically.

4.3.1.2. Activating the steering wheel heating

Steering wheel heating can be controlled via the display. You can activate it manually or set it to automatic activation.

In colder temperatures, it's nice to heat your steering wheel for a more comfortable driving experience. You can activate and adjust the steering wheel heating via the display.

1. Press the temperature in the bottom bar.
2. Select your preferred steering wheel heating level.



 **Tip**

Automatic steering wheel heating

You can select automatic steering wheel heating in the comfort view. This means your steering wheel heating adjusts automatically.

4.3.2. Climate settings

In climate settings, you can choose which functions should automatically activate when the car turns on.

You can access the climate settings by pressing the fan symbol  in the bottom bar and going to settings .

There are a number of climate functions you can set to automatically turn on. These include:

- Air quality notification.
- Open window notification.

4.3.3. Temperature and air conditioning

By using the automatic climate settings, your car's climate system aims to always provide you with a comfortable interior environment. However, if you want to, you can always make adjustments to your liking.

The auto climate mode provides a comfortable interior environment in most circumstances. However, adjustments can always be made. For example, you can make changes to the temperature settings, let different climate zones have their own settings and change the settings for the air conditioning.

4.3.3.1. Activating air conditioning

The air conditioning cools and dehumidifies the incoming air.

When you select auto climate mode, the air conditioning is automatically activated or deactivated to maintain the set temperature. Deselecting the air conditioning while in auto climate mode will activate manual climate mode.

For the air conditioning to work efficiently, windows, doors and the boot need to be closed.



Tip

Open window detection

In the climate settings view, you can choose to be notified when an open window severely affects the climate performance.

1. Press the fan symbol  in the bottom bar and go to **Climate**.
2. Press the air conditioning symbol *A/C*.

4.3.3.2. Setting temperature

You can change the temperature in the passenger compartment via the display.

1. Press the temperature in the bottom bar.
2. Use the plus or minus symbol to adjust the temperature.



Tip

You can set the temperature in your car hands-free via voice control.

4.3.3.3. Synchronising temperature

By default, the driver's temperature setting is used for all climate zones. However, each climate zone can also have its own individual setting. You can switch between the two options by desynchronising and synchronising the temperature.

1. Press the temperature in the bottom bar.
2. Press the synchronisation symbol  to desynchronise or synchronise the temperature.



Tip

The temperature setting is also desynchronised when the passenger sets a different temperature on their side.

4.3.3.4. Activating eco climate

Your car has an eco climate function which prioritises the car's range over climate-related features.

Eco climate prioritises range over climate comfort. The heating, cooling and air conditioning functions are limited in this mode.

Note

Problems with misting may occur as the air conditioning function that adjusts humidity is limited when eco climate is active. This can also affect the air quality, especially in the rear seat as the air recirculation increases.

1. Press the fan symbol  in the bottom bar and go to **Climate**.
2. Press the eco climate symbol **Eco**.

4.3.4. Air distribution and climate modes

The general air distribution is decided by the selected climate mode and settings. There are also air vents that offer additional adjustability of the airflow throughout the car.

Adjustable air vents



The positions of the adjustable air vents.

The adjustable air vents can be opened, closed and angled to control the intensity and direction of the airflow.

Climate modes

There are two climate modes – automatic and manual. The automatic mode takes care of most adjustments and climate functions for you. However, in manual mode, you can control more of the available adjustments and functions yourself.

You can also turn the climate system off completely.

 **Important**

Condensation risk

Turning the climate system off completely may cause condensation on the windows, which could affect visibility.

The climate modes and their settings are available in the display's climate view.

4.3.4.1. Adjusting air vents

You can adjust the air vents via the display's climate view as well as by using the physical air vent controls.

You can open and close the air vents via the climate view in the display. Use the physical knob on each air vent to adjust the air vents and air flow.

Opening and closing air vents via the display

1. Press the fan symbol in the bottom bar .
2. Select the air vents you want to open or close.

Physically adjusting the air vents

3. Use the physical air vent knobs to adjust the air vents and the airflow.

To close an air vent, press the same vent again in the display.

If you only have one air vent open, you can't close it in the climate view. Instead, press **Climate off** to close the open vent.

 **Tip**

If you choose a specific air vent while auto climate mode is active, the climate system will change to manual mode. You can always go back to auto climate mode again by selecting **Auto** in the climate view.

4.3.4.2. Activating auto climate mode

When you activate auto climate mode, the climate system controls several of its functions automatically.



Tip

In auto climate mode, the climate system automatically adjusts the air flow towards the windscreen when needed.

1. Press the fan symbol  in the bottom bar and go to **Climate**.
2. Select **Auto**.
3. You can change the fans' power level if you prefer.

4.3.4.3. Activating manual climate mode

If you activate manual climate mode, you can set your preferred airflow direction and choose the fans' power level.

1. Press the fan symbol  in the bottom bar and go to **Climate**.
2. Select **Manual**.
3. Choose your preferred airflow direction and the fans' power level.

4.3.5. Ice, condensation and defrosters

In cold conditions, ice and condensation can obstruct visibility. Your car is equipped with defrosters, a heated rear windscreen and heated wing mirrors to prevent that from happening.

There are defrosters placed by the windows and windscreens. The wing mirrors heat up at the same time as the rear windscreen. Combined, these functions aim to ensure good visibility.



4.3.5.1. Activating max defroster

To quickly remove condensation and ice from the front windscreen and windows, you can activate max defroster.

Max defroster raises the temperature and fan speed. Air conditioning is activated and air recirculation is unavailable while max defroster is active. When max defroster is turned off again, the climate settings return to their previous levels.

 **Note**

When max defroster uses the high fan speed, the noise level of the fans increases.



1. Press the fan symbol  in the bottom bar and go to **Climate**.
2. Press **Max defroster** .

 **Tip**

The defroster button  in the overhead console also activates max defroster.

4.3.5.2. Activating rear windscreen and wing mirror heating

Activate the rear windscreen and wing mirror heating to get rid of condensation and ice.

1. Press the fan symbol  in the bottom bar and go to **Climate**.
2. Press **Rear defroster** .

4.3.6. Interior climate when parked

Your car can maintain a comfortable interior climate when parked. You can also precondition your car so that the passenger compartment is prepared for your next trip.

 **Note**

The parking climate functions automatically turn off when the maximum running time is reached or the car's battery level is too low.

Preconditioning

Preconditioning automatically activates the auto climate mode to heat up or cool down the passenger compartment to a comfortable temperature before you enter the car.

You can schedule a single or recurring preconditioning timer in the display, or via the mobile app for the car. Preconditioning automatically deactivates when you enter the car or when the scheduled time is reached.

For preconditioning to be available, the traction battery must be sufficiently charged. If preconditioning is started when your car is not connected for charging, the car's range will be affected.

Note

When preconditioning in a hot climate, condensation might drip under the car. This is normal.

Tip

In colder weather, your car's seat and steering heating activates automatically during preconditioning.

Parking comfort

Parking comfort allows you to maintain a comfortable interior climate in your car while parked. This includes keeping the climate functions and the entertainment system on. You can activate the parking comfort function via the display. Just be aware that the car's range can be affected if you leave this setting on for too long.

4.3.6.1. Setting the preconditioning timer

You can set and activate a timer to precondition your car for a specific departure time. If you want to, you can set it to repeat on certain days.

If you choose to precondition the passenger compartment, the car will cool or heat it before your scheduled departure time.

The timer can be set to repeat on a weekly schedule or set for a single departure time.

1. Press the fan symbol  in the bottom bar and go to **Parking**.

2. Press the timer to open and modify it.

3. Choose a time when the preconditioning should be ready.

Activate **Repeat every week** and select one or more weekdays to set a repeating schedule.

4. Select **Save**.

> The timer is saved and activated.

4.3.6.2. Activating parking comfort

You can activate the parking comfort function to maintain a comfortable climate in the car while you are away from it.

Warning

Never leave a child or pet unattended in your car. You are responsible for their safety and well-being. Some regions have laws prohibiting people or pets being left inside a locked vehicle.

Note

The parking comfort function will automatically turn off when the maximum running time is reached, the car's battery level is too low or you start a new drive cycle. If you activate it when your car's battery level is already low, the maximum running time will be less.

1. Press the fan symbol  in the bottom bar and go to **Parking**.
2. Go to **Parking comfort**.
3. Select **Start**.

Press **Stop** to turn it off again.

4.3.7. Air quality

Your car is designed to provide a pleasant and healthy interior climate. Air filtering helps to remove odours, substances and particles from the passenger compartment.

Passenger compartment air filter

The air going into the passenger compartment is first filtered through the climate control system. To ensure high performance, the filter needs to be replaced regularly. If the filter is exposed to intense use, such as prolonged driving through areas of smog or dust clouds, the filter needs to be changed more frequently. If you are uncertain about what kind of filter to use, contact Volvo support.

Air quality system

The air in the passenger compartment is purified by:

- filtering out allergy and asthma-inducing substances.
- removing gases and particles to reduce odours.

- removing air contaminants such as particles.

If the air quality sensors detect contaminants in the outside air, the air intake closes and internal air recirculation activates.

4.3.7.1. Air quality indication

In the display's climate view, you can find information about the air quality inside the car.

In the climate tab, the colour and number following the dot indicate the AQI ^[1] value inside the car.

The air quality tab shows more information, including the detailed AQI and the actual concentration of airborne particles. A sensor measures the content of particles smaller than 2.5 µm in the passenger compartment.

^[1] Air Quality Index

4.3.7.2. Activating air recirculation

Air recirculation helps you keep out harmful or foul-smelling air from the passenger compartment. In some cases, it's activated automatically but you can also activate it manually in the climate view.



When air recirculation is not manually activated, the climate system automatically decides whether to recirculate the air depending on certain environmental conditions. These include the temperature inside and outside the car as well as the air quality outside. You can also manually activate constant air recirculation to close the air intake if you want to.

Important

If the air is recirculated for a long period of time, condensation can fog up the windows, which can affect visibility.

Note

Air recirculation is unavailable while max defroster is active.

1. Press the fan symbol  in the bottom bar and go to **Climate**.
 2. Press the recirculation symbol .
-

4.3.8. Climate system

Your car's climate system aims to provide everyone in the car with a comfortable environment using electronic climate control.

All climate control system functions are controlled via the display.

Your car uses sensors to automatically control different capabilities that are designed to offer a comfortable interior climate at all times.



Tip

Most climate functions can also be controlled using voice control. Most features require an internet connection for voice control use.

4.3.8.1. Climate zones

Your car's passenger compartment is divided into different climate zones. These zones enable passengers to set their own preferred temperature to enjoy a comfortable environment.

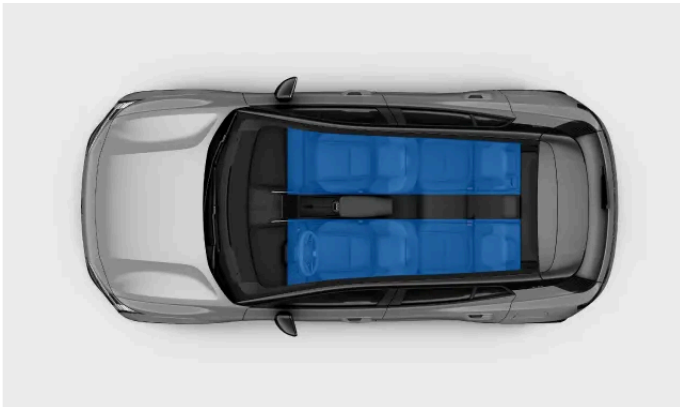

Available climate zones.

There are two different climate zones in your car's passenger compartment. All zones are directly synced to the driver's preferred climate settings by default. However, each zone can have its own individual temperature setting.

4.3.8.2. Perceived and actual temperature

Your temperature perception is affected by more factors than the actual temperature of the air around you. Knowing the difference between perceived and actual temperature can benefit your climate comfort experience.

Whether the air in your car feels warm or cold depends on its temperature as well as several other factors. These factors include your own body temperature, airflow and humidity in the car, and whether you're exposed to direct sunlight. When you adjust

the temperature setting, the car considers some of the factors contributing to your perceived temperature. The car then continuously adapts its climate functions to make the interior climate feel like the temperature you selected, regardless of any changing conditions. This means that the actual temperature in your car can differ from the temperature you selected to give you a more consistent climate comfort experience.

4.3.8.3. Climate sensors

There are several climate sensors located inside and outside of your car. These sensors help to provide a comfortable climate in the passenger compartment.

For the interior sensors to be able to perform as intended, it's important that you don't cover them.



- ① Sunlight, rain and humidity sensor in the rear-view mirror console.
- ② Passenger compartment temperature sensor, located behind the dashboard panel on the driver's side next to the glove box.
- ③ Airborne particulate matter sensor, located under the speaker cover on the passenger's side.

The exterior ambient temperature sensor is located in the right wing mirror.

4.3.8.4. Heaters

If the ambient temperature is lower than the temperature you prefer in your car, the heating system can help provide a comfortable interior climate.

Electric heater

The electric heater is powered by the car's traction battery. It is used to heat the battery and for heating the passenger compartment during preconditioning.

If the charge level in the traction battery is too low, the heater will switch off.

Heat pump

The heat pump works primarily as a range extender. In low temperatures, the heat pump helps to heat up the passenger compartment while using less energy compared to the electric heater, which extends the battery's power availability. The heat pump operates during both preconditioning and driving. It also helps to maintain the traction battery at its desired operating temperature, which enhances performance.

4.4. Windows and glass panes

Your car has several different windows and glass panes. Some of them are laminated for added safety and security. The lamination also provides better sound insulation in the passenger compartment.

There are four power operated side windows in the car, one for each door.

The rear windows are fitted with privacy glass, which restricts the view from outside the car and reduces glare.

Panoramic roof

Your car's panoramic roof has an infrared coating which helps to keep the passenger compartment cool in sunny conditions.

Note

Be sure not to use tinted film with a metallised surface coating on the rear windscreen. This can cause problems with signal reception as this is where the antenna is located.

4.4.1. Operating the windows

You can use the power switches on the front and rear ends of the centre armrest to operate the windows.

The power windows may still work for a while after you exit the car. Keep this in mind when leaving the car unattended.

Warning

Always consider the safety risks while operating the windows. The car's moving parts can cause injury to children or other occupants, as well as damage to objects.

- Make sure you have a clear view of the windows you operate.
- Do not allow children to play with the window controls.
- Never leave children alone in the car.
- Never put an object or body part through an open window, even if the car's electrical system is fully disconnected.

All of the windows have built-in pinch protection to help prevent injuries. Be sure to read the relevant information on pinch protection in a separate section of the manual.

i Note

Situations where the windows cannot be opened

- The windows cannot be opened at speeds above approximately 180 km/h (112 mph) but they can be closed.
- At very low temperatures, the windows might freeze in place and you won't be able to operate them.

Operating windows from the front seats

1.



From the front seats, you can control all of the power windows. Press the button with the text REAR to switch between operating the front or rear windows. The button turns amber to indicate that the rear windows are selected. The controls will switch back to the front windows if you press the button again or after a few seconds of inactivity.

Operating the windows from the rear seats

2.



From the rear seats, you can operate the rear windows using the switches on the rear end of the centre armrest.

3. Use the switches to open or close the windows:

- A slight push or pull allows you to manually operate the window until you release the switch.
- If you push or pull the switch fully, the window moves automatically even if you release the switch. Stop it by moving the switch in the opposite direction.



Tip

Noise reduction

One way to reduce the noise of the wind when the rear windows are open is to also open the front windows slightly.

Close by locking

If you want to close all the windows at the same time when you lock the car, you can enable this feature in the settings. Look up automatic window closing in this manual for more information.

Locking the rear windows

You can disable the rear window controls in settings. This prevents rear seat passengers from operating the windows.



Note

If automatic window movement or pinch protection isn't working properly, you may need to reset the windows. You can learn how to do this in a separate section of the manual.

4.4.1.1. Locking the rear windows

You can lock the rear power windows via a setting in the display. This can be important to consider when driving with children in the rear seats.



Important

Child lock

Locking the rear windows does not affect the door locks. If you want to prevent rear seat passengers from opening the doors, read more about the child lock in a separate section in this manual.

When driving with children in the rear seats, check that the rear doors are secured with an active child lock.

1. Press the car symbol  in the bottom bar and go to **Settings**.
2. Go to **Controls** → **Locking** → **Lock rear power windows**.
3. Turn on to lock the rear windows.

4.4.2. Pinch protection

The content of this manual represents the status of the user manual at the time of printing and may not be completely valid in future instances. For more information, refer to the first page for the complete disclaimer note.

To help prevent injuries from power-operated windows and other moving parts, your car has a built-in pinch protection system. Occupants should also keep proper user practices in mind to reduce the risk of getting caught between moving or closing parts.

If something is blocking the window when it is closing, the window will stop and then slightly reverse, allowing you to remove what's in the way.

 **Warning**

Always consider the safety risks while operating the windows. The car's moving parts can cause injury to children or other occupants, as well as damage to objects.

- Make sure you have a clear view of the windows you operate.
- Do not allow children to play with the window controls.
- Never leave children alone in the car.
- Never put an object or body part through an open window, even if the car's electrical system is fully disconnected.

If the automatic closing of a window stops due to obstructions, such as ice, you can still try to close the window manually by continuing to pull the control switch. However, always try to remove the source of the obstruction first and make sure nothing is blocking the path of the window before trying to close it again.

If there is a problem with the pinch protection, you can try to solve the issue by resetting the windows.

 **Warning**

The power window pinch protection may not work properly if the car loses track of the current window position. The window positions are recalibrated when you reset the windows. Always reset them to make sure the window positions are correctly calibrated if:

- the car has lost power, for instance if the 12 V battery has been disconnected.
- the automatic window movement does not work properly.

This restores the automatic window movement and re-enables the pinch protection function.

4.4.3. Resetting windows

If you're experiencing issues with the power-operated windows, you need to reset them. This allows the car to recalibrate their position, restoring both pinch protection and automatic movement.

 **Important**

The pinch protection system will not work properly until the window has been reset after losing calibration.

1. Lightly pull the window switch until the window is completely closed and then continue to hold for at least two seconds.
 2. Lightly press the switch until the window is completely open and then continue to press for at least two seconds.
 3. Lightly pull the switch again until the window is completely closed and then continue to hold for at least two seconds.
- > Recalibration is now done, re-enabling both pinch protection and the automatic window movement.

If the problem persists, contact an authorised Volvo workshop.

4.5. Seats

The seats are all designed to provide comfort and safety. Adjust the seats, headrests and other comfort functions, and make sure to sit properly.



The seats of the car have a range of features to provide comfort, safety and flexibility.

In this section of the manual, you'll get to know the comfort features and adjustments available for the car seats. This includes features such as the front seats' positional adjustments and how to fold the rear seats to get more space for stowing. At the same time, you will learn the essentials of how to use these features safely and properly.

For more information about the passive safety functions of the seats and to learn how to accommodate them through proper seating, there is a separate safety section in this manual.

4.5.1. Front seats

The front seats have plenty of adjustability to increase comfort.

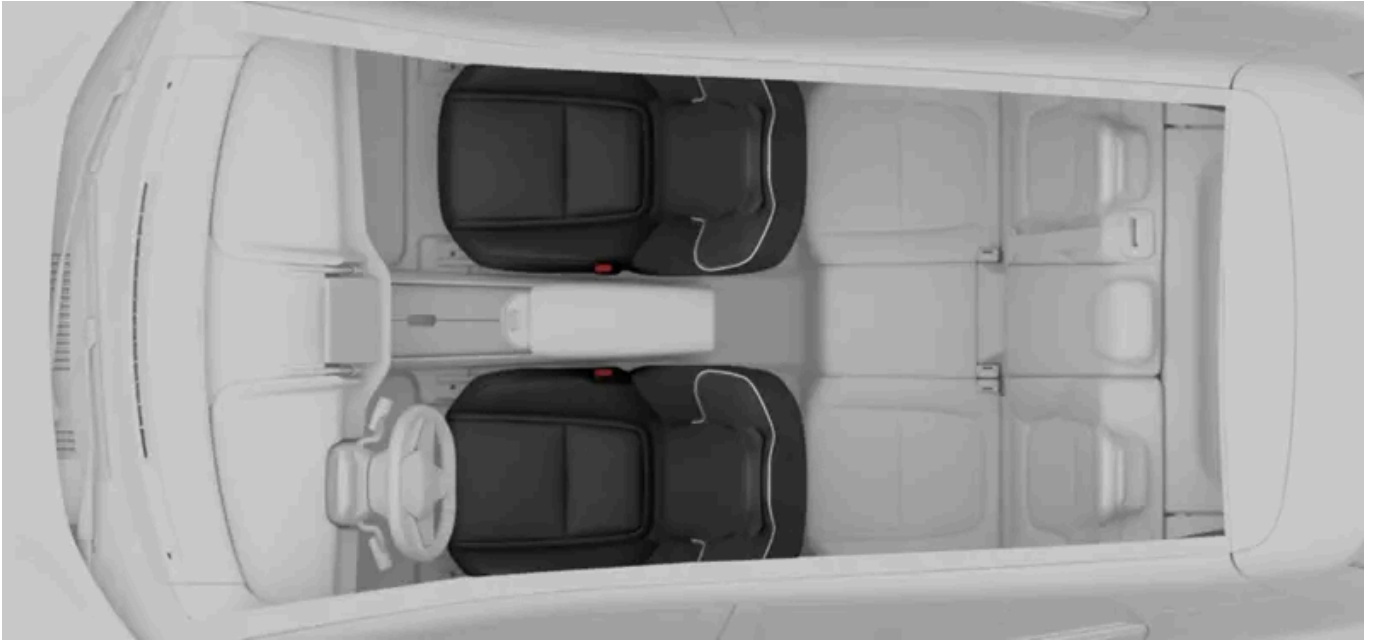

Adjustability

The power seat adjustments are divided into separate adjustment modes:

- Basic adjustments** Height and position of the seat as well as backrest tilt.
- Tilt adjustments** Seat cushion tilt.
- Lumbar adjustments** The driver seat also has access to lumbar support height and depth adjustments.



Tip

Seat adjustment knob

All power seat adjustments are done using the knob on the side of the seat. When you press the centre button, the seat adjustment view appears in the display to guide you.

Seat heating

The front seats have three levels of heating to choose from.

4.5.1.1. Adjusting front seats

Adjust the front seats with the seat adjustment knob. You can find this on the side of the seat closest to the door.

Seat adjustment knob



The seat adjustment knob can move up and down, forward and backward, as well as rotate in both directions. In the middle of the knob there's also a button you can use to change the active adjustment mode.

There are lots of different changes you can make to the seats. To control them all with the adjustment knob, the available changes have been grouped into separate adjustment modes. Each mode is visually represented in the display to guide you while adjusting the seat.

 **Warning**

Never adjust the seat while driving. This can cause dangerous distraction and loss of control. Instead, be sure to make all necessary adjustments to the seat before starting a drive.

Adjusting the seat

1. Start by pressing the button on the adjustment knob.
 - > The seat adjustment view appears in the display.
2. To cycle through the different adjustment modes, press the button on the knob repeatedly.
3. Rotate or move the knob to adjust the seat according to your preference.
 - > The visual guide in the display indicates which part of the seat you are adjusting.



Tip

Quick adjustments

You can also customise the seat without visual guidance from the display. Just move or rotate the seat adjustment knob to start adjusting. Note, however, that only the basic adjustment mode is available this way.

Saving a preset seat adjustment

If you have adjusted your seat position, the display shows a notification where you can save the adjustments to your profile. When you save a preferred seat position, your car automatically saves your current positions for the wing mirrors.



Note

Adjustment lock

If you move the adjustment knob an excessive number of times within a short timeframe, the knob becomes unresponsive for 20 seconds. This is to prevent unintentional use of the adjustment knob.



Important

Once you've finished adjusting the seat to your liking, it's important to make sure other parts of the car are aligned correctly. Your driving posture is important and is affected by more than your seat adjustments, such as the position of your steering wheel and mirrors.

4.5.2. Rear seats

You can adjust the rear seats to get more space or to provide more comfort.

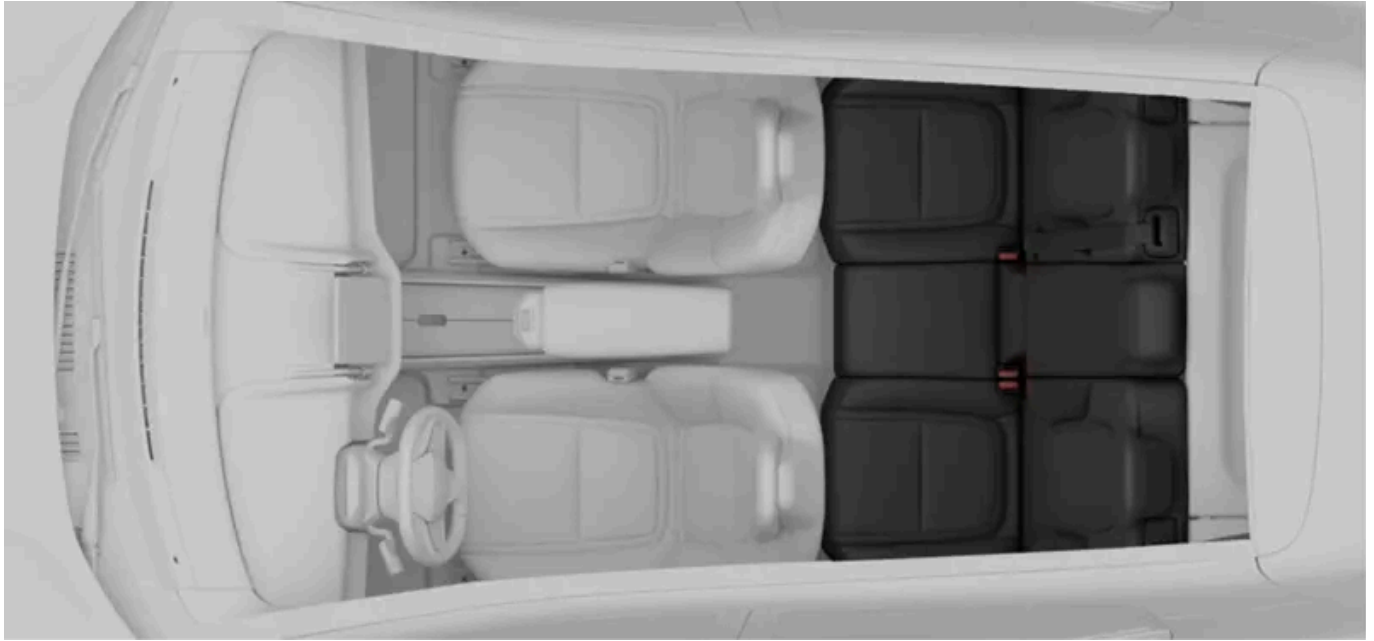

The rear seats have the following features:

- Adjustable and removable headrests** The rear seats have adjustable headrests. They can be raised or lowered to better support your head. You can also remove the headrests for more space when folding the seats.
- Foldable backrests** You can fold the rear seats to create more cargo space. The left seat can fold on its own whereas the centre and right seats fold together.



Tip

Small item storage

There is a pocket for storing small items on the side closest to the door of each outer seat.

4.5.2.1. Adjusting rear seat headrests

All three rear seats have adjustable headrests. The headrest should be adjusted according to your height and fully support back of your head if possible.

A correctly adjusted headrest can help prevent neck injury during collisions. It's important to align the headrest to cover as

much as possible of the back of the head.

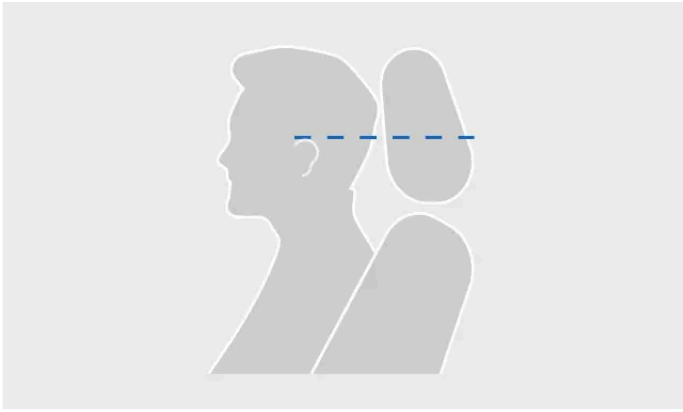

Correct headrest level

Upward movement of the headrest is not locked.

1. Pull the headrest upwards to a level that fits your height.

To lower the headrest, press and hold the button at the base of the right support to release the lock. Then, carefully push the headrest down.



Locking button on the headrest

i Tip

Make a habit of lowering the headrest when the seat is not used. When it's down, it doesn't risk obstructing the rear view.

4.5.2.2. Removing rear seat headrests

If you need more room to fold the rear seats, you can remove the seats' headrests.

There are two buttons involved when removing the headrests. The first button is located on the base of the right headrest support. This is the same button you use to adjust the headrest height. The second button is smaller and located on the base of the left support. This button is integrated into a larger button.

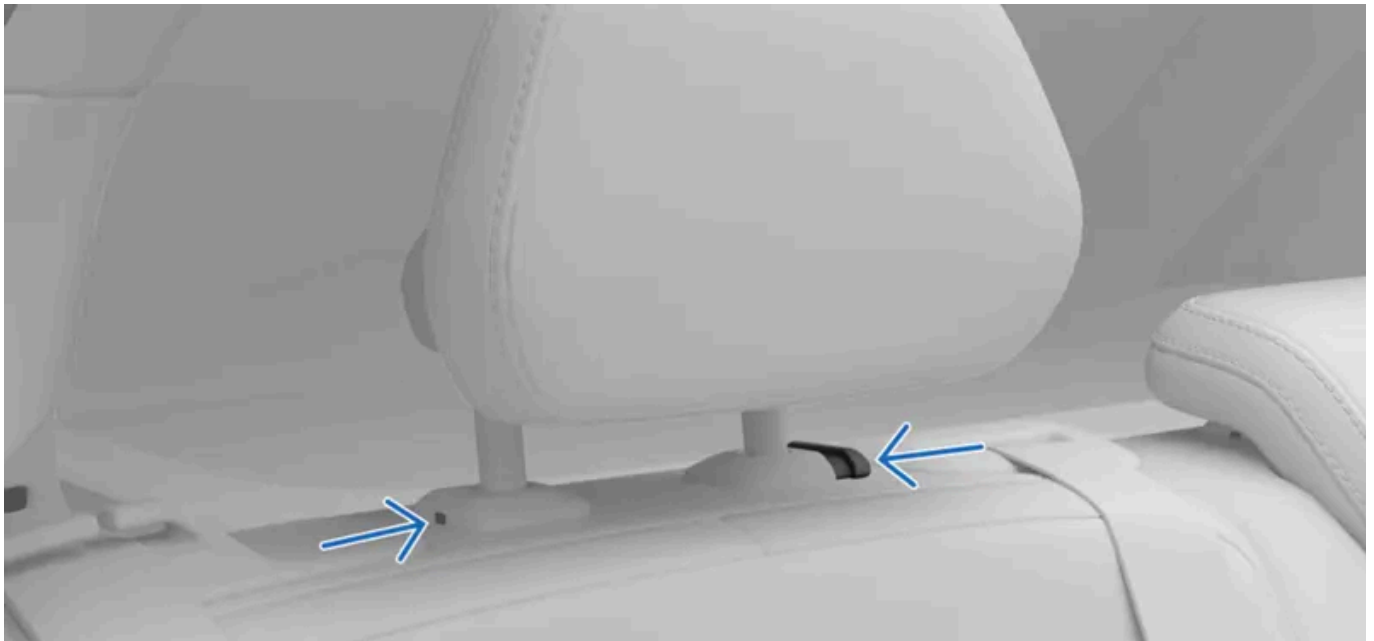

Buttons used to remove headrest.

1. Press and hold both buttons on the support bases.
2. Move the headrest upwards until it detaches from the seat.

 **Warning**

Never drive with a passenger sitting in a seat without an attached and properly adjusted headrest. This can lead to fatal or serious personal injury.

Make sure to stow the removed headrests properly while the rear seats are folded down. Always reattach the headrests once you raise the seats again.

4.5.2.3. Folding down the rear seats

You can fold the rear seats with a button on the seat backrest. The left seat can be folded on its own while the centre and right seats fold together.

! Important

Before folding the seats, make sure:

- there are no objects on the seats.
- the seatbelts are not buckled.
- there is enough space to fold the seats down. If needed, move the front seats forwards and adjust or remove the rear seats' headrests.

! Warning

If any of the rear seats are folded down, they must not be in contact with the seats in front. This can impede the safety of other occupants.

1.

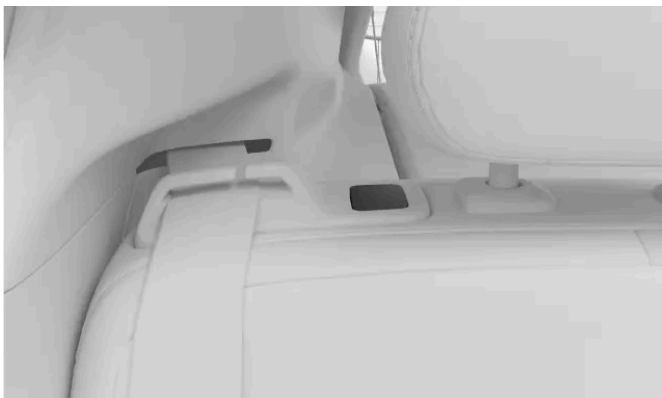

Press the button on the seat backrest.

> The seat releases and folds forwards.

Manually push the backrests to their upright position when you no longer need the extra cargo space. Make sure they lock into place.

4.6. Interior lighting

The lights in your car's passenger compartment provide illumination for different purposes. There are lights for reading as well as for general illumination and lighting up storage areas.

Reading lights

The front and rear seats have reading lights. You can adjust their intensity to suit your needs. In the rear seat, the reading lights also work as general lighting.

General illumination

Your car has lights to provide general illumination of the passenger compartment, such as when you get into the car. General illumination can be activated both manually and automatically.

Ambience lights

The passenger compartment also has ambience lights to provide comfortable illumination when it's dark outside. The lights can be adjusted in terms of both intensity and colour theme.

Storage area lights

There are lights in different storage areas, such as the boot, to make it easier to find what you're looking for.

4.6.1. Adjusting the reading lights

There are reading lights available for the front and rear seats. You can adjust the brightness according to your needs.

The front seat reading lights are located in the overhead console and the rear reading lights can be found over the rear doors.



The front seat reading lights in the overhead console



Rear seat reading lights

- Press the button next to your reading light to turn it on and off. The button is marked with a reading light symbol.



- Hold the button down to adjust the brightness.



Tip

Turning all reading lights on

You can turn all reading lights on at the same time in settings.

4.6.2. Adjusting interior lights

You can adjust the interior lights in the lights and displays section of the settings.

1. Press the car symbol  in the bottom bar and go to **Settings**.
2. Go to **Controls** → **Lights and displays** → **Interior lights**.

Selecting light colour

3. Go to **Neutral ambience colour**.
4. Select which colour the neutral light should be. Choose between white light or light matching the interior of your car.



Tip

The brightness of both the neutral light and the ambience light themes can be adjusted in the ambience settings. You can read more about the ambience light in a separate section of this manual.

Adjusting button brightness

5. Go to **Button brightness**.
6. Adjust the backlight brightness of the car's physical buttons.



Tip

Courtesy light

If the courtesy light feature is enabled, the interior lights will temporarily turn on when you enter the car. The extra light can be helpful while getting seated when it's dark outside. You can enable or disable the feature in the lights and displays section of the settings.

Turning all reading lights on

You can turn all reading lights on at the same time in the lights and displays section of the settings.

4.6.3. Adjusting ambience lighting

The ambience lighting in the car can provide comfortable illumination of the passenger compartment. There are several colour themes to choose from along with matching ambient sounds.

1. Press the car symbol  in the bottom bar and go to **Quick controls**.
2. Press the ambience symbol.



- > The ambience view appears.

Selecting theme

3. Select one of the colour themes in the bottom of the ambience view or select Off to use neutral static light.



Tip

Even if there is no active theme selected, you can still change the colour of the neutral light. It can either be white or match the colour of your car's interior. To change this setting, go to **Controls** → **Lights and displays** in settings. You can read more about adjusting the interior lights in a separate section of this manual.

Adjusting light brightness

4. Press the brightness symbol.



5. Adjust the brightness to your preference.

Enabling ambience theme sound

6. Press the sound symbol to turn sound on and off.



Note

There is a dedicated sound loop for each ambience theme. The ambient sound is designed to be unintrusive and will temporarily turn off while you are in a phone call. If you start playing music, it will completely turn off and has to be actively turned on again in the ambience view.

5. Safety

Get to know your car's collision protection features such as airbags and seatbelts, and what's required for safe use.

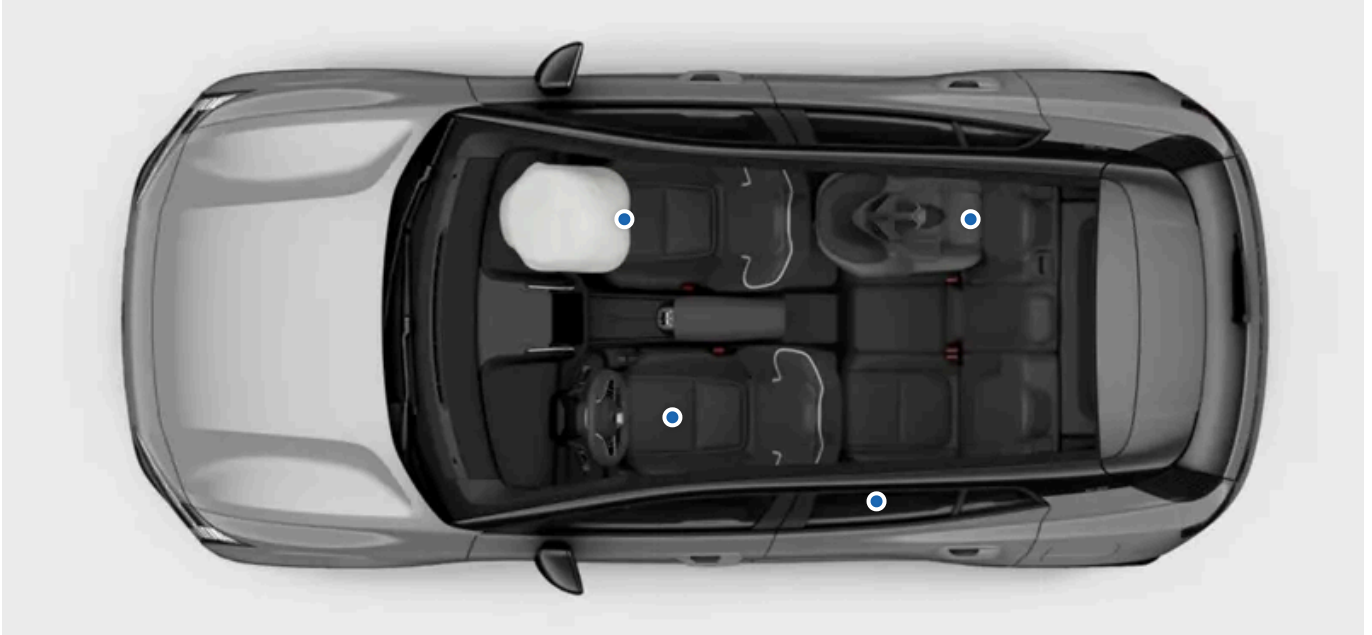

The safety section describes features designed to reduce the risk of serious injury in the event of a collision. They include seatbelts, airbags, child restraints and other features that can help save lives when used correctly.

Your car is designed to promote and provide the conditions for safe use. Safety features never replace the need for safe user practice. This applies to features directly related to safety, but also to the rest of your car. It's your responsibility to use the car's functions safely.

Warning

Safety synergy

The safety features are designed to work together to increase the safety of all occupants in the car. No feature replaces the need for another unless the user manual explicitly states so. For example, the presence of airbags in no way reduces the need to wear a seatbelt.

SRS warning

Sensors in the car can detect if there is something wrong with the airbags or related safety systems. A warning symbol will appear in the driver information area of the display to alert you if any faults are found.



SRS warning symbol

If the SRS warning symbol appears, immediately contact an authorised Volvo workshop.

 **Note**

Start-up checks

Several safety systems are part of the car's start-up check. Address any indicated faults.

Safety-related areas

Some driver support functions are related to safety. Instead of keeping you safe in the event of an accident, they are designed to prevent them in the first place. Get to know those functions as well for a safer trip.

5.1. Collision response

In the event of a collision, your car has many features designed to help mitigate the effects. Your car's response to a collision happens before, during and after the impact.

 **Tip**

You can find information related to collision response in many places throughout this manual. Therefore, this section exists to provide a more cohesive overview of your car's capabilities in this area.

Before

Before an impact, several driver support functions can work to avoid the collision or reduce its effects. If the car perceives a collision to be likely or unavoidable, it has the ability to pre-emptively activate protective systems before the impact occurs.

During

During the collision, sensors throughout the car continuously provide information about the states of the car and its occupants. The car uses the information to selectively time and activate protective functions such as airbag deployment and seatbelt pretensioning. Collisions are complex events that can unfold in several stages, where the first impact isn't necessarily the most severe. Good timing is essential for the best chance of effective protection.

The car's safety systems work in synergy with passive safety features. In the event of a collision, your car's construction distributes forces to specific structural components. It also takes advantage of crumple zones that absorb energy from the impact. Using similar principles, the exterior has been designed with the protection of pedestrians in mind.

After

After a collision, the car tries to stop in a controlled and safe manner. It can also make an automated call for emergency response.

 **Note**

Safety mode

The car can enter safety mode after certain collisions even without airbag deployment. The traction power supply is cut off in safety mode and the car cannot be driven.

Do not try to move the car in safety mode. If the car poses an acute traffic hazard and is able to move, an exception can be made to move it a short distance out of immediate danger. Tow mode needs to be activated before towing the car.

 **Important**

Your car is designed around safety, but no protective system is 100% effective in all situations. Safety features never replace the need for safe user practice.

5.2. Occupant detection

Your car can remind you not to leave anyone or anything important in the car when you leave it.

Presence warnings

By default, your car alerts you if it detects that passengers or pets are still in the car after you lock it.

When this happens, you receive a mobile app notification and the car signals using the horn and exterior lights. You can turn these warnings off temporarily in the locking settings.

 **Note**

Double lock

Double lock is an anti-theft feature that prevents your car from being unlocked from the inside. For safety reasons, the car won't double lock when it detects passengers inside the car. This is to ensure that any remaining occupants in the car can exit safely in the event of an emergency.

 **Warning**

Volvo recommends not leaving people or pets in a locked car.

Some regions have laws prohibiting people or pets being left inside a locked vehicle.

5.3. Proper seating

Appropriate seating and proper seatbelt use are essential for the safety and comfort of everyone in the car. There are also specific recommendations for pregnancy and child seating.

! Important

Importance of proper seating

Safety features, such as seatbelts and airbags, require that all occupants are properly seated for the best chance of effective protection in a collision. Failure to follow the seating instructions can endanger life or lead to serious injury.

Pregnancy

Take extra care to follow all seating recommendations if the occupant is pregnant. The following are either additions or of extra importance:

- Make sure that the seatbelt does not cross the belly. The hip strap should be under it and the shoulder section should pass above it.
- If seated in the driver's seat, avoid sitting closer to the steering wheel than necessary. Adjust the seat to create as much distance between the belly and wheel as possible while also keeping all driver controls comfortably within reach.

Child seating needs

Always seat children with extra care and attention to their needs. Make sure you have the required child restraint, that it's installed correctly and that the child remains safely seated throughout the entire trip. For children travelling forward-facing, the same seating recommendations apply as for adults. Always make sure the seatbelt is properly adjusted and that the headrest is at a height suitable for the child when possible.

i Note

Physical limitations

Physical limitations can prevent an occupant from following the seating recommendations. The car may need modifications to accommodate safe use. Contact an authorised Volvo workshop for information about Volvo-approved modifications.

Sitting posture

Both sitting posture and proper seatbelt adjustment are important for safety. Avoid irregular sitting postures.

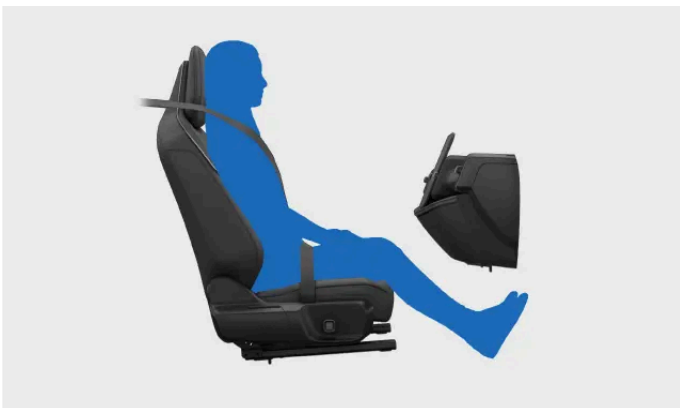

A correctly seated occupant. Do not adopt other postures when the car is moving.



Do not slide forward in the seat. The lower back should have contact with the backrest.



Keep both feet planted on the floor.



Do not fold the backrest to a lying position. The seatbelt must remain tensioned against the shoulder.

Proper headrest use

Proper headrest use is essential to reduce the risk of neck injuries in a collision. All of the car's headrests are designed to help protect the head and neck when used correctly.

- Keep the back of your head against the headrest.
- Make sure occupants have correctly adjusted headrests where possible.

5.4. Seatbelts

When you use seatbelts correctly, they can help prevent serious injury in situations ranging from sudden braking to severe collisions.

Seatbelt features



The seatbelt locks itself to act as a safety restraint under certain conditions. They include sudden and forceful pulling of the belt, if the car is driven aggressively and if the car is on a steep incline.

Seatbelt reminder

The car uses built-in sensors to detect if the driver or any of the passengers aren't using their seatbelts. The system alerts the driver with a warning sound and the seatbelt reminder symbol appears in the display.



Seatbelt reminder symbol.

 **Important**

Wearing seatbelts

These are the essentials for wearing seatbelts properly. There is also more detailed information in other sections of the manual covering proper seating and seatbelt adjustments.

- Make sure that everyone in the car wears their seatbelt and that all belts are properly adjusted.
- Adjust the seatbelt for the wearer's size.
- Wear the seatbelt closely against the body.
- Minimise slack in all belt segments.
- Allow the belt to run as straight as possible between its three anchor points.^[1]
- Have the backrest in an upright position.
- Follow all seating and posture recommendations.^[2]
- Do not wear the seatbelt in ways other than those described in this user manual.
- Always use seatbelts when driving.
- Never use the same seatbelt for more than one individual at a time.

 **Warning**

Seatbelt care and maintenance

- Never modify or repair seatbelts or related parts such as fittings and hooks yourself. Any service or replacement must be done by a trained technician with access to type-approved parts.^[3]
- Contact an authorised Volvo workshop if the seatbelt or a related part shows signs of damage or wear.
- Replace the seatbelt if it has been subjected to a heavy load, such as in a collision. It may have lost protective properties even if there is no apparent damage.
- Clean the seatbelt as soon as possible if anything is spilled onto it. The spilled substance can enter the mechanism and deteriorate the material.

^[1] For example, never wrap around or attach it to other items or fittings in the car.

^[2] There are general seating recommendations as well as specific recommendations for children and pregnant occupants.

^[3] Volvo recommends an authorised Volvo workshop.

5.4.1. Fastening and adjusting seatbelt

A correctly fastened and adjusted seatbelt is important for your safety as well as comfort.



Correctly fastened and adjusted seatbelt.

i Note

These instructions apply to adults and children who are seated normally or are using a booster seat or booster cushion. Read the separate section covering child safety for detailed information about child seating and different types of child restraints.

Before fastening the seatbelt on an outer rear seat, make sure the belt is running flat through the seatbelt guide on top of the backrest. If the seatbelt has made its way outside of the guide, reinsert it through the gap.

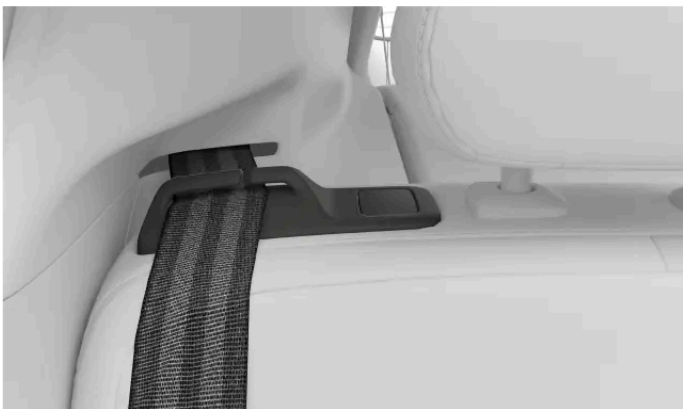

Seatbelt guide

! Important

Leaving the seatbelt outside the guide during fastening can cause the belt to shift position. This could have a negative impact on passenger safety or comfort. It can also lead to retracting-issues, which in turn might damage the belt over time.

Fastening the seatbelt

1. Pull the seatbelt out by the latch plate. If you pull too fast, the locking mechanism will engage.
2. While extended, check the belt for twists, knots or damage.

The content of this manual represents the status of the user manual at the time of printing and may not be completely valid in future instances. For more information, refer to the first page for the complete disclaimer note.

3. Insert the latch plate into the buckle.

> The latch plate clicks into place.

 **Warning**

Check when seatbelt is fastened

- The seatbelt should run directly and as straight as possible between its three anchor points. Any unnecessary slack increases the risk of injury.
- Make sure everyone in the car is wearing their seatbelt correctly.

Adjusting the seatbelt

4. For occupants in the front seats, adjust the height of the seatbelt's upper anchor point.

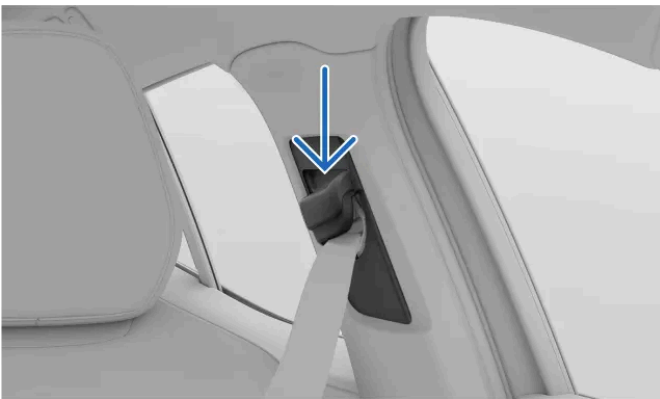

Seatbelt upper anchor point

Hold the button on the upper anchor point down to allow it to slide up and down.

Place it as high as possible without the belt touching the throat or neck.

5. Tension the hip strap to remove slack by pulling upwards on the diagonal chest strap. It should be as straight and low as possible, running below the abdomen.

 **Important**

Pregnancy

Take extra care to follow all seating recommendations if the occupant is pregnant. Make sure that the seatbelt does not cross the belly. The hip strap should be under the belly and the shoulder section should pass above it.

Releasing the seatbelt

6. Release the seatbelt by pressing the buckle button.

7. Guide the seatbelt back to its retracted position.

 **Important**

Make sure the seatbelt retracts fully after using it. Closing a door with the seatbelt caught in the gap can damage both the seatbelt and the door.

5.4.2. Seatbelt reminder

The car uses built-in sensors to detect if the driver or any of the passengers aren't using their seatbelts.

If the car detects any occupants that are not wearing their seatbelts, the system alerts the driver with a warning sound and the seatbelt reminder symbol appears in the display.



Seatbelt reminder symbol.

You can find information about which seatbelts aren't fastened in the driver information area of the display.



Car overview in the display.

If the reminder appears, buckle the indicated seatbelts as soon as possible in a safe manner. Stop the car, if necessary, to avoid distracted driving.

In some cases, the sensors may mistake an object on the seat for a passenger and alert you if the seatbelt hasn't been fastened. If you dismiss these reminders in the display, the large graphic will disappear but the other warning indicators will remain active. Buckle the seatbelt to remove them.



Always make sure everyone in the car wears their seatbelt.

5.5. Airbags

There are several airbags that your car can deploy in a collision. They can help reduce the impact forces experienced by occupants.



The image shows a selection of available airbags. Continue reading for details on the airbags in your car.

The airbags are designed to work with the rest of the car's safety features. Their effectiveness especially relies on proper seating and seatbelt use. An airbag deployment is a sudden, forceful but controlled event that can significantly lower the risk of serious injury for correctly seated occupants.

 **Warning**

The airbags cannot work as intended if an occupant is incorrectly seated in the event of a collision. Always use seatbelts.

Sensors throughout your car allow it to deploy different airbags based on information about the collision itself, as well as the status of the car and its occupants.

Airbag types

Your car has the following airbag types:

- Front airbags** Frontal collision airbags for the front occupants.
- Side airbags** Seat-integrated side-on collision airbags for the front occupants.
- Inflatable curtains** Ceiling-mounted airbags for occupants seated by a window.

5.5.1. Airbag deployment

If an airbag has deployed, your car needs to be recovered and serviced.

When the car deploys an airbag, it inflates almost instantly with considerable force accompanied by a loud noise. After that point, it behaves differently depending on the type of airbag. The front and side airbags deflate as they are compressed and

The content of this manual represents the status of the user manual at the time of printing and may not be completely valid in future instances. For more information, refer to the first page for the complete disclaimer note.

provide controlled cushioning for a single severe impact. The inflatable curtains stay inflated longer to protect against repeated impacts.

 **Warning**

Airbag-related injuries

No safety feature can prevent all possible injuries in a collision. The airbags are designed to reduce the risk of severe injuries. Impacting an airbag often results in some form of injury, and several factors affect the type and severity of the injury. Reading the user manual allows you to recognise and avoid practices known to increase the risk of injury.

To reduce the risk of airbag-related injuries in a collision:

- Follow the user manual's instructions for proper seating and use of seatbelts.
- Learn the placement of all airbags and how they affect the use of your car.
- Do not store or place any objects in the airbag deployment areas.
- Do not make any modifications to the interior or electrical systems of your car that are not approved by Volvo.

 **Note**

Deployment conditions

Not all airbags may deploy in a collision. This is because different airbags require different conditions and forces to deploy. The severity of damage to the car after a collision is not a reliable indicator of whether any airbags should have deployed.

Airbag gases and smoke

- The gas inside an airbag contains smoke that releases into the interior compartment when the airbag deflates.
- Always be attentive to signs of fire after a severe collision, but keep in mind that some smoke is normal if an airbag has deployed.

After airbag deployment

After a collision in which the airbags have deployed, prioritise the safety and medical needs of those involved in the accident. Before handling the car, contact an authorised Volvo workshop. Follow the user manual's instructions for safe handling and recovery of a car that's immobilised or in safety mode.

 **Important**

Safety mode

The car can enter safety mode after certain collisions even without airbag deployment. The traction power supply is cut off in safety mode and the car cannot be driven.

Do not try to move the car in safety mode. If the car poses an acute traffic hazard and is able to move, an exception can be made to move it a short distance out of immediate danger. Tow mode needs to be activated before towing the car.

5.5.2. Front airbags

The front airbags are designed to deploy in certain frontal collisions. The front passenger airbag can be disabled to accommodate certain rearward-facing child restraints.

The front airbags can help protect the driver and front passenger from severe injury if they are properly seated during a collision. The airbags on each side deploy independently of one another.

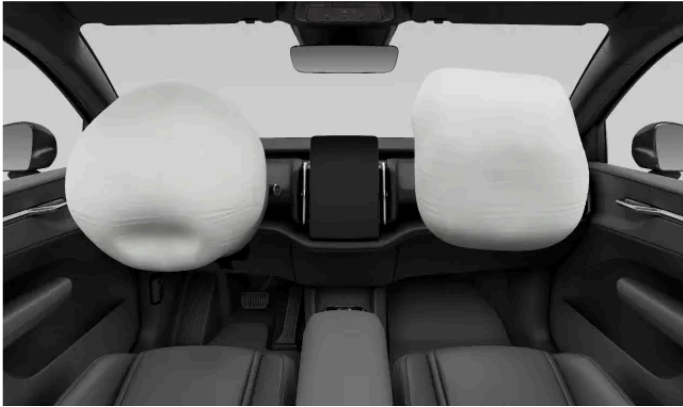

The driver side airbag is packed inside the steering wheel.

The passenger side airbag is packed behind a panel on the dashboard.

All front airbag locations are marked with the text AIRBAG or SRS AIRBAG.

Warning

Do not block the front airbags

- Do not place luggage, children or pets in the space between the seated occupant and the front airbags, including in the occupant's lap.
- Legs or feet must never be placed on the dashboard. This could endanger life or lead to serious injury.
- Do not place or mount any items on the dashboard. Even small objects can become dangerous projectiles in a collision and end up between inflating airbags and occupants.

Blocking airbags in general

Keep all airbag locations and expansion spaces free of obstructions. Obstructions can reduce airbag effectiveness and cause serious injury.

- Follow the instructions for a correct sitting posture.
- Properly stow luggage and other objects. The car has several luggage compartments for safe stowing.
- Do not modify or mount accessories to any panel covering an airbag or adjacent panels.

Passenger airbag switch

You can enable or disable the front passenger airbag using the airbag switch. This also controls the side airbag on the passenger side and the inner side airbag on the driver's side. The passenger airbag needs to be disabled before you install a rearward-

facing child restraint on the front passenger seat. Read all information about airbags and child safety before installing a child restraint.

Passenger airbag status

The passenger airbag status is shown in the overhead console.



This icon indicates that the passenger airbag is enabled and can be deployed by the car.



This icon indicates that the passenger airbag is disabled and cannot be deployed by the car.

Warning

Child restraints and front passenger seat

NEVER use a rearward facing child restraint on a seat protected by an ACTIVE AIRBAG in front of it, DEATH or SERIOUS INJURY to the CHILD can occur.

Tip

Read everything about airbags

There is more information about airbags and safety in general. Make sure you have read everything about these topics so that you understand the capabilities and limitations of your car's safety features.

5.5.2.1. Disabling and enabling front passenger airbag

To use a rearward-facing child restraint in the front passenger seat, you must first disable the front passenger airbag using the passenger airbag switch. When disabled, the airbag will not deploy in a collision. Read all information about front airbags and child seating before changing the passenger airbag status.

Switch location and positions



The airbag switch is located on the side of the dashboard and is accessible when the front passenger door is open.

It has two positions. They are marked with both symbols and text indicating whether the front passenger airbag is enabled or disabled.



Airbags enabled. Always use this position when a forward-facing passenger, child or adult, is in the seat.

In the position marked ON, the airbag is enabled and can be deployed by the car.



Airbag disabled. Always use this position when a rearward-facing child restraint is installed in the front passenger seat.

In the position marked OFF, the airbag is disabled and cannot be deployed by the car.

Changing the airbag switch position

The content of this manual represents the status of the user manual at the time of printing and may not be completely valid in future instances. For more information, refer to the first page for the complete disclaimer note.

1. Pull the switch outwards and turn it to position ON or OFF.
- > The display confirms the status change.
If set to ON, the message **Passenger airbag enabled (ON)** appears. The airbag is enabled.
If set to OFF, the message **Passenger airbag disabled (OFF)** appears. The airbag is disabled.

i Note

The overhead console always shows the current passenger airbag status. Make a habit of regularly checking it before driving, especially if a rearward-facing child restraint has been installed or removed recently.

5.5.3. Side airbags

The side airbags are designed to deploy in the event of a side-on collision.

The side airbags can help protect the driver and front passenger, if they are properly seated, in certain side-on collisions. The outer side airbag will typically only deploy on the collision side of each front seat. The inner side airbag, which is only fitted on the driver seat, will typically deploy in the event of a side-on collision on either side of the vehicle.



Side-on collision airbags for the front occupants.

The side airbags are packed into the sides of the seat's back frame. Both front seats have outer side airbags, but the driver seat also has an inner side airbag.

Both front seats have markings with the text AIRBAG.

 **Warning**

Do not block the side airbags

- Do not place any objects on either side of the front seats. Objects between the seats and the door panel, or between the seats and the tunnel console, can interfere with the side airbags.
- Do not use seat covers that have not been approved by Volvo.

Blocking airbags in general

Keep all airbag locations and expansion spaces free of obstructions. Obstructions can reduce airbag effectiveness and cause serious injury.

- Follow the instructions for a correct sitting posture.
- Properly stow luggage and other objects. The car has several luggage compartments for safe stowing.
- Do not modify or mount accessories to any panel covering an airbag or adjacent panels.

 **Tip**

Read everything about airbags

There is more information about airbags and safety in general. Make sure you have read everything about these topics so that you understand the capabilities and limitations of your car's safety features.

5.5.4. Inflatable curtains

Your car's inflatable curtains help protect occupants seated by a window in certain collisions. They are placed above the doors on both sides of the car.

The inflatable curtains are designed to help protect the head of a properly seated and secured occupant. Unlike conventional airbags, the inflatable curtains stay inflated for an extended time after deployment.



Inflatable curtain deployed on one side of the car.

The inflatable curtains are packed behind panels along the ceiling's edges on both sides of the car. The panels are marked IC AIRBAG.

 **Warning**

Do not block the inflatable curtains

- Do not hang heavy items from the ceiling hooks or handles. The hooks are meant for light coats and jackets.
- Do not modify or mount accessories to the panels covering the inflatable curtains, the ceiling, pillars or adjacent panels.

Blocking airbags in general

Keep all airbag locations and expansion spaces free of obstructions. Obstructions can reduce airbag effectiveness and cause serious injury.

- Follow the instructions for a correct sitting posture.
- Properly stow luggage and other objects. The car has several luggage compartments for safe stowing.
- Do not modify or mount accessories to any panel covering an airbag or adjacent panels.

 **Tip**

Read everything about airbags

There is more information about airbags and safety in general. Make sure you have read everything about these topics so that you understand the capabilities and limitations of your car's safety features.

5.5.5. Airbag maintenance and servicing

Contact an authorised Volvo workshop if there is any indication of faults or damage to the airbags or other safety systems.

Any servicing or repairs of the airbags and related safety systems must be performed by authorised service technicians.^[1] Never attempt to alter or repair any part of the car's safety systems yourself. Incorrectly performed repairs can lead to malfunctions and serious injury. Contact an authorised Volvo workshop when your car needs servicing or repairs.



Warning

Car modifications and airbags

Modifications to the car risk affecting airbags and other safety systems. Carefully read the section about car modifications and contact Volvo ^[2] if you are considering modifying your car in any way ^[3], such as when accommodating a disability.

Airbags and water damage

If the car has been flooded or the interior has been exposed to excessive amounts of water, there may be water damage affecting the safety systems. This can lead to unintentional airbag deployment and cause injury.

- Do not use the car if you suspect it has water damage.
- Contact Volvo Assistance for recovery support.



Note

A warning appears in the driver information area of the display if the car detects any airbag faults. Immediately contact an authorised Volvo workshop if this happens.



SRS warning symbol

^[1] Volvo recommends an authorised Volvo workshop for any repairs or servicing.

^[2] You can find detailed contact information in a separate section in this manual or by contacting Volvo support.

^[3] This applies to all parts of the car, but the front seats and all airbag locations are especially necessary to consider.

5.5.6. Airbag labels

The airbag labels in your car provide essential information about the airbags or can act as airbag location markers.

Airbag location labels

Places in your car marked either AIRBAG, IC AIRBAG or SRS AIRBAG indicate that there is an airbag in that location.



Warning

Airbag label locations

The airbag label locations tell you where your car's airbags are located. Keep these locations and the space around them free of objects. Obstructions can interfere with airbag deployment, reduce their effectiveness and cause serious injury. The airbags section contains more detailed information about use and conditions that can affect the airbags.

Airbag information labels



This label is located on the front passenger side sun visor.



Warning

Child restraints and front passenger seat

NEVER use a rearward facing child restraint on a seat protected by an ACTIVE AIRBAG in front of it, DEATH or SERIOUS INJURY to the CHILD can occur.

5.6. Child safety

Several features in the car aim to increase child safety, including anchorage points for child restraint installation and child locks.



Children in the car should always be securely seated and kept under adult supervision. Follow the recommendations in this manual as well as the local regulations and recommendations that apply to you.

 **Warning**

Securely seated

- Children should be securely seated in a child restraint or with the car's seatbelt depending on their age and size. Never let a child sit in the lap of another passenger or in a location not intended for passengers.
- Other occupants in the car should be properly seated and use the seatbelts correctly. This can help prevent serious injury to children in the car in situations ranging from sudden braking to severe collisions.

Under supervision

- Never leave children alone in the car. Children may be exposed to potentially harmful temperatures on hot or cold days, or may lock themselves in.
- Do not allow children to play in the car or play with any of the car's controls. This reduces the risk of injury to the child or inadvertent activation or deactivation of the car's features.

5.6.1. Child restraints

Children should always use suitable child restraints and be securely seated in the car according to given recommendations.

Different types of child restraints are specifically designed for certain age and height ranges. Your car is equipped with child restraint anchorage points that suit different types of child restraints.

Volvo recommends that children use rearward-facing child restraints for as long as possible, until at least the age of four. After that, children should use forward-facing child restraints, preferably a booster seat using the car's seatbelt to secure the child. Children should use a child restraint until they reach at least 140 centimetres (4 feet 7 inches) in height.

Child restraints are classified into different approval levels:

i-Size	The i-Size child restraint standard uses ISOFIX in combination with the top tether anchorage points or a support leg. This standard ensures that any i-Size child restraint can be used on a seat designated as i-Size approved.
Universal	A child restraint of this approval level can be installed on a seat in any car model, as long as the car seat position is suitable for universally approved child restraints according to the car's manual.
Vehicle specific	A child restraint of this approval level can be installed on a seat in specific car models, as long as the child restraint manufacturer has included the car model in the type list for the specific restraint.



Warning

Child restraints and front passenger seat

NEVER use a rearward facing child restraint on a seat protected by an ACTIVE AIRBAG in front of it, DEATH or SERIOUS INJURY to the CHILD can occur.

Damaged and old child restraints

Never use or reuse a child restraint:

- if the restraint has been involved in an accident or is damaged in any way
- if the expiry date or service life of the restraint has been exceeded
- if you don't know the full history of the restraint.

 **Important**

Loose child restraints

Never leave a loose child restraint in the passenger compartment. When not in use, keep it installed according to the manufacturer's instructions or store it securely in the boot. A loose child restraint can cause damage in the event of a collision or sudden braking.

General safety recommendations

When applicable, follow the general safety recommendations regarding seatbelt use, headrest adjustment and proper seating.

Local regulations

Regulations on where and how children should be seated and secured differ between regions. Make sure that you know what applies to the region you are in.

Airbag information labels



This label is located on the front passenger side sun visor.

5.6.1.1. Installing child restraints

When installing and using a child restraint, there is a number of things to keep in mind, depending on the location of the child restraint in your car.

 **Warning**

Child restraints and front passenger seat

NEVER use a rearward facing child restraint on a seat protected by an ACTIVE AIRBAG in front of it, DEATH or SERIOUS INJURY to the CHILD can occur.

 **Important**

Local regulations

Regulations on where and how children should be seated and secured differ between regions. Make sure that you know what applies to the region you are in.

Manufacturer's instructions

Always follow the instructions from the manufacturer of the child restraint.

5.6.1.1.1. Installing child restraints on the outer rear seats

To securely install a child restraint on either of the outer rear seats, there is important information to read and recommendations to follow.

ISOFIX, top and lower tether anchorage points can be used when installing a child restraint on the outer rear seats. The seats are approved for i-Size child restraints.

 **Tip**

Long-term use of a child restraint may cause wear and tear on the car interior. Use a kick guard accessory to protect the car interior.

Allowed child restraints

- Only use child restraints that are recommended by Volvo, i-Size approved, universally approved or are vehicle specific approved where the car is included in the child restraint manufacturer's vehicle list.

Seat preparations

- Remove cushion extenders, leg supports and other accessories from the seat before installing a child restraint. If you use a kick guard accessory, this can remain on the seat.
- Any support legs of a child restraint should always be fitted directly to the floor. Do not fit support legs to any raised or uneven floor surfaces, footrests or other objects. Adjust the position of the seat in front if necessary to get enough space.
- Loose objects should not be stored around any support legs of a child restraint.
- Any restraining straps of a child restraint should always be secured to designated anchorage points. Do not secure restraining straps to seat rails, handles or other parts of the interior.
- When installing an adjustable, rearward-facing child restraint, adjust the child restraint according to the child's age. Older children should be seated in a more upright position than younger ones.
- When installing a forward-facing child restraint, make sure you adjust the headrest of the seat to the child's height. Even if the child restraint includes a head support, it might not have been built to withstand the forces involved in a collision.

Seatbelt use

- When installing a child restraint secured using the car's seatbelt or when the car's seatbelt is used to secure a child, ensure that brackets or other parts of the restraint do not come into contact with the seatbelt buckle button.

 **Warning**

Follow the instructions

Take extra care to read all information about child safety in this manual and follow the instructions from the manufacturer of your child restraint. If you do not, the child could sustain serious injury in the event of an accident.

 **Important**

Follow the general recommendations for any child restraint anchorage points used to install a child restraint.

1. Follow the instructions from the manufacturer to install the child restraint.

 **Note**

Installation questions

If you have installation questions, contact the manufacturer of the child restraint for more detailed instructions.

Protecting the car interior

During installation, be careful to avoid damage to the car interior caused by protruding parts or sharp edges of the child restraint.

- If the child restraint uses lower tether straps, never adjust the position of the front seats after the straps have been secured to the lower tether anchorage points. Always remember to remove the straps when the child restraint is not installed.
- Fasten loose parts of child restraints, such as restraining straps, according to the manufacturer's instructions.

 **Important**

Raised headrest

The headrest must always be raised when a child restraint is installed.

General safety recommendations

When applicable, follow the general safety recommendations regarding seatbelt use, headrest adjustment and proper seating.

Local regulations

Regulations on where and how children should be seated and secured differ between regions. Make sure that you know what applies to the region you are in.

5.6.1.1.2. Installing child restraints on the centre rear seat

To securely install a child restraint on the centre rear seat, there is important information to read and recommendations to follow.

There are no anchorage points available when installing a child restraint on the centre rear seat.

 **Tip**

Long-term use of a child restraint may cause wear and tear on the car interior. Use a kick guard accessory to protect the car interior.

Allowed child restraints

- Only use child restraints that are recommended by Volvo, universally approved or are vehicle specific approved where the car is included in the child restraint manufacturer's vehicle list.
- Child restraints that use support legs are not allowed on the centre rear seat.

Seat preparations

- Remove cushion extenders, leg supports and other accessories from the seat before installing a child restraint. If you use a kick guard accessory, this can remain on the seat.
- Any restraining straps of a child restraint should always be secured to designated anchorage points. Do not secure restraining straps to seat rails, handles or other parts of the interior.
- When installing an adjustable, rearward-facing child restraint, adjust the child restraint according to the child's age. Older children should be seated in a more upright position than younger ones.
- When installing a forward-facing child restraint, make sure you adjust the headrest of the seat to the child's height. Even if the child restraint includes a head support, it might not have been built to withstand the forces involved in a collision.

Seatbelt use

The content of this manual represents the status of the user manual at the time of printing and may not be completely valid in future instances. For more information, refer to the first page for the complete disclaimer note.

- When installing a child restraint secured using the car's seatbelt or when the car's seatbelt is used to secure a child, ensure that brackets or other parts of the restraint do not come into contact with the seatbelt buckle button.

 **Warning**

Follow the instructions

Take extra care to read all information about child safety in this manual and follow the instructions from the manufacturer of your child restraint. If you do not, the child could sustain serious injury in the event of an accident.

 **Important**

Follow the general recommendations for any child restraint anchorage points used to install a child restraint.

1. Follow the instructions from the manufacturer to install the child restraint.

 **Note**

Installation questions

If you have installation questions, contact the manufacturer of the child restraint for more detailed instructions.

Protecting the car interior

During installation, be careful to avoid damage to the car interior caused by protruding parts or sharp edges of the child restraint.

- Fasten loose parts of child restraints, such as restraining straps, according to the manufacturer's instructions.

 **Important**

General safety recommendations

When applicable, follow the general safety recommendations regarding seatbelt use, headrest adjustment and proper seating.

Local regulations

Regulations on where and how children should be seated and secured differ between regions. Make sure that you know what applies to the region you are in.

5.6.1.1.3. Installing child restraints on the front passenger seat

To securely install a child restraint on the front passenger seat, there is important information to read and recommendations to follow.

Accessory lower tether anchorage points^[1] can be used when installing a child restraint on the front passenger seat.



Tip

Long-term use of a child restraint may cause wear and tear on the car interior. Use a kick guard accessory to protect the car interior.

Allowed child restraints

- Only use child restraints that are recommended by Volvo, universally approved or are vehicle specific approved where the car is included in the manufacturer's vehicle list.

Seat preparations

- Remove cushion extenders, leg supports and other accessories from the seat before installing a child restraint. If you use a kick guard accessory, this can remain on the seat.
- Any support legs of a child restraint should always be fitted directly to the floor. Do not fit support legs to any raised or uneven floor surfaces, footrests or other objects. Adjust the seat position if necessary to get enough space.
- Loose objects should not be stored around any support legs of a child restraint.
- Any restraining straps of a child restraint should always be secured to designated anchorage points. Do not secure restraining straps to seat rails, handles or other parts of the interior.
- When installing rearward-facing child restraints, adjust the seat to its lowest position.
- When installing adjustable, rearward-facing child restraints, adjust the child restraint according to the child's age. Older children should be seated in a more upright position than younger ones.
- When installing a child restraint using the lower tether anchorage points, never adjust the seat position to tighten the straps.

Seatbelt use

- When installing a child restraint secured using the car's seatbelt or when the car's seatbelt is used to secure a child, ensure that brackets or other parts of the restraint do not come into contact with the seatbelt buckle.^[2]
- When securing a child with the car's seatbelt, always start with the seatbelt's upper anchorage point adjusted to its highest level. Then lower it as needed to properly position the belt against the shoulder.

 **Warning**

Passenger airbag status

- When installing rearward-facing child restraints, always check that the passenger airbag is disabled.
- When installing forward-facing child restraints, always check that the passenger airbag is enabled.

Failure to follow these instructions can endanger life or lead to serious injury.

Follow the instructions

Take extra care to read all information about child safety in this manual and follow the instructions from the manufacturer of your child restraint. If you do not, the child could sustain serious injury in the event of an accident.

 **Important**

Follow the general recommendations for any child restraint anchorage points used to install a child restraint.

1. Follow the instructions from the manufacturer to install the child restraint.

 **Note**

Installation questions

If you have installation questions, contact the manufacturer of the child restraint for more detailed instructions.

Protecting the car interior

Be careful during installation to avoid damage to the car interior caused by protruding parts or sharp edges of the child restraint.

- If the child restraint uses lower tether straps, never adjust the position of the seat after the straps have been secured to the lower tether anchorage points. Always remember to remove the straps when the child restraint is not installed.
- Fasten loose parts of child restraints, such as restraining straps, according to the manufacturer's instructions.

! Important

General safety recommendations

When applicable, follow the general safety recommendations regarding seatbelt use, headrest adjustment and proper seating.

Local regulations

Regulations on where and how children should be seated and secured differ between regions. Make sure that you know what applies to the region you are in.

[1] Availability may vary between regions.

[2] If the space between the belt buckle and the child restraint is too narrow, adjust the height of the seat to make more room.

5.6.1.2. Child restraint anchorage points

Your car has different types of anchorage points. Be sure to use the correct anchorage points for your specific child restraint.

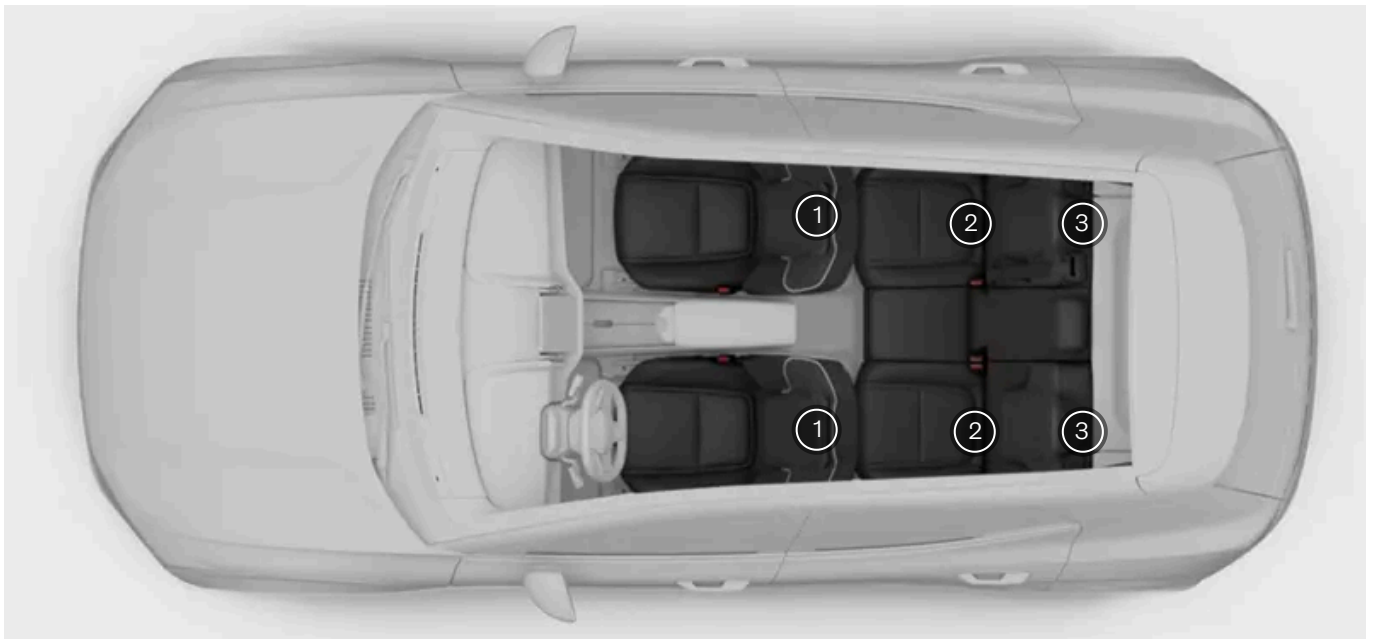

- ① Lower tether anchorage points on the floor rails of the front seats
- ② ISOFIX anchorage points in the lower part of the backrests of the rear seats
- ③ Top tether anchorage points on the backs of the rear seats

Your car's various anchorage points can be used in combination with each other or along with other fastening methods to secure different types of child restraints.

The i-Size child restraint standard uses ISOFIX in combination with the top tether anchorage points or a support leg. This standard ensures that any i-Size child restraint can be used on a seat designated as i-Size approved.

The content of this manual represents the status of the user manual at the time of printing and may not be completely valid in future instances. For more information, refer to the first page for the complete disclaimer note.

Some child restraints are secured using a car seatbelt, usually in combination with other fastening methods.

Note

Manufacturer's instructions

When using anchorage points, always follow the instructions from the manufacturer of the child restraint.

5.6.1.2.1. ISOFIX anchorage points

Your car is equipped with ISOFIX anchorage points that can be used to secure child restraints on a rear seat.

The ISOFIX anchorage points can be used in combination with other fastening methods to secure i-Size and ISOFIX child restraints. These anchorage points are part of an international standard for child restraints.

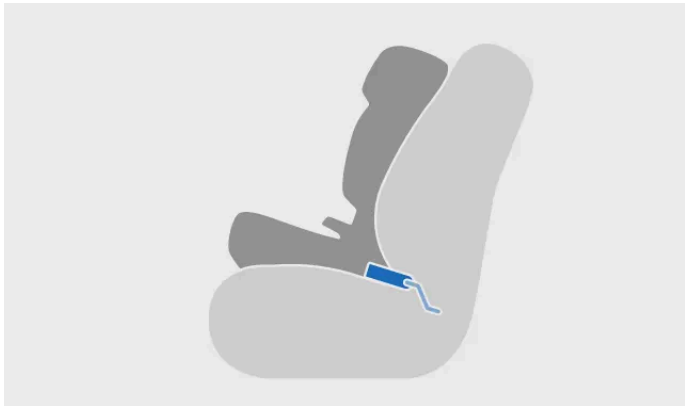

Child restraint installed using ISOFIX



Attaching to ISOFIX anchorage point

Child restraints installed on the outer rear seats can use these anchorage points.

i Note

ISOFIX is an international standard for child restraint anchorage points. It is also known by other regional names such as LATCH and LUAS.



The ISOFIX anchorage points for the rear seats are located behind a flap in the lower part of the backrest on the outer rear seats. The flap needs to be unfolded to access the anchorage points behind it.

i Note

The unfolded flap should lie flat between the seat cushion and an installed child restraint.

The anchorage point locations marked with the i-Size symbol are approved for i-Size child restraints.



i Note

Manufacturer's instructions

When using anchorage points, always follow the instructions from the manufacturer of the child restraint.

5.6.1.2.2. Top tether anchorage points

Your car is equipped with top tether anchorage points that can be used to secure child restraints on a rear seat.

The top tether anchorage points can be used in combination with other fastening methods to secure different types of child

restraints.

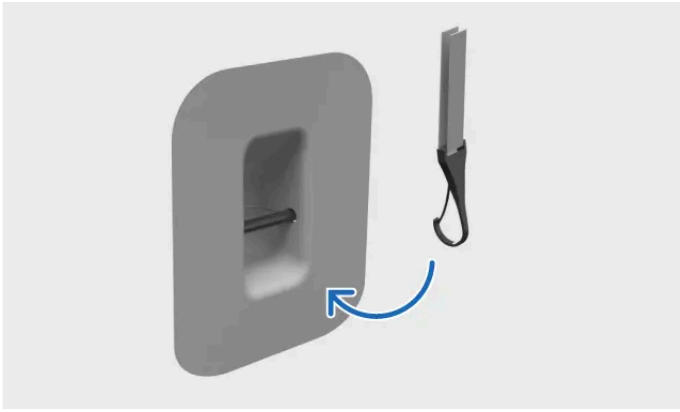

Fastening tether to top tether anchorage point

Child restraints installed on the outer rear seats can use these anchorage points.

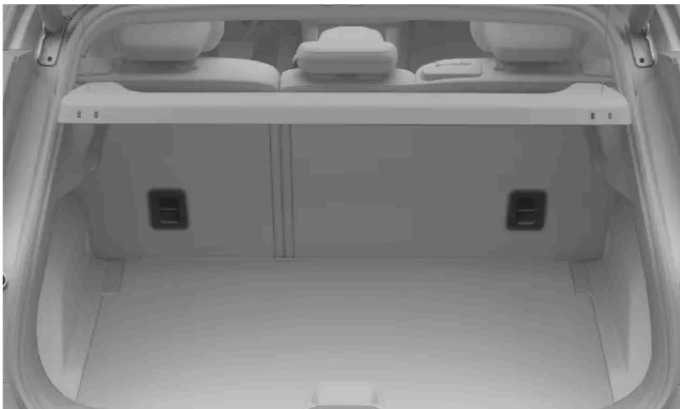

The top tether anchorage points for the rear seats are located on the back of the outer rear seats.

The anchorage locations are indicated by the top tether symbol.



! Important

Manufacturer's instructions

When using anchorage points, always follow the instructions from the manufacturer of the child restraint.

Parcel shelf

If the parcel shelf is installed behind the rear seats, the narrow gap between backrest and parcel shelf can make it difficult to attach the top tether strap. If necessary, remove the parcel shelf temporarily to make the installation easier. Always make sure the parcel shelf is not in contact with the top tether strap.

5.6.1.2.3. Lower tether anchorage points

Your car is equipped with lower tether anchorage points that can be used to secure child restraints on a rear seat.

The lower tether anchorage points can mainly be used in combination with the car's seatbelt to secure certain rearward-facing child restraints.

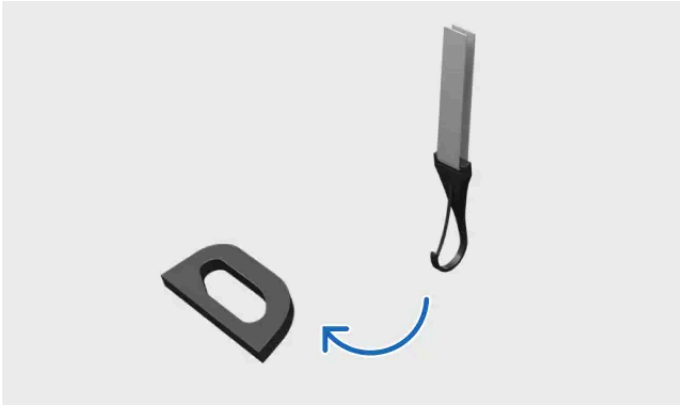

Fastening tether to lower tether anchorage point

Child restraints installed on any rear seat can use these anchorage points.

Additionally, child restraints installed on the front passenger seat can use these anchorage points if your car is equipped with the front lower tether accessory.

Tip

It is possible to attach two lower tether straps from different child restraints to the single lower tether anchorage point closest to the centre of the car, such as when installing two rearward-facing child restraints next to each other.

Anchorage points for the rear seats



The lower tether anchorage points for the rear seats can be found at the back of the floor rails of the seats in front.

Anchorage points for the front seat

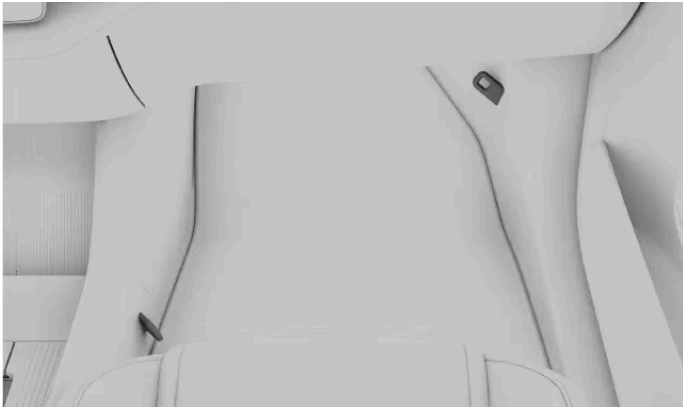

With the front lower tether accessory^[1], the anchorage points for the front passenger seat are located on the sides of the seat's footwell.

Note

Manufacturer's instructions

When using anchorage points, always follow the instructions from the manufacturer of the child restraint.

^[1] Availability may vary between regions.

5.6.1.3. Recommended child restraints

Only use child restraints that are recommended by Volvo, i-Size approved, universally approved or are vehicle specific approved where the car is included in the manufacturer's vehicle list.

Child restraint ^[1]	Installation type	Child group/child size (ECE R44/ECE R129)
Maxi-Cosi Pearl 360 + FamilyFix 360 Base ^[2]	Rearward-facing	40–105 cm (max 17.5 kg)
Britax Römer Kidfix i-Size ^[3]	Forward-facing	100–150 cm (max 36 kg)
Graco Booster Basic ^[4]	Forward-facing	Group III (22–36 kg)
Volvo rear-facing child seat ^[5]	Rearward-facing	61–115 cm (max 25 kg)
Volvo booster seat ^[6]	Forward-facing	105–150 cm (max 36 kg)
Volvo booster cushion ^[6]	Forward-facing	138–150 cm (max 36 kg)

^[1] Availability of listed child restraints may vary by region.

^[2] Approval No: 030062

^[3] Approval No: 0061 01

^[4] Approval No: ECE R44.04: E11-0444165

^[5] Approval No: E11 129R03/08 0599 00

^[6] Approval No: E1 129R03/09 0061 07

The content of this manual represents the status of the user manual at the time of printing and may not be completely valid in future instances. For more information, refer to the first page for the complete disclaimer note.

5.6.1.4. Overview table of suitable locations for child restraints

The following table provides an overview of the types of child restraints suitable for installation on each seat.

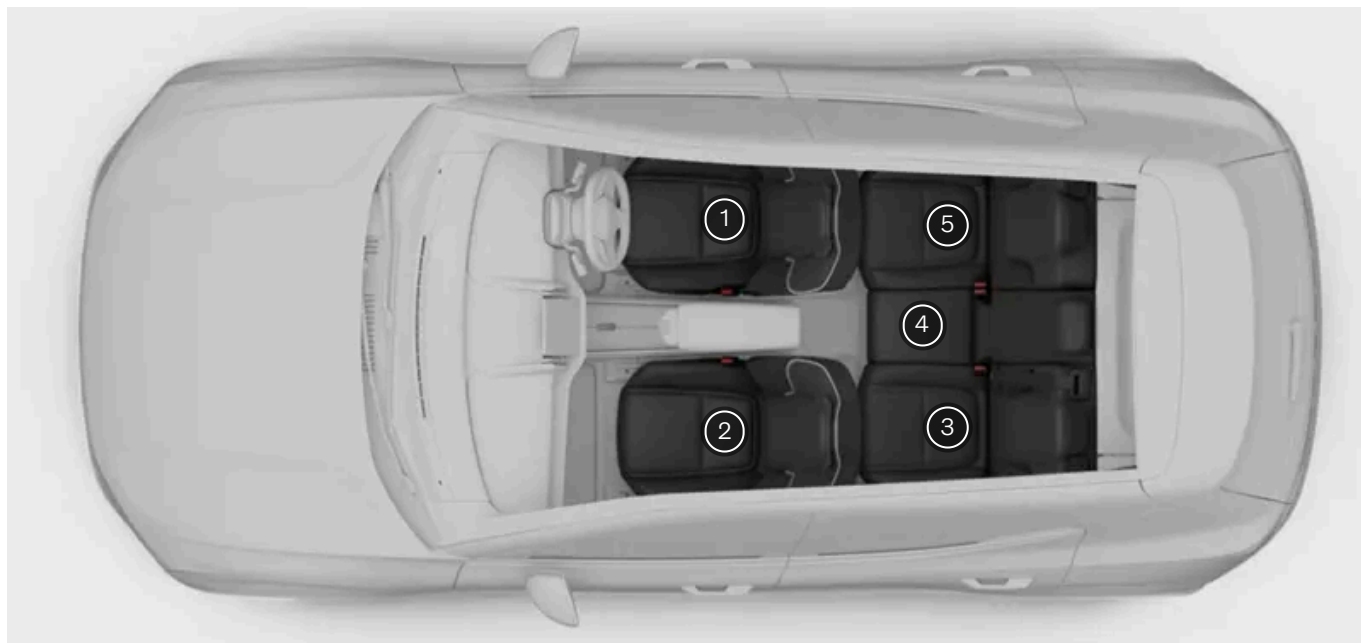

Seat position ^[1]	1	2 ^[2]	3	4	5
i-Size child restraint systems	No	No	Yes	No	Yes
Universally approved child restraint systems secured using the car's seatbelt	No	Yes	Yes	No ^[3]	Yes
Other child restraint system categories ^[4]	No	Yes	Yes	No	Yes

Warning

- When forward-facing child restraints are installed on the front passenger seat (seat position 2), the passenger airbag must be enabled.
- When rearward-facing child restraints are installed on the front passenger seat (seat position 2), the passenger airbag must be disabled.

Failure to follow these instructions can endanger life or lead to serious injury.

Important

Local regulations

Regulations on where and how children should be seated and secured differ between regions. Make sure that you know what applies to the region you are in.

[1] According to illustration.

[2] Enabled airbag for forward-facing child restraints. Disabled airbag for rearward-facing child restraints.

[3] For more information, read the detailed child restraint information in this manual.

[4] For more information, contact the manufacturer of the child restraint system.

6. Entry and security

Learn about the various features associated with entering and exiting the car, including how the keys and alarm work.



This section of the manual covers the different types of keys, opening and closing the doors, locking and unlocking, and the alarm.

Learn more about the different types of keys and how you can customise the way your car reacts when you lock, unlock, approach or leave it.

6.1. Keys

Your car supports several types of keys. Some keys can be sensed by the car as you approach or leave it, whereas key cards need to be placed on the driver's door pillar.

Important

Using keys is fairly straightforward, but you should be aware of the limitations of each key type for safety and security reasons. Therefore, it is important to read all of the information in this manual about keys and how to use them.

Car and key wireless technologies may cause disturbances in other devices. You can find more information about these systems in the specifications section of this manual.

For safety and security reasons, never leave unattended keys in an exposed place.

The car supports the following types of keys:

- Digital key

- Key card
- Key tag

Charged key tags and digital keys are distance-capable, meaning your car can detect them when you approach or leave it. This allows for automatic locking and unlocking.

Keys without power, such as a key card or a distance-capable key with a flat battery, use NFC^[1]. This means they can only be read at specific key reading locations.

Note

Ordering new or additional keys

Your car comes with a limited number of keys. Contact a Volvo dealer if you lose a key or simply require additional keys.

Key reading locations

There are two ways that your car can detect your key and use it to lock or unlock:

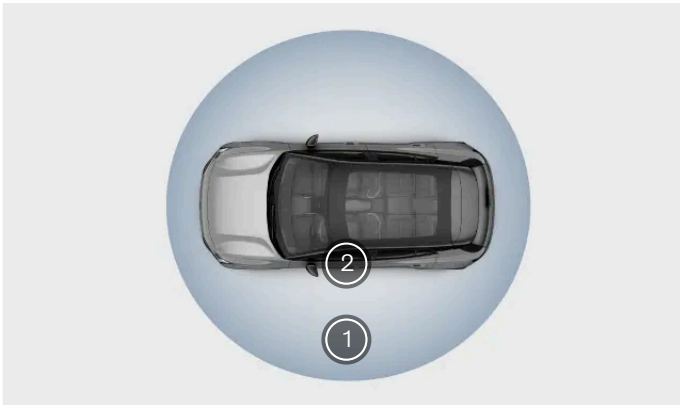

- ① Distance-capable keys can lock or unlock the car from a distance.
- ② Keys that are not distance-capable need to be placed on the driver's door pillar to unlock the car.

There is also a key reader below the display where you can place a key card or a discharged distance-capable key to start the car.

User profiles and keys

You can assign keys to a user profile. This allows the car to automatically identify who's unlocking it and apply all of their customisations. You can read more about which customisation options are available in a separate section of this manual.

Note

Unresponsive car

If the car has been turned off for a long time, it may take several seconds for it to unlock. This is because the car needs time to turn its systems back on, to recognise the key and to give you access.

If the car's batteries go completely flat, it will not respond to any key.

Locking keys in

If you lock the car while a distance-capable key is still inside, that key will be temporarily deactivated. You can still use one of your other keys on the driver's door pillar to enter the car.

Important

When the car is locked, key cards can still be used to start the car. For safety and security reasons, never leave unattended keys in an exposed place.

Warning

Improper use of car opening and starting systems can result in serious personal injury. Always take your keys with you when you leave the car, including distance-capable keys. The car can be started and systems, such as the power windows, can be operated, leading to serious personal injury. Never leave children, disabled persons or anyone who cannot help themselves in the car. The doors can be locked using a distance-capable key or by touching the capacitive lock sensor area of the door handle. This could result in people being trapped in the car in an emergency. For example, depending on the time of year, people trapped in the car can be exposed to very high or low temperatures.

The keyless entry system for distance-capable keys may sometimes be affected by other devices or signals. Key reading signals can be blocked or affected by proximity to wireless emissions from powerful interference sources such as telecommunication towers or power stations.

Do not place the key tag with a smartphone, Bluetooth earphones and other similar devices, they can cause signal interference to the keys.

Keep your key card away from devices such as smartphones while charging, they can damage the NFC capability in the card.

Key tags and key cards are sensitive to extreme temperatures.

^[1] Near Field Communication

6.1.1. Key tag

You can use your key tag to lock, unlock and drive the car.



The key tag works at a distance to lock, unlock and start the car, but it can also be used in the same way as a key card.

If the car doesn't detect your key tag, it can be due to signal interference or low battery. In that case, you can still use it like a key card. Place it on the driver's door pillar with the logo facing towards you to lock or unlock the car.



To start your car using the key tag, just keep it with you inside the car.

! Important

If your key tag has a flat battery or suffers signal interference, you can place it on the key reader between the front seats and the car will be ready to drive. This is because the wireless charger also works as a key reader by using NFC^[1]. Keep this in mind if you leave the car momentarily unattended, especially if there are occupants in the car.

i Note

You can replace the key tag battery. It uses a CR2450 battery.

Be aware that the signals between the key and the car can be affected by obstacles or interference from other signals.

If you are in close proximity to the car for long periods of time without opening the driver door, there might be a delay when you try to open or unlock the car using the driver door handle. If the car doesn't immediately unlock or open, this is normal. Just wait a few seconds and try again.

^[1] Near Field Communication

6.1.1.1. Replacing the key tag battery

You can replace the battery in your key tag when it goes flat.

If the key tag signal appears to be unreliable, this may be due to a low battery. You can replace the battery yourself. The tag requires a flat CR2450 disc or button battery.

i Tip

- You may find it helpful to use a small screwdriver to unlock the tag lid and to lift the battery from its slot.
- You only need to replace the key tag battery if you're using the proximity lock feature. If you're only using your key tag like a key card, you don't need to replace the battery.

! Important

- For safety reasons and to ensure optimal battery performance, use hand protection such as a medical glove when handling a new battery.
- Used batteries must be recycled in an environmentally sound manner.

⚠ Warning

Check that the battery is fitted correctly with the correct polarity. If the key tag will not be used for a long time, remove the battery to avoid battery leakage and damage. Batteries with damage or leaks may cause corrosive injury on contact with the skin. Therefore, use protective gloves when handling old or damaged batteries.

- Keep batteries out of the reach of children.
- Do not leave batteries lying around since they can be swallowed by children or pets.
- Batteries must not: be dismantled, short-circuited or thrown into open flames.
- Do not try to charge non-rechargeable batteries. They may explode.
- Check battery operated products for signs of damage on a regular basis. The key tag should not be used if anything indicates that the tag or its battery has been damaged or has started to leak.
- Keep defective products out of the reach of children.

1.



Hold the tag with the Volvo logo facing upwards. There is a small opening on one of the tag's short sides. Pry open the tag from this side by pulling the edge outwards and upwards.

2. Lift the tag lid to access the battery.

3. Pry the battery from the locking teeth and slide it towards you to remove it.

4. Slide the new battery into the slot and press it down to lock it into place. Make sure the positive side of the battery is facing upwards.
5. Close the tag lid so that it clicks into place.

If the key tag signal is still unreliable, this may be due to signal interference outside of the car. If the tag fails to work at all, repeat the steps and ensure that a fully-charged battery is properly installed. If you think that you may need a new key tag, contact a Volvo dealer.

6.1.2. Key card

Your key card can lock and unlock the car, and allows you driving access.



You can lock and unlock the car by placing the key card on the driver's door pillar.



Key reading location on the driver's door pillar.

The key card starts the car when placed on the card reader located between the two front seats. When you start using the pedals, you can remove the card from the card reader.

If the car is stationary without a card on the card reader for a while, you will need to put the card back on the reader for the car to reactivate driving mode.

Note

The card reader and wireless charger are located in the same place. Therefore, if you have any kind of car key on the card reader, you have to remove it to be able to wirelessly charge a phone.

Important

Do not place cards with NFC^[1], such as key cards or electronic payment cards, between the wireless charger and the device when using the charging function. This could damage them.

Warning

The car's use of Bluetooth, UWB^[2] and NFC signals may cause disturbances in other devices at certain distances.

Tip

Key card as backup access

If your car is unresponsive when you try to unlock it with a distance-capable key, try unlocking the driver door with your key card. The key card is designed specifically to also act as a backup in this kind of situation. You will be able to get to any belongings inside even if the other doors don't work. If your car is unresponsive, contact Volvo support.

Keep in mind that if the car battery is flat, you won't be able to open the doors.

^[1] Near Field Communication

^[2] Ultra-wideband

6.1.3. Digital key

The digital key allows you to lock, unlock and start your car using a compatible phone or smart watch.

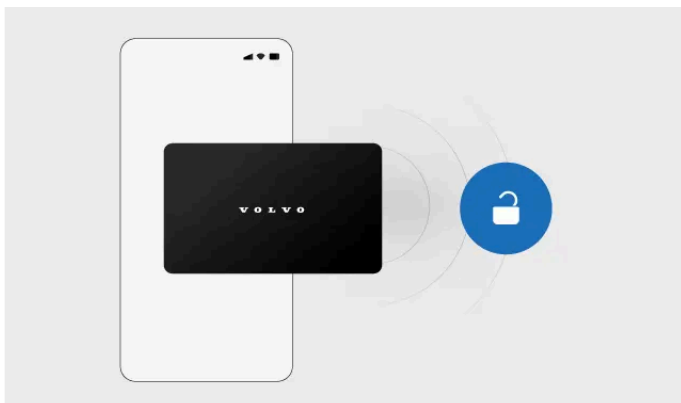

Once you've set up a digital key on your device, it works in the same way as your other keys. If your device has UWB^[1] capability, your car will be able to detect the digital key from a distance. If your device doesn't have UWB capability, the digital key works as a key card.

The car's owner can create one primary digital key. Once the primary key has been created, you can share digital keys with family and friends.

 **Note**

The digital key for your car is currently available for certain Apple iPhone, Samsung Galaxy and Google Pixel models. Check with your device manufacturer if you're unsure about the compatibility of your device. Many manufacturers have information about compatibility and UWB capability on their website.

Using the digital key on a device with UWB

When you set up a digital key on a device with UWB capability, you can lock or unlock the car by:

- using the approach and leave feature for automatic unlocking and locking
- touching the inside of the door handle
- using your device as a key card
- using the lock and unlock button in your device's wallet app.

To get driving access, you just need to bring your device with you inside the car or place it on the key reader below the display. The key reader is located in the same place as the wireless charger.

 **Tip**

Disable passive entry in wallet app

Many wallet apps have a setting that lets you disable passive entry. When this feature is disabled, your car won't unlock automatically when you get close to it while carrying a digital key. The approach unlock feature will still be available when you use your other distance-capable keys.

Using the digital key on a device without UWB

If your device doesn't have UWB capability, your digital key works as a key card. To unlock the car, open your key in the wallet app and place the device on the driver's door pillar. You can also lock and unlock your car from a distance via the wallet app if you enable Bluetooth on your device.

To start the car, put the device on the key reader below the display.

Sharing a digital key

Once you've set up a digital key, you can share it with family and friends. Open the digital key in your phone's wallet app to find the sharing option.

 **Note**

The option to share your digital key may not be available in all wallet views. Make sure to open the wallet app via the app icon.

 **Tip**

No battery

You may still be able to use your digital key as a key card even if your device has run out of battery. Contact the device's manufacturer for more information.

^[1] Ultra-wideband

6.1.3.1. Creating a digital key

The car's owner can create a primary digital key at any time via settings.

The car's owner can create a primary digital key in the setup guide. This digital key can then be shared with family and friends. You can access the guide via your car's centre display, the Volvo Cars app^[1] or the activation email you receive when your car is being prepared for delivery.

Creating a digital key via the centre display

You need to be inside the car while setting up your digital key. You also need to make sure that:

- your car is updated to software version 1.5.2 or later
- the car is stationary and all of the doors are closed
- you are signed in to the car's owner profile in the centre display
- both your car and your phone have a stable internet connection^[2]
- Bluetooth is enabled on your phone
- mobile data usage is enabled in the wallet app on your phone
- you have a valid key with you, such as a key tag or key card
- you have access to the Volvo ID registered to the car's owner profile.^[3]

1. Press the car symbol  in the bottom bar and go to **Settings**.
2. Select the owner profile and go to **Profiles** → **Set up digital key**.

3. Place your key card on the key reader under the display.

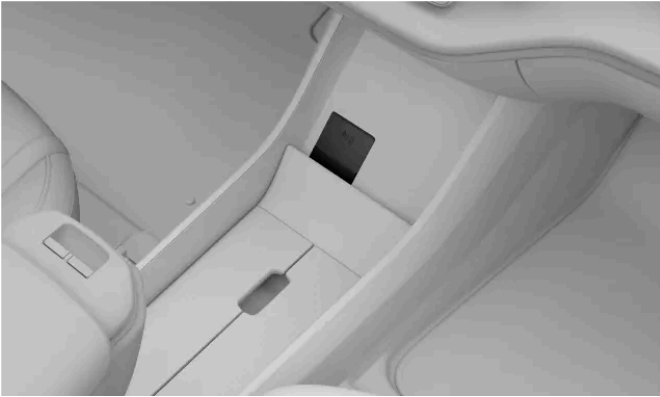

Key reader location

- > A message appears in the centre display once the key has been successfully read.
4. Remove your key from the reader.
 5. Place your phone on the key reader until a message about the car key appears on your phone.
- > An email with a pairing code is sent to the email address associated with your Volvo ID.
6. Remove your phone from the reader and enter the pairing code in your wallet app.
 7. Place your phone back on the key reader.
- > A confirmation message appears in the centre display when your digital key is ready to use.

Moving the primary digital key to another phone

If you want to move the primary digital key to another device, such as a new phone, you can do so via the centre display. In the owner's profile settings, select your primary digital key and press **Change device** to move the key to the new device.

Tip

Using the digital key on Apple Watch

If you want to add your digital key to your Apple Watch at a later stage, you can do so via the Apple Watch app on your iPhone.

Assigning digital keys to a profile

The primary digital key is always assigned to the car's owner profile. If you have shared a digital key with someone, make sure they assign it to their car user profile to ensure that all of their preferred settings are applied when they unlock the car.

^[1] Version 5.6 or later

^[2] If the car is parked in an underground garage or surrounded by obstacles such as buildings, hills or mountains, the network signal may be blocked or too weak.

^[3] If you're not the car's owner, you can't create your own digital key. You need to ask the owner to share their digital key with you instead.

6.1.3.2. Deleting a digital key

You can delete digital keys at any time, either via the centre display, the Volvo Cars app or your phone's wallet app.

Anyone with a digital key can delete and remove it from their phone's wallet app. The car's owner can also remove the primary key or shared keys via their wallet app, the Volvo Cars app or the owner's profile in the centre display.

Note

Grace period

When the car's owner deletes a shared key through their phone's wallet app, the key will be fully disabled after the shared key's holder finishes their last drive or 48 hours after deletion. If the shared key is deleted via the centre display, the key is instantly disabled.

Removing one or all digital keys via the centre display

1. Press the car symbol  in the bottom bar and go to **Settings**.
2. Select the owner profile and go to **Access and privacy** → **Digital key** → **Manage**.
3. Select the digital key or keys you want to remove.
4. Press **Remove**.

Note

Lost device

If a device with a digital key gets lost, it's a good idea to delete the digital key. Always keep a key card close to hand so that you can still access your car if you lose your device.

6.1.4. Key reading locations

There are some key interaction points where your car can detect your keys to let you lock, unlock or drive.

Interaction points for keys

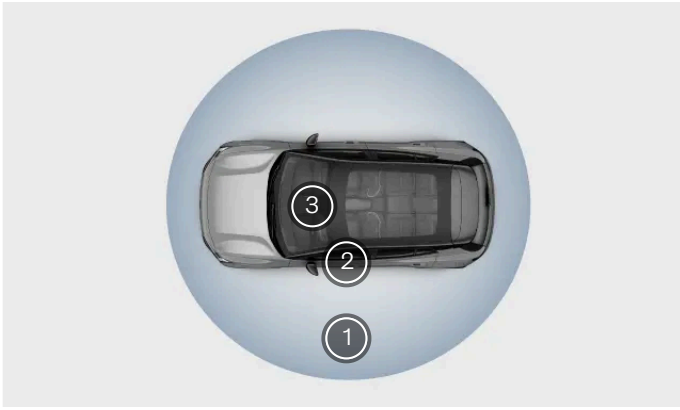

- ① Your car can detect distance-capable keys from a short distance away.
- ② Keys that are not distance-capable need to be placed on the driver's door pillar to unlock the car.
- ③ Key cards or discharged keys can be placed on the key reader below the display to start the car.

Distance-capable keys

Charged key tags and digital keys are distance-capable, meaning your car can detect them when you approach or leave it. This allows for automatic locking and unlocking. Go to settings to select your preferences and to turn automatic locking and unlocking on or off.

Distance-capable keys also let you lock or unlock the car by using the touch points on the door handle.

i Note

Your distance-capable keys also have NFC^[1] functionality. This means that even if a distance-capable key has a low or discharged battery, you can still use it as a key card. Therefore, any reference to key card functionality applies to discharged distance-capable keys too.

Exterior key reader

You can lock and unlock the car by placing any type of key on the key reading sensor in the driver's door pillar.



Key reading location on the driver's door pillar

Make sure the card or device is laid flat against the reader. If you're using a key tag, the logo should be facing towards you.

Interior key reader

You can place your key card or a discharged key tag on the key reader below the display to get driving access.

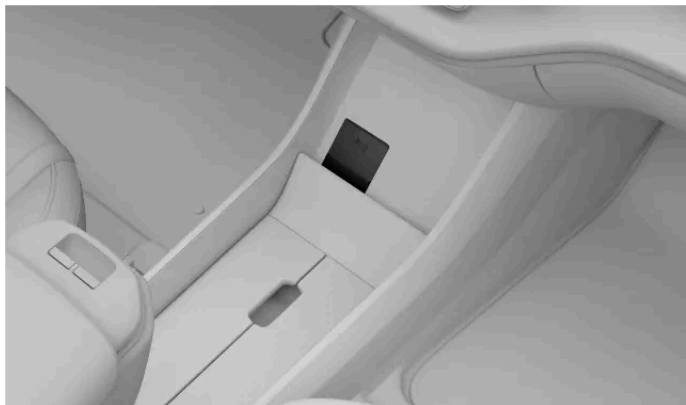

Key reader location

i Note

The key reader won't work at the same time as the wireless charger.

^[1] Near Field Communication

6.2. Opening and closing

Your car has a few features and situation-specific behaviours you should be aware of when opening and closing the doors.

Doors

You open the doors manually, but you can set how the doors unlock and under which conditions via the display.

The rear doors are equipped with a double-pull feature to help protect against accidental opening of the rear doors. To open the rear doors from the inside, you need to pull the door handle twice.

Bonnet

The bonnet is opened by using a lever near the driver's seat.

Boot

You can open the boot via the display or using the button on the boot hatch.

Open door warning

Regularly check that the bonnet, boot and doors are fully closed.



Open doors are highlighted in red on the car symbol in the display. The car will also use warning sounds to indicate improperly closed doors.

6.2.1. Opening the bonnet

Opening the bonnet provides access to the front storage compartment. Be sure to close the bonnet again before driving the car.

Location of release lever



The interior lever as seen from the driver's seat.

The lever to open the bonnet can be found below the dashboard on the driver's side, just in front of the door hinge.

Opening the bonnet

1. Pull the bonnet lever upwards twice.
 - > The bonnet releases from its fully locked position.
2. Lift the bonnet by its front edge and open it to its fully extended height, which is just above a 45-degree angle.
 - > The bonnet stays in position.

Warning

Do not drive with the bonnet open

Stop the car immediately if there is any indication that the bonnet is not completely closed.

Note

Open bonnet warning

If you see an open bonnet warning in the display, open the bonnet and check for obstructions before closing it again. Contact Volvo support if the notification doesn't go away.

6.2.2. Closing the bonnet

Take extra care to ensure that the bonnet completely closes after being open.

Make sure nothing gets in the way of the bonnet as it closes.

Warning

Pinching and crushing hazard

Keep all hands away from the bonnet's closing path. Take extra caution when children or pets are nearby.

1. From the fully opened position, simply pull the bonnet down by holding the outer edge.
2. Carefully lower the bonnet until it reaches the locking mechanism.

3.



Press down with both hands on the front edge of the bonnet lid. Make sure the bonnet fits into the locks at the same time. Keep the front edge flat as it closes.

- > The bonnet noticeably locks in place on both sides.
4. Make sure there are no significant gaps or any indication that the bonnet is not completely closed.

Note

Open bonnet warning

If you see an open bonnet warning in the display, open the bonnet and check for obstructions before closing it again. Contact Volvo support if the notification doesn't go away.

Warning

Do not drive with the bonnet open

Stop the car immediately if there is any indication that the bonnet is not completely closed.

6.2.3. Boot access

Open and close the boot via the display or the button on the boot hatch.

Warning

Be aware when the boot is opening or closing. Make sure that no persons are in the vicinity of the boot when it is in motion. Always use the boot access functions with caution.

Do not interfere with the boot's support arms, these are highly pressurised and tampering with them can result in serious injury.

After use, check the display for indications that the boot is fully closed.

If the car is unlocked, you can open the boot using the button in the middle of the boot hatch.

You can also open the boot from inside the car via the display.

Button on the boot's interior



Location of the boot closing button.



Press the close button on the inner right side of the boot hatch to close it. Press the button twice to activate a delayed close. The delay is approximately 30 seconds.

You can also use the close button to adjust how far the boot opens. This is useful if you want the boot hatch to stay within easy reach or if you are somewhere with a low ceiling, such as a garage.

Locking with the boot open

Locking the car with the boot open will lock all doors and set the alarm only for the closed doors. If you then close the boot hatch, it will lock and the alarm will be set for the boot.

6.2.3.1. Adjusting boot opening height

You can adjust how much the boot hatch opens.

If the car is often in places with a low ceiling, such as a garage, you may want to reduce the boot opening height. To have more room to access the boot, you can raise the boot opening height.

Once adjusted, the boot hatch will continue to open to the newly set height until changed.

1. Open the boot hatch.
2. Adjust the boot hatch to the desired height using the close button on the inner right side of the boot hatch.



Use the close button marked with the associated symbol.

To lower the boot hatch, move it manually to the preferred height, then press the close button to stop it. If you do not press the close button, the hatch will continue to lower until it closes.

To raise the boot hatch, move it manually to the preferred height.

3. Press and hold the close button for a few seconds to set the new height.
 - > A chime sound confirms that the new height is set.

A height adjustment is saved to the profile being used at that time.

6.3. Locking and unlocking

You have several options for locking and unlocking the car, depending on what keys you use and which settings are enabled.

Locking and unlocking from a distance

Your car can unlock and lock automatically when you approach or leave it with a recognised distance-capable key. You can enable or disable this behaviour in settings.

You can also lock and unlock the car via the Volvo Cars app or, if you have set up a digital key on your device, via your device's wallet app.

Important

It is the driver's responsibility to ensure the car is locked, even when automatic functions are enabled.

Car thieves can use frequency jamming to interfere with key functions and prevent cars from locking. When you leave your car, always check that the driver's door is locked.

Tip

Disable passive entry in wallet app

Many wallet apps have a setting that lets you disable passive entry. When this feature is disabled, your car won't unlock automatically when you get close to it while carrying a digital key. The approach unlock feature will still be available when you use your other distance-capable keys.

Using the driver's door handle

If you want to lock or unlock your car manually while still using a distance-capable key, you can use the touch points on the driver's door handle.

To unlock the car, touch the inside of the door handle. To lock it, place a finger on the small indentation on the outside of the door handle.



The indentation marks where you can place your thumb or fingers to lock the door.

Note

For the touch points to work, you need to keep a recognised distance-capable key where your car can detect it.

To prevent your car from unlocking or locking automatically when you approach or leave it, be sure to disable **Proximity lock** in settings.

If you are in close proximity to the car for long periods of time without opening the driver's door, there might be a delay when you try to open or unlock the car using the driver's door handle. If the car doesn't immediately unlock or open, this is normal. Just wait a few seconds and try again.

Using the key reader

If you're using a key card or a discharged distance-capable key, you can lock or unlock your car by putting the key on the NFC^[1] reader in the door pillar.



Key reading location on the door pillar

Make sure the card or device is laid flat against the reader. If you're using a key tag, the Volvo logo should be facing towards you.

Using the button panels inside the car

You can lock or unlock your car from inside using the buttons on the armrest between the front seats. The lock and unlock symbols are visible on the buttons.



Lock symbol



Unlock symbol

Emergency unlock

In the event of a collision, the car will automatically unlock. If the damage to the car is minor, the car can be locked again. With significant damage to the car, you will not be able to lock the car again. In that case, the locking function can only be restored by Volvo technicians^[2].

Child lock

The child lock can increase passenger safety in the rear seats. When the child lock is active, the passengers in the rear seats are unable to open the rear doors. You can read about how to activate the child lock in a separate section of the manual.

Double pull

Your car's rear doors are equipped with a double-pull feature to help protect against accidental opening. This means that it takes two pulls on the inner door handle to unlock and open the door from inside the car.

Warning

Volvo recommends not leaving people or pets in a locked car. The driver is always fully responsible for the well-being and safety of anyone left inside.

Some regions have laws prohibiting people or pets being left inside a locked vehicle.

^[1] Near Field Communication

^[2] Volvo recommends an authorised Volvo workshop.

6.3.1. Activating child lock

You can activate and deactivate the child lock manually.

Important

The child lock does not affect the rear windows. You can lock the rear windows in settings.

When driving with children in the rear seats, check that the rear doors are secured with an active child lock.

The child lock can increase passenger safety in the rear seats. When the child lock is active, the passengers in the rear seats are unable to open the rear doors.



Child lock switch location.

The child locks are accessed from inside the car and are located on the rear doors.

You need a tool, such as a flathead screwdriver, to activate or deactivate the child locks. The direction for enabling or disabling the locks is indicated around the switch.

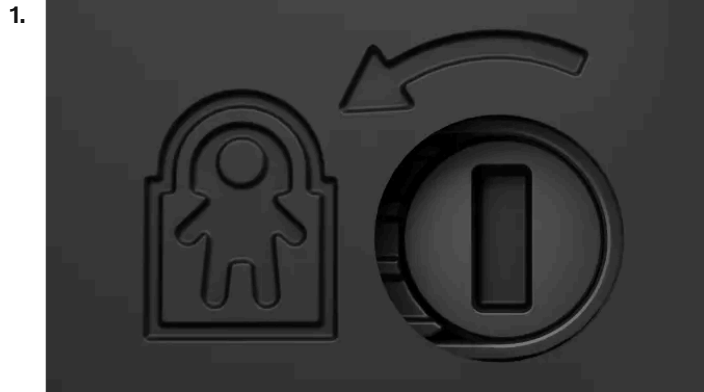

Child lock with turn directions for activation.

Insert a tool into the switch hole.

2. Turn the tool in the indicated direction to enable the lock.

> When the lock is enabled, you will hear a click.

Disabling the child lock

To disable the child lock, use the tool to turn the lock in the direction opposite to the one indicated on the lock.

6.3.2. Settings for locking and unlocking

You can customise how your car reacts when locking or unlocking.

Note

Different settings affect how and when your car is locked. Make sure to familiarise yourself with the different options and how they affect the locking and unlocking behaviours.

Proximity lock

You can choose whether your car should automatically unlock when you approach it and lock when you're walking away from it with the **Proximity lock** setting. For this feature to work, you need to carry a recognised distance-capable key.

General locking behaviour

You can customise many of your car's general locking behaviours. For example, you can turn feedback responses on or off and choose whether all of the doors should unlock automatically when you park.

It's also possible to choose which doors unlock when you use the touch points on the driver door handle.

 **Note**

When the **Proximity lock** setting is enabled, all of the doors unlock or lock simultaneously when you approach or leave the car with a distance-capable key. Disable the **Proximity lock** setting if you want to select which doors unlock.

Presence warning

The presence warning setting allows the car to remind you that there may be passengers or pets still in the car after you lock it. You can turn these warnings off temporarily.

 **Warning**

Volvo recommends not leaving people or pets in a locked car.

Some regions have laws prohibiting people or pets being left inside a locked vehicle.

6.3.2.1. Adjusting locking and unlocking settings

You can adjust several of your car's locking and unlocking responses and behaviours in settings.

 **Important**

Changing locking and unlocking settings

Enabling or disabling certain features affects how and when your car locks and unlocks. Make sure you familiarise yourself with the different key types as well as the locking and unlocking features. Misunderstanding a feature might lead you to believe that your car is locked when it isn't.

It is the driver's responsibility to ensure the car is locked, even when automatic functions are enabled.

1. Press the car symbol  in the bottom bar and go to **Settings**.
2. Go to **Controls** → **Locking**.
3. Adjust your locking and unlocking settings.

 **Warning**

Volvo recommends not leaving people or pets in a locked car.

Some regions have laws prohibiting people or pets being left inside a locked vehicle.

6.3.3. Unresponsive lock

If your car doesn't lock or unlock as expected, there are some steps you can try.

 **Note**

If the car's batteries go completely flat, it will not respond to any key.

If the car has been turned off for a long time, it may take several seconds for it to unlock. This is because the car needs time to turn its systems back on, to recognise the key and to give you access.

Locking not working

If the car won't lock, check that all of the doors are properly closed.

If you are in close proximity to the car for long periods of time without opening the driver door, there might be a delay when you try to open or unlock the car using the driver door handle. If the car doesn't immediately unlock or open, this is normal. Just wait a few seconds and try again.

Automatic locking not working

For the car to automatically unlock when you approach and lock when you leave, make sure that:

- **Proximity lock** is enabled in settings.
- your distance-capable key is charged.
- the key's wireless signals are not being blocked.

If your car doesn't respond when you approach it with your distance-capable key, you can try unlocking it by touching the inner part of the door handle or placing your key on the key reader in the door pillar.

Digital key not working

If you are using a digital key, you can also try:

- turning your device's Bluetooth off and on
- checking that any required access settings are selected
- making sure that your car and device are updated to the latest software version
- restarting your device
- deleting and creating the digital key again.

Rear doors not unlocking

If the rear doors don't open when you pull the inner door handles, make sure the child lock isn't active and that you pull the handle twice. The first pull unlocks the door and the second pull opens it.

6.4. Anti-theft

Your car has a number of systems and features which help to make your car secure when it's locked.

When you lock the car, some of its functions and systems are either shut down or activated to help protect the car from theft. For example, the alarm is automatically armed.



Warning

Do not leave your keys unattended in your car. They can be used to disable the security systems.

Alarm

The alarm is automatically armed when you lock the car and disarmed when you unlock it.

You can adjust the alarm sensitivity in settings.

Immobiliser

The immobiliser is an anti-theft system that prevents your car from being driven until it is started using a valid key. If your car can't find the key or fails to authenticate it, your car will remain immobilised. A notification appears in the display if the key can't be found or has a low battery. If your car is unresponsive to a battery-powered key, try using a key card. If the car appears to have no power, the cause could be flat batteries or something affecting its electrical systems.

Steering wheel lock

Your car's steering wheel lock is automatically engaged when you lock the car. This is to prevent unauthorised driving of your car, such as if it's stolen. When you unlock your car, the steering wheel is also unlocked.

Double lock

The double lock feature allows you to simultaneously lock your car from the outside and the inside. This is to prevent unauthorised attempts to open the car using the inner door handles.

There isn't a specific setting to activate or enable double locking. For double locking to take effect, you need to disable the reduced alarm setting and proximity locking, then lock the doors as usual. The double lock system then activates after a few seconds.

 **Warning**

Volvo recommends not leaving people or pets in a locked car. The driver remains responsible for the well-being and safety of anyone left in the car.

Some regions have laws prohibiting people or pets being left inside a locked vehicle.

 **Note**

Presence warning

By default, the car alerts you when it suspects that there are occupants in the car when locking. When this happens, the car will not activate the double lock. This is intended to help you be more aware of and responsibly use double locking.

 **Tip**

If the double lock is not active but occupants in the rear seats still can't exit the car, check that the child lock is disabled.

6.4.1. Alarm

The alarm helps deter unwanted interference with your car when it's parked.

The alarm is automatically enabled when you lock the car from the outside and disabled when you unlock it.

 **Note**

Locking with bonnet or boot open

If the bonnet or the boot is not properly closed when you lock the car, the alarm won't be fully enabled. In these cases, the alarm will only protect the side doors.

The car also won't detect any motion inside if you've locked it with the bonnet or boot still open.

Once you close the bonnet or boot, it will lock and be covered by the alarm.

Triggering the alarm

The alarm triggers when an unauthorised attempt is made to open the bonnet, boot or any door.

Movement inside the car can also trigger the alarm.

Once the alarm is triggered, the following happens:

- The alarm warning lights flash for up to 5 minutes.
- The alarm sound starts.
- The alarm cycle restarts several times over if whatever triggered the alarm isn't resolved.

 **Tip**

Alarm sensitivity

You can turn reduced alarm sensitivity on in settings, which is especially useful if the car is parked on a ferry where it can be affected by external motion or vibrations.

The alarm may also be triggered if you use a carjack, connect a trailer or have the car towed. In such cases, you should always activate reduced alarm sensitivity.

Stopping the alarm

Unlocking the car while the alarm is triggered will stop any alarm sounds and warning lights.

 **Important**

Do not make any changes or additions to the alarm system, or it may not work properly.

6.4.1.1. Reducing the alarm sensitivity

Reduce the alarm sensitivity when you expect significant movement in or around the car when parked.

This setting is especially useful if the car is parked where it can be affected by external motion, such as when travelling on a ferry.

 **Note**

While the reduced alarm sensitivity setting is active:

- the car won't double lock
- you can't install software updates.

1. Press the car symbol  in the bottom bar and go to **Settings**.
2. Go to **Controls** → **Locking** → **Reduced alarm mode**.
3. Turn reduced alarm sensitivity on or off.

7. Charging your car

Learn how charging works and how you can make each charging session more efficient.



In this section, you can find out more about the different charging types, charging settings, and how to start and stop charging. You can also read about other types of charging-specific information.

7.1. Charging types

Learn more about the different types of charging for your car and how to initiate charging for each type.

 **Warning**

Charging components and high voltage

- The car's charging components carry hazardous currents and voltages. They must be handled with care. Do not perform actions that are not clearly described in the user manual.
- Do not modify or make your own repairs to any charging components. Contact an authorised Volvo workshop for any required repairs or servicing.
- Installation and repairs of at-home charging equipment^[1] must be performed by a licensed electrician.
- Damage to the car's high voltage components, including the traction battery, can cause overheating, fire and serious personal injury. If there is a risk of damage, such as after battery leakage, flooding, fire or a collision, do not use the car. Contact an authorised Volvo workshop as soon as possible. If possible, leave the car outdoors and away from people, buildings, property and other objects that could catch or spread fire.

If you have a pacemaker or similar device

Charging the car may affect the function of an implanted pacemaker or other medical equipment. People with an implanted pacemaker are recommended to consult a doctor before charging the first time.

 **Note**

12 V battery charging

The car keeps the 12 V battery charged as long as the traction battery has sufficient charge.

Condensation during charging

During charging, condensation from the cooling system can collect under the car. This is perfectly normal and is caused by the traction battery cooling down.

AC charging at a charging station or from a charging point at home

AC charging points are available at a variety of charging locations, both public and private. An AC charging point can be installed at home and is the recommended source for regular charging.

AC charging with a household socket

You can charge your car from a regular household socket. This type of charging is only suitable for occasional charging and is not recommended for regular use. If you are planning to charge your car from a household socket, there are additional steps you need to take to ensure it is done safely.

 **Warning**

Do not use visibly worn or damaged electrical sockets as they could cause overheating, electric shock or personal injury.

 **Important**

- The car must only be charged from approved, earthed household sockets.
- Do not exceed the maximum permitted charging current when charging via a regular household socket. Limits imposed by local and national charging recommendations may apply.
- Ensure that the household socket fuse can handle the charging cable's specified current before you start charging. If you are uncertain, the socket must be checked by a qualified and licensed electrician.
- Never connect the charging cable when there is a risk of thunderstorm or lightning strike.

DC fast charging

DC fast charging is available at certain charging stations. These charging stations deliver very high power, as well as shorter charging times.

 **Note**

Charging stations with support for fast charging are usually clearly marked with CCS or Combo.

 **Tip**

Fast charging battery preconditioning

When you set a fast charging station as your destination in Google Maps, your car automatically starts battery preconditioning to improve its charging performance. When preconditioning starts, a notification appears in the display.

Charging cables

There are different charging cables to use when you charge your car. Mode 3 cables are the standard cables to use when charging electric cars. There are different versions of the mode 2 cable available. Mode 2 cables can be used as an emergency solution, but it is not recommended to use them as a daily charging method.

^[1] Including any work on the electric metre housing or power distribution service panel.

7.1.1. Charging cables

When using a charging cable for the first time, always check to make sure it's compatible with your car.

Charging cable recommendations and use

 **Warning**

High voltage

The cable is connected to a hazardous electrical system. Contact with high voltage currents can cause fatality or serious personal injury.

Damaged cables

Do not use a charging cable that shows any signs of damage or wear. It can cause an electric shock. A damaged or malfunctioning charging cable provided by Volvo may only be repaired at an authorised workshop. Contact an authorised Volvo workshop for more information. If you are charging at a charging station, try another cable or charging point.

Excessive wear and debris

Remember to always check the charging cable's connector for excessive wear or debris. Do not touch the charging cable's connector or use any tools to attempt to remove debris from the charging cable. It can cause an electric shock.

Public charging stations are in constant use and can be exposed to more wear and tear than a private charging station.

Cable placement

Remember to place the cable where there is minimal risk of it getting damaged or causing personal injury. A carelessly placed cable can easily get run over or tripped over.

Child safety

Keep children away from charging cables, especially when the cables are plugged in.

 **Important**

Adaptors

Do not use any adaptors between the charging cable and the electrical socket of the car.

Liquids and cables

Do not submerge the charging cable or its components in liquid. If you need to clean the cable, use a clean cloth lightly dampened with water. If needed, use a mild detergent but never use chemicals or strong solvents.

Only use recommended cables

- Only use the cables originally provided with your car or that are recommended by Volvo.
- Volvo takes no responsibility for damage or injury caused by charging equipment not recommended by Volvo.

 **Note**

Recommended cables

Volvo recommends a charging cable according to IEC 62196 and IEC 61851 that supports temperature monitoring.

Charging cable instructions

Before using a charging cable, make sure to read the instructions from the cable's manufacturer.

Some charging stations have a permanently attached charging cable. Be sure to follow the charging station's instructions on how to use it.

Mode 3 cable for charging stations

You can use this type of cable to charge your car at AC charging stations.

Mode 2 charging cables

Use a charging cable with a household plug to charge the car from an ordinary household socket, such as when no other charging options are available.

 **Important**

Do not use this type of charging as a daily charging method.

7.2. Charging view and settings

In the charging view, you can access information about the charging process, start or stop the charging and set different charging settings. You can customise the charging settings according to your preferences. The charging view appears automatically when charging is initiated.

Note

The information content can vary depending on the current charging status.

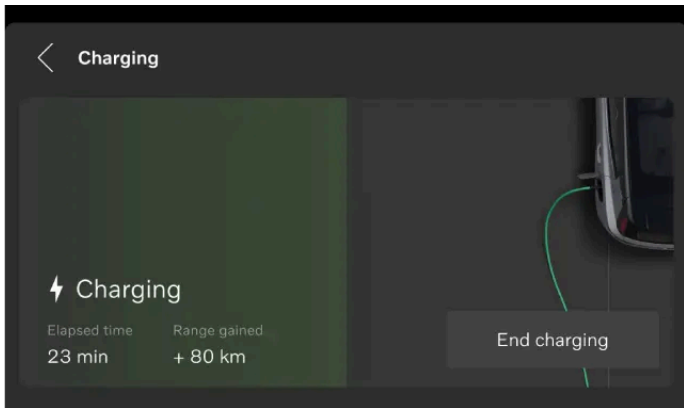

The following information, functions and settings are available in the main area of the display:

- Current battery level
- Target battery level
- Amperage^[1]
- Charging status
- Start or stop charging^[2]
- Set a target battery level for charging
- Limit the electrical current for AC charging
- Add and manage schedules

Tip

You can also access information about battery level, charging status and the charging process in the mobile app for the car.

You can also access the charging view through the settings in the display.

^[1] Amperage is only shown if a limit was set.

^[2] The **Start charging** option is only available when the AC cable is still connected.

7.2.1. Setting a target battery level for charging

You can set a target battery level by selecting a value in the charging view. This will help you to maintain good charging performance and battery longevity.

There are two preset options: **Daily drive** and **Long trip**. **Daily drive** is the recommended charging level which charges your car up to 90%. **Long trip** charges your car up to 100% and can be selected if you want the maximum range possible from your car. You can also choose to customise the target battery level value by selecting **Custom**.



Tip

You can also adjust the target battery level in the mobile app for the car.

1. Press the car symbol  in the bottom bar and go to **Settings**.
 2. Go to **Charging** → **Target battery level**.
 3. Select your preferred battery level.
- > The target battery level value changes. The value is saved until you change it again.

If the battery level is 20% or lower, the battery level status changes to orange.

7.2.2. Setting the amperage limit for charging

You can set an amperage limit for AC charging by selecting a value in the charging view.

The charging current limiting feature is turned off as standard. When the charging current is not limited, the maximum available amperage value is applied. When the charging current is limited for the first time, the lowest available value is applied by default. Ampere, often written as "amp" or "A", is the unit for electric current.

1. Press the car symbol  in the bottom bar and go to **Settings**.
 2. Go to **Charging** → **Limit charging current**.
 3. Turn the function on.^[1]
 4. Adjust the amperage limit to your preferred value.
- > The amperage limit changes and the value is saved until you change it again. When your car is charging, the actual amperage value and the limit are shown in the display.

Note

The amperage limit may vary between regions.

When you turn the function off, the amperage limit that you set isn't saved. This means that you need to set a new limit if you turn the function on again.

^[1] Only available for AC charging.

7.2.3. Adding and managing charging schedules

You can set and activate a charging schedule for your car in the charging view. This means you can specify when you want the car to charge, such as when plugged in overnight.

Note

The charging schedule setting only applies to AC charging. When using DC charging, it will always override the charging schedule and start charging when the charging cable is plugged into the car.

1. Press the car symbol  in the bottom bar and go to **Settings**.
2. Go to **Charging** → **Charging schedule**.

The content of this manual represents the status of the user manual at the time of printing and may not be completely valid in future instances. For more information, refer to the first page for the complete disclaimer note.

3. Select start and stop times for the charging schedule by using the timer.
 4. Activate the schedule by turning it on.
- > The timer is active and the scheduled charging time is visible in the display, both in the main area and in the driver information area.

You can deactivate the schedule by turning it off. The timer will not be active and no scheduled charging is planned.

7.3. Start and stop charging

You can charge your car by using either AC ^[1] charging or DC ^[2] charging. How you start and stop the charging process depends on the type of charging you use.

AC charging is the recommended charging mode for everyday charging as it maintains the condition of the battery over time. AC charging can be used if you are charging from a charging station, a charging point at home or a regular household socket. DC charging is available at certain charging stations and charges your car faster than AC charging. However, it also wears the battery out faster. DC charging can be used when you need to recharge your battery immediately.

^[1] Alternating current

^[2] Direct current

7.3.1. Starting AC charging

AC charging can be done at certain charging stations, from a charging point at home or from a regular household socket. The cable you need depends on the charging mode.

To initiate charging, make sure:

- the car is in park.
- the charging settings are set up according to your preferences. ^[1]

If you are using a regular household socket, also make sure it meets the safety requirements for charging.

 **Warning**

Do not connect any equipment other than the charging cable between the charging source and the car's charging port. ^[2]
It can cause malfunction, damage or electric shock.

1. Connect the charging cable to the charging source. Some charging stations have a permanently attached charging cable that you connect to your car.
2. Open the charging lid by lightly pressing on its rearmost end.



3. Remove any protective covers from the charging port and cable connector.

 **Important**

To avoid damage to the paintwork, position the connector's protective cover so that it does not touch the car.

4. Connect the cable to the charging port.
- > When the cable is fully inserted it locks into place. Charging starts within a few seconds.

You can see the charging status in the charging port and in the display.

Recommended action if charging does not start

First, disconnect the cable from the car's charging port, then from the charging source. Wait a moment before reconnecting it. If the problem persists, contact an authorised Volvo workshop.

^[1] Some settings can be adjusted during charging.

^[2] This includes extension leads, socket splitters, socket adaptors, external timers, overvoltage protection devices and similar devices.

7.3.2. Starting DC charging

DC charging is available at certain charging stations.

DC charging stations have permanently attached charging cables, so you don't need to use your own.

 **Warning**

- Public charging stations are in constant use and can be exposed to more wear and tear than a private charging station. Remember to always check the charging cable's connector for excessive wear or debris.
- Do not touch the charging cable's connector or use any tools to attempt to remove debris from the charging cable. It can cause an electric shock.
- Do not use a charging cable that shows any signs of damage or wear. It can cause an electric shock. Try another cable or charging point at the charging station.
- Ensure that the charging cable's connector connects all the way into the charging port. A worn connector may prevent a safe connection to your car.

To initiate charging, make sure:

- the car is in park.
- to check the charging station for any instructions before you begin.

1. Open the charging lid by lightly pressing on its rearmost end.



2. Remove any covers from the port and cable connector.
3. Use both hands to press the cable's connector all the way into the charging port. Make a habit of pushing the charging cable upwards for a couple of seconds after inserting it to ensure connection and locking.
 - > The charging cable automatically locks in place after a few seconds.
4. After confirming that the cable is locked in place, follow the charging station's instructions for charging authorisation.
 - > Charging starts after an insulation test has been completed by the charging station. It can take a minute to complete.

You can see the charging status in the charging port and in the display.

7.3.3. Stopping AC charging

You can stop the charging process at any time.

 **Important**

Stop the charging session before attempting to unplug the cable from the car's charging port. If you do not, you may cause damage to the cable or to the system.

 **Tip**

When AC charging is stopped, the charging cable unlocks.

Make sure that the car is unlocked.

1. Press the car symbol  in the bottom bar and go to **Settings**.
 2. Go to **Charging**.
 3. Press **End charging**.
- > The charging is stopped and the cable unlocks from the charging port.
4. Unplug the charging cable from the car.
 5. If available, reattach the protective cover on the cable connector.
 6. Depending on the cable you have used:
 - Unplug the charging cable from the charging station.
 - Reattach the charging cable to the station's storage socket.
 7. Reattach the charging port's protective cover and close the charging lid.

 **Tip**

You can also stop the charging process by pressing the **End charging** button in either the welcome view, the home view or in the mobile app.

7.3.4. Stopping DC charging

You can stop the charging process at any time.

 **Important**

Stop the charging session before attempting to unplug the cable from the car's charging port. If you do not, you may cause damage to the cable or to the system.

1. Press the car symbol  in the bottom bar and go to **Settings**.
2. Go to **Charging**.
3. Press **End charging**.
- > The charging is stopped and the charging cable's handle unlocks. This may take a couple of seconds.
4. Unplug the charging cable from the car.
5. If available, reattach the protective cover on the cable connector.
6. Reattach the charging port's protective cover and close the charging lid.

 **Tip**

You can also stop the charging process from the charging station or by pressing the **End charging** button in either the welcome view or the home view.

7.3.5. Releasing the charging cable

If the charging cable doesn't automatically release after you have stopped the charging, there are some steps you can try.

The charging cable usually releases automatically when you have stopped the charging. However, if the charging cable is left in the charging port for a while after charging has stopped, the charging cable is automatically locked in again.^[1]

Make sure that the key is within range and that the car is unlocked.

- Stop charging by pressing **End charging** in the display.
- If you're charging at a public charging station, follow the instructions in the charging station's interface to stop charging.
- Carefully wiggle the charging cable.
- Lock and unlock the car.

- Lock the car and wait until the LED on the car's charging port turns off. This can take some time. After that, unlock the car and try to stop charging via the display again.

If the charging cable still doesn't release, stop charging via the charging station, charging point or household socket in one of the following ways:

- Charging via a public charging station: Contact the charging station's customer service to get help to stop the charging.
- Charging via a home charging point: Safely disconnect the power supply to your home charging point.
- Charging via a household socket: Unplug the cable from the household socket.

If the problem persists, contact an authorised Volvo workshop.

^[1] Applies to AC charging.

7.3.5.1. Manually releasing the charging cable

If the charging cable doesn't release from the car after you have stopped the charging, you can use the emergency release handle. Never use the emergency release handle when charging is in progress.

1. Open the boot and the cargo hatch.
2. Locate the cap on the left side of the boot.



3. Remove the cap by prising it off with a screwdriver or a similar tool.

4.  **Warning**
Before using the emergency release handle, check the display or the charging port to make sure the charging process has stopped. The emergency release handle should not be used when charging is in progress.

Carefully pull the emergency release handle until you feel resistance.



- > The charging cable unlocks from the charging port.

Note

The emergency release handle automatically retracts when the next charging cycle is started.

5. Unplug the charging cable from the car.
6. Put the cap back and close the cargo hatch and the boot.

If the problem persists, contact an authorised Volvo workshop.

7.4. Charging time and statuses

Learn more about charging times so that you have an idea of what to expect in different situations and what the different charging statuses mean.

7.4.1. Charging times

The time it takes to charge your car depends on the charging type and several factors. The charging times mentioned are approximate.

Some examples of factors that can affect the charging time are:

- preconditioning
- ambient temperature
- battery temperature
- charging equipment
- battery size

- battery condition and car condition
- infrastructure
- charging settings such as amperage limit.

AC charging from a household socket^[1]

Current (A) ^[2]	Charging power (kW)	Charging time (hours) ^[3]
10	2.2	39.5
16	3.6	23.5
32	7.2	11.5

AC charging at a charging station or from a charging point at home

Current (A) ^[2]	Charging power (kW)	Charging time (hours) ^[3]
10	6.8	12.5
16	11	8
32	22	4

Tip

If your charging point at home is equipped with load balancing and can handle more than 6A, you need to set a charge limit that matches the maximum current that the charging point can provide. You can set the charge limit in the charging view.

DC charging at a charging station

Station power (kW) ^[4]	Charging time (minutes) ^[5]
50	56
175	30

Note

The battery can charge the fastest when the battery level is low. After reaching 30%, the maximum charging speed gradually decreases as the battery level increases.

Tip

When you use Google Maps to set a fast-charging station as your destination, the car preconditions the battery to improve charging performance once you get there.

^[1] Using a 200-240 V socket.

^[2] Maximum charging current may vary depending on region.

^[3] From 0-100%

[4] Maximum power that the charging station can supply.

[5] Applies at 10-80% state of charge provided that the temperature of the battery is approximately 25 °C-30 °C (77 °F-86 °F).

7.4.2. Charging status

The car's charging status is shown using different colours, both in the charging port and in the display.



- ① Charging status information in the display
- ② Charging status information in the charging port



The charging port light only indicates the current status of the charging cycle. If you would like more comprehensive information, you can find this in the display.



i Tip

You can also access information about the charging status in the mobile app for the car.

7.4.2.1. Charging status in the charging port

You can see the car's current charging status in the charging port.

Colour	Colour name	Description
	White, solid	The charging lid is open and no cable is connected or the cable is connected but the car is not charging.
	Yellow, solid	The charging cable is attached and the battery is being preheated.
	Green, pulsating	Charging is in progress or the cable is unlocked.

Colour	Colour name	Description
	Blue, solid	Charging is scheduled.
	Green, solid	The car is either done charging or has stopped charging.
	Red	Charging fault. Check the display for additional information. Always make sure that the charging cable is correctly connected to the car's charging port and that the power source, such as the cable or the charging station, works correctly. If an error is indicated, try to disconnect the cable from the car then reconnect it and re-initiate charging to see if the problem is solved. If the problem persists, contact an authorised Volvo workshop.

7.4.2.2. Charging status in the display

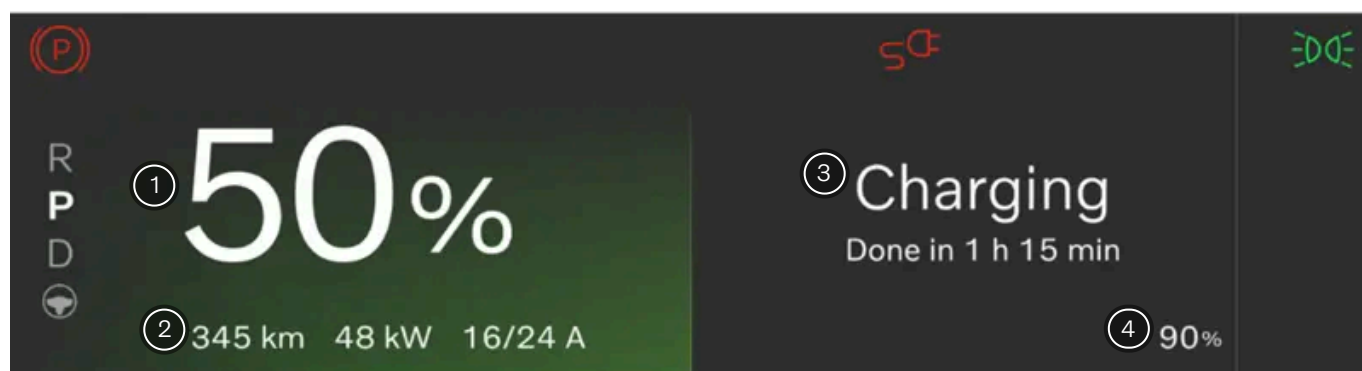

You can see the car's current charging status in the display.





Information available in the driver information area.

- ① Battery level information
- ② Current range, charging power and amperage^[1]
- ③ Charging status information
- ④ Target battery level

The driver information area contains charging status information such as status text, battery level, current range, amperage, remaining charging time and scheduled time information. Different colours of the progress bar are also visible. The information may vary depending on the charging status.

Status	Colour	Colour name	Description
Waiting...		White, solid	The cable is connected but the car is not charging. The status can also be visible when heating or cooling is needed before starting the charging session.
Charging		Green, pulsating	The car is charging manually. ^[2]

Status	Colour	Colour name	Description
Scheduled		Blue, solid	The cable is plugged in and your car is scheduled to charge at a later time. Information about the scheduled time is visible in the display.
Charging ended and Cable unlocked		Green, solid	The car is either done charging or has stopped charging. When AC charging is stopped, the charging cable unlocks. The charging process is temporarily paused and the charging cable can be removed.
Charging fault		Red, solid	The cable is plugged in but there is an error in the charging connection. Depending on the error, the display shows different messages. If the problem persists, contact an authorised Volvo workshop.

[1] Amperage is only shown if a limit was set.

[2] AC manual, AC scheduled, DC.

8. Driving

Your car is designed for driving. This section covers the essential driver controls that allow you to start, stop, steer and change gears. You can also find information about driving characteristics and handling here.



Many of your car's driving features can be customised for a personalised experience. While some features are more directed towards comfort, others are strictly safety related. It's important to check your driving position, maintain good visibility and to always stay attentive and focused while driving.

8.1. A typical driving cycle

This description provides an overview of your car's capabilities and behaviour in the different stages of a typical driving cycle.

A driving cycle starts when you unlock your car and ends when your car is powered down after driving.

The different situations and scenarios described here have their own sections in this manual with more detailed information.

Approaching and unlocking

Your car unlocks differently depending on which type of key you use. When your car unlocks, it also powers on.

Entering

When you enter your car, it can automatically select your profile if you use a connected key. It adjusts the driver's space and applies your profile settings for features and car behaviour. Additional features can be accessed when you are seated and ready to drive, such as climate and comfort.

Beginning your drive

The type of key you are using affects how you start the car. If you are using a key card or a discharged key, it needs to be placed on the card reader for you to be able to start driving. If your car detects a distance-capable key, you just have to keep it inside of the car.

To start driving, press the brake pedal and select a gear. Your car can notify you of any open doors, unbuckled seatbelts or other issues related to driving.

Tip

There's information in this manual that might be useful, depending on what kind of journey you're about to go on. For example, you can find information about your car's stowing capabilities or what you need to think about when driving in winter conditions.

Parking

Your car will automatically apply the parking brake and enter a parked state. This is part of a gradual power-down as you get ready to leave the car. If you want to remain in your car after parking, with the climate and media features still available, you can activate the parking comfort feature.

You can also manually activate the parking brake by pressing the P button on the right-hand steering wheel stalk.

Powering down, locking and leaving

When you leave and lock your car it will gradually power down. This is done automatically and the car will enter a stand-by state.

You can also manually turn your car off via the display.

Tip

If possible, charge your car when you leave it for longer periods of time.

8.2. Trips app

The Trips app is a driving journal that automatically logs all trips made with your car.

When this app is enabled, it automatically collects your car's identification number^[1], location and other trip-related data, such as time, distance and battery consumption.

Note

The Trips app calculates the battery consumption based on pure consumption during a trip. If you see a different value in your car's trip meter, it's because the trip meter also takes energy regeneration into account.

In the mobile app, you can:

- View, manage and delete all of your trips.
- Export your driving journal.
- Stay informed if a trip isn't uploaded due to an issue, such as network problems.

When the Trips app is enabled, all users that have paired the mobile app with the car can see the trips. If the Trips app is disabled, the car stops sending information about new trips.

 **Note**

Car location sharing

You need to enable car location sharing in the display and in the mobile app to start logging your trips.

Storage limits

When a trip is logged, it can be stored in the Trips app for up to 400 days. The app has the capacity to store approximately 500 trips. When this limit is reached, older trips are automatically deleted to free up space and make room for new trips.

 **Note**

If the journal isn't logging trips, the reasons for this might include:

- Weak or no network connection.
- The app isn't receiving GPS coordinates.
- Location permissions are disabled so the Trips app can't access the car's location.

[1] VIN

8.3. Starting the car

Starting your car requires a present and correctly used key along with pressing down the brake pedal and selecting a driving gear.



Your main interaction points for starting your car are the brake pedal and the gear stalk.

If you are using a distance-capable key, your car gradually powers on when you approach it and take your seat. If you are using a key card or a distance-capable key with a flat battery, you must unlock the car manually for it to power on. Many features, such as the climate system, will be accessible once you enter your car.

To start your car, press down the brake pedal and select a driving gear.

Before you start driving, make sure that:

- All doors are closed.
- All occupants are properly seated and wearing their seatbelts correctly.
- The driver's seat, steering wheel position and mirrors are adjusted to your driving position.
- No charging cables are connected.
- The driver area is unobstructed and that the pedals are freely moveable.

i Tip

The car can alert you to certain conditions you should address before driving. If something is preventing you from starting the car, have a look in the driver information area for guidance.

i Note

If your car is equipped with an alcohol lock, you need to take and pass a breath test before starting the car.

1. If you are using a distance-capable key, make sure to keep it with you.

The content of this manual represents the status of the user manual at the time of printing and may not be completely valid in future instances. For more information, refer to the first page for the complete disclaimer note.

If you are using a key card or a discharged distance-capable key, place it on the card reader.

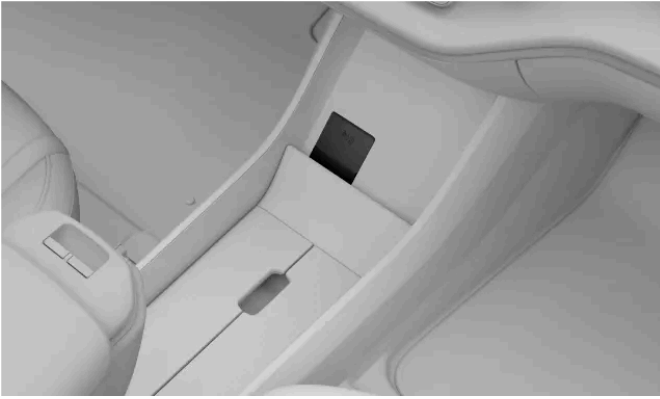

The location of the key card reader, used if you start the car with a key card or a discharged distance-capable key.

2. Press and hold the brake pedal down.
 3. Select D or R using the right-hand side steering wheel stalk.
- > The selected gear is indicated in the driver information area. The ready symbol also appears, emphasising the transition from parked to a driving gear.

READY

***i* Note**

The ready symbol disappears when the car's speed exceeds walking pace. It reappears whenever the car slows down below the same threshold.

8.3.1. Start-up checks

When you select a gear to start driving, the car performs a number of self-checks of important systems and functions. This short test is indicated in the driver information area.

The start-up check is indicated by several warning and indicator symbols in the driver information area. If any of the warning or indicator symbols remain visible after a few seconds, it tells you that there's a fault or condition you need to address before driving.

If a fault is indicated:

- Read any related information presented in the driver information area.
- For additional information about warning and indicator symbols, consult that section of the manual.
- Resolve the indicated fault before driving.
- If you cannot resolve the issue yourself, do not hesitate to contact an authorised Volvo workshop.

After the start-up check is performed, the car continues to actively monitor many of its systems and functions.

The content of this manual represents the status of the user manual at the time of printing and may not be completely valid in future instances. For more information, refer to the first page for the complete disclaimer note.

8.3.2. Alcohol lock

The alcohol lock is a safety measure to prevent driving under the influence of alcohol. If your car is equipped with an alcohol lock, you must take and pass a breath test before you can start your car.

If you have connected an alcohol lock, it will integrate with some of your car's systems. This means that you can receive messages from the alcohol lock directly in the driver information area. Alcohol lock calibration should be done in accordance with the local laws and regulations on the limit value in force for driving legally.

For information about a specific alcohol lock, please refer to the relevant alcohol lock manufacturer.

Warning

The alcohol lock is an aid and does not exempt the driver from responsibility. It is always the responsibility of the driver to be sober and to drive the car safely.

Using an alcohol lock

The alcohol lock automatically activates to be ready for use when the car is unlocked. Follow the instructions included with the installation of the alcohol lock, along with the messages presented in the driver information area.

After completing a driving cycle, meaning that you have driven and then stopped, your car can be restarted within a few minutes without requiring a new breath test.

Tip

Accurate measurement

Avoid eating or drinking approximately five minutes before the breath test.

Avoid excessive windscreen washing as the alcohol in the washer fluid may affect the alcohol lock.

Emergency bypass of the alcohol lock

In the event of an emergency or if the alcohol lock is not working, it is possible to bypass the alcohol lock. To do this, see the instructions provided with the alcohol lock or contact the manufacturer.

8.4. Turning the car off

The car typically powers down automatically but you can also manually turn it off in the display.

Your car can automatically turn itself off after you leave it and lock it from the outside. However, in some situations, you may want to manually turn it off. This can be done in the display.

 **Note**

Leaving your car without locking it starts a 30-minute timer before the car automatically turns itself off. If you return to the driver seat before the timer runs out, it will be cancelled.

To turn the car off manually, the car has to be in P. If the parking brake has not been automatically applied, press the parking brake button.

Turning the car off manually

1. Press the car symbol  in the bottom bar and go to **Settings**.
2. Go to **Controls** → **Vehicle modes** → **Turn off car**.
3. Turn the car off.
 - > The car powers down.
 - > The car can now be locked and left.

 **Note**

After being turned off, a number of essential systems remain available, such as key detection, alarm, internet connectivity and battery monitoring. Under normal conditions, they only use a small amount of power.

8.5. Driving characteristics

Explore the features that affect driving performance and dynamics. This can allow you to customise your driving experience.



Your car has several features that affect your car's driving dynamics and performance.

- One pedal drive** This allows you to both brake and accelerate using only the accelerator pedal. The function can be turned on or off in the display.
- Drive modes** You can configure the car for daily driving or set your car's power delivery to prioritise range or performance.
- Electronic stability control** You can turn the electronic stability control^[1] off if you want a more active driving experience or if you are stuck in mud or deep snow.
- Hill descent** By activating hill descent, your car can brake in a more controlled and active way. This can be useful if you are driving downhill at low speeds.
- Steering feel** Adjusting the steering feel affects the steering wheel resistance and firmness.



Tip

Exterior sound

Your car plays an artificial driving sound when you are driving at low speeds. This is to alert others of your presence.

^[1] ESC

8.5.1. Drive modes

The drive modes change the driving dynamics of your car.

The different drive modes available in your car are all suitable for different scenarios and types of driving. Depending on which drive mode you select, certain driving dynamics may be affected, such as steering, braking and acceleration. Your car's fuel consumption and estimated range are also affected.

The car has three drive modes:

The content of this manual represents the status of the user manual at the time of printing and may not be completely valid in future instances. For more information, refer to the first page for the complete disclaimer note.

- Standard** This is the default mode and is recommended for everyday use. It's also selected automatically every time you start the car.
- Range** This mode limits climate and driving performance to maximise range.
- Performance** The performance mode lets your car prioritise performance over range, which allows for a more active and dynamic driving experience.
-

8.5.1.1. Selecting a drive mode

You can select a drive mode in settings.

Your car is equipped with different drive modes for different driving conditions and situations. Selecting a drive mode allows your car to adjust the driving characteristics and dynamics for the intended use, which might disable certain settings. You can select a drive mode in settings.

The standard drive mode is selected by default every time you start your car.

1. Press the car symbol  in the bottom bar and go to **Settings**.
 2. Go to **Driving** → **Driving dynamics** → **Drive modes**.
 3. Select a drive mode.
- > Your car's driving characteristics and settings are adjusted, depending on your selected drive mode.
-

8.5.2. One pedal drive

You control both braking and acceleration with the accelerator pedal when One pedal drive is active.



The braking behaviour changes through the use of the accelerator pedal. When you press the accelerator, the car accelerates as normal but releasing the pedal engages braking. The more you ease up on the pedal, the more braking action you get.

Regenerative braking is prioritised by One pedal drive. However, the disc brakes can be applied if the braking action demands it.

To conserve battery power, One pedal drive can be used in driving sessions where you expect to vary your speed.

 **Important**

You can only use One pedal drive after buckling your seatbelt and selecting driving gear D. Otherwise, no braking force will be applied when you ease up on the accelerator, even if One pedal drive is enabled in settings.

 **Warning**

Keep the brake pedal in mind

There is a limit to the braking force that can be applied by releasing the accelerator when using One pedal drive. For hard braking you need to use the brake pedal.

8.5.2.1. Adjusting One pedal drive

Braking by using One pedal drive can be adjusted, enabled or disabled in drive settings.

The level of applied braking force from One pedal drive can be adjusted in settings.

The available One pedal drive settings are:

Off The function is off. Releasing the accelerator does not engage the brakes.

Low When you ease up on the accelerator, the car will apply regenerative braking.

High When you ease up on the accelerator, the car will brake with more force than in the low setting.

 **Tip**

Quick access

The adjustment settings for One pedal drive are available in quick controls and via the customisable steering wheel button  as well. These allow you to quickly adjust the level of braking force from One pedal drive without going into settings.

 **Warning**

Keep the brake pedal in mind

There is a limit to the braking force that can be applied by releasing the accelerator when using One pedal drive. For hard braking, you need to use the brake pedal.

1. Press the car symbol  in the bottom bar and go to **Settings**.
2. Go to **Driving** → **Driving dynamics** → **One Pedal Drive**.
3. Select a setting.

8.5.3. Enabling automatic creeping

When creeping is enabled, the car can automatically move slowly without you using the accelerator. Automatic creeping can be enabled or disabled in settings.

When you start the car or if you're at a standstill with creeping enabled, the car will begin creeping after you release the brake pedal. Once the car is moving, you can release the accelerator to make the car slow down and start to creep.

Automatic creeping can be useful in driving situations such as traffic queues or car parks.



Tip

Pressing down hard on the brake pedal temporarily pauses creeping and activates auto hold. Press the accelerator to initiate creeping again.

1. Press the car symbol  in the bottom bar and go to **Settings**.
2. Go to **Driving** → **Driving dynamics** → **Creep forward**.
3. Turn it on or off.

8.5.4. Activating hill descent

Hill descent can help you with speed control during steep downhill driving.

By activating hill descent, your car can brake in a more controlled and active way. This can be useful if you are driving downhill, as it can help you avoid unwanted acceleration. You can activate hill descent in the display.



Hill descent availability is indicated with the hill descent symbol in the driver information area. The symbol turns green when hill descent is active.

 **Note**

Hill descent is only available at speeds below 40 km/h (25 mph). If you drive faster than this, the function will be deactivated.

1. Press the car symbol  in the bottom bar and go to **Settings**.
2. Go to **Driving** → **Driving dynamics** → **Hill descent**.
3. Activate hill descent.

8.5.5. Stability control

Your car has stability control systems in place that can help to prevent skidding.

Electronic stability control

Electronic stability control^[1] can automatically apply your car's brakes to prevent skidding when your car detects a loss of traction or steering control. To do this, ESC applies the brakes to each wheel individually. When this intervention happens, the symbol for ESC flashes in the driver information area.



The function can be turned off to allow for a more active driving experience. It can also be useful to turn ESC off if the car is stuck in mud or deep snow.

 **Note**

Towing a trailer

When you are towing a trailer, the electronic stability control should always be enabled as it helps to prevent snaking. You can read more about this in the manual section about towing.

Your car's stability control includes several other features, such as:

Anti-lock braking system ^[2]	The car's anti-lock braking system prevents the brakes from locking up during hard braking. This improves manoeuvrability and helps with stabilising the car.
Trailer stability assist	This is part of the ESC and can intervene if snaking is detected when you are towing a trailer.
Spin control and active yaw control	These features act to prevent the wheels from slipping against the road surface.
Regeneration stability control	Helps with preventing wheel locking when regenerative braking is applied.

 **Note**

Some of the other stability functions are partially disabled as a part of turning the ESC off. None of them are completely turned off, but their threshold of activation will be increased to allow for a more active driving experience.

[1] ESC

[2] ABS

8.5.5.1. Disabling electronic stability control

You can disable the electronic stability control for a more active driving experience.

Electronic stability control [1] can be turned on or off in the display. When it is turned off, it is still active to a certain extent for safety reasons. However, turning the function off limits the interactions by ESC. This can give you a more active driving experience as more control is transferred to the driver. ESC will still interfere and help the driver in many scenarios.

Turning ESC off can also be useful for off-road driving, or if the car is stuck in mud or deep snow.

When ESC is deactivated, the stability system off symbol is shown in the driver information area.



1. Press the car symbol  in the bottom bar and go to **Settings**.
2. Go to **Driving** → **Driving dynamics** → **ESC OFF**.
3. Turn ESC on or off.

The function resets when the car is powered down.

 **Note**

Disabling ESC also disables lane keeping aid.

[1] ESC

8.5.6. Suspension

Your car has suspension designed to create a pleasant driving experience.

Your car's suspension affects the comfort and handling of your drive. The suspension is fully automatic and cannot be customised or adjusted in any way.



Warning

The shock absorbers are gas pressurised. Do not heat or open the shock absorbers.

8.6. Range

Your car's expected range is shown in the display and depends on several factors.

380 km  80%

Your range is primarily related to your car's battery level and your driving practices but external conditions can also be a factor. The battery level and expected range are displayed in the driver information area. The expected range tells you how far you can drive with the current battery level. It is calculated based on your driving pattern, both current and historical, and on real-time driving conditions.

Factors that affect your car's range

How you drive your car, which settings or features are activated, weather conditions and traffic can all affect your car's range in different ways.

Speed	Driving at higher speeds drains the battery more.
City driving and traffic situation	Varying your speed by frequently accelerating and braking will increase your battery consumption compared to keeping a constant speed.
Eco driving	Keep track of your driving and consumption to drive as economically as possible.
Range mode	Selecting the range mode will limit climate and driving performance to maximise range.
Outside temperature	The outside temperature can affect your battery consumption and range.
Battery temperature	A cold battery is less efficient and needs more energy to be heated.
Preconditioning	By preconditioning your car, you can decrease the energy used to heat it up as well as the battery. This can be done in the climate settings.
Climate settings	Which climate features are activated and to what extent affects your battery consumption.
Tyres and tyre pressure	Tyre condition and tyre pressure can affect your range.

Road condition and topography

The condition of the road, along with any potential slopes, can affect your car's battery consumption.

Towing

Towing a trailer demands more power from your car and will therefore adversely affect battery consumption. This is relative to the type of trailer being towed.

Range in cold temperatures

Your car's battery can be negatively affected by cold temperatures. When the car has a cold battery, a snowflake ❄ appears next to the battery percentage. This indicates that the battery's charge capacity and range are reduced compared to normal conditions. You can avoid this by always charging your car while it's parked, which can prove especially useful if you are parking in a cold climate.

Factory reset and range value

After a factory reset, or when the car is delivered from the factory, the estimated range is based on a certified value. After driving your car for a while, the estimated range is instead based on your historical driving patterns. You can change this back again in settings in the display.

8.6.1. Trip information

Trip information can provide you with an overview of your current consumption along with your trip meter.

You can view trip information such as mileage, average consumption and average speed. There is also a setting to show the current consumption in the driver information area of the display.

This information is accessed by pressing the car symbol  in the bottom bar and going to **Car status**.

The trip information is divided into:

- Current trip** Information from your current trip. This can be set to show data from your ongoing driving cycle or since you last charged your car.
- Since last reset** Displays information about your trip since the last time you reset the trip meter.
- Consumption** You can view your consumption, which is separated into spent and regenerated energy.

Trip information symbols

Different symbols represent different types of data in the trip information:



Distance driven.



Your average consumption.



Your average speed.



How much time has passed since you began your current trip.

8.6.1.1. Resetting the trip meter

You can reset your car's trip meter.

The trip meter can show you information such as mileage, average consumption and average speed.

1. Press the car symbol  in the bottom bar and go to **Car status**.
2. Go to **Trip info** → **Since last reset** → **Reset**.
3. Reset the trip meter.

8.7. Steering

Get familiar with your car's steering-related functions.



Your car has been designed to provide a responsive and intuitive steering experience. Be sure to adjust your driving posture and preferred steering feel before driving.



Tip

Steering and driver support interactions

Several of your car's driver support features can affect the steering. Read the user manual sections about these features for a more complete understanding of how they can interact with and affect your steering experience.

Speed-dependent steering response

The steering resistance and firmness change with the speed of the car. At low speeds, steering resistance is low for precision manoeuvring. At high speeds, the steering adapts to be firmer.

Steering feel

You can adjust the steering feel via the settings in the display. Steering feel affects the firmness of the steering wheel's turning.

8.7.1. Steering wheel

Get to know the steering wheel and some of its features.

You can use your steering wheel for more than just steering the car.



Heated steering wheel

The steering wheel has built-in heating. The function can be turned on manually or set to automatic activation.

Adjust the steering wheel position

The steering wheel can be adjusted to suit your driving posture.

Steering wheel touch buttons

There are touch zone buttons on the steering wheel that can control certain settings and adjustments.

Horn

The button for the horn is located in the middle of the steering wheel and is indicated with the horn symbol .

Note

Steering wheel lock

Your car's steering wheel lock is automatically engaged when you lock the car. This is to prevent unauthorised driving of your car, such as if it's stolen. When you unlock your car, the steering wheel is also unlocked.

8.7.1.1. Steering wheel controls

The steering wheel has several buttons and control surfaces. They control specific functions such as the horn, as well as certain settings, adjustments and what's shown in the driver information area.







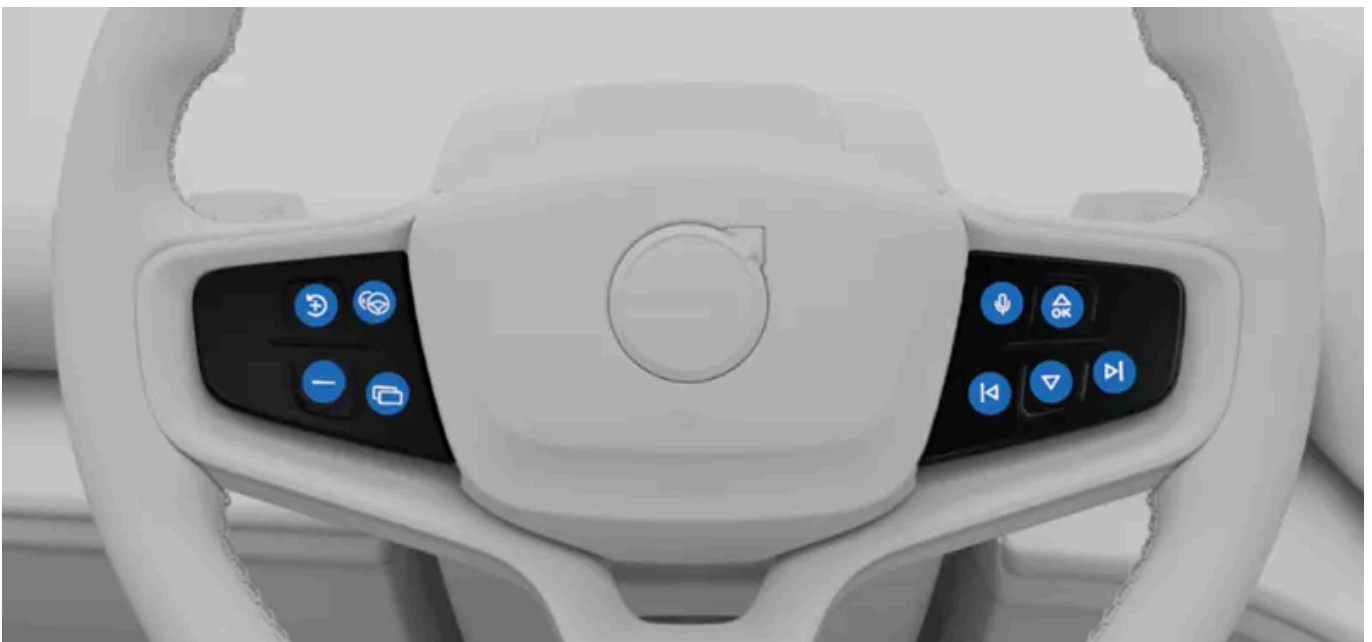

- Horn
- Touch-sensitive buttons
- Left-hand stalk
- Right-hand stalk

Touch-sensitive buttons



⏪ Resume or increase set speed

- Decrease set speed
-  Alternate steering assist
-  Customisable button
-  Voice control
-  Increase volume or confirm
-  Decrease volume or decline
-  Media: Previous or rewind
-  Media: Next or fast forward

The buttons' functions change depending on the context and they typically control what's currently shown in the display.

You can set the customisable button to always correspond to a certain action.

Interacting with the touch-sensitive buttons

The buttons on the right-hand side of the steering wheel often control what you see on the right-hand side of the driver information area. The buttons on the left-hand side often control what you see on the left-hand side. The driver information area in the display typically shows which action each zone is assigned to.

You can find the touch button zone you're looking for by moving your finger across the buttons. The display reacts and shows what the button's assigned behaviour or action is. When the function you want is indicated, press the button.

8.7.1.1.1. Assigning an action to the customisable button

You can set the customisable steering wheel button to correspond to a certain action.

You can assign a specific action to the customisable steering wheel button . By doing this, you select which function you want to be able to control with it.

The available settings are:

- Screen view Switch between display modes in the driver information area.
- One pedal drive Adjust One pedal drive settings.
- Speed limit warnings Turn speed limit warnings on or off.

1. Press the car symbol  in the bottom bar and go to **Settings**.
2. Go to **Controls** → **Steering wheel controls** → **Customisable button**.
3. Assign an action to the customisable button.

8.7.1.2. Adjusting the steering wheel position

You can adjust the steering wheel position to suit your driving posture.

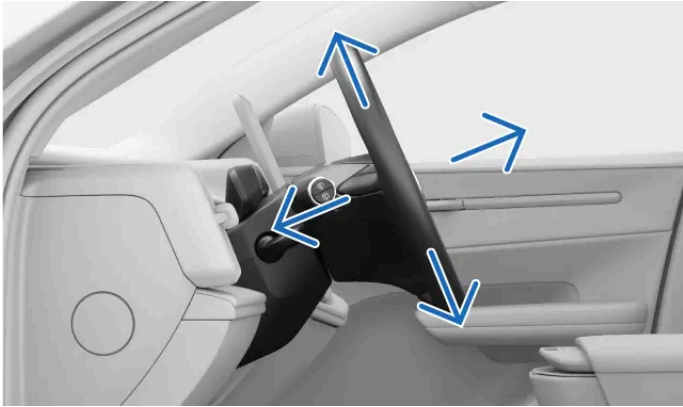

Adjusting the steering wheel position is fundamental to your driving posture, allowing you better comfort and control of the car.

 **Warning**

Make sure that you adjust your steering wheel position when you are parked as this should not be done whilst driving.

1. Push the steering wheel adjustment lever located on the steering wheel column.

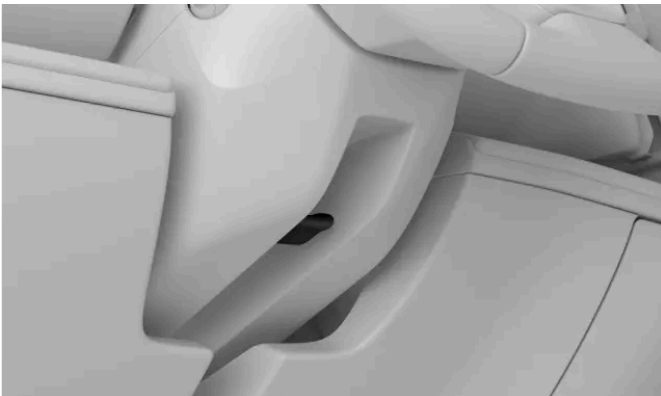

2. Grasp the steering wheel and adjust its position.

Move it up or down and backwards or forwards to fit your driving posture.

3. Pull the steering wheel adjustment lever up to secure the position of the steering wheel.

 **Important**

Once you've finished adjusting the steering wheel position to your liking, it's important to make sure other parts of the car are aligned correctly. Your driving posture is important and is affected by more than your steering wheel adjustments, such as the position of your seat and mirrors.

8.7.2. Adjusting steering feel

You can adjust the steering wheel resistance and driving feel via settings.

A range of predefined settings are available to control the steering feel. These options are selected in the display.

Note

Your car has speed-dependent steering wheel resistance in addition to the manually adjusted steering feel. This means that your car automatically adjusts the steering wheel resistance in line with your driving speed, giving you enhanced control and stability.

1. Press the car symbol  in the bottom bar and go to **Settings**.
2. Go to **Driving** → **Driving dynamics** → **Steering feel**.
3. Select a steering feel setting.

8.8. Brakes

Your car has several types of braking functions, both manual and automatic.



Your car has several features and capabilities when it comes to braking.

- | | |
|-----------------------------|---|
| Foot brake | Your main way of braking manually. Pressing the brake pedal may activate regenerative braking or engage the friction brakes, depending on the driving conditions. |
| One pedal drive | When One pedal drive is active, you control both braking and acceleration with the accelerator pedal. |
| Regenerative braking | Slows the car down by using the car's movement to charge the battery. ^[1] |

The content of this manual represents the status of the user manual at the time of printing and may not be completely valid in future instances. For more information, refer to the first page for the complete disclaimer note.

Friction brakes	Slows the car down by engaging the disc brakes.
Parking brake	Keeps the car in place while parked.
Auto hold	Automatically applies the brake to hold the car when coming to a stop.
Automatic braking	This is a general term for the car's braking interventions. Several driver support and safety systems can intervene and perform braking manoeuvres for safety reasons or convenience.
Post-impact braking	Automatic braking after severe collisions to avoid further hazards.
Electronic stability control^[2]	Helps prevent skidding and other stability-related issues by automatically applying the brakes.

Note

Brake lights

Your car's brake lights automatically light up during braking manoeuvres. The lights respond to manual braking from brake pedal use and One pedal drive, as well as automatic braking from any driver support system.

Emergency brake lights

During hard braking manoeuvres, or if the ABS system is activated, your car's emergency brake lights can activate. This causes the brake lights to flash to alert vehicles behind you. Your car's hazard warning lights can also be activated in these situations, but only after the car has slowed down to a speed below 10 km/h (6 mph).

^[1] Converts kinetic energy to electricity

^[2] ESC

8.8.1. Foot brake

The foot brake engages different types of braking mechanisms, depending on the situation.



The foot brake engages either regenerative braking or the friction brakes, depending on how hard you press the pedal. Light braking activates regenerative braking, whereas harder braking engages the friction brakes.

 **Note**

Automatic disc brake engagement

Regenerative braking often covers the majority of your braking needs. Therefore, it's possible that the disc brakes won't be engaged for long periods of time. To keep them clean, dry and ready for use, the car will regularly engage the disc brakes along with regenerative braking in light braking manoeuvres.

Electronically controlled braking^[1]

The foot brake is electronically controlled. As the braking force is transmitted electronically rather than physically, there are no natural reaction forces travelling from the brakes to the pedal.

Anti-lock braking system^[2]

The car's anti-lock braking system prevents the brakes from locking up during hard braking. This improves manoeuvrability.

 **Note**

P button

At high speeds, pressing and holding the P button slows the car down at a steady rate. This provides a backup alternative to braking normally. Only use the P button in this way if you are unable to brake using the brake pedal.

Start-up checks

Several brake systems are part of the car's start-up check. Make sure to resolve any indicated brake faults before driving.

 **Warning**

Wet brakes

The car's stopping distance is longer if the brake discs are wet. If they have been exposed to water, safely perform a braking manoeuvre to remove water from the brakes. By engaging the disc brakes while driving, they heat up and dry.

^[1] Also called brake-by-wire.

^[2] ABS

8.8.2. Parking brake

The parking brake engages when you transition from a driving gear to the car's parked state.

The parking brake locks the car's rear wheels. When parked, the car monitors and automatically tightens the grip if necessary.

By pressing the stalk button marked P, you put the car in park and the parking brake is engaged.^[1]

Your car will automatically engage the parking brake in several situations. These include:

- Your car has been stationary in auto hold for a longer period of time.
- You leave your car.
- A charging cable is connected to your car.
- At the end of an assisted parking manoeuvre.

The driver information area indicates when the car is in park and the parking brake is engaged.

 **Warning**

Avoid parking on a slope during winter conditions. The tyres might lose traction, even if the parking brake is engaged. You are always responsible for safe parking. Check the parking brake warning symbol for the parking brake status.



Automatic release

The parking brake releases automatically when you select a driving gear.

 **Note**

P button

At high speeds, pressing and holding the P button slows the car down at a steady rate. This provides a backup alternative to braking normally. Only use the P button in this way if you are unable to brake using the brake pedal.

^[1] The car needs to be stationary to be put in park.

8.8.2.1. Engaging the parking brake

Engage the parking brake by pressing the button marked P on the right-hand steering wheel stalk.

Your car can automatically apply the parking brake in several situations. You can also apply the parking brake manually.

1. After coming to a stop, press the button marked P on the right-hand steering wheel stalk.

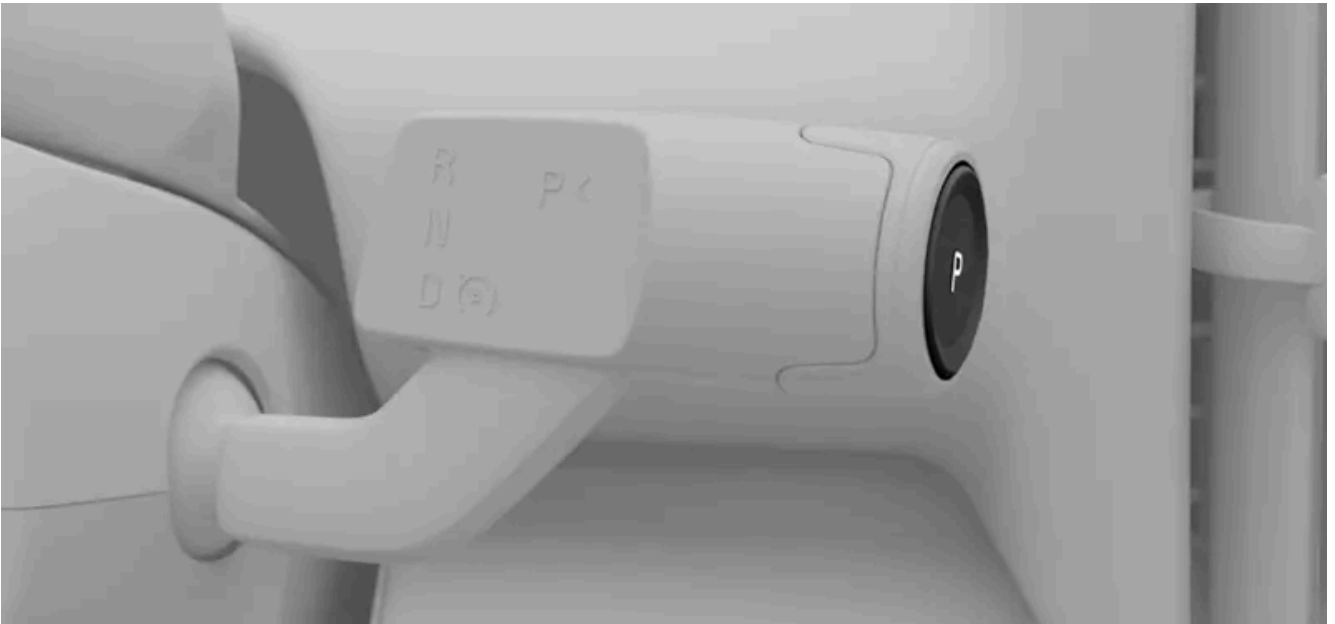

- > The car transitions to a parked state, which includes engaging the parking brake. The new state is indicated in the driver information area.



The parking brake releases automatically when you select a driving gear.

8.8.3. Auto hold

Auto hold helps to keep the car stationary after coming to a full stop, allowing you to release the brake pedal.

When the car comes to a stop while automatic creeping is enabled, auto hold will only activate automatically if the necessary conditions are met. When creeping is disabled, the car will slow down gradually until it comes to a standstill. Auto hold is then activated automatically.

Activation of auto hold is indicated by the auto hold activation symbol in the driver information area.



To exit auto hold and continue driving in the selected gear, press the accelerator. If you are in gear D, you can also exit auto hold by changing gear.

Important

If you're at a standstill on a slope and the car starts rolling downwards, auto hold will activate automatically.

 **Note**

Transitioning from auto hold to parked

Your car will transition to P if auto hold is active for several minutes, if you unbuckle your seatbelt or if you open the driver door.

Conditions

Auto hold is available when you are in gear D. You must also have your seatbelt buckled and the driver door closed.

8.8.4. Post-impact braking

The car automatically applies the brakes when a severe collision is detected. This can reduce the risks associated with additional impacts.

In the moments after a collision, the car may still be moving at high speed. There is also a major risk that the driver is not in full control of the car, which could lead to additional impacts.

In the event of a severe collision^[1], automatic braking reduces your speed in a controlled manner, bringing the car to a halt. Reducing your speed is especially important if there are pedestrians, vehicles or objects in the car's path.

The brake lights and hazard warning lights activate during the manoeuvre. When the car comes to a stop, the hazard warning lights stay on and the parking brake activates.

 **Note**

Manual override

Pressing down on the accelerator overrides the braking manoeuvre, allowing the driver to select a safe place to stop.

Post-impact braking requires that the brake system is intact after the collision.

^[1] The severity of the collision must exceed a certain threshold for post-impact braking to activate. For example, if airbags have deployed.

8.9. Selecting gear

Select a gear with the right-hand side steering wheel stalk. The current gear is indicated in the driver information area.

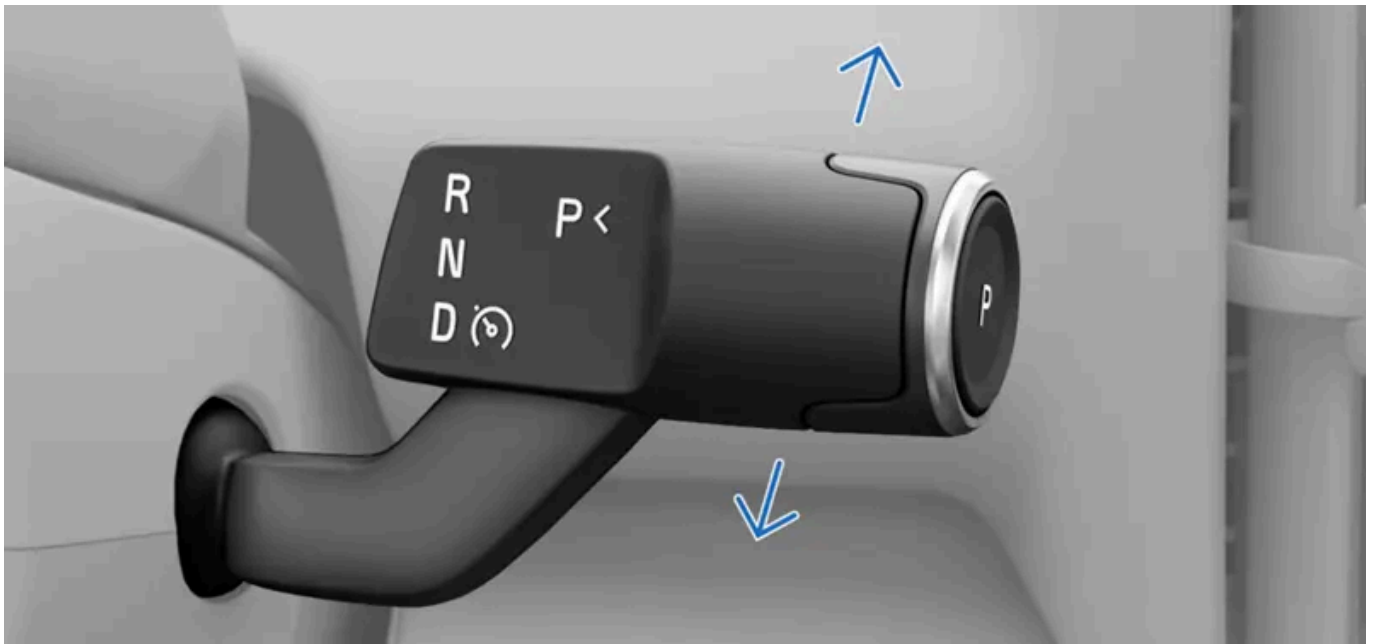

R Reverse
N Neutral
D Drive

In addition to gear selection, the right-hand side stalk also controls the parking brake and certain driver support functions.

Changing gears is only possible when the car is stationary or when you are driving at walking pace.

1. Press the brake pedal ^[1].
 2. Move the stalk up or down to select a gear.
- > Your selection is indicated in the driver information area.

Note

When moving the gear selector either up or down, you can feel that it has two positions in both directions. Select R by moving the gear selector all the way up. Move the selector all the way down to select D.

You can select the neutral gear, N, by moving the gear selector to the first position, in either direction, and holding it there for a couple of seconds. The stalk always returns to its middle position between gear selections.

^[1] only necessary if your car is stationary

9. Visibility, mirrors and exterior lights

Learn how to control your car's lights, mirrors and wipers for better visibility when the conditions call for it.



Your car is equipped with multiple features to assist you in your driving. Some are designed to improve safety, while others improve visibility. Some features are designed with both purposes in mind. Reading this section of the manual can assist in making your driving experience safer and more comfortable.

9.1. Exterior lights

Your car has a range of lighting capabilities. You can select and control the different lighting options in the display and on the left-hand steering wheel stalk.

 **Warning**

Car lights systems which are dependent on ambient light detection do not absolve the driver of responsibility for ensuring that proper lighting is used for all situations according to local laws and traffic regulations.

Exterior lights refers to all of the exterior illumination functions and features that affect visibility.



- ① You control certain driving lights, such as the high beam and the direction indicators, with the left-hand steering wheel stalk.
- ② You select primary lighting modes, additional driving lights and exterior convenience lights in the main area of the display.
- ③ The hazard warning lights button is located on the overhead console.

Some lighting features rely on the car's ability to sense that there are poor light conditions outside. Make sure that the car cameras are kept clean and are well-maintained. If the cameras' views are affected by dirt, they can't do their job properly. They need to be able to obtain enough information so that they can properly direct the car's lighting responses.

i Note

Condensation in the lights

Exterior lighting may temporarily contain water from condensation. This is normal and all exterior lights are designed to withstand this. Condensation is normally vented out of the light housing after a period of time.

9.1.1. Driving lights



Driving lights mix automatic behaviours and direct controls which allow you to adapt to any situation or visibility conditions.

! Important

The driver is always responsible for ensuring that the car is driven while using a lights mode that is suitable for the current driving conditions and local traffic regulations.

Primary lighting

You can choose between several different primary lighting modes in the display. Your selection sets a standard lighting behaviour.

Auto	Auto	The automatic lights mode ^[1] allows your car to automatically detect and calculate which lighting mode is most suitable for the driving and environmental lighting conditions.
	Passing beam	You can manually select the passing beam to keep the front lights dipped.
	Position lights	The position lights are points of illumination around the car that make your car more visible to other road users. You can lock the car with the position lights on if you intend to leave it for a short period of time.
Off	Off	Off deactivates all primary lighting modes. ^[2]

 **Note**

You can only turn the lights off or select the position lights when your car is parked. The automatic lights mode automatically activates when you start driving.

Additional lights

You can control the high beam and the direction indicators with the left-hand steering wheel stalk.

The hazard warning lights help you to warn others of potential risks. You can turn them on or off by pressing the button in the display or the overhead console.

There are additional lights that can be enabled or adjusted in the display, such as:

- Rear fog light** The rear fog light warns traffic behind you of your presence in poor light conditions.
- Adjust height of light beam** You can counteract any changes to the car's balance by adjusting the height of the headlights.

^[1] Auto

^[2] Some exterior lights may remain on when driving based on regulations in various market regions.



9.1.1.1. Selecting a primary lighting mode

You can select a primary lighting mode via the display.

The primary lighting mode sets the car's standard lighting behaviour. In certain lighting modes, you can activate or enable additional features to help you adapt to the driving conditions.

 **Note**

Some primary lighting modes can only be selected in certain conditions. You can only turn the lights off or select the position lights when your car is parked. The automatic lights mode^[1] automatically activates when you start driving and stays on until you select a different primary lighting mode.

1. Press the car symbol  in the bottom bar and go to **Settings**.
2. Go to **Controls** → **Lights and displays** → **Exterior lights**.
3. Select a primary lighting mode.
4. Confirm your selection by pressing the OK button  on the steering wheel.

[1] Auto

9.1.1.2. High beam

The high beam is important for your driving visibility. There are different options you can use to suit your needs.

Important

Remember that your ability to see the road properly in low lighting conditions is important not just for your own safety, but for other road users and pedestrians too.

The high beam is more powerful and has a longer reach of illumination than the passing beam. To use the high beam, you must first select the automatic or passing beam primary lighting mode.

When the automatic high beam is active, the car automatically reacts to oncoming traffic to avoid dazzling other road users.

Note

The automatic high beam only activates at speeds over approximately 40 km/h (25 mph) and in low light.

You can use the left-hand steering wheel stalk to switch between the manual high beam and the automatic high beam. There are symbols in the driver information area that show which high beam setting is currently active. These include:



The manual high beam is active.



The automatic high beam is enabled but not active.



The automatic high beam is active and the lights are turned on.

! Important

Make sure that the car cameras are well-maintained and kept clean. If the cameras' views are obscured by dirt, they will not be able to obtain enough information to properly direct the car's lighting responses.

9.1.1.2.1. Operating the high beam

You can control the high beam using the left-hand steering wheel stalk.

There are several different high beam options you can choose from to suit the driving conditions.

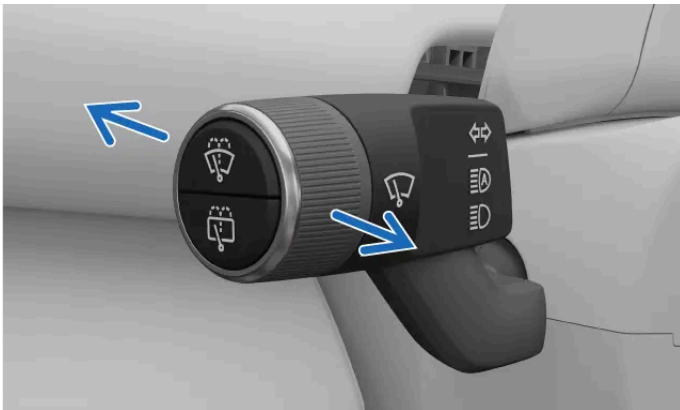

You can move the left-hand stalk forwards or backwards to switch between the different high beam options. The stalk always springs back to the neutral position.

The options available are:

- Automatic high beam
- Manual high beam
- High beam flash

i Note

Primary lighting modes

When you are in the automatic primary lighting mode, the high beam becomes part of the adaptive front-light system and works in different ways depending on the outside light conditions. You can enable the automatic high beam in all lighting conditions, but both the automatic and manual high beam can only be activated in low light.

When passing beam is selected as the primary lighting mode, you can only activate the manual high beam.

Enabling or activating the high beam

- When the high beam is turned off, push the stalk once to enable the automatic high beam or activate the manual high beam.

Deactivating the high beam

The content of this manual represents the status of the user manual at the time of printing and may not be completely valid in future instances. For more information, refer to the first page for the complete disclaimer note.

- Pull the stalk fully to turn the high beam off.

Flashing the high beam

- A short pull of the stalk activates the high beam flash.

Switching between manual and automatic high beam

- When the automatic lights mode^[1] is selected and the high beam is activated, push the stalk once to switch between the automatic high beam and the manual high beam.

! Important

Make sure that the car cameras are well-maintained and kept clean. If the cameras' views are obscured by dirt, they will not be able to obtain enough information to properly direct the car's lighting responses.

^[1] Auto

9.1.1.3. Operating the direction indicators

Use the direction indicators to communicate how you intend to manoeuvre your car. The controls are located on the left-hand steering wheel stalk.

The indicators have two types of activation – quick and standard. While the indicators are blinking, you will hear a ticking sound and see a direction indicator symbol in the driver information area of the display.



Quick indication

- Move the left-hand steering wheel stalk slightly up or down and allow it to spring back to the middle.
- > The indicators blink three times before turning off.

Standard indication

- Move the left-hand steering wheel stalk up to turn the right indicator on and down to turn the left direction indicator on.
- > The stalk moves back to its original position and the indicators turn off when you straighten the steering wheel out after turning.

 **Note**

You can cancel standard indication by moving the left-hand steering wheel stalk slightly up or down.

 **Note**



Indicator malfunction

In the event of any malfunction or damage to the direction indicator function, the malfunction symbol  appears in the display.

9.1.1.4. Activating the rear fog light

The rear fog light is designed to warn traffic behind you of your presence in bad weather with poor light conditions.



The rear fog light needs to be manually activated in the main area of the display.

1. Press the car symbol  in the bottom bar and go to **Settings**.
2. Go to **Controls** → **Lights and displays** → **Exterior lights** → **Rear fog light**.
3. Turn it on or off by pressing the fog light symbol .

9.1.1.5. Adjusting headlights height

You can adjust the height of the front headlights.

Changing the vertical tilt of the passing beam allows you to control how far ahead the beam will illuminate. You can use the headlights' height adjustment to counteract any changes to the car's balance. Keep in mind that high-angled beams can dazzle other road users.

1. Press the car symbol  in the bottom bar and go to **Settings**.
 2. Go to **Controls** → **Lights and displays** → **Exterior lights** → **Adjust height of light beam**.
- > The height adjustment page opens.
3. Select the height you want.
 4. Confirm your selection by pressing the OK button  on the steering wheel.

9.1.1.6. Hazard warning lights

If there is a potential risk to surrounding traffic, you should turn the hazard lights on. This helps to alert other road users of the need for greater awareness.

 **Important**

It is the driver's responsibility to use hazard lights according to local laws and traffic regulations.

The hazard lights button is located in the overhead console. You can also access the lights in the bottom bar in the display.



The location of the hazard lights button in the overhead console



The location of the hazard lights button in the display

The status and interaction points to control the hazard lights are signified by the associated symbol.



Automatic activation

The hazard warning lights turn on automatically when the emergency brake lights are triggered due to sudden braking.

You can turn the hazard lights off manually or let them turn off automatically when you begin driving again.

In the event of a collision

Your hazard lights will automatically turn on in the event of a collision.^[1]

There is a cool-down period which disables the option to turn the hazard lights off. When you can use them as normal, the hazard lights button begins flashing again.

^[1] This is dependent on local regulations and regional standards.

9.1.1.6.1. Activating the hazard warning lights

The hazard warning lights are essential for driving safety. Be sure that you know how to work them.



Hazard warning lights symbol

When you get into the car, the hazard warning lights button in the overhead console lights up, showing that you can use it. There's also a button located in the bottom bar in the display.

1. Press the hazard warning lights button, either in the overhead console or the display.
- > Both of the direction indicator symbols in the driver information area of the display and the hazard warning lights buttons flash simultaneously in the same rhythm as the lights. You will also hear a ticking sound.

9.1.2. Exterior convenience lights

There are lighting functions available that make it easier to see when you are outside your car.

Convenience lights refers to lights which work when the car is parked.

Welcome lights

The welcome lights display a short light sequence and give better visibility as you approach your car. The welcome lights sequence is triggered when you unlock your car. It can be enabled via the display.

Guidance light

The guidance light provides extra lighting around your car and activates when your car is locked. This is useful when you are parked in a dark location. You can use the display to set your desired time duration or turn the guidance light on or off.

9.1.2.1. Enabling the guidance light

The guidance light helps you to see when you're outside of the car and to be seen by others.

The guidance light illuminates the area surrounding your car to help you see in low light. You can enable it and select a time duration via the display. The guidance light automatically activates when your car is locked and deactivates after the selected time period.

1. Press the car symbol  in the bottom bar and go to **Settings**.
2. Go to **Controls** → **Locking** → **Guidance light**.
3. Turn it on or off, or set your desired time duration.

The guidance light stays enabled between drives. You can disable it via the display.

9.1.2.2. Enabling the welcome lights

In addition to the default lights that activate when you unlock your car, you can turn on the welcome lights sequence.

The welcome lights display a short lights sequence and give better visibility as you approach your car.

1. Press the car symbol  in the bottom bar and select **Settings**.
2. Go to **Controls** → **Locking** → **Welcome light**.
3. Enable or disable the welcome lights.

Your car will keep these features active until deselected.

9.2. Mirrors

The rear-view mirror and the two wing mirrors are important for your driving awareness. Make sure that you adjust the mirrors to your needs before driving.

Rear-view mirror

You can adjust the interior rear-view mirror by moving it manually.

Wing mirrors

You can adjust the wing mirrors' positions using the buttons on the right-hand side of the steering wheel.

You can save the wing mirrors' positions to your user profile.

Via the locking settings, you can set the mirrors to automatically fold and unfold when you lock or unlock the car.

The wing mirrors are heated to prevent ice and frost from impeding visibility.

Note

Alerts about vehicles in blind spots

The wing mirrors have lights on them to give you greater driving awareness. They activate when vehicles are detected in or near the blind spots.

Open door warning

The wing mirror lights will also illuminate when a door is open.

 **Warning**

The wing mirrors are curved to improve visibility. Objects may appear to be further away than they actually are.

Mirror dimming

The dimming function reduces strong reflections from bright light.

The driver side's wing mirror and the rear-view mirror have automatic dimming.

9.2.1. Adjusting wing mirrors

Before you start driving, make sure that the wing mirrors are in positions that give you good visibility.

1. Press the car symbol  in the bottom bar and select **Settings**.
2. Go to **Controls** → **Mirrors and wipers** → **Adjust side mirrors**.
3. Press **Adjust**.
- > The adjustment settings view appears.
4. Select the wing mirror you want to adjust.
5. Use the steering wheel buttons to adjust the selected mirror.

 **Tip**

Folding and unfolding the wing mirrors

You can fold and unfold the wing mirrors in the adjustment settings view. This can be useful to do when you are parking or driving in narrow spaces.

If you fold the wing mirrors and start driving, they will fold out again when the car reaches a certain speed.

9.3. Wipers and washers

The wipers and washers work together to keep the windscreens clean and clear.

Wiper and washer controls



You can control the wipers and washers using the scroll wheel and buttons on the left-hand steering wheel stalk.



Front wipers and washers



Rear wiper and washer

The front washer nozzles are located on the underside of the bonnet, at the bottom of the windscreen. The rear washer nozzle is on the underside of the roof spoiler, above the rear windscreen.

Front wiper modes

The front wipers have an automatic mode as well as multiple manual speeds. Each wiper mode sets a different speed for the wiper movements, so you need to select the appropriate mode for the conditions you are driving in. You can see the current wiper mode in the display. Between drives, the car resets to automatic mode by default.

When automatic mode is active, the car uses information from its rain sensor to activate the wipers and control their speed. You can change the rain sensor sensitivity in settings and the quick controls view. When the rain sensor is active, you can see a symbol in the display.



Active rain sensor symbol

Rear wiper

Use the left-hand steering wheel stalk to manually turn the rear wiper on or off. The driver information area of the display shows whether the rear wiper is active or not.

You can also enable a setting to allow the rear wiper to activate automatically when you are reversing the car. When this setting is enabled via the display, the rear wiper automatically activates if the front windscreen wipers are active while you are reversing. If you change gear, the rear wiper will stop wiping the rear windscreen.

 **Important**

Maintenance, refilling and replacing

- Clean the wiper blades regularly.
- Replace the wiper blades if they show signs of wear.
- Refill washer fluid when your car tells you to.
- Avoid using the wipers without lubrication from either rain or washer fluid. It can cause wear or damage.

Car wash safety

Turn the automatic wiper mode off when you enter a car wash. Otherwise, the rain sensor will cause the wipers to activate, which could lead to damage.

9.3.1. Controlling front wipers

You can manually activate the windscreen wipers or change the way they work. When the car detects rain in automatic mode, the wipers will activate.

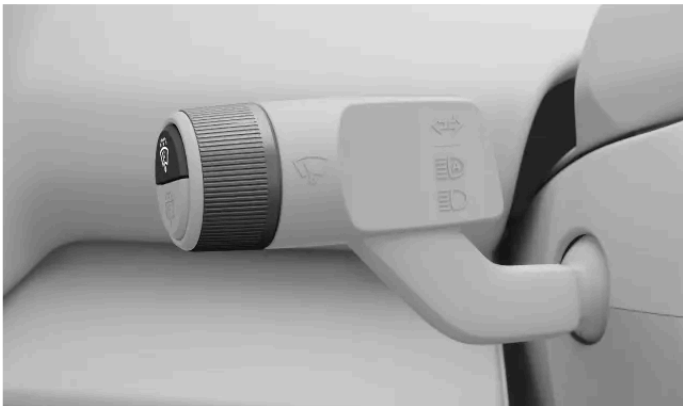

There are different front wiper modes that you can activate by using the left-hand stalk. The modes are:

- Off** Wipers are turned off
- Auto** Automatic mode using rain sensor
- 1x** Low
- 3x** High

Single wipe

1. Press once on the upper button on the end of the left-hand steering wheel stalk.



- > The wipers will swipe once across the front windscreen.

Changing wiper mode

2. Rotate the scroll wheel on the end of the left-hand steering wheel stalk.
- > The display shows the wiper menu as you scroll through the wiper mode options. The currently selected mode is also highlighted.

9.3.2. Controlling rear wiper

The rear wiper can be manually turned on and off. You can also enable a setting via the display to allow the rear wiper to activate automatically when you are reversing the car.



You control the rear windscreen wiper by using the lower button on the left-hand steering wheel stalk.

Turning on and off

1. Press once on the lower button on the end of the left-hand steering wheel stalk.



- > The rear wiper turns on.
2. Press the button again to turn the rear wiper off.

Enabling automatic rear wiper while reversing

3. Press the car symbol  in the bottom bar and go to **Settings**.
4. Go to **Controls** → **Mirrors and wipers** → **Auto rear wiper while reversing**.
5. Turn it on.

9.3.3. Activating washers

Activate the front or rear windscreen washers using the buttons on the left-hand steering wheel stalk.



Washer buttons on the left-hand steering wheel stalk.

- Press and hold the button on the left-hand steering wheel stalk for the washer you want to activate. The front washer is activated by the upper button and the rear washer is activated by the lower button.



Front wipers and washers symbol



Rear wiper and washer symbol

- > The washers and wipers work together to distribute washer fluid across the windscreen. When you release the button, the wipers make a few more passes to wipe away excess fluid.

10. Driver support and navigation

Driver support features are designed to improve safety, comfort and convenience when you are using your car. They assist you with your driving, route-planning and decision-making on the road.



The collection of driver support features in this car can assist you in driving, navigating and parking. Some are exclusively designed to improve safety, others convenience. Some features are designed with both purposes in mind.

When used correctly, driver support features can reduce the effort of driving, help reduce distractions and improve safety for you and others. They often take advantage of the car's ability to monitor and keep track of its surroundings. Some features deliver that information to you for increased driver awareness, while other features provide fast reactions to hazards identified by the car.

10.1. Navigation

Use the Google Maps navigation app to get directions and traffic information as well as find the nearest charging station.

When the car is connected to the internet, it can continuously download map and traffic information to help you navigate to a destination. Navigation guidance can appear in the car's display.

The car knows its location through GPS and shows it in the car's display.

Navigation app



Google Maps symbol

Note

Latest app version

Be sure to update the app whenever there's a new version available. Functionality and support for old versions may vary.

Connected navigation features

Whenever your car is connected to the internet, it can get the latest navigation information.

Real-time traffic information	You can get real-time traffic information if the car is connected to the internet. For example, you can see if traffic is moving slowly. Different coloured lines that correspond to traffic situations will appear on your chosen map route. If the internet connection is lost, the lines disappear after a while. You also get information about traffic conditions along the chosen route, such as roadworks or accidents.
Alternative routes and redirected traffic	When you set a destination in the navigation app, the fastest route is suggested while also taking your navigation settings into account. For example, you can choose to avoid tolls or ferries. The chosen route can be redirected while you are driving, such as when there is an accident or a traffic condition that affects your travelling time.
Sharing information with other devices	Link your Google account to an active user profile to get the same Google Maps information in your car as on your other devices. Destinations saved to your Google account using other devices, such as home, work, favourites and last searches, are then also available in your car.

Offline maps

When you are connected to the internet, you can download map areas so that they are available in the car even if your car has poor reception or no internet connection. This feature is available in Google Maps' settings.

Displayed information

When a route is added, the following travel information about the trip is shown in the display:

- Travel time
- Distance to the next destination on your route, such as an extra stop
- Estimated time of arrival
- The name of the next destination on your route

Navigation settings

You can change the navigation settings in the navigation app.

Warning

Avoid driver distraction

Avoid any interaction with the car's system or other devices that may distract you from driving safely. Any task that does not allow you to keep your attention on the road and surrounding traffic should be performed when the car is parked.

 **Note**

Navigation limitations

- The navigation feature is from a third-party supplier. Availability and functionality may vary over time and depend on region.
- Navigation instructions can sometimes be less reliable than usual due to factors such as weather or road conditions.

Poor or no internet connection

The navigation app can have trouble finding a route or signal when you are in a location which can interfere with your internet connection, such as a tunnel or multi-storey car park.

 **Tip**

Range and charging

There are features in navigation that can help you plan your trip based on charging stations, estimated charging time, estimated battery level upon arrival and range.

10.1.1. Finding and selecting a navigation destination

Find your destination using the search field or a voice command. The car then suggests routes for you to choose from.

1. Press the app library symbol  in the bottom bar and open Google Maps.
2. Enter an address or destination in the search field.
 - > A route is suggested along with alternative routes.
3. Select your preferred route.
4. Select start.
 - > Navigation instructions start.

10.2. Detection of surroundings and traffic

This section covers the essentials of how cameras, radars and other sensors work, including their limitations. Understanding how your car perceives its surroundings can help you use features that rely on this capability.

Your car's ability to understand its surroundings is achieved through many systems and types of sensors. The car's interpretation of the data it collects helps inform its behaviour, especially for driver support features.

Cameras	Cameras work similarly to the human eye. What they capture is used for different purposes, which depends on the camera. For example, the upper front-facing camera helps the car identify things such as traffic signs and road markings, whereas what the rear parking camera captures appears in the display.
Radars	Radars use radio waves to collect information about the car's surroundings. They can identify the distance to objects and certain aspects of their movement. This information is essential for many features in the car.
Ultrasonic parking sensors	These sensors use sound waves to detect relatively close objects. They work by sending out ultrasound pulses that can bounce back to the sensors when they encounter an object.

How systems work together

The different detection types complement each other. They are sometimes used on their own and sometimes together.

Important

Even when used together, these detection systems cannot handle all conditions and traffic situations. This is why it's important for the driver to never rely fully on driver support features. Always be attentive to conditions and situations where driver support feature performance is affected by the features' limitations.

General detection and identification limitations

Each type of detection has its own set of limitations, but there are a few general things to consider as well.

- The car can't always handle unpredictable or strange situations. When the car finds it difficult to correctly identify the environment or traffic situation, the accuracy of its response is affected.
- Damage to the car can affect detection and reliant features. Many faults can be identified by the car, but some may not be possible to self-identify. This is why it's important to make sure that the car is in good condition and working order. Contact an authorised Volvo workshop if you suspect there are any faults or if you notice damage to the car.
- Limiting factors and conditions can, and frequently do, coincide. They can compound and interact in ways that amount to an incorrect response from the car.

Obstacle detection limitations

Obstacle detection helps the car identify certain stationary and moving objects. These objects can be other road users, such as pedestrians or other vehicles, animals, barriers or other objects. If they are in or close to the car's driving path, they could pose a collision risk. Depending on the circumstances, the car might be able to warn or intervene if the object is accurately identified. For all types of objects the car can identify, there are many factors that can prevent accurate identification. Examples of limiting factors, situations and events include:

- Closely spaced, overlapping or partially blocked objects and road users.
- Objects and road users that blend in with the background.
- Objects and road users that move or accelerate particularly fast.
- Uncommon vehicles, such as recumbent bicycles, combine harvesters or trailers with oddly-shaped loads.
- Bicycles of a different type or size compared to a regular adult bicycle.

The content of this manual represents the status of the user manual at the time of printing and may not be completely valid in future instances. For more information, refer to the first page for the complete disclaimer note.

- New modes of transportation.
- Clothing or carried objects that alter the silhouette of a pedestrian.
- Pedestrians shorter than 80 cm (32 inches).
- Obstacles angled in ways that create an unknown silhouette.
- Size and speed of animals. Cats and dogs are often too small to be reliably identified.

Note

Traffic detection examples

The following examples of different traffic scenarios can help you understand some of the limitations of your car's detection systems. Real-world scenarios are often more complex than the following illustrative^[1] examples in this manual.

Out of view and late detection

The various detection zones around your car are static, each with a limited range and field of view. If something enters a detection zone at an unusual angle, at high speed or very close to your car, it can cause a rapid response. This reduces safety margins compared to a situation in which earlier detection was possible.

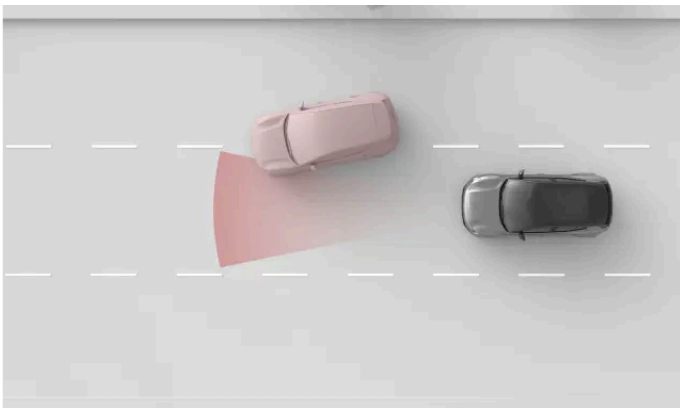

The front radar's detection zone has a limited width. If you get cut off by another vehicle, detection can occur relatively late causing a sudden response by your car.

Important

Lane placement and small vehicles

For forward detection, the middle of the lane is more favourable compared to its outer parts. Vehicles can go undetected if they don't occupy the middle of the lane. While this can happen for any vehicle, the risk is higher for small ones, such as motorcycles. They take up less of the lane's width and can move about more within the lane. Always pay extra attention to any vehicle not driving in the middle of the lane.

Shape, size and number of objects

Detection can be less reliable depending on the shape, size and number of objects in a detection zone. Identifying the distance to the closest vehicle ahead can become less accurate depending on these factors, especially if they are compounded.

- Small objects are harder to identify.
- The more objects, the harder it is to identify individual ones.

The content of this manual represents the status of the user manual at the time of printing and may not be completely valid in future instances. For more information, refer to the first page for the complete disclaimer note.

- Objects close together that overlap are harder to identify.
- Objects with non-uniform shapes, such as having overhangs or parts that stick out, are harder to identify.

The presence of a large vehicle in front can make it difficult to identify a smaller one, such as a motorcycle.

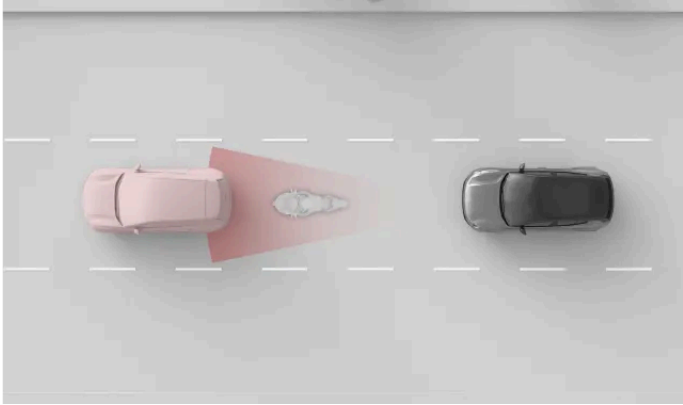

The smaller motorcycle and the car are close to each other and overlap, making detection of the motorcycle less accurate.

! Important

Trailer in front

Compared to many other vehicles on the road, the detection of trailers is often less reliable due to their shape and height. This applies, in particular, to slim trailers, low trailers and trailers with very high loading beds. These types of trailers often don't have enough surface area at the height where forward detection systems focus.

Road and infrastructure

Bends in the road can cause the car to misinterpret the traffic situation. For example, it can lose track of a vehicle or misidentify which lane a vehicle ahead is in.

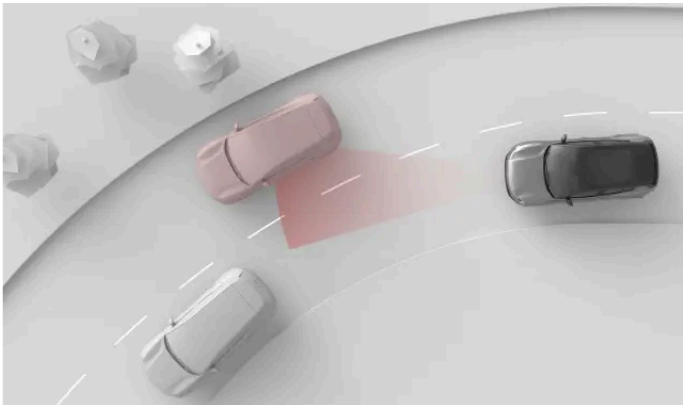

In a bend, the car ahead may slip out of the detection zone. Cars in the adjacent lane may also enter the zone, affecting your car's perception of the distance to traffic ahead.

 **Important**

Road condition and irregularities

Both common and uncommon road features can impact the effectiveness of the car's detection systems.

- Sharp bends and bumps in the road can temporarily obscure important parts of the car's surroundings, such as other vehicles or road markings.
- Non-standard or unusual road infrastructure might not be correctly identified by the car. For example, road work or traffic diversions can result in conflicting or multiple sets of road markings.
- Worn road markings or signs might not be correctly identified.

^[1] The representations of detection systems and the car's surroundings are not to scale.

10.2.1. Locations of cameras, sensors and radars

Knowing the placement of different components the car uses to map its surroundings helps you keep them free of dirt, obstructions and accidental damage.

Many of your car's driver support features rely on data from components that scan and map your car's surroundings, such as cameras, sensors and radars. This section doesn't show all components and their precise locations, but it gives you a general idea of where they are. Areas pointed out in this section are particularly important to keep clean. Damage to these areas can also affect functions that rely on components located there.

 **Warning**

Clean regularly

Camera, sensor and radar locations on the car must be cleaned on a regular basis and kept free from labels, objects, dirt and other potential obstructions. Otherwise, car functions may respond incorrectly or become less responsive or deactivated.

Mounted accessories

Be mindful of the effects of mounted car accessories, such as load carriers or exterior light accessories. The items themselves or the load you add may obstruct cameras, sensors or radars.

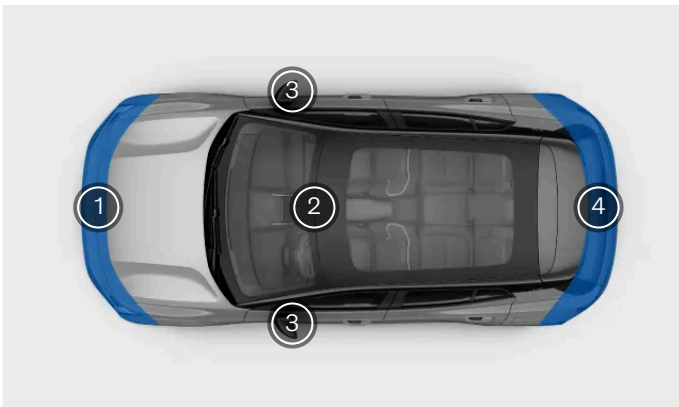

- 1 The front of the car houses several detection components. There is a radar in centre, just below the number plate, as well as additional radars in each corner. There is also a camera in the centre and several parking sensors along the lower edge.
- 2 The top-centre of the windscreen houses a front-facing camera.
- 3 The car's side-view cameras are located on the wing mirrors. The right-side wing mirror also houses the ambient climate temperature sensor.
- 4 The rear of the car houses a rear-view camera in the centre and radars in each corner. There are also several parking sensors along the lower edge.

 **Tip**

Finding the parking sensors

You can see the exact location of your car's ultrasonic parking sensors by looking for their button-like cover plates along the bumper panel.

 **Important**

Cleaning in front of radars

If you find dirt, snow or ice, or if the car indicates that a radar is blocked, you should address it as soon as possible. Always clean and clear a large area around the radars to make their full field of view available.

10.2.2. Camera detection and limitations

The car's cameras capture the surroundings in a similar way to the human eye. This comparison is useful for understanding their capabilities and limitations.

Cameras help the car identify certain objects and surfaces that visually stand out against their backgrounds. This includes things such as road markings, traffic signs, pedestrians and other vehicles.

Camera information in the parking view can provide you with an additional way to monitor the car's surroundings.

Light conditions

Cameras need light to work and are affected by light conditions.

- Strong light sources, such as the sun, can cause glare and reflections that negatively affect camera detection.
- Low light can negatively affect certain types of camera detection.
- Some detection types require low-light conditions. When it's dark, the lights from other vehicles can be identified as they stand out against the background.

Important

Camera detection in darkness

For the car to be able to identify other vehicles when it is dark, the other vehicles must have their headlights and rear lights turned on and be clearly visible. While the car uses other types of detection as well, such as radar, it may not have enough information to reliably identify vehicles that are not seen by the cameras. Several driver support features can be affected by this, such as safety interventions, collision warnings and features that provide distance-keeping.

Visibility

Poor visibility for the driver typically means poor visibility for the cameras. Objects that are hard to detect for the human eye can sometimes be hard to detect for the cameras as well. This can include well-camouflaged objects or objects where the outlines don't stand out against the background.

- Fog, heavy rain, snow or dust storms can severely limit visibility for the cameras.
- Beware of dust, water or snow on the ground that may be disturbed and kicked up into the air by your car, other traffic or the wind.

Field of view and obstructions

Cameras see in the direction they're facing and only within their field of view. The field of view differs for each camera and depends on their intended purpose.

Obstructions limit what the camera sees. Each camera views the surroundings from where it's mounted, and anything that enters its field of view blocks what's behind the obstruction. Objects close to a camera will block more of the camera's field of view than objects that are further away. If the car detects that a camera is blocked, it can disable certain features that rely on that camera.

- Make sure that any mounted accessories, extra equipment or externally-stowed cargo don't block part of the cameras' fields of view. For example, far-extending roof loads may block part of the top view for front- and rear-facing cameras.

- Trailers, bike racks or other towbar-mounted equipment can block the rear camera view.
- Dirt, ice, snow, water droplets and condensation on camera lenses obstruct the cameras' view to some extent. In some cases, the car may be able to identify that something is in the way and notify you. However, it is still recommended to regularly inspect the cameras and make sure that they are clean and unobstructed.

 **Warning**

Clean regularly

Camera, sensor and radar locations on the car must be cleaned on a regular basis and kept free from labels, objects, dirt and other potential obstructions. Otherwise, car functions may respond incorrectly or become less responsive or deactivated.

Other limitations

If the cameras become too hot, they can be temporarily switched off to protect them from damage. This can happen when starting the car after being parked in high temperatures in combination with direct sunlight hitting a camera. The camera can become available again once it has sufficiently cooled down.

 **Important**

Windscreen damage

Windscreen damage in the camera area, including small chips, scratches or cracks, can negatively affect performance of the camera and features that use it. This can cause reduced functionality, unreliable response from the car and disabling of features. If damage occurs, follow this manual's separate recommendations for handling windscreen damage.

10.2.3. Radar detection and limitations

Radars use radio waves to collect information about the car's surroundings. They can identify the distance to objects and certain aspects of their movement. It's important not to block the radars.

There are several radars aimed in different directions to collect information about the car's surroundings. This information is primarily used by driver support features in the car. Radio waves are continuously sent out and bounce back if they encounter an object in their path. As the waves return, the car can calculate things such as position and motion of the object.

Radars are unaffected by the light conditions, working equally well on a sunny day as in complete darkness.

 **Important**

Use responsibly

Radars and features that rely on them are supplements to safe driving practices. They do not reduce or replace the need for the driver to stay attentive and focused on driving safely.

Detection zone and field of view

The content of this manual represents the status of the user manual at the time of printing and may not be completely valid in future instances. For more information, refer to the first page for the complete disclaimer note.

Each radar in the car has its own detection zone. The zone is limited by the radar's field of view and range.

Objects in the field of view block what's behind them. The closer something is to the radar, the more it blocks the radar's field of view.

- If a radar is blocked, certain features may become less effective or respond incorrectly.
- If the car detects that a radar is blocked, it may disable certain features.
- Do not place or mount anything in front of or close to the car's radars. This includes stickers, car body foil and adhesive tape.
- Paintwork damage in front of a radar can affect its performance. Contact an authorised Volvo workshop for repairs if there is any damage close to the radars.^[1]
- Make sure that any mounted accessories, extra equipment or externally-stowed cargo don't block the car's radars.
- Trailers, bike racks or other towbar-mounted equipment can block the radar, making it and certain features unavailable.
- Radars are sensitive to buildups of dirt, ice or snow in front of them. This affects the radio waves and can reduce the radar's ability to detect objects. Radar obstruction cannot always be identified by the car. In situations where it is detected, the car communicates this via notifications in the display. However, it is still recommended to regularly inspect the radars and make sure the areas around them are clean and free of obstructions.

 **Warning**

Clean regularly

Camera, sensor and radar locations on the car must be cleaned on a regular basis and kept free from labels, objects, dirt and other potential obstructions. Otherwise, car functions may respond incorrectly or become less responsive or deactivated.

Other conditions and limitations

Other radar sources can cause interference and reduce the effectiveness of your car's radars.

^[1] Volvo recommends engaging an authorised Volvo workshop to perform any service and maintenance work.

10.2.4. Parking sensor detection and limitations

The ultrasonic parking sensors allow the car to detect objects and their distance from the car. They operate at relatively close range during slow and tight manoeuvring, such as when parking.

Ultrasonic sensors use sound waves to detect obstacles close to the car. They work by sending out ultrasound pulses that can bounce back to the sensor when they encounter an object or barrier. This allows the car to identify the distance to obstacles in the direction of detection.

Information from these sensors is only available at low speeds. They provide distance information when the parking view is shown in the display.

 **Important**

Use responsibly

Ultrasonic parking sensors and features that rely on them are supplements to safe driving practices. They do not reduce or replace the need for the driver to stay aware of the car's surroundings and focused on driving safely.

Detection range

Ultrasonic sensors are typically located relatively low down on the bumper.

- Obstacles whose supports are outside of the detection zone can go undetected. Such obstacles include objects that are suspended from above or objects that extend far away from their ground support, such as certain barriers and gates.

Blocked sensors

Ultrasonic sensors can get blocked, either reducing distance and obstacle detection or making it unavailable. To avoid blocked sensors or better understand when they may be unavailable, consider the following:

- If a sensor is blocked, certain features may become less effective or respond incorrectly.
- Heavy rain or snowfall can lead to unreliable detection and features relying on the ultrasonic sensors becoming unavailable.
- If the car detects that a sensor is blocked, it may disable certain features.
- Do not place or mount anything in front of or close to the car's sensors. This includes stickers, car body foil and adhesive tape.
- Bodywork damage where the sensors are located can affect their performance. Contact a workshop for repairs if there is any damage in the sensor areas.^[1]
- Make sure that any mounted accessories, extra equipment or externally-stowed cargo don't block the sensors.
- Trailers, bike racks or other towbar-mounted equipment can block sensors, making detection and certain features unavailable.
- Ultrasonic sensors are sensitive to buildup of dirt, ice or snow in front of them. This can reduce their ability to detect objects. Parking sensor obstruction cannot always be identified by the car. In situations where it is detected, the car communicates this via notifications in the display. However, it is still recommended to regularly inspect the sensor locations and make sure the areas around them are clean and free of obstructions.

 **Warning**

Clean regularly

Camera, sensor and radar locations on the car must be cleaned on a regular basis and kept free from labels, objects, dirt and other kinds of potential obstructions. Otherwise, car functions may respond incorrectly or become less responsive or deactivated.

^[1] Volvo recommends an authorised Volvo workshop for all servicing and repairs.

10.3. Safety interventions and warnings

Your car has features that directly or indirectly help prevent collisions. If your car detects a dangerous traffic situation, it can intervene by warning the driver or performing an evasive driving manoeuvre.

Safe driving begins with good user practices. As an additional level of protection against incidents, your car can warn you if it detects a situation that requires your immediate attention or action. In addition to making the driver aware through warnings, the car can intervene by steering or braking to avoid or mitigate a collision.

Features that are designed to provide warnings or perform interventions in different ways include:

- Collision warnings and mitigation
- Blind spot information
- Lane keeping aid
- Driver focus and alertness notifications^[1]
- Alerts about traffic crossing behind the car when reversing^[2]
- Automatic braking when reversing^[3]



Tip

What are safety interventions?

Safety interventions are responses from the car in situations in which it identifies a high or imminent risk of collision. Warnings can be provided to alert the driver to hazards so that they can take action, but the car is also capable of performing emergency steering or braking manoeuvres depending on the situation. Some types of warnings and interventions are always enabled while others are part of features that you may be able to customise or choose to turn on or off.

Safety interventions to avoid collisions

When the car identifies a risk of collision, it reacts according to the level of urgency. It can identify objects such as pedestrians, cyclists and vehicles that are approaching or are in your driving path. Many factors can affect how early and effectively the car can detect the risk of an incident. There are situations that are beyond the car's capabilities, which is why safe driving practices are essential.

If the car identifies an increasing risk of collision, alerts can quickly escalate to evasive manoeuvres by the car. If a threat appears suddenly, the car can immediately perform evasive manoeuvres.

Safety interventions can include:

Collision warnings	When the car identifies that there's a risk of collision, the first step is to get the driver's attention. The car can warn you visually, with sound or with brake pulses.
Braking manoeuvres	If the car determines that immediate action is required, it can brake independently of the driver's actions. This can occur at the same time as a steering manoeuvre. The amount the car brakes when intervening depends on the situation. An obstacle that suddenly appears just in front of the car may cause the brakes to be fully applied, whereas another situation might require less braking to avoid a potential collision.
Steering manoeuvres	If the car determines that immediate action is required, it can steer independently of the driver's actions. This can occur at the same time as a braking manoeuvre.

The display can show messages about performed safety interventions.

 **Note**

Overriding steering and braking interventions

- Steering interventions by the car can always be overridden with intentional steering by the driver.
- To override a braking intervention, you must firmly press down on the accelerator pedal. Past a certain threshold, you override the braking action.

Knowing your car's capabilities

Safety interventions by the car can occur suddenly and catch you by surprise. They can cause discomfort despite the benefit they provide. Knowledge about your car is a good way to make safety interventions feel less unsettling when they occur. Be sure to read any notifications following an intervention to better understand why the car intervened.

Reducing the amount of interventions and warnings

The amount of safety interventions and warnings you experience depends on the driving conditions and your driving style. Certain combinations of factors might result in responses you perceive to be unnecessary or too sensitive. In general, the most effective way of reducing the amount of warnings and interventions is to drive responsibly. Adapt your speed to the driving conditions and keep a safe distance to other vehicles. You can also adjust or turn off certain features in settings.

Balancing the response need

When the car suggests, guides or performs a driving action, it is considered a response. Most driver support features have some set of possible responses. For instance, automatic braking to prevent a collision with a car that suddenly brakes in front of you is a response. Features that can provide you with warnings and safety interventions are designed to limit unnecessary responses.

Your car's responses each have their own set of conditions. These conditions can be related to the traffic situation, the state of the car and driver, and information collected using the car's detection systems. For a response to occur, all of the required conditions need to be met and the car must have a high certainty that the response is needed. As a situation develops, the car continuously evaluates the conditions and response need. If the response need or conditions are uncertain, then the car won't respond.

If a potentially hazardous situation can be easily addressed by the driver, that is preferred over a response by the car. The car can delay or avoid providing a response in situations where you have the opportunity to address it using non-emergency manoeuvring. This helps reduce unnecessary warnings and safety interventions. Most potential hazards identified by the car are addressed by the driver through minor adjustments well ahead of the need for emergency evasive manoeuvring. In most instances, you perceive them as routine actions that are part of normal driving.

 **Important**

Always address driving hazards

The car can and will compensate for some, but not all, instances where you are unable to or fail to respond to a driving hazard. There are situations in which an effective response is beyond the capabilities of the car, and situations in which a response is not provided because the driver is expected to address the potential hazard. When driving, you are required to stay alert and attentive so that you can respond to hazards the same way you would driving a car without driver support features.

Conditions and limitations

Warning

Never rely on safety interventions by the car to be a replacement for safe driving practices. Drive the car with the same attention to safety as required by a car without these features.

Warnings and interventions cannot be guaranteed in any situation. The car cannot handle all driving, traffic, weather and road conditions. Failure of the car to detect or respond to a hazard can happen for reasons that you may not be able to identify or predict.

The car's ability to respond to hazards varies depending on many factors. They often fall into any of the following categories:

- Your car's speed and movement.
- Size, shape, speed and movement of objects or road users around the car.
- Environmental conditions.
- The condition of the driving infrastructure.
- The complexity of the traffic situation.

Notable examples include:

- Sharp turns can cause detection to become less consistent. The car might be unable to identify hazards that appear suddenly as a result of turning sharply.
- Low traction, such as when the road is wet or icy, can reduce the effectiveness of interventions.
- Conditions and limitations affecting obstacle detection can prevent the car from accurately identifying potential hazards. Obstacle detection limitations are described in detail in the separate manual section about how surroundings and traffic is detected by the car.
- The car won't perform automatic braking interventions if you are driving forwards at or below walking pace. This is to avoid unwanted braking interventions when you are manoeuvring in tight spaces.



Important

General limitations

You have good reason to feel safe in a car capable of intervening in dangerous situations, but it's important to still do your best to drive safely and responsibly. The capabilities of the car are always limited by technological factors and constraints, the car's condition and the driving environment.

Detection capabilities

The car's ability to monitor its surroundings is used by features that can provide warnings and interventions. To better understand the limitations of such features, read the separate section about detection of traffic and surroundings. It provides an overview of how important components work, such as cameras and radars, detailing both capabilities and limitations.

Reaction times

In favourable conditions, the car can perceive and react to certain hazards, in some cases faster than a human driver can. However, this capability is not a guarantee of intervention as the car cannot detect all potential hazards that may require a response.

Availability of responses

All of the car's response types have their own set of conditions that define when they are available. This means that available responses constantly change as you drive. Certain conditions are strictly defined, such as an exact speed range, a setting being enabled or the driver wearing their seatbelt. Other conditions have more imprecise thresholds that can depend on a combination of factors. This has the effect that you cannot with certainty know if or how the car will respond in a given situation, but you can develop a sense of what responses are likely or not.

Read everything about the features you use

You are recommended to read all information about driver support features before using them. It's essential to understand both their capabilities and limitations.

Wear your seatbelt

Emergency braking interventions requires that the driver is wearing their seatbelt. Also make sure that any passengers also wear their seatbelts. The risk of injury from hard braking rises significantly for unrestrained occupants.

Driver responsibility

Features that provide interventions and warnings are supplements to safe driving practices. They do not reduce or replace the need for the driver to stay attentive and focused on driving safely. The section covering driver responsibility is essential reading to understand the limitations of safety interventions and warnings. If you find anything unclear or have further questions, do not hesitate to contact your Volvo dealer.

^[1] Driver Alert

^[2] Rear Cross Traffic Alert (RCTA)

^[3] Rear Auto Brake (RAB)

10.3.1. Collision warnings and mitigation

Your car has warning features designed to reduce the risk of a collision. If a collision cannot be avoided, early warning and response can help reduce its effects.

Collision warning features include:

- Forward collision warnings
- Warnings about vehicles cutting across your lane
- Rear collision warnings

Note

Safety interventions

If an urgent enough collision risk is identified, the car can intervene to avoid or mitigate the collision without any preceding collision warnings.

Warning

Never rely on collision warnings or safety interventions by the car to be a replacement for safe driving practices. Drive the car with the same attention to safety as required by a car without these features.

Forward collision warnings

Forward collision warnings can occur if you are getting too close to a vehicle in front of you. The car warns you if it identifies a collision risk that requires your immediate attention. This is done through notifications in the driver information area. If you are using the driving view, animations can be shown in combination with the notifications.

The situation and level of urgency affect how forward collision warnings are communicated. Warnings can be communicated visually in the driver information area, with sound and with brake pulses.

There are three levels of escalation for forward collision warnings.

1. **Increase distance to vehicle ahead**
2. **Brake!**
3. **Safety intervention. Forward collision risk.**

You can adjust how early you want to be warned. This is done in settings.

Warnings about vehicles cutting across your lane

Your car can warn you if you are about to be cut off, such as when a vehicle changes lanes just in front of you. Vehicles that swerve or move unpredictably in adjacent lanes can trigger these warnings as well. Your car uses messages in the driver information area to warn you in these situations. If you are using the driving view, the messages can be shown in combination with animations.

Rear collision warnings

If your car identifies a situation with a high risk of a rear collision, it can flash its rear lights to warn drivers behind you. Rear collision warnings appear automatically if you slow down suddenly^[1], such as during very hard braking. Warnings can also be provided if your car detects a vehicle rapidly approaching from behind. In this case, you do not need to be slowing down for a warning to appear. They can appear both when you're driving and when stopped, but only if your car detects a high enough risk of collision.

If your car identifies a risk of a rear collision, this will be indicated in the driver information area if you are using the driving view.

You can turn rear collision warnings on or off in settings.

 **Note**

Collision response

If a collision cannot be avoided, the car can respond in other ways to protect occupants and reduce the danger to surrounding traffic. Read more about these features in the safety section of this manual.

^[1] The rate of deceleration must exceed a certain threshold.

10.3.1.1. Adjusting the sensitivity for forward collision warnings

You can adjust the sensitivity of forward collision warnings in settings, giving you earlier or later warnings.

 **Important**

Changing driver support settings

Make sure that you understand how changing the car's settings affects its behaviour. It is particularly important when it comes to features that affect the level of assistance the car can provide.

1. Press the car symbol  in the bottom bar and go to **Settings**.
2. Go to **Driving** → **Safety assistance** → **Forward collision warning**.
3. Adjust how early or late forward collision warnings appear.

10.3.1.2. Enabling and disabling rear collision warnings

Rear collision warnings can be enabled or disabled in settings.

 **Important**

Changing driver support settings

Make sure that you understand how changing the car's settings affects its behaviour. It is particularly important when it comes to features that affect the level of assistance the car can provide.

1. Press the car symbol  in the bottom bar and go to **Settings**.
2. Go to **Driving** → **Safety assistance** → **Rear collision warning**.
3. Enable or disable rear collision warnings.

10.3.2. Interventions and warnings when reversing

Your car has specialised features that can intervene and help prevent collisions when you are reversing at low speeds, such as when parking.

Forms of detection

The car has several ways to identify objects that are in or approaching your reversing path. If it detects an object, the car can provide warnings or intervene by braking.

Ultrasonic parking sensors These sensors can identify certain obstacles immediately behind the car when reversing at low speeds.

Rear-facing radar The car's rear radars can detect traffic approaching your reversing path from the sides.

Camera Certain features may use camera detection to help identify obstacles when reversing.

 **Important**

These types of detection have limitations and cannot detect all obstacles in every situation. Be sure to read the separate manual sections about their conditions and limitations.

When you are reversing, some information from the detection systems can be communicated in the parking view.

Warning and intervention features

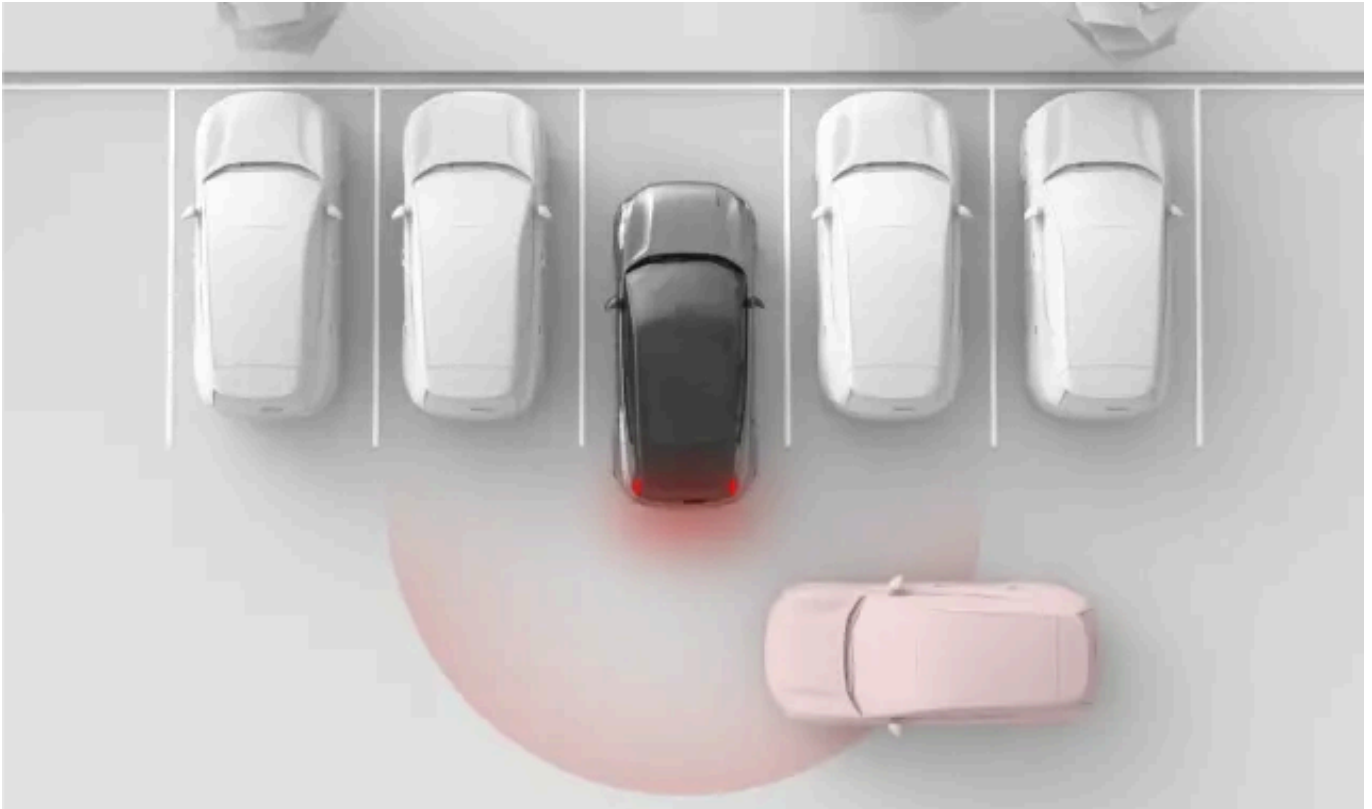

The following features are designed to react when the car identifies a risk of collision when reversing.

Alerts about traffic crossing behind the car^[1] Your car can provide visual alerts if it detects traffic about to cross your reversing path.

Automatic braking when reversing^[2] The car can automatically brake if an obstacle is detected immediately behind the car while reversing at low speeds.



Tip

Temporary deactivation

These features can be temporarily turned off if their interventions are too frequent or distracting. For example, reversing in tall grass or manoeuvring in very tight spaces can cause unwanted braking interventions.



Important

Use responsibly

Warnings and interventions when reversing are supplements to safe driving practices. They do not reduce or replace the need for the driver to stay attentive and focused on driving safely.

Pay attention to surroundings

The driver is always responsible for paying attention to the car's surroundings and ensuring that it is safe to manoeuvre the car.

^[1] Rear Cross Traffic Alert (RCTA)

^[2] Rear Auto Brake (RAB)

10.3.2.1. Alerts about traffic crossing behind the car

When you're reversing at low speeds, the car can alert you if it detects traffic about to pass behind you. The name of this feature is Rear Cross Traffic Alert^[1].



Alerts about traffic crossing behind the car are only available when the car is in reverse or neutral gear. Using the rear radars, this feature can detect traffic approaching from the sides and provide a visual alert in the parking view. The visual alert can also be accompanied by a sound.

These alerts are primarily for larger vehicles in motion, such as cars. In favourable conditions, the car may also be able to warn you of smaller moving objects.

Important

Driver responsibility

Alerts about traffic behind the car are a supplement to safe driving practices. They do not reduce or replace the need for the driver to stay attentive and focused on driving safely.

Note

Automatic braking for crossing traffic

If the separate Rear Auto Brake function is enabled, the car may also intervene by braking to prevent or mitigate an imminent collision with traffic detected behind you.

Detection zones

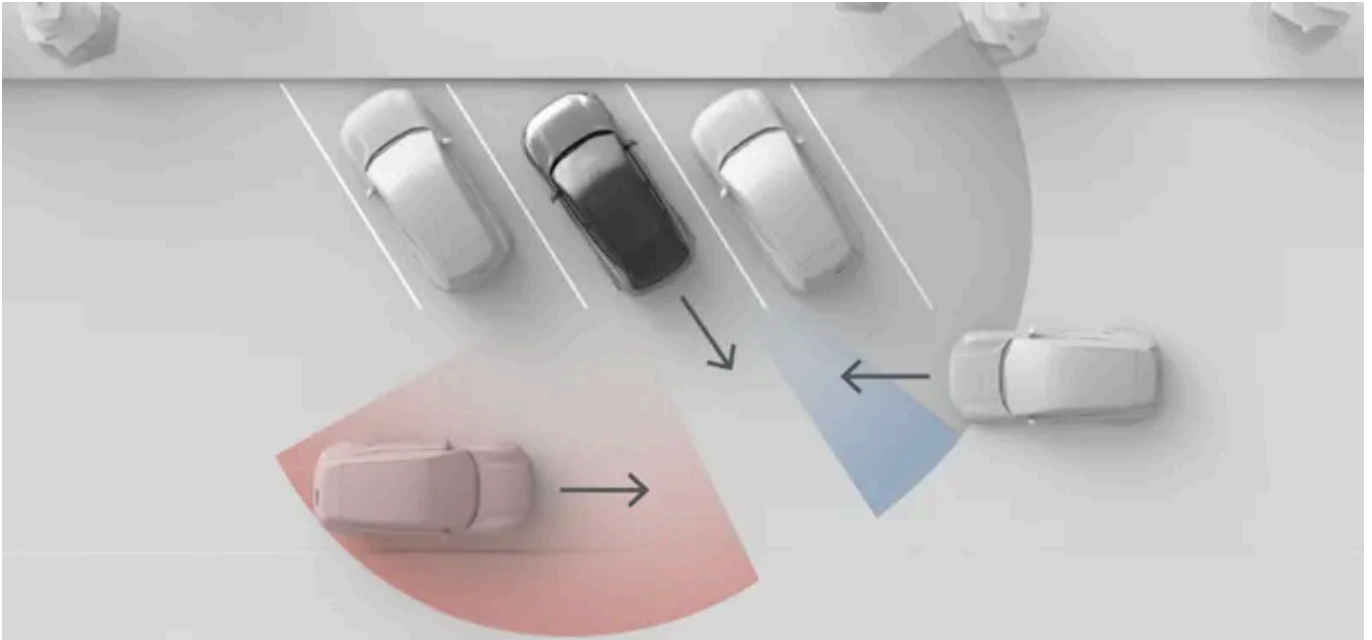

The situation shown in this image illustrates how surrounding objects, such as parked cars, can limit the radar's view. In a situation without obstacles, the effective detection zones are the same on both sides.

i Note

Reversing out of a parking space

When parked, your rear corner radar views might be obstructed to the sides, which affects detection of crossing traffic. This happens when you are parked with the rear corners of your car further in than adjacent cars or other objects. This effect is particularly noticeable in angled parking spaces. However, as you reverse out of a parking space, the radars' views gradually increase, making detection possible. To minimise the risk of late or no detection when reversing out of a parking space, go slowly.

Conditions and limitations

- The alerts are only available when reversing at speeds below 15 km/h (9 mph).
- If the car deactivates the rear radars, this feature is automatically disabled. This happens if a trailer is connected. Towbar-mounted accessories that are not connected electrically to the car does not disable the rear radars, but can obstruct them.
- Detection of traffic behind the car relies on detection by the rear radars. Be sure to read the separate section about limitations of radar detection.

[1] RCTA

10.3.2.1.1. Disabling rear cross traffic alert

The rear cross traffic alerts can be temporarily disabled in settings.

 **Important**

By disabling rear cross traffic alert, you also disable your car's ability to perform braking interventions if it detects a vehicle approaching your reversing path.

Changing driver support settings

Make sure that you understand how changing the car's settings affects its behaviour. It is particularly important when it comes to features that affect the level of assistance the car can provide.

1. In the parking view, press the RCTA button.



RCTA

- > Alerts about traffic crossing behind your car are temporarily disabled.

 **Note**

Disabling rear cross traffic alerts is only temporary for your current drive. The next time you start your car, the function will be re-enabled by default.

10.3.2.2. Disabling automatic braking when reversing

The rear auto brake can be temporarily disabled in the parking view.

By disabling the rear auto brake, your car will not brake for obstacles detected immediately behind it. However, if rear cross traffic alerts are enabled, it can still intervene by braking if it detects traffic approaching your reversing path.

 **Important**

Changing driver support settings

Make sure that you understand how changing the car's settings affects its behaviour. It is particularly important when it comes to features that affect the level of assistance the car can provide.

1. In the parking view, press the RAB button.



RAB

> The rear auto brake is temporarily disabled.

10.3.3. Lane keeping aid

Lane keeping aid helps prevent accidental high-speed lane departures by providing warnings and steering interventions.



When lane keeping aid is enabled, the car can alert you if you are about to drift out of your lane. It can also perform steering interventions. Lane keeping aid relies on the car's forward-facing camera to identify road markings and your position in the lane.

 **Warning**

Lane keeping aid warnings and interventions are supplements to safe driving practices. They do not reduce or replace the need for the driver to stay attentive and focused on driving safely. Drive the car with the same attention to safety as required by a car without the ability to intervene.

Main conditions for using lane keeping aid

For lane keeping aid to work, several conditions need to be met. The following are the most essential:

- Your speed must be in the range of 65-180 km/h (40-110 mph).
- The lane markings must be clearly visible for the car's camera to see.
- The lane must be wide enough. A very narrow lane does not provide enough space between the car and the road markings.

The content of this manual represents the status of the user manual at the time of printing and may not be completely valid in future instances. For more information, refer to the first page for the complete disclaimer note.

- You must keep your hands on the steering wheel and actively steer the car.

 **Important**

Steering actively

Never let go of the steering wheel when driving. Do not dismiss the car's requests for you to steer actively and keep your attention on the road.

Lane keeping aid intervention types

If you are about to cross your lane's road markings, your car can intervene in either or both of the following ways:

Steering intervention The car tries to steer back into the lane.

Lane departure warning The car alerts you using steering wheel vibrations.

You can enable or disable both the steering interventions and the lane departure warnings in settings.

 **Note**

Indicating a turn or lane change

As long as you use the direction indicators when changing lanes, the car assumes it's an intentional manoeuvre.

Safety interventions are always enabled

Some situations can cause a steering intervention to prevent a dangerous lane departure even if lane keeping aid is turned off in settings.

Display symbols and communication

Lane keeping aid warnings and interventions are communicated in the driver information area.

When the driver information area shows the driving view, warnings and interventions are shown as road marking animations.



Interventions by lane keeping aid are indicated with a solid line marking in red.



Warnings are indicated with a solid line marking in amber.

When the display shows the calm view, symbols are used instead.



This symbol appears if you are about to cross your lane's road markings on the left-hand side.



This symbol appears if you are about to cross your lane's road markings on the right-hand side.

Inactive lane keeping aid



This symbol indicates that lane keeping aid is disabled in settings.



This symbol appears when there is a lane keeping aid malfunction. This means that lane keeping aid and safety interventions to prevent lane departures are disabled due to a system malfunction.

Conditions and limitations

For lane keeping aid to work, road markings must be present and visible. The car identifies them using a forward-facing camera. This form of detection requires that the camera view is unobstructed and that the conditions for visual detection are present. Read the separate section of this manual about conditions and limitations of your car's cameras to understand how features relying on camera detection are affected.

The appearance, condition and layout of road markings can affect their detection in the following ways:

- Lane divisions and mergers can cause temporary misidentification of the lane.
- Non-standard or unusual road marking layouts might not be identified correctly by the car. For example, road work or traffic diversions can result in conflicting or multiple sets of road markings.
- The car may be unable to detect deteriorated road markings, for example if they are worn, misshapen or discoloured.
- Other edges or lines can be misidentified as road markings, such as kerbs, road surface repair edges, barriers or well-defined shadows.
- Road markings must be sufficiently illuminated to be detected. In low-light conditions, they need to be illuminated by the car or street lights.

10.3.3.1. Disabling lane keeping aid

You can enable or temporarily disable lane keeping aid in settings.

When lane keeping aid is enabled, the car can alert you or intervene by steering if you are about to drift out of your lane.

You can temporarily disable lane keeping aid if it interferes too much with your driving. This can be useful if the road markings are partially obscured or faded, which can cause unwanted warnings.

Important

Changing driver support settings

Make sure that you understand how changing the car's settings affects its behaviour. It is particularly important when it comes to features that affect the level of assistance the car can provide.

1. Press the car symbol  in the bottom bar and go to **Settings**.
2. Go to **Driving** → **Safety assistance** → **Lane keeping aid**.
3. Enable or disable lane keeping aid.

 **Note**

Disabled

A symbol is shown in the driver information area when lane keeping aid is disabled.



 **Tip**

If you want to disable alerts about accidental lane departures, you can do this in settings as well.

10.3.3.2. Disabling lane departure warnings

You can disable lane departure warnings in settings.

When lane departure warnings are enabled, the car can alert you with steering wheel vibrations if you are about to drift out of your lane.

You can temporarily disable lane departure warnings if they interfere too much with your driving. This can be useful if the road markings are partially obscured or faded, which can cause unwanted warnings.

 **Important**

Changing driver support settings

Make sure that you understand how changing the car's settings affects its behaviour. It is particularly important when it comes to features that affect the level of assistance the car can provide.

1. Press the car symbol  in the bottom bar and go to **Settings**.
2. Go to **Driving** → **Safety assistance** → **Lane departure warning**.
3. Disable lane departure warnings,

10.3.4. Blind spot information

The blind spot information feature helps increase your awareness of vehicles in or approaching your blind spots. A light appears in the wing mirror when a vehicle is detected.

Blind spot alerts can increase your awareness of vehicles to the side of your car, which can help you avoid performing dangerous lane changes. The alerts primarily appear as a light in the wing mirror on the side of detection. They rely on your car's rear radars for detection of vehicles in adjacent lanes.

Traffic situations in which blind spot alerts appear include:

- When you are being overtaken by another vehicle.
 - In some cases, they can appear before the passing vehicle reaches your blind spot. This happens if it's quickly approaching from behind in an adjacent lane.
- When you are overtaking another vehicle.

Regardless of the situation, the alert remains as long as the other vehicle is detected to your side.



Tip

Blind spot alerts and door opening alerts

Door opening alerts are indicated in the same way as blind spot alerts. These two features also rely on the same rear radars for detection of traffic. However, the features are enabled or disabled independently of each other.

Alerts in the wing mirrors

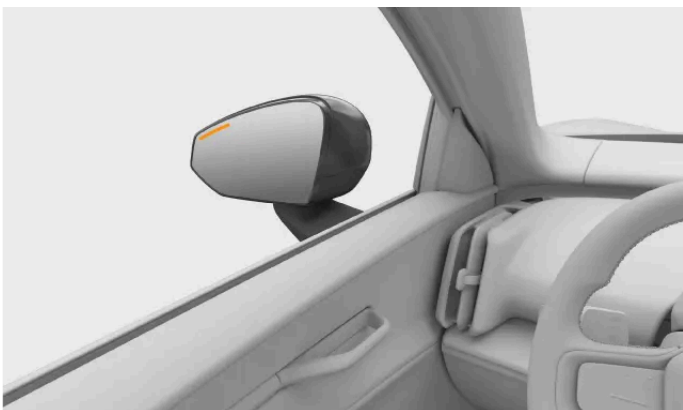

When a vehicle is detected in or approaching your blind spot, a light appears in the wing mirror.

Detection areas

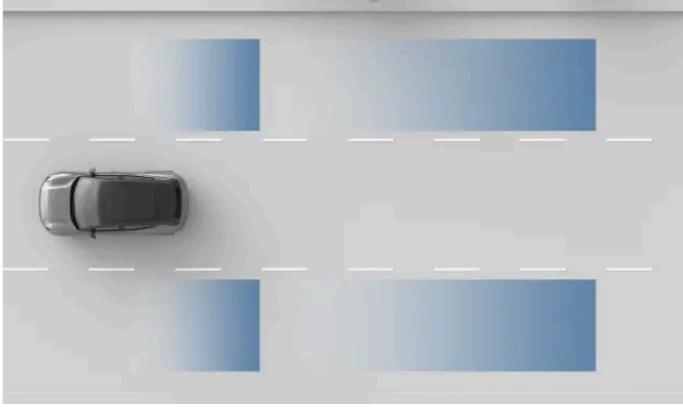

Radar detection areas.

! Important

The detection areas may not perfectly cover your own blind spots. Be sure to adjust your driving posture to allow for a good overview of surrounding traffic.

Conditions and limitations

- Blind spot information is active at speeds above 15 km/h (10 mph). It's not available when reversing.
- When passing other vehicles, the speed difference between your car and the other vehicles must be below 15 km/h (9 mph) for the alerts to appear.
- Blind spot information relies on detection by the rear radars. Be sure to read the separate section of this manual about the limitations of radar detection.
- If the rear radars are obstructed, such as by an attached trailer or mounted bike rack, alerts about vehicles in the blind spots are automatically disabled.

! Important

Driver responsibility

Alerts about vehicles in the blind spots are a supplement to safe driving practices. They do not reduce or replace the need for the driver to stay attentive and focused on driving safely.

The lack of a blind spot indication is not a confirmation that it is safe to change lanes. It is one of several pieces of information that inform the driver's assessment of whether it is safe to proceed.

10.3.4.1. Enabling blind spot alerts

You can enable or disable blind spot alerts in settings.

When blind spot alerts are enabled, your car can alert you of vehicles in or approaching your blind spots.

 **Important**

Changing driver support settings

Make sure that you understand how changing the car's settings affects its behaviour. It is particularly important when it comes to features that affect the level of assistance the car can provide.

1. Press the car symbol  in the bottom bar and go to **Settings**.
2. Go to **Driving** → **Safety assistance** → **Blind spot information**.
3. Enable or disable blind spot alerts.

10.3.5. Door opening alerts

Door opening alerts are designed to make exiting your car safer. They can warn you of traffic approaching from behind so that you don't open a door in its path.

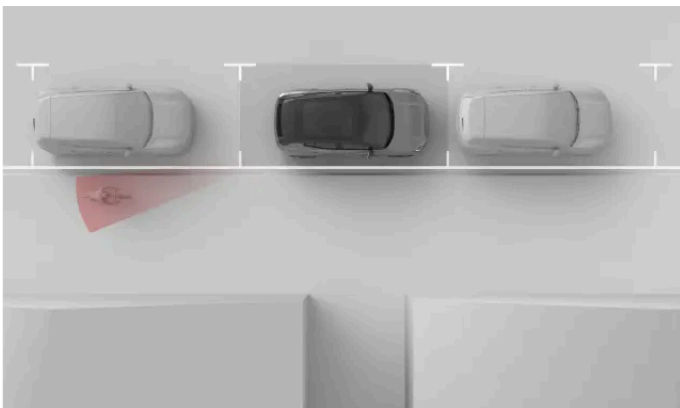

Door opening alerts are designed to warn you of passing traffic so that you don't open a door in its path. These alerts can be provided when the car is stationary or moving very slowly^[1].

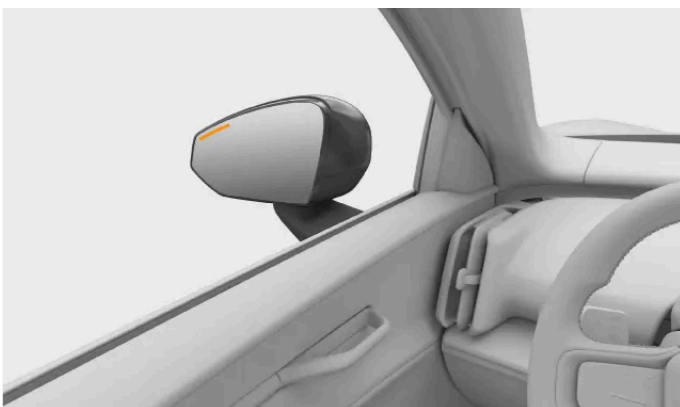

When the car detects traffic that is about to pass close to the car's sides, a light appears in the wing mirror along with a notification in the display. If you begin to open the door on the side of the detected traffic, the alert intensifies. A sound alert can occur along with the visual alerts depending on how urgent the warning is.

Door opening alerts can be turned on or off in settings.



Tip

Door opening alerts and blind spot information

Door opening alerts are indicated in a similar way to alerts about vehicles in your blind spot. These two features also rely on the same rear radars for detection of traffic. However, the features are enabled or disabled independently as they have separate use cases.

Limitations

The car uses its rear radar system to detect approaching traffic. Be sure to read about radar and detection conditions and limitations in their separate section of the manual.



Important

Door opening alerts are supplements to safe user practices. The driver and passengers are fully responsible for making sure that the car doors can be safely opened.

^[1] Below 3.6 km/h (2.2 mph)

10.3.5.1. Enabling door opening alerts

Door opening alerts can warn you of traffic approaching from behind so that you don't open a door in its path. You can enable or disable these alerts in settings.

1. Press the car symbol  in the bottom bar and go to **Settings**.
2. Go to **Driving** → **Safety assistance** → **Door opening alert**.
3. Enable or disable door opening alerts.

10.3.6. Driver alert

The car continuously observes your behaviour while driving and can alert you if you seem unfocused. A lack of focus can be caused by distractions or being tired.

The car analyses your driving behaviour and can detect signs of tiredness. If the car identifies signs of reduced driver focus, it will notify you in the driver information area and with a sound.



The car uses sensor tracking of your face and eye movements to assess your focus when driving. This allows the car to determine where you are directing your attention and to detect signs of tiredness.

Driver alert notifications can be turned off in settings. This does not disable the systems that monitor your driving as they are used by other features.

 **Warning**

The importance of a well-rested driver

Any notifications about you showing signs of being tired should be taken seriously, as a tired driver is often unaware of their condition. If you feel tired or receive an alert about it from the car, stop as soon as possible in a suitable location for a rest. Always plan for regular breaks and start all trips with a well-rested driver.

Driving while tired is comparable to driving under the influence of alcohol.

 **Important**

Driver responsibility

Alerts about a lacking focus when driving are a supplement to safe driving practices. The driver is fully responsible for making sure they are able to stay alert and maintain focus when driving.

Conditions and limitations

Attention tracking requires an unobscured view of the driver's face.

- Improperly stowed items can obscure the view of the driver, as can dust and dirt on the sensor. Keep the driver's space clean and clutter-free.
- Wearing certain clothing and accessories can obstruct parts of the driver's face that need to be visible for attention tracking, such as the eyes.

 **Note**

If something is blocking the view of the driver's face, you will be notified via the driver information area. The notification only appears once per driving cycle.

10.3.6.1. Disabling driver alerts

You can disable or enable driver alert notifications in settings.

Disabling driver alert notifications is only temporary as this setting automatically resets to enabled between drives.

Warning

The importance of a well-rested driver

Any notifications about you showing signs of being tired should be taken seriously, as a tired driver is often unaware of their condition. If you feel tired or receive an alert about it from the car, stop as soon as possible in a suitable location for a rest. Always plan for regular breaks and start all trips with a well-rested driver.

Driving while tired is comparable to driving under the influence of alcohol.

Note

Driver responsibility

Alerts about a lacking focus when driving are a supplement to safe driving practices. They do not reduce the driver's responsibility to continuously assess whether they are too tired or unfocused to drive safely.

1. Press the car symbol  in the bottom bar and go to **Settings**.
2. Go to **Driving** → **Safety assistance** → **Driver alert**.
3. Turn driver alert notifications on or off.

10.4. Assisted driving

Assisted driving features use the car's ability to monitor its surroundings to make driving safer and less demanding.

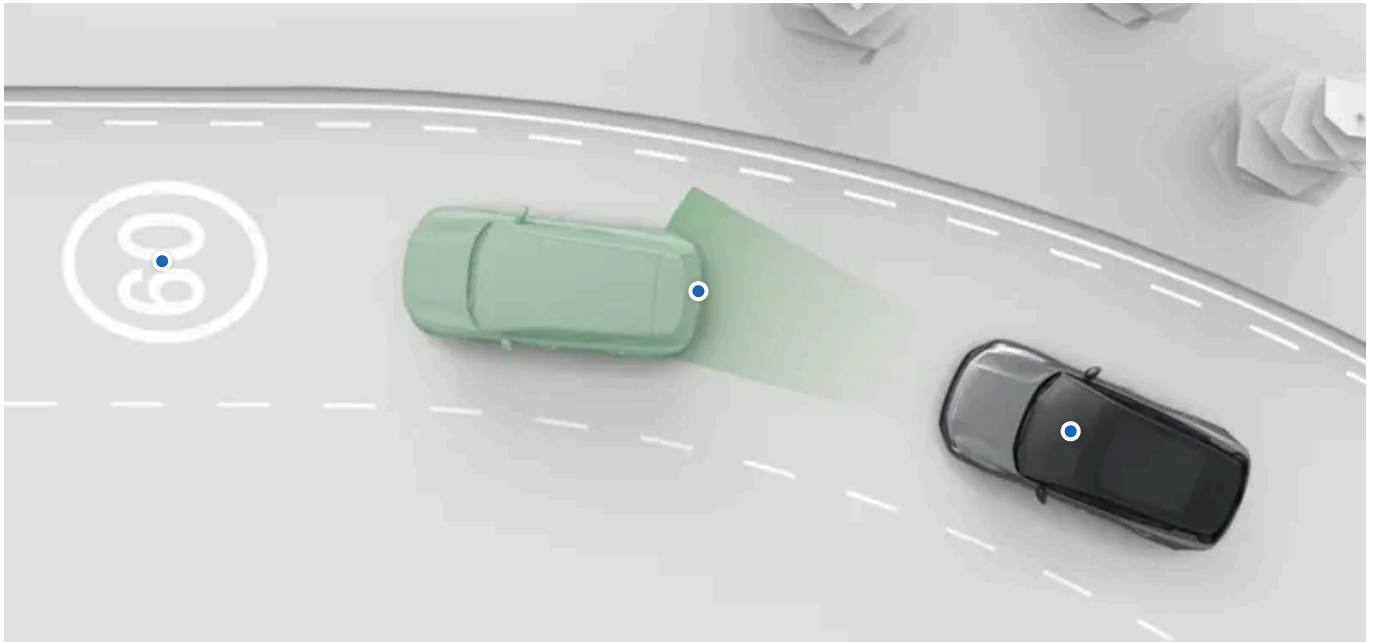

There are several forms and levels of assistance. They can actively assist you with a number of driving tasks and provide information support for better driver decision-making.

You can enable, disable or customise many of your car's assisted driving features in settings.

Pilot Assist	This feature can assist you in several driving tasks such as steering, managing speed and changing lanes. Pilot Assist can be customised in settings.
Road signs and speeding response	Several features can assist you with keeping track of the speed limit and preventing unintentional speeding. They include road sign information, which makes you aware of the speed limit, and different responses from the car designed to prevent you from exceeding the speed limit. These features can be customised in settings.



Tip

Safety interventions and warnings

Many of the driver support features are designed to improve both convenience and safety. Features that primarily provide safety interventions and warnings have their own, separate section in this manual.

Assisted parking

There is a separate section of this manual covering assisted parking features.

 **Important**

Required knowledge and driver responsibility

Assisted driving features are designed to make driving safer and less demanding, but they do not reduce the driver's responsibility to operate the car as safely as possible. Be sure to read all related information about a feature before using it. The section covering driver responsibility is essential reading to understand the capabilities and limitations of your car's assisted driving features.

If you find anything unclear or have further questions, do not hesitate to contact your Volvo dealer.

Detection capabilities

The car's ability to monitor its surroundings is used by assisted driving features. To better understand the limitations of such features, read the separate section about detection of traffic and surroundings. It provides an overview of how important components work, such as cameras and radars, by detailing both capabilities and limitations.

10.4.1. Road signs and speeding response

Several features can assist you with keeping track of the speed limit and preventing unintentional speeding.

To encourage maintaining a legal speed, your car is designed to make you aware of the current speed limit by showing it in the driver information area. It can also respond with warnings if you exceed the speed limit.

- Road sign information** The car can detect and display information from road signs, such as the speed limit.
- Speed limiter** When enabled, this feature reduces the response from the accelerator pedal if you exceed your selected limit.
- Speed limit warning** If you exceed the speed limit, this feature will warn you by providing sound alerts.
- Sound for new speed limit** A sound alert indicates when the car detects that the speed limit changes.

 **Note**

Intelligent Speed Assistance in your car

Your car is designed to meet the requirements of the European Union's Intelligent Speed Assistance^[1] regulation. The purpose of the regulation is to make driving safer by requiring features that encourage staying below the legal speed limit. In your car, the behaviour of speed limit warnings and displayed road signs is in part affected by these requirements.

 **Important**

Speed-related information and warning features are supplements to safe driving practices. They do not reduce or replace the need for the driver to stay attentive and focused on driving safely. It is the driver's responsibility to observe and maintain a legal and safe speed.

[1] ISA

10.4.1.1. Speed limiter

The speed limiter can help you avoid unintentional speeding. When it's active, the car's acceleration response is limited after exceeding your selected speed limit.

When active, the speed limiter can gradually reduce the response from the accelerator pedal and provide light braking when you exceed your selected limit. These two responses help nudge you down to the selected max speed. You can always override the speed limiter by pressing the accelerator pedal down further.

To use the speed limiter, it needs to be enabled in settings. You can then activate it with the right-hand steering wheel stalk during driving.

When the speed limiter is active, it is indicated below the gear indication in the driver information area. You can adjust the limit with the steering wheel buttons.



Important

Driver responsibility

The speed limiter feature is a supplement to safe driving practices. It does not reduce or replace the need for the driver to stay attentive and focused on driving safely. It is the driver's responsibility to observe and maintain a legal and safe speed.

10.4.1.1.1. Activating the speed limiter

You can activate or deactivate the speed limiter by moving the right-hand side steering wheel stalk downwards while driving.

When driving, a grey speed limiter symbol in the driver information area indicates that the function is available but not yet activated.

The speed limiter must be enabled in settings before it can be activated.^[1]

1.

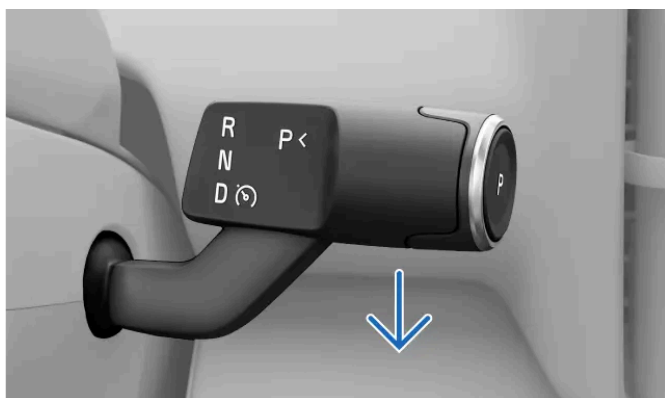

When appropriate, pull the right-hand steering wheel stalk all the way down.

> Your action is confirmed in the driver information area.



^[1] Enabling either of the speed limiter or Pilot Assist features automatically disables the other feature.

10.4.1.1.2. Deactivating the speed limiter

When you want to stop driving with the speed limiter, you can deactivate it manually.

Deactivating and activating the speed limiter is done in the same way. You simply pull the right-hand side steering wheel stalk downwards.

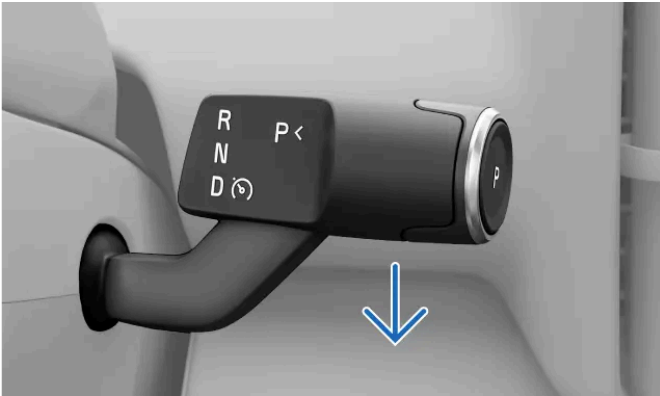

Pull the right-hand side steering wheel stalk all the way down.

> Deactivation is confirmed in the driver information area.

10.4.1.1.3. Adjusting the speed limiter value

You can adjust the speed limiter value using the steering wheel buttons.

When the speed limiter is active, you can adjust the set limit manually.

Adjustment actions:

Pressing once Adjusts the limit by 5 km/h or 5 mph^[1].

Press and hold Continuously adjust your set limit by 1 km/h or 1 mph by pressing and holding the button.

1. Adjust the set speed value with the  and  buttons on the steering wheel.

> Your new speed limiter value is shown next to the speedometer.

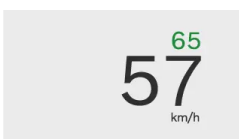

^[1] The limit will default to speed increments that are divisible by five, such as 25, 30 and 35.

10.4.1.1.4. Enabling the speed limiter in settings

You can enable or disable the speed limiter in settings. When enabled, it can help you in avoiding unintentional speeding.

1. Press the car symbol  in the bottom bar and go to **Settings**.
2. Go to **Driving** → **Driver support**.
3. Select **Speed limiter** as your default driver support function.

10.4.1.2. Speed limit warnings

Speed limit warnings can be provided to help prevent speeding.

Speed limit warnings are provided when you exceed the speed limit. The warnings appear visually in the driver information area and as a sound alert.



The speed limit warning symbol appears below the speedometer when you exceed the speed limit.

The sound alerts can be temporarily disabled for the duration of your current drive.

Conditions and limitations

Speed limit warnings use road sign information to keep track of the speed limit. If information about the speed limit is unavailable for some reason, no warning can be provided.

Important

Driver responsibility

Speed limit warnings are supplements to safe driving practices. They do not reduce or replace the need for the driver to stay attentive and focused on driving safely. It is the driver's responsibility to observe and maintain a legal and safe speed.

10.4.1.2.1. Disabling speed limit warnings

Speed limit warnings can be temporarily disabled for the rest of the drive.

Speed limit warnings are enabled by default for each new drive. They can be disabled and re-enabled in settings.



Tip

Quick access when driving

A button for turning speed limit warnings off is also available in the display when you drive. This allows you to quickly turn them on or off without going into settings.



1. Press the car symbol  in the bottom bar and go to **Settings**.
2. Go to **Driving** → **Safety assistance** → **Speed limit warnings**.
3. Temporarily disable speed limit warnings.

10.4.1.3. Disabling sound alerts for speed limit changes

Your car can alert you with a sound when it detects a new speed limit. This feature can be enabled or temporarily disabled in settings.

1. Press the car symbol  in the bottom bar and go to **Settings**.
2. Go to **Driving** → **Safety assistance** → **Sound for new speed limit**.
3. Enable or temporarily disable sound alerts for speed limit changes.

10.4.1.4. Road sign information

The car can identify and display road signs as you pass them. This allows you to keep track of the speed limit. The road sign information feature combines the direct detection of signs with information from map data.

The signs shown in the driver information area come from two different sources – either from real-world signs identified by cameras or from map data. The car automatically prioritises which source to use depending on the situation.

The car can only show signs that are part of the car's sign library.

How signs are shown

Detected road signs appear next to the speedometer in the driver information area. Different signs are shown in different areas.



Road sign symbols can also appear on the other side of the speedometer, depending on the current driver information area display mode.

- ① Warning signs and upcoming speed limit signs
- ② Current speed limit sign
- ③ Traffic information signs.

The car can simultaneously display several sign types. This can include the current speed limit, an upcoming speed limit or a warning sign, as well as an additional traffic information sign.

Displayed road signs

This list contains examples of road sign types that can be shown in the car.



Speed limit



No entry

Note

Symbol availability

Road signs available to display in your car can change over time and vary between regions. The selection presented in this manual may not include every sign that can appear in your car's display.

Symbol design

Road sign styles vary between regions. The symbol style displayed by the car will not exactly match the symbol style of signs you encounter. If you have any issues interpreting a displayed sign despite the information provided in this manual, contact Volvo support.

Road sign display times

The display time for signs typically depends on the type of sign and whether you pass additional signs. Road signs can be shown in the following ways:

- Briefly as one-time alerts after passing a sign.
- Until the sign no longer applies.
- Until you pass another sign with higher display priority.

Note

Lingering signs

The car might fail to identify a sign indicating the end of a traffic limitation. If this happens, a symbol for the previous limitation can linger in the driver information area. It will eventually be replaced or cancelled. In the meantime, drive according to the applicable rules of the road.

Conditions and limitations

Important

Driver responsibility and road signs

Road sign information is designed to help you manage information while driving. It is a supplement to safe driving practices. The driver is fully responsible for remaining attentive, keeping track of road signs and following local regulations. Do not prioritise the car's road sign detection over your own observations if they conflict.

Why all signs are not shown

The car cannot detect and show every sign that is relevant to the driver.

- The system does not support all signs.
- Signs may go undetected in certain conditions and traffic situations.

Conditions that affect road sign detection or identification:

- The car's forward-facing camera must be clean and free of obstructions.
- The road sign must be clearly visible and properly illuminated.
- The road sign must be within a certain distance of the car and within the camera's field of view.
- The car may not be able to identify misaligned road signs, such as signs placed too high or at an angle.
- The car may not be able to identify damaged or worn road signs.

Conditions that affect sign information from map data:

- An internet connection is required to download map data that contains information about road signs.
- The coverage of road sign information from map data varies between regions.

Note

For consistent and up-to-date road sign information in your car, be sure to accept Google's Terms of service. Contact an authorised Volvo workshop if you experience any issues with the road sign information feature.

10.4.2. Pilot Assist

Pilot Assist combines several support capabilities to make driving safer, more convenient and less demanding. It can assist you with speed management and steering guidance in a wide variety of situations.

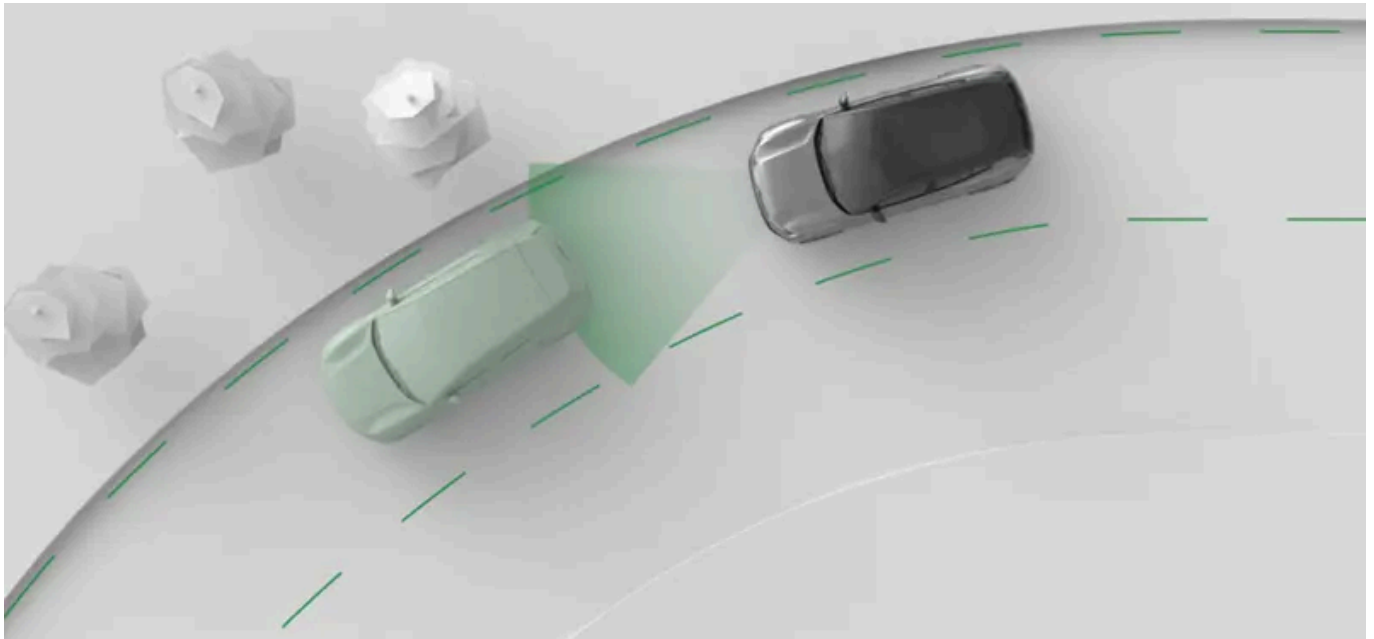

Pilot Assist actively guides your driving in a number of ways. When driving with Pilot Assist, you select the target speed. The car then manages acceleration and braking to meet that target while also adapting to surrounding traffic.

It's also capable of steering assistance. When enabled, steering assistance helps with road positioning by guiding your steering wheel movement.

Important

Before using Pilot Assist

- Take the time to read everything the manual has to say about Pilot Assist before using it.
- This support feature depends on information from radar and camera detection systems. Understanding their capabilities and limitations is necessary for safe use.

The driver is in control

When using Pilot Assist, you are still in control of the car. It's your responsibility to continuously assess Pilot Assist's performance. As long as you judge its input to be correct, you can let it guide your driving.



Tip

Customise Pilot Assist

Some of Pilot Assist's capabilities can be customised in settings. This allows you to set it up for the level of support you want.

Managing speed and distance to vehicles ahead

When you activate Pilot Assist, a set speed value appears by the speedometer. This represents the target speed that Pilot Assist tries to maintain. You can adjust the set speed with the steering wheel buttons.

Instead of manually adjusting the set speed, you also have the option to use the current speed limit as your target speed. The set speed then automatically updates when the speed limit changes. This can be enabled in Pilot Assist's settings.

If your car detects a vehicle ahead that's either slower than you or a bit too close, Pilot Assist will slow down to maintain a certain distance to the vehicle in front. Once the road ahead becomes clear again, your car returns to the target speed. You can adjust the general distance to vehicles ahead in Pilot Assist's settings.

Steering assistance

The availability of active steering assistance depends on the conditions you are experiencing. For example, if you encounter a stretch of road with worn-out markings, the car may temporarily turn steering assistance off and tell you to increase your level of control. As soon as the necessary conditions are met again, steering assistance reactivates.

Steering assistance can be enabled in Pilot Assist's settings.

Pilot Assist features and settings

There are a number of Pilot Assist capabilities and settings to read about in this manual.

Steering assist	When driving with steering assistance, your steering is actively guided. This can help you maintain correct lane positioning.
Lane change assist	Guides lane change manoeuvres initiated by the driver.
Adapt to speed limit	Adapts the set target speed to follow the speed limit.
Time interval to vehicle ahead	Adjust the target time interval to the vehicle ahead.

Status and availability

To use Pilot Assist, it needs to be enabled in settings. It is then available for activation when you are driving. Availability is indicated in the driver information area and depends on the current driving conditions. You can always see the current level of support you're getting from Pilot Assist in the driver information area.



Note

Paused

In some situations, Pilot Assist can be temporarily paused. This can happen when a driver decision is needed to resume driving with Pilot Assist, such as after coming to a stop. When Pilot Assist is paused, a message with instructions for resuming is typically shown in the display.





10.4.2.1. Pilot Assist communication and status

Learn how Pilot Assist's status and actions are communicated in the car.

The driver information area of the display shows the status of Pilot Assist using graphics and symbols. Important information can also appear as notifications.

Some situations, such as a temporary loss of steering assistance, may cause steering wheel vibrations along with notifications in the display.

The primary status is shown below the gear indicator. It tells you whether Pilot Assist is active or not.

-  Pilot Assist is off but available to activate if all conditions are met.
-  Pilot Assist is active without providing steering assistance.
-  Pilot Assist is active and providing steering assistance.
-  Lane change assist communication. The colour and direction of the arrows are different depending on the situation.
-  Steering assistance is temporarily unavailable.

The target speed appears in green next to the speedometer.

Communication in surround display mode



- ① An assisted lane change is possible
- ② Pilot Assist is adapting the speed to a vehicle ahead
- ③ Steering assistance is active and providing support

When the driver information area shows the surround mode, Pilot Assist's status and actions are shown as animations. The animations can show what level of support Pilot Assist is currently providing, depending on your Pilot Assist settings. This may include speed-keeping, distance-keeping, adjusting the speed to other vehicles ahead, available assisted lane changes and steering assistance.

 **Important**

Using surround mode

Surround mode cannot perfectly depict what is really happening on the road around you, so do not rely on it when you are driving.

Communication in calm display mode

When the driver information area of the display shows the calm mode, Pilot Assist's status is communicated using symbols. They can show what level of support Pilot Assist is currently providing, depending on your Pilot Assist settings.



Pilot Assist is off but available to activate if all conditions are met.



Pilot Assist is active without providing steering assistance.



Pilot Assist is active and providing steering assistance.



Pilot Assist is adapting the car's speed and distance to a vehicle ahead.



An assisted lane change is available. The arrow indicates the direction of the available lane change.



A lane change is ongoing. The arrow indicates the direction of the initiated lane change.



Lane change assist is unavailable and any ongoing lane change is cancelled. This can happen if there is a fault affecting critical systems, such as steering assistance. Be attentive to any messages that may follow.

Notifications and messages

When using Pilot Assist, notifications can appear in the driver information area. They can contain important information about the status of Pilot Assist features as well as instructions for you to follow, such as not letting go of the steering wheel.

10.4.2.2. Activating Pilot Assist

You activate Pilot Assist by moving the right-hand steering wheel stalk downwards while driving. It's important to assess whether the current driving conditions allow you to use Pilot Assist safely.

When driving, a grey Pilot Assist symbol in the driver information area indicates that the function is available but not yet activated.



Pilot Assist is only available for activation if it's enabled in settings.^[1]

! Important

Before using Pilot Assist

Take the time to read everything about Pilot Assist in this manual before using it for the first time. Understanding its capabilities and limitations is important for safe use.

Assess the situation

Make sure the traffic situation and conditions are suitable for activation. Wait until ongoing manoeuvres, such as a lane change, are completed before activating Pilot Assist.

Activating Pilot Assist when driving

1.

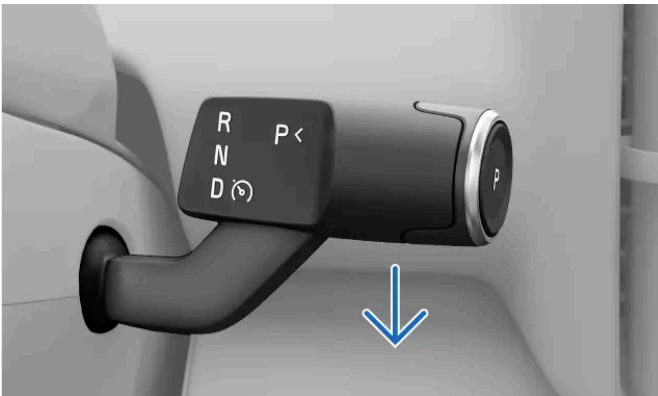

When appropriate, pull the right-hand steering wheel stalk all the way down.

> Activation is confirmed in the driver information area.



The first time you activate Pilot Assist during a drive, your speed at the time of activation becomes the set speed. If Pilot Assist is set to adapt to the speed limit, it will use the current speed limit as its target speed.



Tip

Resume

If you recently used Pilot Assist and you want to activate it again you can use the resume button  on your steering wheel. In this case, your previously used set speed is used instead of your current driving speed.

Pilot Assist symbols

When Pilot Assist is active, its level of support is shown via symbols and graphics in the driver information area.

[1] Enabling either of the Pilot Assist or speed limiter features automatically disables the other feature.

10.4.2.3. Deactivating Pilot Assist

When you want to stop driving with Pilot Assist, you can deactivate it manually. There are also situations in which Pilot Assist deactivates automatically.

Deactivating and activating Pilot Assist is done in the same way. You simply pull the right-hand side steering wheel stalk downwards. You can also deactivate Pilot Assist by braking.

When you deactivate Pilot Assist, all of its assistance is turned off. This includes speed- and distance-keeping as well as steering assistance.

Deactivating Pilot Assist using the stalk

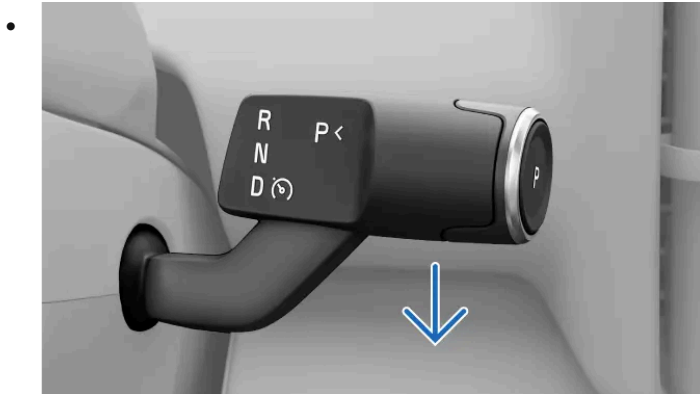

Pull the right-hand side steering wheel stalk all the way down.

> Deactivation is confirmed in the driver information area.

Deactivating by braking

- Press down on the brake pedal.

> Deactivation is confirmed in the driver information area.

Note

Automatic deactivation

Pilot Assist has several limitations and only works if all the necessary conditions are met. If the driving conditions change during your drive, Pilot Assist can deactivate automatically.

Scenarios where Pilot Assist may automatically deactivate include, but are not limited to, instances where:

- You are not driving actively. You must stay attentive and keep both of your hands on the steering wheel, even if steering assistance is activated.
- You open a door or unbuckle your seatbelt.
- You change gears. Pilot Assist can only support you when D is selected.
- You manually speed up and exceed 150 km/h (90 mph).
- Camera or radar conditions for Pilot Assist are not met.

10.4.2.4. Adjusting the target speed for Pilot Assist

Pilot Assist can support you in keeping a set target speed. You can adjust the target speed with the steering wheel control buttons.

When you are driving with Pilot Assist active, you can select a target speed. The car then manages acceleration and braking to meet that target while also adapting to surrounding traffic.

You can adjust your set speed target by pressing the set speed adjustment buttons on your steering wheel's left-hand side control area.

Adjustment actions:

Pressing once Adjusts the target speed by 5 km/h or 5 mph^[1].

Press and hold Continuously adjust your set target speed by 1 km/h or 1 mph by pressing and holding the button.

1. Adjust the set speed value with the  and  buttons on the steering wheel.

> Your new set target speed is shown next to the speedometer.

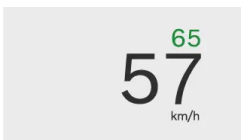

^[1] The target speed will default to speed increments that are divisible by five, such as 25, 30 and 35.

10.4.2.5. Enabling and disabling steering assistance when driving

Pilot Assist's steering assistance can be easily enabled or disabled using the steering wheel buttons. This allows you to control it without going into settings while driving.

Steering assistance is part of Pilot Assist and can only be used when Pilot Assist is active.

If steering assistance is unavailable for some reason, such as due to deteriorated lane markings, you won't be able to activate it. However, by enabling steering assistance, it will automatically activate when the required conditions are met.

Note

Temporary loss of steering assistance

The availability of active steering assistance depends on the conditions you are experiencing. For example, if you encounter a stretch of road with worn out markings, the car may temporarily turn steering assistance off. If this happens you are notified with vibrations in the steering wheel.

1. Press the steering assistance button  on the steering wheel.
 - > Steering assistance is either enabled or disabled.
 - If enabled, steering assistance activates automatically when the required conditions are met.
 - If disabled, Pilot Assist will remain active but mainly provide speed- and distance-keeping.

10.4.2.6. Changing lanes with Pilot Assist

Pilot Assist can provide steering assistance during lane changes in certain conditions. This Pilot Assist feature is called lane change assist.

Pilot Assist automatically provides steering assistance during your lane changes if all conditions are met.

In addition to the general conditions for using Pilot Assist, conditions for assisted lane changes include:

- Both steering assistance and lane change assist are enabled in Pilot Assist's settings.
- Pilot Assist is active.
- The conditions for steering assistance are met.
- The traffic situation allows a lane change.
 - The car checks if the conditions for an assisted lane change are met, such as the adjacent lane being available. However, the responsibility to assess and decide whether a lane change can be done safely ultimately lies with the driver.
 - There are road and driving conditions that do not supply the car with enough information for it to provide steering assistance during a lane change. In such situations, the driver can still perform unassisted lane changes. This disables steering assistance until its conditions are met again.

The primary status of Pilot Assist, including available lane changes, is shown below the gear indicator.



The colour and direction of the arrows are different depending on the situation.

If the driver information area is in surround mode, assisted lane changes are shown as animations.

If the driver information area is in calm mode, lane change status is communicated via symbols instead.



An assisted lane change is available.



A lane change is ongoing. The arrow indicates the direction of the initiated lane change.



Lane change assist is unavailable and any ongoing lane change is cancelled. This can happen if there is a fault affecting critical systems, such as steering assistance. Be attentive to any messages that may follow.

Warning

Lane change assist is a supplement to safe driving practices. It does not reduce or replace the need for the driver to stay attentive and focused on driving safely. Drive the car with the same attention to safety as required by a car without the ability to intervene.

1. Use the direction indicator to initiate the lane change.
- > The car recognises that you want to change lanes. If the necessary conditions are met, the car begins to guide your steering during the lane change.
- The indicators turn off automatically after the lane change is completed.

Note

Keep your hands on the steering wheel

Keep both hands on the steering wheel during the lane change. You are responsible for intervening if necessary. You can override the guidance from the car by braking, accelerating or steering at any time.

Interrupted lane change

The lane change can be interrupted if there is a change in conditions or traffic situation. This is indicated in the driver information area and the manoeuvre is cancelled immediately. Take full control of the car as required.

10.4.2.7. Enabling Pilot Assist in settings

You can enable or disable Pilot Assist in settings. When enabled, it can be activated during driving.

1. Press the car symbol  in the bottom bar and go to **Settings**.
2. Go to **Driving** → **Driver support**.
3. Select **Pilot Assist** as your default driver support function.

10.4.2.8. Adjusting Pilot Assist settings

You can adjust or change which features are enabled for Pilot Assist in settings.

Pilot Assist includes several features, some of which you can enable, disable or customise in settings. This allows you to set Pilot Assist up for the level of support you want.

The customisable settings include:

Steering assist	Guides the steering wheel movement to correctly position the car in the lane.
Lane change assist	Provides steering assistance for lane changes. Available lane changes are indicated by the car but initiated by the driver.
Adapt to speed limit	The set speed is automatically updated if the speed limit changes.
Time interval to vehicle ahead	Adjust the target time interval to the vehicle ahead. This way, you can adjust the distance to vehicles in front of you.

Important

Changing driver support settings

Make sure that you understand how changing the car's settings affects its behaviour. It is particularly important when it comes to features that affect the level of assistance the car can provide.

1. Press the car symbol  in the bottom bar and go to **Settings**.
2. Go to **Driving** → **Driver support**.
3. Customise Pilot Assist settings. Pilot Assist must be selected as your default driver support function for the settings to appear.

10.4.2.9. Pilot Assist conditions and limitations

To use Pilot Assist safely, it's important to be aware of its limitations. While it's an advanced function, there are conditions and situations that it cannot handle.

Driver responsibility when using Pilot Assist

A main limitation of Pilot Assist that you need to be aware of relates to driver responsibility. When using the function, you are still required to actively and attentively drive the car. You are responsible for all decision-making, actions and responses that are part of driving.

Pilot Assist does not know your intentions or the intentions of other drivers. It cannot predict or identify every potentially hazardous situation that an attentive driver can. It's your responsibility to continuously assess Pilot Assist's performance and act if necessary. As long as you judge its input to be correct, you can let it guide your driving.

Important

Driving conditions

Assessing Pilot Assist's performance requires that you take all driving, traffic, weather or road conditions into consideration. For example, if there is poor visibility you may need to increase the distance to vehicles ahead compared to the distance kept by Pilot Assist. The same applies to maintaining a speed that is safe for the current road and traffic conditions.

Improved safety and convenience

When used correctly, Pilot Assist can improve safety and reduce the effort of driving. In some cases, it can compensate for driver errors, such as mistakes caused by lapses of attention or distractions. This potential benefit is a supplement to safe driving practices. It does not reduce or replace the need for the driver to stay attentive and focused on driving safely.

Driver readiness

Using speed- and distance-keeping features can result in long periods of you not using the pedals. However, you must remain prepared and ready to brake or accelerate manually if necessary. Avoid changing your driving posture in ways that can delay your response time.

Hands on the wheel

Pilot Assist can guide your steering but you are still required to keep your hands on the steering wheel, just like when driving unassisted. As long as you judge the steering input to be correct, you can let Pilot Assist guide your steering.

Emergency stop

The car can initiate a controlled stop if the driver doesn't respond to requests to actively drive the car and keep their hands on the steering wheel. During the stopping manoeuvre, the car utilises all of the information it continuously collects about its surroundings to come to a controlled stop in the lane of the road you're on. It also activates the hazard warning lights to warn other drivers.

You can always override the stop manoeuvre by actively steering, braking or accelerating. This indicates that you are attentive again and available to continue the drive.

Speed range for Pilot Assist

Pilot Assist is available at different speeds depending on the context of activation and use.

- You can set target speeds between 30-150 km/h (20-90 mph).
- When following another vehicle, Pilot Assist can stay active below 30 km/h (20 mph).
 - In situations where you are driving slowly behind other vehicles, such as in a traffic queue, you may be able to activate Pilot Assist despite driving slower than 30 km/h (20 mph). This requires a vehicle ahead whose speed your car can match.^[1]

Activation and availability

Several conditions must be met to activate Pilot Assist. They can be related to the current traffic and road conditions or the car's system status. Some are related to the car being driving-ready, such as the driver wearing their seatbelt and all doors being closed. Others relate to your current driving situation, such as driving at a speed within the speed range for Pilot Assist. If activation is prevented, the specific reason is typically communicated in the driver information area.

Keeping track of vehicles ahead

One of Pilot Assist's capabilities is to adapt the car's speed to a vehicle ahead and maintain a certain distance to it. Pilot Assist's behaviour and ability to track traffic ahead depends on several factors, such as your speed and the speed of the vehicle in front.

Very slow or stationary vehicles in front of you can make Pilot Assist behave differently, depending on the situation and your speed:

- If Pilot Assist follows a vehicle that comes to a stop, Pilot Assist slows your car down to a stop behind the other vehicle.
- If a stopped vehicle is detected ahead of you, Pilot Assist will slow your car down in an attempt to stop behind the other vehicle.
 - Depending on your driving speed, the car may not be able to reach a full stop behind the vehicle in front. You are always responsible for keeping track of the surrounding traffic and driving the car in a way that allows you to react and control it safely.
- When driving at high speeds, stationary vehicles in front of you can be misinterpreted by Pilot Assist, such as when catching up to a stationary traffic queue. In a situation like this, Pilot Assist will not consider the stopped cars or slow your car down. Always be attentive and available to control your car and brake when necessary.



Warning

Stopped or slow vehicles ahead

A stopped vehicle in your lane is a collision risk that requires you to act by braking or steering.^[2]

- At low speeds, Pilot Assist may pause when following another vehicle if:
 - there is uncertainty whether what's detected in front is a stopped vehicle or another object^[3].
 - the vehicle ahead makes a turn and leaves your driving path.
 - you manually steer the car out of your current lane.

Car status and systems

Pilot Assist relies on the accurate detection and identification of surrounding traffic and road conditions. This includes using information from cameras, radars and other sensors. The detection system cannot handle all driving, traffic, weather or road conditions. Read the separate manual sections about detection types, how they work and their limitations to better understand how Pilot Assist's performance can be affected.

Several of Pilot Assist's features depend on other systems in the car.

- To adapt the speed to vehicles ahead, the car uses a combination of radar and camera detection. Consequently, conditions and limitations of these systems can affect the availability and performance of this feature.
- When Pilot Assist's set speed is set to adapt to the speed limit, the value is provided by the car's road sign information system. In some conditions, it may not be able to provide an accurate speed limit. This includes situations where the

difference between your current driving speed and the detected speed limit is too large^[4]. In these situations, your car will not adapt your set speed to the speed limit.

- Steering assistance is only available when the car can identify its position on the road through camera detection of lane markings.
 - This requires that the road conforms to certain standards.
 - Conditions and limitations of the car's camera detection can affect the availability and performance of steering assistance.

Important

Car faults

Certain car faults can affect the availability of driver support features. Check the car status view for indicated issues if Pilot Assist is unavailable.

Car alterations

Modifications, repairs and accessory installations can negatively affect or limit driver support features. There is a separate manual section with detailed information on this topic.

Other conditions and limitations

- Pilot Assist is primarily intended for use when driving on level road surfaces. It may have difficulty keeping the correct distance to vehicles ahead on steep downhill slopes.
- Do not use Pilot Assist when driving with a trailer or heavy loads.

^[1] Pilot Assist's lowest target speed is 30 km/h (20 mph), even if your speed at activation is lower than that.

^[2] Your car can still warn you of the collision risk and perform a safety intervention if you fail to react in time. This can happen separately from Pilot Assist's capabilities.

^[3] Such as obstacles designed to encourage slow driving.

^[4] larger than 50 km/h (30 mph)

10.5. Assisted parking

Your car has several features that help you during parking, such as guidance through camera and sensor views. Learn how to use the different types of assistance.

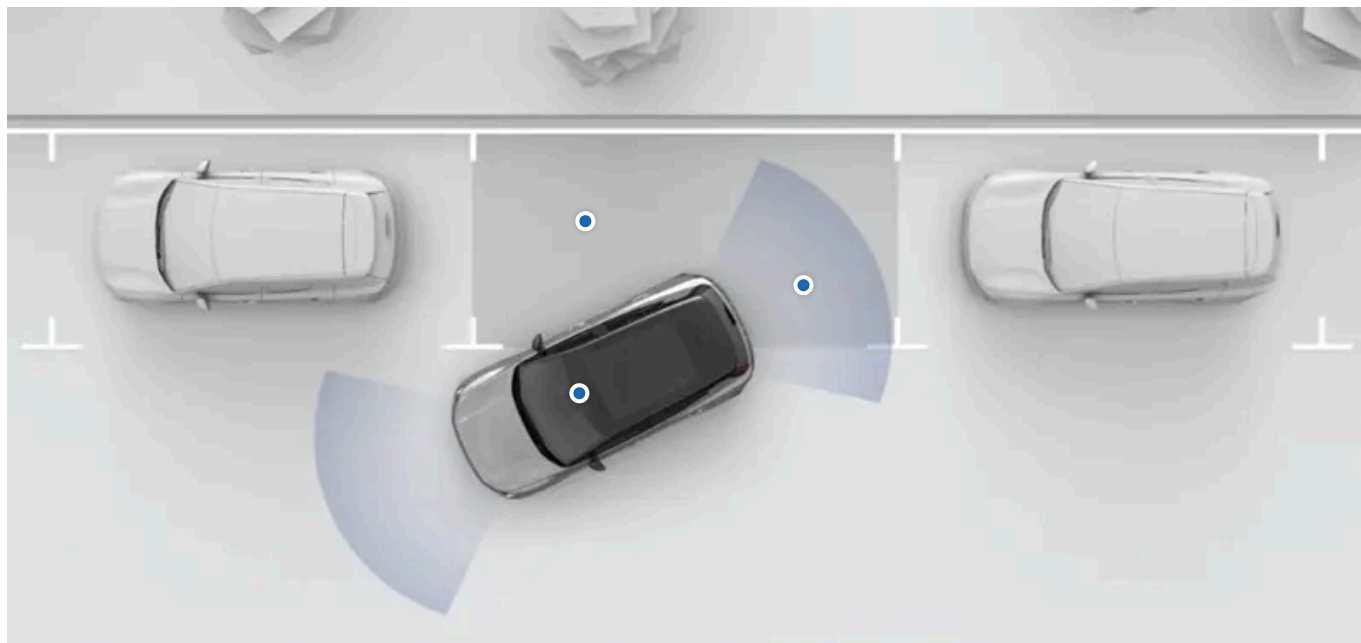

Your car's parking assistance features are available in the display's parking view. In most cases, the parking view opens automatically when you need it, but you can also open it yourself in the display.

The following parking assistance features are available in the parking view:

Distance and obstacle detection	The car senses the surroundings using many different sensors. It uses this information to guide you with sound, graphics and warnings when driving at low speeds.
Parking camera views	The car shows your surroundings using cameras located around the car.
Park Pilot Assist	This feature can actively steer the car in and out of parking spaces.
Rear Auto Brake	The car can automatically brake if an obstacle is detected immediately behind the car while reversing at low speeds.
Rear Cross Traffic Alert	This feature can warn you if the car detects that traffic is about to cross your reversing path.

Important

Required knowledge and driver responsibility

Assisted parking features are designed to make driving more comfortable and safer, but they do not reduce the need or responsibility of the driver to operate the car as safely as possible. Be sure to read all related information about a feature before using it. The section covering driver responsibility is essential reading for understanding the capabilities and limitations of your car's assisted driving features.

If you find anything unclear or have further questions, do not hesitate to contact your Volvo dealer.

Note

Towbar

If you have installed a towbar on your car, some of the parking assistance features might be affected or unavailable.

10.5.1. Parking view

The parking view contains both camera and parking sensor information to help improve your awareness of the car's surroundings. This can be useful when manoeuvring at slow speeds, such as when parking.

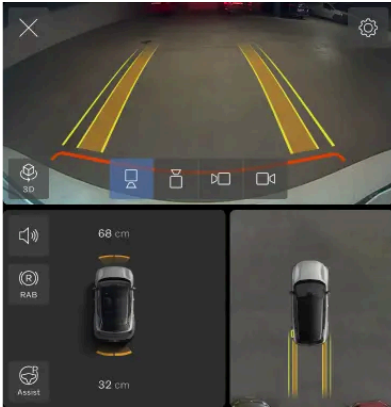

Accessing the parking view

The parking view often appears automatically when you slow down to park but sometimes you need to open it manually. Find the Camera app in the contextual bar to open the parking view.



The parking view closes automatically when you are parked or driving above a certain speed.

Features in the parking view

The parking view contains the following features:

- Multiple camera views
- Front and rear distance and obstacle detection
- Rear Auto Brake, which can provide automatic braking for obstacles while reversing at low speeds
- Alerts about traffic crossing behind your car^[1]
- Park Pilot Assist, which can actively steer the car in and out of parking spaces



Tip

Temporary mute

You can turn the parking support sounds off by pressing the mute button  in the parking view. This lasts for the rest of the drive.

Adjust volume

If you want to change the volume of the parking support sounds, go to sound settings.

Check your selected gear

Availability of certain features can depend on your gear selection.

Camera views

There are several camera views to choose from in the parking view.



3D The car combines front, rear and side camera views to show the car in its surroundings.

3D



Rear A camera at the back of the car provides the rear view.



Front A camera at the very front of the car provides the front view.



Left A camera on the left side of the car provides the left side view.



Right A camera on the right side of the car provides the right side view.

Top view



The top view shows the car from above.

Adjusting the 3D view

You can adjust the 3D view by changing the angle using your fingers. Adjusting the view can make it easier for you to navigate between different angles and get an overview of your car in the parking view.



Tip

You can always recentre the view by pressing the 3D view symbol. This allows you to return to the default 3D view again.

Obstacle and distance detection

The content of this manual represents the status of the user manual at the time of printing and may not be completely valid in future instances. For more information, refer to the first page for the complete disclaimer note.

The parking view can provide visual as well as sound alerts if your car detects any obstacles in your close surroundings.

These alerts escalate the closer you are to a detected obstacle. The colour of the visual indication shifts towards red and the sound intensifies.

 **Important**

Driver responsibility

Obstacle and distance detection is a supplement to safe driving practices. It does not reduce the need or responsibility of the driver to operate the car as safely as possible.

The driver is always responsible for paying attention to the car's surroundings and ensuring that it's safe to manoeuvre the car.

Detection limitations

The car's obstacle and distance detection capabilities have limitations. Read the separate section covering detection of car surroundings and traffic before using features that rely on these capabilities.

[1] RCTA

10.5.2. Park Pilot Assist

Park Pilot Assist can help you manoeuvre in and out of parking spaces.

When active, Park Pilot Assist controls the car with high precision, allowing you to park in parking spaces. It works for both parallel and perpendicular parking, as well as when leaving a parallel parking space. Park Pilot Assist controls steering, acceleration and braking during the manoeuvre.

 **Important**

Read everything

Read all information about the function before using it. It is important to know its proper use and limitations.

Detection of surroundings

Park Pilot Assist relies on the car's ability to detect its surroundings. It primarily uses information from cameras and parking sensors.

Parking in a parking space

You can use Park Pilot Assist during parallel and perpendicular parking. When you activate Park Pilot Assist, it identifies available spaces close to the car and presents them in the display. After selecting a space to park in, supervise the manoeuvre and follow any instructions provided in the display.

Leaving a parking space

You can use Park Pilot Assist to manoeuvre out of a parallel parking space, if you have used Park Pilot Assist to park there. When you activate Park Pilot Assist, the car suggests an exit path. After confirming the path, supervise the manoeuvre and follow any instructions provided in the display.

Warning

Pay attention

When using Park Pilot Assist, you must keep the same level of attention to your surroundings as if parking without assistance. Immediately take full control of the car if necessary.

Driver responsibility

The driver is always responsible for driving safely and in accordance with traffic rules and regulations. Park Pilot Assist is not a substitution for the driver's attention and judgement.

Limitations

Park Pilot Assist cannot handle all traffic, weather and road conditions. Read the separate manual section covering detection of car surroundings and traffic before using features that rely on these capabilities.

Stopping Park Pilot Assist

You can always stop an ongoing manoeuvre. Depending on how you do it, Park Pilot Assist either pauses or ends the manoeuvre.

There are several reasons to stop an ongoing Park Pilot Assist manoeuvre, such as:

- You want to take over and complete the manoeuvre on your own.
- The current placement is good and you don't need it to continue.
- You want it to stop for safety reasons.

You can exit Park Pilot Assist in different ways. For example, you can:

- Press cancel in the display.
- Start steering manually.
- Press the accelerator or brake pedal.
- Change gear.

Conditions and limitations

Certain events and conditions can prevent activation or pause Park Pilot Assist if they occur during the manoeuvre. Examples include:

- An obstacle is detected in the parking path.
- A camera becomes obscured.
- The boot, bonnet or a door is opened.
- The wing mirrors are folded in.

The content of this manual represents the status of the user manual at the time of printing and may not be completely valid in future instances. For more information, refer to the first page for the complete disclaimer note.

- The driver's seatbelt is unbuckled.

Park Pilot Assist can resume the manoeuvre when the condition no longer applies. You can also choose to exit Park Pilot Assist and complete the manoeuvre without using it.

 **Note**

Towbar

If you have a towbar installed, some of the parking assistance features might be affected or unavailable.

10.5.2.1. Parking using Park Pilot Assist

You can activate Park Pilot Assist in the parking view. It's capable of both parallel and perpendicular parking.

The parking view often appears automatically when you slow down to park but sometimes you need to open it manually. Find the **Camera** app in the contextual bar to open the parking view.



 **Important**

Before using Park Pilot Assist

Take the time to read everything about Park Pilot Assist in this manual before using it for the first time. Understanding its capabilities and limitations is important for safe use.

Assess the situation

Make sure the traffic situation and conditions are suitable for activation.

1. In the parking view, press the Park Pilot Assist button.



> The car begins scanning for available parking spaces.

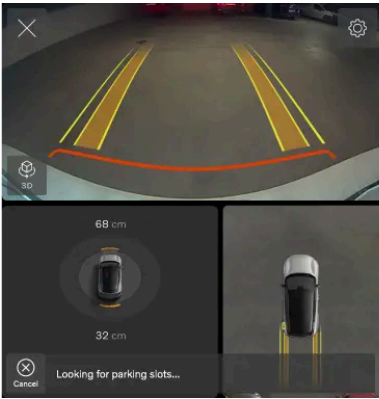

2. Drive slowly to continuously scan for available spaces.

> When the car identifies an available parking space, it's highlighted in the display. The car is capable of identifying several spaces at the same time.

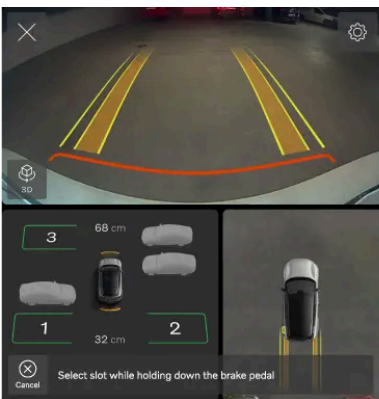

3. Select any of the highlighted spaces to park there.

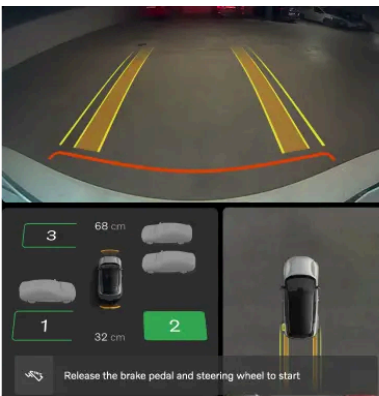

> The car begins the parking manoeuvre. Follow any instructions in the display.

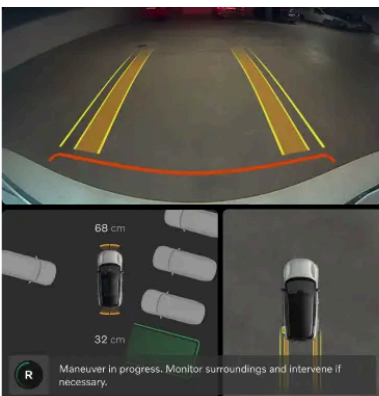

 **Warning**

As long as Park Pilot Assist is active

Pay attention to your surroundings and take control of the car if necessary.

4. The car confirms when it has completed the manoeuvre.

10.5.2.2. Leaving a parking space using Park Pilot Assist

You can activate Park Pilot Assist in the parking view. It's capable of manoeuvring the car out of a parking space when you're parallel parked, if you have used Park Pilot Assist to park there.

The parking view often appears automatically when you slow down to park but sometimes you need to open it manually. Find the **Camera** app in the contextual bar to open the parking view.



 **Important**

Before using Park Pilot Assist

Take the time to read everything about Park Pilot Assist in this manual before using it for the first time. Understanding its capabilities and limitations is important for safe use.

Assess the situation

Make sure the traffic situation and conditions are suitable for activation.

1. In the parking view, press the Park Pilot Assist button.



- > The car begins scanning for an exit path.

When a path is identified, it's highlighted in the display.

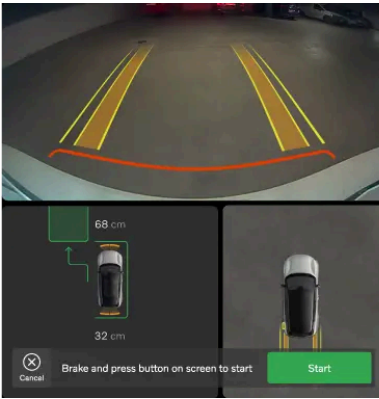

2. To confirm the path and start the manoeuvre, press the **Start** button in the display.

> The car begins the parking manoeuvre. Follow any instructions in the display.



 **Warning**

As long as Park Pilot Assist is active

Pay attention to your surroundings and take control of the car if necessary.

3. The car confirms when it has completed the manoeuvre.

11. Scenarios and driving recommendations

The conditions you're experiencing sometimes affect how you can and should use your car. Knowing its capabilities and how you can adapt to the situation can have a significant impact on the outcome. The benefits range from avoiding outright hazards to getting the most out of your car's performance.



This section of the manual covers specific driving scenarios. These include preparing for a long trip, wading through water and driving on icy roads. Exploring this section gives you a good idea of what features and practices can support you in demanding conditions.

11.1. Cold conditions

Driving in cold conditions can be tricky. It requires different preparations and a different way of driving than a warmer climate does.

When driving in cold conditions, there are many things to take into consideration. From energy consumption and battery health to a comfortable climate and different safety aspects. Be sure to familiarise yourself with what this way of driving entails, as well as which laws and regulations may apply.

Visibility

In cold conditions, ice and condensation can obstruct visibility. Your car is equipped with defrosters, a heated rear windscreen and heated wing mirrors to prevent that from happening.

Range

Your car's battery can be negatively affected by cold temperatures. When the car has a cold battery, a snowflake ❄️ appears next to the battery percentage. This indicates that the battery's charge capacity and range are reduced compared to normal con-

The content of this manual represents the status of the user manual at the time of printing and may not be completely valid in future instances. For more information, refer to the first page for the complete disclaimer note.

ditions. You can avoid this by always charging your car while it's parked, which can prove especially useful if you are parking in a cold climate.

Maintenance

Note

As the temperature drops, the tyre pressure drops. Remember to check the tyre pressure regularly and adjust it as needed.

Important

Cleaning in front of radars

If you find dirt, snow or ice, or if the car indicates that a radar is blocked, you should address it as soon as possible. Always clean and clear a large area around the radars to make their full field of view available.

Parking in cold weather

When the battery is cold, the car temporarily reduces battery performance until it's warmed up. Driving the car in a state of reduced performance doesn't harm the battery.

To avoid temporarily reduced performance from a cold battery, connect the car for charging and activate the car's preconditioning ahead of your trip. The car can then heat the battery without affecting performance and available range.

In temperatures below $-30\text{ }^{\circ}\text{C}$ ($-22\text{ }^{\circ}\text{F}$), avoid leaving the car parked without charging for longer than 24 hours.

11.1.1. Winter driving recommendations

There are some things to keep in mind when driving in snow and on ice. Here are some tips and recommendations for safer driving and improved car system effectiveness.

Preparations for driving in winter conditions

- Cold weather is more demanding for the battery and can lead to temporarily reduced performance. For better battery performance, precondition your car before driving.
- Use washer fluid with antifreeze to avoid ice forming in the washer fluid reservoir.
- Volvo recommends that winter tyres are used when there's a risk of snow or ice.

Note

In some regions, winter tyres are required by law. However, keep in mind that not all countries allow studded tyres.

Recommendations for driving in winter conditions

The content of this manual represents the status of the user manual at the time of printing and may not be completely valid in future instances. For more information, refer to the first page for the complete disclaimer note.

Snowy and icy roads require careful driving different to that of driving on dry roads. There are a number of precautions to take that will help you drive more safely. For example:

- Remove all snow from your car before you start driving, both for your own sake and for your fellow road users. Pay special attention to the sensor areas, lights, roof and bonnet.
- Avoid any sudden steering wheel movements, strong acceleration or hard braking as it can cause the car to lose grip.
- Turn off One pedal drive or use the lowest One pedal drive setting.
- Keep a safe distance from the car in front of you, as you are likely to require a longer braking distance.
- Keep in mind that even if the sun melts the snow and ice, it can still be slippery.
- Even when other roads aren't icy, bridges can still be dangerous.
- Snow and ice can accumulate inside the mudguards, which can affect the steering. Check regularly and remove any snow, ice or debris.
- Braking capabilities can be negatively affected if snow and ice gather in the brake system. Check that the brakes work properly on a regular basis. However, only do so in a safe and careful manner.
- Sometimes, using snow chains can be a good idea. However, be sure to read the instructions on how to use them safely and effectively.

 **Warning**

Avoid parking on inclines during winter conditions. The tyres might lose traction, even if the parking brake is engaged. You are always responsible for safe parking.

 **Tip**

It's a good idea to practise driving on slippery surfaces under controlled conditions to learn how the car reacts. Visit a skidpan if you have access to one.

11.2. Wading recommendations

When driving through water, there are important limitations to consider regarding the water's depth and the driving speed.

 **Important**

Volvo recommends that wading is done with great caution and avoided when possible. It can be difficult to accurately assess the water's depth and the strength of the current. The driver is always responsible for driving in a safe manner and in compliance with all applicable rules of the road.

- If possible, determine how deep the water is before you start driving. Only attempt to drive through if you are confident it's shallow enough to safely wade through.
- The recommended highest water level when wading is up to the bottom of the undercarriage.

The content of this manual represents the status of the user manual at the time of printing and may not be completely valid in future instances. For more information, refer to the first page for the complete disclaimer note.

- Limit your speed to walking pace.
- Avoid wading in strong currents, especially if the water is deep enough to risk flowing over the car.
- Oncoming traffic can cause waves that increase how high the water reaches.
- If possible, avoid stopping when you're in the water. Carefully keep driving forward or reverse out of it.
- Avoid driving through saltwater as it can cause corrosion.

 **Warning**

Wet brakes

The car's stopping distance is longer if the brake discs are wet. Driving through water exposes the brake discs to water, and possibly mud or other sediment. After wading, safely perform a hard braking manoeuvre to remove dirt and water from the brakes. By engaging the brake discs while driving, they heat up and dry.

11.3. Preparations for a long trip

Before you head out for a long road trip, there are a few things that are good to check.

- Make sure that the brakes work as intended.
- Check the tyres' tread depth and pressure. If there is a risk of snowy or icy roads, change to winter tyres.
- Ensure that the wipers are in good shape and change them if needed.
- Top up the washer fluid.
- Charge the car to the battery level you need for the first leg of your trip. It's a good idea to look up available charging stations along your planned route.
- Make sure that useful equipment is in place, such as charging cables, a puncture repair kit, a first aid kit, a warning triangle and a reflective vest.
- If you plan to visit a region that uses different units of measurement, such as miles or kilometres per hour, you can change the car's unit settings.
- If driving to a region with other traffic laws, make sure the car is equipped as required and read up on what rules of the road differ from what you're used to.
- Remote areas may have bad or no internet connection. If you plan to drive in these areas, download the maps you need in the navigation app to be able to use them when your car is offline.

11.4. Long-term parking

Follow the long-term parking recommendations when your car will go unused for longer than one month. Remember to regularly check on the car when it's parked.

Long-term parking preparations

- When leaving your car parked for longer than one month, the recommended battery level is 40-60%. Use or charge the car to reach the recommended level.
- If you are leaving the car parked for longer than three months, it's recommended to keep it plugged in but set the battery charging limit to 50%. This is for better battery health.
- Check and adjust the tyre pressure. The recommended pressure during long-term parking is 330 kPA (48 psi).
- Choose a cool and shaded location. An environment with controlled and consistent conditions is recommended.

During long-term parking

Regularly check:

- The state of charge and that charging is working properly
- The tyre pressure



Tip

Keep the car up to date

During periods when the car goes unused, make a habit of checking for and installing software updates.

After long-term parking

- Before driving the car, make sure all core driving controls and functions work properly, such as the brakes.
- Install any available software updates.

12. Storage, stowing and towing

Your car is designed to transport people as well as luggage and other cargo. Learn about the car's stowing and towing capabilities.



The storage space under the bonnet can be used to store items, such as a puncture repair kit.

Your car's passenger compartment and boot have several areas for stowing items of different shapes and sizes safely. The boot can be expanded to create more space for larger cargo.

You can also use the roof for transporting heavy cargo and, with a towbar, you can attach a trailer.

Warning

It is important to properly store objects, even small items. Objects that are not stowed securely can be dangerous in the event of sudden braking or a collision.

Adding cargo to the car changes the car's weight and driving control properties. Always refer to the car's permitted weight regulations and guidelines.

Before towing a trailer, ensure that all connectors and safety attachments are secured. Also, be sure to follow local regulations regarding towing.

Important

Carrying loads on the roof may interfere with car sensors.

12.1. Passenger compartment storage

The content of this manual represents the status of the user manual at the time of printing and may not be completely valid in future instances. For more information, refer to the first page for the complete disclaimer note.

Find where the storage locations are in the passenger compartment.



- ① Door panel storage compartments.
- ② Pockets on the front seat backs.
- ③ Tunnel console between the two front seats.
- ④ Space under the display.
- ⑤ Glove box.

The tunnel console has several small utility and storage spaces. This includes a retractable cup holder tray.

i Note

Using the cup holder

To access the cup holder, push the lower front section of the centre armrest and let go. The cup holder will slide out fully. The cup holder tray needs to be handled carefully to avoid damaging it. You need to slide it back one cup hole at a time. Do not try to force the tray back in one motion.

12.1.1. Glove box

Store items that you don't immediately need in the glove box.

In the event of sudden braking or a collision, loose items can be hazardous. The glove box is useful for storing small items safely and securely.

The glove box is located in the middle of the dashboard.

Opening the glove box

You can open the glove box via the display. Just press the car symbol in the bottom bar  and go to **Settings** → **Controls** → **More**.

Tip

You can also open the glove box via the **Quick controls** view.

Locking the glove box

You can lock the glove box with a PIN via the display.

Note

If you forget the PIN to unlock the glove box, it can be reset.

12.1.1.1. Locking the glove box

You may want to temporarily lock the glove box for when you are away from your car.

You can lock and unlock the glove box with a PIN code via the display. The PIN will be deactivated after you unlock the glove box. Make sure you create a new PIN whenever you want to lock the glove box again.

1. Press the car symbol  in the bottom bar and go to **Settings**.
2. Go to **Controls** → **Locking** → **Glove box lock**.
3. Press **Lock**.
4. Type in your four-digit PIN.
5. Type the same four-digit PIN again to confirm it.

To unlock the glove box, press the car symbol in the bottom bar , go to **Settings** → **Controls** → **More** and type in your PIN.

Tip

You can also unlock the glove box via the **Quick controls** view.

Forgotten PIN

If you forget the PIN to unlock the glove box, you can reset it via the mobile app for your car. Follow the instructions shown in the app.

12.2. Boot space and storage

The boot can be configured to accommodate cargo of different shapes and sizes.

You can adapt the boot in different ways and expand it to create a larger cargo space. This can be useful for storing larger items.



- ① Parcel shelf.
- ② Foldable rear seats.
- ③ Cargo hold.

Folding down the rear seats is ideal for loading large objects. Install a safety net when doing so to prevent objects moving into the front passenger compartment.

Tip

Adjust boot opening height

You can adjust how much the boot hatch opens. This can be useful when you're parked in places with a low ceiling, such as a garage, and you want to reduce the boot opening height. You can also raise the boot opening height to create more room for accessing the boot.

Stowing cargo securely

You can also find options for stowing cargo securely, such as load-retaining eyelets and bag hooks. These features are useful for ensuring cargo doesn't move around the boot while you are driving.

12.2.1. Parcel shelf

Use the parcel shelf to hide items in the boot from view.

The parcel shelf is attached by two hinges at the back, near the rear seats, and two cords in the front. The cords hook onto attachment points on the boot hatch.

Remove the parcel shelf to create more space or more easily access the rear interior of the car.

Important

- Do not place anything on the parcel shelf. In the case of sudden braking or a collision, loose objects can move abruptly and cause injury.
- Keep in mind that large objects stored in the car can reduce your driving visibility.
- Do not leave the parcel shelf in the car when it is not properly secured.
- When folding the rear seats down, first remove the parcel shelf.
- When placing tall objects in the boot, it's best to remove the parcel shelf. This is because the shelf is attached to the boot hatch and lies flat when the hatch is closed. If a tall object gets in the way of the parcel shelf, it can damage the shelf.

Warning

Child restraints

Take care to keep the parcel shelf and objects in the boot clear from the top tether straps of a child restraint. Contact with the straps can cause damage. Never use the child restraint if the top tethers are damaged in any way. When using a child restraint on the rear seats, remove the parcel shelf or detach it and keep it secure in the cargo area. Furthermore, secure all objects in the boot.

12.2.1.1. Removing the parcel shelf

The parcel shelf can be removed to give you more space in the boot.



There are two attachment points on the parcel shelf itself and two on the boot hatch. When the parcel shelf is attached, cords run between attachment points on the parcel shelf and the boot hatch.

The cords have loops at each end that you hook onto the boot hatch attachment points.



1. Detach each cord from the boot hatch attachment points.
 - > The shelf is loose but lies flat in the same position.
2. Lift the shelf from the hinges at the back, near the rear seats.
3. Carefully move the parcel shelf towards you until it is completely removed from the boot.
4. Store the removed parcel shelf somewhere it won't get damaged or be in the way for other people.

i Note

Keep in mind that large objects stored in the boot can reduce your driving visibility.

12.2.2. Removing the cargo hatch

The content of this manual represents the status of the user manual at the time of printing and may not be completely valid in future instances. For more information, refer to the first page for the complete disclaimer note.

You can make the boot space bigger and access the cargo hold more easily by removing the cargo hatch.

Removing the cargo hatch allows you to enlarge the boot space.

Clear all items from the boot and extend the boot hatch to its full height. This ensures that nothing will get in the way when you remove the cargo hatch.

1. Grasp the hatch handle. It is located in the middle of the cargo hatch, near the outer edge.
2. Pull the hatch up.
 - > The hatch is open and resting on its hinges.
3. Reach into the cargo hold and push the cargo hatch upwards near the hinges.



Illustrative guide for removing the cargo hatch.

- > The cargo hatch lifts out from the hinges.
4. When the cargo hatch is free from the hinges and fully loose, pull it out from the boot.

Place the cargo hatch where it can't get damaged or fall.

12.2.3. Stowing cargo in the boot

The boot has a number of options for stowing items. This can be useful for ensuring cargo doesn't move around the boot while you are driving.

The boot has several features to help stow items. These include:

- Load-retaining eyelets in the lower four corners of the boot for securely fastening objects with straps.
- Bag hooks for preventing shopping bags from falling over. They are located on the side panels.

- Cargo hold under the boot floor for stowing items.



Load-retaining eyelets are located in the four corners of the boot. You can use the load-retaining eyelets to attach straps and secure cargo in the boot.

i Tip

You can find a 12 V socket on the right-hand side of your boot. It can be useful for powering various electrical devices, such as a cool box.

12.2.3.1. Accessing the cargo hold

You can access a storage area under the floor of the boot.

The cargo hatch can be lifted to store and protect fragile items in the cargo hold.

Make sure you can open the cargo hatch by removing any obstructions.

1. Grasp the hatch handle. It is located in the middle of the cargo hatch, near the outer edge.
2. Pull the hatch up.

12.3. Storage under the bonnet

In addition to the boot, there is a storage space under the bonnet.

Examples of items that can be stored in the front cargo area include the car's warning triangle, tool kit, towing eye and puncture repair kit.

12.4. Towing a trailer

A towbar allows you to tow a trailer with your car. Be sure to familiarise yourself with towing features and any relevant safety issues.

Before towing a trailer, consider how this will affect your journey. Make a thorough assessment based on your car's capabilities.

- Keep in mind that the car performs differently with added weight at the rear. This affects both handling and power usage. Expect a notable reduction in range when towing a trailer.
- Only use trailers in good working condition that comply with local regulations.
- Make sure you have read the separate section of the manual covering loading recommendations.

Note

Software features connected to your towbar

Make sure that the towbar is properly installed.

If you've had the towbar installed after purchasing your car, a system update may be needed for the towing features to work. Contact an authorised Volvo workshop to update the software.

Maximum permitted trailer weights

The stated maximum permitted trailer weights are those permitted by Volvo. National vehicle regulations can further limit permitted trailer weights and speeds. Your towbar may be certified for a higher towing weight than the car can actually tow.

Towing preparations

1. Increase the tyre pressure to the recommended pressure for a full load. This applies regardless of the trailer weight.

Driving with a trailer

2. Read the recommendations for driving with a trailer thoroughly before you start driving.

 **Important**

While driving

- Maintain a low speed when driving with a trailer up long, steep ascents.
- Avoid driving with a trailer on inclines of more than 12%.
- The additional load increases the risk of overheating, which will be indicated in the driver information area of the display. Follow any instructions shown.
- Avoid parking on an incline if possible. The extra weight of the trailer can affect the parking brake's ability to securely hold the car. If you cannot avoid parking on an incline, be sure to block the wheels ^[1] as a precaution.

Snaking

Snaking is a phenomenon that can occur when towing a trailer. It causes the car and trailer to resonate in a side-to-side motion, which can escalate quickly and cause loss of control. Snaking primarily occurs at high speeds, especially if the trailer load is too heavy or improperly distributed. The car continually monitors its movement and can intervene to help the driver regain control if it detects snaking.

Factors that introduce sideways motion can trigger snaking. For example:

- Sudden gusts and powerful side winds.
- Uneven road surfaces.
- Sweeping steering wheel movements from side to side.

Trailer stability assistance

The stability control system ^[2] intervenes if it detects snaking when towing a trailer. The system precisely times individual braking actions for the front wheels to mitigate the snaking phenomenon. This is often enough to help the driver stabilise the car and trailer. When the system intervenes to suppress snaking, the electronic stability control symbol flashes in the driver information area.



Electronic stability control symbol

Interventions and warnings when reversing

The car can automatically brake to prevent a collision when reversing if it detects an obstacle or crossing traffic behind the car. Interventions and warnings when reversing are disabled when towing a trailer.

^[1] If you do not have wheel chocks, you can use large stones or wooden blocks instead.

^[2] Electronic Stability Control (ESC)

12.5. Recommendations for loading

Proper loading is important for safety and your car's performance on the road.

Loading in general

Load weight and placement affect the car's centre of gravity, handling and performance.

Warning

Unsecured loads

A loose object weighing 20 kg (44 lbs) can, in a frontal collision at a speed of 50 km/h (30 mph), carry the impact of an object weighing 1,000 kg (2,200 lbs). Always follow the loading recommendations to reduce the risk of material damage or personal injury.

- Place heavy cargo as low as possible.
- Always secure cargo to the load-retaining eyelets with straps or web lashings. Otherwise, it may shift during heavy braking or sharp turns. This is particularly important if the rear seats are folded down.
- Do not stow cargo where it may obstruct airbag deployment. If stacked cargo reaches above the upper edge of the windows, be sure to have at least 10 cm (4 inches) of clear space between the window and the cargo. Otherwise, the intended protection of the inflatable curtain, which is concealed behind the panels above the windows, may be compromised.
- Always comply with the car's specifications regarding weight and maximum permitted load.
- When loading the boot, position the cargo firmly against the rear seats' backrests.
- Avoid placing cargo against the back of the front seats. It may compromise the effectiveness of the front seat whiplash protection.
- Cover any sharp edges, corners and protrusions.
- Make sure that all cargo is secure for the duration of travel. You need to regularly check and re-tighten the straps as cargo can move during transit.
- Remove cargo you no longer need to have in the car. Reducing the car's overall weight improves both performance and range.

Tip

Expand the stowing capabilities

For bulky cargo, expand the cargo area by removing the parcel shelf and folding the seats. You can also make space for long and narrow objects by folding the rear seats down.

Roof loading

Important

Use a load holder recommended by Volvo when carrying loads on the car's roof. This reduces the risk of damage to the car and helps ensure safety while travelling. Carefully follow the mounting instructions supplied with the load holders.

Exterior loads affect the car's aerodynamics, handling and sensitivity to crosswinds. Increased drag affects energy consumption and range.

- Place heavy cargo as low as possible.
 - Distribute the load evenly across the load holders.
 - For long loads that extend over the bonnet, fit the towing eye at the front of the car and use it to secure the load.
 - Drive gently. Avoid heavy acceleration or braking, and sharp cornering.
 - Remove the load holders when you are not using them. It improves both performance and range.
-

13. Care and maintenance

Keep the interior and exterior of your car in good condition with regular care and maintenance.



This section of the manual covers regular care and cleaning you can do yourself, information about some of your car's components that have specific maintenance needs and service maintenance information.

Note

Volvo's service programme

Adhering to your car's service programme is highly recommended. A car in good condition contributes to traffic safety and operational reliability.

13.1. Car status

The car status view in the display is a useful aid for keeping track of your car's health. This is where the car shows you information about any detected issues.

The car status view shows a visual overview of your car and lists any detected issues. The issues are classified depending on severity. A minor issue may be something you can sort out on your own, such as refilling washer fluid. A critical issue may require a workshop visit before you can safely drive the car again. It's recommended to address issues as soon as they appear, especially if they're not minor.

 **Important**

The car is unable to detect and identify all types of issues that can occur. It is therefore important to regularly inspect the car's condition and address any service or maintenance needs you identify. Contact an authorised Volvo workshop for guidance if you are unsure of an issue's severity, regardless of whether it is indicated by the car or not.

To open the car status view, press the car symbol  in the bottom bar and go to **Car status**.

13.1.1. Battery status and health

You can find your car's traction battery status and health in the display.

To open the car status view, press the car symbol  in the bottom bar and go to **Car status** and then **Battery**.

Press the information symbol or downward arrow to find more information for each area:

- Charging power** Current estimation of your car's charging power as well as the battery's preconditioning status. You can press the information symbol for more details on the actual charging power and the actual charging limit. If the car is not plugged in the values will be 0.
- Battery health** Battery state of health is a measure of how much energy can be stored in the battery compared to when it was new. Distance driven since last estimation is also provided.
- Battery temperature** Here you can find information about the battery temperature, which can impact charging speed, range and acceleration.

You will get notifications if functions related to the battery health are affected or if you need to take action somehow.

13.2. Exterior cleaning and care

Keep your car's exterior in good condition by getting rid of dirt and taking care of any paintwork scratches as soon as you notice them. Ensure good visibility by keeping wiper blades in good condition.



Wash your car regularly, top up the washer fluid when needed and replace the wiper blades when they get worn. Taking care of your car's exterior doesn't just make it look nice, it also keeps your car in good condition.

13.2.1. Washing the exterior by hand

To avoid problems cleaning ingrained dirt, wash the car regularly and as soon as it starts getting dirty. It reduces the risk of scratches and, of course, keeps your car looking good.

 **Important**

When and where to clean the exterior

- Clean your car as soon as it has attracted dust or dirt. This prevents the build-up of ingrained dirt, which often contains larger particles and debris that cause wear and damage, especially during cleaning.
- Remove bird droppings and tree sap or resin as soon as possible. These contain substances that can quickly damage and discolour the paintwork.
- Avoid washing your car in direct sunlight. This can cause cleaning agents or wax to dry out and act as abrasives.
- If the car has been exposed to corrosive substances, such as acid rain, salt, chemicals, iron powder, soot or ash, it needs to be cleaned as soon as possible to prevent damage. In areas with a lot of industrial emissions, more frequent washing is recommended.
- Clean the car in a dedicated cleaning area that collects the wastewater and make sure the water is treated according to environmental regulations. Make sure that there is an oil separator in the cleaning area.

High-pressure washing

- Make sure that doors, windows and hatches are closed.
- Use a circular motion and keep the nozzle at least 30 cm (1 foot) from the car's surface.
- Do not spray directly onto openings or sensitive areas such as locks, cameras, trim, air intakes or the charging port.

Do not wash while charging

Do not wash your car if the charging cable is connected.

 **Note**

- Be gentle and use the right cleaning equipment for the type of surface you are washing.
- Only use cleaning agents and car care products recommended by Volvo, and follow each product's accompanying instructions.

Full exterior washing

1. Start by rinsing the underbody, including the wheel housings and bumpers.
2. Rinse the entire car to dissolve and wash away dirt. For particularly dirty surfaces, you can use a cold degreasing agent.
3. Then use a sponge, car shampoo and plenty of lukewarm water to wash the entire car.
4. Dry the car with a clean, soft chamois cloth or a gentle squeegee. This reduces the risk of stains from dried water droplets, which require additional polishing.
5. Remove dirt from the drainage holes in the doors and clean out the door sills after washing the car.
6. If any bitumen stains from the road surface tarmac remain, use a tar remover to get rid of them.

If there are particularly stubborn dirt patches or if you don't get the desired result when cleaning your car, contact Volvo support for advice.

13.2.2. Washing the car in an automatic car wash

Volvo recommends that you wash the car by hand so that you can properly reach all parts of the car. However, an automatic car wash is a simple way to quickly clean your car as soon as it gets dirty.

Note

Volvo recommends that you do not use an automatic car wash during the first few months, when the car is still new. This allows the paintwork to harden properly.

Important

Before using an automatic car wash

Before driving up to the car wash, remember to:

- check that doors and hatches are closed
- disable the rear auto brake in the parking view
- reduce the alarm sensitivity if you won't be inside the car while it's being washed
- secure any auxiliary lights.

Once you're waiting to enter the car wash, activate car wash mode in settings to get your car ready. It will then:

- close all windows
- turn the wipers off
- fold the wing mirrors in
- activate air recirculation.

Remember to perform these steps manually if you are not using car wash mode.

1. Follow the instructions to drive into the automatic car wash and stop at the designated location.

2. If you are using a rollover car wash:

- Put the gear in P to engage the parking brake.

If you are using a tunnel car wash:

- Put the gear in N and take your foot off the brake. Do not apply the parking brake.

 **Important**

In a tunnel car wash, your wheels will need to be able to roll freely throughout the washing process.

3. When the wash is completed, follow the instructions and drive out.
 - > Car wash mode will automatically deactivate when you start driving again.
4. Be sure to reset any functions you changed manually before you drove in.

 **Warning**

Always test the brakes after washing, including the parking brake. This helps prevent moisture from causing corrosion, which could reduce the brakes' performance.

 **Note**

To ensure that all car features are available to you, it is recommended that car wash mode is turned off before you reach a public road.

13.2.2.1. Activating car wash mode

You can get your car ready to go into an automatic car wash by activating car wash mode in the display.

Instead of preparing the car to be washed in an automatic car wash yourself, you can activate car wash mode. It ensures that your car is ready to be washed and that certain capabilities, such as the rain sensor, remain deactivated while you wash the car.

1. Press the car symbol  in the bottom bar and go to **Settings**.
2. Go to **Controls** → **Car modes** → **Car wash mode**.
3. Activate car wash mode.

 **Note**

Car wash mode will deactivate automatically when you start driving again. However, to ensure that all car features are available to you, it's recommended to deactivate car wash mode before you reach a public road.

13.2.3. Polishing and waxing

When your car loses its lustre, it's time for a new coat of polish. This gives the paintwork extra protection.

Feel free to wax your car whenever necessary, but you shouldn't need to polish it during its first year.

Important

Be careful

- Do not use products intended for high-gloss paintwork and do not polish surfaces that have matte paintwork. This may create a permanent gloss on the surface.
- Polishing glossy trim mouldings could wear away or damage the glossy surface layer.
- Avoid using polish or wax on rubber and unpainted plastic components.

Contact a Volvo dealer for information on recommended cleaning agents and car care products.

1. Make sure the car is protected from direct sunlight. The surface should be no more than 45 °C (113 °F) when applying polish or wax.
2. Wash and dry the car thoroughly.
3. First polish the car, then wax it. Follow the instructions on the packaging carefully. Many products contain both polish and wax.

13.2.4. Touching up paintwork damage

Taking care of your car's paintwork helps to maintain the exterior. Inspect it regularly and repair damage straightaway to avoid further problems.

Common damage that may occur includes stone chips, scratches and marks along the edges of doors or bumpers.

Important

Paintwork damage in front of a radar can affect the radar's detection capabilities. Contact a service point for repairs if you find any damage close to the radars.^[1] If you're unsure about where your car's radars are, you can find an overview of their locations in a separate section of this manual.

 **Note**

Paint batches and brands may differ slightly in colour even if the colour code is the same. Therefore, even though fixing these issues can be done on your own, Volvo recommends that you always contact an authorised Volvo workshop to get help with any paintwork damage.

- Contact a Volvo dealer for recommendations on touch-up pens and spray paints.
 - The surface must be clean and dry before doing any touch-ups.
 - The temperature of the surface should be at least 15 °C (59 °F).
 - Follow the instructions for the touch-up pen or paint you're using.
1. Apply masking tape over the damaged area. Then peel it off to remove all loose paint.
 2. If there are uneven edges, you may need to gently polish around the damaged area using a very fine abrasive cloth. Clean the area thoroughly afterwards and let it dry.
 3. If the damage:
 - has not reached the metal and an undamaged layer of paint remains, you can apply touch-up paint directly to the cleaned surface.
 - has reached the metal, first use a primer.
 - is on a plastic surface, first use an adhesive primer for better results. Spray into the lid of the spray can and brush on a thin layer.
 - is a long scratch, use masking tape around the damaged area to protect the undamaged paintwork.
 4. Stir the primer thoroughly and apply with a fine brush, matchstick or something similar. Let it dry.
 5. Finish with a basecoat and clearcoat.

^[1] Volvo recommends an authorised Volvo workshop for all servicing and repairs.

13.2.4.1. Finding the paint colour code

You can find the car body paint colour code on the product label located on a pillar between the front and rear doors.

If there is damage to your car's paintwork, or it needs repairing or repainting, you need to know the exact colour of the paint.

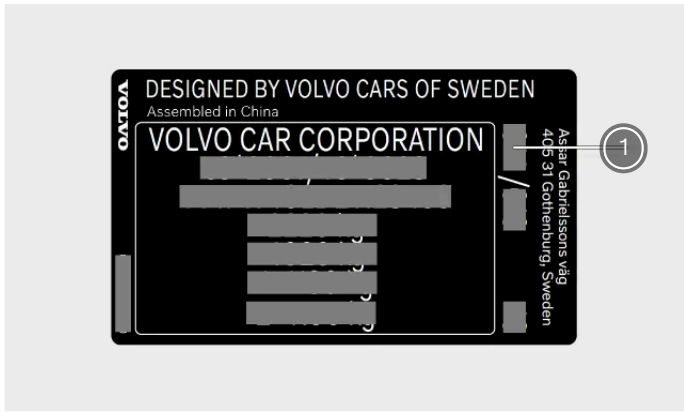

① Paint colour code

1. Go to the right-hand side of the car.
 2. Open the front and rear doors.
 3. Find the door pillar located between the front and rear doors.
- > The product label containing the colour code is located on the outer side of the door pillar, near the bottom of it.



13.2.5. Windscreen damage

It's important to repair a damaged windscreen as soon as possible. If you take immediate action, minor chips and cracks can often be repaired without replacing the entire windscreen.

Small cracks or chips

Small windscreen cracks or chips can quickly spread, turning it from minor to severe damage. Contact an authorised Volvo workshop if you notice glass damage. Repair the windscreen as soon as possible.

 **Important**

Camera and sensor area

Any windscreen damage in the camera and sensor area, including small chips, scratches or cracks, can negatively affect forward detection and features that use it.

- Any windscreen damage in this area requires inspection by a service technician.
- Volvo recommends not repairing small damage in the camera and sensor area. Instead, the entire windscreen should be replaced.

Severe glass damage

If the windscreen suffers severe damage, the entire glass panel needs to be replaced.

 **Warning**

Compromised safety

Do not drive the car if there is structural damage to the windscreen. Weakened glass can degrade very quickly, impair visibility and seriously compromise safety.

 **Note**

Compatibility of new windscreen

It's important that the new windscreen and its installation meet Volvo's specifications for safety and compatibility with the car's features.

Calibration

When a windscreen is installed, the forward-facing camera behind the glass requires function checks and calibration by a service technician to ensure that it works correctly.

13.2.6. Refilling washer fluid

The washer fluid reservoir cap is located under the bonnet. Be sure to use good quality washer fluid.

The car notifies you when the washer fluid level is getting low.^[1]

 **Note**

Reservoir capacity

Your car can hold 3.5 litres (approximately 3.7 US quarts) of washer fluid.

 **Important**

Washer fluid quality

- Use washer fluid with a pH between 6 and 8.
- If you use concentrated washer fluid, dilute it as instructed on the packaging and use clean pH-neutral water.
- Volvo recommends washer fluid with frost protection in cold conditions, especially in temperatures below freezing. This is to prevent damage caused by the fluid freezing inside the pump, reservoir and hoses.

1. Open your car's bonnet.



Locate the blue cap with the washer fluid symbol and open it.

3. Pour the washer fluid into the reservoir. Avoid spillage if possible.

4. Close the cap and bonnet.

^[1] When there is about 1 litre (1 quart) left.

13.2.7. Cleaning wipers

Dirt, dust, sand, insects and different weather conditions are just a few of the things your wipers take care of. It's important to clean your wipers regularly to maintain good visibility and prolong the blades' service life.

1. To access the front wiper blades, activate the wiper service position. This is available in the car's settings.
2. Rinse the area with water to get rid of any loose dust and dirt.
3. Use a soft sponge with a lukewarm soap solution or car shampoo to clean the area. Lift the wiper arms from the windscreen for better access.

4. Use a clean, soft cloth to dry the wipers.
5. Make sure the wiper arms are folded back down against the windscreen and then deactivate the wiper service position.

! Important

Test the wipers before driving. Use plenty of washer fluid when the wipers are in motion. The windscreen must be wet for the wipers to work properly.

13.2.8. Replacing front wiper blades

Your front wiper blades' service life is affected by the water, dirt and debris that they sweep off your windscreen. The wiper blades need to be replaced when they show signs of wear.

1. Activate the wiper service position via settings in the display.

2.

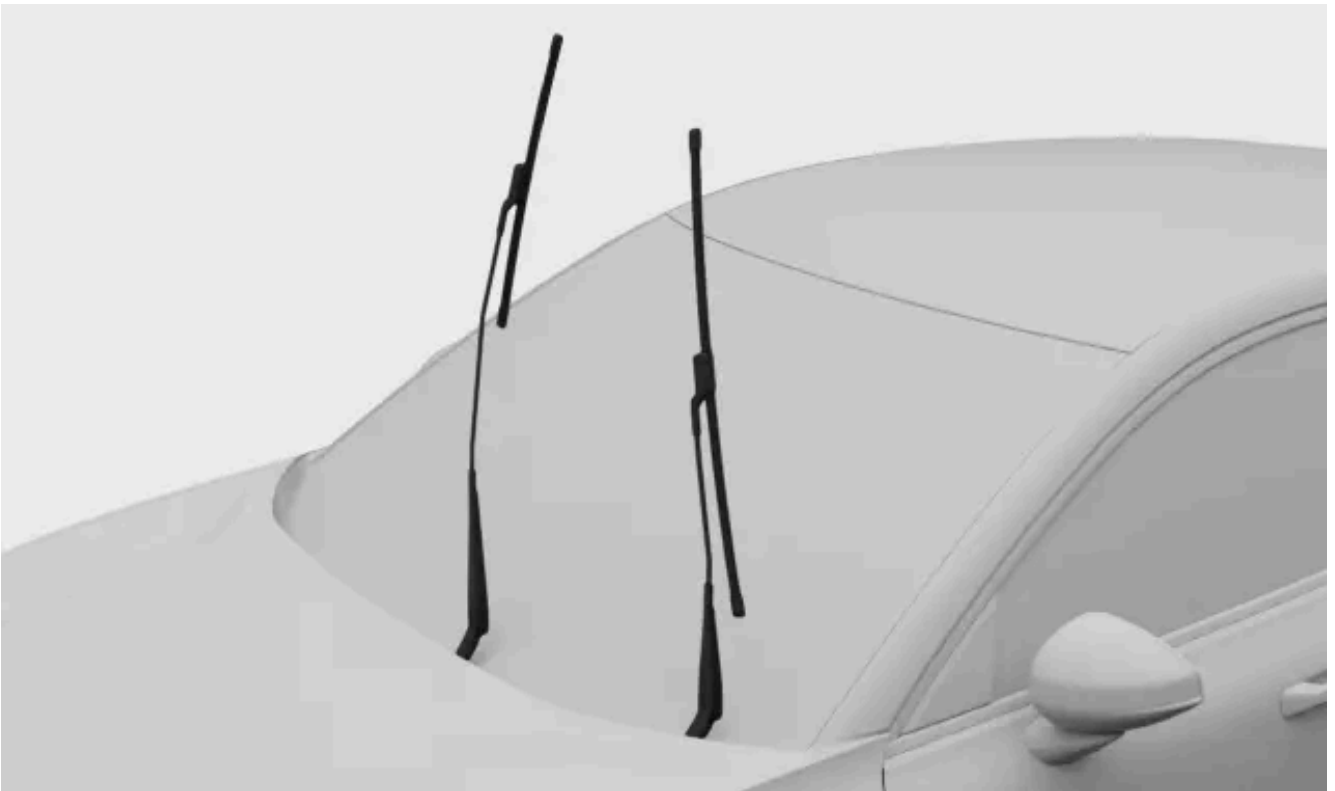

Fold the wipers up and away from the windscreen.

3.

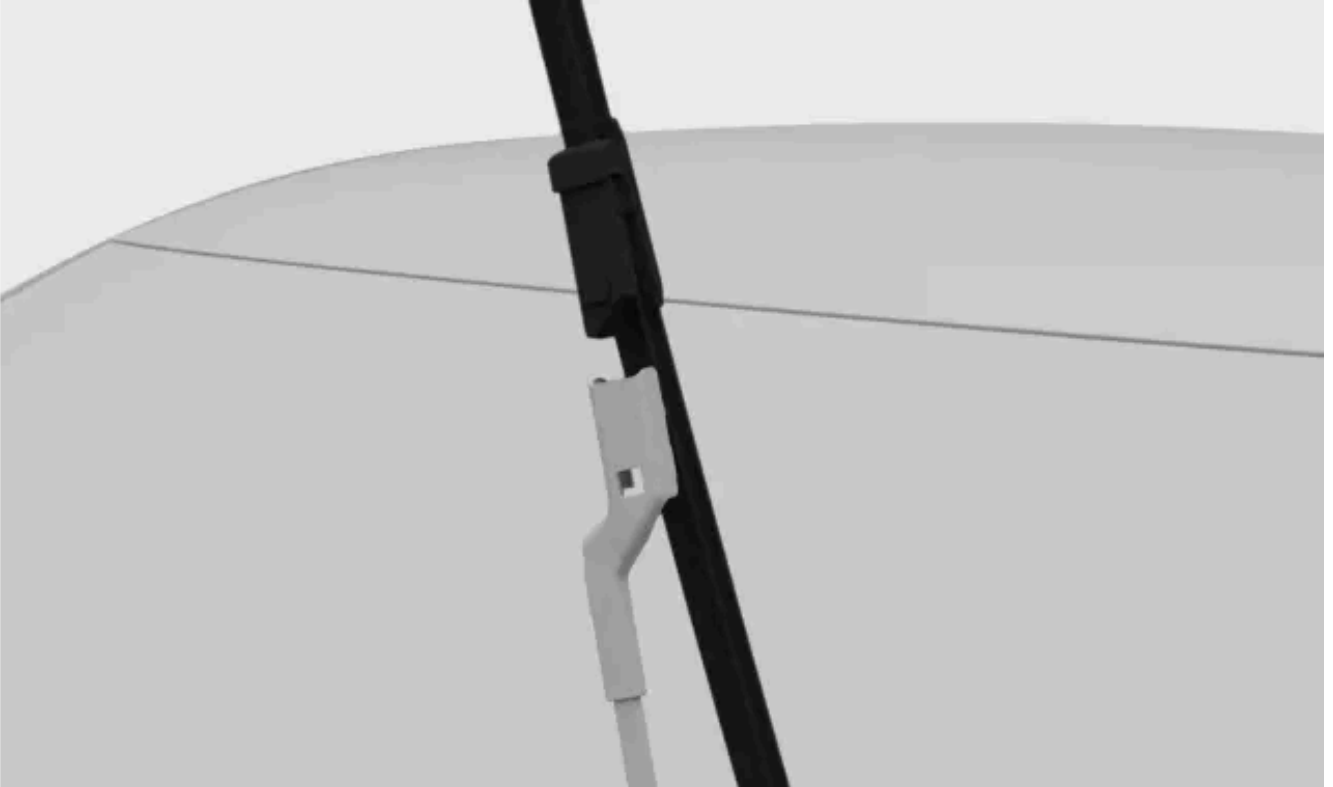

Press the button on the wiper arm and pull the blade straight out so that it's parallel with the wiper arm.

4.

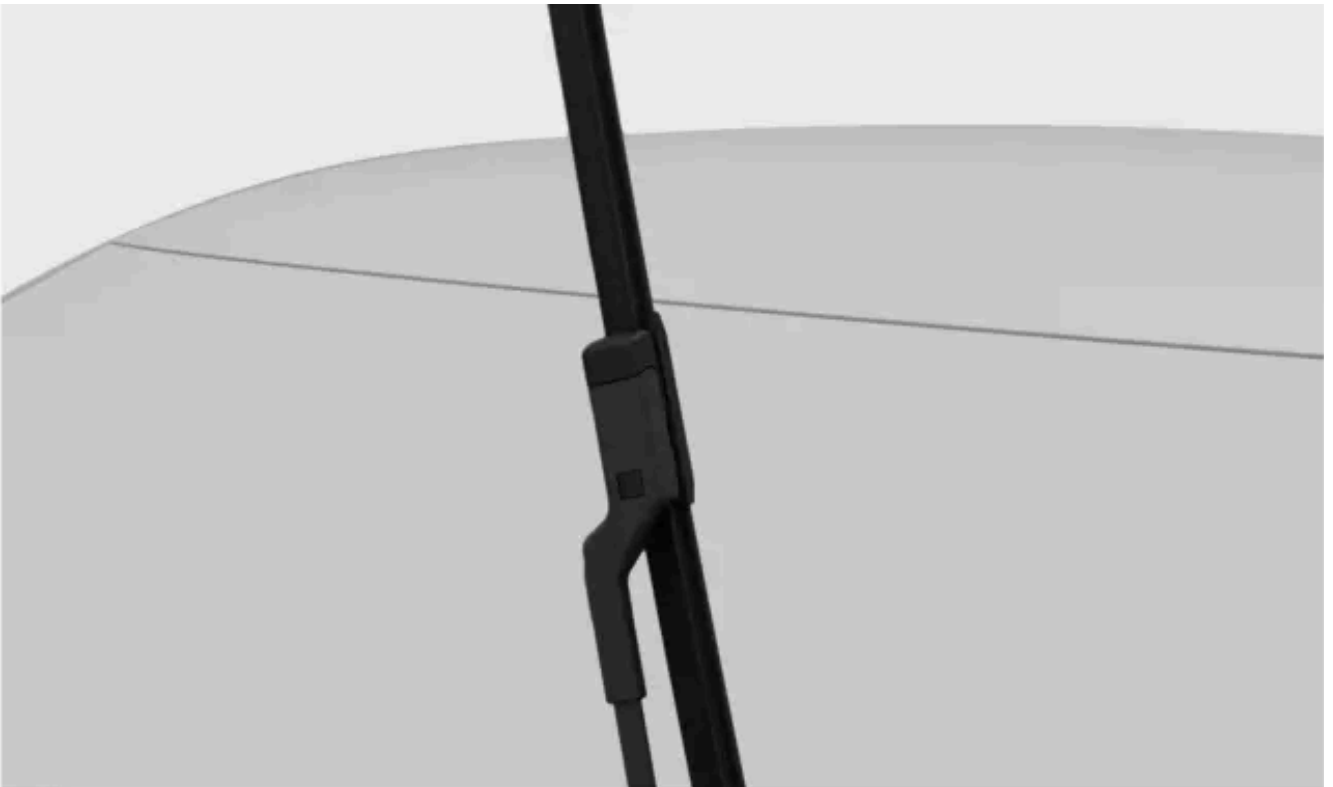

Make sure that the blade for the driver side is longer than the blade for the passenger side. Slide the new blade into the wiper arm until you hear it click into place.

5. Check that the blade is firmly attached.
6. Fold the wiper arms back down against the windscreen.
7. Deactivate the wiper service position.

13.2.9. Replacing the rear wiper blade

Your rear wiper blade's service life is affected by the water, dirt and debris that it sweeps off your rear windscreen. The wiper blade needs to be replaced when it shows signs of wear.

1.



Grasp the centre of the wiper arm and lift it up and away from the rear windscreen. You may feel some resistance halfway – this is the lock position. You need to pull the wiper arm past the lock position so that it doesn't fall back onto the windscreen.

2.

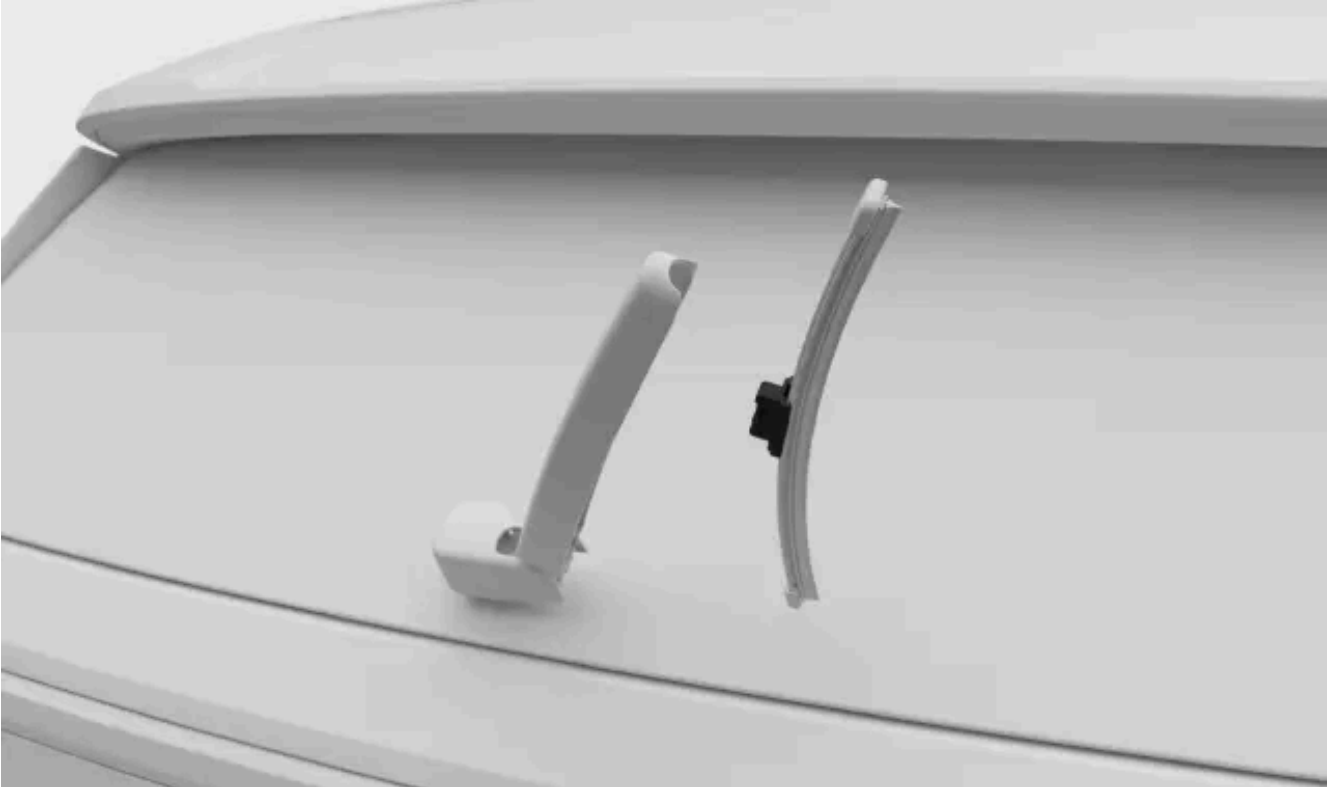

Put your thumbs on top of the wiper blade, underneath the wiper arm, and push down on the blade until it loosens and comes away from the wiper arm.

3.

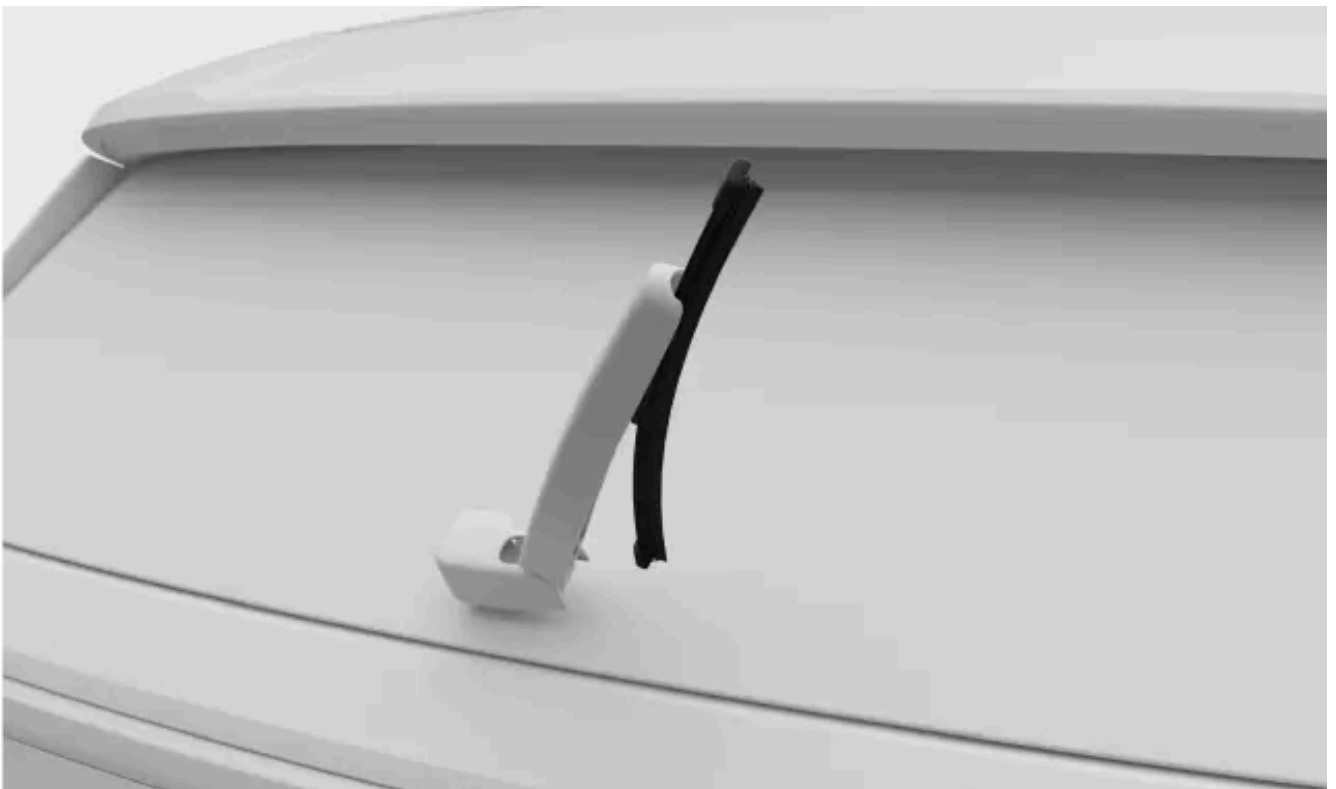

Press the new blade into place until you hear a click.

4. Check that the blade is firmly attached to the wiper arm.

5. Fold the arm back down against the windscreen.

13.2.10. Activating the wiper service position

The wiper service position allows you to clean or replace the front wiper blades. When activated, the wipers move to a more accessible position on the windscreen.

1. Press the car symbol  in the bottom bar and go to **Settings**.
 2. Go to **Controls** → **Mirrors and wipers** → **Wipers** → **Wiper service position**.
 3. Activate the service position.
- > The wipers move to a more accessible position and can be lifted up from the windscreen for servicing.

Important

Fold the wipers down

Be sure to fold the wipers back down against the windscreen after servicing them. Activation of the wipers when they are in an elevated position can damage the car.

Once you have folded the wipers back down, deactivate the service position. This can be done by either of these options:

- The setting in the display.
- Start driving.
- Start using the wipers or washers.

13.2.11. Corrosion protection

A good way to reduce the risk of corrosion is to keep your car clean. Your car also has durable corrosion protection.

Normally, the corrosion protection doesn't require maintenance apart from regular cleaning and washing, which removes corrosive substances. Avoid using strong alkaline or acidic cleaning solutions on glossy trim components as they can cause corrosion. Road surfaces with gravel or small stones can lead to paint chips that can act as entry points for corrosion. Deal with such damage as soon as you notice it.

The car body's corrosion and abrasion protection consists of:

- protective coatings, both on the sheet metal and applied in a high-quality painting process
- shielding with plastic components
- corrosion-resistant cast aluminium used for exposed components of the wheel suspension.

13.3. Interior cleaning and care

Keep the interior of your car in good condition by taking care of its materials and keeping them clean.



Use the passenger compartment's storage areas and the cup holders to keep your car tidy. Always take care of stains and dirt as soon as you notice them to avoid permanent staining.

If there are particularly stubborn dirt patches, or if you don't get the desired result when cleaning your car, contact Volvo support for advice.

13.3.1. Cleaning fabrics and textiles

If you get a stain on the car's interior, such as on the headlining or seat upholstery, clean it as soon as possible.

These recommendations apply to various interior fabrics.

 **Important**

When cleaning upholstery

- Never scrape or rub dirty surfaces. Instead, use gentle circular motions. Remember that sharp objects or abrasive materials can damage the car.
- Always clean the entire upholstery. Cleaning only spots on the upholstery can leave water rings or other marks.
- Do not remove surface upholstery during cleaning.
- Certain clothes, such as jeans or suede, can discolour the textile upholstery.
- Be careful when cleaning the headliner as harsh treatment may damage it.
- Only use cleaning agents and car care products recommended for cleaning textiles, and follow each product's accompanying instructions.

 **Warning**

Seats with side airbags

Never spray a cleaning agent directly on the sides of seats with side airbags. Instead, wipe them clean with a cloth lightly dampened with a suitable cleaning agent.

1. Vacuum clean or dust off the area to remove loose dust and dirt.
2. Clean the area with a neutral-coloured, clean and lint-free microfibre cloth that is lightly dampened with water or a colourless, mild cleaning agent. Use gentle circular motions.

 **Tip**

To wash the textile upholstery, an upholstery cleaning machine is recommended for extracting the cleaning solution and performing a water rinse.

3. Let the material dry fully before use.

 **Important**

Cleaning seatbelts

When cleaning a seatbelt, keep it extended until fully dry.

13.3.2. Cleaning glass and glossy surfaces

Clean surfaces such as the display, mirrors and touch buttons regularly and gently.

The content of this manual represents the status of the user manual at the time of printing and may not be completely valid in future instances. For more information, refer to the first page for the complete disclaimer note.

 **Important**

- Before you clean the display, remember to activate the display cleaning mode.
- Do not scrape or use any abrasive cleaning agent on mirrors, touch buttons and the display's surface. This can damage the reflective surface.

1. Vacuum clean or dust off the area to remove loose dust and dirt.
2. Use a clean microfibre cloth lightly dampened with water and clean the area with gentle circular motions.
3. Let the surface dry fully before use.

13.3.2.1. Activating display cleaning mode

Before you clean the display, you need to activate the display cleaning mode.

1. Press the car symbol  in the bottom bar and go to **Settings**.
2. Go to **Controls** → **Lights and displays** → **Display** → **Clean screen**.
3. Press to activate.

13.3.3. Cleaning interior plastic and metal components

Clean panels and controls regularly, and deal with stains straightaway.

 **Important**

Be gentle

Never scrape or rub dirty surfaces. Instead, use gentle circular motions. Remember that sharp objects or abrasive materials can damage the car.

1. Vacuum or dust the area to remove loose dust and dirt.
2. Use a clean microfibre cloth lightly dampened with water and clean the area with gentle circular motions.

The content of this manual represents the status of the user manual at the time of printing and may not be completely valid in future instances. For more information, refer to the first page for the complete disclaimer note.

 **Important**

Never spray fluids directly on electrical components, such as buttons or controls.

3. Let the material dry fully before use.

13.3.4. Cleaning mats

Clean the mats regularly and always make sure they are properly in place.

 **Important**

Be gentle

Never scrape or rub dirty surfaces. Instead, use gentle circular motions. Remember that sharp objects or abrasive materials can damage the car.

1. Remove the mats for separate cleaning and access to the floor. Grasp the mat by the fastening pins and lift straight up.
2. Vacuum the mats and floor to remove loose dust and dirt. Do not shake or beat the mats to remove dust and dirt as they can crack.
3. Clean the area with a neutral-coloured, clean microfibre cloth that is lightly dampened with water or a colourless, mild cleaning agent. Use gentle circular motions.
4. Let the mat dry fully before putting it back. Fix it into place by pressing down near each pin.

 **Warning**

Only use one mat for each seat and make sure they are properly fastened using all pins. If the driver's mat is not properly attached, it can move around and endanger your driving by getting caught near or under the driver pedals.

13.4. Wheels and tyres

The tyres' purpose is to carry your car's load, grip the underlying surface well, reduce vibration and protect the wheel rim from wear. Get familiar with the recommendations to get the most out of your wheels and tyres.



Familiarise yourself with tasks such as how to maintain a correct tyre pressure and how to change wheels so you are comfortable in these situations.

13.4.1. Wheel and tyre recommendations

Volvo recommends that you only use wheel rims and tyres that have been tested and approved by Volvo and are genuine Volvo accessories. A complete wheel refers to when tyres are fitted onto wheel rims.

Recommended tyres

On delivery, the car is equipped with Volvo original tyres that have the VOL marking on their sides^[1]. These tyres are carefully adapted to the car. It is therefore important that if you change tyres, the new tyres also have this marking in order to maintain the car's driving characteristics, comfort and electricity consumption.

Original tyres

Your car is originally equipped with tyres according to the label found on the pillar by the driver door.

The tyres have good roadholding properties and provide good driving characteristics on dry and wet road surfaces. Remember, however, that the tyres have been developed to provide these properties on roads that are free from ice and snow.

Some cars are equipped with a combination of tyres and wheel rims with extra-high performance. They are designed to be capable on dry road surfaces and with resistance against aquaplaning. These may be more sensitive to damage on the road surface and, depending on conditions, may have a service life of less than 30,000 km (20,000 miles). Even if the car is equipped with AWD or stability systems, these tyres are not designed for winter driving and should be changed to winter tyres as the weather requires.

"All-season" tyres provide slightly better roadholding on slippery road surfaces than tyres without the "all-season" classification. However, for good roadholding on icy or snow-covered roads, Volvo recommends winter tyres on all four wheels.

Tyre age

The content of this manual represents the status of the user manual at the time of printing and may not be completely valid in future instances. For more information, refer to the first page for the complete disclaimer note.

Volvo recommends that tyres should be changed after 6 years of normal use. Tyres age and deteriorate over time, even if they are rarely or never used. The function can therefore be affected. This applies to all tyres that are stored for future use. Heat caused by hot climates, frequently carrying heavy loads or exposure to ultraviolet (UV) radiation may accelerate the ageing process. Cracks or discolouration are examples of external signs which indicate that the tyre is unsuitable for use. A tyre that has visible signs of deterioration should be changed immediately.

When you replace your tyres, it is important to use the newest tyres possible. This is especially important with regard to winter tyres. Use the tyres' DOT^[2] markings to determine how old your tyres are.

Replacing tyres

When you replace your tyres, you must make sure that all four tyres have the same size designation, are of the same type (radial), and are preferably from the same manufacturer as the original tyres. Otherwise, there is a risk of changing the car's road-holding properties and driving characteristics.

If the wheels are fitted incorrectly, the car's braking characteristics and capacity to deflect rain and slush are adversely affected.

Wheel rims and tyre sizes

Warning

- Your Volvo's wheel rim and tyre sizes are specified to meet stringent requirements for stability and driving characteristics. Unapproved combinations of wheel rim size and tyre size may have a negative effect on the car's stability and driving characteristics.
- Any damage caused by the fitting of unapproved combinations of wheel rim size and tyre size are not covered by the new car warranty. Volvo accepts no liability for death, personal injury or any costs caused by such installations.
- Do not use steel or aluminium wheel rims which are damaged, cracked or deformed, which have extensive corrosion damage, or which have been welded or repaired.

^[1] There may be deviations for certain tyre dimensions.

^[2] Department of Transportation

13.4.1.1. Tyres and wheel storage

To keep them in good condition, you should always store wheels that are not in use in a cool, dry and dark place. How you place them, as well as avoiding exposure to chemicals, is also important.

When you store wheels that are not in use, it's important to keep them from direct sunlight, rain, water, heat sources or sparks. They should never be stored near solvents, petrol, oils or similar substances. Especially flammable ones.

Store wheels^[1] hung up or lying on their sides on the floor. If you store tyres not fitted on rims, you should never hang them up. Be sure to store them standing upright or lying on their sides. If you hang up rimless tyres they may become deformed.

^[1] Tyres fitted on rims

13.4.1.2. Tyre economy

To preserve your tyres as much as possible, there are some things you should keep in mind.

- Correct tyre pressure reduces uneven wear. It's important to check the pressure regularly.
- Hard acceleration, heavy braking and driving in a way which causes screeching tyres lead to increased tyre wear.
- Tyre wear increases with speed.
- Unbalanced wheels cause uneven and excessive tyre wear and reduced ride comfort.
- Wheels must have the same direction of rotation during their entire service life.
- The rear tyre grip should always be equal to, or better than, the front tyre grip to reduce the risk of oversteering in case of heavy braking.
- Tyres or wheel rims may be damaged permanently if you hit kerb stones or drive into deep holes.
- Driving style, road conditions and climate affect the tyre wear.

13.4.2. Designations on tyre sidewall

There are many digits, numbers and symbols that may be found on a tyre's sidewall. Here are some examples and explanations of what they indicate.

Note

Be aware that the following tyre designations are only examples. Not all of these designations may be available for your tyres and there may be designations on your tyres which are not included here.

Tyre dimensions

All tyres have a designation of dimensions, such as: 265/40 R21 98 W

- 265** Tyre width (mm).
- 40** Ratio between tyre wall height and tyre width (%).
- R** Radial ply. The designation RF and symbol specify that the car is equipped with puncture-resistant tyres.
- 21** Rim diameter (inches).
- 98** Codes for the maximum permitted tyre load, Load Index.
- W** Speed rating for maximum permitted speed, Speed Symbol.

Wheel rim dimensions

All wheel rims have a designation of dimensions, such as: 8J x 19 x 50

- 8** Rim width (inches).
- J** Rim flange profile.
- 19** Rim diameter (inches).

Weather condition classification

Here are some classification examples. Weather capabilities can also be defined with certain symbols.

M+S or M/S Mud and Snow.

AT All Terrain.

AS All Season.

Tyre age

DOT YLX2 0819 Tyre Identification Number or TIN. This information helps the tyre manufacturer identify tyres in the event of safety recalls.

1. DOT^[1]
2. The first two characters are the code for the plant where the tyre was manufactured.
3. The next two characters are the tyre's size code.
4. The last four digits specify the week and year the tyre was manufactured. For example, 0819 means that the tyre was manufactured during week 08, year 2019.

Any numbers or letters shown in between are market codes chosen by the manufacturer.

Max load and pressure

Max load 685 kg (1610 lbs) Specifies the maximum load that the tyre can carry.

Max pressure 240 kPa (35 psi) The maximum tyre pressure that the tyre should ever be subjected to. This limit is specified by the tyre manufacturer.

Minimum permitted load index and speed rating



Warning

The minimum permitted load index (LI) and speed rating (SS) for the tyres for each respective motor variant are shown in the specifications sections. If a tyre with too low a load index or speed rating is used, it may overheat and become damaged.

Type, materials and tyre rotation

P	Indicates that the tyre is for passenger vehicles.
VOL	Volvo original tyres.
Plyes: Tread 2 polyester, 2 steel, 1 polyamide. Sidewall 2 polyester.	States the number of cord layers or number of layers with rubber-coated fabric in the tyre's tread and sidewall. The tyre manufacturers must also state the layer materials used in the tyre and sidewall, which may be steel, nylon, polyester and certain other materials.
Arrow symbol	Tyres with a tread pattern designed to only turn in one direction have the direction of rotation marked with an arrow.

Classification of uniform tyre quality

Treadwear grade 200	The treadwear grade is a comparative rating based on the wear-rate of the tyre in a standardised test. A higher value is better.
Traction grade AA	The traction grade is based on standardised straight-ahead braking traction tests. The traction grades, from highest to lowest, are AA, A, B and C.
Temperature grade A	The temperature grade reflects the thermal performance of a tyre that is properly inflated and not overloaded. The temperature grades, from highest to lowest, are A, B and C.

^[1] Department of Transportation

13.4.2.1. Tyre tread wear indicators

There are tread wear indicators to show the status of the tyre's tread depth.

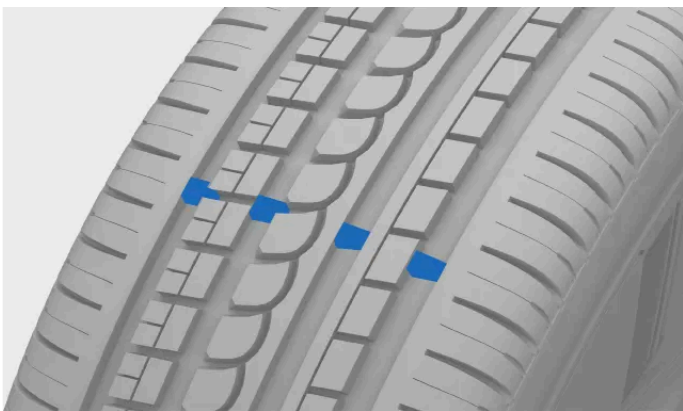

The narrow grooves that run lengthways across the tyre's tread pattern are tread wear indicators. On the side of the tyre are the letters TWI ^[1].

! Important

- Tyres should be changed before wearing them down to the tread wear indicators to avoid poor traction in rain and snow.
- Volvo recommends that winter tyres have a greater tread depth than 3 millimetres (1/8 inch) and summer tyres 1.6 millimetres (1/16 inch).

^[1] Tread Wear Indicator

13.4.3. Changing wheels

If you need to change a wheel, it's important to follow the recommended procedure.

 **Warning**

Raising the car to change a wheel

Changing a wheel requires that you raise the wheel off the ground. Carefully follow the separate instructions for raising the car safely.

- If you are changing the wheel in or close to traffic, make sure you and the car are clearly visible to others. Activate the hazard warning lights and put out a warning triangle in a visible but safe place.
- Designate a safe space for passengers to wait, away from both the car and traffic.
- You are responsible for safety around the car while it is raised. Do not allow people inside or close to the car.
- Never get under the car, or let anyone reach under it with any part of their body, while it is raised with a jack.

Before removing the wheel

The wheels on your car are fastened with wheel bolts. For extra security, you can use lockable bolts.

 **Important**

- Make sure that the dimensions of the replacement wheel are approved for your car.^[1]
- Make sure you read through all the instructions before you start. Get all the tools you need before the car is raised.^[2]

Removing the wheel

1. Remove the wheel fastener cap.
2. While your car is still on the ground, use the wheel wrench to loosen the wheel fasteners approximately 0.5-1 turn. Press the wrench downwards while the wrench is extended to the left to avoid personal injury. The anticlockwise rotation loosens the fastener. If you have fasteners that are lockable bolts, start with them.
3. Follow the instructions on how to safely raise the car.
4. Raise the car high enough so that the wheel you want to remove is off the ground. Remove the fasteners and lift off the wheel.

 **Tip**

When switching wheels between winter and summer, mark which side they were mounted on, for example L for left and R for right.

Mounting the wheel

5. Clean the surfaces between the wheel and hub.
6. Mount the wheel. Make sure you tighten the fasteners. However, the final tightening to the specified torque is done when the wheel is back on the ground and unable to rotate while you do it.

 **Warning**

- Make sure that you put the wheels on the correct axle. Incorrectly mounted wheels can affect the car's handling.
- Never use lubricant on the threads of wheel fasteners. It could cause the wheel fasteners to loosen after tightening.

7. Lower the car back to the ground.

> When on the ground, the wheel can't rotate, making final tightening easier.

8. Fasten the fasteners crosswise. If the car is equipped with lockable bolts, finish with those. It's very important that the fasteners are properly secured. Tighten to 140 Nm (103 lb-ft). Check the tightening torque with a torque wrench. Overtightened or loosely tightened fasteners may damage the fastening threads or the wheel itself.



Tighten the wheel fasteners crosswise.

9. Place the wheel fastener cover back over the fasteners, using the guide markers to position it correctly, then press it into place. Ensure that it's securely fastened.

 **Warning**

Check the wheel fasteners

The wheel fasteners may need to be re-tightened a few days after the wheel has been changed. Temperature differences and vibrations may cause them to loosen.

Wheel properties after a wheel change

Be attentive to signs of incorrectly fitted wheels. This could affect the car's braking characteristics and the ability to deflect rain and slush.

When you have changed the type or size of the wheels, you should drive carefully at first. The dynamics and driving characteristics of the wheels may have changed.

[1] Some spare wheels have different dimensions. If your car is approved for the spare wheel you intend to use, the difference in dimensions is okay.

[2] Use tools that are designed for your car model.

13.4.3.1. Spare wheel

If you get a punctured tyre, a spare wheel^[1] can be temporarily used until the original wheel can be replaced or repaired.

The spare wheel is only designed for temporary use. You should replace the spare wheel with an ordinary wheel as soon as possible.

When not in use, you should store the spare wheel in a bag on the floor of the boot. It must be secured by a strap attached to the car's load-retaining eyelets.

Warning

Before driving with a spare wheel

- Only use a spare wheel that your car is approved for.
- Never drive your car with more than one spare wheel fitted.
- Snow chains cannot be used if the spare wheel is fitted on the front axle.
- The spare wheel should never be repaired.
- Make sure to follow the spare wheel manufacturer's recommendations regarding tyre pressure.

Driving with a spare wheel

- Never drive faster than 80 km/h (50 mph) when a spare wheel is fitted to your car.
- Your car's driving characteristics may be affected by using a spare wheel. It is important to replace the spare wheel with an original wheel as soon as possible.

Important

The spare wheel is smaller than your car's original wheels. This will affect the car's ground clearance. Pay attention to high kerbs and do not wash your car in an automatic car wash.

Note

While a spare wheel is used, the tyre pressure monitoring system might not work correctly.

If the spare wheel is damaged, a new one can be purchased from a Volvo dealer.

^[1] The spare wheel must be of the type Temporary Spare.

13.4.3.2. Winter tyres

Winter tyres are designed for driving in road conditions with ice and snow. Your winter tyres' tread depth should be deeper than that of regular tyres.

Dimensions

When driving with winter tyres, it's important that all four tyres are of the correct type. Contact a Volvo dealer for advice.

Studded tyres

Studded winter tyres should be run-in gently for 500-1,000 km (300-600 miles) so that the studs settle properly into the tyres. This gives the tyre, and especially the studs, a longer service life.

Note

Legal regulations for the use of studded tyres may vary. Make sure your fitted tyres are in full compliance with local regulations and laws.

Tread depth

Road conditions with ice, slush, snow and low temperatures put higher demands on your tyres than summer conditions. Volvo recommends that winter tyres have a tread depth of at least 4 millimetres (0.15 inch).

Note

Speed rating

Winter tyres^[1] are allowed to have a lower speed rating than your car's top speed. However, if your winter tyres do have a lower speed rating than your car's top speed, you are not allowed to drive faster than the tyres' speed rating.

^[1] Both studded and stud-free tyres.

13.4.3.3. Using snow chains

Using snow chains can help to improve traction in winter conditions. However, there are some restrictions you have to keep in mind.

Warning

Snow chains can be used on your car with the following restrictions:

- Use genuine Volvo snow chains or equivalent chains designed for the car model, tyre and wheel rim dimensions.
- Only single-sided snow chains are permitted.
- The wrong snow chains may cause serious damage to the car and lead to an accident.

 **Note**

Using snow chains may result in malfunction of the tyre pressure monitoring system.

Fitting snow chains

- Make sure you are in a safe place when fitting or removing the snow chains.
- Always comply with local regulations and laws regarding the use of snow chains.
- Always carefully follow the mounting instructions from the manufacturer.
- Always use the same type of chains on left and right-hand side tyres.
- Make sure you use the correct size in relation to the wheels.
- Snow chains must only be used on the rear wheels.^[1]
- If wheels of a different size than the original wheels are fitted, certain snow chains must not be used.
- There needs to be sufficient distance between the chains and the car's brakes, suspension and body components. Chains that risk interfering with brake components must not be used.
- If you need to move your car while fitting or removing chains, do not let the wheels run over the chains' attachments.
- Fit the chains as tensioned as possible and tension them at regular intervals.

 **Tip**

Practise fitting the snow chains before winter comes.

Driving with snow chains

- Once the snow chains are fitted, drive about 200 metres (650 feet). Then stop the car and check again that the chains are firmly attached.
- Never exceed the chain manufacturer's specified speed limit. You must never exceed 50 km/h (30 mph) under any circumstances.
- While improving grip in certain conditions, snow chains negatively affect other driving characteristics. If possible, avoid driving over uneven ground, such as bumps or holes. Also avoid fast or sharp turns as well as hard braking.
- Avoid driving on ground not covered in snow or ice as this wears out both the snow chains and wheels.

Contact a Volvo dealer for more information.

^[1] This also applies to all-wheel drive cars.

13.4.4. Punctures

If you suffer a punctured tyre, there are several actions to take to recover safely, especially if it happens while you are driving.

If the puncture occurs while you are driving, it's important to think about safety first. Activate the hazard warning lights and, if possible, move the car away from immediate danger. If necessary, call roadside assistance.

Warning

- Do not drive the car if it has a punctured tyre. It is not safe and will damage the car.
- If possible, exit your car from the side with the least traffic to avoid causing an accident.
- Place a warning triangle so that others are warned well in advance of passing your car. Remember to first put on a reflective vest if you have one.

Tip

If your car is equipped with a temporary puncture repair kit, be sure to read its instructions before you use it.

13.4.4.1. Temporary puncture repair

A temporary puncture repair kit^[1] can be used to repair a minor puncture in a tyre. The kit includes a bottle of sealant fluid and a compressor.

Warning

Read through all the instructions before using the repair kit.

You should not drive faster than 80 km/h (50 mph) after the repair kit has been used on your tyres.



Temporary puncture repair kit

Compressor

The compressor is intended to be used for temporary tyre repair. You can also use the compressor to check and adjust the tyre pressure on your original tyres when needed.

The compressor is an electrical device. When it's time to dispose of it, be sure to follow local regulations related to waste management.

Sealant fluid

The sealant fluid works as a temporary repair. It is effective at sealing a tread puncture but should not be used to seal a puncture in the sidewall of the tyre. If the tyre has larger slits, cracks or similar damage, you should not use the sealant to repair it.

The bottle of sealant fluid needs to be replaced if the expiration date has passed. The old bottle is considered hazardous waste.

[1] Also called temporary mobility kit or TMK.

13.4.4.1.1. Using the temporary puncture repair kit

When using the temporary puncture repair kit, there are a number of important steps you need to follow. Make sure you read and understand each step before proceeding.

Note

These instructions apply to the temporary puncture repair kit supplied by Volvo.



Overview of the temporary puncture repair kit's compressor

- ① Pressure-reducing valve
- ② Pressure gauge
- ③ Air hose
- ④ Power switch

5 Electrical cable



Overview of the temporary puncture repair kit's sealing fluid bottle

1 Sealing fluid hose

2 Air hose connector

Warning

Sealing fluid can be harmful

The sealing fluid contains substances that are harmful if swallowed. The contents can also cause allergic reactions or be otherwise harmful to the respiratory tract, the skin, the central nervous system and the eyes.

Precautions

- Store the kit out of reach of children.
- Avoid prolonged or repeated contact with the skin. If you get sealing fluid on your clothes, remove them.
- Wash hands thoroughly after handling.

First aid

- Ingestion: Do not induce vomiting unless directed to do so by medical personnel. Get medical attention.
- Skin: Wash affected areas of skin with soap and water. Get medical attention if symptoms occur.
- Eyes: Flush with plenty of water for least 15 minutes, occasionally lifting the upper and lower eyelids. Get medical attention if symptoms occur.
- Inhalation: Move the exposed person to fresh air. If irritation persists, get medical attention.

- Make sure the compressor's power button is in the off position before starting.
- Don't remove the air hose or sealing fluid hose during repair.
- If the puncture was caused by a nail or similar and it's still in the tyre, leave it in. This helps to seal the puncture.
- If the repair is carried out in an area where there might be other vehicles, activate the hazard warning lights and use a warning triangle, if you have one.

Preparations

1.



Screw the air hose to the sealing fluid bottle. There's a place for it opposite to the sealing fluid hose.

2. Unscrew the tyre valve's dust cap and attach the sealing fluid hose. Screw the hose connector as far down the thread as possible.

Begin puncture repairs

3. Connect the compressor to the car's 12 V socket and ensure that the socket works and is supplying current.^[1]
4. Start the compressor by pressing the power button.

Warning

Never stand next to the tyre while the compressor is on. If cracks or bumps appear, the compressor must be turned off immediately. Stop and contact Volvo Assistance for safe recovery.

Note

Avoid placing the compressor in water, directly on sand or on very dusty ground as this may cause the compressor to malfunction.

5. Inflate the tyre until the pressure is greater than 1.8 bar (26 psi).
6. Shut the compressor off to check the pressure on the pressure gauge. Minimum pressure is 1.8 bar (26 psi) and maximum is 2.8 bar (39 psi). Use the pressure-reducing valve if the pressure is too high.

Warning

If the pressure is below 1.8 bar (26 psi), the hole in the tyre is too big. Do not continue and contact Volvo Assistance for safe recovery.

7. Unplug the compressor from the 12 V socket.
8. Unscrew the sealing fluid hose from the tyre.
9. Refit the tyre valve's dust cap.
10. As soon as possible, drive for 10 minutes^[2] at a maximum speed of 60 km/h (37 mph) and let the fluid seal the tyre. After that, perform a follow-up check.

Follow-up check

11. Connect the air hose to the tyre's air valve.

12. Check the tyre pressure on the compressor's pressure gauge.

- > • If the pressure is below 1.3 bar (19 psi), the tyre is insufficiently sealed. Stop and contact Volvo Assistance for safe recovery.
- If the pressure is higher than 1.3 bar (19 psi) but below 1.8 bar (26 psi), the tyre must be inflated to a minimum pressure of 1.8 bar (26 psi) and a maximum pressure of 2.8 bar (39 psi). Connect the compressor to the 12 V socket and inflate the tyre. Release air using the pressure-reducing valve if the tyre pressure is too high. Then redo step 10.
- If the pressure is between 1.8 bar (26 psi) and 2.8 bar (39 psi), you can drive at a maximum speed of 80 km/h (50 mph).

13. Refit the tyre valve's dust cap.

- Replace the sealing fluid bottle and hose after use. Contact a Volvo dealer to do so.
- Volvo recommends replacing or repairing the damaged tyre as soon as possible. Inform the workshop that the tyre contains sealing fluid.



Warning

Maximum mileage with tyres containing sealing fluid is 200 km (125 miles).

^[1] The socket no longer supplies power for a while after the driver has got out of the car. To resume power, just re-enter the car.

^[2] Or 5 kilometres (3 miles)

13.4.4.1.2. Inflating tyre with the puncture repair compressor

Your car's tyres can be inflated with the compressor that is included in the temporary puncture repair kit.

Make sure the compressor's power button is in the off position before starting.

1. Unscrew the tyre valve's dust cap and attach the compressor's air hose. Screw the air hose connector as far down the thread as possible.
2. Connect the compressor to the car's 12 V socket and ensure that the socket works and is supplying current.^[1]
3. Start the compressor by pressing the power button.

 **Important**

To avoid overheating, do not run the compressor for any longer than 10 minutes at a time.

4. Check the tyre pressure on the compressor's pressure gauge^[2]. Use the pressure-reducing valve if the pressure is too high.
5. Turn off the compressor and unplug it from the 12 V socket.
6. Unscrew the air hose from the tyre.
7. Refit the tyre valve's dust cap^[3].

Return the kit to its storage location.

^[1] The socket no longer supplies power a while after the driver has got out of the car. To resume power, just re-enter the car.

^[2] The recommended tyre pressure for the car's original tyres can be found on a label on the driver's side door pillar.

^[3] Only use original Volvo dust caps or plastic dust caps.

13.4.5. Tyre pressure

A correct tyre pressure helps to improve driving stability, lower energy consumption and extend the lifespan of the tyre.

With time, the tyre pressure decreases. The pressure also varies depending on environmental conditions. All of this is normal. However, if you drive with an incorrect tyre pressure, the tyres may overheat and become damaged. The tyre pressure affects ride comfort, noise levels and handling characteristics.

Make it a habit to check the tyre pressure monthly and before longer trips. Always make sure you use a reliable pressure gauge. To keep the tyres in good shape, use the recommended tyre pressure for cold tyres.

 **Warning**

If the tyre pressure is too high or too low, the tyres can sustain severe damage. The tyres can explode while you are driving and cause you to lose control of the car.

 **Tip**

A correct tyre pressure will help you take advantage of your car's full loading capacity.

13.4.5.1. Tyre pressure monitoring

Your car can detect and indicate if the tyre pressure is too low. Tyre pressure monitoring cannot be disabled. If the system is unable to detect low tyre pressure, it will indicate that there's a malfunction.

For the tyre pressure monitoring system to provide updated information, you need to drive the car above 35 km/h (22 mph) for several minutes.



An indicator symbol lights up if a low tyre pressure is detected in any of the tyres. It will stay illuminated until the problem is resolved.

In addition to messages in the display, you can also find information about the tyre pressure monitoring in the car status view.



Warning

No advance warning possible

The system cannot give you any advance warning of potential tyre damage.

Ensure correct tyre pressure immediately

When the low tyre pressure symbol is lit, stop and check the tyre pressures as soon as possible. Driving with underinflated tyres can cause tyre failure.

If you experience a malfunction or a fault is permanently indicated for the tyre pressure monitoring system, a service is required. [\[1\]](#)

Remember:

- The system does not replace the need for regular tyre inspection and maintenance.
- The indication symbol for low tyre pressure won't disappear until the low tyre pressure has been corrected.
- When you change wheels or loads, you should store a new tyre pressure reference value.



Note

Tyre pressure monitoring sensors need to be mounted on all wheels, including winter tyres. If you use a spare wheel or other wheel without the sensor, a fault message will appear in the driver information area after a few minutes of driving. Remember to make sure that new wheels have the sensor to avoid a system malfunction warning.

System description

The following information is phrased according to external legal requirements.

Each tyre, including the spare (if provided), should be checked monthly when cold and inflated to the inflation pressure recommended by the vehicle manufacturer on the vehicle placard or tyre inflation pressure label. (If your vehicle has tyres of a differ-

ent size than the size indicated on the vehicle placard or tyre inflation pressure label, you should determine the proper tyre inflation pressure for those tyres.)

As an added safety feature, your vehicle has been equipped with a tyre pressure monitoring system (TPMS) that illuminates a low tyre pressure telltale when one or more of your tyres is significantly under-inflated. Accordingly, when the low tyre pressure telltale illuminates, you should stop and check your tyres as soon as possible, and inflate them to the proper pressure. Driving on a significantly under-inflated tyre causes the tyre to overheat and can lead to tyre failure. Under-inflation also reduces fuel efficiency and tyre tread life, and may affect the vehicle's handling and stopping ability.

Please note that the TPMS is not a substitute for proper tyre maintenance, and it is the driver's responsibility to maintain correct tyre pressure, even if under-inflation has not reached the level to trigger illumination of the TPMS low tyre pressure telltale.

Your vehicle has also been equipped with a TPMS malfunction indicator to indicate when the system is not operating properly. The TPMS malfunction indicator is combined with the low tyre pressure telltale. When the system detects a malfunction, the telltale will flash for approximately one minute and then remain continuously illuminated. This sequence will continue upon subsequent vehicle start-ups as long as the malfunction exists. When the malfunction indicator is illuminated, the system may not be able to detect or signal low tyre pressure as intended. TPMS malfunctions may occur for a variety of reasons, including the installation of replacement or alternate tyres or wheels on the vehicle that prevent the TPMS from functioning properly. Always check the TPMS malfunction telltale after replacing one or more tyres or wheels on your vehicle to ensure that the replacement or alternate tyres and wheels allow the TPMS to continue to function properly.

^[1] Volvo recommends an authorised Volvo workshop for any repair or service needs.

13.4.5.1.1. Limitations of tyre pressure monitoring

There are some circumstances in which the tyre pressure monitoring may not function correctly. Be sure to familiarise yourself with them to understand the system's limitations.

Tyre pressure monitoring can be negatively affected by:

- incompatible rims or tyres
- wheel modifications
- injected liquids such as tyre sealing fluid
- snow chains
- accessories that interfere with the system's wireless transmission or the car's electrical system
- staying close to sources of strong radio waves or electrical fields. A few examples of locations that may cause this type of interference are petrol stations, airports and TV stations.

If the car detects a fault with the system, it is indicated in the display.

13.4.5.2. Adjusting tyre pressure

The tyre pressure needs to be adjusted if you're planning to drive with a heavy load or at high speeds for prolonged periods. It's also normal for tyre pressure to decrease over time. Adjusting it so you have the

correct pressure for the current situation helps ensure an even tyre wear and high performance.

The tyres need to be at ambient temperature when the pressure is checked and adjusted. This is referred to as having cold tyres. Never release air from a warm tyre. When it cools down, the internal air pressure drops, which can lead to underinflated or even entirely deflated tyres.

The tyres can warm up very quickly and should be considered warm if driven for longer than approximately 1.5 km (1 mile). They often need about 3 hours of cooling down before reaching ambient temperature again.

1. Remove the tyre valve's dust cap and then press the tyre pressure gauge firmly onto the valve.
2. Check the gauge to see what the current tyre pressure is.
3. If the pressure is low, inflate the tyre to the correct pressure. The recommended pressure for factory-fitted tyres is shown on the door pillar on the driver's side.
4. Refit the dust cap^[1] to avoid damage to the valve.
5. Inspect the tyre for stuck debris, such as nails or other objects, that could puncture the tyre.
6. Check the sidewalls for any cavities, cuts, bumps or other irregularities.

If you accidentally over-inflate the tyre, press the metal pin in the middle of the valve to let out the excess air. Then check the pressure again.

 **Note**

Spare wheels may have recommended pressures that are different from those of the original tyres. Always use the pressure recommended by the spare wheel manufacturer.

 **Tip**

You can use the compressor from the temporary puncture repair kit to check and adjust the tyre pressure on your original tyres when needed.

^[1] Only use original Volvo dust caps or plastic ones as metal dust caps may corrode and stick to the valve.

13.5. Car electrics and batteries

Your car has a specialised electrical system that delivers electricity to and from the batteries. There are both high-voltage and low-voltage circuits for different electrical functions.

There is information about several of your car's electrical components in this section of the manual. This includes:

The content of this manual represents the status of the user manual at the time of printing and may not be completely valid in future instances. For more information, refer to the first page for the complete disclaimer note.

- Traction battery
- 12 V battery
- Emergency 12 V supply terminal
- Fuses

 **Important**

12 V terminal

In the event of a total loss of power, the car can't be unlocked as the locks are electrically operated. To access the car and charge it, the car can be powered for a short time using the externally accessible 12 V terminal. It can be accessed by removing a small panel below the front bumper, near the front left wheel.

Before any use of the 12 V terminal, consider the following:

- Volvo recommends that the 12 V terminal is only used by service technicians for the purpose of accessing the car as part of immobilisation recovery.
- The external 12 V terminal on your car should only be used to make your car accessible. Do not attempt to charge another car or similar external source from this point.
- Only use a 12 V charger with a maximum charging current below 40 A.
- Connecting any power source that delivers currents higher than 40 A blows the terminal's fuse, thereby disabling it.
- Only use the 12 V terminal for short amounts of time. This is not meant as a way of powering the car continuously.
- Make sure to follow the positive and negative markings on the terminals as reversing the polarity of the low voltage system can lead to damaging the low voltage system components or blowing the 40 A fuse.

 **Tip**

Car charging

Features and equipment related to charging, such as the charging port and cables, have their own section.

Convenience features

Power-related features, such as USB ports and the wireless charging of devices, are covered in other sections.

 **Warning**

- Do not handle or modify the car's electrical components. Only perform actions that are clearly described in the user manual.
- High-voltage components can produce or conduct lethal currents and must only be handled by authorised technicians.
- Do not perform repairs on the car's electrical system or components. Contact an authorised Volvo workshop for any required repairs or servicing.

13.5.1. Traction battery

Your car's traction battery is the central energy and power source for your car. It powers all electric propulsion and indirectly powers the rest of the car by keeping the smaller 12 V battery charged.

The traction battery sits low in the underbody of the car.

Battery care and health

How you use your car affects the traction battery's condition. Over time its capacity decreases. There are recommended user practices that can help extend the battery's service life. These user practices cover events and conditions that can cause battery damage.

Important

Leaving the car with a low battery level can lead to battery damage. Make sure to charge the car as soon as possible if the battery level is near empty.

Tip

There are separate sections in this manual about battery health and what you can do to recover from a low-power scenario.

Battery service and maintenance

The traction battery is a high-voltage component that only authorised technicians are equipped to service safely.

Warning

- Do not handle or modify the car's electrical components. Only perform actions that are clearly described in the user manual.
- High-voltage components can produce or conduct lethal currents and must only be handled by authorised technicians.
- Do not perform repairs on the car's electrical system or components. Contact an authorised Volvo workshop for any required repairs or servicing.

13.5.1.1. Managing battery health and performance

There are user practices that can help maintain the traction battery's condition and performance over time. Some scenarios can lead to battery damage and should always be avoided.

Low battery level and flat battery

 **Important**

The traction battery can sustain severe damage if it is not charged after the battery level reaches 0%. The car draws a small amount of power when parked. Therefore, leaving the car with a low battery level without charging can lead to a flat battery and battery damage. If the battery level is below 20% when parked, it is recommended that the car is connected for charging as soon as possible.

If the battery level reaches 0%, the battery is considered flat or empty. The car then needs to be charged as soon as possible to reduce the risk of battery damage.

The smaller 12 V battery is also at risk of going flat if the traction battery can't supply it with power. If both batteries have gone flat, the car will have no power at all and no ability to initiate charging.

High state of charge

 **Important**

The traction battery can sustain damage if the car's battery level is kept very high for a long period of time.

If you are leaving the car plugged in for charging without any immediate plans to drive it, select the target battery level recommended in the car's charging view.

Charging habits

AC charging is the recommended charging mode for everyday charging. This helps maintain the condition of the battery over time. DC charging causes more wear.

You can set a target battery level by selecting a value in the charging view. This will help you to maintain good charging performance and battery longevity.

Long-term parking

When leaving your car parked for longer than one month, the recommended battery level is 40-60%. Use or charge the car to reach the recommended level.

If you are leaving the car parked for longer than three months, it's recommended to keep it plugged in but set the battery charging limit to 50%. This is for better battery health.

Regularly check the battery level and that charging is working.

 **Tip**

There is a separate section in this manual with more recommendations for long-term parking.

Parking in hot weather

 **Important**

Avoid exposing the car to extreme temperatures. Avoid leaving the car parked for longer than 24 hours if the temperature is at risk of reaching 55 °C (131 °F).

During warmer periods of time, you're recommended to plug in the car during parking. High temperatures cause battery damage, especially when the car is exposed to hot weather for prolonged periods. The car can actively cool the battery while it's parked, but that uses energy. When you're returning to your parked car, the battery level could be noticeably lower than before. If the car is plugged in for charging, it can cool the battery without lowering the battery level and risking a flat battery.

In hot temperatures, it is recommended that you park in a shaded spot. Strong sunlight combined with high temperatures can lead to very high battery temperatures and excessive cooling needs.

Parking in cold weather

When the battery is cold, the car temporarily reduces battery performance until it's warmed up. Driving the car in a state of reduced performance doesn't harm the battery.

To avoid temporarily reduced performance from a cold battery, connect the car for charging and activate the car's preconditioning ahead of your trip. The car can then heat the battery without affecting performance and available range.

In temperatures below -30 °C (-22 °F), avoid leaving the car parked without charging for longer than 24 hours.

13.5.1.2. Powertrain cooling system

Your car has an advanced temperature regulation system.

The system actively regulates the temperature of the traction battery while you're parked, charging or driving your car. This happens if your car experiences high or low temperatures and during preconditioning.

 **Important**

Never attempt to add coolant yourself

The cooling system is a closed system. A trained technician must perform any required maintenance of the cooling system.^[1]

^[1] Volvo recommends an authorised Volvo workshop.

13.5.2. 12 V battery

The 12 V battery powers everything in your car except the electric propulsion.

Servicing and replacement

The 12 V battery is maintenance-free.

Contact an authorised Volvo workshop if the 12 V battery needs to be replaced.

Important

12 V terminal

In the event of a total loss of power, your car can't be unlocked as the locks are electrically operated. To access your car and charge it, it can be powered for a short time using the externally accessible 12 V terminal. The terminal can be accessed by removing a small panel below the front bumper, near the front left wheel.

Before any use of the 12 V terminal, consider the following:

- Volvo recommends that the 12 V terminal is only used by service technicians for the purpose of accessing the car as part of immobilisation recovery.
- The external 12 V terminal on your car should only be used to make your car accessible. Do not attempt to charge another car or similar external source from this point.
- Only use a 12 V charger with a maximum charging current below 40 A.
- Connecting any power source that delivers currents higher than 40 A blows the terminal's fuse, thereby disabling it.
- Only use the 12 V terminal for short amounts of time. This is not meant as a way of powering the car continuously.
- Make sure to follow the positive and negative markings on the terminals as reversing the polarity of the low voltage system can lead to damaging the low voltage system components or blowing the 40 A fuse.

12 V battery specifications

Battery type	AGM H4
Voltage	12 V
Dimensions (length × width × height)	207 × 175 × 190 mm (8 ⁵ / ₃₂ × 6 ⁵⁷ / ₆₄ × 7 ³¹ / ₆₄ in)
Capacity	50 Ah
Cold start capacity ^[1]	540 A

[1] CCA

13.5.2.1. Battery labels

Low-voltage car batteries have labels containing information for safe handling.

Symbols



The content of this manual represents the status of the user manual at the time of printing and may not be completely valid in future instances. For more information, refer to the first page for the complete disclaimer note.

Avoid sparks and naked flames.



Risk of explosion.



The battery contains corrosive acid.



Use protective goggles.



Store the battery out of reach of children.



The battery must be disposed of properly to be recycled.



Recycle properly.



More information in the car's user manual.

(i) Note

Depicted labels

Labels depicted in this manual are generic representations of those found around your car. The manual only contains their location and what kind of information they hold. Find the actual label for specific information about your car.

13.5.3. Battery recycling

Used batteries must be recycled in an environmentally sound manner.

Consult Volvo support if you're unsure of how to dispose of batteries. The traction battery must only be handled by authorised technicians.

13.5.4. Fuses

Electrical fuses protect different parts of the car's electrical system by cutting the power if the current exceeds the fuse's threshold. A blown fuse must be replaced to restore functionality.

A blown fuse may be an indicator of an underlying electrical fault. Contact Volvo support if your car indicates that a fuse has blown.

Important

- If a fuse is incorrectly replaced it can cause severe damage to the electrical system.
- A replacement fuse must have the correct specifications, such as type and ampere value.
- Volvo recommends an authorised Volvo workshop for fuse replacements.

13.6. Tools and equipment

Your car is equipped with some tools that may be useful in certain situations. For example, if you need to change a wheel.

The tools and equipment in your car are stored in different places, such as under the bonnet, in the glove box and in the boot. Be sure to familiarise yourself with where everything is stored so you don't have to search for something when you need it.

Warning

Store tools appropriately

Always store loose tools and equipment in designated storage areas when not in use. Otherwise, they can cause damage or injury in the event of a collision.

Read all instructions before using tools

Before use, make sure you read and understand all the relevant instructions for tools and equipment.

Contact a Volvo dealer for recommendations concerning tools and equipment for your car.

Warning triangle



If your car should be immobilised in an area where there might be other vehicles, you can place the warning triangle on the ground to alert others before they reach your car.

Towing eye



The towing eye can be attached to the car's bumper to enable towing. It can also be used to secure roof-loaded objects that are longer than the roof.

Temporary puncture repair kit



Temporary puncture repair kit

Your car is equipped with a temporary puncture repair kit which can be used to repair a minor puncture in a tyre.

First aid kit

Your car is equipped with a first aid kit. Some regions require that it's always available in your car.

13.6.1. Using a warning triangle

Assemble and set out a warning triangle if your car is immobilised in an area where there might be other vehicles. The warning triangle's purpose is to give other drivers advance notice of your car or other stationary hazards.

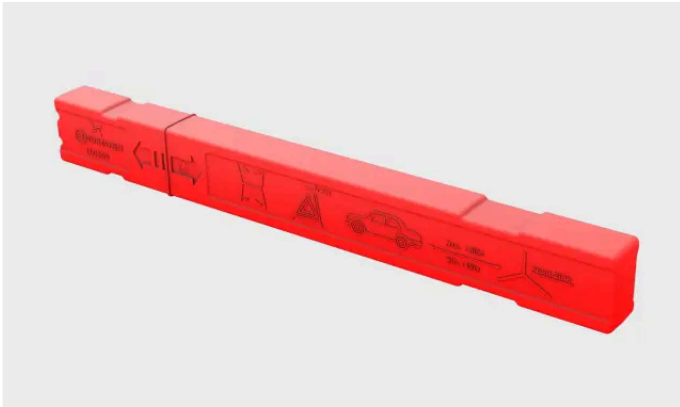

The folded warning triangle in its case.

i Note

Local rules and regulations

Rules and regulations about how and when to put out a warning triangle vary between regions. You are responsible for knowing and following what applies in your location.

i Tip

- If it's dark when you set out the warning triangle, wear a reflective vest if you have one in the car. If you don't have one, you can hold the warning triangle so that its reflective parts are visible as you carry it.
- You can use the case as a reminder to retrieve the warning triangle when you leave by placing it on the driver's seat.

1. Activate the hazard warning lights.
2. Take out the warning triangle from the case, unfold it and connect its ends.
3. Fold out the triangle's support legs.
4. Position the warning triangle in a suitable place in regard to traffic and at a distance which ensures that other drivers are alerted in good time before they reach your car.

Remember to retrieve the warning triangle before you drive off again.

13.6.2. Attaching the towing eye

Use the towing eye to attach a winch wire when towing.

On the right-hand side of the car, the towing eye is screwed into a threaded socket behind a cover located on the front and rear bumpers.

! Important

Be sure to read about towing and its limitations before you start.

Fetch the towing eye so you have it at hand.

1.

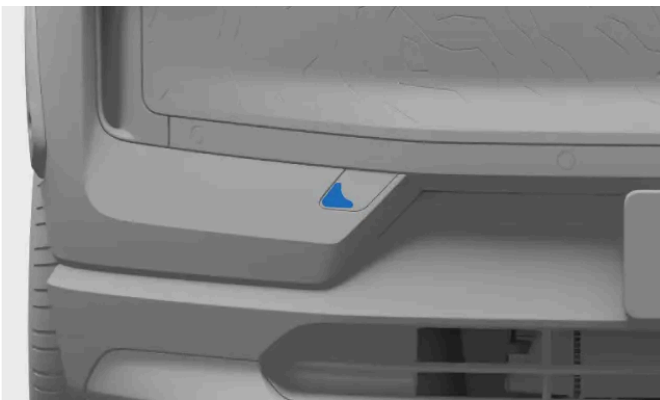

Front towing eye fastening cover.

To attach in the front: Remove the cover by pushing the middle of the left-hand side edge. The cover pivots around its centre line and can then be removed.



Rear towing eye fastening cover.

To attach in the rear: Remove the cover by pushing its top edge. Fold it out entirely and take it off.

2. Screw the towing eye all the way into the socket.

! Important

It is important that the towing eye is firmly screwed into place. Putting something through the towing eye, such as a wheel wrench, can give extra leverage.

After you're done, remember to remove the towing eye again and return it to its storage location.

13.7. Raising the car

You can raise one wheel off the ground at a time using a jack. Be sure to read all instructions before raising the car.

Important

It is very important to place the jack on the jacking points or the battery may get damaged.

Recommended or supplied equipment

- The instructions for raising the car presume use of a jack recommended or supplied^[1] by Volvo.
- Only use tools and equipment designed for your car model. Contact a Volvo dealer for tool recommendations.
- Volvo recommends an authorised Volvo workshop for tasks not described in the user manual.
- A portable jack designed for occasional and limited use is only suitable for short and urgent tasks, such as handling a puncture. A workshop jack is recommended for frequent or extended use.
- Only raise the car using its jacking points.

Other lifting equipment

- If using lifting equipment not supplied by Volvo^[2], carefully read their instructions before raising the car. Ensure that the equipment is compatible with the car.
- Use additional safety equipment such as axle stands and wheel blocks when applicable.
- If you're using a workshop jack, make sure that the jack plate is fitted with a rubber guard to protect the car as well as ensure that the car remains stable.

 **Warning**

Safety around the car

- If you are changing a wheel in or close to traffic, make sure you and the car are clearly visible to others. Activate the hazard warning lights, put out a warning triangle in a visible but safe place and wear a reflective vest.
- Designate a safe area for passengers to wait, away from both the car and traffic.
- You are responsible for safety around the car while it is raised. Do not allow people to stay inside of or close to the car.

Raising the car

- Never get under the car, or let anyone reach under it with any part of their body, while it is raised.
- Do not place any object between the ground and the jack, nor between the jack and the car's jacking point.
- Do not use lifting equipment that shows any sign of damage.

Before raising the car:

- Gather the tools and parts needed for your planned work.
 - Make sure that the jack is in good condition, and that its threads are properly lubricated and free from dirt.
 - To avoid accidentally triggering the alarm, reduce your car's alarm sensitivity.
1. Activate the parking brake.
 2. Place wheel blocks to reduce the risk of car movement while raised. Large stones or wooden blocks work well. Place them both in front of and behind each wheel that will remain on the ground.
 3. Locate the intended jacking point on the car's underbody. Triangular markings low down along the car's sides indicate the jacking points' locations.

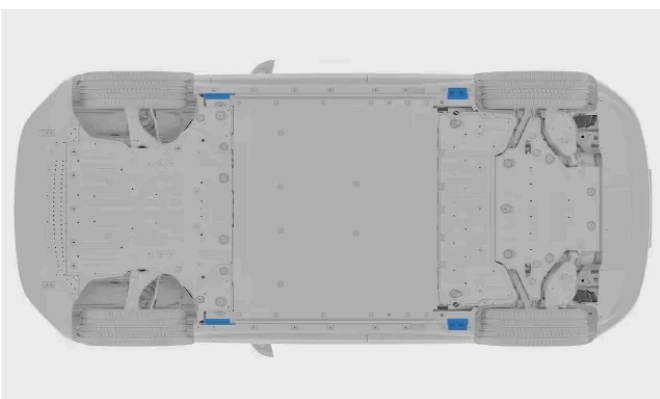

There are two jacking points on each side of the car.

4. Place the jack under the car's jacking point. The surface it stands on must be firm, non-slippery and level. Position the jack with the crank handle pointing away from the car.

5. Crank the jack up until its head reaches the car's jacking point. Ensure that the jacking point fits into the jack's slot properly.

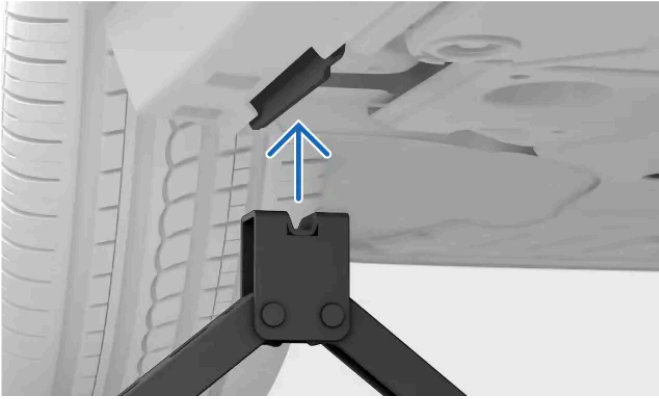

6. Make a final alignment. Make sure that:

- the jack is not leaning in any direction
- the base of the jack is centred under the jacking point
- the jack head meets the jacking point correctly.

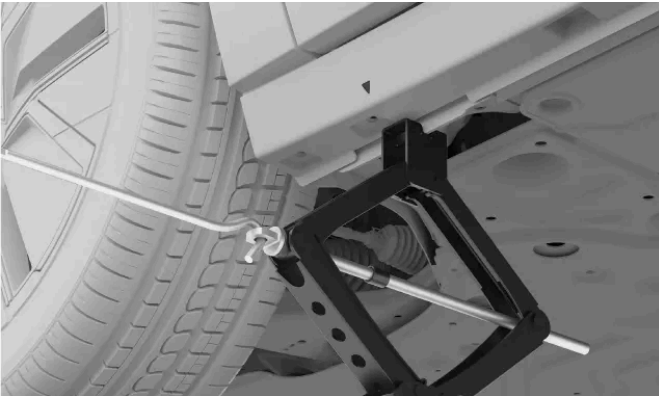

7. Raise the car to an appropriate height. Do not raise it higher than what's necessary for the work you're doing.



Warning

Do not leave the car unsupervised when raised.

Carefully lower the car when you have finished your work. Remember to test important car functions that may have been affected by the work you performed.

Put the jack back in its storage place.

^[1] Depending on market, a jack for occasional and limited use may be included with the car.

^[2] Such as workshop jacks or other lifting equipment designed for frequent and extended use.

13.8. Servicing and repairs

Properly performed maintenance, servicing and repairs are essential for keeping your car in good working condition.

Your car keeps track of when it was last serviced and tells you when it's time to make a new appointment. It can self-diagnose many types of faults and notify you if you need to take action.

If you notice any service or repair needs that have not been detected by the car, contact Volvo support.

Volvo recommends an authorised Volvo workshop for all servicing and repair needs.

 **Important**

Faults and notifications

If a notification in the car calls for a service, make a service appointment as soon as you can. The car status view in the display also contains information about detected issues.

 **Warning**

- Do not handle or modify the car's electrical components. Only perform actions that are clearly described in the user manual.
- High-voltage components can produce or conduct lethal currents and must only be handled by authorised technicians.
- Do not perform repairs on the car's electrical system or components. Contact an authorised Volvo workshop for any required repairs or servicing.

Volvo's recommended service programme

Volvo recommends engaging an authorised Volvo workshop to perform any service and maintenance work. Volvo workshops have the personnel, special tools and service literature required to provide high-quality servicing. Volvo's recommended service programme has been developed to give your car a long service life. Servicing your car according to its customised service programme may be a prerequisite for coverage under Volvo's warranties. Your car's service and warranty information^[1] contains more details about maintenance service and warranty terms and conditions.

^[1] This is a separate publication included with your car.

13.8.1. Booking servicing or repairs

Volvo support handles bookings when you need a service or repair appointment. Authorised Volvo workshops have specialised training and equipment to take care of your car.

Your car notifies you when it's time for servicing.

1. Contact Volvo support to book an appointment. They can locate your closest service point.

If you're unable to reach Volvo support and urgently need servicing or repairs, contact a roadside assistance service available in your location.

13.8.2. On-board diagnostic port

Your car has a diagnostic port that allows a workshop to connect to the car and communicate with its systems. Do not connect equipment that has not been authorised by Volvo.

The diagnostic port is of the type OBDII.

The diagnostic port is located on the underside of the dashboard, close to the bonnet release lever.

Improper use of the diagnostic port can negatively affect the car's systems and software. This includes connecting unauthorised equipment^[1] and installation of software or diagnostic tools.

Note

Volvo accepts no liability if unauthorised equipment is connected to the on-board diagnostic port. Contact an authorised Volvo workshop for more information.

^[1] Equipment not approved by Volvo.

14. Immobilised car and recovery

If you can't drive your car, it's considered to be immobilised. You can always contact an authorised Volvo workshop if you're unable to find a solution in the user manual or if you are uncertain about how to proceed.

Depending on the nature of the problem, you may be able to solve it on your own or with assistance from an authorised Volvo workshop or other services. In this part of the user manual, you will find a number of scenarios and how to handle them safely.

In a situation where there are injuries or risk of injury, prioritise safety and medical needs over car recovery. Don't hesitate to contact emergency services if necessary.

The following scenarios have their own manual sections that can help you identify the underlying issue and what the necessary steps for recovery are.

- The car malfunctions and the car can't be used as intended.
- The battery is flat and the car is unresponsive.
- There is physical damage to the car. The damage can make the car unsuitable to drive or cause immobilisation. Even superficial damage needs to be evaluated to ensure that you can safely use the car.

Important

Having your car towed

If your car requires towing, there are some guidelines you need to follow. If your car is undamaged and has power, tow mode must be activated to pull your car onto a recovery vehicle's platform. When your car is in tow mode, the speed of the recovery vehicle should not exceed 5 km/h (3 mph) and the towing distance should not exceed 10 m (30 ft). If tow mode cannot be activated, the car must be lifted onto a recovery vehicle.

14.1. Damaged car

If your car is damaged, it is important to identify the extent and severity of the damage to determine how to handle the car safely.

Damage can immobilise your car or make it unsafe to drive.

Contact an authorised Volvo workshop if your car has been damaged or if it shows signs of damage sustained while parked. If the damage immobilises or severely impairs your car's performance, recovery through a roadside assistance and recovery service is necessary.

 **Important**

Minor damage

Your car can self-diagnose many defects, but it can't detect all types of damage or predict their consequences. A small impact resulting in superficial damage can disturb components behind the affected area, such as misaligning a parking sensor behind a bumper. It is therefore important to have seemingly minor or superficial damage examined by a trained technician to determine the full extent of the damage.

Immobilising damage

There are several types of damage that can immobilise your car. They include, but are not limited to:

- Collision damage
- Puncture
- Windscreen damage
- Water damage
- Mechanical failure

Collision damage

After a severe enough collision, your car enters safety mode and needs to be recovered.

 **Important**

If possible, do not try to drive or move your car after a severe collision. If the car poses an acute traffic hazard, an exception can be made to move it a short distance out of immediate danger if the state of the car allows it.

Water damage

Water damage can cause permanent damage to your car and severely affect how well it works.

 **Important**

Simply drying the car out or allowing it to dry will often be insufficient to resolve significant water damage. A trained technician should examine any water damage to determine its full extent and severity.

Mechanical damage

The best way to avoid mechanical failures is to follow the intended use and to regularly maintain your car. It is important to continuously perform check-ups of the car.

14.2. Malfunction

When part of your car or one of its features is not working as designed, that counts as a malfunction.^[1] It may not be safe to use the car at all, depending on what type of malfunction the car is experiencing.

 **Note**

Immobilised car

You should consider your car to be immobilised if a malfunction prevents you from driving safely.

Unresponsive car

There is a separate section in this manual for power-related issues.

General advice for malfunctions

If a function doesn't work properly, try the following actions:

- Read what the user manual has to say about the function. Make sure that you are aware of what's required for it to work properly. The cause of the problem might be that you are unaware of a limitation of a specific function.
- Restart all related devices and systems. This applies to your car itself, but can also include your phone or an app.
- If there is more than one way to use a function or perform a task, try the alternatives.

 **Note**

Changes after software updates

Software updates can introduce changes to functions that affect how they work. Be sure to read the information provided with each update so that you understand why your car may behave differently.

Possible causes

When a function isn't working the way you expect it to, there are several possible causes:

- The car's settings have been changed.
- Environmental conditions are affecting your car and its systems.
- Signal interference is affecting connectivity and wireless systems.
- A fuse has blown and needs to be replaced.
- Software error.
- Mechanical failure.

Contact an authorised Volvo workshop if needed

If you can't solve the problem using the information in the user manual, contact an authorised Volvo workshop.

Take note of what happened around the time the problem appeared. It may help identify the cause. A key event could be:

- Damage to your car.
- Exposure to extreme conditions.

- Recently performed servicing, maintenance or replacement of a component.
- Recently updated software.
- Any other faults or malfunctions.

[1] In some cases, a suspected fault or failure may instead be an intentional limitation under the conditions experienced by the car.

14.3. Powerless or unresponsive car

If your car is unresponsive or appears to have no power, the cause could be flat batteries or something affecting its electrical systems.

If your car's batteries are flat, the car will not respond to some of your actions. This includes trying to unlock or start it.

If your car doesn't respond due to low power, there are several recovery options depending on the situation.

The following situations can lead to both batteries in your car going flat:

- The car is driven to 0% battery level and is then not immediately recharged.
- The car is left with a low battery level. If not plugged in for charging, the battery level drops further as the car uses a small amount of power while parked.
- The car is left without being charged for a long time, which allows the battery level to drop.
- Low temperatures temporarily reducing battery capacity below the required level to keep your car powered.

Conditions or uses that increase power consumption and result in a faster-than-expected drop in battery level include:

- Use of accessories or power-consuming car functions.
- High temperatures triggering battery cooling.

Recovery from a flat traction battery

If only the traction battery is flat, the car's systems have power but it can't be started or driven. Your car shows that the battery level is at 0%. In this situation, the 12 V battery can power the systems needed to initiate charging of the traction battery. It's important to conserve energy in the 12 V battery so that you can access and charge your car.

Car recovery actions:

- If you can charge your car where it's parked, do so immediately.
- If your car can't be charged at your current location, have the car recovered and transported to a charging source. In the meantime, try to conserve the remaining power in the 12 V battery. This is important for battery health, but also keeps essential functionality available for you to use in an emergency.

Recovery from total loss of power

If the 12 V battery goes flat, your car will be completely unresponsive. This can happen if something prevents the traction battery from keeping the 12 V battery charged, such as allowing the traction battery to go flat and then not charging the car in time.

If both batteries are flat, your car is entirely unresponsive and cannot be charged as usual.

Recovery actions:

- Contact an authorised Volvo workshop or a recovery and roadside assistance service.
- If there is a charging source where your car is immobilised, it may be possible to temporarily power the car using a special exterior 12 V terminal. This can allow you to initiate charging.
- If your car can't be charged where it is, it needs to be transported to a location with a charging source. An authorised Volvo workshop has the equipment to power your car and charge it.

 **Important**

12 V terminal

In the event of a total loss of power, your car can't be unlocked as the locks are electrically operated. To access your car and charge it, it can be powered for a short time using the externally accessible 12 V terminal. The terminal can be accessed by removing a small panel below the front bumper, near the front left wheel.

Before any use of the 12 V terminal, consider the following:

- Volvo recommends that the 12 V terminal is only used by service technicians for the purpose of accessing the car as part of immobilisation recovery.
- The external 12 V terminal on your car should only be used to make your car accessible. Do not attempt to charge another car or similar external source from this point.
- Only use a 12 V charger with a maximum charging current below 40 A.
- Connecting any power source that delivers currents higher than 40 A blows the terminal's fuse, thereby disabling it.
- Only use the 12 V terminal for short amounts of time. This is not meant as a way of powering the car continuously.
- Make sure to follow the positive and negative markings on the terminals as reversing the polarity of the low voltage system can lead to damaging the low voltage system components or blowing the 40 A fuse.

Other no power scenarios

There may be cases where you are fairly sure that the battery level is not low. In those cases, a lack of power indicates that the 12 V battery isn't receiving power from the traction battery or can't deliver power to the car.

Possible scenarios that affect the 12 V power delivery are:

- A fuse has blown and needs to be replaced.
- The 12 V battery is defective.
- There is an electrical, hardware or software fault preventing the car from turning on.

If you can't identify the cause of the problem or solve it by referring to the user manual, contact an authorised Volvo workshop.

14.4. Recovery

Recovery of your car typically requires transporting it with a recovery vehicle. This is necessary if the car is immobilised and its functions cannot be restored where it is.

The content of this manual represents the status of the user manual at the time of printing and may not be completely valid in future instances. For more information, refer to the first page for the complete disclaimer note.

Contact an authorised Volvo workshop if you need to recover your car.^[1]

The recommended recovery procedure depends on the conditions and state of the car. If your car is undamaged and has power, tow mode can be activated to pull the car onto a recovery vehicle's platform. If the car is damaged, unresponsive or in safety mode, it should be lifted onto the recovery vehicle's platform.

 **Important**

Wheels off the ground

Regardless of your car's condition, it must be transported with all wheels off the ground when recovered. Forced wheel rotation during transportation can severely damage your car.

Keep a safe distance

Do not allow anyone to stand directly behind your car as it is pulled onto the recovery vehicle.

^[1] For urgent recovery needs, you can also directly contact a recovery and roadside assistance service.

14.5. Safety mode

If your car detects damage that compromises safety, it can enter safety mode.

Safety mode limits the available functions when your car has sustained damage. When safety mode is active, you cannot drive your car and it must undergo damage assessment and repairs^[1]. Contact an authorised Volvo workshop if safety mode has been activated for any reason.

The display clearly indicates when your car is in safety mode, if it is still functioning.

 **Warning**

- Do not use or stay in your car when it is in safety mode.
- Do not tow your car without first activating tow mode. This can be done in the display.
- Resetting your car's status without performing damage assessment and repairs can result in further damage to the car as well as personal injury.

^[1] Volvo recommends an authorised Volvo workshop.

14.6. Having your car towed

Your car can be towed short distances. For this, tow mode must first be activated.

The content of this manual represents the status of the user manual at the time of printing and may not be completely valid in future instances. For more information, refer to the first page for the complete disclaimer note.

 **Important**

Before having your car towed

- To avoid triggering the alarm inadvertently, you need to reduce your car's alarm sensitivity before towing it.
- You can only access tow mode if the car has power. If your car can't be powered on, it will need to be lifted onto the recovery vehicle's platform.
- Be sure to read all information about having your car towed before you activate tow mode.
- You should not tow your car further than 10 m (30 ft). Towing your car longer distances can damage the car by causing the battery to charge incorrectly.
- In tow mode, the towing speed of your car should not exceed 5 km/h (3 mph).

To tow your car, you must first activate tow mode, which involves attaching the towing eye and the winch wire. Make sure that you have all the necessary equipment ready.

1. Activate tow mode.
 - > Tow mode activation confirmation appears in the display, if it is still functioning.
2. Tow your car onto a recovery vehicle or to a safe place, such as the side of the road.
3. When the car is in the necessary place, engage the parking brake.
 - > Tow mode deactivates.
4. If necessary, remove the towing eye and winch wire.

 **Important**

Always use a recovery vehicle to transport the car whenever it cannot be driven. Forced wheel rotation during transportation can severely damage your car. Make sure the car is only transported by a recovery vehicle such as a flatbed, so that the car's wheels do not touch the ground while being transported.

14.6.1. Activating tow mode

If your car needs to be towed onto a flatbed recovery vehicle, you first need to activate tow mode in settings.

 **Important**

- Having your car towed without activating tow mode may damage it. Be sure to follow the instructions in the display until you have received confirmation that tow mode is active before your car is towed.
- To avoid accidentally triggering the alarm, reduce your car's alarm sensitivity before towing it.
- Tow mode can only be accessed if the car has power. If the car can't be powered on it will need a full recovery.
- Be sure to read all information about having your car towed before you activate tow mode.

 **Note**

Tow mode is only used when having your car towed. Do not activate it when towing other vehicles or trailers.

1. Press the car symbol  in the bottom bar and go to **Settings**.
 2. Go to **Controls** → **Car modes** → **Tow mode guide**.
- > The tow mode tutorial appears in the display.
3. Follow the tutorial until you get confirmation that tow mode is active.

Tow mode deactivates when you engage the parking brake and lock the car, or when you start driving.

15. Specifications

These specifications describe your car in technical terms and figures. You might need to find some of these details, such as when buying new tyres.

This information is divided up in the following manner, with some examples of their content to help guide you.

- General car characteristics – dimensions, weights and type designations.
 - Powertrain specifications – performance, electric motor, range and electric consumption.
 - Wheel and tyre specifications – approved tyre pressures and tyre sizes.
 - Fluid specifications – brake fluid and air conditioning coolant.
 - Certificates and type approvals
-

15.1. General car characteristics

These are the basic facts about your car. This data helps you determine your car's specific set-up.

You may need to know these things about your car for a number of reasons. For example, to be able to order the correct spare parts or accessories.

15.1.1. Car dimensions

Here you can find your car's measurements, such as length and height.

Locate the measurement you're looking for in the images first, then check the corresponding letter in the table below.

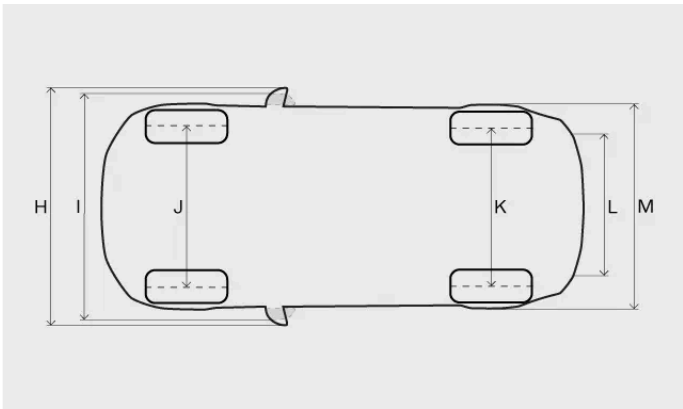
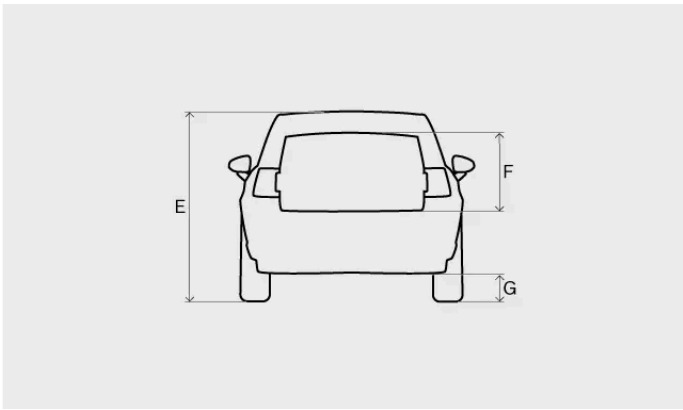
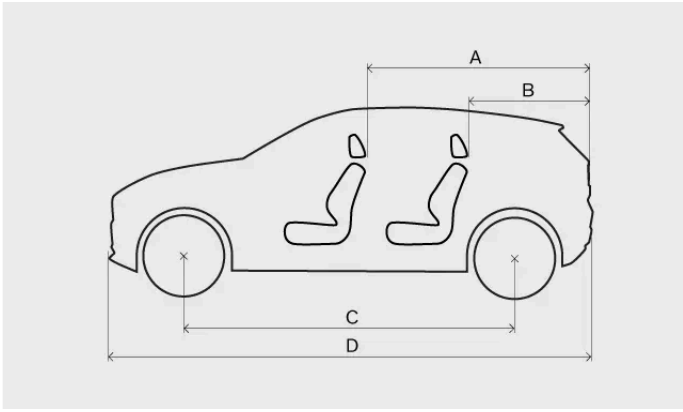

Measurement	Millimetres	Inches	
A	Load length, floor, folded seat	1460	57.5
B	Load length, floor	720	28.3
C	Wheelbase	2650	104.3
D	Length	4233	166.7
E	Height ^[1]	1567	61.7
F	Load height	581	22.9
G	Ground clearance ^[1]	190	7.5
H	Width including folded-out wing mirrors	2040	80.3
I	Width including folded-in wing mirrors	1953	76.9
J	Front track	1590	62.6

Measurement		Millimetres	Inches
K	Rear track	1595	62.8
L	Load width, floor	1019	40.1
M	Width	1850	72.8

[1] At kerb weight plus one person.

15.1.2. Weights

Your car's maximum gross vehicle weight can be read on a label in the car.

Weight terminology

Kerb weight	Weight of the car, including the driver, all oils, fluids and standard equipment. This does not include passengers, cargo, optional equipment or towball load when there is a trailer connected.
Permitted maximum load	Gross vehicle weight - Kerb weight
Maximum gross vehicle weight	Kerb weight + cargo + passengers

The documented kerb weight applies to cars in the standard version, such as a car without extra equipment or accessories. This means that for every accessory added, the loading capacity of the car is reduced correspondingly by the weight of the accessory.

Weighing the car is a sure way to determine the kerb weight of your own particular car.



Warning

The car's driving characteristics change depending on how heavily it is loaded and how the load is distributed.

Label weights

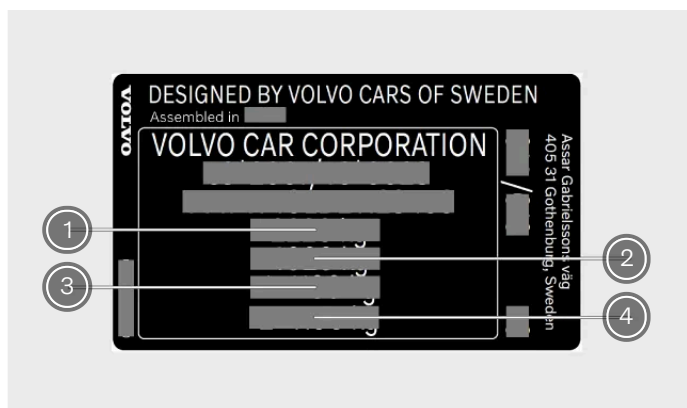

The label is located on the right-hand door pillar and will be visible when the door is opened.

① Maximum gross vehicle weight

The content of this manual represents the status of the user manual at the time of printing and may not be completely valid in future instances. For more information, refer to the first page for the complete disclaimer note.

- ② Maximum train weight (car+trailer)
- ③ Maximum front axle load
- ④ Maximum rear axle load

Maximum load

Maximum load See your car's registration document.

Maximum roof load 75 kg

Note

Labels depicted in this manual are generic representations of those found around your car. The manual only contains their location and what kind of information they hold. Find the actual label for specific information about your car.

15.1.3. Towing specifications and capabilities

Towing weights and towball loads for driving with a trailer can be viewed in the tables.

Important

Always follow local rules and regulations when driving with a trailer, such as speed for the vehicle combination.

Braked trailer

Twin Motor Performance:

Max. trailer weight 1600 kg

Max. towball load 100 kg

Unbraked trailer

Max. trailer weight 750 kg

15.1.4. Towbar specifications

Here you can find measurements related to your towbar.

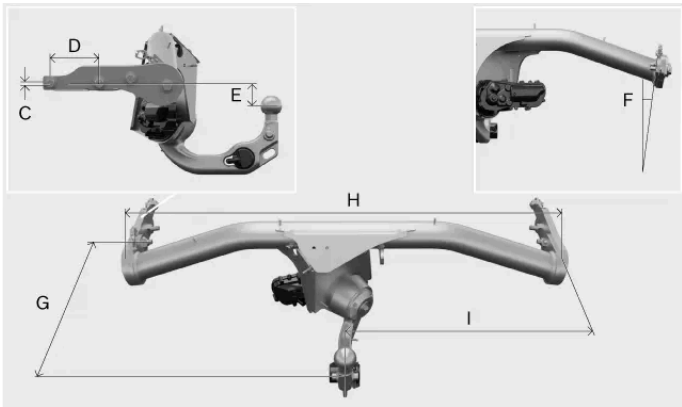
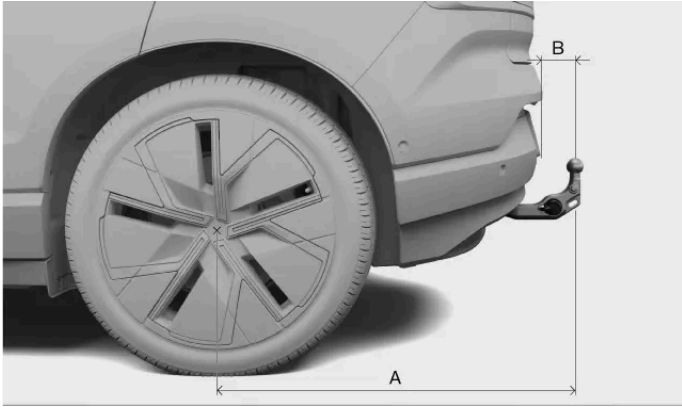

Dimensions, mounting points in millimetres (inches)

A 900.375 (35.447)

B 104.508 (4.114)

C 9.9 (0.389)

D 110 (4.33)

E 52.612 (2.07)

F 8°

G 395 (15.55)

H 1032.726 (40.658)

I 516.363 (20.329)

15.1.5. Type designations

Knowing the car's detailed information can help facilitate contact with a Volvo dealer and when ordering spare parts and accessories.

Product label



The product label is located on the right-hand door pillar and will be visible when the door is opened.



Examples of information you can find on the label:

- Vehicle identification number
- Weight information

Note

Labels depicted in this manual are generic representations of those found around your car. The manual only contains their location and what kind of information they hold. Find the actual label for specific information about your car.

Tip

For many markets, more information can also be found in the car's registration document.

15.2. Powertrain specifications

Find the specifications regarding your car's propulsion.

These specifications provide details about what your car is capable of and certified for. They also specify data on relevant charging cables.

15.2.1. Electric motor specifications

The content of this manual represents the status of the user manual at the time of printing and may not be completely valid in future instances. For more information, refer to the first page for the complete disclaimer note.

Your car is powered by two electric motors (front and rear) and you can find the specifications here.

Twin Motor Performance			
Front	Electric motor type		Synchronous motor with permanent magnet
	Electric motor model		TZ180XSB01
	Max. power output	kW	115
		hp	156
	Rated power (continuous power)		kW N/A
	Max. torque	Nm	200
lb-ft		147	
Rear	Electric motor type		Synchronous motor with permanent magnet
	Electric motor model		TZ220XSA02
	Max. power output	kW	200
		hp	272
	Rated power (continuous power)		kW N/A
	Max. torque	Nm	343
lb-ft		253	
Total car (system)	Max. power output	kW	315
		hp	428
	Rated power (continuous power)		kW N/A
	Max. torque	Nm	543
lb-ft		400	

***i* Note**

If data is missing it will be updated at a later stage.

15.2.2. Performance

You can find the car's top speed and acceleration time in the table below.

Twin Motor Performance

Top speed 180 km/h (112 mph)
Acceleration time 0-100 km/h (0-60 mph) 3.7 seconds (3.5 seconds)

***i* Note**

If data is missing it will be updated at a later stage.

15.2.3. The car's certified values for range and electricity consumption

These are the certified values for your car's range and use of electrical power. However, range and electricity consumption vary according to the circumstances and driving conditions. These values should not be interpreted as an expected range but should primarily be used to compare different cars.

Procedure used to establish the values

The values in the table below are established in accordance with WLTP^[1], which is an international test method performed in a laboratory environment. The method uses drive cycles to simulate an average driving run of the car. Every drive cycle is determined by different conditions such as speed, time and mileage.

The standard is based on four drive cycle profiles with different average speeds:

- Urban driving** Low speed
- Suburban driving** Medium speed
- Extra-urban driving** High speed
- Motorway driving** Extra high speed

Symbol explanation

This is an explanation of the symbols used in the specification table below.



Certified value for the car's potential range (km)^[2].



Urban and suburban driving.



Average value over all four drive cycle phases (urban, suburban, extra-urban and motorway driving).



Certified value for the car's electricity consumption (kWh/100 km). The value is an average over all four drive cycle phases (urban, suburban, extra-urban and motorway driving).





Low value.



High value.

Specifications for range and electricity consumption

Twin Motor Performance			

	18.3	618	436
	19.1	542	417

 **Note**

If data is missing in the table it will be updated at a later date.

Certified values and actual values

When driving, the car's range and electricity consumption can differ from the certified value indications. Some reasons for this may be:

- Driving style.
- Extra equipment and cargo affect the car's weight or air resistance.
- Non-standard wheels can increase rolling resistance and air resistance.
- High speed causes increased air resistance.
- Road, traffic and weather conditions.
- The general condition of the car.

^[1] Worldwide Harmonised Light-Duty Vehicles Test Procedure

^[2] The value should not be interpreted as an expected range. The range is difficult to achieve during normal driving.

15.2.4. Charging cable specifications

These specifications provide details about mode 2 charging cables. Mode 2 charging cables can be purchased from the Volvo Extras shop.

Ambient temperature -30 °C to 40 °C (-22 °F to 104 °F)

Residual-current device

Mode 2 charging cables have a built-in residual-current device that protects the car and the user from electric shocks caused by system faults.

 **Warning**

The residual-current device helps to protect the car's charging system, but there is no guarantee that an overload never occurs.

! Important

The residual-current device does not protect the household socket.

Temperature monitoring

The mode 2 cable is also equipped with a control unit, which has a built-in overtemperature monitoring function. This monitors the temperature of the charging cable.

! Important

Avoid exposing the control unit and its plug connector to direct sunlight. The overheating protection in the plug connector may otherwise reduce or stop the charging of your car.

15.2.5. Charging port labels and identifiers

Your car has a number of identification labels that provide information about charging compatibility. There is also a label with information about the different charging port status on the charging lid.

Charging compatibility identification

You can find out if your car and the charging point are compatible by looking at the identification labels. The labels are given in accordance with the EN 17186 standard. The identification labels include a letter or letters. If a letter on the charging point match a letter on your car's identification labels, it means that they are compatible.



The identification labels are located in the charging port.



Charging compatibility identification labels.

The three identification labels letters indicate the types of charging point your car is compatible with. Your car has three letters defining compatibility. Details can be found in the EN 17186 standard.

Identification label	Charging type
C	AC ^[1] charging type 2
K and L	DC ^[2] charging (including Combined Charging System (CCS) Combo 2)

Charging statuses

The label contains information about the different charging port statuses. The label is shown on the inside of the charging lid.

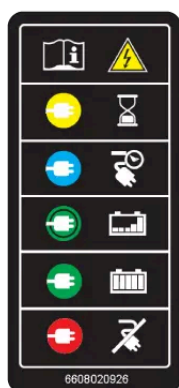

^[1] Alternating current

^[2] Direct current

15.3. Wheel and tyre specifications

Here you can find specific data for wheels and tyres applicable to your car.

Note

There are more recommendations regarding wheels and tyres that are important to be aware of.

15.3.1. Approved tyre pressures

You can find the approved tyre pressures for your car in the table below.

The recommended pressure for factory-fitted tyres can be found on the tyre pressure label. It's located on the door pillar on the driver's side and is visible when the door is opened.

Tyre size	Load 1-3 persons		Max load		ECO pressure Front/rear kPa (psi)
	Front kPa (psi)	Rear kPa (psi)	Front kPa (psi)	Rear kPa (psi)	
235/55 R18 235/50 R19	260 (38)	260 (38)	290 (42)	290 (42)	290 (42)

15.3.2. Approved wheel and tyre sizes

In some countries, approved sizes are not indicated by the car's registration documents. However, you can find all approved combinations of wheel rims and tyres below.

Tyre	Wheel rim
235/55 R18	7,5x18x46
235/50 R19	7,5x19x47

15.3.3. Minimum permitted load index and speed rating for tyres

All tyres have specific speed and load limitations. Tyres must have a speed rating and load index that are equal to or higher than your car's maximum speed.

Your tyre's specification must be at least equal to or greater than:

Minimum permitted load index (LI): 99

The content of this manual represents the status of the user manual at the time of printing and may not be completely valid in future instances. For more information, refer to the first page for the complete disclaimer note.

 **Warning**

If a tyre with a speed rating that is too low is used, it may overheat and become damaged.

 **Note**

Winter tyres

Winter tyres^[1] are allowed to have a lower speed rating than your car's top speed. However, if your winter tyres do have a lower speed rating than your car's top speed, you are not allowed to drive faster than the tyres' speed rating.

^[1] Both studded and stud-free tyres.

15.4. Fluid specifications

Your car has fluids to help different systems function properly. When it is time to refill or perform maintenance, you may need to know the specific data for them.

For some fluids, it is recommended that they are changed or filled by an authorised Volvo workshop. Check this section for the fluid you need information on and, if necessary, contact an authorised Volvo workshop to schedule an appointment.

15.4.1. Brake fluid specifications

The medium in your car's brake system is called brake fluid.

Prescribed grade Volvo Original or equivalent brake fluid that fulfils a combination of the Dot 4, 5.1 and ISO 4925 class 6 classifications.

 **Important**

It is recommended that brake fluid is changed or filled by an authorised Volvo workshop.

15.4.2. Climate system specifications

Here you find the information about the refrigerant quantity and the prescribed quality and volume for compressor oil.

Climate system label



The label with information on climate system fluids is located under the bonnet, on the right-hand side of the car.

On this label you can find:

- Refrigerant type (R1234yf)
- Refrigerant quantity

Label symbols



Caution



A trained and certified technician is required to service the mobile air conditioning system^[1]



Flammable refrigerants



Mobile air conditioning system^[1]



Lubricant type

Compressor oil

Volume 260 ml (8.79 US fl oz) (9.15 UK fl oz)

Prescribed grade PVE FVC56EA

Servicing and repair of the climate system

Warning

Servicing and repair

The climate system contains pressurised refrigerant. The climate system must only be serviced and repaired by trained and certified technicians in order to ensure the safety of the system^[2]. Volvo recommends an authorised Volvo workshop for any repair or service needs.

! Important

Repairing the evaporator

The climate system's evaporator must never be repaired or replaced with a previously used evaporator. A new evaporator must be certified and labelled in accordance with SAE J2842.

[1] MAC

[2] In accordance with SAE J2845 (Technician Training for Safe Service and Containment of Refrigerants Used in Mobile A/C System).

15.5. Certificates and type approvals

This documentation shows that your car meets certain standards and specifications.

User manuals are required by law to provide documentation of certain certificates and type approvals.

For more information, contact Volvo support.

15.5.1. Detailed child restraint information

The table provides detailed information for manufacturers of child restraint systems regarding which locations in the car are appropriate for different kinds of child restraints.

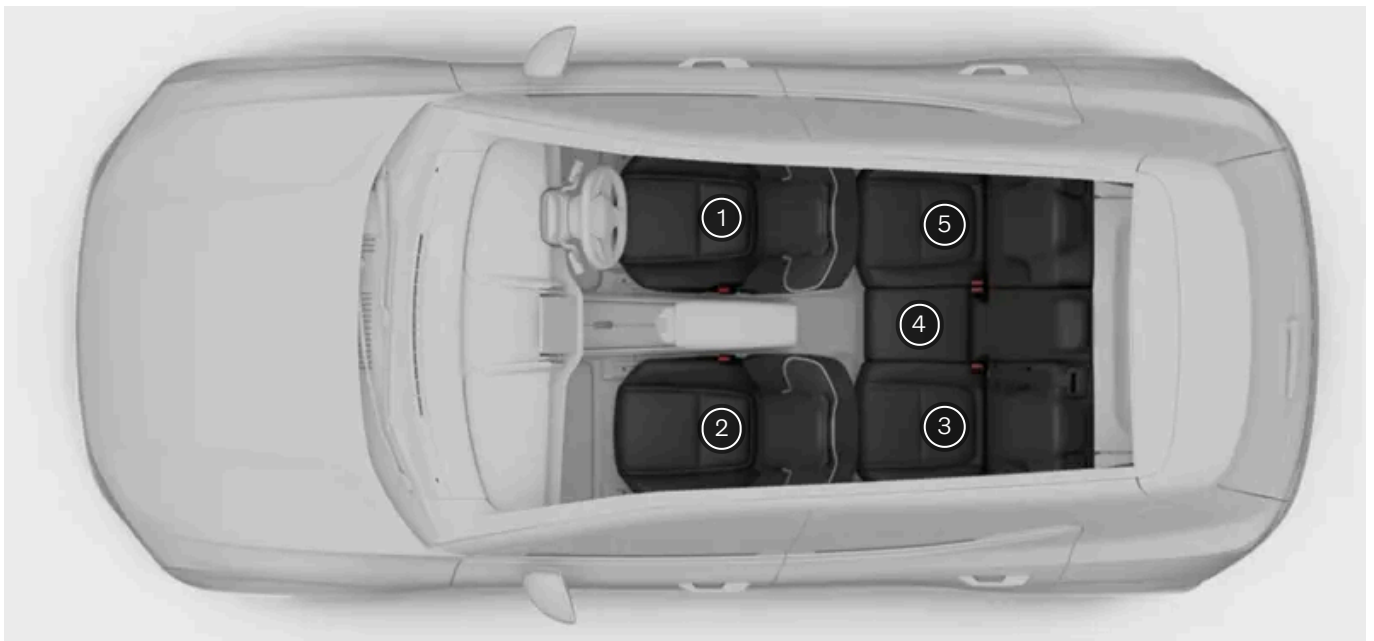

Seat position ^[1]	1	2 (with disabled airbag, only rearward-facing child restraints) ^[2]	2 (with enabled airbag, only forward-facing child restraints) ^[2]	3	4	5
Seat position suitable for universal category restraints which are attached using the car's seatbelt (Yes/No)	No	Yes ^[3]	Yes ^[3]	Yes	Yes	Yes
Seat position for i-Size (Yes/No)	No	No	No	Yes	No	Yes
Seat position lateral fixture (L1/L2/No)	No	No	No	No	No	No
Largest suitable rearward-facing fixture (R1/R2/R3/No)	No	No	No	R3 ^[4]	No	R3 ^[5]
Largest suitable forward-facing fixture (F2/F2x/F3/No)	No	No	No	F3	No	F3
Largest suitable booster fixture (B2/B3/No)	No	No	B3	B3	No	B3

^[1] According to illustration.

^[2] The seat cushion extension must always be retracted when installing child restraints.

^[3] Adjust the backrest to a more upright position when necessary.



^[4] Adjust height of seat in front if necessary to get enough space for installation.

^[5] Adjust height or position of seat in front if necessary to get enough space for installation.

15.5.2. Radar type approvals

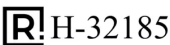

Find the radar type approval you're looking for among the ones listed here.

Front centre radar



Regions	Labels and symbols	Specification
Argentina		
Brazil		Este equipamento não tem direito à proteção contra interferência prejudicial e não pode causar interferência em sistemas devidamente autorizados

Regions	Labels and symbols	Specification
Canada		<p>This device contains license-exempt transmitter(s)/receiver(s) that comply with Innovation, Science and Economic Development Canada's licence-exempt RSS(s).</p> <p>Operation is subject to the following two conditions:</p> <p>(1) This device may not cause interference.</p> <p>(2) This device must accept any interference, including interference that may cause undesired operation of the device.</p> <p>Le présent appareil est conforme aux CNR d'Industrie Canada applicables aux appareils radio exempts de licence.</p> <p>L'exploitation est autorisée aux deux conditions suivantes:</p> <p>(1) l'appareil ne doit pas produire de brouillage, et</p> <p>(2) l'utilisateur de l'appareil doit accepter tout brouillage radioélectrique subi, même si le brouillage est susceptible d'en compromettre le fonctionnement.</p>
European Union & EFTA		<p>Simplified EU declaration of conformity.</p> <p>English</p> <p>Hereby, Veoneer US, Inc. declares that the radio equipment type 77V12FLR is in compliance with Directive 2014/53/EU. The full text of the EU declaration of conformity is available at the following internet address: https://www.magna.com/type-approval/76-77-ghz/77v12flr [https://www.magna.com/type-approval/76-77-ghz/77v12flr]</p> <p>Operational frequency band: 76 – 77 GHz/ Maximum output power:<55 dBm peak eirp</p> <p>Bulgarian</p> <p>С настоящото Veoneer US, Inc. декларира, че този тип радиосъоръжение 77V12FLR е в съответствие с Директива 2014/53/ЕС. Цялостният текст на ЕС декларацията за съответствие може да се намери на следния интернет адрес: https://www.magna.com/type-approval/76-77-ghz/77v12flr [https://www.magna.com/type-approval/76-77-ghz/77v12flr]</p> <p>Работна честотна лента: 76 – 77 GHz/ Максимална изходна мощност:<55 dBm peak eirp</p> <p>Croatian</p> <p>Veoneer US, Inc. ovime izjavljuje da je radijska oprema tipa 77V12FLR u skladu s Direktivom 2014/53/EU. Cjeloviti tekst EU izjave o sukladnosti dostupan je na sljedećoj internetskoj adresi: https://www.magna.com/type-approval/76-77-ghz/77v12flr [https://www.magna.com/type-approval/76-77-ghz/77v12flr]</p> <p>Radni frekvencijski pojas: 76 – 77 GHz/ Maksimalna izlazna snaga:<55 dBm peak eirp</p> <p>Czech</p> <p>Tímto Veoneer US, Inc. prohlašuje, že typ rádiového zařízení 77V12FLR je v souladu se směrnicí 2014/53/EU. Úplné znění EU prohlášení o shodě je k dispozici na této internetové adrese: https://www.magna.com/type-approval/76-77-ghz/77v12flr [https://www.magna.com/type-approval/76-77-ghz/77v12flr]</p> <p>Provozní kmitočtové pásmo: 76 – 77 GHz/ Nejvyšší výstupní výkon:<55 dBm peak eirp</p> <p>Danish</p> <p>Hermed erklærer Veoneer US, Inc., at radioudstyrstypen 77V12FLR er i overensstemmelse med direktiv 2014/53/EU. EU-overensstemmelseserklæringens fulde tekst kan findes på følgende internetadresse: https://www.magna.com/type-approval/76-77-ghz/77v12flr [https://www.magna.com/type-approval/76-77-ghz/77v12flr]</p> <p>Driftsfrekvensområde: 76 – 77 GHz/ Maksimal udgangseffekt:<55 dBm peak eirp</p> <p>Dutch</p> <p>Hierbij verklaar ik, Veoneer US, Inc., dat het type radioapparatuur 77V12FLR conform is met Richtlijn 2014/53/EU. De volledige tekst van de EU-conformiteitsverklaring kan worden geraadpleegd op het volgende internetadres: https://www.magna.com/type-approval/76-77-ghz/77v12flr [https://www.magna.com/type-approval/76-77-ghz/77v12flr]</p> <p>Operationele frequentieband: 76 – 77 GHz/ Maximaal uitgangsvermogen:<55 dBm peak eirp</p> <p>Estonian</p> <p>Käesolevaga deklareerib Veoneer US, Inc., et käesolev raadioseadme tüüp 77V12FLR vastab direktiivi 2014/53/EL nõuetele. ELi vastavusdeklaratsiooni täielik tekst on kättesaadav järgmisel internetiaadressil: https://www.magna.com/type-approval/76-77-ghz/77v12flr [https://www.magna.com/type-approval/76-77-ghz/77v12flr]</p> <p>Töösagedusriba: 76 – 77 GHz/ Maksimalne väljundvõimsus:<55 dBm peak eirp</p> <p>Finnish</p> <p>Veoneer US, Inc. vakuuttaa, että radiolaitetyyppi 77V12FLR on direktiivin 2014/53/EU mukainen. EU-vaatimustenmukaisuusvakuutuksen täysimittainen teksti on saatavilla seuraavassa internetosoitteessa: https://www.magna.com/type-approval/76-77-ghz/77v12flr [https://www.magna.com/type-approval/76-77-ghz/77v12flr]</p> <p>Käyttöraajuusalue: 76 – 77 GHz/ Enimmäislähtöteho:<55 dBm peak eirp</p> <p>French</p> <p>Le soussigné, Veoneer US, Inc., déclare que l'équipement radioélectrique du type 77V12FLR est conforme à la directive 2014/53/UE. Le texte complet de la déclaration UE de conformité est disponible à l'adresse internet suivante: https://www.magna.com/type-approval/76-77-ghz/77v12flr [https://www.magna.com/type-approval/76-77-ghz/77v12flr]</p> <p>Bande de fréquences opérationnelle: 76 – 77 GHz/ Puissance de sortie max:<55 dBm peak eirp</p> <p>German</p> <p>Hiermit erklärt Veoneer US, Inc., dass der Funkanlagentyp 77V12FLR der Richtlinie 2014/53/EU entspricht. Der vollständige Text der EU-Konformitätserklärung ist unter der folgenden Internetadresse verfügbar: https://www.magna.com/type-approval/76-77-ghz/77v12flr [https://www.magna.com/type-approval/76-77-ghz/77v12flr]</p> <p>Betriebsfrequenzband: 76 – 77 GHz/ Maximale Ausgangsleistung:<55 dBm peak eirp</p> <p>Greek</p> <p>Με την παρούσα ο/η Veoneer US, Inc., δηλώνει ότι ο ραδιοεξοπλισμός 77V12FLR πληροί την οδηγία 2014/53/ΕΕ. Το πλήρες κείμενο της δήλωσης συμμόρφωσης ΕΕ διατίθεται στην ακόλουθη ιστοσελίδα στο διαδίκτυο: https://www.magna.com/type-approval/76-77-ghz/77v12flr [https://www.magna.com/type-approval/76-77-ghz/77v12flr]</p> <p>Ζώνη συχνότητας λειτουργίας: 76 – 77 GHz/ Μέγιστη Ισχύς Εξόδου:<55 dBm peak eirp</p>

Regions	Labels and symbols	Specification
		<p>Hungarian</p> <p>Veoneer US, Inc. igazolja, hogy a 77V12FLR típusú rádióberendezés megfelel a 2014/53/EU irányelvnek. Az EU-megfelelőségi nyilatkozat teljes szövege elérhető a következő internetes címen: https://www.magna.com/type-approval/76-77-ghz/77v12flr [https://www.magna.com/type-approval/76-77-ghz/77v12flr]</p> <p>Működési frekvenciasáv: 76 – 77 GHz/ Maximum kimeneti teljesítmény:<55 dBm peak eirp</p> <p>Icelandic</p> <p>Í þessu sambandi lýsir Veoneer US, Inc. að búnaður útværpsbúnaðarins 77V12FLR sé í samræmi við tilskipun 2014/53/EU. Fullkominn texti EU yfirlýsing um samræmi er að finna á eftirfarandi netfangi: https://www.magna.com/type-approval/76-77-ghz/77v12flr [https://www.magna.com/type-approval/76-77-ghz/77v12flr]</p> <p>Rekstrar tíðnisvið: 76 – 77 GHz/ Hámarks útgangsstyrkur:<55 dBm peak eirp</p> <p>Italian</p> <p>Il fabbricante, Veoneer US, Inc., dichiara che il tipo di apparecchiatura radio 77V12FLR è conforme alla direttiva 2014/53/UE. Il testo completo della dichiarazione di conformità UE è disponibile al seguente indirizzo Internet: https://www.magna.com/type-approval/76-77-ghz/77v12flr [https://www.magna.com/type-approval/76-77-ghz/77v12flr]</p> <p>Banda di frequenza operativa: 76 – 77 GHz/ Massima potenza di uscita:<55 dBm peak eirp</p> <p>Latvian</p> <p>Ar šo Veoneer US, Inc. deklarē, ka radioiekārta 77V12FLR atbilst Direktīvai 2014/53/ES. Pilns ES atbilstības deklarācijas teksts ir pieejams šādā interneta vietnē: https://www.magna.com/type-approval/76-77-ghz/77v12flr [https://www.magna.com/type-approval/76-77-ghz/77v12flr]</p> <p>Darba frekvenču josla: 76 – 77 GHz/ Maksimālā izejas jauda:<55 dBm peak eirp</p> <p>Lithuanian</p> <p>Aš, Veoneer US, Inc., patvirtinu, kad radijo įrenginių tipas 77V12FLR atitinka Direktyvą 2014/53/ES. Visas ES atitikties deklaracijos tekstas prieinamas šiuo interneto adresu: https://www.magna.com/type-approval/76-77-ghz/77v12flr [https://www.magna.com/type-approval/76-77-ghz/77v12flr]</p> <p>Darbiniių dažnių diapazonas: 76 – 77 GHz/ Maksimali išėjimo galia:<55 dBm peak eirp</p> <p>Maltese</p> <p>B'dan, Veoneer US, Inc., niddikjara li dan it-tip ta' tagħmir tar-radju 77V12FLR huwa konformi mad-Direttiva 2014/53/UE. It-test kollu tad-dikjarazzjoni ta' konformità tal-UE huwa disponibbli f'dan l-indirizz tal-Internet li ġej: https://www.magna.com/type-approval/76-77-ghz/77v12flr [https://www.magna.com/type-approval/76-77-ghz/77v12flr]</p> <p>Il-banda tal-frekwenzi operattivi: 76 – 77 GHz/ L-Energija Massima Maħruġa:<55 dBm peak eirp</p> <p>Norwegian</p> <p>Hermed erklærer Veoneer US, Inc. at radioutstyrtypen 77V12FLR er i samsvar med direktiv 2014/53/EU. Den fulle teksten til EU-samsvarserklæringen er tilgjengelig på følgende internetadresse: https://www.magna.com/type-approval/76-77-ghz/77v12flr [https://www.magna.com/type-approval/76-77-ghz/77v12flr]</p> <p>Operasjonelt frekvensbånd: 76 – 77 GHz/ Maksimal utgangseffekt:<55 dBm peak eirp</p> <p>Polish</p> <p>Veoneer US, Inc. niniejszym oświadcza, że typ urządzenia radiowego 77V12FLR jest zgodny z dyrektywą 2014/53/UE. Pełny tekst deklaracji zgodności UE jest dostępny pod następującym adresem internetowym: https://www.magna.com/type-approval/76-77-ghz/77v12flr [https://www.magna.com/type-approval/76-77-ghz/77v12flr]</p> <p>Pasma częstotliwości roboczej: 76 – 77 GHz/ Maksymalna moc wyjściowa:<55 dBm peak eirp</p> <p>Portuguese</p> <p>O(a) abaixo assinado(a) Veoneer US, Inc. declara que o presente tipo de equipamento de rádio 77V12FLR está em conformidade com a Diretiva 2014/53/UE. O texto integral da declaração de conformidade está disponível no seguinte endereço de Internet: https://www.magna.com/type-approval/76-77-ghz/77v12flr [https://www.magna.com/type-approval/76-77-ghz/77v12flr]</p> <p>Faixa de frequência de funcionamento:76 - 77 GHz/ Potência de Saída Máxima:<55 dBm peak eirp</p> <p>Romanian</p> <p>Prin prezenta, Veoneer US, Inc. declară că tipul de echipamente radio 77V12FLR este în conformitate cu Directiva 2014/53/UE. Textul integral al declarației UE de conformitate este disponibil la următoarea adresă internet: https://www.magna.com/type-approval/76-77-ghz/77v12flr [https://www.magna.com/type-approval/76-77-ghz/77v12flr]</p> <p>Bandă frecvență operațională: 76 – 77 GHz/ Putere maximă la ieșire:<55 dBm peak eirp</p> <p>Slovenian</p> <p>Veoneer US, Inc. potrjuje, da je tip radijske opreme 77V12FLR skladen z Direktivo 2014/53/EU. Celotno besedilo izjave EU o skladnosti je na voljo na naslednjem spletnem naslovu: https://www.magna.com/type-approval/76-77-ghz/77v12flr [https://www.magna.com/type-approval/76-77-ghz/77v12flr]</p> <p>Operativni frekvenčni pas: 76 – 77 GHz/ Največja izhodna moč:<55 dBm peak eirp</p> <p>Slovak</p> <p>Veoneer US, Inc. týmto vyhlasuje, že rádiové zariadenie typu 77V12FLR je v súlade so smernicou 2014/53/EÚ. Úplné EÚ vyhlásenie o zhode je k dispozícii na tejto internetovej adrese: https://www.magna.com/type-approval/76-77-ghz/77v12flr [https://www.magna.com/type-approval/76-77-ghz/77v12flr]</p> <p>Prevádzkové frekvenčné pásmo: 76 – 77 GHz/ Maximálny výstupný výkon:<55 dBm peak eirp</p> <p>Spanish</p> <p>Por la presente, Veoneer US, Inc. declara que el tipo de equipo radioeléctrico 77V12FLR es conforme con la Directiva 2014/53/UE. El texto completo de la declaración UE de conformidad está disponible en la dirección Internet siguiente: https://www.magna.com/type-approval/76-77-ghz/77v12flr [https://www.magna.com/type-approval/76-77-ghz/77v12flr]</p> <p>Banda de frecuencias de funcionamiento: 76 – 77 GHz/ Potencia máxima de salida:<55 dBm peak eirp</p> <p>Swedish</p>

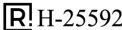

Regions	Labels and symbols	Specification
Thailand		<p>1) [Placeholder text]</p> <p>2) [Placeholder text]</p>
Ukraine		<p>справжнім Veoneer заявляє, що тип радіобладнання (77V12FLR) відповідає Технічному регламенту радіобладнання; повний текст декларації про відповідність доступний на веб-сайті за такою адресою: https://www.magna.com/type-approval/76-77-ghz/77v12flr [https://www.magna.com/type-approval/76-77-ghz/77v12flr]</p>
United Kingdom		<p>Hereby, Veoneer US, Inc. declares that the radio equipment type 77V12FLR is in compliance with radio regulation 2017. Operational frequency band: 76 – 77 GHz/ Maximum output power:<55 dBm peak e.i.r.p</p> <p>The full text of the UK declaration of conformity is available at the following internet address: https://www.magna.com/type-approval/76-77-ghz/77v12flr [https://www.magna.com/type-approval/76-77-ghz/77v12flr]</p>
United States		<p>This device complies with Part 15 of the FCC Rules. Operation is subject to the following two conditions:</p> <p>(1) this device may not cause harmful interference, and</p> <p>(2) this device must accept any interference received, including interference that may cause undesired operation.</p> <p>CAUTION TO USERS</p> <p>Changes or modifications not expressly approved by the party responsible for compliance could void the user's authority to operate the equipment.</p>

Corner radars

Regions	Labels and symbols	Specification
Argentina		
Brazil		<p>Este equipamento não tem direito à proteção contra interferência prejudicial e não pode causar interferência em sistemas devidamente autorizados</p>

Regions	Labels and symbols	Specification
Canada		<p>This device contains license-exempt transmitter(s)/receiver(s) that comply with Innovation, Science and Economic Development Canada's licence-exempt RSS(s).</p> <p>Operation is subject to the following two conditions:</p> <p>(1) This device may not cause interference.</p> <p>(2) This device must accept any interference, including interference that may cause undesired operation of the device.</p> <p>Le présent appareil est conforme aux CNR d'Industrie Canada applicables aux appareils radio exempts de licence.</p> <p>L'exploitation est autorisée aux deux conditions suivantes:</p> <p>(1) l'appareil ne doit pas produire de brouillage, et</p> <p>(2) l'utilisateur de l'appareil doit accepter tout brouillage radioélectrique subi, même si le brouillage est susceptible d'en compromettre le fonctionnement.</p>
European Union & EFTA		<p>Simplified EU declaration of conformity.</p> <p>English</p> <p>Hereby, Veoneer US, Inc. declares that the radio equipment type 7713CRN is in compliance with Directive 2014/53/EU. The full text of the EU declaration of conformity is available at the following internet address: https://www.magna.com/type-approval/76-77-ghz/77v12flr [https://www.magna.com/type-approval/76-77-ghz/77v12flr]</p> <p>Operational frequency band: 76 – 77 GHz/ Maximum output power:<55 dBm peak eirp</p> <p>Bulgarian</p> <p>С настоящото Veoneer US, Inc. декларира, че този тип радиосъоръжение 7713CRN е в съответствие с Директива 2014/53/ЕС. Цялостният текст на ЕС декларацията за съответствие може да се намери на следния интернет адрес: https://www.magna.com/type-approval/76-77-ghz/77v12flr [https://www.magna.com/type-approval/76-77-ghz/77v12flr]</p> <p>Работна честотна лента: 76 – 77 GHz/ Максимална изходна мощност:<55 dBm peak eirp</p> <p>Croatian</p> <p>Veoneer US, Inc. ovime izjavljuje da je radijska oprema tipa 7713CRN u skladu s Direktivom 2014/53/EU. Cjeloviti tekst EU izjave o sukladnosti dostupan je na sljedećoj internetskoj adresi: https://www.magna.com/type-approval/76-77-ghz/77v12flr [https://www.magna.com/type-approval/76-77-ghz/77v12flr]</p> <p>Radni frekvencijski pojas: 76 – 77 GHz/ Maksimalna izlazna snaga:<55 dBm peak eirp</p> <p>Czech</p> <p>Tímto Veoneer US, Inc. prohlašuje, že typ rádiového zařízení 7713CRN je v souladu se směrnicí 2014/53/EU. Úplné znění EU prohlášení o shodě je k dispozici na této internetové adrese: https://www.magna.com/type-approval/76-77-ghz/77v12flr [https://www.magna.com/type-approval/76-77-ghz/77v12flr]</p> <p>Provozní kmitočtové pásmo: 76 – 77 GHz/ Nejvyšší výstupní výkon:<55 dBm peak eirp</p> <p>Danish</p> <p>Hermed erklærer Veoneer US, Inc., at radioudstyrstypen 7713CRN er i overensstemmelse med direktiv 2014/53/EU. EU-overensstemmelseserklæringens fulde tekst kan findes på følgende internetadresse: https://www.magna.com/type-approval/76-77-ghz/77v12flr [https://www.magna.com/type-approval/76-77-ghz/77v12flr]</p> <p>Driftsfrekvensområde: 76 – 77 GHz/ Maksimal udgangseffekt:<55 dBm peak eirp</p> <p>Dutch</p> <p>Hierbij verklaar ik, Veoneer US, Inc., dat het type radioapparatuur 7713CRN conform is met Richtlijn 2014/53/EU. De volledige tekst van de EU-conformiteitsverklaring kan worden geraadpleegd op het volgende internetadres: https://www.magna.com/type-approval/76-77-ghz/77v12flr [https://www.magna.com/type-approval/76-77-ghz/77v12flr]</p> <p>Operationele frequentieband: 76 – 77 GHz/ Maximaal uitgangsvermogen:<55 dBm peak eirp</p> <p>Estonian</p> <p>Käesolevaga deklareerib Veoneer US, Inc., et käesolev raadioseadme tüüp 7713CRN vastab direktiivi 2014/53/EL nõuetele. ELi vastavusdeklaratsiooni täielik tekst on kättesaadav järgmisel internetiaadressil: https://www.magna.com/type-approval/76-77-ghz/77v12flr [https://www.magna.com/type-approval/76-77-ghz/77v12flr]</p> <p>Töösagedusriba: 76 – 77 GHz/ Maksimalne väljundvõimsus:<55 dBm peak eirp</p> <p>Finnish</p> <p>Veoneer US, Inc. vakuuttaa, että radiolaitetyyppi 7713CRN on direktiivin 2014/53/EU mukainen. EU-vaatimustenmukaisuusvakuutuksen täysimittainen teksti on saatavilla seuraavassa internetosoitteessa: https://www.magna.com/type-approval/76-77-ghz/77v12flr [https://www.magna.com/type-approval/76-77-ghz/77v12flr]</p> <p>Käyttöraajuusalue: 76 – 77 GHz/ Enimmäislähtöteho:<55 dBm peak eirp</p> <p>French</p> <p>Le soussigné, Veoneer US, Inc., déclare que l'équipement radioélectrique du type 7713CRN est conforme à la directive 2014/53/UE. Le texte complet de la déclaration UE de conformité est disponible à l'adresse internet suivante: https://www.magna.com/type-approval/76-77-ghz/77v12flr [https://www.magna.com/type-approval/76-77-ghz/77v12flr]</p> <p>Bande de fréquences opérationnelle: 76 – 77 GHz/ Puissance de sortie max:<55 dBm peak eirp</p> <p>German</p> <p>Hiermit erklärt Veoneer US, Inc., dass der Funkanlagentyp 7713CRN der Richtlinie 2014/53/EU entspricht. Der vollständige Text der EU-Konformitätserklärung ist unter der folgenden Internetadresse verfügbar: https://www.magna.com/type-approval/76-77-ghz/77v12flr [https://www.magna.com/type-approval/76-77-ghz/77v12flr]</p> <p>Betriebsfrequenzband: 76 – 77 GHz/ Maximale Ausgangsleistung:<55 dBm peak eirp</p> <p>Greek</p> <p>Με την παρούσα ο/η Veoneer US, Inc., δηλώνει ότι ο ραδιοεξοπλισμός 7713CRN πληροί την οδηγία 2014/53/ΕΕ. Το πλήρες κείμενο της δήλωσης συμμόρφωσης ΕΕ διατίθεται στην ακόλουθη ιστοσελίδα στο διαδίκτυο: https://www.magna.com/type-approval/76-77-ghz/77v12flr [https://www.magna.com/type-approval/76-77-ghz/77v12flr]</p> <p>Ζώνη συχνότητας λειτουργίας: 76 – 77 GHz/ Μέγιστη Ισχύς Εξόδου:<55 dBm peak eirp</p>







Regions	Labels and symbols	Specification
		<p>Hungarian</p> <p>Veoneer US, Inc. igazolja, hogy a 7713CRN típusú rádióberendezés megfelel a 2014/53/EU irányelvnek. Az EU-megfelelőségi nyilatkozat teljes szövege elérhető a következő internetes címen: https://www.magna.com/type-approval/76-77-gHz/77v12flr [https://www.magna.com/type-approval/76-77-gHz/77v12flr]</p> <p>Működési frekvenciasáv: 76 – 77 GHz/ Maximum kimeneti teljesítmény:<55 dBm peak eirp</p> <p>Icelandic</p> <p>Í þessu sambandi lýsir Veoneer US, Inc. að búnaður útvarpsbúnaðarins 7713CRN sé í samræmi við tilskipun 2014/53/EU. Fullkominn texti EU yfirlýsing um samræmi er að finna á eftirfarandi netfangi: https://www.magna.com/type-approval/76-77-gHz/77v12flr [https://www.magna.com/type-approval/76-77-gHz/77v12flr]</p> <p>Rekstrar tíðnisvið: 76 – 77 GHz/ Hámarks útgangsstyrkur:<55 dBm peak eirp</p> <p>Italian</p> <p>Il fabbricante, Veoneer US, Inc., dichiara che il tipo di apparecchiatura radio 7713CRN è conforme alla direttiva 2014/53/UE. Il testo completo della dichiarazione di conformità UE è disponibile al seguente indirizzo Internet: https://www.magna.com/type-approval/76-77-gHz/77v12flr [https://www.magna.com/type-approval/76-77-gHz/77v12flr]</p> <p>Banda di frequenza operativa: 76 – 77 GHz/ Massima potenza di uscita:<55 dBm peak eirp</p> <p>Latvian</p> <p>Ar šo Veoneer US, Inc. deklarē, ka radioiekārta 7713CRN atbilst Direktīvai 2014/53/ES. Pilns ES atbilstības deklarācijas teksts ir pieejams šādā interneta vietnē: https://www.magna.com/type-approval/76-77-gHz/77v12flr [https://www.magna.com/type-approval/76-77-gHz/77v12flr]</p> <p>Darba frekvenču josla: 76 – 77 GHz/ Maksimālā izejas jauda:<55 dBm peak eirp</p> <p>Lithuanian</p> <p>Aš, Veoneer US, Inc., patvirtinu, kad radijo įrenginių tipas 7713CRN atitinka Direktyvą 2014/53/ES. Visas ES atitikties deklaracijos tekstas prieinamas šiuo interneto adresu: https://www.magna.com/type-approval/76-77-gHz/77v12flr [https://www.magna.com/type-approval/76-77-gHz/77v12flr]</p> <p>Darbinių dažnių diapazonas: 76 – 77 GHz/ Maksimali išėjimo galia:<55 dBm peak eirp</p> <p>Maltese</p> <p>B'dan, Veoneer US, Inc., niddikjara li dan it-tip ta' tagħmir tar-radju 7713CRN huwa konformi mad-Direttiva 2014/53/UE. It-test kollu tad-dikjarazzjoni ta' konformità tal-UE huwa disponibbli f'dan l-indirizz tal-Internet li ġej: https://www.magna.com/type-approval/76-77-gHz/77v12flr [https://www.magna.com/type-approval/76-77-gHz/77v12flr]</p> <p>Il-banda tal-frekwenzi operattivi: 76 – 77 GHz/ L-Energija Massima Maħruġa:<55 dBm peak eirp</p> <p>Norwegian</p> <p>Hermed erklærer Veoneer US, Inc. at radioutstyrtypen 7713CRN er i samsvar med direktiv 2014/53/EU. Den fulle teksten til EU-samsvarserklæringen er tilgjengelig på følgende internetadresse: https://www.magna.com/type-approval/76-77-gHz/77v12flr [https://www.magna.com/type-approval/76-77-gHz/77v12flr]</p> <p>Operasjonelt frekvensbånd: 76 – 77 GHz/ Maksimal utgangseffekt:<55 dBm peak eirp</p> <p>Polish</p> <p>Veoneer US, Inc. niniejszym oświadcza, że typ urządzenia radiowego 7713CRN jest zgodny z dyrektywą 2014/53/UE. Pełny tekst deklaracji zgodności UE jest dostępny pod następującym adresem internetowym: https://www.magna.com/type-approval/76-77-gHz/77v12flr [https://www.magna.com/type-approval/76-77-gHz/77v12flr]</p> <p>Pasma częstotliwości roboczej: 76 – 77 GHz/ Maksymalna moc wyjściowa:<55 dBm peak eirp</p> <p>Portuguese</p> <p>O(a) abaixo assinado(a) Veoneer US, Inc. declara que o presente tipo de equipamento de rádio 7713CRN está em conformidade com a Diretiva 2014/53/UE. O texto integral da declaração de conformidade está disponível no seguinte endereço de Internet: https://www.magna.com/type-approval/76-77-gHz/77v12flr [https://www.magna.com/type-approval/76-77-gHz/77v12flr]</p> <p>Faixa de frequência de funcionamento: 76 - 77 GHz/ Potência de Saída Máxima:<55 dBm peak eirp</p> <p>Romanian</p> <p>Prin prezenta, Veoneer US, Inc. declară că tipul de echipamente radio 7713CRN este în conformitate cu Directiva 2014/53/UE. Textul integral al declarației UE de conformitate este disponibil la următoarea adresă internet: https://www.magna.com/type-approval/76-77-gHz/77v12flr [https://www.magna.com/type-approval/76-77-gHz/77v12flr]</p> <p>Bandă frecvență operațională: 76 – 77 GHz/ Putere maximă la ieșire:<55 dBm peak eirp</p> <p>Slovenian</p> <p>Veoneer US, Inc. potrjuje, da je tip radijske opreme 7713CRN skladen z Direktivo 2014/53/EU. Celotno besedilo izjave EU o skladnosti je na voljo na naslednjem spletnem naslovu: https://www.magna.com/type-approval/76-77-gHz/77v12flr [https://www.magna.com/type-approval/76-77-gHz/77v12flr]</p> <p>Operativni frekvenčni pas: 76 – 77 GHz/ Največja izhodna moč:<55 dBm peak eirp</p> <p>Slovak</p> <p>Veoneer US, Inc. týmto vyhlasuje, že rádiové zariadenie typu 7713CRN je v súlade so smernicou 2014/53/EÚ. Úplné EÚ vyhlásenie o zhode je k dispozícii na tejto internetovej adrese: https://www.magna.com/type-approval/76-77-gHz/77v12flr [https://www.magna.com/type-approval/76-77-gHz/77v12flr]</p> <p>Prevádzkové frekvenčné pásmo: 76 – 77 GHz/ Maximálny výstupný výkon:<55 dBm peak eirp</p> <p>Spanish</p> <p>Por la presente, Veoneer US, Inc. declara que el tipo de equipo radioeléctrico 7713CRN es conforme con la Directiva 2014/53/UE. El texto completo de la declaración UE de conformidad está disponible en la dirección Internet siguiente: https://www.magna.com/type-approval/76-77-gHz/77v12flr [https://www.magna.com/type-approval/76-77-gHz/77v12flr]</p> <p>Banda de frecuencias de funcionamiento: 76 – 77 GHz/ Potencia máxima de salida:<55 dBm peak eirp</p> <p>Swedish</p>

Regions	Labels and symbols	Specification
Thailand		<p>1) [Placeholder text]</p> <p>2) [Placeholder text]</p>
Ukraine		<p>справжнім Veoneer заявляє, що тип радіобладнання (7713CRN) відповідає Технічному регламенту радіобладнання; повний текст декларації про відповідність доступний на веб-сайті за такою адресою: https://www.magna.com/type-approval/76-77-ghz/77v12flr [https://www.magna.com/type-approval/76-77-ghz/77v12flr]</p>
United Kingdom		<p>Hereby, Veoneer US, Inc. declares that the radio equipment type 7713CRN is in compliance with radio regulation 2017. Operational frequency band: 76 – 77 GHz/ Maximum output power: <55 dBm peak e.i.r.p The full text of the UK declaration of conformity is available at the following internet address: https://www.magna.com/type-approval/76-77-ghz/77v12flr [https://www.magna.com/type-approval/76-77-ghz/77v12flr]</p>
United States		<p>This device complies with Part 15 of the FCC Rules. Operation is subject to the following two conditions:</p> <p>(1) this device may not cause harmful interference, and</p> <p>(2) this device must accept any interference received, including interference that may cause undesired operation.</p> <p>CAUTION TO USERS</p> <p>Changes or modifications not expressly approved by the party responsible for compliance could void the user's authority to operate the equipment.</p>

15.5.3. Type approval for TPMS radio frequency

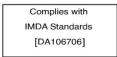
Here you find the radio frequency type approvals for the tyre pressure monitoring system.

Region	Specification
Argentina	
Canada	<p>ISED Regulatory Compliance Statements</p> <p>This device contains licence-exempt that comply with Innovation, Science and Economic Development Canada's licence-exempt RSS(s). Operation is subject to the following two conditions:</p> <ol style="list-style-type: none"> 1. This device may not cause interference. 2. This device must accept any interference, including interference that may cause undesired operation of the device. <p>This equipment complies with ISED RSS-102 radio frequency exposure limits set forth by the Innovation, Science and Economic Development Canada for an uncontrolled environment. The further RF exposure reduction can be achieved if the product can be kept as far as possible from the user body or set the device to lower output power if such function available. This device must not be co-located or operating in conjunction with any other antenna or transmitter.</p> <p>Déclaration de conformité avec la réglementation d'ISDE</p> <p>Le présent appareil est conforme aux CNR d'Industrie Canada applicables aux appareils radio exempts de licence. L'exploitation est autorisée aux deux conditions suivantes:</p> <ol style="list-style-type: none"> 1. l'appareil ne doit pas produire de brouillage, et 2. l'utilisateur de l'appareil doit accepter tout brouillage radioélectrique subi, même si le brouillage est susceptible d'en compromettre le fonctionnement. <p>L'appareil est conforme aux limites d'exposition aux radiofréquences du CNR - 102 d'ISDE établies par innovation, sciences et développement économique Canada pour les environnements non contrôlés. L'exposition aux RF peut être encore réduite si le produit peut être placé aussi loin que possible du corps de l'utilisateur ou si la fonction peut être utilisée, l'appareil peut être réglé à une puissance de sortie inférieure. L'appareil ne doit pas coexister ou fonctionner en synergie avec d'autres antennes ou émetteurs.</p>

Region	Specification
Mexico	IFT NO.: VOSCAG23-34968
Morocco	
Serbia	
Singapore	
South Africa	
Thailand	
United Arab Emirates	
Ukraine	
United States	<p>FCC Regulatory Compliance Statements</p> <p>This device complies with Part 15 of the FCC Rules. Operation is subject to the following conditions:</p> <ol style="list-style-type: none"> 1. This device may not cause harmful interference, and 2. This device must accept any interference received, including interference that may cause undesired operation. <p>Note: This equipment has been tested and found to comply with the limits for a Class B digital device, pursuant to Part 15 of the FCC Rules. These limits are designed to provide reasonable protection against harmful interference in a residential installation. This equipment generates, uses, and can radiate radio frequency energy and, if not installed and used in accordance with the instructions, may cause harmful interference to radio communications. However, there is no guarantee that interference will not occur in a particular installation. If this equipment does cause harmful interference to radio or television reception, which can be determined by turning the equipment off and on, the user is encouraged to try to correct the interference by one or more of the following measures:</p> <ul style="list-style-type: none"> • Reorient or relocate the receiving antenna. • Increase the separation between the equipment and receiver. • Connect the equipment into an outlet on a circuit different from that to which the receiver is connected. • Consult the dealer or an experienced radio/TV technician for help. <p>Caution: Changes or modifications not expressly approved by the party responsible for compliance could void the user's authority to operate the equipment.</p> <p>FCC Radiation Exposure Statement</p> <p>This equipment complies with the FCC portable RF exposure limit set forth for an uncontrolled environment and are safe for intended operation as described in this manual. The further RF exposure reduction can be achieved if the product can be kept as far as possible from the user body or set the device to lower output power if such function is available.</p>

15.5.4. Type approvals for Wireless charger and NFC

What follows are the technical specifications and type approvals for the wireless charger and NFC reader.

The content of this manual represents the status of the user manual at the time of printing and may not be completely valid in future instances. For more information, refer to the first page for the complete disclaimer note.

Technical specification

The wireless charger and NFC reader is designed to work in ambient temperatures between -35 °C and 85 °C.

Wireless charger

- Frequency Band: 127,7±10kHz
- Maximum Magnetic Field Strength: 65,69dBµA/m @10m

NFC card reader

- Frequency Band 13.56MHz ±10%
- Maximum Magnetic Field Strength: 42dBµA/m @10m



Declaration of conformity









CE RED	<p>Hereby, Hefei Invispower Co.,Ltd declares that the radio equipment NFCR-INTERNAL (model: NFC-I-SX-21548) and Model-Wireless charging (model: WPC-15SN-21493) are in compliance with Directive 2014/53/EU.</p> <p>The Maximum Permissible Exposure (MPE) level for this equipment is based on a distance of 20 cm between the equipment and the human body. To comply with RF exposure requirements, it is recommended to maintain a distance of at least 20 cm between the equipment and body parts during use.</p>
UKCA	<p>Hereby, Hefei Invispower Co.,Ltd declares that the radio equipment NFCR-INTERNAL (model: NFC-I-SX-21548) and Model-Wireless charging (model: WPC-15SN-21493) are in compliance with UK Radio Equipment Regulations (SI 2017/1206).</p>
FCC ID & IC	<p>This device complies with part 15 of the FCC rules and with RSS-Gen,RSS-216 rules of Canada. Operation is subject to the following two conditions:</p> <ol style="list-style-type: none">1. This device may not cause harmful interference, and2. This device must accept any interference received, including interference that may cause undesired operation. <p>Any changed or modifications not expressly approved by the party responsible for compliance could void the user's authority to operate this equipment. FCC RF Radiation Exposure Statement: This equipment complies with FCC RF Radiation exposure limits set forth for an uncontrolled environment. This device and its antenna must not be co-located or operating in conjunction with any other antenna or transmitter. This equipment should be installed and operated with a minimum distance of 20cm between the radiator and your body. Note: This equipment has been tested and found to comply with the limits for a Class B digital device, pursuant to part 15 of the FCC Rules. These limits are designed to provide reasonable protection against harmful interference in a residential installation. This equipment generates, uses and can radiate radio frequency energy and, if not installed and used in accordance with the instructions, may cause harmful interference to radio communications. However, there is no guarantee that interference will not occur in a particular installation. If this equipment does cause harmful interference to radio or television reception, which can be determined by turning the equipment off and on, the user is encouraged to try to correct the interference by one or more of the following measures:</p> <ul style="list-style-type: none">• Reorient or relocate the receiving antenna.• Increase the separation between the equipment and receiver.• Connect the equipment into an outlet on a circuit different from that to which the receiver is connected.• Consult the dealer or an experienced radio/TV technician for help. <p>Déclaration d'avertissement ISED Son fonctionnement est soumis aux deux conditions suivantes:</p> <ol style="list-style-type: none">1. Cet appareil ne doit pas provoquer d'interférences nuisibles, et2. Cet appareil doit accepter toute interference recue, y compris les interferences pouvant entrainer un fonctionnement indésirable. <p>Les changements ou modifications non expressément approuvés par la partie responsable de la conformité peut annuler l'autorité de l'utilisateur à utiliser l'équipement. Déclaration d'exposition aux radiations RF de l'ISED: Cet équipement est conforme aux limites d'exposition aux rayonnements RF de l'ISED définies pour un environnement non contrôlé. Cet appareil et son antenne ne doivent pas être situés ou fonctionner conjointement avec une autre antenne ou un autre émetteur</p>
ANATEL	<p>This equipment is not entitled to protection against harmful interference and may not cause interference to properly authorized systems. For more information, see the ANATEL website – https://www.gov.br/anatel [https://www.gov.br/anatel]</p> <p>Este equipamento não tem direito à proteção contra interferência prejudicial e não pode causar interferência em sistemas devidamente autorizados. Para maiores informações, consulte o site da ANATEL – https://www.gov.br/anatel [https://www.gov.br/anatel]</p>





Country/Region	Model/Product	Compliance	Label
FCC/IC	GE-1	<p>FCC Regulations: This device complies with Part 15 of the FCC Rules. Operation is subject to the following two conditions: (1) This device may not cause harmful interference, and (2) this device must accept any interference received, including interference that may cause undesired operation. This equipment has been tested and found to comply with the limits for a Class B digital device, pursuant to Part 15 of the FCC Rules. These limits are designed to provide reasonable protection against harmful interference in a residential installation. This equipment generates, uses and can radiate radio frequency energy and, if not installed and used in accordance with the instructions, may cause harmful interference to radio communications. However, there is no guarantee that interference will not occur in a particular installation. If this equipment does cause harmful interference to radio or television reception, which can be determined by turning the equipment off and on, the user is encouraged to try to correct the interference by one of the following measures: Reorient or relocate the receiving antenna. Increase the separation between the equipment and receiver. Connect the equipment into an outlet on a circuit different from that to which the receiver is connected. Consult the dealer or an experienced radio/TV technician for help. FCC Caution: Any changes or modifications not expressly approved by the party responsible for compliance could void the user's authority to operate this equipment. Radiation Exposure Statement: This equipment complies with FCC radiation exposure limits set forth for an uncontrolled environment. This equipment should be installed and operated with minimum distance 20cm between the radiator & your body. IC[?] ISED Notice: This device complies with Industry Canada license-exempt RSS standard(s). Operation is subject to the following two conditions: 1) this device may not cause interference, and 2) this device must accept any interference, including interference that may cause undesired operation of the device. Le présent appareil est conforme aux CNR d'Industrie Canada applicables aux appareils radio exempts de licence. L'exploitation est autorisée aux deux conditions suivantes: 1) l'appareil ne doit pas produire de brouillage, et 2) l'utilisateur de l'appareil doit accepter tout brouillage radioélectrique subi, même si le brouillage est susceptible d'en compromettre le fonctionnement. This device and its antenna(s) must not be co-located or operating in conjunction with any other antenna or transmitter, except tested built-in radios. Cet appareil et son antenne ne doivent pas être situés ou fonctionner en conjonction avec une autre antenne ou un autre émetteur, exception faites des radios intégrées qui ont été testées. The County Code Selection feature is disabled for products marketed in the US/ Canada. La fonction de sélection de l'indicatif du pays est désactivée pour les produits commercialisés aux États-Unis et au Canada. Radiation Exposure Statement: This equipment complies with IC radiation exposure limits set forth for an uncontrolled environment. This equipment should be installed and operated with minimum distance 20cm between the radiator & your body. Déclaration d'exposition aux radiations: Cet équipement est conforme aux limites d'exposition aux rayonnements IC établies pour un environnement non contrôlé. Cet équipement doit être installé et utilisé avec un minimum de 20 cm de distance entre la source de rayonnement et votre corps.</p>	











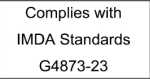
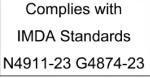
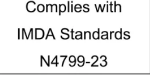



Country/Region	Model/Product	Compliance	Label
FCC/IC	GK2	<p>WARNING: Do not ingest the battery, Chemical Burn Hazard (The remote control supplied with) This product contains a coin/button cell battery. If the coin/button cell battery is swallowed, it can cause severe internal burns in just 2 hours and can lead to death. Keep new and used batteries away from children. If the battery compartment does not close securely, stop using the product and keep it away from children. If you think batteries might have been swallowed or placed inside any part of the body, seek immediate medical attention. WARNING 1. Replacement of a battery with an incorrect type that can defeat a safeguard; Disposal of a battery into fire or a hot oven, or mechanically crushing or cutting of a battery, that can result in an explosion; Leaving a battery in an extremely high temperature surrounding environment that can result in an explosion or the leakage of flammable liquid or gas A battery subjected to extremely low air pressure that may result in an explosion or the leakage of flammable liquid or gas 2. The exclamation point within an equilateral triangle is intended to alert the user to the presence of important operating and maintenance (servicing) instructions in the literature accompanying the appliance. 3. CAUTION For coin/button battery used, please refer for further information to the user manual FCC[?] FCC Regulations: This device complies with Part 15 of the FCC Rules. Operation is subject to the following two conditions: (1) This device may not cause harmful interference, and (2) this device must accept any interference received, including interference that may cause undesired operation. This equipment has been tested and found to comply with the limits for a Class B digital device, pursuant to Part 15 of the FCC Rules. These limits are designed to provide reasonable protection against harmful interference in a residential installation. This equipment generates, uses and can radiate radio frequency energy and, if not installed and used in accordance with the instructions, may cause harmful interference to radio communications. However, there is no guarantee that interference will not occur in a particular installation. If this equipment does cause harmful interference to radio or television reception, which can be determined by turning the equipment off and on, the user is encouraged to try to correct the interference by one of the following measures: Reorient or relocate the receiving antenna. Increase the separation between the equipment and receiver. Connect the equipment into an outlet on a circuit different from that to which the receiver is connected. Consult the dealer or an experienced radio/TV technician for help. FCC Caution: Any changes or modifications not expressly approved by the party responsible for compliance could void the user's authority to operate this equipment. Radiation Exposure Statement: This equipment complies with FCC radiation exposure limits set forth for an uncontrolled environment. This equipment should be installed and operated with minimum distance 20cm between the radiator & your body. Device may not be employed for the operation of toys. Operation on-board an aircraft, a ship or a satellite is prohibited. IC: ISED Notice: This device complies with Industry Canada license-exempt RSS standard(s). Operation is subject to the following two conditions: 1) this device may not cause interference, and 2) this device must accept any interference, including interference that may cause undesired operation of the device. Le présent appareil est conforme aux CNR d'Industrie Canada applicables aux appareils radio exempts de licence. L'exploitation est autorisée aux deux conditions suivantes: 1) l'appareil ne doit pas produire de brouillage, et 2) l'utilisateur de l'appareil doit accepter tout brouillage radioélectrique subi, même si le brouillage est susceptible d'en compromettre le fonctionnement. This device and its antenna(s) must not be co-located or operating in conjunction with any other antenna or transmitter, except tested built-in radios. Cet appareil et son antenne ne doivent pas être situés ou fonctionner en conjonction avec une autre antenne ou un autre émetteur, exception faites des radios intégrées qui ont été testées. The County Code Selection feature is disabled for products marketed in the US/ Canada. La fonction de sélection de l'indicatif du pays est désactivée pour les produits commercialisés aux États-Unis et au Canada. Radiation Exposure Statement: This equipment complies with IC radiation exposure limits set forth for an uncontrolled environment. This equipment should be installed and operated with minimum distance 20cm between the radiator & your body. Déclaration d'exposition aux radiations: Cet équipement est conforme aux limites d'exposition aux rayonnements IC établies pour un environnement non contrôlé. Cet équipement doit être installé et utilisé avec un minimum de 20 cm de distance entre la source de rayonnement et votre corps.</p>	



Country/Region	Model/Product	Compliance	Label
FCC/IC	GR4	<p>FCC Regulations: This device complies with Part 15 of the FCC Rules. Operation is subject to the following two conditions: (1) This device may not cause harmful interference, and (2) this device must accept any interference received, including interference that may cause undesired operation. This equipment has been tested and found to comply with the limits for a Class B digital device, pursuant to Part 15 of the FCC Rules. These limits are designed to provide reasonable protection against harmful interference in a residential installation. This equipment generates, uses and can radiate radio frequency energy and, if not installed and used in accordance with the instructions, may cause harmful interference to radio communications. However, there is no guarantee that interference will not occur in a particular installation. If this equipment does cause harmful interference to radio or television reception, which can be determined by turning the equipment off and on, the user is encouraged to try to correct the interference by one of the following measures: Reorient or relocate the receiving antenna. Increase the separation between the equipment and receiver. Connect the equipment into an outlet on a circuit different from that to which the receiver is connected. Consult the dealer or an experienced radio/TV technician for help. FCC Caution: Any changes or modifications not expressly approved by the party responsible for compliance could void the user's authority to operate this equipment. Radiation Exposure Statement: This equipment complies with FCC radiation exposure limits set forth for an uncontrolled environment. This equipment should be installed and operated with minimum distance 20cm between the radiator & your body. IC[?] ISED Notice This device complies with Industry Canada license-exempt RSS standard(s). Operation is subject to the following two conditions: 1) this device may not cause interference, and 2) this device must accept any interference, including interference that may cause undesired operation of the device. Le présent appareil est conforme aux CNR d'Industrie Canada applicables aux appareils radio exempts de licence. L'exploitation est autorisée aux deux conditions suivantes: 1) l'appareil ne doit pas produire de brouillage, et 2) l'utilisateur de l'appareil doit accepter tout brouillage radioélectrique subi, même si le brouillage est susceptible d'en compromettre le fonctionnement. This device and its antenna(s) must not be co-located or operating in conjunction with any other antenna or transmitter, except tested built-in radios. Cet appareil et son antenne ne doivent pas être situés ou fonctionner en conjonction avec une autre antenne ou un autre émetteur, exception faites des radios intégrées qui ont été testées. The County Code Selection feature is disabled for products marketed in the US/ Canada. La fonction de sélection de l'indicatif du pays est désactivée pour les produits commercialisés aux États-Unis et au Canada. Radiation Exposure Statement: This equipment complies with IC radiation exposure limits set forth for an uncontrolled environment. This equipment should be installed and operated with minimum distance 20cm between the radiator & your body. Déclaration d'exposition aux radiations: Cet équipement est conforme aux limites d'exposition aux rayonnements IC établies pour un environnement non contrôlé. Cet équipement doit être installé et utilisé avec un minimum de 20 cm de distance entre la source de rayonnement et votre corps.</p>	
FCC/IC	GU1	<p>FCC Regulations: This device complies with Part 15 of the FCC Rules. Operation is subject to the following two conditions: (1) This device may not cause harmful interference, and (2) this device must accept any interference received, including interference that may cause undesired operation. This equipment has been tested and found to comply with the limits for a Class B digital device, pursuant to Part 15 of the FCC Rules. These limits are designed to provide reasonable protection against harmful interference in a residential installation. This equipment generates, uses and can radiate radio frequency energy and, if not installed and used in accordance with the instructions, may cause harmful interference to radio communications. However, there is no guarantee that interference will not occur in a particular installation. If this equipment does cause harmful interference to radio or television reception, which can be determined by turning the equipment off and on, the user is encouraged to try to correct the interference by one of the following measures: Reorient or relocate the receiving antenna. Increase the separation between the equipment and receiver. Connect the equipment into an outlet on a circuit different from that to which the receiver is connected. Consult the dealer or an experienced radio/TV technician for help. FCC Caution: Any changes or modifications not expressly approved by the party responsible for compliance could void the user's authority to operate this equipment. Radiation Exposure Statement: This equipment complies with FCC radiation exposure limits set forth for an uncontrolled environment. This equipment should be installed and operated with minimum distance 20cm between the radiator & your body. Device may not be employed for the operation of toys. Operation onboard an aircraft, a ship or a satellite is prohibited. IC[?] ISED Notice This device complies with Industry Canada license-exempt RSS standard(s). Operation is subject to the following two conditions: 1) this device may not cause interference, and 2) this device must accept any interference, including interference that may cause undesired operation of the device. Le présent appareil est conforme aux CNR d'Industrie Canada applicables aux appareils radio exempts de licence. L'exploitation est autorisée aux deux conditions suivantes: 1) l'appareil ne doit pas produire de brouillage, et 2) l'utilisateur de l'appareil doit accepter tout brouillage radioélectrique subi, même si le brouillage est susceptible d'en compromettre le fonctionnement. This device and its antenna(s) must not be co-located or operating in conjunction with any other antenna or transmitter, except tested built-in radios. Cet appareil et son antenne ne doivent pas être situés ou fonctionner en conjonction avec une autre antenne ou un autre émetteur, exception faites des radios intégrées qui ont été testées. The County Code Selection feature is disabled for products marketed in the US/ Canada. La fonction de sélection de l'indicatif du pays est désactivée pour les produits commercialisés aux États-Unis et au Canada. Radiation Exposure Statement: This equipment complies with IC radiation exposure limits set forth for an uncontrolled environment. This equipment should be installed and operated with minimum distance 20cm between the radiator & your body.</p>	

Country/Region	Model/Product	Compliance	Label
Israel	BNCM [®] 51-93994	מספר אישור התאמה מטעם משרד התקשורת: חל איסור לבצע פעולות במכשיר שיש בהן כדי לשנות את תכונותיו האלחוטיות של המכשיר, ובכלל זה שינוי תוכנה, החלפת אנטנה מקורית או הוספת אפשרות לחיבור לאנטנה חיצונית, בלא קבלת אישור משרד התקשורת, בשל החשש להפרעות אלחוטיות.	
Israel	UWB anchor: 51-93993	מספר אישור התאמה מטעם משרד התקשורת: חל איסור לבצע פעולות במכשיר שיש בהן כדי לשנות את תכונותיו האלחוטיות של המכשיר, ובכלל זה שינוי תוכנה, החלפת אנטנה מקורית או הוספת אפשרות לחיבור לאנטנה חיצונית, בלא קבלת אישור משרד התקשורת, בשל החשש להפרעות אלחוטיות.	
Israel	key tag: 51-99616	מספר אישור התאמה מטעם משרד התקשורת: חל איסור לבצע פעולות במכשיר שיש בהן כדי לשנות את תכונותיו האלחוטיות של המכשיר, ובכלל זה שינוי תוכנה, החלפת אנטנה מקורית או הוספת אפשרות לחיבור לאנטנה חיצונית, בלא קבלת אישור משרד התקשורת, בשל החשש להפרעות אלחוטיות.	
Israel	NFC Reader: 51-98998	מספר אישור התאמה מטעם משרד התקשורת: חל איסור לבצע פעולות במכשיר שיש בהן כדי לשנות את תכונותיו האלחוטיות של המכשיר, ובכלל זה שינוי תוכנה, החלפת אנטנה מקורית או הוספת אפשרות לחיבור לאנטנה חיצונית, בלא קבלת אישור משרד התקשורת, בשל החשש להפרעות אלחוטיות.	
Japan	BNCM		 218-230158
Japan	UWB anchor		 218-230167
Japan	Key tag		 218-230159
Japan	NFC Reader		総務省指定[MICRCS]第AC-23100号

Country/Region	Model/Product	Compliance	Label
Jordan	All	BNCM: TRC/34/11930/2023 UWB anchor: TRC/34/11931/2023 key tag: TRC/34/12858/2023 NFC Reader: TRC/15/13157/2023	
Korea	BNCM		 R-R-MQU-GE1
Korea	UWB anchor		 R-R-MQU-GU1
Korea	Key tag		 R-R-MQU-GK2
Korea	NFC Reader		 R-R-MQU-GR4
Lebanon	BNCM		 5601/E&M/2023
Lebanon	UWB anchor		 5599/E&M/2023
Lebanon	Key tag		 9814/E&M/2023
Lebanon	NFC Reader		 9817/E&M/2023

Country/Region	Model/Product	Compliance	Label
Mexico		BNCM: IFETEL:TEMAGE23-38667 UWB anchor: IFETEL:SYMAGU23-26221 key tag: IFETEL:TEMAGK23-44107 NFC Reader: IFETEL:SYMAGR23-34983	
Moldova	All		
Morocco	BNCM		<p>AGREE PAR L'ART MAROC</p> <p>Numéro d'agrément : MR00038206ANRT2023 Date d'agrément : 20230517</p>
Morocco	UWB anchor		<p>AGREE PAR L'ART MAROC</p> <p>Numéro d'agrément : MR00038196ANRT2023 Date d'agrément : 20230516</p>
Morocco	Key tag		<p>AGREE PAR L'ART MAROC</p> <p>Numéro d'agrément : MR00039920ANRT2023 Date d'agrément : 20230912</p>
Morocco	NFC Reader		<p>AGREE PAR L'ART MAROC</p> <p>Numéro d'agrément : MR00040022ANRT2023 Date d'agrément : 20230919</p>
Oman	BNCM		<p>OMAN-TRA TRA/TA-R/15622/23 D202897</p>
Oman	UWB anchor		<p>OMAN-TRA TRA/TA-R/15648/23 D202897</p>
Oman	Key tag		<p>OMAN-TRA TRA/TA-R/16718/23 D202897</p>
Oman	NFC Reader		<p>OMAN-TRA TRA/TA-R/16798/23 D202897</p>
Paraguay	BNCM		
Paraguay	UWB anchor		
Paraguay	Key tag		
Paraguay	NFC Reader		
Singapore	BNCM		<p>Complies with IMDA Standards N4800-23</p>

Country/Region	Model/Product	Compliance	Label
Singapore	UWB anchor		
Singapore	Key tag		
Singapore	NFC Reader		
Serbia	All		
South Africa	BNCM		
South Africa	UWB anchor		
South Africa	Key tag		
South Africa	NFC Reader		
Thailand	BNCM		
Thailand	UWB anchor		
Thailand	Key tag		
Thailand	NFC Reader		
UAE	BNCM		
UAE	UWB anchor		
UAE	Key tag		
UAE	NFC Reader		

Country/Region	Model/Product	Compliance	Label
Ukraine	BNCM		 UA.032.CT.0268-23
Ukraine	UWB anchor		 UA.032.CT.0268-23
Ukraine	Key tag		 UA.032.CT.0359-23
Ukraine	NFC Reader		 UA.032.CT.0346-23
USA		BNCM: FCC ID: IYZGE1. UWB anchor: FCC ID: IYZGU1. NFC Reader: FCC ID: IYZGR4. key tag: FCC ID: IYZGK2.	

15.5.6. Candidate List Substance Information (CL) in accordance with the REACH Regulation, Article 33.1

Volvo Cars supports the underlying goals of the REACH regulation in general, and Article 33 in particular, which are consistent with our own commitment to promote the responsible manufacturing, handling and use of our products.

In accordance with Article 33.1 of the REACH Regulation (Reg. EC 1907/2006),^[1] professional customers must be informed of Substances of Very High Concern (SVHC^[2]) in products supplied by Volvo Cars. The intention is to facilitate the safe handling of the constituent components affected in order to protect people and the environment.

Presence of candidate list substances

The articles in the "Candidate List Substances Table" below contain substances at greater than 0.1% w/w in the candidate list (CL) for the specific car. The information on substances in the candidate list (CL) is based on the data obtained from our suppliers and our own product data.

General Safe Use Information for Articles

Every car from Volvo Cars is provided with a user manual, which includes safe use information for owners, drivers and users of the car. Volvo Cars information on the repair and servicing of cars and genuine parts also includes safe use information for service personnel.

Where present in parts of this car, the Candidate List substances shown in the relevant "Candidate List Substances Table" for the specific car are incorporated in such a way that potential exposure to customers as well as risks for people or the environment can be minimised as long as the car and its parts are used as intended, and any repairs, servicing and maintenance are carried out following technical instructions for those activities, and industry standard good practices.

An end-of-life vehicle may only be disposed of legally in the European Union at an Authorised Treatment Facility (ATF). Vehicle parts should be disposed in accordance with locally applicable laws and local authority guidance.

Candidate List Substances Table

More details are available in a PDF file, see Support / Car information / Regulatory information.

^[1] REACH - The European Union's chemicals legislation, which entered into force on 1 June 2007, Regulation (EC) No. 1907/2006 concerning the Registration, Evaluation, Authorisation and Restriction of Chemicals (REACH).

^[2] SVHC - Substances of Very High Concern, which are included in the current candidate list (CL).

15.6. Labels

Your car has a number of labels that provide information about the car and its use, such as specifications and warnings.

Label types



Black ISO symbols on a yellow header with white text, or an illustration on a black background.

Illustrates the risk of serious injury or death if the warning is ignored.



White ISO symbols and white text, or an illustration on a black or blue background.

Illustrates the risk of material damage if the warning is ignored.



White ISO symbols and white text, or an illustration on a black background.

Contains information about the car and its use.

Note

Depicted labels

Labels depicted in this manual are generic representations of those found around your car. The manual only contains their location and what kind of information they hold. Find the actual label for specific information about your car.