

EX90 2027 (26w17) User Manual

Version 2026-06-22

Disclaimer

Due to the dynamic nature of our software-based product, the content of this PDF represents the most up-to-date version of the user manual as of the time of printing. As we continuously update and improve our product, certain content may not reflect the most up-to-date information in a future instance. Therefore, we strongly recommend utilising the digital user manual app in your car's centre display for the most accurate and up-to-date information. You can also access information in the Volvo Cars mobile app.

Please note that if you choose to print the manual, we cannot guarantee the validity of the information in future instances, as updates may have occurred since the time of printing. To ensure the highest level of safety and optimal product usage, we strongly advise relying on the digital user manual, which can be easily accessed through your car's centre display.

This printable version is generic and does not correspond to your car. If there are discrepancies between this printable manual and the manual you see in your car's centre display, the latter takes precedence.

Contents

1. [Consumer information](#)
 - 1.1 [About the user manual](#)
 - 1.1.1 [Reading the user manual](#)
 - 1.2 [Customer support and contact information](#)
 - 1.3 [Driver responsibility](#)
 - 1.4 [Modifications, repairs and accessory installations](#)
 - 1.5 [Finding the vehicle identification number](#)
 - 1.6 [Approval of terms and conditions and data collection](#)
 - 1.7 [Handling of recorded and collected data](#)
 - 1.8 [About connected services and fair use policy](#)
 - 1.9 [Changing ownership of the car](#)
 - 1.10 [Resetting user data](#)
 - 1.11 [Recommendations when changing regions](#)
2. [User accounts, profiles and services](#)
 - 2.1 [Setting up your car for the first time](#)
 - 2.2 [Volvo ID](#)
 - 2.2.1 [Creating a Volvo ID](#)
 - 2.3 [Volvo Cars app](#)
 - 2.4 [Getting started with Google services](#)
 - 2.5 [Customisation and settings](#)
 - 2.6 [Car user profiles](#)
 - 2.6.1 [Switching profiles](#)
 - 2.6.2 [Adding a profile](#)
 - 2.6.3 [Removing a profile](#)
 - 2.6.4 [Assigning a key to a profile](#)
 - 2.6.5 [Managing keys assigned to profiles](#)
 - 2.6.6 [Restricting access to a profile](#)
 - 2.6.7 [Adding an account to a profile](#)
 - 2.7 [Volvo Assistance](#)
 - 2.7.1 [Calling Volvo Assistance for roadside assistance](#)
 - 2.8 [Emergency assistance](#)

The content of this manual represents the status of the user manual at the time of printing and may not be completely valid in future instances. For more information, refer to the first page for the complete disclaimer note.

- 2.8.1 Calling emergency services with SOS button
- 2.8.2 Changing emergency call recipient
- 3. Displays, software and phone
 - 3.1 Displays
 - 3.1.1 Centre display
 - 3.1.1.1 Centre display views
 - 3.1.1.2 Status symbols in the centre display
 - 3.1.1.3 Keyboard
 - 3.1.1.3.1 Changing keyboard language
 - 3.1.1.3.2 Adding and removing keyboard languages
 - 3.1.2 Driver display
 - 3.1.2.1 Warning and indicator symbols
 - 3.1.2.2 Battery meter
 - 3.1.2.3 Power meter
 - 3.1.3 Head-up display
 - 3.1.3.1 Adjusting the head-up display
 - 3.1.4 System settings
 - 3.1.4.1 Changing time and date
 - 3.1.4.2 Changing system language
 - 3.1.4.3 Changing system units
 - 3.1.5 Restarting the displays
 - 3.2 Phone
 - 3.2.1 Connecting your phone to the car
 - 3.2.2 Using your phone in the car
 - 3.2.3 Switching between paired phones
 - 3.2.4 Apple CarPlay
 - 3.2.4.1 Connecting your iPhone to Apple CarPlay
 - 3.2.5 Android Auto™
 - 3.2.5.1 Connecting your Android™ phone to Android Auto™
 - 3.3 Sound and media
 - 3.3.1 Radio
 - 3.3.1.1 Adding radio favourites
 - 3.3.1.2 Linking DAB and FM stations
 - 3.3.2 Sound settings
 - 3.3.3 Media players
 - 3.4 In-car apps
 - 3.4.1 Downloading apps
 - 3.4.2 Uninstalling apps
 - 3.5 Connectivity and software
 - 3.5.1 Internet connection
 - 3.5.1.1 Connecting to the internet via a Bluetooth-connected phone
 - 3.5.1.2 Connecting to the internet via Wi-Fi
 - 3.5.2 Over-the-air updates
 - 3.6 Voice control
 - 3.6.1 Using voice control
- 4. Interior comfort and climate
 - 4.1 Interior
 - 4.1.1 Using the wireless charger
 - 4.1.2 Enabling the wireless charger
 - 4.1.3 USB ports
 - 4.1.4 12 V socket
 - 4.1.5 Sun visors

- 4.2 Comfort
- 4.3 Climate
 - 4.3.1 Climate controls
 - 4.3.1.1 Activating seat heating
 - 4.3.1.2 Activating seat ventilation
 - 4.3.1.3 Activating the steering wheel heating
 - 4.3.2 Climate settings
 - 4.3.3 Temperature and air conditioning
 - 4.3.3.1 Activating air conditioning
 - 4.3.3.2 Setting temperature
 - 4.3.3.3 Synchronising temperature
 - 4.3.3.4 Activating eco climate
 - 4.3.4 Air distribution and climate modes
 - 4.3.4.1 Adjusting air vents
 - 4.3.4.2 Activating auto climate mode
 - 4.3.4.3 Activating manual climate mode
 - 4.3.5 Ice, condensation and defrosters
 - 4.3.5.1 Activating max defroster
 - 4.3.5.2 Activating rear windscreen and wing mirror heating
 - 4.3.6 Interior climate when parked
 - 4.3.6.1 Setting the preconditioning timer
 - 4.3.6.2 Keeping climate active while parked
 - 4.3.6.3 Air purification
 - 4.3.7 Air quality
 - 4.3.7.1 Air quality indication
 - 4.3.7.2 Air cleaning
 - 4.3.7.2.1 Advanced air cleaning
 - 4.3.7.2.2 Focused air cleaning
 - 4.3.7.2.2.1 Activating focused air cleaning
 - 4.3.7.3 CleanZone
 - 4.3.7.4 Activating air recirculation
 - 4.3.8 Climate system
 - 4.3.8.1 Climate zones
 - 4.3.8.2 Partial climate
 - 4.3.8.3 Perceived and actual temperature
 - 4.3.8.4 Climate sensors
 - 4.3.8.5 Heaters
- 4.4 Windows and glass panes
 - 4.4.1 Operating the windows
 - 4.4.2 Adjusting roof tint
 - 4.4.3 Pinch protection
 - 4.4.4 Resetting windows
- 4.5 Seats
 - 4.5.1 Front seats
 - 4.5.1.1 Adjusting front seats
 - 4.5.1.2 Resetting the front seat positions
 - 4.5.1.3 Activating seat massage
 - 4.5.1.4 Extending the seat cushion
 - 4.5.2 Second row seats
 - 4.5.2.1 Adjusting outer second row seats
 - 4.5.2.2 Adjusting centre second row seat
 - 4.5.2.3 Adjusting centre second row headrest

- 4.5.2.4 Folding down the outer second row seats
 - 4.5.2.5 Folding down the centre second row seat
 - 4.5.2.6 Second row centre armrest
 - 4.5.3 Third row seats
 - 4.5.3.1 Getting in and out of the third row
 - 4.5.3.2 Folding down the third row seats
 - 4.6 Interior lighting
 - 4.6.1 Adjusting the reading lights
 - 4.6.2 Adjusting interior lights
 - 4.6.3 Disabling interior auto lights
 - 4.6.4 Activating all interior lights
- 5. Safety
 - 5.1 Collision response
 - 5.1.1 Pedestrian protection system
 - 5.2 Occupant detection
 - 5.3 Proper seating
 - 5.4 Seatbelts
 - 5.4.1 Fastening and adjusting seatbelt
 - 5.4.2 Seatbelt reminder
 - 5.5 Airbags
 - 5.5.1 Airbag deployment
 - 5.5.2 Front airbags
 - 5.5.2.1 Disabling and enabling front passenger airbag
 - 5.5.3 Side airbags
 - 5.5.4 Inflatable curtains
 - 5.5.5 Airbag maintenance and servicing
 - 5.5.6 Airbag labels
 - 5.6 Child safety
 - 5.6.1 Child restraints
 - 5.6.1.1 Installing child restraints
 - 5.6.1.1.1 Installing child restraints on the outer second row seats
 - 5.6.1.1.2 Installing child restraints on the centre second row seat
 - 5.6.1.1.3 Installing child restraints on the third row seats
 - 5.6.1.1.4 Installing child restraints on the front passenger seat
 - 5.6.1.2 Child restraint anchorage points
 - 5.6.1.2.1 ISOFIX anchorage points
 - 5.6.1.2.2 Top tether anchorage points
 - 5.6.1.2.3 Lower tether anchorage points
 - 5.6.1.3 Integrated child seat
 - 5.6.1.3.1 Folding up the integrated child seat
 - 5.6.1.3.2 Folding down the integrated child seat
 - 5.6.1.4 Recommended child restraints
 - 5.6.1.5 Overview table of suitable locations for child restraints
- 6. Entry and security
 - 6.1 Keys
 - 6.1.1 Key tag
 - 6.1.1.1 Charging the key tag
 - 6.1.2 Key card
 - 6.1.3 Digital key
 - 6.1.3.1 Creating a digital key
 - 6.1.3.2 Deleting a digital key
 - 6.1.4 Key reading locations

- 6.2 Opening and closing
 - 6.2.1 Opening the bonnet
 - 6.2.2 Closing the bonnet
 - 6.2.3 Boot access
 - 6.2.3.1 Opening the boot hands-free
 - 6.2.3.2 Adjusting boot opening height
- 6.3 Locking and unlocking
 - 6.3.1 Activating child lock
 - 6.3.2 Settings for locking and unlocking
 - 6.3.2.1 Adjusting locking and unlocking settings
 - 6.3.3 Unresponsive lock
- 6.4 Anti-theft
 - 6.4.1 Alarm
 - 6.4.1.1 Reducing the alarm sensitivity
- 7. Charging your car
 - 7.1 Charging types
 - 7.1.1 Charging cables
 - 7.2 Charging view and settings
 - 7.2.1 Setting a target battery level for charging
 - 7.2.2 Setting the amperage limit for charging
 - 7.2.3 Adding and managing charging schedules
 - 7.2.4 Setting a minimum battery level for charging
 - 7.2.5 Plug & Charge
 - 7.2.5.1 Activating Plug & Charge
 - 7.3 Start and stop charging
 - 7.3.1 Starting AC charging
 - 7.3.2 Starting DC charging
 - 7.3.3 Stopping AC charging
 - 7.3.4 Stopping DC charging
 - 7.3.5 Releasing the charging cable
 - 7.3.5.1 Using the emergency release handle for the charging cable
 - 7.4 Charging time and statuses
 - 7.4.1 Charging times
 - 7.4.1.1 Manually activating battery preconditioning
 - 7.4.2 Charging status
 - 7.4.2.1 Charging status in the charging port
 - 7.4.2.2 Charging status in the driver display
- 8. Driving
 - 8.1 A typical driving cycle
 - 8.2 Trips app
 - 8.3 Starting the car
 - 8.3.1 Start-up checks
 - 8.3.2 Alcohol lock
 - 8.4 Turning the car off
 - 8.5 Driving characteristics
 - 8.5.1 Drive modes
 - 8.5.1.1 Selecting a drive mode
 - 8.5.2 One pedal drive
 - 8.5.2.1 Adjusting One pedal drive
 - 8.5.3 Stability control
 - 8.5.4 Suspension
 - 8.5.4.1 Adjusting suspension feel

- 8.6 Range
 - 8.6.1 Range and trip
 - 8.6.1.1 Resetting the trip meter
 - 8.7 Steering
 - 8.7.1 Steering wheel
 - 8.7.1.1 Steering wheel controls
 - 8.7.1.2 Adjusting the steering wheel position
 - 8.7.2 Adjusting steering feel
 - 8.8 Brakes
 - 8.8.1 Foot brake
 - 8.8.2 Parking brake
 - 8.8.2.1 Engaging the parking brake
 - 8.8.3 Auto hold
 - 8.8.4 Post-impact braking
 - 8.9 Selecting gear
9. Visibility, mirrors and exterior lights
- 9.1 Exterior lights
 - 9.1.1 Driving lights
 - 9.1.1.1 Selecting a primary lighting mode
 - 9.1.1.2 High beam
 - 9.1.1.2.1 Operating the high beam
 - 9.1.1.3 Operating the direction indicators
 - 9.1.1.4 Adaptive passing beam
 - 9.1.1.5 Cornering lights
 - 9.1.1.6 Static bending lights
 - 9.1.1.7 Activating the rear fog light
 - 9.1.1.8 Hazard warning lights
 - 9.1.1.8.1 Activating the hazard warning lights
 - 9.1.1.9 Re-orientating lights to local traffic
 - 9.1.2 Exterior convenience lights
 - 9.1.2.1 Enabling the greeting lights
 - 9.2 Mirrors
 - 9.2.1 Adjusting wing mirrors
 - 9.3 Wipers and washers
 - 9.3.1 Controlling front wipers
 - 9.3.2 Controlling rear wiper
 - 9.3.3 Activating washers
10. Driver support and navigation
- 10.1 Navigation
 - 10.1.1 Finding and selecting a navigation destination
 - 10.2 Detection of surroundings and traffic
 - 10.2.1 Locations of cameras, sensors and radars
 - 10.2.2 Camera detection and limitations
 - 10.2.3 Radar detection and limitations
 - 10.2.4 Parking sensor detection and limitations
 - 10.3 Driver behaviour detection
 - 10.4 Safety interventions and warnings
 - 10.4.1 Collision warnings and mitigation
 - 10.4.2 Interventions and warnings when reversing
 - 10.4.2.1 Alerts about traffic crossing behind the car
 - 10.4.2.2 Disabling automatic braking when reversing
 - 10.4.3 Lane keeping aid

- 10.4.3.1 Adjusting lane keeping aid
 - 10.4.4 Blind spot information
 - 10.4.5 Door opening alerts
 - 10.4.6 Driver alert
 - 10.4.6.1 Disabling distraction alert notifications
 - 10.4.7 Connected safety
 - 10.4.7.1 Enabling connected safety
 - 10.4.8 Emergency stop assist
- 10.5 Assisted driving
 - 10.5.1 Road signs and speeding response
 - 10.5.1.1 Speed limit warnings
 - 10.5.1.1.1 Disabling Intelligent Speed Assist
 - 10.5.1.1.2 Adjusting speed limit warnings
 - 10.5.1.2 Enabling sound alerts for speed limit changes
 - 10.5.1.3 Road sign information
 - 10.5.2 Pilot Assist
 - 10.5.2.1 Pilot Assist video guide
 - 10.5.2.2 Pilot Assist communication and status
 - 10.5.2.3 Activating Pilot Assist
 - 10.5.2.4 Deactivating Pilot Assist
 - 10.5.2.5 Adjusting the target speed for Pilot Assist
 - 10.5.2.6 Enabling and disabling steering assistance when driving
 - 10.5.2.7 Changing lanes with Pilot Assist
 - 10.5.2.8 Inside overtaking prevention
 - 10.5.2.9 Adjusting Pilot Assist settings
 - 10.5.2.10 Pilot Assist conditions and limitations
- 10.6 Assisted parking
 - 10.6.1 Parking view
 - 10.6.2 Park Pilot Assist
 - 10.6.2.1 Parking using Park Pilot Assist
 - 10.6.2.2 Leaving a parking space using Park Pilot Assist

11. Scenarios and driving recommendations

- 11.1 Cold conditions
 - 11.1.1 Winter driving recommendations
- 11.2 Wading recommendations
- 11.3 Preparations for a long trip
- 11.4 Long-term parking

12. Storage, stowing and towing

- 12.1 Passenger compartment storage
 - 12.1.1 Glove box
- 12.2 Boot space and storage
 - 12.2.1 Load cover
 - 12.2.1.1 Installing the load cover
 - 12.2.1.2 Removing the load cover
 - 12.2.2 Removing the cargo hatch
 - 12.2.3 Installing the safety net
 - 12.2.4 Stowing cargo in the boot
 - 12.2.4.1 Lowering the rear for loading
 - 12.2.4.2 Accessing the cargo hold
- 12.3 Storage under the bonnet
- 12.4 Towing a trailer
 - 12.4.1 Using the towbar

- 12.5 Recommendations for loading
- 13. Care and maintenance
 - 13.1 Car status
 - 13.2 Exterior cleaning and care
 - 13.2.1 Washing the exterior by hand
 - 13.2.2 Washing the car in an automatic car wash
 - 13.2.3 Polishing and waxing
 - 13.2.4 Touching up paintwork damage
 - 13.2.4.1 Finding the paint colour code
 - 13.2.5 Windscreen damage
 - 13.2.6 Refilling washer fluid
 - 13.2.7 Cleaning wipers
 - 13.2.8 Replacing front wiper blades
 - 13.2.9 Replacing the rear wiper blade
 - 13.2.10 Activating the wiper service position
 - 13.2.11 Corrosion protection
 - 13.3 Interior cleaning and care
 - 13.3.1 Cleaning fabrics and textiles
 - 13.3.2 Cleaning leather and vinyl
 - 13.3.3 Cleaning glass and glossy surfaces
 - 13.3.4 Cleaning interior plastic, metal and wood components
 - 13.3.5 Cleaning mats
 - 13.4 Wheels and tyres
 - 13.4.1 Wheel and tyre recommendations
 - 13.4.1.1 Tyres and wheel storage
 - 13.4.1.2 Tyre economy
 - 13.4.2 Designations on tyre sidewall
 - 13.4.2.1 Tyre tread wear indicators
 - 13.4.3 Changing wheels
 - 13.4.3.1 Spare wheel
 - 13.4.3.2 Winter tyres
 - 13.4.3.3 Using snow chains
 - 13.4.4 Checking the brake discs for wear
 - 13.4.5 Punctures
 - 13.4.5.1 Temporary puncture repair
 - 13.4.5.1.1 Using the temporary puncture repair kit
 - 13.4.5.1.2 Inflating tyre with the puncture repair compressor
 - 13.4.6 Tyre pressure
 - 13.4.6.1 Tyre pressure monitoring
 - 13.4.6.1.1 Saving a new reference value for tyre pressure monitoring
 - 13.4.6.2 Adjusting tyre pressure
 - 13.5 Car electrics and batteries
 - 13.5.1 Traction battery
 - 13.5.1.1 Managing battery health and performance
 - 13.5.1.2 Powertrain cooling system
 - 13.5.2 12 V battery
 - 13.5.2.1 Battery labels
 - 13.5.3 Battery recycling
 - 13.5.4 Fuses
 - 13.6 Tools and equipment
 - 13.6.1 Using a warning triangle
 - 13.6.2 Attaching the towing eye

- 13.7 Raising the car
 - 13.7.1 Workshop lifting areas
 - 13.7.2 Activating jack mode
- 13.8 Maintenance and repairs
 - 13.8.1 Booking maintenance or repairs
 - 13.8.2 On-board diagnostic port
- 14. Immobilised car and recovery
 - 14.1 Damaged car
 - 14.2 Malfunction
 - 14.3 Powerless or unresponsive car
 - 14.4 Recovery
 - 14.5 Safety mode
 - 14.6 Having your car towed
 - 14.6.1 Activating tow mode
- 15. Specifications
 - 15.1 General car characteristics
 - 15.1.1 Car dimensions
 - 15.1.2 Weights
 - 15.1.3 Towing specifications and capabilities
 - 15.1.4 Towbar specifications
 - 15.1.5 Type designations
 - 15.2 Powertrain specifications
 - 15.2.1 Electric motor specifications
 - 15.2.2 Performance
 - 15.2.3 The car's certified values for range and electricity consumption
 - 15.2.4 Charging cable specifications
 - 15.2.5 Charging port labels and identifiers
 - 15.3 Wheel and tyre specifications
 - 15.3.1 Approved tyre pressures
 - 15.3.2 Approved wheel and tyre sizes
 - 15.3.3 Minimum permitted load index and speed rating for tyres
 - 15.4 Fluid specifications
 - 15.4.1 Brake fluid specifications
 - 15.4.2 Climate system specifications
 - 15.5 Certificates and type approvals
 - 15.5.1 Detailed child restraint information
 - 15.5.2 Exterior radar type approvals
 - 15.5.3 Interior radar type approvals
 - 15.5.4 Type approvals for Telematic Connectivity Antenna Module
 - 15.5.5 Type approval for TPMS sensor radio frequency
 - 15.5.6 Type approvals for wireless charger and NFC
 - 15.5.7 Door NFC certification
 - 15.5.8 Key systems certification
 - 15.5.9 Candidate List Substance Information (CL) in accordance with the REACH Regulation, Article 33.1
 - 15.5.10 Certifications for radio and entertainment system
 - 15.6 Labels

1. Consumer information

There's a lot to learn about your Volvo. This section covers some essential topics, such as where you can find support if you need it and information about certain consumer rights and responsibilities.



Where to start?

Technically, the whole manual is recommended reading for anyone new to the car. However, you can start by reading the information about how this manual works so you know how to find what you need.

Driver responsibility

The information about driver responsibility is also a good place to start reading. It covers some general principles for safe use of the car and its features.

1.1. About the user manual

Learn about how the user manual applies to your car's use, where you can find it and how to navigate its content.

An important part of your car

Your car is a highly advanced product. However, as a well-designed product, advanced doesn't have to mean it's difficult to use. The aim here is to give you an intuitive experience, with natural interactions that work for both driver and passenger alike. This manual is designed to be a part of the car, giving you information for safe and effective use. It's your resource on the car's functions and features.



New user

If you are new to this car, take some time to explore the different areas in the manual. Knowing the car's capabilities and limitations is your responsibility and a necessity for safe and effective use.

Keep the manual up to date

Make sure that you keep the manual up to date by always having the latest version. Take a look any time a software update introduces changes or new features.

A guide to your car's intended use

The manual establishes the car's intended use, as defined by Volvo. Whenever you are directed to the manual, consider it an instruction to make absolutely sure that you are using the car as intended. This is the recommendation, as both the descriptive and prescriptive parts of the manual provide important knowledge that contributes to safe and effective use.

The content of this manual represents the status of the user manual at the time of printing and may not be completely valid in future instances. For more information, refer to the first page for the complete disclaimer note.

 **Note**

Intended use

If you use the car in a manner which Volvo has not intended, it can negatively affect how it works. This includes shortening the car's service life and limiting your ability to use the car safely and effectively. It may also affect the validity of the vehicle warranty.

Volvo is not the only authority that defines proper use of the car. It is your responsibility to use the car in accordance with local laws and restrictions.

Accuracy in representing your car

The primary goal is that this manual accurately describes how your car works. However, certain differences between produced cars are not reflected in the manual, such as the colours, materials and certain equipment.

 **Note**

Cars are equipped and adapted to meet specific market needs as well as local legislation and requirements. Certain regional variations in configuration may not be reflected in the manual's content.

Where to find the manual

Your car's user manual is available as an app in the car's display, via the mobile app for the car and at [volvocars.com/intl/support](https://www.volvocars.com/intl/support) [<https://www.volvocars.com/intl/support>].

 **Note**

Volvo's support site

The version of the user manual on Volvo's support site is for a fully-equipped car with all of the available options, functions and features. Therefore, it may differ from this user manual due to what's available in your car.^[1]

Printed supplements

The manual is fully digital, but a selection of its content may be included with your car as a printed supplement. The inclusion of printed supplements depends on region and how your car is configured.

Applicability

 **Important**

- Maintain and handle the car according to Volvo's recommendations in the user manual. Volvo accepts no responsibility for damage or accidents if you disregard the instructions in this manual.
- It is recommended that you read all the user information before you drive for the first time.
- If you find information through other channels, such as the Volvo website, that differs from the information in your car, it is always the user information in the car's display that is valid.
- Volvo works continuously to improve the quality of the user information and make it more accessible and useful. This means that descriptions and illustrations may change. Volvo reserves the right to make changes without prior notice.
- The original version of this user manual is written in British English. Therefore, there may be certain differences between the descriptions in the manual and the actual car.
- The descriptions in this manual are based on general usage conditions. Remember that they can change depending on location, environment and driving behaviour.
- No illustrations or texts in this manual may be copied without permission from Volvo.

[1] Availability may vary between regions and equipment levels.

1.1.1. Reading the user manual

Learn how this user manual's content is organised so that you can find what you need, when you need it.

Your car's user manual is designed to guide you, both when you're looking for a specific piece of information and when you're simply exploring to learn more about your car.

Structure

This manual is a large network of informational pages. Each page has its own content and might have a list of links that take you to related pages. The links can take you to sub-sections of the one you're in or to other sections with a connection to what you're currently reading.

 **Tip**

Find the right level of information

Sometimes the answer to what you're looking for might not lie in the details. Moving up a level or two in the structure might provide the context and perspective you need, or just a better idea of where to look.

Search for information

You can use the search field for quicker access to what you are looking for.

All main areas

To get you started, the related information links on this page include all of the main sections in this user manual.

Navigate through interactive images

Some of the manual's pages have images with interactive markers. You can tap these markers to reveal links to relevant parts of the manual. These interactive markers allow you to explore the user manual in a more visual way.



Tip

Animated introductions

Some pages show a short animation as an introduction. This provides you with a few visual hints of what you can expect to find in that part of the user manual.

Images and videos

Images in the user manual are sometimes schematic and intended to give an overview or an example. Images can differ from your car due to equipment level or market requirements.

Highlighted content

You can find content that is highlighted in various ways throughout this user manual.



Warning

Content highlighted like this primarily informs of conditions or use with obvious potential to cause severe harm to health.



Important

Content highlighted like this primarily informs of conditions or use with a clear potential to cause material damage.



Note

Content highlighted like this primarily contains information that can help avoid incorrect use, or information that is easily missed or misunderstood.



Tip

Content highlighted like this primarily provides tips for use or where to find related content.

Equipment, accessories and features

Some equipment, accessories and features might be limited or only available for certain car configurations or markets. Even if the information is available to you, it does not guarantee that the specific equipment, accessory or feature described is available in your car.

**Note**

There may be differences in terminology between the manual and materials for marketing, sales and advertisements.

For more information on standard and optional equipment, contact Volvo support.

1.2. Customer support and contact information

Should you have any questions regarding your car, you can find answers or solutions in a number of places. In addition to searching the user manual you are reading now, you can visit Volvo's website, Volvo's support site or contact Volvo Assistance.

Website and support site

Volvo's website [volvocars.com](https://www.volvocars.com) [<https://www.volvocars.com>] has several customer support resources.

The support section [volvocars.com/intl/support](https://www.volvocars.com/intl/support) [<https://www.volvocars.com/intl/support>] provides contact information, software news and answers to frequently asked questions. You can also find your closest Volvo dealer or contact Volvo via phone or chat.

Volvo Assistance

Volvo Assistance can offer help in the event of a breakdown or if your car unexpectedly becomes immobilised. This includes roadside assistance. Volvo Assistance is available 24 hours a day, 7 days a week.

Press the assist button  in the car's ceiling or use the mobile app for the car to contact Volvo Assistance.

1.3. Driver responsibility

As a driver, you are responsible for doing everything possible to ensure your own safety as well as that of your passengers and other road users.

Your knowledge, decisions and actions determine how safely you drive. Your car has features that, in certain situations, can compensate for mistakes and lapses in judgement. However, they do not change where the responsibility lies. They are a supplement to good driver practices, which you are responsible for as a driver.

You have likely studied and trained to ensure you have the necessary knowledge and abilities to be a safe driver. This section covers a few essentials you may recognise, such as:

- Driving and using driver support functions
- Knowing the car's capabilities and limitations
- Driver distraction
- Driver fatigue
- Laws and regulations

The content of this manual represents the status of the user manual at the time of printing and may not be completely valid in future instances. For more information, refer to the first page for the complete disclaimer note.

Driving and using driver support functions

You are responsible for adapting your driving to the current conditions, even when using driver support functions. This includes adapting your distance to other vehicles and speed as well as being ready to react to traffic and road hazards. The car's safety interventions and warnings rely on accurate detection and identification of surrounding traffic and road conditions. The detection systems cannot handle all driving, traffic, weather and road conditions.

Note

Driver support

Driver support functions can assist you with certain driving tasks and improve driving awareness. When used correctly, they can improve safety and convenience, but they are not a replacement for safe driving practices. Drive the car with the same attention to safety as required by a car without these functions.

Knowing the car's capabilities and limitations

Before driving, all drivers are recommended to familiarise themselves with the car and any functions and features they might use. The driver has a responsibility to ensure they have sufficient knowledge of the car to use it safely.

If you are uncertain about any of the car's functions or have questions about its intended use, consult the manual. If you can't find the information you need, contact Volvo support.

Driver distraction

Distractions reduce your attentiveness and focus when driving. As a driver, you are always responsible for assessing whether a task is safe to perform. Your assessment should take the situation as a whole into account, as well as specific conditions and circumstances that can cause distraction. It might be safe to adjust the volume when you're driving on a straight empty road, but not in more demanding situations such as when overtaking.

Warning

Avoid distractions

Any task that prevents you from keeping your attention on the road and surrounding traffic should only be performed when the car is parked. A few examples include:

- Do not hold your phone while driving. Local laws often restrict or forbid phone use while driving.
- Do not manually change the navigation route while driving.
- Do not change detailed sound settings while driving.

Driver responsibility and safety features

Your car has several safety features designed to reduce the risk of an accident. They do not reduce the driver's responsibility to remain attentive, nor the need to operate the car as safely as possible.



Tip

Help from passengers

Tasks that risk distracting the driver can often be done by a passenger instead. However, certain actions are simply not available in the car when driving, such as reading this manual in the centre display. For these actions, you need to be parked.

Voice commands

Voice commands can, in some situations, be less distracting than manually doing the same task.

Driver fatigue

The driver is always responsible for being well-rested. Your car has some functions with abilities to warn you if you show signs of fatigue. It's important to always stop and take a break at the slightest feeling of fatigue, regardless of whether a function has given you a warning.

Laws and regulations

The driver is always responsible for knowing and following local laws and regulations. If you drive to a region with other traffic laws, make sure that the car is equipped as required and read up on which traffic laws differ from what you're used to.

1.4. Modifications, repairs and accessory installations

Modifications^[1], repairs and installation of accessories or extra equipment requires proper knowledge and quality of both work and parts. Otherwise, they risk impairing your car's functionality and safety. Contact a Volvo dealer before making any alterations to your car.

For any alterations^[2] to the car, Volvo strongly recommends that:

- you seek prior advice of a trained and qualified Volvo service technician.
- work is only carried out by trained and qualified Volvo service technicians.
- installed parts and accessories are approved by Volvo.^[3]
- parts and accessories are fitted according to their installation instructions.
- they comply with local laws and regulations.^[4]

Contact a Volvo dealer for more information.

 **Warning**

Systems can be negatively affected

Unapproved or incorrectly installed accessories can negatively affect your car's performance, communication and safety systems. Certain accessories only work with associated software that needs to be installed in the car.

Electrical installations

For additional electrical installations, it is essential that appropriate connection points are used to ensure the integrity of the car's electrical system. The car has a specific ground attachment point designated for aftermarket installations, which is separate from those reserved for critical components. Volvo recommends an authorised Volvo workshop for any electrical installations.

End-of-life handling

Some parts of the car are dangerous to handle. Special handling is required when servicing, or scrapping after the car has reached its end-of-life.

- Electrical components in the car^[5] may contain harmful substances and can deliver lethal electrical currents if handled incorrectly.
- Components such as airbag modules, seatbelt tensioners, adaptable steering columns and button cell batteries may contain perchlorate materials.

 **Note**

Non-approved changes and liability

Volvo does not accept any liability for damage, incurred cost, personal injury or death that is caused by changes to the car^[6] not approved by Volvo.

^[1] Modifications include changes to the car's software, including but not limited to tuning.

^[2] Meaning modifications, repairs and installation of accessories and extra equipment.

^[3] Accessories that are not approved by Volvo may not have been specifically tested for use with your car.

^[4] Applies to both the act of making the alteration and subsequent use of the altered car.

^[5] Such as batteries

^[6] Including but not limited to modification, repair and installation of accessories or extra equipment.

1.5. Finding the vehicle identification number

There are several ways to find your car's unique vehicle identification number.^[1] You might need your car's VIN if you contact Volvo about any questions or problems regarding your car.

Find the number in one of the following ways:

- In the centre display.

The content of this manual represents the status of the user manual at the time of printing and may not be completely valid in future instances. For more information, refer to the first page for the complete disclaimer note.

- On a label on the dashboard, close to the windscreen's lower edge. It can typically be read from outside the car.
- In the car's registration documentation.
- By contacting a service technician who can retrieve it through the on-board diagnostics socket.

In the centre display

1. Press the car symbol  in the bottom bar and go to **Settings**.
2. Go to **System** → **About** → **VIN number**.

^[1] VIN

1.6. Approval of terms and conditions and data collection

You will see messages about different terms and conditions and data collection ^[1] in the centre display. Your agreement is necessary for certain apps and services to work properly.

The first time you use your car, a guide opens in the centre display to assist you to make various settings. In connection with the guide, you are prompted to give your agreement to different types of terms and conditions and collection of information. You can do this later in privacy settings as well.

You may also need to give your consent, for example, when you:

- Use an app or service for the first time.
- Add a new profile.
- Delete a profile.
- Change the ownership of the car.
- Reset user data or do a factory reset.

Note

Accept Google's terms and conditions

Not accepting Google's terms and conditions limits the availability and performance of certain features such as Pilot Assist, map features and voice control.

General Privacy Notice

Depending on your market, Volvo Cars may collect and process different types of personal data for various purposes. You can find more information about how Volvo Cars processes your personal data in the Volvo Cars Privacy General Privacy Notice available at Volvo's website. If there are any differences between the user manual and the privacy notice related to the processing of personal data, the privacy notice takes precedence.

Accept privacy settings

1. Press the car symbol  in the bottom bar and go to **Settings**.
2. Go to **Privacy**.
3. Select the privacy setting you want to change and follow the instructions in the centre display.

Important

Accept privacy settings

If you decide not to accept privacy settings, you may not experience full functionality from apps and services.

Note

Volvo services

You can manage your consent to data sharing with Volvo here.

Before using the internet

The terms of use must be accepted once per car to use the internet.

Car location sharing

You need to enable location sharing in your car to use certain apps and functions. For example, location sharing is required to use remote vehicle services via Volvo Assistance and for apps such as Find my car and the Trips app.^[2] Map features also rely on location sharing. If you disable location sharing via the privacy settings, location sharing is also disabled for any features or apps that use it.

^[1] Data is collected to provide better car, safety and app functions.

^[2] The Trips app can then collect data such as the car's position, speed, mileage and power consumption.

1.7. Handling of recorded and collected data

Certain information about the car's status and operation is recorded and collected for quality and safety reasons. This can provide an understanding of the circumstances around traffic accidents involving the car and other usage scenarios.

Event Data Recorder (EDR)

This vehicle is equipped with an Event Data Recorder. Its primary purpose is to register and record data related to traffic accidents or collision-like situations, such as times when the airbag deploys or the vehicle strikes an obstacle in the road. The data

is recorded in order to increase understanding of how vehicle systems work in these types of situations. The EDR is designed to record data related to vehicle dynamics and safety systems for a short time, usually 30 seconds or less.

The EDR in this car is designed to record data related to the following in the event of traffic accidents or collision-like situations:

- How the various systems in the car worked.
- Whether the driver and passenger seatbelts were fastened or tensioned.
- The driver's use of the accelerator or brake pedal.
- The travel speed of the car.

This creates a better understanding about the circumstances in which traffic accidents, injuries and damage occur. The EDR only records data when a non-trivial collision situation occurs. The EDR does not record any data during normal driving conditions. Similarly, the system never registers who is driving the vehicle, or the geographic location of the accident or collision-like situation. However, other parties, such as the police, could use the recorded data in combination with the type of personally identifiable information routinely collected after a traffic accident. Special equipment and access to either the car or the EDR is required to be able to interpret the registered data.

Additional recorded data

In addition to the EDR, the car is equipped with a number of computers designed to continually check and monitor the function of the car. They can record data during normal driving conditions, but in particular register faults affecting the car's operation and functionality, or upon activation of the car's active driver support function.

Some of the recorded data is required to enable service and maintenance technicians to diagnose and remedy any faults that occurred in the car. The registered information is also needed to enable Volvo to satisfy legal requirements laid out in laws and by government authorities. Information registered in the car is stored in its computer until the car is serviced or repaired.

In addition to the above, the registered information can be used in combined form for research and product development with the aim of continuously improving the safety and quality of Volvo cars.

Volvo will not contribute to the above-described information being disclosed to third parties without the car owner's consent. To comply with national legislation and regulations, Volvo may be forced to disclose information of this nature to the police or other authorities who may assert a legal right to access such information. Special technical equipment which Volvo and workshops that have entered into agreements with Volvo have access to is required to be able to read and interpret the recorded data. Volvo is responsible for ensuring that the information, which is transferred to Volvo during servicing and maintenance, is securely stored and managed and that its management complies with relevant legal requirements. For further information, contact a Volvo dealer.

1.8. About connected services and fair use policy

Use of your car's connected services is subject to certain conditions.

Fair use policy

Your use of connectivity services which are part of your vehicle is subject to this fair use policy.

When using these services you agree not to:

- submit content that is unlawful, obscene, libellous, threatening, harassing, hateful, racially or ethnically offensive or otherwise inappropriate

The content of this manual represents the status of the user manual at the time of printing and may not be completely valid in future instances. For more information, refer to the first page for the complete disclaimer note.

- use the services in breach of any applicable law
- use the services for commercial purposes.

Your access to these services is part of a shared access. Volvo reserves the right to suspend your access to or use of the services if your use involves very high volumes of data, disproportionate to other users. Volvo may also suspend your access for technical reasons or to protect other functions of your vehicle.

1.9. Changing ownership of the car

The driver of the car must be registered with Volvo in order to use all available functions and services. Therefore, in connection with a change of ownership, the current owner needs to be removed to give the new owner access.

The current owner needs to end their ownership by removing their Volvo ID from the car. This can be done in the mobile app for the car or by visiting a Volvo dealer. The new owner can also get help with registering their ownership from a Volvo dealer.

Note

Reset the car

When the current owner has ended the ownership, an automatic factory reset of the car takes place. This means that profiles, user data and other individual settings are removed.

No owner?

If the car doesn't have an owner, you can claim the ownership by connecting your Volvo ID to your profile in profile settings via the centre display. Make sure that you have two keys in the car as you will need both of them for the setup process.

1.10. Resetting user data

You can reset the user data and system settings in the centre display.

You can reset the app settings or network settings to their standard values or do a complete factory reset. If you do a factory reset, you will delete profiles, keys, user data and other customised settings.

Note

Only the owner can reset the network settings and do a factory reset.

Volvo Cars app connection

If you do a factory reset in the car, the Volvo Cars app will still be connected and may recreate your profile using cloud data. To avoid this, you need to remove the car connection in the Volvo Cars app.

1. Press the car symbol  in the bottom bar and go to **Settings**.
2. Go to **System** → **Reset options**.
3. Select what you want to reset and follow the instructions in the centre display.

1.11. Recommendations when changing regions

When relocating or importing your car to a new region, you need to register your car and Volvo ID there. This is to make sure that digital services work correctly and that the car follows local laws and regulations.

To get help registering your car in a new region, contact Volvo support.

 **Note**

Available services can vary over time and depend on region. This may also have an effect when you're visiting another region temporarily.

2. User accounts, profiles and services

Get more out of your car by customising it using profiles and connecting it to the phone app. This gives you access to more features and services, such as support if you're having issues on the road.

Note

Some of the services available for your car require a registered personal account, such as your Volvo ID.

To get the most out of your car experience:

- Connect your Volvo ID
- Download and sign in to the Volvo Cars app on your phone
- Set up your user profile and customise the car's settings, such as the ergonomic settings and other preferences
- Sign in with your Google account

2.1. Setting up your car for the first time

There is a guide that helps you set your car up the first time you use it.

The setup guide for your car automatically starts in the centre display. It guides you through setting up a profile and other essential settings.

Tip

Before getting your car

Before you start, you will need to create a Volvo ID and download the Volvo Cars app. This makes the in-car setup faster.

The setup guide covers the following:

- Important settings, such as your car's system language
- Connecting the car to your Volvo ID and the Volvo Cars app
- Consent to terms and conditions for various car services, including third party services
- Setting up internet access
- Consent to software updates
- Setting up a profile

 **Note**

Stay parked during setup

The car needs to be stationary and in P when you go through the setup guide.

Complete setup

It's advisable to complete the setup before driving the car. If you exit the guide before going through the necessary steps, certain features will be unavailable until you go back and complete the process. You will also be reminded about the setup the next time you drive the car.

No guide?

If the car has already been set up by someone else, such as a previous owner, you can reset the car to access the setup guide again.

2.2. Volvo ID

Your Volvo ID is a personal account that gives you access to various services connected to your car.

You will need your Volvo ID when you use remote features via the Volvo Cars app.

 **Note**

Available services can vary over time and depend on both region and equipment level.

2.2.1. Creating a Volvo ID

Create your Volvo ID in the Volvo Cars app on your phone or on Volvo's website.

If you want to use the Volvo Cars app to create your Volvo ID, make sure that you have the latest version installed on your phone.

1. Open the app on your phone or go to [volvocars.com](https://www.volvocars.com) [<https://www.volvocars.com>].

Note

If you use the website, make sure that you are signed in.

2. Select the option to create a new Volvo ID and follow the instructions.

Note

After creating your Volvo ID, you may need to confirm your email address to fully activate your account.

2.3. Volvo Cars app

The Volvo Cars app allows you to control certain functions and interact with the car via your phone.

The Volvo Cars app is available for iPhone and Android phones. You can download it for free from your phone's app store. The app is updated regularly, so make sure that you have the latest version on your phone.

Note

Sign in with your Volvo ID

You need to sign in to the app using the same Volvo ID that's connected to your profile in the car.

Give your consent

Give your consent to Volvo services in privacy settings to be able to connect the app to the car.

Check the internet connection

The Volvo Cars app and your car need to be connected to the internet for all services to work properly.

Here are a few things you can do in the Volvo Cars app:

- Check the battery level, lock status, window status and other car statuses

- Lock and unlock doors
- Start and stop parking climate control
- Contact Volvo for more assistance
- View your account information

 **Note**

Available services can vary over time and depend on region.

2.4. Getting started with Google services

Signing in with your Google account gives you a personalised experience when using Google services and apps such as Maps.

To sign in to your Google account and take full advantage of Google services, the car needs to be connected to the internet.

1. If you don't already have a Google account, go to accounts.google.com/signup [https://accounts.google.com/signup] and create one.
2. Sign in using your Google account via the car's centre display and follow the instructions.

2.5. Customisation and settings

You can customise many of your car's features and behaviours by accessing its settings.

Where to find settings

Settings and adjustments are available in the following places:

- The settings tab in the display contains most of your car's settings and adjustments. To access it, press the car symbol  in the bottom bar and go to **Settings**. There are several categories to explore within the tab.
- Some views and in-car apps have their own settings sections. Open the app or view and look around to find available customisation options.
- The mobile app for the car has settings related to remote and connected features.

Setting types

Your car's settings apply differently depending on their type. Most settings are specific to a user profile, but some apply to all users of the car. A few settings are only available to adjust when the owner profile, which has administrative privileges, is in

use.



Tip

Customised experience

Set up user profiles for all drivers to get a customised experience. There are many profile-specific settings that are applied automatically when you select your profile.

Some settings apply indefinitely from the moment you change them, while others may only be temporarily applied, such as until the end of the current drive.

2.6. Car user profiles

For a more customised experience, you can set up user profiles for different drivers.

To access all of your car's features, you need to set up the owner profile. You can then add co-driver profiles for more users. Having individual user profiles allows each driver to save customised settings and adjustments which are automatically applied when their profile is selected.

Profile type	Who uses it?
Owner	The permanent user profile for the owner of the car.
Guest	A guest user profile that's available for temporary users of the car.
Co-driver	Up to five additional user profiles for regular users of the car.

The owner has all the administrative privileges while the co-drivers have some of them. The guest can make some adjustments but that profile resets when you start using another profile.

You can find the profile settings in settings, where you can do the following:

- Add and switch profiles
- Restrict access to your profile
- Connect the Volvo Cars app to the car
- Connect keys to your profile
- Change your profile name
- Remove your profile, if you are a co-driver

2.6.1. Switching profiles

You can switch between profiles in the centre display.

 **Note**

Only available while stationary

It's only possible to switch profiles when the car is stationary and in P. It's also unavailable during certain tasks.

Can't switch?

If you have problems switching to another profile, you will use the guest profile. Try again later.

Locked profile?

You might need a PIN or pattern to unlock a profile before using it. If it's not your profile, you can switch to your own profile instead.

1. Press the car symbol  in the bottom bar and go to **Settings**.
2. Go to **Profiles**.
3. Select your profile.

2.6.2. Adding a profile

You can add new profiles in the centre display.

When you add a new profile, the setup guide starts automatically in the centre display. It guides you through all of the essential settings.

Note

If you don't complete the setup guide, some features and services will be unavailable.

Tip

The owner can also create new profiles in the Volvo Cars app by inviting a new co-driver to link their Volvo ID to the car.

Add a profile in profile settings

1. Press the car symbol  in the bottom bar and go to **Settings**.
2. Go to **Profiles**.
3. Press **Add new** and follow the instructions in the centre display.

2.6.3. Removing a profile

You can remove your user profile in the centre display.

Note

You cannot remove the owner or the guest profile, but you can reset them. If you want to reset the owner profile, you need to do a factory reset. The owner profile also resets when you end your ownership. The guest profile resets when you switch to another profile.

Tip

The owner of the car can also remove user profiles from the car via the Volvo Cars app.

1. Press the car symbol  in the bottom bar and go to **Settings**.

2. Go to **Profiles**.
 3. Select **Remove this profile**.
- > The car will switch to the guest profile automatically.

Note

If you have a Volvo ID connected to your profile as a co-driver, you cannot delete your profile. You can only remove your profile from the car.

2.6.4. Assigning a key to a profile

You can assign keys to your profile. Choose a distance-capable key or key card.

In the setup guide

You can assign a key to the owner profile during the setup guide. When it's time, place your key on the NFC^[1] reader and follow the instructions in the centre display. You can also do it later in profile settings.

Note

If you want to assign a digital key to your profile, you have to create a digital key first.

Tip

Assign a key to your profile so that your profile is automatically selected when you unlock the car or unlock the driver door using the key. If you use a key that's not assigned to any profile, the guest profile will be automatically selected.

Assigning a key to a profile in Profile settings

1. Press the car symbol  in the bottom bar and go to **Settings**.
2. Go to **Profiles** → **Car keys**.
3. Select the key you want to assign and follow the instructions in the centre display.

^[1] Near field communication

2.6.5. Managing keys assigned to profiles

You can manage your assigned keys in profile settings.

Note

What you can manage

A co-driver can only disconnect their own connected keys. The owner can change the primary key as well as disconnect or remove all of the connected keys.

Changing a key

You can only change the primary key. For any other keys, you can disconnect the old key and then connect the new key to your profile.

1. Press the car symbol  in the bottom bar and go to **Settings**.
2. Go to **Profiles** → **Car keys**.
- > You will see a list of all the assigned keys.
3. Select the key you want to manage and follow the instructions in the centre display.

Tip

New phone?

The owner can change the primary key if it's already assigned to their profile. To do this, select the primary key and press **Change device** in the centre display and follow the instructions. You will need your new phone to scan a QR code and your Volvo ID that's linked to the car to log in.

2.6.6. Restricting access to a profile

You can restrict access to a profile by adding a profile lock in the centre display. When a profile lock is active, you need a PIN or pattern to unlock the profile.

1. Press the car symbol  in the bottom bar and go to **Settings**.
2. Go to **Profiles** → **Profile lock**.
3. Select your preferred lock type and follow the instructions in the centre display.

2.6.7. Adding an account to a profile

You can add different accounts to your profile, such as your Google account and accounts from third-party apps.

1. Press the car symbol  in the bottom bar and go to **Settings**.
 2. Go to **Profiles** → **Accounts**.
 3. Select **Add account**.
- > You will see a list of possible accounts to add.
4. Select the account you want to add and follow the instructions in the centre display.

If you want to remove an account from your profile, select the account and press **Remove**.

2.7. Volvo Assistance

Volvo Assistance is a service that provides assistance and remote access to certain car features. You can contact a Volvo Assistance service centre at any time for assistance.

If you experience any unpredictable problems on the road, you can call Volvo Assistance. This includes if:

- your car's battery runs out of charge
- your car breaks down
- you get a puncture.

Volvo Assistance is available in the Volvo Cars app and by pressing the assist button  in the car's ceiling.

Note

Not for emergencies

If you need assistance in an emergency situation, press the SOS button instead. Situations that could require immediate emergency assistance include traffic accidents, acute illness and external threats.

An included service

Volvo Assistance is included with new Volvo cars for the first few years of ownership.^[1] For more information regarding your car, contact Volvo support or a Volvo dealer.

 **Note**

If you don't have a Volvo Assistance agreement, you will still be able to use the service for an extra cost.

Terms and conditions

Volvo Assistance is intended to be active for as long as the car is used and the technology it relies on is supported, such as the car's mobile network connectivity.

Certain information, including personal data, needs to be shared with Volvo in order to use Volvo Assistance.

 **Note**

Volvo reserves the right to reduce Volvo Assistance functionality that is deemed no longer practically possible to maintain.

If a car remains unused for more than one year, it is considered no longer in use.

If you need any help or have any questions regarding Volvo Assistance, contact Volvo support.

^[1] Availability and inclusion with new cars varies between regions.

2.7.1. Calling Volvo Assistance for roadside assistance

You can press the assist button in the car's ceiling to contact Volvo Assistance for roadside assistance^[1]. For example, if you experience any unpredictable problems on the road, such as if your car's battery runs out of charge, your car breaks down or you get a puncture.

 **Note**

Not for emergencies

If you need assistance in an emergency situation, press the SOS button instead. Situations that could require immediate emergency assistance include traffic accidents, acute illness and external threats.

Using Volvo Assistance abroad

If you press the assist button  when you are abroad, you will reach Volvo Assistance in your home country.

 **Tip**

You can also use the mobile app for the car to contact Volvo Assistance.



The assist button is located in the ceiling, on the right side of the overhead console.

1. Press and hold the assist button for at least 2 seconds.



- > The car makes a voice call to Volvo Assistance. It also sends information such as its location and status. The Volvo Assistance call centre tries to communicate with the people in the car to find out what kind of help you need.

If the voice call fails, the Volvo Assistance call centre has the ability to respond based on information sent by the car.

^[1] Availability depends on region.

2.8. Emergency assistance

In an emergency, the car can connect you to an emergency call centre. This is done automatically in response to severe collisions or manually by pressing the SOS button in the ceiling. ^[1]

Note

Strictly for emergencies

Situations that could require immediate emergency assistance include traffic accidents, acute illness and external threats.

Built to work after a collision

Calling an emergency call centre after a collision requires that the system is not critically damaged. The system is designed to survive severe collisions and has its own backup battery in case the regular power supply fails.

When an emergency call is made, the following happens:

1. The car makes a voice call to an emergency call centre. It also sends information such as its location and status.
2. The emergency call centre tries to communicate with the people in the car to find out what kind of help you need.
3. If the voice call fails, the emergency call centre has the ability to respond based on information sent by the car.

Using the SOS button

The SOS button is located in the ceiling, on the left side of the overhead console. You can read more about using the SOS button in a separate section of the manual.

When the emergency assistance system is working normally, the SOS button LED is white. In other cases, the light may change to red or flash with varying intervals.

LED behaviour	Description
Blinking	The system is performing a self-check.
Solid red with SOS symbol showing in the driver display	The system has detected a critical fault. Immediate service is recommended.
Solid red without SOS symbol showing in the driver display	The system has detected a fault. It may still work but should be checked.
Moderate flashing	An emergency call is starting.
Rapid flashing	The system is transmitting data to the emergency services.
Slow flashing	The system is connected to the emergency services.
Solid white	The system is working normally.

Automatic emergency response

The car automatically attempts to contact an emergency call centre if it registers a collision above a certain level of severity.^[2]

In situations where the driver is unable to continue driving, the car can perform a controlled stop to reduce the risk of a collision. If this happens your car can automatically connect you to an emergency call centre.^[3]

Note

Not an emergency?

If you need help on the road but aren't in an emergency situation, press the assist button  to call Volvo Assistance instead. Volvo Assistance can help you in certain situations, such as if your car's battery runs out of charge, your car breaks down or you get a puncture.

^[1] Availability varies between regions. Contact Volvo support for more information.

[2] For example, when safety features such as airbags or seatbelt pretensioners have deployed.

[3] The availability of this feature may differ between regions.

2.8.1. Calling emergency services with SOS button

A long press of the SOS button in the car's ceiling connects you to an emergency call centre.^[1]

Note

Strictly for emergencies

Situations that could require immediate emergency assistance include traffic accidents, acute illness and external threats.

Not an emergency?

If you need help on the road but aren't in an emergency situation, press the assist button  to call Volvo Assistance instead. Volvo Assistance can help you in certain situations, such as if your car's battery runs out of charge, your car breaks down or you get a puncture.

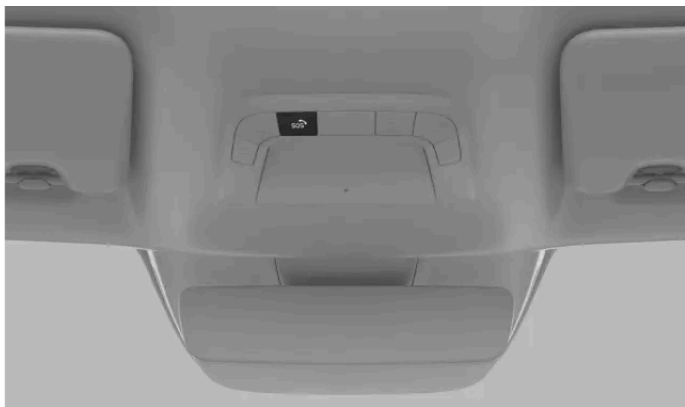

The SOS button is located in the ceiling, on the left side of the overhead console.

1. Press and hold the SOS button for at least 2 seconds.



- > The car makes a voice call to an emergency call centre. It also sends information such as its location and status. The emergency call centre tries to communicate with the people in the car to find out what kind of help you need.

If the voice call fails, the emergency call centre has the ability to respond based on information sent by the car.

[1] Availability varies between regions.

2.8.2. Changing emergency call recipient

When pressing the SOS button, your car will make a call to a Volvo emergency service by default. If you want your car to call an emergency centre instead, you need to change it in your profile settings.

Note

Default settings

In some regions, the car calls an emergency centre by default instead of Volvo's emergency service.

Unable to change recipient?

The ability to change emergency call recipient depends on your region and may vary over time.

1. Press the car symbol  in the bottom bar and go to **Settings**.
 2. Go to **Controls** → **More** → **SOS button calls Volvo Cars emergency service**.
 3. Select one of the options.
-

3. Displays, software and phone

Explore how to interact with your car. Here's where you can find more information on your car's displays, connectivity features, sound and media, in-car apps, software and voice control.



You can access most of your car's functions via its displays, but there's also plenty you can do by using your phone.

An internet-connected car makes remote access possible and keeps the car up to date by downloading software updates. Learn how it's all connected.

3.1. Displays

The different displays show you information related to the car and your driving. You can also control many of the car's functions by interacting with the displays.

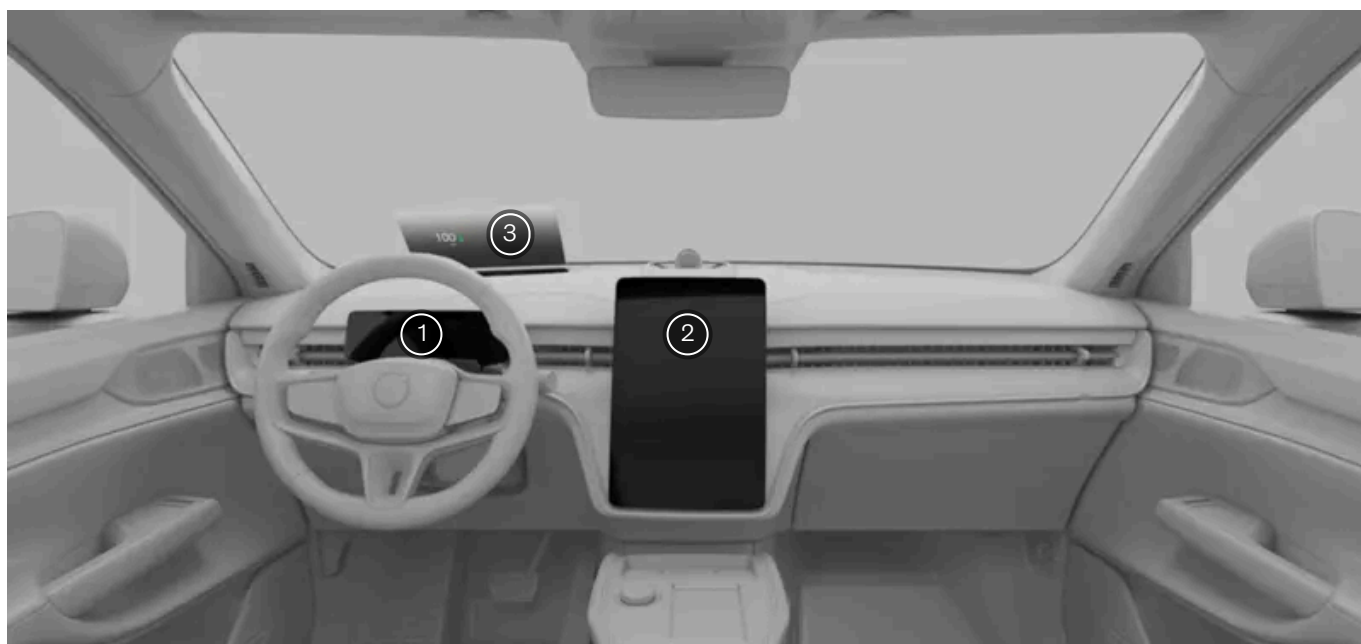

Locations of the displays

- ① Driver display
- ② Centre display
- ③ Head-up display

i Tip

You can adjust the brightness for all of the displays via the lights and displays settings in the centre display.

3.1.1. Centre display

Interact with the centre display to control and view information about many of the car's features and functions.

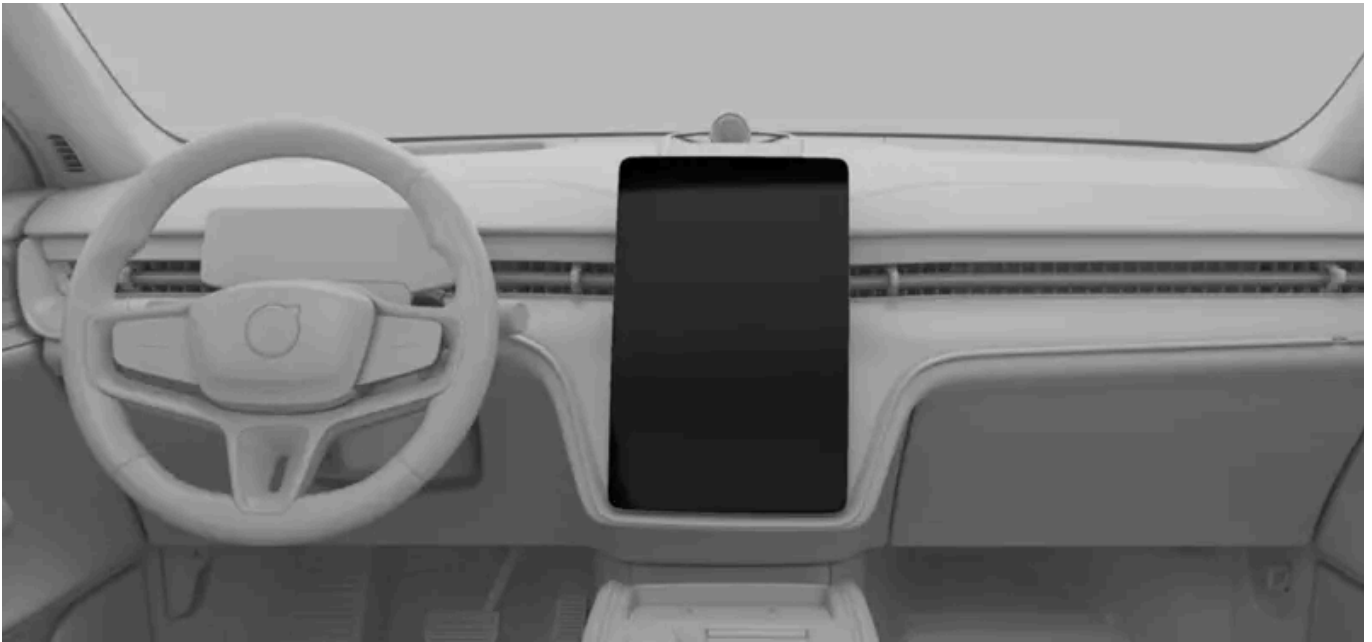

The centre display sits in the middle of the dashboard.

Frequently used features such as climate, car status and the app library can be accessed by pressing the symbols at the bottom of the display.

Examples of functions that can be viewed and controlled via the centre display are:

- Navigation
- Media players
- In-car apps
- Phone

 **Important**

Do not use sharp objects on the centre display as they may cause damage.

3.1.1.1. Centre display views

Learn about some of the views that you can see in the centre display.

The different bars provide status information, display shortcuts to apps or quick controls, and allow you to navigate around the centre display views. The main views let you use and access navigation information, in-car apps, climate, car status and settings. There are also some specialised views for managing specific car functions.

Centre display bars







The content of this manual represents the status of the user manual at the time of printing and may not be completely valid in future instances. For more information, refer to the first page for the complete disclaimer note.

The status bar at the top of the centre display shows you symbols relating to the car's status and apps, along with the time and outside temperature. The bottom bar is your main way of navigating around the centre display views. By pressing the symbols, you can get to other views and functions as well as access the comfort view and activate the hazard warning lights. The status bar and bottom bar are always visible, regardless of which view you are looking at.

In some views, you will see the contextual bar appear above the bottom bar. This bar contains shortcuts to recently used functions or apps that only appear when you can use them. Sometimes these shortcuts are replaced by quick controls which allow you to control ongoing phone calls and media when the associated views or widgets aren't visible.

Main views

The following list contains the main views that you will see and use in the centre display.

Home view	The home view shows a large navigation map and so it also works as the navigation view. There are widgets with quick controls for media and phone underneath the map. The home view is accessed from other views by pressing the home symbol  in the bottom bar.
App library	You can access the manual, in-car apps and the app store in this view. To get to this view, press the app library symbol  in the bottom bar.
Climate view	You can change a variety of climate settings in this view, such as activating or deactivating defrosters and adjusting settings for air conditioning. The climate view is accessed by pressing the fan symbol  in the bottom bar.
Car overview	This view gives you access to the quick controls, settings and car status tabs as well as user profiles. These come together to give you an overview of the car which can be accessed by pressing the car symbol  in the bottom bar.
Quick controls view	This view gives you quick and easy access to some of the car's functions, such as exterior lights and driver adjustments. You can get to the quick controls view by pressing the car symbol  in the bottom bar.
Settings view	This view is where you can access all of the different settings tabs and views for your car. You can get to the settings view by pressing the car symbol  in the bottom bar.
Car status view	This view shows you important information relating to your car's status, such as issues that need resolving and the severity of them. You can also see the odometer and when your car is due for a maintenance appointment. It can be accessed by pressing the car symbol  in the bottom bar.

Specialised views

The following views are related to specific functions in the car.

Comfort view	The comfort view appears when you press the seat symbol in the bottom bar that corresponds to the driver or passenger side. This view gives each side quick access to a few essential climate and comfort settings, such as seat heating and temperature control.
Adjustments view	You can adjust the seats, wing mirrors, steering wheel and head-up display in the adjustments view. These are grouped together because they relate to your driving position. For example, if you change your seat position, you probably also need to adjust the wing mirrors, steering wheel height and head-up display.
Parking view	The parking view contains features that help you park. When shown, it takes up most of the centre display. If the parking view doesn't automatically appear when you need it to, you can open it yourself by pressing the camera symbol  in the contextual bar above the bottom bar.

Note

Driver distraction overlay

What you can see and do in the centre display sometimes depends on whether the car is moving or not. To minimise driver distraction while the car is moving, some views become unavailable, such as certain settings. If this happens, the centre display shows the driver distraction overlay. When the car stops moving, the overlay disappears and you can interact with the view again.

3.1.1.2. Status symbols in the centre display

Status symbols are shown in the status bar at the top of the centre display. The symbols tell you important information about your car's system status.















Symbol types

Some status symbols, such as the clock and temperature, will always be visible in the status bar. Others are only visible when a particular function is active, such as wireless charging, or even disabled. You will also see symbols that tell you when there is an error, such as when you have a Wi-Fi or mobile internet connection issue.

Note

Make sure you look up any status symbols that you are unfamiliar with. They might not appear with any extra information or notifications.

This is a list of some status symbols that can appear in the status bar. It is not an exhaustive list and you might also see status symbols in the status bar from third-party apps.

	Clock	The clock shows you the current time. You can choose whether to display the time in the 12-hour or 24-hour format.
	Outside temperature	This is the current ambient temperature outside of the car. You can choose to have the temperature displayed in degrees Celsius or Fahrenheit in the car's system settings.
	Outside temperature with snowflake	This is the current ambient temperature outside of the car. The snowflake appears when the outside temperature is low.
	Microphone is listening	The microphone is active and recording.
	Microphone is not listening	The microphone is not recording.
	New notification	There is a new notification in the notification centre.
	Mobile internet signal	Mobile internet is active and being used by the car. The number of bars indicates the signal strength.
	Mobile internet error	There is an issue with the mobile internet connection.
	Wi-Fi signal	Wi-Fi is enabled and active. The number of bars indicates the signal strength. If no bars are shown, this indicates that a Wi-Fi connection is active but there is no signal.
	Wi-Fi internet error	There is an issue with the Wi-Fi internet connection.
	Bluetooth connected	Bluetooth is enabled and a device is connected to the car.
	Location	Your location is being shared.
	Wireless charging active	A device is charging on the wireless charger.
	Software updates available	New over-the-air software updates are available to download and install.



3.1.1.3. Keyboard

The centre display's keyboard appears when you can write text or numbers. You can customise many of its features in settings.

You can use the on-screen keyboard to write text or numbers. For example, when searching for a destination in the navigation app or putting the password in for a Wi-Fi network.

The keyboard's layout can change depending on the type of input field you are writing in.

The keyboard supports some alternative ways of inputting text. These include:

- Glide typing
- Speech to text
- Handwriting



Tip

You can download other keyboards to use by going to the app store in the app library.

3.1.1.3.1. Changing keyboard language

You can change the language for the centre display's keyboard on the keyboard itself.

Change the keyboard language when you want to write text in a different language. This can be useful when you are driving abroad and need to search for a destination or address in the local language.



Note

To be able to change the keyboard language, you need to have more than one language available for the keyboard. If you only have one language available, the languages symbol won't be shown on the keyboard.

Changing language to the next available language

1. Press the languages symbol  at the bottom of the keyboard.
- > The keyboard language switches to the next one in the available languages list.

Changing language to any available language

The content of this manual represents the status of the user manual at the time of printing and may not be completely valid in future instances. For more information, refer to the first page for the complete disclaimer note.

2. Press and hold the languages symbol  at the bottom of the keyboard.
 - > A list of available languages appears.
 3. Select the language you want to use.
 - > The keyboard language changes to the one you selected.
-



3.1.1.3.2. Adding and removing keyboard languages

You can add and remove keyboard languages in settings.



You can add languages to the centre display's on-screen keyboard if you want to write in a language that isn't already available. Languages can also be removed from the keyboard if you find that you no longer need them.

1. Press the car symbol  in the bottom bar and go to **Settings**.
2. Go to **System** → **Languages and input** → **Keyboard**.
3. Choose the keyboard you want to make changes to.
4. Select **Languages**.

Adding a language

5. Press the add symbol  above the currently available languages and search for your desired language.
6. Select the language you want to add, then press the download symbol .
- > The language is added to the list of languages available to use on your keyboard.

Removing a language

7. Press the edit symbol  above the list of currently available languages.
 8. Select the language you want to remove from the list of available languages, then press the rubbish bin symbol .
 - > The language is removed from the list of languages available to use on your keyboard.
-

3.1.2. Driver display

The driver display shows you notifications and information related to your driving and the car itself.

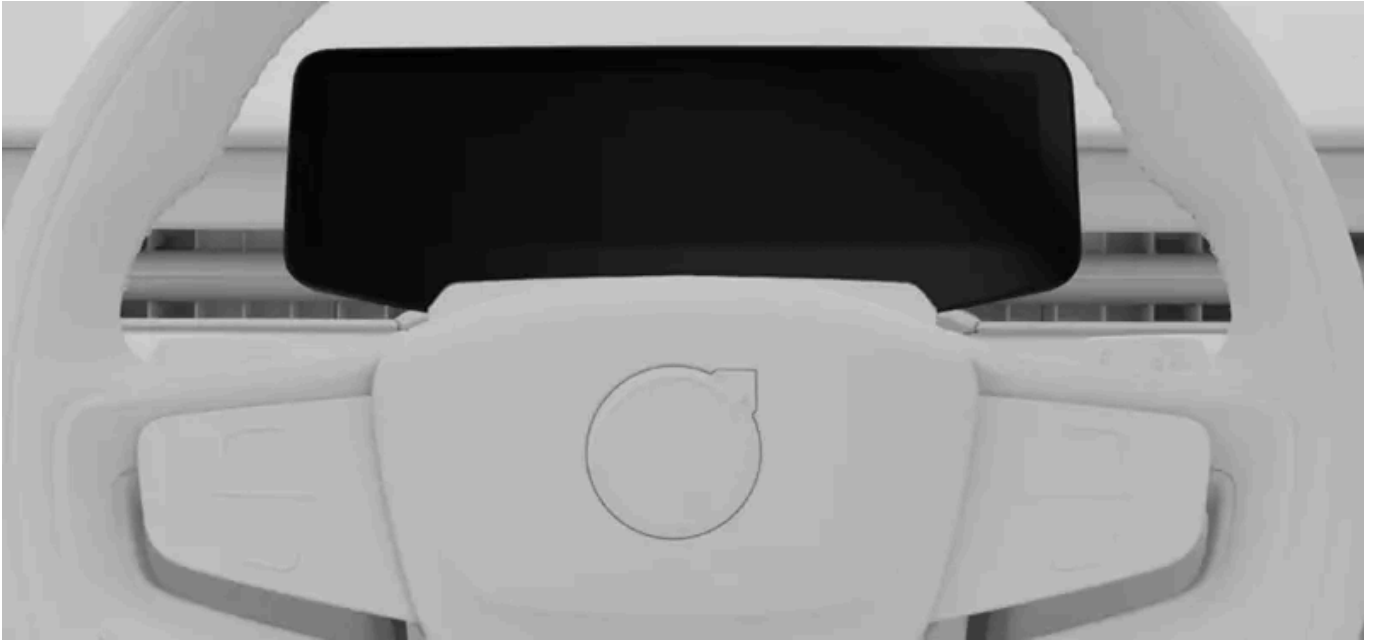

The driver display is located in front of the driver, behind the steering wheel. Its position changes along with the steering wheel when you adjust it to your preferred driving posture.

Use the steering wheel buttons to interact with the display and control what's shown on it.

Examples of information that can be shown in the driver display are:

- Warning and indicator symbols
- Speed
- Navigation
- Driver support information and status
- Notification messages
- Battery meter
- Power meter

Display modes

There are three driver display modes that you can choose from: calm, map and surround. Use the buttons on the steering wheel to change the display mode.

Calm This displays essential information, such as speed, battery level and range, as well as warning and indicator symbols.

Map The driver display shows your current navigation route on a map as well as essential driving and car information.

Surround In this mode, you can see a depiction of the car and its positioning on the road. The same essential information as calm mode is also displayed.

 **Important**

Using surround mode

Surround mode cannot perfectly depict what is really happening on the road around you, so do not rely on it when you are driving.

 **Warning**

If the driver display turns off, doesn't turn on or is only partially legible, you must not use the car. This is because the driver will not receive warnings and car status information shown in the driver display, such as warnings and information relating to brakes, airbags or other safety systems. If there is an issue with the driver display, contact an authorised Volvo workshop.

 **Important**

Clear space around the driver display

Do not hang or place any objects on the steering column in front of or behind the driver display. You risk damaging the driver display if an object is placed there when the steering wheel position changes.

 **Tip**

You can change driver display settings in the centre display.

3.1.2.1. Warning and indicator symbols

The driver display symbols tell you the status of different systems in your car. Some indicate whether a system is active and operating as it should, and others alert you to important information or detected faults.

Symbol types and colours

Some symbols are warnings that require immediate action, while others indicate the current status of specific functions. The symbol colour roughly signifies the level of importance. Red symbols are the most critical while amber symbols represent less urgent warnings and alerts. Symbols of other colours typically convey status information about the car's functions.























 **Tip**

Be sure to look up the meaning of symbols you are unfamiliar with. Many symbols will appear with a notification providing more information.



Brake system warning

A fault is detected in the brake system. Take immediate action and contact an authorised Volvo workshop.

	Parking brake warning	Continuous illumination indicates that the parking brake is engaged. Flashing indicates a parking brake fault.
	System fault warning	A fault is detected in the car system. Take immediate action and contact an authorised Volvo workshop.
	Seatbelt reminder	Someone in the car isn't wearing their seatbelt.
	Emergency call	There is an issue with the emergency call system.
	SRS warning	A fault is detected with the airbags or related safety systems. Take immediate action and contact an authorised Volvo workshop.
	Brake system warning	A fault is detected in the brake system.
	Anti-lock braking system warning	The anti-lock braking system is disengaged. The friction brakes still function but without anti-lock braking.
	Direction indicator warning	A fault is detected with the direction indicators.
	Lane keeping aid fault	There is a fault with the lane keeping aid system. ^[1]
	Tyre pressure warning	Constant illumination indicates low tyre pressure. Flashing indicates a system fault or inability to measure the tyre pressure.
	Air suspension warning	A fault is detected in the air suspension system.
	Stability system alert	A flashing symbol indicates that the stability system is intervening. A fault in the system is indicated by a constant glow.
	Front wiper failure	A fault is detected with the front wipers.
	Reduced performance alert	The car's performance is reduced.
	Driver support system fault	There is a fault with the driver support system.
	Left lane keeping aid warning	You are too close to or crossing over the lane markings on the left-hand side of the car.
	Right lane keeping aid warning	You are too close to or crossing over the lane markings on the right-hand side of the car.
	Towbar unlocked	The towbar is unlocked.
	Rear fog light on	The rear fog light is on.
	Exterior lights malfunction	There is an issue with the exterior lights.
	Automatic high beam active	The automatic high beam is active.
	Manual high beam on	The manual high beam is on.

READY	Ready to drive	The car has started and is ready to drive. This appears when the car goes from being parked to being put in a driving gear. It disappears when the car starts to move.
	Left-hand direction indicator	The left direction indicator is active and indicating a left turn.
	Right-hand direction indicator	The right direction indicator is active and indicating a right turn.
	Position lights	The position lights are on.
	Child lock	The child lock is active. Passengers in the rear seats can't open the rear doors or operate the rear windows.
	Hold	Hold is active.
	Charging cable connected	The charging cable is still connected to the car.
	Automatic high beam enabled	The automatic high beam is enabled.
	Rain sensor	The rain sensor is active and the front wipers are in auto mode.
	Lane keeping aid off	Lane keeping aid is turned off or temporarily unavailable.

[1] When a fault is indicated, the function is disabled.

[2] Depending on the car's current theme, this symbol can be a different colour.

3.1.2.2. Battery meter

The battery meter shows the charge level percentage and estimated range of your car.

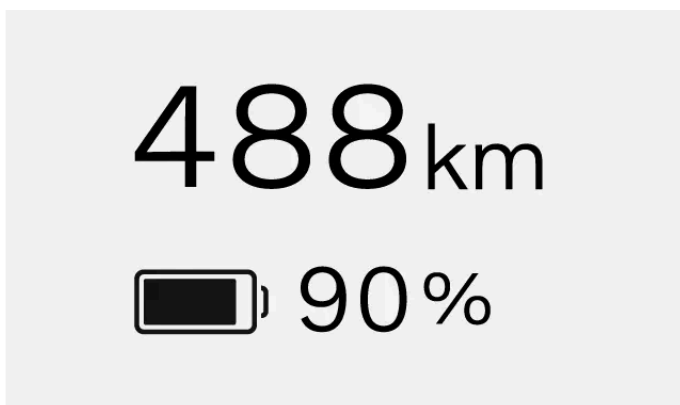

The battery meter is shown in the driver display at all times.

Remaining battery

The battery percentage indicates the level of charge left in your car's battery.

The range tells you how far you can drive with the battery's current charge level. The estimated range is based on your historical driving patterns.

i Note

Driving style and external factors, such as outside temperatures and driving for prolonged periods at high speeds, can have different effects on the estimated battery range.

Cold battery indicator

When the car has a cold battery, a snowflake ❄ appears next to the battery percentage. This indicates that the battery's charge capacity and range are reduced compared to normal conditions.

When the battery warms up, for example during preconditioning of the car or when driving, the snowflake disappears from the driver display.

3.1.2.3. Power meter

The power meter tells you how and when the battery power is being used or regenerated.

The power meter is always visible in the driver display and its appearance varies between driver display modes.

The different sections and colours of the power meter indicate different power uses or limitations. They can appear on their own or in combination with other sections.

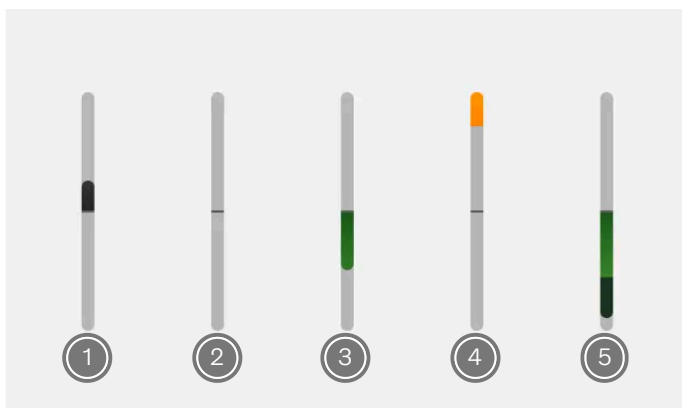

- ① The car is using power to move. The size of this section grows and shrinks with the amount of power being used.
- ② This line is always visible. When you can see just the line by itself, it means that the car is neither using nor regenerating power.
- ③ The car's battery is regenerating power rather than using it. This can appear when decelerating or braking, or when easing up on the accelerator while using One pedal drive. The size of this section grows and shrinks with the amount of power

The content of this manual represents the status of the user manual at the time of printing and may not be completely valid in future instances. For more information, refer to the first page for the complete disclaimer note.

being regenerated.

- ④ The car isn't able to draw its normal amount of power from the battery and the available power is reduced. This can appear in cold weather, when the battery percentage is low or when the car's performance is reduced.
- ⑤ The friction brakes are in use. You might see this section appear when the disc brakes are engaged or if the battery is full and can't store any more power. The more you apply the friction brakes, the larger the section becomes.

3.1.3. Head-up display

The head-up display projects information from the driver display onto the windscreen in front of the driver.

The display unit, which projects the information through a glass cover, is located in the dashboard.

Examples of information that can be shown in the head-up display are:

- Speed
- Symbols relating to notifications that can be seen in the driver display
- Navigation directions

You can adjust the head-up display's brightness and position as well as turn it on or off in settings.

Note

Some factors may impair your ability to see the information in the head-up display. For example:

- wearing polarised sunglasses
- not sitting centred in the seat
- unfavourable light conditions.

Important

To avoid damaging the display, do not store any objects on the glass cover and make sure that objects cannot fall onto it.

3.1.3.1. Adjusting the head-up display

You can adjust the brightness and position of the head-up display in settings.

1. Press the car symbol  in the bottom bar and go to **Settings**.
2. Go to **Controls** → **Lights and displays** → **Adjust head-up display**.

3. Use the steering wheel buttons to adjust the brightness and position of the head-up display.

3.1.4. System settings

You can change the system settings so that the car displays information in a way that suits you.

There are a number of system settings that you can change, including:

- System language
- Time and date
- Units of measurement
- Keyboard languages

3.1.4.1. Changing time and date

You can manually change the time, date and local time zone in settings.

By default, your car uses information from the internet to automatically change the time, date and local time zone for you. You can also manually change these, as well as the time format, in settings.

1. Press the car symbol  in the bottom bar and go to **Settings**.
 2. Go to **System** → **Date and time**.
 3. If **Automatic date and time** and **Automatic time zone** are enabled, turn them off.
 4. Select your desired setting and make any changes.
- > The changes are shown in the displays.
The clock in the centre display's status bar updates if you made changes to the time settings.



Tip

To change the time format, turn it on for 24-hour format or off for 12-hour format.

3.1.4.2. Changing system language

The content of this manual represents the status of the user manual at the time of printing and may not be completely valid in future instances. For more information, refer to the first page for the complete disclaimer note.

You can change the language of the car's system in settings.

If you want the car's system to be in a language that is different from the current language, you need to change the system language.

 **Important**

Only select a system language that you can fully understand. The car communicates safety-critical information and notifications to you through messages, so you need to be able to understand them at all times.

1. Press the car symbol  in the bottom bar and go to **Settings**.
 2. Go to **System** → **Languages and input** → **Languages**.
 3. Choose the language you want to change to.
- > The new language is shown in the displays.

3.1.4.3. Changing system units

You can change the units of measurement, such as for speed and distance, in settings.

 **Tip**

When driving abroad, it can be useful to change the car's units of measurement to match the local ones. It can be especially helpful if road signs display distances and speeds in units that are different to those currently displayed in your car.

1. Press the car symbol  in the bottom bar and go to **Settings**.
 2. Go to **System** → **Units**.
 3. Select the units of measurement you want the car to display.
- > The car displays units in the new format.

3.1.5. Restarting the displays

The content of this manual represents the status of the user manual at the time of printing and may not be completely valid in future instances. For more information, refer to the first page for the complete disclaimer note.

You can restart the displays using the play/pause button on the tunnel console.

If you are having problems with the displays, restarting them might be a way to resolve any issues. Problems with the displays might include a display freezing, the centre display not starting or the car not being able to connect to the internet.

To restart the displays, the car must be at a standstill and not moving.

1. Press and hold the play/pause button on the tunnel console until the Volvo logo appears. It might take some time for the logo to appear.



> The displays restart.

i Note

Ignore any messages that appear in the centre display when you are pressing and holding the play/pause button.

3.2. Phone

Connect your phone to the car via Bluetooth to be able to use it while driving. When you are away from your car, you can also use your phone to read the manual or use some car features remotely via the Volvo Cars app.

Connect your phone to your car

Connecting your phone to the car via Bluetooth allows you to use it through the car's interface. You can also stream media directly from your phone to the car as well as share its internet connection.

You can use voice control or the centre display to search for your contacts, make and receive phone calls, and respond to text messages without even touching your phone.

Other uses for your phone

Using your phone with your car isn't limited to just when you're inside the car. Download the Volvo Cars app to remotely use certain car functions or read the manual when you're away from the car.

The content of this manual represents the status of the user manual at the time of printing and may not be completely valid in future instances. For more information, refer to the first page for the complete disclaimer note.

3.2.1. Connecting your phone to the car

Connect your phone to the car via Bluetooth to use your phone through the car's interface.

Bluetooth must be enabled for both the car and your phone for them to be able to pair. You can turn Bluetooth on in settings. Make sure that your phone is set as discoverable so that the car can find it when pairing.

1. Press the car symbol  in the bottom bar and go to **Settings**.
 2. Go to **Connectivity** → **Bluetooth** → **Found devices**.
 3. Choose the device you want to pair the car with from the list of discovered devices.
 4. Check that the confirmation code in the centre display matches the one shown on your phone.
 5. Accept the settings and permission requests that appear on your phone.^[1]
- > Your phone is now connected to the car. It will automatically connect next time, as long as Bluetooth is enabled on your phone.

Note

You can have multiple phones paired with the car, but only one can be connected to the car at a time. To change the active phone, select it from the list of paired devices or add a new device.

^[1] You can still connect your phone to the car even if you skip over permission requests, but there will be reduced functionality.

3.2.2. Using your phone in the car

You can use your phone via the centre display and voice control.

Important

Make sure that you comply with all local laws and regulations regarding mobile phone use while driving.

 **Note**





You need to connect your phone to the car via Bluetooth and accept the corresponding phone settings permissions to be able to use these features.



Calling

There are some different ways you can make and receive phone calls while in your car. You can:

- answer and decline incoming calls using the centre display
- call someone while driving by asking the digital assistant to make the call for you
- use the in-car phone app via the centre display to call contacts or type a phone number in using the on-screen keypad.

When you have an ongoing call, it will be shown in the centre display. If you open the in-car phone app when you have an ongoing call, you can:

- mute and unmute your microphone 
- change the sound input and output, such as through the car or your mobile phone's microphone and speakers 
- end the call 
- put the call on hold by pausing it 
- use the keypad to input numbers, such as when asked to select an option in a service menu .

If you receive a second phone call while in the middle of an ongoing call, answering the second phone call automatically puts the first one on hold. You can switch between the two calls  or create a conference call and speak to both callers at the same time .

Messaging

You can write and send text messages via the digital assistant using voice control^[1]. If you receive a text message, a notification will appear in the centre display with the following options:

- **Play** to hear the digital assistant read the message out loud.
- **Mute** to stop receiving new message notifications from this specific conversation for the rest of the time you are in the car.

You can also ignore the notification and view it later in the notification centre.

Looking through and searching for your contacts

Use the in-car phone app to search for a specific contact by:

- pressing the search symbol 
- going to the contacts tab and typing their name
- going to the keypad tab and putting their number in.

You can also just ask the digital assistant to find the contact you are looking for.

^[1] Only applies to Android phones or phones with iOS 13 or later.

3.2.3. Switching between paired phones

You can change which Bluetooth-paired phone the car is connected to in settings.

The car can connect to and remember multiple phones, but it can only be actively connected to one phone at a time.

If you want to switch the Bluetooth connection to a new device, you need to pair it with the car first. You can do this in settings.

Before trying to switch to a different paired device, make sure that Bluetooth is enabled on the device you want to switch to.

1. Press the car symbol  in the bottom bar and go to **Settings**.
 2. Go to **Connectivity** → **Bluetooth** → **Saved devices**.
 3. Press the name of the phone you want to connect to.
- > If the connection is successful, the phone's name moves to the top of the saved devices list.

If you can't see the device you want to switch to in the saved devices list, try pairing it with the car again.

3.2.4. Apple CarPlay

Activate Apple CarPlay to use your iPhone wirelessly via the car.

Apple CarPlay gives you another way of using your iPhone via the car's interface. You can use certain communication, navigation and media apps on your iPhone via the centre display as well as the steering wheel buttons and voice control.

 **Important**

Local laws and regulations

Make sure that you comply with all local laws and regulations regarding mobile phone use while driving.

CarPlay content

Volvo does not accept responsibility for the content available in Apple CarPlay.

 **Note**

Phone compatibility and supported apps

Apple CarPlay only works with iPhones but it doesn't work with all iPhone models. To find out if your iPhone is compatible or to learn more about which apps are supported, go to Apple's website www.apple.com/ios/carplay [<https://www.apple.com/ios/carplay>].

 **Tip**

Keep your iPhone and apps updated to the latest versions.

Connect your iPhone and start CarPlay

Connect your iPhone to the car via Bluetooth and activate Apple CarPlay. After setting up CarPlay for the first time, it automatically starts when you connect your phone via Bluetooth again.

CarPlay view

You can access the CarPlay view by opening the CarPlay app in the app library. If the CarPlay symbol  is shown in the contextual bar, you can also access the view by pressing this symbol.

Once active, the CarPlay view takes up the whole of the centre display. However, the bottom bar, contextual bar and status bar will still be visible at all times if you want to return to the car's own system.

Navigation with CarPlay

You can use navigation apps on your iPhone via Apple CarPlay. If you start a navigation route via CarPlay, you can see the guidance in the centre display's CarPlay view as well as in the driver display. If you are following a navigation route in the car's own navigation app and then start another navigation route in CarPlay, the driver display navigation for the car's own app will end.

Using Siri

If you want to use Siri instead of the car's in-built digital assistant, press and hold the voice control button  on the steering wheel while CarPlay is active.



You can use Siri to read out, write and send messages. Siri will read and write messages in the language selected in the Siri settings on your iPhone. If you write a message via Siri, the centre display won't show you your message but it will be displayed on your iPhone.

3.2.4.1. Connecting your iPhone to Apple CarPlay

Connect your iPhone to the car via Bluetooth to start using Apple CarPlay.

Bluetooth must be enabled for both the car and your phone for them to be able to pair. You can turn Bluetooth on in settings. Make sure that your phone is set as discoverable so that the car can find it when pairing.

To be able to use CarPlay, you need to activate Siri on your iPhone and have an active internet connection. You also need to turn the car's Wi-Fi off as CarPlay can't be active while Wi-Fi is enabled.

1. Press the car symbol  in the bottom bar and go to **Settings**.
 2. Go to **Connectivity** → **Bluetooth**.
 3. Select your iPhone from the list of discovered devices.
 4. Check that the confirmation code in the centre display matches the one shown on your phone.
 5. On your iPhone, consent to using CarPlay.
 6. In the car's centre display, read and accept CarPlay's terms and conditions.
- > Your iPhone connects to CarPlay and the CarPlay view opens in the centre display. A CarPlay symbol  also appears in the status bar to indicate that CarPlay is active.

CarPlay automatically starts the next time you connect your iPhone via Bluetooth.



Tip

You can disconnect from CarPlay but keep your iPhone connected to the car by pressing the CarPlay symbol  next to your device's name in the car's Bluetooth settings.

3.2.5. Android Auto™

Connect your phone via Bluetooth and activate Android Auto™ to use your Android™ phone via the car.

Android Auto gives you another way of using your Android phone via the car's interface. With Android Auto, you can safely access your phone's communication, navigation and media apps via the centre display as well as the steering wheel buttons.



Important

Local laws and regulations

Make sure that you comply with all local laws and regulations regarding mobile phone use while driving.

Android Auto content

Volvo does not accept responsibility for the content available in Android Auto.

 **Note**

Phone compatibility and supported apps

Android Auto only works with Android phones but it doesn't work with all phone models. To find out if your phone is compatible or to learn more about which apps are supported, go to Android Auto's website www.android.com/auto/ [<https://www.android.com/auto/>].

Google Trademarks and compatibility

Google, Android and Android Auto are trademarks of Google LLC. Compatible Android phone and compatible active data plan required.

 **Tip**

Keep your phone updated

Keep your phone and apps updated to the latest versions.

Connect your Android phone and start Android Auto

 **Note**

Make sure your phone has at least Android 9.0 and an active internet connection

To be able to use Android Auto, you need to have Android 9.0 or higher installed on your phone and an active internet connection.

Connect your Android phone to the car via Bluetooth and activate Android Auto. If you are using Android Auto for the first time, you need to accept the terms and conditions in the centre display, then Android Auto will start. If you have used Android Auto before, it will automatically start when you connect your phone to the car.

Android Auto view

You can access the Android Auto view by opening the Android Auto app in the app library. If the Android Auto symbol  is shown in the contextual bar, you can also access the view by pressing this symbol.

Once active, the Android Auto view takes up the whole of the centre display. However, the bottom bar, contextual bar and status bar will still be visible at all times if you want to return to the car's own system.

Navigation with Android Auto

You can use navigation apps on your phone via Android Auto. If you start a navigation route via Android Auto, you can see the guidance in the centre display's Android Auto view as well as in the driver display. If you are following a navigation route in the car's own navigation app and then start another navigation route in Android Auto, the driver display navigation for the car's own app will end.

Using Google Assistant

Talk to Google Assistant on Android Auto to carry out tasks with your voice so that you can keep your focus on driving. To use Google Assistant, just say "Hey Google" or press and hold the voice control button  on the steering wheel while Android Auto is active.



You can use Google Assistant to carry out tasks such as sending messages, getting directions or controlling media.

3.2.5.1. Connecting your Android™ phone to Android Auto™

Connect your Android phone to the car via Bluetooth to start using Android Auto.

Bluetooth must be enabled for both the car and your Android phone for them to be able to pair. You can turn Bluetooth on in settings. Make sure that your phone is set as discoverable so that the car can find it when pairing.

You need to turn the car's Wi-Fi off as Android Auto can't be active while Wi-Fi is enabled.

1. Press the car symbol  in the bottom bar and go to **Settings**.
 2. Go to **Connectivity** → **Bluetooth**.
 3. Select your Android phone from the list of discovered devices.
 4. Check that the confirmation code in the centre display matches the one shown on your phone.
 5. In the car's centre display, read and accept Android Auto's terms and conditions.
- > Your phone connects to Android Auto and the Android Auto view opens in the centre display. An Android Auto symbol  also appears in the status bar to indicate that Android Auto is active.

Android Auto automatically starts the next time you connect your phone via Bluetooth.

3.3. Sound and media

Listen to music and media through the car's sound system. You can adjust how it sounds in settings.

Sound settings

There is a variety of sound settings for you to customise your sound experience. The sound system also supports Dolby Atmos.

Radio and media players

You can listen to live radio via the pre-installed radio app and stream media from your phone to the car via the Bluetooth media player.



Tip

You can find and download more third-party media apps via the car's app store.

Controlling media playback

You can control media playback in a number of ways by using:

- media playback controls in the centre display
- the media knob on the tunnel console
- the steering wheel buttons
- voice control.

3.3.1. Radio

Use the pre-installed radio app to listen to live radio in your car.

Link DAB and FM radio stations

DAB and FM linking allows the car to automatically select the strongest reception between the DAB or FM sources of linked stations. Your car comes with this already enabled but you can turn it off in the radio app settings.

Radio announcements

When listening to the radio, you might hear some announcements which interrupt what you're listening to. They are accompanied by a notification in the centre display. You can stop the announcement and continue listening to the radio by dismissing the notification.

You can choose which radio announcements you want to hear in radio settings. Press the settings symbol  at the top of the radio app, then turn the announcements on or off. By default, alarm announcements are turned on but the other announcements are turned off.

Radio favourites

You can add stations to your radio favourites list for quicker access.





Tip

You can find and download other radio apps via the app store.

3.3.1.1. Adding radio favourites

You can add radio stations to the favourites list in the radio app.

Add the radio stations you listen to frequently to the favourites list for quicker access. You can add up to 50 radio stations to the list.



1. Press the app library symbol  in the bottom bar and open the radio app.
 2. Find the station you want to add as a favourite from the list of currently available radio stations.
 3. Press the star symbol  to the right of the station name.
- > The appearance of the station's star symbol changes and the radio station appears in the favourites list.

If you want to remove a station from the favourites list, just press the star next to its name.

3.3.1.2. Linking DAB and FM stations

Turn DAB and FM linking on or off in the radio app settings.

When an FM station has a corresponding DAB station, and vice versa, they can often be linked in the radio app. Linking the two radio sources allows the car to automatically switch between the DAB and FM stations to play the source with the strongest reception.

1. Press the app library symbol  in the bottom bar and open the radio app.
 2. Press the settings symbol  to go to radio settings.
 3. Turn DAB and FM linking on or off.
- > When turned on, the radio app shows one radio station tab.
When turned off, the radio app shows separate DAB and FM station tabs.

 **Note**

It might not be possible to link some corresponding DAB and FM stations, so these will appear as separate stations.

3.3.2. Sound settings

You can change and adjust a variety of sound options in settings.

Focus

You can choose from four sound focus settings: all, driver, front and rear. All is the default setting and doesn't focus the sound in a particular direction. It provides a neutral sound focus where occupants in the front and rear seats have the same sound experience. The driver setting focuses the sound towards the driver. The front setting focuses sound towards the front seats whereas the rear setting focuses it towards the rear seats.

Stage

By default, intensity and envelopment are set to a neutral level. Increase or decrease these settings to customise your sound experience.

Abbey Road Studios

Choose between five different settings to change and experience the sound as if you are in London's Abbey Road Studios.

Tone and equaliser

Customise how your media sounds by adjusting the values for the different tone qualities. Turn the equaliser on to adjust the sound frequencies to your preferences. If you decide that you don't like your equaliser adjustments, just press **Reset levels** and the levels return to the default settings.

Volume

You can adjust the volume of a variety of sounds via the centre display, such as:

- Media
- Ringtone
- Calls
- Voice assistant
- Navigation
- Notifications
- Park assistance



Tip

There are other ways to adjust the sound volumes in your car. You can turn the media knob on the tunnel console, press the steering wheel buttons or use voice control.

Voice amplification

Voice amplification can help you hear people in other seat rows better via the sound system. You can choose the amplification to be low, medium or high, or simply turn it off. The setting resets to off by default after each drive.

You can also choose to amplify the front seats only. Just turn this setting on when voice amplification is active or turn it off to amplify all seat rows in the car again.

3.3.3. Media players

Your car comes with a pre-installed media player. You can download more third-party media apps from Google Play in the app library.

Your car comes with the Bluetooth media player pre-installed in the app library.

Use the Bluetooth media app to stream media from a Bluetooth-connected device straight to the car.

3.4. In-car apps

All of the car's apps can be found in the app library.

You can access the app library by pressing its symbol in the bottom bar.



App library symbol

The apps in the library are shown in chronological order, starting with the app installed first and ending with the most recently installed app.

Some apps are pre-installed, such as Bluetooth media, Google Maps and Google Assistant. You can search for and download new apps via Google Play, which can be accessed in the app library.

3.4.1. Downloading apps

Download more apps to your car from the app store in the app library.

Your car comes with some apps pre-installed, but you can find and download more in the app store.

1. Press the app library symbol  in the bottom bar.
 2. Press **Get more apps** to go to the app store.
 3. Search for the app you want to download.
 4. Download and install your desired app.
- > If the app is successfully downloaded and installed, it appears in the app library.

3.4.2. Uninstalling apps

You can uninstall apps you no longer want or use in the app library.

 **Note**

Pre-installed apps, such as phone and radio, can't be uninstalled.

1. Press the app library symbol  in the bottom bar.
 2. Find the app you want to uninstall, then press and hold the app until a menu appears.
 3. Select **Uninstall** from the menu.
 4. Press **Uninstall** to continue uninstalling the app.
- > The app is uninstalled and it disappears from the app library.

3.5. Connectivity and software

Connect your car to the internet to get more from your car and receive over-the-air software updates.

Internet connectivity

Connect your car to the internet via the car's built-in mobile network connection, Wi-Fi or a Bluetooth-connected mobile phone.

Software updates

Over-the-air updates keep your car's software up to date.

3.5.1. Internet connection

Connecting your car to the internet gives you access to certain features and over-the-air software updates.

There are several ways to connect your car to the internet:

- Mobile network
- Wi-Fi network
- Bluetooth-connected phone tethering

Mobile network

Your car has a built-in modem for connecting to a mobile network. The mobile internet connection is set up before you get your car and is included for a certain number of years. As long as the car has an active mobile network service plan and it's in an area with network reception, it can connect to the internet. Contact an authorised Volvo workshop for information about mobile connectivity services for your car.

The car supports mobile networks up to, and including, 5G. The available mobile network speeds depend on the SIM card installed in your car.

Note

Mobile network connectivity conditions and limitations

- You need to consent to the mobile network operator's terms to enable the mobile internet connection. You can do this during onboarding and via the car's privacy settings.
- The car needs to be in an area with mobile network reception.
- Mobile connectivity services must be active for the region in which the car is located.
- Obstacles such as buildings, hills and mountains can weaken or block the mobile network signal.

Wi-Fi

You can connect the car to a Wi-Fi network for internet access. The car can automatically connect to the network whenever it's within range.

Bluetooth-connected phone tethering

When a phone is connected to the car via Bluetooth, the car can use the phone's mobile internet connection. To do this, Bluetooth tethering needs to be enabled for the phone in the car's connectivity settings. Both the phone and mobile network provider need to support sharing an internet connection through tethering.

Internet connection settings

You can find the connectivity settings in the centre display.



3.5.1.1. Connecting to the internet via a Bluetooth-connected phone

Connect your phone to the car via Bluetooth and share its internet connection.

 **Note**

Sharing your phone's mobile internet connection with the car will affect the amount of mobile data you use. Some mobile data providers might not allow this kind of data use. It's possible that the available amount will be limited or the providers may charge you extra money for it. Make sure you check your provider's conditions for data usage before activating Bluetooth tethering.

You need to connect your phone to the car via Bluetooth before you can share your phone's internet connection.

1. Press the car symbol  in the bottom bar and go to **Settings**.
 2. Go to **Connectivity** → **Bluetooth**.
 3. Press the Bluetooth tethering symbol  for the phone that you want to share the internet connection from.
 4. Press **Accept** to continue with the tethering activation.
- > The Bluetooth tethering symbol changes colour, indicating that tethering is now active.

3.5.1.2. Connecting to the internet via Wi-Fi

Connect your car to a Wi-Fi network for internet access.

1. Press the car symbol  in the bottom bar and go to **Settings**.
 2. Go to **Connectivity** → **Wi-Fi**.
 3. Enable Wi-Fi if it is disabled.
 4. Select the Wi-Fi network you want to connect to.
 5. Enter the Wi-Fi network password using the centre display's keyboard and press **Confirm**.
- > The car connects to the Wi-Fi network.

3.5.2. Over-the-air updates

Over-the-air updates keep your car's software up to date.

When your car is connected to the internet, it can receive over-the-air^[1] updates to keep the car's software up to date. The car will tell you when there is an update available to download and install by displaying the update symbol  in the status bar as well as a notification.

You can also check for new software updates by going to **System** → **System details** → **Software update** in settings.

Automatic software downloads

You will be asked if you want to enable automatic software downloads when you set up your car for the first time. You can always choose to enable or disable the automatic downloads at a later time in settings. If you decide not to enable them, you will be asked for consent to download software updates whenever they are available.

Installing software updates

When a new software update is available, the car will download the update but it won't install it for you. You need to start the installation yourself, either via a notification in the centre display or in the software update view. You can also choose to postpone the update so that it installs at a later time or cancel the installation after confirming it.

You can't access or use your car while a software update is installing. Therefore, make sure that there is sufficient remaining battery charge and that you don't need to use your car during the installation process. The car will tell you how much battery charge you need to start the installation and give you an estimation for how long it will take to install the update.

Note

Installation issues

There might be updates that you can't install yourself. If this happens, you will see a notification in the centre display telling you what to do next.

Don't use the diagnostic port

Don't use the diagnostic port while a software update is installing. Using the diagnostic port during an installation might affect the car's systems and the software update.

Alarm disabled

To avoid any false alarms, the car's alarm is disabled during the software installation process.

^[1] OTA

3.6. Voice control

Keep your hands on the wheel and use your voice to interact with the car via the digital assistant.

With the help of the digital assistant, you can use voice control to carry out tasks, such as searching the internet and getting weather forecasts. You can also use your voice to interact with the car and control a number of its functions, including:

- Media player

- Phone
- Navigation
- Climate

Speaking to the digital assistant

The assistant understands everyday speech, so you don't need to know any specific voice commands to use it. You can ask the assistant anything and it responds by confirming what you said, then doing what you asked. It will let you know if it doesn't understand you.

Note

- The voice control feature is from a third-party supplier. Availability, how to use it and how it works may vary over time and between regions.
- A poor internet connection may limit the number of available functions.

3.6.1. Using voice control

Use your voice to control and interact with a number of the car's functions via the digital assistant.

The only time you need to use specific voice commands to interact with the digital assistant is when you activate it. After activating the assistant, just speak or give instructions to it using everyday phrases.

Note

Google Assistant isn't available in every language yet. Find out more at support.google.com [\[https://support.google.com\]](https://support.google.com) or try to use another language if you can.

1. Say "Ok Google" or "Hey Google" to activate Google Assistant.
 - > The assistant confirms that it's listening.
2. Speak or give instructions to the digital assistant using everyday phrases.



Tip

Other ways to activate

You can also activate the digital assistant by pressing the steering wheel button and via the centre display.

Sign in to your Google account

If you sign in with a Google account, Google Assistant will be more personalised when the car is online. For example, you can easily call contacts stored in your Google contacts or check what's in your Google Calendar. When Google Gemini becomes available, you will be able to opt in to use Gemini.

4. Interior comfort and climate

Get familiar with your car's interior and the controls for seat adjustment, climate and windows.



Your car is equipped with multiple features to assist you in your driving. While some features are mainly for comfort, others improve visibility. Reading this section of the manual can assist in making your driving experience more comfortable.

4.1. Interior

Get to know the interior's layout and its practical features, such as cup holders and charging ports for your devices.



Interior walk-through

There are a few places and components whose names and locations are good to know, as they are referenced throughout the manual.

Passenger compartment	The passenger compartment is divided into the front and rear passenger compartment.
Boot	The boot, or cargo area, is the space behind the rear seats, which you typically access from behind the car.
Dashboard	The dashboard refers to the whole set of panels and components in front of the driver and front passenger. It has some of your car's main interaction areas, such as the displays, steering wheel, air vents and glove box.
Tunnel console	The tunnel console sits between the front seats. It's where you find the volume control, storage compartments, wireless charger, a cup holder and a rearward-facing utility panel. You can also find USB ports in both the front and rear of the tunnel console.
Overhead console	The overhead console sits in the ceiling against the windscreen. It provides easy access to certain important functions and indicators. This is also where you find the front seat reading lights.
Door control panel	Each door has its own set of controls for windows and locks.

4.1.1. Using the wireless charger

Use the wireless charger to charge Qi-certified devices, such as a phone.



To use the wireless charger, your device should be certified to the Qi wireless charging standard. Also make sure that wireless charging is enabled on both the device^[1] and on the charger itself. You can enable the charger in the centre display.

Warning

Wireless charging may affect the operation of a pacemaker or other implanted medical devices. If you have one, consult your doctor before using the wireless charging system.

 **Important**

NFC cards and charging

Do not place cards with NFC, such as key cards or electronic payment cards, between the wireless charger and the device when using the charging function. This could damage them.

If you have any cards or other sensitive items in your phone case, remove them before charging or make sure that they aren't between your phone and the charger.

Before charging a device, make sure there are no other objects on the charger.

1. Place the device in the middle of the charger.
- > The device starts charging and the integrated cooling fan activates. The charging symbol is visible in the centre display's status bar.

 **Warning**

Never leave your phone on the wireless charger when you leave the car.

 **Note**

- You may experience differing results when charging different devices. For example, the time it takes before charging starts and how quickly a device is fully charged.
- Your device might get hot during charging. This is normal and nothing to worry about. If the device's battery temperature becomes too high, charging is deactivated.

If the device doesn't charge

If your device doesn't charge when placed on the charger, there are some steps you can try:

- Make sure you have enabled the charger in the centre display.
- Make sure there are no items on the charger apart from the device you want to charge.
- Lift the device and then place it back in the middle of the charger.
- Remove any cases or covers from the device.
- Disable the device's NFC function if it has one.

[1] Many Qi-certified devices are always enabled

4.1.2. Enabling the wireless charger

You can enable or disable the wireless charger in the centre display.

The charger has to be enabled before you start using it.

1. Press the car symbol  in the bottom bar and go to **Settings**.
2. Go to **Controls** → **More** → **Wireless device charging**.
3. Turn the charger on.

4.1.3. USB ports

You can use your car's USB ports to charge a phone, tablet or other device.

Location of the USB ports



There are two USB ports^[1] under the centre display.



There are also two USB ports^[1] in the rear part of the tunnel console.



Finally, for the third row passengers, there is one USB port in each side panel.

Using the USB ports

Always disconnect devices from the ports when not in use.

Some devices may become hot during charging. This is normal.

The ports are disabled if you leave the car. If you leave the car unlocked, the ports will remain active for a while longer.

USB port specifications

The power output of the USB ports depends on the device you are charging. The voltage and current is modulated to what is accepted by your device.

- Type C socket
- Max. power output 18 W
- Supports Quick Charge 3.0

^[1] type C

4.1.4. 12 V socket

You can use the 12 V socket to power various electrical devices, such as a cool box.



The 12 V electrical socket is on the right-hand side in the boot.

The car turns off power to the socket automatically when you leave the car. If you leave the car unlocked, the socket remains active for a while longer.

Always disconnect devices from the socket and close the cover when not in use.

Some devices may become hot when charged through the 12 V socket. This is normal for many devices.

 **Warning**

Failure to observe the following instructions could cause damage or personal injury.

- Do not use electrical devices with large, heavy plugs. They can damage the socket or come loose while driving.
- Do not use electrical devices that could interfere with the car's systems, such as the radio receiver.
- Only connect undamaged and fully working devices that meet all relevant safety standards^[1].
- Keep an eye on connected devices to prevent damage or injury if they malfunction.
- Do not connect adaptors or extension cables to the 12 V socket as these can override the socket's safety features.
- Do not expose the socket, connectors or connected devices to water or other liquids.
- Do not touch or use the socket if it appears to be damaged or has come into contact with water or other liquids.

Power rating

 **Important**

The maximum power draw is 120 W (10 A).

4.1.5. Sun visors

There are sun visors overhead in front of the driver's seat and the front passenger seat.



The visors can be folded down and angled to the side when necessary. With the sun visor angled to the side, you can also extend the rod holding the sun visor for better positioning.

There is a covered mirror in the sun visor. The mirror light comes on automatically when you open the cover.

There is also a clip on the sun visor which can be used to conveniently place cards or tickets, for example.

4.2. Comfort

Your car has several features designed to enhance your comfort while driving or parked.

While many of your car's features are designed to enable safe driving practices, others are more focused towards enhancing your comfort. This includes certain climate features and comfort modes.

Climate

Your car has the ability to provide a comfortable climate in the passenger compartment. It can cool, heat and dehumidify the air for you when needed. There are also built-in features for providing good air quality.

Many of the climate features are automatic whereas others can be adjusted manually.

Seats

The front seats of your car are adjustable. While a good driving posture is necessary for visibility and safe driving practices, adjusting your seat also enables better comfort while driving or parked.

In colder temperatures, it's nice to heat your seat for a more comfortable driving experience. When it's warm outside, you can activate seat ventilation instead. You can activate and adjust the seat heating and ventilation via the centre display.

Your front seats are equipped with a massage feature too. You can choose from five different massage programmes with three different speeds and intensities.

Heated steering wheel

The steering wheel has built-in heating, which can provide comfort in colder temperatures. You can activate and adjust the steering wheel heating via the display.

Keeping climate active while parked

You can maintain a comfortable interior climate in your car while parked. This includes keeping the climate functions and the entertainment system on. You can activate the keep climate active function via the centre display. Just be aware that the car's range can be affected if you leave this setting on for too long.

4.3. Climate

Your car has the ability to provide a comfortable climate in the passenger compartment. It will cool, heat and dehumidify the air for you when needed. There are also built-in features which will provide good air quality.



This section of the manual covers the various climate features in your car, such as air conditioning, climate modes and heating options.

4.3.1. Climate controls

You can control the car's interior climate through various means, from both inside the car as well as from your phone.



Climate controls in the front passenger compartment



Climate controls in the tunnel console



The mobile app

You can control the car's interior climate here:

- The centre display
- The tunnel console's rear seat panel
- The overhead console
- The mobile app for the car.

Most of your car's climate controls and settings can be found in the centre display. There are, however, also some physical buttons. The passengers in the rear seats can, for example, set their own preferred temperature via the climate settings in the tunnel console's rear seat panel. There is also a defroster button located in the overhead console.

In addition, passengers in the rear seats can control their own seat heating via the climate control panel on the back of the tunnel console.



Tip

Use the mobile app for the car to remotely precondition your car. That way, you can ensure a comfortable interior climate when you enter the car.

4.3.1.1. Activating seat heating

You can activate the seat heating function via the comfort view in the centre display. There are three levels of heating to choose from.



In colder temperatures, it's nice to heat your seat for a more comfortable driving experience. You can activate and adjust the seat heating via the centre display.



Warning

Seat heating should not be used by individuals who:

- have difficulties sensing temperature shifts due to sensory loss.
- have trouble controlling the seat heating settings.

1. Open the comfort view for the seat by pressing the corresponding seat symbol   in the bottom bar.
2. Select your preferred heating level.

To close the comfort view, press the downward arrowhead symbol in the bottom bar.



Tip

Second row seat heating

Passengers in the second row seats can control their own seat heating. This can be done via the climate control panel on the back of the tunnel console. You can also control the second row seat heating from the centre display. Press the fan symbol  in the bottom bar and go to **Rear** to access the seat heating settings.



Automatic seat heating

In cold weather you may appreciate the automatic seat heating. Go to climate settings to turn on automatic activation.

4.3.1.2. Activating seat ventilation

You can activate the seat ventilation via the comfort view in the centre display.

In warmer temperatures, it's nice to use seat ventilation for a more comfortable driving experience. You can activate and adjust the seat ventilation via the centre display.

1. Open the comfort view for the seat by pressing the corresponding seat symbol   in the bottom bar.
2. Select your preferred level of ventilation.

To close the comfort view, press the downward arrowhead symbol in the bottom bar.

4.3.1.3. Activating the steering wheel heating

Steering wheel heating can be controlled via the centre display. You can activate it manually or set it to automatic activation.

In colder temperatures, it's nice to heat your steering wheel for a more comfortable driving experience. You can activate and adjust the steering wheel heating via the centre display.

1. Press the driver side's seat symbol in the bottom bar .
2. Select your preferred steering wheel heating level.





Tip

Automatic steering wheel heating

In cold weather you may appreciate the automatic steering wheel heating. Go to climate settings to turn on automatic activation.

4.3.2. Climate settings

In climate settings, you can choose which functions should automatically activate when the car turns on.

You can access the climate settings by pressing the fan symbol  in the bottom bar and go to settings .

There are a number of climate functions you can set to automatically turn on and set the heat level for. These include:

The content of this manual represents the status of the user manual at the time of printing and may not be completely valid in future instances. For more information, refer to the first page for the complete disclaimer note.

- Seat heating
- Steering wheel heating
- Rear defroster

4.3.3. Temperature and air conditioning

By using the automatic climate settings, your car's climate system aims to always provide you with a comfortable interior environment. However, if you want to, you can always make adjustments to your liking.

The auto climate mode provides a comfortable interior environment in most circumstances. However, adjustments can always be made. For example, you can make changes to the temperature settings, let different climate zones have their own settings and change the settings for the air conditioning.

Tip

Third row climate

The third row climate automatically activates when passengers are detected in the third row.

When the third row climate is active, the driver's climate settings are also applied to the third row.

Note



In certain circumstances, such as when fast charging on a particularly warm day, the air coming from the air vents might not be as cool as expected. This is because the climate system is prioritising cooling the battery over cooling the passenger compartment. This helps to provide good conditions for the battery's performance and range.

4.3.3.1. Activating air conditioning

The air conditioning cools and dehumidifies the incoming air.

When you select auto climate mode, the air conditioning is automatically activated or deactivated to maintain the set temperature. Deselecting the air conditioning while in auto climate mode will activate manual climate mode.

For the air conditioning to work efficiently, windows, doors and the boot need to be closed.

1. Press the fan symbol  in the bottom bar.
2. Press the air conditioning symbol .

4.3.3.2. Setting temperature

You can change the temperature in the passenger compartment via the centre display.

1. Press the temperature in the bottom bar.
2. Use the plus or minus symbol to adjust the temperature.





Tip

You can also set the temperature in your car hands-free via voice control.

4.3.3.3. Synchronising temperature

By default, the driver's temperature setting is used for all climate zones. However, each climate zone can also have its own individual setting. You can switch between the two options by desynchronising and synchronising the temperature.

1. Press the driver's temperature setting in the bottom bar.
2. Press the synchronisation symbol  to desynchronise the temperature.
 - > The climate zones are desynchronised and the desynchronisation symbol appears.
3. Press the desynchronisation symbol  to resynchronise the temperature.



Tip

The temperature setting is also desynchronised when the passenger sets a different temperature on their side.

4.3.3.4. Activating eco climate

Your car has an eco climate function which prioritises the car's range over climate-related features.

Eco climate prioritises range over climate comfort. The heating, cooling and air conditioning functions are limited in this mode.

Note

Problems with misting may occur as the air conditioning function that adjusts humidity is limited when eco climate is active. When the air conditioning function is limited, it can also affect the air quality, especially in the rear seats as the air recirculation increases.

1. Press the fan symbol  in the bottom bar.
2. Press the eco climate symbol ECO.

4.3.4. Air distribution and climate modes

The general air distribution is decided by the selected climate mode and settings. There are also air vents that offer additional adjustability of the airflow throughout the car.

Adjustable air vents



The locations of the adjustable air vents

The adjustable air vents can be redirected to control the direction of the airflow.

Climate modes

There are two climate modes – automatic and manual. The automatic mode takes care of most adjustments and climate functions for you. However, in manual mode, you can control more of the available adjustments and functions yourself.

You can also turn the climate system off completely.

! Important

Condensation risk

Turning the climate system off completely may cause condensation on the windows, which could affect visibility.

The climate modes and their settings are available in the centre display's climate view.

4.3.4.1. Adjusting air vents

Adjustments to the air vents are done in the centre display as well as by using the physical air vent knobs.

Opening and closing air vents

1. Press the fan symbol in the bottom bar .



Press the air vent you want to open or close.

Redirecting the air flow

3. Move the physical air vent knobs to redirect the airflow.

4.3.4.2. Activating auto climate mode

When you activate auto climate mode, the climate system controls several of its functions automatically.

i Note

Deselecting the air conditioning while in auto climate mode will activate manual climate mode.

1. Press the fan symbol  in the bottom bar.
 2. Select **Auto**.
 3. You can change the fans' power level and the temperature if you prefer.
-

4.3.4.3. Activating manual climate mode

If you activate manual climate mode, you can set your preferred airflow direction and have more control of the fans' power level.

1. Press the fan symbol in the bottom bar .
 2. Select **Manual**.
 3. Choose your preferred airflow direction and fan power level.
-

4.3.5. Ice, condensation and defrosters

In cold conditions, ice and condensation can obstruct visibility. Your car is equipped with defrosters, a heated rear windscreen and heated wing mirrors to prevent that from happening.

There are defrosters placed by the windows and windscreens. The wing mirrors heat up at the same time as the rear windscreen. Combined, these functions aim to ensure good visibility.

 **Important**

Always make sure the windows and windscreens have good visibility before you start driving.



4.3.5.1. Activating max defroster

To quickly remove condensation and ice from the front windscreen and windows, you can activate max defroster.

Max defroster raises the fan speed and temperature. Air conditioning is activated and air recirculation is unavailable while max defroster is active. When max defroster is turned off again, the climate settings return to their previous levels.

 **Note**

When max defroster uses the high fan speed, the noise level of the fans increases.



1. Press the fan symbol in the bottom bar .
2. Press the max defroster symbol .

 **Tip**

The defroster button  in the overhead console activates max defroster as well as the heating of the rear windscreen and wing mirrors. If you already have either the max defroster or rear defroster activated via the centre display, pressing the defroster button in the overhead console will activate the second function. Press the defroster button again to turn both off.

4.3.5.2. Activating rear windscreen and wing mirror heating

Activate the rear windscreen and wing mirror heating to get rid of condensation and ice.

1. Press the fan symbol in the bottom bar .
2. Press the rear defroster symbol .

 **Tip**

Overhead console defroster button

The defroster button  in the overhead console activates max defroster as well as the heating of the rear windscreen and wing mirrors. If you already have either the max defroster or rear defroster activated via the centre display, pressing the defroster button in the overhead console will activate the second function. Press the defroster button again to turn both off.

Automatic rear defroster

In climate settings, you can set the rear defroster to automatically turn on when you start the car in cold conditions.

4.3.6. Interior climate when parked

Your car can maintain a comfortable interior climate when parked. You can also precondition your car so that the passenger compartment is prepared for your next trip.

Note

Parking climate functions automatically turn off when their maximum running time is reached or the car's battery level is too low.

Preconditioning

Preconditioning automatically activates the auto climate mode to heat up or cool down the passenger compartment to a comfortable temperature before you enter your car. It also preconditions the battery to help your car's performance and range.

You can schedule single and recurring preconditioning timers in the centre display, or via the mobile app for the car. Preconditioning automatically deactivates when you enter the car or when the scheduled time is reached.

Tip

When setting a timer via the mobile app, you can select what you want to precondition and set your preferred passenger compartment temperature.

For preconditioning to be available, the traction battery must be sufficiently charged. If preconditioning is started when your car is not connected for charging, the car's range will be affected.

Note

When preconditioning in a hot climate, condensation might drip under the car. This is normal.

Keep climate active

You can maintain a comfortable interior climate in your car while parked. This includes keeping the climate functions and the entertainment system on. You can activate the keep climate active function via the centre display. Just be aware that the car's range can be affected if you leave this setting on for too long.

4.3.6.1. Setting the preconditioning timer

You can set and activate a timer to precondition your car for a specific departure time. If you want to, you can set it to repeat on certain days.

If you choose to precondition the passenger compartment, the car will cool or heat it before your scheduled departure time. You can set the timer to repeat on a weekly schedule or for a single departure time.

1. Press the fan symbol  in the bottom bar and go to **Timers**.
 2. Go to **Climate timers** → **Add timer**.
 3. Choose a departure time.
- > The timer is set.

Setting a timer to repeat

4. Turn **Repeat weekly** on to set a weekly schedule and select one or more weekdays.
5. Press **Save**.

You can activate an already existing timer under **Climate timers**.

 **Tip**

When setting a timer via the mobile app, you can select what you want to precondition and set your preferred passenger compartment temperature.

4.3.6.2. Keeping climate active while parked

You can activate the keep climate active function to maintain a comfortable climate in the car while you are away from it.

Warning

Never leave a child or pet unattended in your car. You are responsible for their safety and well-being. Some regions have laws prohibiting people or pets being left inside a locked vehicle.

Note

The keep climate active function will automatically turn off when the maximum running time is reached, the car's battery level is too low or you start a new drive cycle. If you activate it when your car's battery level is already low, the maximum running time will be less.

1. Press the fan symbol in the bottom bar .
2. Go to **Timers** → **Keep climate active**.
3. Press **Start**.
4. Confirm your selection.

Press **Stop** to turn it off again.

4.3.6.3. Air purification

Air purification improves the air quality in the passenger compartment of your car before you start your drive.

You can start air purification via the mobile app for the car. It also starts automatically when preconditioning ends.

Air purification improves the interior air quality by blowing fresh air through the air filter and letting the air recirculate in the passenger compartment. This happens until the air quality reaches a certain level.

Tip

You can follow the content of small particulate matter^[1] via the mobile app for the car during the pre-cleaning cycle.

^[1] PM2.5

4.3.7. Air quality

Your car is designed to provide a pleasant and healthy interior climate. Air filtering helps to remove odours, substances and particles from the passenger compartment.

Passenger compartment air filter

The air going into the passenger compartment is first filtered through the climate control system. To ensure high performance, the filter needs to be replaced regularly. If the filter is exposed to intense use, such as prolonged driving through areas of smog or dust clouds, then the filter needs to be changed more frequently. If you are uncertain about what kind of filter to use, contact Volvo support.

Air quality system

The air in the passenger compartment is purified by:

- filtering allergy and asthma-inducing substances.
- removing gases and particles to reduce odours.
- removing air contaminants such as particles.

If the air quality sensors detect contaminants in the outside air, the air intake closes and internal air recirculation activates.

Air cleaning

To provide good air quality, your car is equipped with different air cleaning capabilities. Some of these can be activated via the centre display to quickly improve air quality in the passenger compartment.

CleanZone

CleanZone indicates whether conditions for good air quality are met or not.

4.3.7.1. Air quality indication

The air quality tab in the centre display's climate view provides you with information on the air quality both inside and outside of the car.

The air quality tab indicates the quality of the inside and outside air. A sensor measures the content of particles smaller than 2.5 µm in the passenger compartment. The information on the content of contaminants outside the car is provided by an external service and is based on modelled data.



Tip

For some regions, information on pollen levels is available. Press **Air quality and pollen** to see more detailed information.

4.3.7.2. Air cleaning

To provide good air quality, your car is equipped with different air cleaning capabilities.

Your car has multiple functions to ensure good air quality. Some of these are passive and some can be controlled in the centre display.

4.3.7.2.1. Advanced air cleaning

Advanced air cleaning aims to minimise the amount of hazardous particles and harmful gases in the passenger compartment.

Advanced air cleaning is always active except during air recirculation or when the climate system is turned off. You can see in the climate view's air quality tab if it's active or not.

4.3.7.2.2. Focused air cleaning

You can improve the passenger compartment's air quality by activating focused air cleaning. This lowers the number of unwanted particles in the air.

When you activate focused air cleaning, your car prioritises lowering the particle content in the incoming air over your climate comfort. This limits some of the other climate comfort features such as lowering the fans' power level.

The loss in comfort is due to the climate system recycling larger portions of the air. This is most noticeable when there are multiple passengers in the car.



Activating focused air cleaning

Focused air cleaning prioritises lowering the number of unwanted air particles in the car over other climate comfort features. You activate it in the centre display's climate view.

The focused air cleaning function quickly cleans the air in the passenger compartment to get rid of unwanted particles. When it's active, it's prioritised over other climate functions.

Important

When focused air cleaning is active, climate comfort and ventilation are reduced. This may lead to condensation that fogs the windows up and negatively affects visibility.

1. Press the fan symbol  in the bottom bar.
 2. Go to **Air quality**.
 3. Press the focused air cleaning symbol .
 4. Press **Activate**.
- > **Focused** appears below the fan symbol  in the bottom bar when focused air cleaning is active.

 **Note**

Avoid using focused air cleaning for longer periods of time as the air in the passenger compartment can become stuffy. Once the air inside the car has been cleaned, focused air cleaning has no further benefits so can be turned off.

Press the focused air cleaning symbol  again to turn it off. You can also turn focused air cleaning off by activating other climate features.

4.3.7.3. CleanZone

CleanZone is an air quality function that controls and indicates whether all conditions for providing good air quality are met or not.

You can find information regarding the air quality in the climate view's air quality tab. CleanZone is obtained if all conditions to provide a good air quality in the passenger compartment are met. If it can't be obtained, you can see in the centre display which condition is still not met.

4.3.7.4. Activating air recirculation

Air recirculation helps you keep out harmful or foul-smelling air from the passenger compartment. In some cases, it's activated automatically but you can also activate it manually in the climate view.



By default, the climate system automatically decides whether to recirculate the air depending on certain environmental conditions. If the air quality sensor notices that the exterior air is polluted, your car will automatically close the air intake and instead recycle the air in the passenger compartment. You can also manually activate constant air recirculation to close the air intake if you want to.

 **Important**

If the air is recirculated for a long period of time, condensation can fog up the windows, which can affect visibility.

 **Note**

Air recirculation is unavailable while max defroster is active.
If activated manually, air recirculation will time out after a while.

1. Press the fan symbol  in the bottom bar.
2. Press the recirculation symbol .

4.3.8. Climate system

Your car's climate system aims to provide everyone in the car with a comfortable environment using electronic climate control.

All climate control system functions are controlled via the centre display.

Your car uses sensors to automatically control different capabilities that are designed to offer a comfortable interior climate at all times.

 **Tip**

Most climate functions can also be controlled using voice control. Most features require an internet connection for use with voice control.

4.3.8.1. Climate zones

Your car's passenger compartment is divided into different climate zones. These zones enable passengers to set their own preferred temperature to enjoy a comfortable environment.

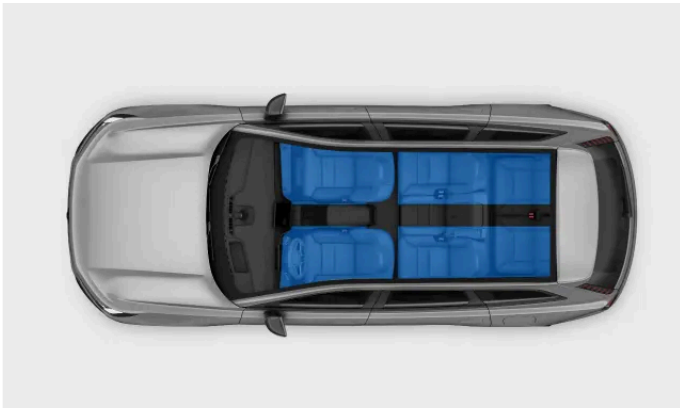

There are different climate zones in your car's passenger compartment. All zones are directly synced to the driver's preferred climate settings by default. However, the temperature can then be adjusted individually for each zone.

4.3.8.2. Partial climate

To save energy, your car can limit the rear climate functions if there are no rear occupants.

If the car detects that there are no occupants in the rear seats, it limits the climate functions for the rear passenger compartment. This is to reduce energy consumption.

4.3.8.3. Perceived and actual temperature

Your temperature perception is affected by more factors than the actual temperature of the air around you. Knowing the difference between perceived and actual temperature can benefit your climate comfort experience.

Whether the air in your car feels warm or cold depends on its temperature as well as several other factors. These factors include your own body temperature, airflow and humidity in the car and whether you're exposed to direct sunlight. When you adjust the temperature setting, the car considers some of the factors contributing to your perceived temperature. The car then continuously adapts its climate functions to make the interior climate feel like the temperature you selected. This means that the actual temperature in your car can differ from the temperature you selected, giving you a more consistent climate comfort experience.

Your car takes exposure to sunlight into consideration when regulating the climate in the car. For example, if the sun hits the driver's side, it can adjust the airflow and temperature to balance the perceived temperature on that side.

4.3.8.4. Climate sensors

There are several climate sensors located inside and outside of your car. These sensors help to provide a comfortable climate in the passenger compartment.

For the interior sensors to be able to perform as intended, it's important that you don't cover them.

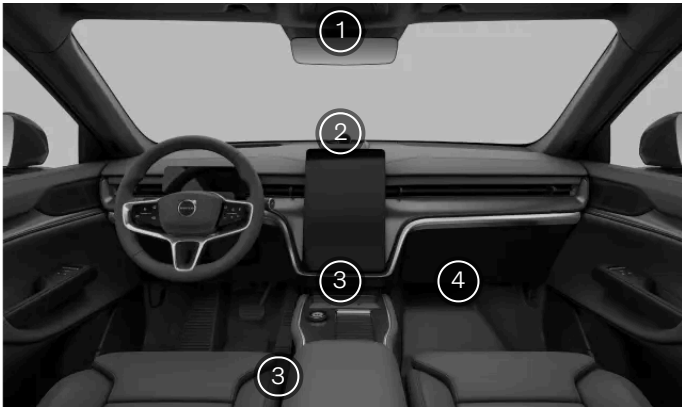

- ① Humidity sensor in the rear-view mirror console.
- ② Sunlight sensor on the upper side of the dashboard.
- ③ Passenger compartment temperature sensor under the centre display.
- ③ Passenger compartment temperature sensor between the tunnel console and the driver seat.
- ④ Airborne particulate matter sensor on the underside of the glove box.

The exterior ambient temperature sensor is located on the underside of the car.

4.3.8.5. Heaters

If the ambient temperature is lower than the temperature you prefer in your car, the heating system can help provide a comfortable interior climate.

Electric heater

The electric heater is powered by the car's traction battery. It is used to heat the battery and for heating the passenger compartment during preconditioning and while driving.

If the charge level in the traction battery is too low, the heater will switch off.

Heat pump

The heat pump works primarily as a range extender. In low temperatures, the heat pump helps to heat up the passenger compartment while using less energy compared to the electric heater, which extends the battery's power availability. The heat pump operates during both preconditioning and driving. It also helps to maintain the traction battery at its desired operating temperature.

4.4. Windows and glass panes

Your car has several different windows and glass panes. Many of them are laminated for added safety and security. The lamination also provides better sound insulation in the passenger compartment.

All laminated windows, except for the windscreen and panoramic roof, are labelled with a laminated glass symbol.



Note

Be sure not to use tinted film with a metallised surface coating on the front or rear windscreen. This can cause problems with signal reception as antennas are located here.

Panoramic roof

Your car's panoramic roof has an infrared coating which helps to keep the passenger compartment cool in sunny conditions.

It also has an electrochromic layer that lets you switch between transparent and tinted glass.

4.4.1. Operating the windows

You can use the power switches in the door panels to operate the windows. The switches in the driver door can control all of the windows in your car, while both the front and rear passenger switches are limited to controlling their respective windows.

Warning

Always consider the safety risks while operating the windows. The car's moving parts can cause injury to children or other occupants, as well as damage to objects.

- Make sure you have a clear view of the windows you're operating.
- Do not allow children to play with the window controls.
- Never leave children alone in the car.
- Never put an object or body part through an open window, even if the car's electrical system is fully disconnected.

The window switches may still work for a while after you exit the car. Keep this in mind when leaving the car unattended.

Control the windows individually using the switches on the driver door panel. Each switch controls the corresponding left and right window.

Press the window symbol  to select the rear windows. The current window selection is indicated by the lights next to the symbol.

All of the windows have built-in pinch protection to help prevent injuries. Be sure to read the relevant information on pinch protection in its separate section of the manual.

To operate the windows, a key must be present inside or near the car. If you use a key card, or if your distance-capable key is discharged, you need to place it on the card reader to be able to operate the windows.

i Note

Situations where the windows cannot be opened

- The windows cannot be opened at speeds above approximately 180 km/h (112 mph) but they can be closed.
- At very low temperatures, the windows might freeze in place and you won't be able to operate them.

1.

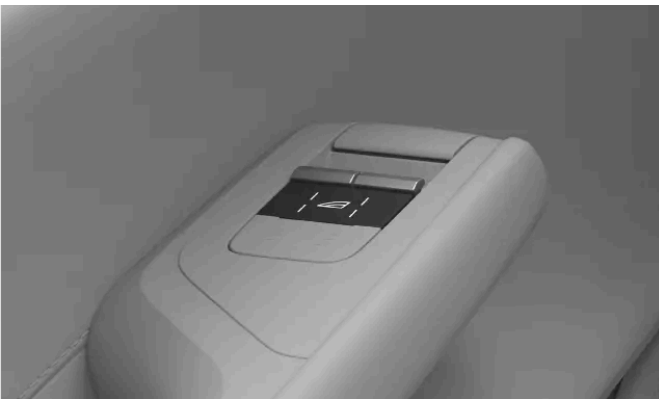

You can find the switches for the windows on the driver door.

Locate the switch on the door panel for the window you want to operate.

2. Use the switches to open or close the windows:

- A slight push or pull allows you to manually operate the window until you release the switch.
- If you push or pull the switch fully, the window automatically moves even if you release the switch. Stop it by moving the switch in the opposite direction.

i Tip

Noise reduction

One way to reduce wind noise when the rear windows are open is to also open the front windows slightly.

Child lock

You can disable the rear window controls in settings. This prevents rear seat passengers from operating the windows.

 **Note**

If automatic window movement or pinch protection isn't working properly, you may need to reset the windows. You can learn how to do this in a separate section of the manual.

4.4.2. Adjusting roof tint

Your car's panoramic roof is made of electrochromic glass. This means that you can switch between a transparent and a tinted roof.

The panoramic roof is protected by a layer of infrared film, shielding the passenger compartment from some of the outside heat on sunny days. In addition to this, the electrochromic properties of the glass make it possible to switch between a transparent and a tinted roof through the settings in the centre display.

1. Press the car symbol  in the bottom bar and go to **Settings**.
2. Go to **Controls** → **Lights and displays** → **Roof shading**.
3. Turn the roof shading on or off.

 **Tip**

You can also adjust the roof tint via quick controls in the centre display. This allows you to quickly adjust the roof tint without going into settings.

4.4.3. Pinch protection

To help prevent injuries from power-operated windows and other moving parts, your car has a built-in pinch protection system. Occupants should also keep proper user practices in mind to reduce the risk of getting caught between moving or closing parts.

If something is blocking the window when it is closing, it will stop and then slightly reverse, allowing you to remove what's in the way. In a similar manner, the boot is also covered by pinch protection when opening or closing.

 **Warning**

Always consider the safety risks while operating the windows. The car's moving parts can cause injury to children or other occupants, as well as damage to objects.

- Make sure you have a clear view of the windows you operate.
- Do not allow children to play with the window controls.
- Never leave children alone in the car.
- Never put an object or body part through an open window, even if the car's electrical system is fully disconnected.

If the automatic closing of a window stops due to obstructions, such as ice, you can still try to close the window manually by continuing to pull the control switch. However, always try to remove the source of the obstruction first and make sure nothing is blocking the path of the window before trying to close it again.

If there is a problem with the pinch protection, you can try to solve the issue by resetting the window.

 **Warning**

The power window pinch protection may not work properly if the car loses track of the current window position. The window positions are recalibrated when you reset the automatic window movement. Always reset it to make sure the window positions are correctly calibrated if:

- the car has lost power, for instance if the 12 V battery has been disconnected.
- the automatic window movement does not work properly.

This restores the automatic window functionality and re-enables the pinch protection function.

4.4.4. Resetting windows

If you're experiencing issues with a power-operated window, you may need to reset it. This allows the car to recalibrate its position to restore both pinch protection and automatic window movement.

Calibration errors

Your car continuously monitors your windows and how they are positioned. Sometimes, an error can occur causing your car to perceive a window's position to be different than it actually is. This can cause errors with the auto close function, as well as with the pinch protection. If there is a calibration error with a window, you can reset it yourself or with help from an authorised Volvo workshop.

There are two different calibration errors that can affect the window calibration. If the window monitoring system registers a calibration error, the auto close function is disabled. If the error is not detected, the auto close function may still work to a certain degree, but not as intended.

The two types of calibration errors are:

Offset down The window is further down than the car's registered window position. This stops the window from fully closing, as the car registers it as closed before it reaches the top of the window frame. You can recalibrate a window with this error on your own.

Offset up The window is further up than the car's registered window position. The manual controls work but if you use auto close, the window will close and then back down again. This is because the system registers the top of the window frame as an obstruction and activates pinch protection. There is no way to recalibrate a window with this offset on your own. Instead contact an authorised Volvo workshop.

! Important

The pinch protection system might not work properly until the window has been reset after losing calibration.

Before resetting a window, make sure it is fully closed. You can force the window to close completely by overriding the window's auto close movement system. Pull the window switch to the manual position three times in quick succession, then close the window manually.

Resetting window

1. Lightly press the window switch until the window is completely open.
 2. Lightly pull the switch until the window is completely closed.
- > Recalibration is now done, re-enabling both pinch protection and the automatic window movement.

Check to make sure that the window operates correctly after following the reset steps. The window should close completely when you pull the switch all the way and release. If the problem persists, contact an authorised Volvo workshop.

4.5. Seats

The seats are all designed to provide comfort and safety. Adjust the seats, activate comfort functions, and make sure to sit properly.



The seats of the car have a range of features to provide comfort, safety and flexibility.

In this section of the manual, you'll get to know the comfort features and adjustments available for the car seats. This includes features such as the seats' positional adjustments and how to fold the rear seats to get more space for stowing. At the same time, you will learn the essentials of how to use these features safely and properly.

For more information about the passive safety functions of the seats and to learn how to accommodate them through proper seating, there is a separate safety section in this manual.

4.5.1. Front seats

The front seats have plenty of adjustability to increase comfort.



Adjustability

The power seat adjustments are divided into groups called adjustment modes:

- | | |
|-------------------------|---|
| Basic adjustments | Height and position of the seat and backrest tilt. |
| Tilt and lumbar support | Lumbar support height and depth adjustments as well as seat cushion tilt. |
| Side support | Side bolster positions. |



Tip

Extending seat cushion

You can manually extend the seat cushion to better support the full length of your upper legs. Grasp the handle below the front of the cushion and pull the cushion outwards.

Seat adjustment knob

All power seat adjustments are done using the knob on the side of the seat. When you press the centre button, the seat adjustment view appears in the centre display to guide you.

Features

The front seats also have the following comfort features:

- Message** You can choose from five different massage programmes with three different speeds and intensities.
- Ventilation** Most parts of the front seats are ventilated. There are three levels of cooling to choose from.
- Heating** The seats have three levels of heating available.
- Speaker headrests** The front headrests have integrated speakers for a more immersive listening experience.



Important

Warning sounds

Never attach covers or pillows to the speaker headrests. The speakers are a part of the car's safety system and covering them might dampen the warning sounds.



Tip

Handbag storage

If you or your passengers bring a handbag or smaller luggage, you can find a convenient storage space for it underneath the front part of the tunnel console.

4.5.1.1. Adjusting front seats

Adjust the front seats with the seat adjustment knob. You can find this on the side of the seat closest to the door.

Seat adjustment knob



The seat adjustment knob can move up and down, forward and backward, as well as rotate in both directions. In the middle of the knob there's also a button you can use to change the active adjustment mode.

There are lots of different changes you can make to the seats. To control them all with the adjustment knob, the available changes have been grouped into separate adjustment modes. Each mode is visually represented in the centre display to guide you while adjusting the seat.

 **Warning**

Never adjust the seat while driving. This can cause dangerous distraction and loss of control. Instead, be sure to make all necessary adjustments to the seat before starting a drive.

Adjusting the seat

1. Start by pressing the button on the adjustment knob.
 - > The seat adjustment view appears in the centre display.
2. To cycle through the different adjustment modes, press the button on the knob repeatedly.
3. Rotate or move the knob to adjust the seat according to your preference.
 - > The visual guide in the centre display indicates which part of the seat you are adjusting.



Tip

Quick adjustments

You can also customise the seat without visual guidance from the centre display. Just move or rotate the seat adjustment knob to start adjusting. Note, however, that only the basic adjustment mode is available this way.

Extending seat cushion

You can manually extend the seat cushion to better support the full length of your upper legs. Grasp the handle below the front of the cushion and pull the cushion outwards.



Note

Adjustment lock

If you move the adjustment knob in the same direction numerous times within a short timeframe, the knob becomes temporarily unresponsive. A message also appears in the centre display, telling you the seat adjustment controls have been disabled. This is to prevent unintentional use of the adjustment knob.



Important

Once you've finished adjusting the seat to your liking, it's important to make sure other parts of the car are aligned correctly. Your driving posture is important and is affected by more than your seat adjustments, such as the position of your steering wheel, mirrors and head-up display.

4.5.1.2. Resetting the front seat positions

If the seat doesn't move to the saved profile position, or if the seat movement appears limited or uneven, the seat may need to be reset.

1. Move the seat all the way forwards and then all the way backwards.
2. Move the seat cushion to its highest position and then to its lowest position.
3. Adjust the seat to your preferred position and save it to your profile.

If the issue persists, contact your authorised Volvo workshop.

4.5.1.3. Activating seat massage

You can activate the seat massage function via the seat adjustment view in the centre display. There are several different massage programmes and settings you can choose from.

1. Press the button on the seat adjustment knob.



The knob is located on the side of the seat closest to the door.

- > The seat adjustment view appears in the centre display.
2. Select **Massage**.
 3. Select your preferred programme, speed and intensity.
 4. Select **Start**.
- > Massage starts and a notification appears in the centre display, telling you how long the massage runs for.

If you would like to stop the massage before the massage programme finishes, select **Stop** from the massage view in the centre display.



You can also reach the massage view in the centre display via settings without using the seat adjustment knob.

4.5.1.4. Extending the seat cushion

The cushion length of the front seats can be adjusted to better support your legs.



Grasp and pull the handle on the front of the seat.

2. Adjust the length of the seat cushion.

4.5.2. Second row seats

The rear seats of the car are divided into the second and third row, each supporting its own set of features and adjustments.



You can adjust the second row seats in a number of ways to get more space or use the additional features to better suit your needs.

Adjustable backrest tilt Adjust the tilt of the backrest to provide better comfort and back support.

Adjustable seat position You can move the seats forwards or backwards depending on the space you need.

The content of this manual represents the status of the user manual at the time of printing and may not be completely valid in future instances. For more information, refer to the first page for the complete disclaimer note.

Foldable headrests	The outer seats have foldable headrests. This can give you more space when you fold the seats.
Adjustable centre headrest	You can adjust the height of the centre headrest to fit the passenger, or set it to its lowest position when the seat is not in use.
Foldable backrests	You can fold the seats to create more cargo space. Each seat can be folded on its own.
Seat heating	The outer seats have access to three levels of heating. You can control this from the panel on the back of the tunnel console or from the centre display.



Tip

Rear seat centre armrest

Fold out the centre seat backrest to access cup holders and get additional arm support.

4.5.2.1. Adjusting outer second row seats

You can adjust the second row seats, either to make your seat feel more comfortable or to free up more space behind the seat.

Both the position of the seat and the tilt of the backrest can be set individually for each seat.



Warning

Never adjust the seats while the car is moving. Sudden braking or turning can make you lose control of the seat and risk injury.



Important

Child restraints

Never adjust the seat if there is a child restraint installed on it that uses either the lower or top tether anchorage points to secure it. This can damage the child restraint or loosen the tethers keeping it fixed in place.

Pinch risk

Take extra care when adjusting the seat position if the seat behind it has a passenger sitting in it or a child restraint installed on it.

Adjusting seat position



Grasp and pull the handle under the seat cushion upwards.

2. Slide the seat forwards or backwards to your preferred position.

3. Release the handle.

> The seat locks into place.

Adjusting backrest tilt



Pull and hold the handle on the side of the seat upwards to unlock backrest movement.

5. Lean forwards or backwards in the seat.

> The backrest follows your movement.

6. Release the handle when you've reached your preferred position.

7. Press against the backrest until it locks.

Important

After adjusting, folding or raising a seat, make sure all parts of the seat are properly locked in place.

4.5.2.2. Adjusting centre second row seat

You can adjust the centre second row seat, either to make your seat feel more comfortable or to free up more space behind the seat.

Both the position of the seat and the tilt of the backrest can be set for the centre seat.

Warning

Never adjust the seats while the car is moving. Sudden braking or turning can make you lose control of the seat and risk injury.

Important

Child restraints

Never adjust the seat if there is a child restraint installed on it that uses the lower tether anchorage points to secure it. This can damage the child restraint or loosen the tethers keeping it fixed in place.

Pinch risk

Take extra care when adjusting the seat position if the seat behind it has a passenger sitting in it or a child restraint installed on it.

Adjusting seat position

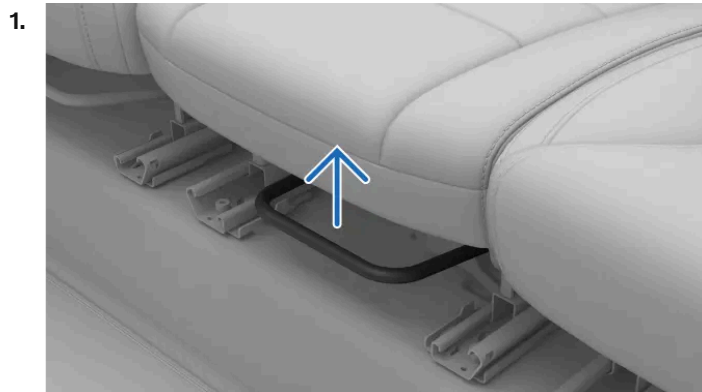

Grasp and pull the handle under the seat cushion upwards.

2. Slide the seat forwards or backwards to your preferred position.
 3. Release the handle.
- > The seat locks into place.

Adjusting backrest tilt

4.

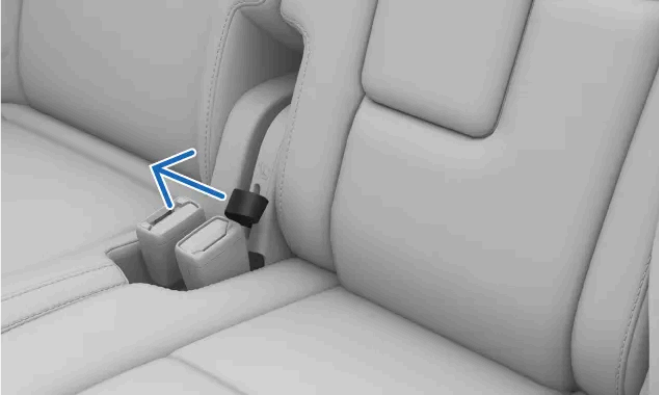

Pull and hold the strap on the side of the seat to unlock backrest movement.

5. Lean forwards or backwards in the seat.

> The backrest follows your movement.

6. Release the strap.

> The backrest locks into place.

Important

After adjusting, folding or raising a seat, make sure all parts of the seat are properly locked in place.

4.5.2.3. Adjusting centre second row headrest

The centre seat headrest should be adjusted according to your height and fully support back of your head if possible.

A correctly adjusted headrest can help prevent neck injury during collisions. It's important to align the headrest to cover as much as possible of the back of the head.

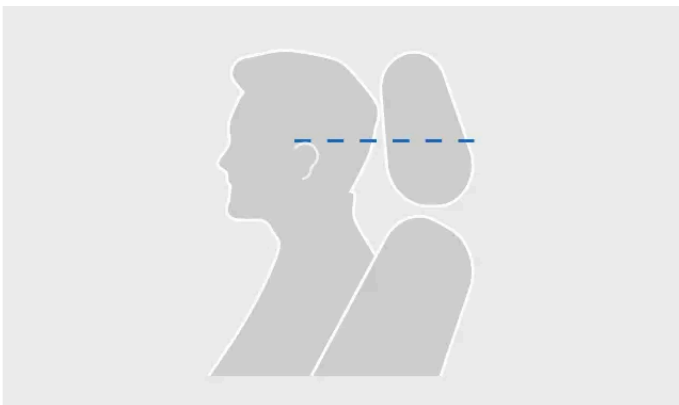

Correct headrest level

Upward movement of the headrest is not locked.

1. Pull the headrest upwards to a level that fits your height.

To lower the headrest, press and hold the button at the top middle of the headrest base to release the lock. Then, carefully push the headrest down.



Locking button on the centre headrest

i Tip

Make a habit of lowering the headrest when the centre seat is not used. When it's down, it doesn't risk obstructing the rear view.

4.5.2.4. Folding down the outer second row seats

You can fold the outer second row seats to get more stowing space.

! Important

Before folding the seats, make sure:

- there are no objects on the seats.
- the seatbelts are not buckled.
- there is enough space to fold the seats down. If needed, move the seats in front forwards.

 **Warning**

If any of the rear seats are folded down, they must not be in contact with the seats in front. This can impede the safety of other occupants.



Pull the handle on the side of the seat upwards.

- > The backrest and headrest release and tilt forwards.
- Guide the backrest down to its folded position.
- Press down on the backrest to lock it into place.

When you want to raise the seat again, use the same handle on the side of the seat to unlock the backrest. Then, manually push it to its upright position. Make sure the backrest locks into place. Finally, move the headrest back to its locked position.

 **Important**

After adjusting, folding or raising a seat, make sure all parts of the seat are properly locked in place.

4.5.2.5. Folding down the centre second row seat

You can fold the centre second row seat to get more stowing space.

 **Important**

Before folding the seats, make sure:

- there are no objects on the seats.
- the seatbelts are not buckled.
- there is enough space to fold the seats down. If needed, move the seats in front forwards.

 **Warning**

If any of the rear seats are folded down, they must not be in contact with the seats in front. This can impede the safety of other occupants.



Pull the strap on the side of the seat.

- > The backrest releases and tilts forwards slightly.
- Guide the backrest down to its folded position.
- Press down on the backrest to lock it into place.

When you want to raise the seat again, use the same strap on the side of the seat to unlock the backrest. Then manually push it to its upright position. Make sure the backrest locks into place.

 **Important**

After adjusting, folding or raising a seat, make sure all parts of the seat are properly locked in place.

4.5.2.6. Second row centre armrest

Part of the centre rear seat backrest can be folded out to act as an armrest.

There is a strap attached near the top of the centre rear seat. Pull this strap to fold out the rear centre armrest.



Rear centre armrest with cup holder

The centre armrest can provide additional arm support but also contains a hidden cup holder with two slots.

To access the cup holder, push the top section of the centre armrest and let go. The sides of the cup holder open up. When the cup holder is no longer in use, gently close both sides by pressing the indentations in the centre of the edges until you hear a click.

4.5.3. Third row seats

The rear seats of the car are divided into the second and third row, each supporting its own set of features and adjustments. The seats on the third row are designed with both comfort and flexibility in mind.



The seats have the following features:

Foldable backrests The backrests and headrests can fold in one motion to give you more stowing space.

Foldable headrests You can fold the headrests without folding the backrests. This can give you a more unobstructed rear view when the seats aren't in use.

4.5.3.1. Getting in and out of the third row

You can temporarily adjust the outer second row seats to make it easier to enter and exit the third row of seats.

! Important

Pinch risk

Be careful after getting in and out of the third row so that the second row seat does not press against or affect an installed child restraint or seated passenger.

1.



Pull the handle on the top of the outer seat backrest.

> The backrest unlocks.

2.



Pull the backrest to tilt it forwards until it comes to a stop.

3. Continue to pull the backrest to move the whole seat forwards.

To return the seat to its original position, follow the steps in reverse order. Push the seat backwards and allow the backrest to tilt backwards until it locks into place.

! Important

After adjusting, folding or raising a seat, make sure all parts of the seat are properly locked in place.

4.5.3.2. Folding down the third row seats

You can fold the third row seats from three locations in the car. Each location has its own benefits, depending on why you want to fold the seats.

Folding button locations



On the right-hand side in the boot, there is a button panel. The top two buttons, one for each seat, can be used to fold and raise the third row seats. This location can be useful if you need more room for stowing while using the boot.



When a rear door is open, you can find the folding buttons in the door frame. There is one identical set of buttons on each side of the car. These locations can be useful if you plan to fold both the second and third row seats.

Important

Before folding or raising the seats, make sure:

- no one is sitting in any of the third row seats.
- there are no loose items on or under the seats.
- the seatbelts are not buckled.
- there is enough space to fold the seats down. If needed, move the second row seats forwards.

 **Warning**

If any of the rear seats are folded down, they must not be in contact with the seats in front. This can impede the safety of other occupants.

- Press the folding button for the seat you want to fold.
- > The seat backrest and headrest fold forwards.

 **Note**

Pinch protection

If the car detects something is blocking the path while folding or raising the backrest, the backrest will revert to the start position. Remove what's in the way and press the folding button again. If something is blocking the backrest movement in both directions, the backrest locks itself and a timeout message appears in the centre display. You must dismiss this message before you can try again.

When you no longer need the extra cargo space, press the folding button again. The backrest will raise into position. Once the backrest is locked, manually move the headrest back until you hear a click.

 **Tip**

If any of the rear seats are folded down by mistake, you need to press the folding button again to stop the seat movement. The backrest will then move back to its original position.

4.6. Interior lighting

The lights in your car's passenger compartment provide illumination for different purposes. There are lights for reading as well as for general illumination and lighting up storage areas.

Reading lights

The front and rear seats have reading lights. You can adjust their intensity to suit your needs. In the rear, they also work as the general lighting.

General illumination

Your car has lights to provide general illumination of the passenger compartment, such as when you get into the car. General illumination can be activated both manually and automatically.

Ambience lights

The content of this manual represents the status of the user manual at the time of printing and may not be completely valid in future instances. For more information, refer to the first page for the complete disclaimer note.

The ambience lights in the car can provide a comfortable illumination of the passenger compartment when it's dark outside.

Storage area lights

There are lights in different storage areas, such as the boot and door pockets, to make it easier to find what you're looking for.

4.6.1. Adjusting the reading lights

There are reading lights available for the front and rear seats. You can adjust the brightness according to your needs.

The front seat reading lights are located in the overhead console and the rear reading lights can be found over the rear doors.

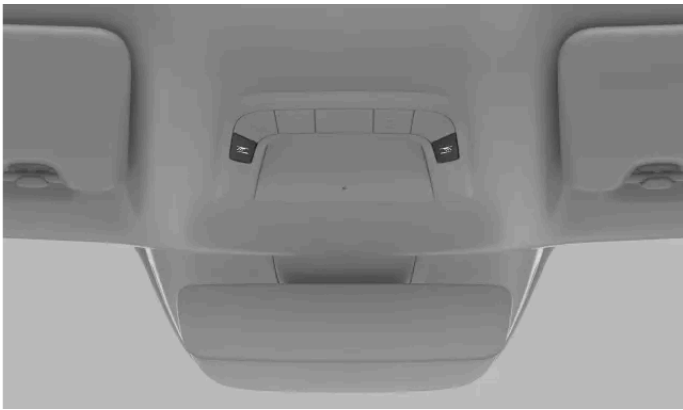

The front seat reading lights in the overhead console



Rear seat reading lights

1. Press the button next to your reading light to turn it on and off. The button is marked with a reading light symbol.



2. Hold the button down to adjust the brightness.

4.6.2. Adjusting interior lights

You can adjust the brightness of the interior lights in the lights and displays section of the settings.

1. Press the car symbol  in the bottom bar and go to **Settings**.
2. Go to **Controls** → **Lights and displays** → **Interior brightness**.
3. Adjust the brightness.



Tip

Screen and button brightness

You can adjust the brightness of the displays via the lights and displays menu in the centre display.

4.6.3. Disabling interior auto lights

The auto lights off function keeps the interior lights off, even when you are entering or exiting your car.

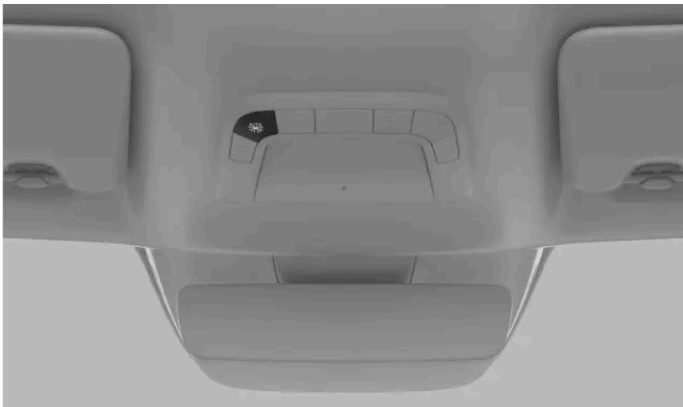

The auto lights off button in the overhead console

The interior auto lights function, sometimes called courtesy lights, turns the interior lights on automatically when a door is opened. The auto lights can make entering and exiting the car easier if it's dark outside. However, there may also be situations in which you don't want the lights to turn on, such as when passengers are sleeping in the car.

The auto lights off button is located in the overhead console and is marked with an auto lights off symbol.



When the auto lights are turned off, the button illumination changes colour.

The content of this manual represents the status of the user manual at the time of printing and may not be completely valid in future instances. For more information, refer to the first page for the complete disclaimer note.

1. Press the button to turn the function on or off.

***i* Note**

Even if the auto lights are disabled, the lights will still turn on if you use the lights all on function.

4.6.4. Activating all interior lights

Activating all interior lights turns on most of the interior lights. This can be helpful when you're looking for something in the passenger compartment.

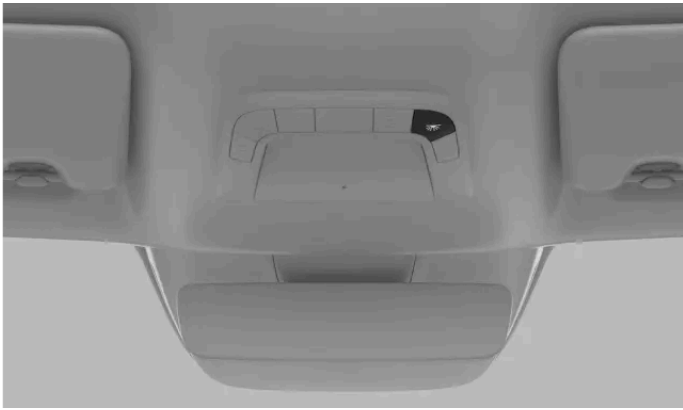

All interior lights on button in the overhead console

The activate all interior lights button is located in the overhead console and is marked with a light symbol.



1. Press the button to turn all interior lights on or off.

***i* Note**

Even if auto lights have been disabled, the lights will still turn on if you use the lights all on function.

5. Safety

Get to know your car's collision-protection features and what's required for safe use of the car.

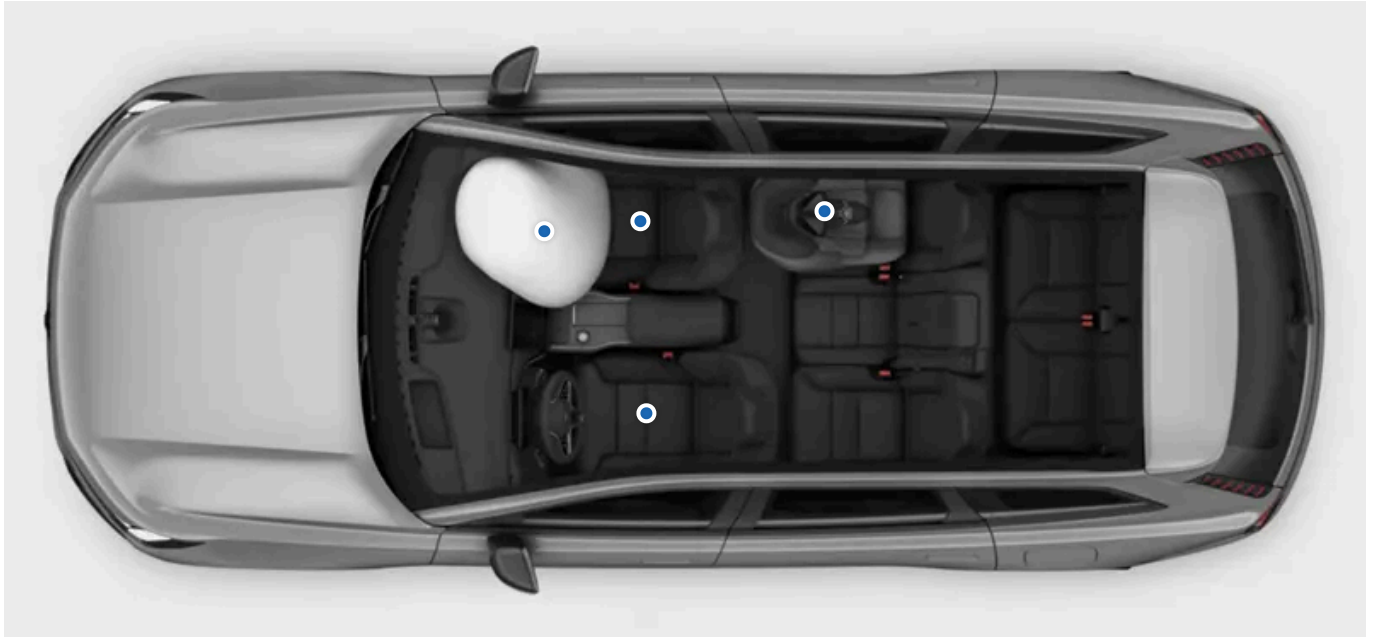

The safety section describes features designed to reduce the risk of serious injury in the event of a collision. The safety features include seatbelts, airbags, child restraints and other components or functions that can help save lives when used correctly.

Your car is designed to promote and provide the conditions for safe use. Safety features never replace the need for safe user practice. This not only applies to features directly related to safety, but also to the rest of your car. It's your responsibility to use the car's functions safely.

Warning

Safety synergy

The safety features are designed to work together to increase the safety of all occupants in the car. No feature replaces the need for another unless the manual explicitly states so. For example, the presence of airbags in no way reduces the need to wear a seatbelt.

SRS warning

Sensors in the car can detect if there is something wrong with the airbags or related safety systems. A red warning symbol will appear in the driver display to alert you if any faults are found.



SRS warning symbol

If the red SRS warning symbol appears in the driver display, immediately contact an authorised Volvo workshop.



Note

Start-up checks

Several safety systems are part of the car's start-up check. During the check, the yellow SRS symbol may appear in the driver display. This is completely normal and means that the safety systems are starting up and checking for potential issues. Make sure you address any indicated faults.



SRS start-up symbol

Safety-related areas

Some driver support functions are related to safety. Instead of keeping you safe in the event of an accident, they are designed to prevent them in the first place. Get to know those functions as well for a safer trip.

5.1. Collision response

In the event of a collision, your car has many features designed to help mitigate the effects. Your car's response to a collision happens before, during and after the impact.



Tip

You can find information related to collision response in many places throughout this manual. Therefore, this section exists to provide a more cohesive overview of your car's capabilities in this area.

Before

Before an impact, several driver support functions can work to avoid the collision or reduce its effects. If the car perceives a collision to be likely or unavoidable, it has the ability to pre-emptively activate protective systems, such as seatbelt pretensioning, before the impact occurs.

During

During the collision, sensors throughout the car continuously provide information about the states of the car and its occupants. The car uses the information to selectively time and activate protective functions such as airbag deployment and seatbelt pretensioning. Collisions are complex events that can unfold in several stages, where the first impact isn't necessarily the most severe. Good timing is essential for the best chance of effective protection.

The car's safety systems work in synergy with passive safety features. In the event of a collision, your car's construction distributes forces to specific structural components. It also takes advantage of crumple zones that absorb energy from the impact. Using similar principles, the exterior has been designed with the protection of pedestrians in mind.

After

After a collision, the car tries to stop in a controlled and safe manner. It can also make an automated call for emergency response.

Note

Safety mode

During a collision, the safety systems of the car may disconnect the high-voltage battery. This is to protect both the occupants and the car itself from potential damage caused by the battery. At the same time, the car enters safety mode. When safety mode is active, you cannot drive the car. However, depending on the severity of the collision, you can exit safety mode via the centre display if you need to move the car out of immediate danger. This in turn reconnects the high-voltage battery and enables short distance driving.

Important

Your car is designed around safety, but no protective system is 100% effective in all situations. Safety features never replace the need for safe user practice.

5.1.1. Pedestrian protection system

In the event of a frontal collision with a pedestrian, your car is equipped with a system that can mitigate the effects of the impact. If the system has been activated, your car needs to be recovered and serviced.

The pedestrian protection system is designed to reduce pedestrian injuries in case of a collision with the car. If the system is triggered during a collision, the car responds in three specific ways, in addition to the normal collision behaviour:

- The bonnet lifts to absorb the impact from the pedestrian.
- An automatic alarm is sent via an emergency call centre.
- A symbol appears in the driver display to indicate the system has been triggered.



Pedestrian protection system

If the system has been triggered, follow the recommendations given.

Note

The pedestrian protection system relies on sensors to detect certain types of collisions. The sensors are active at a speed of approx. 25-50 km/h (15-30 mph) but there are many conditions and factors that determine whether or not the pedestrian protection system will trigger. There may be objects in the car's surrounding environment that the sensors detect in a similar way to a pedestrian. It is possible that the system will activate in the event of a collision with such an object.

 **Important**

Driver responsibility

The pedestrian protection system is a supplement to safe driving practices. It does not reduce or replace the need for the driver to stay attentive and focused on driving safely. Drive the car with the same attention to safety as required by a car without the ability to mitigate collisions.

 **Warning**

Damaged front

Contact an authorised Volvo workshop if the front of the car has been damaged in any way. This is to ensure the damage hasn't affected any of the car's safety systems, including the pedestrian protection system.

Raised bonnet after activation

Do not drive the car if the bonnet is blocking your view after the system has been activated. It is recommended to have the car transported with a recovery vehicle instead. If the pedestrian protection system has been activated, your car needs service at an authorised Volvo workshop.

Car modifications

Do not make modifications or additions to the front of the car. Modifications to the car risk adversely affecting the safety systems and could lead to serious injury and damage to the car. Carefully read the section about car modifications and contact Volvo if you are considering modifying your car.

5.2. Occupant detection

Your car can remind you not to leave anyone in the car when you lock it.

Presence warnings

By default, your car alerts you if it detects that passengers or pets are still in the car when you try to lock it. When this happens, your car will not lock and you'll receive a notification in the centre display. However, it's possible to lock the car with a passenger inside if you've temporarily allowed occupant locking in the locking settings.

 **Tip**

Mobile notification

If your Volvo Cars app is linked to the profile currently signed in to the car, you will also get a notification in the app in situations when the car would alert you.

 **Note**

Double lock

Double lock is an anti-theft feature that prevents your car from being unlocked from the inside. For safety reasons, the car won't double lock when it detects passengers inside the car. This is to ensure that any remaining occupants in the car can exit safely in the event of an emergency.

 **Warning**

Volvo recommends not leaving people or pets in a locked car.

Some regions have laws prohibiting people or pets being left inside a locked vehicle.

5.3. Proper seating

Appropriate seating and proper seatbelt use are essential for the safety and comfort of everyone in the car. There are also specific recommendations for pregnancy and child seating.

 **Important**

Importance of proper seating

Safety features, such as seatbelts and airbags, require that all occupants are properly seated for the best chance of effective protection in a collision. Failure to follow the seating instructions can endanger life or lead to serious injury.

Pregnancy

Take extra care to follow all seating recommendations if the occupant is pregnant. The following are either additions or of extra importance:

- Make sure that the seatbelt does not cross the belly. The hip strap should be under the belly and the shoulder section should pass above it.
- If seated in the driver's seat, avoid sitting closer to the steering wheel than necessary. Adjust the seat to create as much distance between the belly and wheel as possible while also keeping all driver controls comfortably within reach.

Child seating needs

Always seat children with extra care and attention to their needs. Make sure you have the required child restraint, that it's installed correctly and that the child remains safely seated throughout the entire trip. For children travelling forward-facing, the same seating recommendations apply as for adults. Always make sure the seatbelt is properly adjusted and that the headrest is at a height suitable for the child when possible.

Note

Physical limitations

Physical limitations can prevent an occupant from following the seating recommendations. The car may need modifications to accommodate safe use. Contact an authorised Volvo workshop for information about Volvo-approved modifications.

Sitting posture

Both sitting posture and proper seatbelt adjustment are important for safety. Avoid irregular sitting postures.



A correctly seated occupant. Do not adopt other postures when the car is moving.



Do not slide forward in the seat. The lower back should have contact with the backrest.

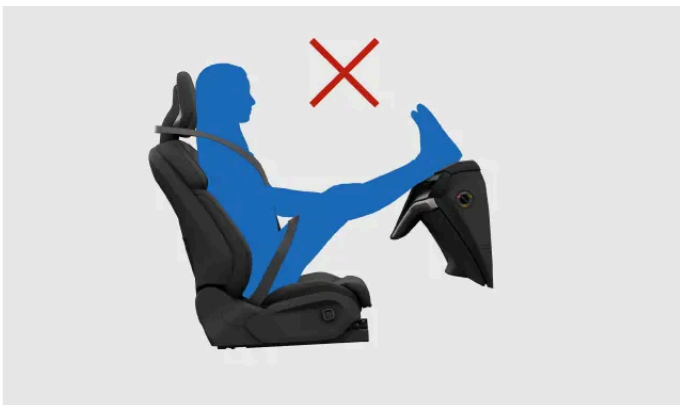

Keep both feet planted on the floor.

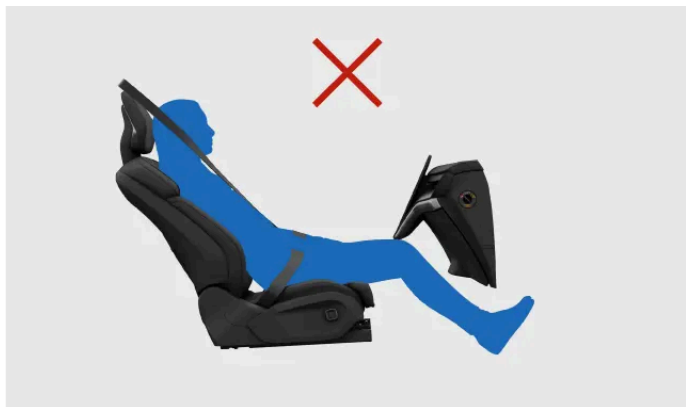

Do not tilt the backrest to a lying position. The seatbelt must remain tensioned against the shoulder.

Whiplash protection considerations

Proper headrest use is essential to reduce the risk of neck injuries in a collision. All of the car's headrests are designed to help protect the head and neck when used correctly. As an added safety feature, the front seats' construction can reduce the risk of whiplash injuries in certain collisions. These seats are designed to shift in a way that lowers whiplash-associated forces.

- Keep the back of your head against the headrest.
- Make sure occupants have correctly adjusted headrests where possible.
- Avoid stowing luggage against the back of the front seats. It can prevent the seat from moving as intended in the event of a collision.

5.4. Seatbelts

When you use seatbelts correctly, they can help prevent serious injury in situations ranging from sudden braking to severe collisions.

Seatbelt features



The seatbelt locks itself to act as a safety restraint under certain conditions, such as sudden and forceful pulling of the belt, if the car is driven aggressively and if the car is on a steep incline.

The car can use belt pulses to alert the driver. The seatbelt can also adjust as a safety precaution in a high-risk situation.

Built-in seatbelt pretensioners can tighten the seatbelts extremely quickly in response to a collision.

Seatbelt reminder

The car uses built-in sensors to detect if the driver or any of the passengers aren't using their seatbelts. The system alerts the driver with a warning sound and the seatbelt reminder symbol appears in the overhead console.



Seatbelt reminder symbol

 **Important**

Wearing seatbelts

These are the essentials for wearing seatbelts properly. There is also more detailed information in other sections of the manual covering proper seating and seatbelt adjustments.

- Make sure that everyone in the car wears their seatbelt and that all belts are properly adjusted.
- Adjust the upper anchor point of the seatbelt to fit the wearer's size.
- Wear the seatbelt closely against the body.
- Minimise slack in all belt segments.
- Allow the belt to run as straight as possible between its three anchor points.^[1]
- Have the backrest in an upright position.
- Follow all seating and posture recommendations.^[2]
- Do not wear the seatbelt in ways other than those described in this manual.
- Always use seatbelts when driving.
- Never use the same seatbelt for more than one individual at a time.

 **Warning**

Seatbelt care and maintenance

- Never modify or repair seatbelts or related parts, such as fittings and hooks, yourself. Any service or replacement must be done by a trained technician with access to type-approved parts.^[3]
- Contact an authorised Volvo workshop if the seatbelt or a related part shows signs of damage or wear.
- Replace the seatbelt if it has been subjected to a heavy load, such as in a collision. It may have lost protective properties even if there is no apparent damage.
- Clean the seatbelt as soon as possible if anything is spilled onto it. The spilled substance can enter the mechanism and deteriorate the material.

^[1] For example, never wrap around or attach it to other items or fittings in the car.

^[2] There are general seating recommendations as well as specific recommendations for children and pregnant occupants.

^[3] Volvo recommends an authorised Volvo workshop.

5.4.1. Fastening and adjusting seatbelt

A correctly fastened and adjusted seatbelt is important for your safety as well as comfort.



Correctly fastened and adjusted seatbelt.

Note

These instructions apply to adults and children who are seated normally or are using a booster seat or booster cushion. Read the separate section covering child safety for detailed information about child seating and different types of child restraints.

Fastening the seatbelt

1. Pull the seatbelt out by the latch plate. If you pull too fast, the locking mechanism will engage.
 2. While extended, check the belt for twists, knots or damage.
 3. Insert the latch plate into the buckle.
- > The latch plate clicks into place.

Warning

Check when seatbelt is fastened

- The seatbelt should run directly and as straight as possible between its three anchor points. Any unnecessary slack increases the risk of injury.
- Make sure everyone in the car is wearing their seatbelt correctly.
- Use the correct buckle for each rear seatbelt. Using the wrong buckle can lead to a seatbelt malfunction or failure.

Adjusting the seatbelt

4. For occupants in the front and outer second row seats, adjust the height of the seatbelt's upper anchor point.



Seatbelt upper anchor point

1. Hold the button on the upper anchor point down to allow it to slide up and down.
 2. Place it as high as possible without the belt touching the throat or neck.
5. Tension the hip strap to remove slack by pulling upwards on the diagonal chest strap. It should be as straight and low as possible, running below the abdomen.

 **Important**

Pregnancy

Take extra care to follow all seating recommendations if the occupant is pregnant. Make sure that the seatbelt does not cross the belly. The hip strap should be under the belly and the shoulder section should pass above it.

Releasing the seatbelt

6. Release the seatbelt by pressing the buckle button.
7. Guide the seatbelt back to its retracted position.

 **Important**

Make sure the seatbelt retracts fully after using it. Closing a door with the seatbelt caught in the gap can damage both the seatbelt and the door.

5.4.2. Seatbelt reminder

The car uses built-in sensors to detect if the driver or any of the passengers aren't using their seatbelts.

If the car detects any occupants that are not wearing their seatbelts, the system alerts the driver with a warning sound and the seatbelt reminder symbol appears in the overhead console as well as the driver display.



Seatbelt reminder symbol

You can find information about which seatbelts aren't fastened in the driver display.



Car overview in the driver display

If the reminder appears, buckle the indicated seatbelts as soon as possible in a safe manner. Stop the car, if necessary, to avoid distracted driving.

In some cases, the sensors may mistake an object on the seat for a passenger and alert you if the seatbelt hasn't been fastened. If you dismiss these reminders in the driver display, the large graphic will disappear but the other warning indicators will remain active. Buckle the seatbelt to remove them.



Warning

Always make sure everyone in the car wears their seatbelt.

5.5. Airbags

There are several airbags that your car can deploy in a collision. They can help reduce the impact forces experienced by occupants.



The image shows a selection of available airbags. Continue reading for details on the airbags in your car.

The airbags are designed to work with the rest of the car's safety features. Their effectiveness particularly relies on proper seating and seatbelt use. An airbag deployment is a sudden, forceful but controlled event that can significantly lower the risk of serious injury for correctly seated occupants.



Warning

The airbags cannot work as intended if an occupant is incorrectly seated in the event of a collision. Always use seatbelts.

Sensors throughout your car allow it to deploy different airbags based on information about the collision itself, as well as the status of the car and its occupants.

Airbag types

Your car has the following airbag types:

- Front airbags** Frontal collision airbags for the front occupants.
- Side airbags** Seat-integrated side-on collision airbags for the front occupants.
- Inflatable curtains** Ceiling-mounted airbags for occupants seated by a window.

5.5.1. Airbag deployment

If an airbag has deployed, your car needs to be recovered and serviced.

When the car deploys an airbag, it inflates almost instantly with considerable force accompanied by a loud noise. After that point, it behaves differently depending on the type of airbag. The front and side airbags deflate as they are compressed and provide controlled cushioning for a single severe impact. The inflatable curtains stay inflated longer to protect against repeated impacts.



Warning

Airbag-related injuries

No safety feature can prevent all possible injuries in a collision. The airbags are designed to reduce the risk of severe injuries. Impacting an airbag often results in some form of injury, and several factors affect the type and severity of the injury. Reading the manual allows you to recognise and avoid practices known to increase the risk of injury.

To reduce the risk of airbag-related injuries in a collision:

- Follow the manual's instructions for proper seating and use of seatbelts.
- Learn the placement of all airbags and how they affect the use of your car.
- Properly stow loose objects when driving and do not place or mount any objects around the airbag deployment areas.
- Do not make any modifications to the interior or electrical systems of your car that are not approved by Volvo.

Note

Deployment conditions

Not all airbags may deploy in a collision. This is because different airbags require different conditions and forces to deploy. The severity of damage to the car after a collision is not a reliable indicator of whether any airbags should have deployed.

Airbag gases and smoke

- The gas inside an airbag contains smoke that releases into the interior compartment when the airbag deflates.
- Always be attentive to signs of fire after a severe collision, but keep in mind that some smoke is normal if an airbag has deployed.

After airbag deployment

After a collision in which the airbags have deployed, prioritise the safety and medical needs of those involved in the accident. Before handling the car, contact an authorised Volvo workshop. Follow the manual's instructions for safe handling and recovery of a car that's immobilised or in safety mode.

Important

Do not try to drive or move the car if any of the airbags have deployed. If the car poses an acute traffic hazard and is able to move, an exception can be made to move it a short distance out of immediate danger.

5.5.2. Front airbags

The front airbags are designed to deploy in certain frontal collisions. The front passenger airbag can be disabled to accommodate certain rearward-facing child restraints.

The front airbags can help protect the driver and front passenger from severe injury if they are properly seated during a collision. The airbags on each side deploy independently of one another.

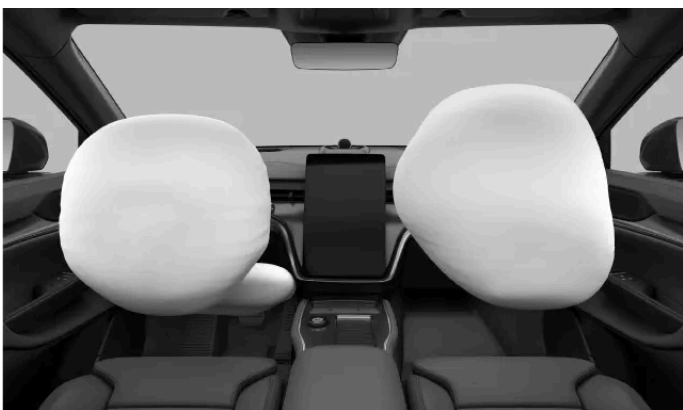

The driver side has two front airbags. The upper airbag is packed inside the steering wheel and the knee airbag is packed behind a panel below the steering wheel.

The content of this manual represents the status of the user manual at the time of printing and may not be completely valid in future instances. For more information, refer to the first page for the complete disclaimer note.

The passenger side has a single front airbag. The airbag is packed behind a panel above the glove box.

All front airbag locations are marked with the text AIRBAG or SRS AIRBAG.

 **Warning**

Do not block the front airbags

- Do not place luggage, children or pets in the space between the seated occupant and the front airbags, including in the occupant's lap.
- Legs or feet must never be placed on the dashboard. This could endanger life or lead to serious injury.
- Do not place or mount any items on the dashboard. Even small objects can become dangerous projectiles in a collision and end up between inflating airbags and occupants.

Blocking airbags in general

Keep all airbag locations and expansion spaces free of obstructions. Obstructions can reduce airbag effectiveness and cause serious injury.

- Follow the instructions for a correct sitting posture.
- Properly stow luggage and other objects. The car has several luggage compartments for safe stowing.
- Do not modify or mount accessories to any panel covering an airbag or adjacent panels.

Passenger airbag switch

You can enable or disable the front passenger airbag using the airbag switch. In addition to the passenger airbag, the switch also controls the status of the passenger seat's side airbags and parts of the seatbelt pretensioner. The passenger airbag needs to be disabled before you install a rearward-facing child restraint on the front passenger seat. Read all information about airbags and child safety before installing a child restraint.

Passenger airbag status

The passenger airbag status is shown in the overhead console.



This icon indicates that the passenger airbag is enabled and can be deployed by the car.



This icon indicates that the passenger airbag is disabled and cannot be deployed by the car.

 **Warning**

Child restraints and front passenger seat

NEVER use a rearward facing child restraint on a seat protected by an ACTIVE AIRBAG in front of it, DEATH or SERIOUS INJURY to the CHILD can occur.

 **Tip**

Read everything about airbags

There is more information about airbags and safety in general. Make sure you have read everything about these topics so that you understand the capabilities and limitations of your car's safety features.

5.5.2.1. Disabling and enabling front passenger airbag

To use a rearward-facing child restraint in the front passenger seat, you must first disable the seat's airbags using the passenger airbag switch. When disabled, the airbags will not deploy in a collision.

Switch location and positions



Location of the passenger airbag switch

The airbag switch is located on the side of the dashboard and is accessible when the front passenger door is open.

It has two positions. They are marked with both symbols and text indicating whether the front passenger airbags are enabled or disabled.



Airbags enabled. Always use this position when a forward-facing passenger, either child or adult, is in the seat.

In the position marked ON, the airbags are enabled and can be deployed by the car.



Airbags disabled. Always use this position when a rearward-facing child restraint is installed in the front passenger seat.

In the position marked OFF, the airbags are disabled and cannot be deployed by the car.

 **Important**

Read all information about front airbags, side airbags and child seating before changing the passenger airbag status.

Changing the airbag switch position

1. Pull the switch outwards and turn it to position ON or OFF.
- > The driver display confirms the status change.
If set to ON, the message **Passenger airbag on** appears. The airbags are enabled.
If set to OFF, the message **Passenger airbag off** appears. The airbags are disabled.

 **Note**

The overhead console always shows the current passenger airbag status. Make a habit of regularly checking it before driving, especially if a rearward-facing child restraint has recently been installed or removed.

5.5.3. Side airbags

The side airbags are designed to deploy in the event of a side-on collision.

The side airbags can help protect the driver and front passenger, if they are properly seated. The side airbags will typically only deploy on the collision side of each front seat.



Left-side collision airbags for the front occupants. In a right-side collision they deploy on the other side of each front seat, mirrored compared to the depicted scenario.

The side airbags are placed on either side of each front seat. The airbags are packed into the seat's back frame on both sides of the seat.

Both front seats have markings with the text AIRBAG.

Warning

Do not block the side airbags

- Do not place any objects on either side of the front seats. Objects between the seats and the door panel, or between the seats and the tunnel console, can interfere with the side airbags.
- Do not use seat covers that have not been approved by Volvo.

Blocking airbags in general

Keep all airbag locations and expansion spaces free of obstructions. Obstructions can reduce airbag effectiveness and cause serious injury.

- Follow the instructions for a correct sitting posture.
- Properly stow luggage and other objects. The car has several luggage compartments for safe stowing.
- Do not modify or mount accessories to any panel covering an airbag or adjacent panels.



Tip

Read everything about airbags

There is more information about airbags and safety in general. Make sure you have read everything about these topics so that you understand the capabilities and limitations of your car's safety features.

5.5.4. Inflatable curtains

Your car's inflatable curtains help protect occupants seated by a window in certain collisions. They are placed above the doors on both sides of the car.

The inflatable curtains are designed to help protect the head of a properly seated and secured occupant. Unlike conventional airbags, the inflatable curtains stay inflated for an extended time after deployment.



Inflatable curtain deployed on one side of the car.

The inflatable curtains are packed behind panels along the ceiling's edges on both sides of the car. The panels are marked IC AIRBAG.

Warning

Do not block the inflatable curtains

- Do not hang heavy items from the ceiling hooks or handles. The hooks are meant for light coats and jackets.
- Do not modify or mount accessories to the panels covering the inflatable curtains, the ceiling, pillars or adjacent panels.

Blocking airbags in general

Keep all airbag locations and expansion spaces free of obstructions. Obstructions can reduce airbag effectiveness and cause serious injury.

- Follow the instructions for a correct sitting posture.
- Properly stow luggage and other objects. The car has several luggage compartments for safe stowing.
- Do not modify or mount accessories to any panel covering an airbag or adjacent panels.

Tip

Read everything about airbags

There is more information about airbags and safety in general. Make sure you have read everything about these topics so that you understand the capabilities and limitations of your car's safety features.

5.5.5. Airbag maintenance and servicing

Contact an authorised Volvo workshop if there is any indication of faults or damage to the airbags or other safety systems.

Any servicing or repairs of the airbags and related safety systems must be performed by authorised service technicians.^[1] Never attempt to alter or repair any part of the car's safety systems yourself. Incorrectly performed repairs can lead to malfunctions and serious injury. Contact an authorised Volvo workshop when your car needs servicing or repairs.

Note

A warning appears in the driver display if the car detects any airbag faults. Immediately contact an authorised Volvo workshop if this happens.



Red SRS warning symbol

^[1] Volvo recommends an authorised Volvo workshop for any repairs or servicing.

5.5.6. Airbag labels

The airbag labels in your car provide essential information about the airbags or can act as airbag location markers.

Airbag location labels

Places in your car marked either AIRBAG, IC AIRBAG or SRS AIRBAG indicate that there is an airbag in that location.

Warning

Airbag label locations

The airbag label locations tell you where your car's airbags are located. Keep these locations and the space around them free of objects. Obstructions can interfere with airbag deployment, reduce their effectiveness and cause serious injury.

The airbags section contains more detailed information about use and conditions that can affect the airbags.

Airbag information labels



This label is located on the front passenger seat's sun visor.

Warning

Child restraints and front passenger seat

NEVER use a rearward facing child restraint on a seat protected by an ACTIVE AIRBAG in front of it, DEATH or SERIOUS INJURY to the CHILD can occur.

5.6. Child safety

Several features in the car aim to increase child safety, including anchorage points for child restraint installation and child locks.



Children in the car should always be securely seated and kept under adult supervision. Follow the recommendations in this manual as well as the local regulations and recommendations that apply to you.



Warning

Securely seated

- Children should be securely seated in a child restraint or with the car's seatbelt depending on their age and size. Never let a child sit in the lap of another passenger or in a location not intended for passengers.
- Other occupants in the car should be properly seated and use the seatbelts correctly. This can help prevent serious injury to children in the car in situations ranging from sudden braking to severe collisions.

Under supervision

- Never leave children alone in the car. Children may be exposed to potentially harmful temperatures on hot or cold days, or may lock themselves in.
- Do not allow children to play in the car or play with any of the car's controls. This reduces the risk of injury to the child or inadvertent activation or deactivation of the car's features.

5.6.1. Child restraints

Children should always use suitable child restraints and be securely seated in the car according to given recommendations.

Different types of child restraints are specifically designed for certain age and height ranges. Your car is equipped with child restraint anchorage points that suit different types of child restraints.

Volvo recommends that children use rearward-facing child restraints for as long as possible, until at least the age of four. After that, children should use forward-facing child restraints, preferably a booster seat using the car's seatbelt to secure the child. Children should use a child restraint until they reach at least 140 centimetres (4 feet 7 inches) in height.

Child restraints are classified into different approval levels:

i-Size	The i-Size child restraint standard uses ISOFIX in combination with the top tether anchorage points or a support leg. This standard ensures that any i-Size child restraint can be used on a seat designated as i-Size approved.
Universal	A child restraint of this approval level can be installed on a seat in any car model, as long as the car seat position is suitable for universally approved child restraints according to the car's manual.
Vehicle specific	A child restraint of this approval level can be installed on a seat in specific car models, as long as the child restraint manufacturer has included the car model in the type list for the specific restraint.

 **Warning**

Child restraints and front passenger seat

NEVER use a rearward facing child restraint on a seat protected by an ACTIVE AIRBAG in front of it, DEATH or SERIOUS INJURY to the CHILD can occur.

Damaged and old child restraints

Never use or reuse a child restraint:

- if the restraint has been involved in an accident or is damaged in any way
- if the expiry date or service life of the restraint has been exceeded
- if you don't know the full history of the restraint.

 **Important**

Loose child restraints

Never leave a loose child restraint in the passenger compartment. When not in use, keep it installed according to the manufacturer's instructions or store it securely in the boot. A loose child restraint can cause damage in the event of a collision or sudden braking.

General safety recommendations

When applicable, follow the general safety recommendations regarding seatbelt use, headrest adjustment and proper seating.

Local regulations

Regulations on where and how children should be seated and secured differ between regions. Make sure that you know what applies to the region you are in.

Airbag information labels



This label is located on the front passenger seat's sun visor.

5.6.1.1. Installing child restraints

When installing and using a child restraint, there is a number of things to keep in mind, depending on the location of the child restraint in your car.

Warning

Follow the instructions

Take extra care to read all information about child safety in this manual and follow the instructions from the manufacturer of your child restraint. If you do not, the child could sustain serious injury in the event of an accident.

Child restraints and front passenger seat

NEVER use a rearward facing child restraint on a seat protected by an ACTIVE AIRBAG in front of it, DEATH or SERIOUS INJURY to the CHILD can occur.

Important

Local regulations

Regulations on where and how children should be seated and secured differ between regions. Make sure that you know what applies to the region you are in.

Manufacturer's instructions

Always follow the instructions from the manufacturer of the child restraint.

5.6.1.1.1. Installing child restraints on the outer second row seats

To securely install a child restraint on either of the outer second row seats, there is important information to read and recommendations to follow.

ISOFIX, top and lower tether anchorage points can be used when installing a child restraint on the outer second row seats.

These seats are approved for i-Size child restraints.

 **Tip**

Long-term use of a child restraint may cause wear and tear on the car interior. Use a kick guard accessory to protect the car interior.

Allowed child restraints

- Only use child restraints that are recommended by Volvo, i-Size approved, universally approved or are vehicle specific approved where the car is included in the child restraint manufacturer's vehicle list.

Seat preparations

- Remove cushion extenders, leg supports and other accessories from the seat before installing a child restraint. If you use a kick guard accessory, this can remain on the seat.
- Any support legs of a child restraint should always be fitted directly to the floor. Do not fit support legs to any raised or uneven floor surfaces, footrests or other objects. To get enough space, adjust the seat to its rearmost position before installing.^[1]
- Loose objects should not be stored around any support legs of a child restraint.
- Any restraining straps of a child restraint should always be secured to designated anchorage points. Do not secure restraining straps to seat rails, handles or other parts of the interior.
- When installing an adjustable, rearward-facing child restraint, adjust the child restraint according to the child's age. Older children should be seated in a more upright position than younger ones.

Seatbelt use

- When installing a child restraint secured using the car's seatbelt or when the car's seatbelt is used to secure a child, ensure that brackets or other parts of the restraint do not come into contact with the seatbelt buckle button.
- When securing a child with the car's seatbelt, always start with the seatbelt's upper anchorage point adjusted to its highest level. Then lower it as needed to properly position the belt against the shoulder.

 **Tip**

Buckling the seatbelt

It can be difficult to buckle a child sitting in a child restraint due to the narrow spaces involved. To make it easier, push the belt buckle forwards slightly. This will give you a better angle to work with. You can also temporarily move the seat next to the child restraint to get more space.

 **Warning**

Follow the instructions

Take extra care to read all information about child safety in this manual and follow the instructions from the manufacturer of your child restraint. If you do not, the child could sustain serious injury in the event of an accident.

 **Important**

Follow the general recommendations for any child restraint anchorage points used to install a child restraint.

1. Follow the instructions from the manufacturer to install the child restraint.

 **Note**

Installation questions

If you have installation questions, contact the manufacturer of the child restraint for more detailed instructions.

Protecting the car interior

During installation, be careful to avoid damage to the car interior caused by protruding parts or sharp edges of the child restraint.

- If the child restraint uses lower tether straps, never adjust the position of the seat after the straps have been secured to the lower tether anchorage points. Always remember to remove the straps when the child restraint is not installed.
- Never adjust the backrest of a seat if there is a child restraint installed on it that uses the top tether anchorage point to secure it. This can damage the child restraint or loosen the tethers keeping it fixed in place.
- Fasten loose parts of child restraints, such as restraining straps, according to the manufacturer's instructions.

 **Important**

Raised headrest

The headrest must always be raised when a child restraint is installed.

General safety recommendations

When applicable, follow the general safety recommendations regarding seatbelt use, headrest adjustment and proper seating.

Local regulations

Regulations on where and how children should be seated and secured differ between regions. Make sure that you know what applies to the region you are in.



Tip

Seatbelt reminder

The seatbelt reminder may appear for a seat if a child restraint has been installed without using the car's seatbelt. You can dismiss the reminder in the driver display, but other warning indicators will remain active. Buckle the seatbelt to remove them.

^[1] An exception can be made if a child restraint is also installed on the seat behind it. In this case, try to adjust the seat to accommodate both child restraints.

5.6.1.1.2. Installing child restraints on the centre second row seat

To securely install a child restraint on the centre second row seat, there is important information to read and recommendations to follow.

Lower tether anchorage points can be used when installing a child restraint on the centre seat.



Tip

Long-term use of a child restraint may cause wear and tear on the car interior. Use a kick guard accessory to protect the car interior.

Allowed child restraints

- Only use child restraints that are recommended by Volvo, universally approved or are vehicle specific approved where the car is included in the manufacturer's vehicle list.

Seat preparations

- Remove cushion extenders, leg supports and other accessories from the seat before installing a child restraint. If you use a kick guard accessory, this can remain on the seat.
- Any support legs of a child restraint should always be fitted directly to the floor. Do not fit support legs to any raised or uneven floor surfaces, footrests or other objects. To get enough space, adjust the seat to its rearmost position before installing.^[1]
- Loose objects should not be stored around any support legs of a child restraint.
- Any restraining straps of a child restraint should always be secured to designated anchorage points. Do not secure restraining straps to seat rails, handles or other parts of the interior.
- When installing an adjustable, rearward-facing child restraint, adjust the child restraint according to the child's age. Older children should be seated in a more upright position than younger ones.
- When installing a forward-facing child restraint, make sure you adjust the headrest of the seat to the child's height. Even if the child restraint includes a head support, it might not have been built to withstand the forces involved in a collision.

Seatbelt use

- When installing a child restraint secured using the car's seatbelt or when the car's seatbelt is used to secure a child, ensure that brackets or other parts of the restraint do not come into contact with the seatbelt buckle button.

Tip

Buckling the seatbelt

It can be difficult to buckle a child sitting in a child restraint due to the narrow spaces involved. To make it easier, push the belt buckle forwards slightly. This will give you a better angle to work with. You can also temporarily move the seat next to the child restraint to get more space.

Warning

Follow the instructions

Take extra care to read all information about child safety in this manual and follow the instructions from the manufacturer of your child restraint. If you do not, the child could sustain serious injury in the event of an accident.

Important

Follow the general recommendations for any child restraint anchorage points used to install a child restraint.

1. Follow the instructions from the manufacturer to install the child restraint.

Note

Installation questions

If you have installation questions, contact the manufacturer of the child restraint for more detailed instructions.

Protecting the car interior

During installation, be careful to avoid damage to the car interior caused by protruding parts or sharp edges of the child restraint.

- If the child restraint uses lower tether straps, never adjust the position of the seats after the straps have been secured to the lower tether anchorage points. Always remember to remove the straps when the child restraint is not installed.
- Fasten loose parts of child restraints, such as restraining straps, according to the manufacturer's instructions.

 **Important**

General safety recommendations

When applicable, follow the general safety recommendations regarding seatbelt use, headrest adjustment and proper seating. Make sure you read these sections of the manual before installing a child restraint.

Local regulations

Regulations on where and how children should be seated and secured differ between regions. Make sure that you know what applies to the region you are in.

 **Tip**

Seatbelt reminder

The seatbelt reminder may appear for a seat if a child restraint has been installed without using the car's seatbelt. You can dismiss the reminder in the driver display, but other warning indicators will remain active. Buckle the seatbelt to remove them.

^[1] An exception can be made if a child restraint is also installed on the seat behind it. In this case, try to adjust the seat to accommodate both child restraints.

5.6.1.1.3. Installing child restraints on the third row seats

To securely install a child restraint on either of the third row seats, there is important information to read and recommendations to follow.

There are no anchorage points available for installing a child restraint on the third row seats.

 **Tip**

Long-term use of a child restraint may cause wear and tear on the car interior. Use a kick guard accessory to protect the car interior.

Allowed child restraints

- Only use child restraints that are recommended by Volvo, universally approved or are vehicle specific approved where the car is included in the manufacturer's vehicle list.
- Child restraints that use support legs are not allowed on the third row.
- Any restraining straps of a child restraint should always be secured to designated anchorage points. Do not secure restraining straps to seat rails, handles or other parts of the interior. There are no lower tether anchorage points at floor level for the third row seats.

Seat preparations

- Remove cushion extenders, leg supports and other accessories from the seat before installing a child restraint. If you use a kick guard accessory, this can remain on the seat.
- When installing an adjustable, rearward-facing child restraint, adjust the child restraint according to the child's age. Older children should be seated in a more upright position than younger ones.
- To make space in the third row, move the second row seats forward. Fold the outer and centre second row seats to get access to the third row. Then install the child restraint while sitting next to it.
- Always leave the second row backrests in their most upright position when there is a child restraint installed behind them.

Seatbelt use

- When installing a child restraint secured using the car's seatbelt or when the car's seatbelt is used to secure a child, ensure that brackets or other parts of the restraint do not come into contact with the seatbelt buckle button.

Warning

Follow the instructions

Take extra care to read all information about child safety in this manual and follow the instructions from the manufacturer of your child restraint. If you do not, the child could sustain serious injury in the event of an accident.

Important

Follow the general recommendations for any child restraint anchorage points used to install a child restraint.

1. Follow the instructions from the manufacturer to install the child restraint.

Note

Installation questions

If you have installation questions, contact the manufacturer of the child restraint for more detailed instructions.

Protecting the car interior

Be careful during installation to avoid damage to the car interior caused by protruding parts or sharp edges of the child restraint.

- Fasten loose parts of child restraints, such as restraining straps, according to the manufacturer's instructions.

 **Important**

Raised headrest

The headrest must always be raised when a child restraint is installed.

General safety recommendations

When applicable, follow the general safety recommendations regarding seatbelt use, headrest adjustment and proper seating. Make sure you read these sections of the manual before installing a child restraint.

Local regulations

Regulations on where and how children should be seated and secured differ between regions. Make sure that you know what applies to the region you are in.

 **Tip**

Seatbelt reminder

The seatbelt reminder may appear for a seat if a child restraint has been installed without using the car's seatbelt. You can dismiss the reminder in the driver display, but other warning indicators will remain active. Buckle the seatbelt to remove them.

5.6.1.1.4. Installing child restraints on the front passenger seat

To securely install a child restraint on the front passenger seat, there is important information to read and recommendations to follow.

Accessory ISOFIX anchorage points^[1] and lower tether anchorage points^[1] can be used when installing a child restraint on the front passenger seat.

 **Tip**

Long-term use of a child restraint may cause wear and tear on the car interior. Use a kick guard accessory to protect the car interior.

Allowed child restraints

- Only use child restraints that are recommended by Volvo, universally approved or are vehicle specific approved where the car is included in the manufacturer's vehicle list.

Seat preparations

- Retract the seat cushion extension and remove cushion extenders, leg supports and other accessories from the seat before installing a child restraint. If you use a kick guard accessory, this can remain on the seat.

The content of this manual represents the status of the user manual at the time of printing and may not be completely valid in future instances. For more information, refer to the first page for the complete disclaimer note.

- Any support legs of a child restraint should always be fitted directly to the floor. Do not fit support legs to any raised or uneven floor surfaces, footrests or other objects. Adjust the seat position if needed.
- Loose objects should not be stored around any support legs of a child restraint.
- Any restraining straps of a child restraint should always be secured to designated anchorage points. Do not secure restraining straps to seat rails, handles or other parts of the interior.
- When installing a child restraint using the lower tether anchorage points, never adjust the seat position to tighten the straps.
- When installing rearward-facing child restraints, adjust the seat to its lowest position to start with. The child restraint should stay flat against the seat without gaps. If the child restraint uses a support leg, raise the seat as needed to secure it against the floor.
- When installing adjustable, rearward-facing child restraints, adjust the child restraint according to the child's age. Older children should be seated in a more upright position than younger ones.

Seatbelt use

- When installing a child restraint secured using the car's seatbelt or when the car's seatbelt is used to secure a child, ensure that brackets or other parts of the restraint do not come into contact with the seatbelt buckle button.
- When securing a child with the car's seatbelt, always start with the seatbelt's upper anchorage point adjusted to its highest level. Then lower it as needed to properly position the belt against the shoulder.



Tip

Buckling the seatbelt

It can be difficult to buckle a child sitting in a child restraint due to the narrow spaces involved. To make it easier, push the belt buckle forwards slightly. This will give you a better angle to work with.



Warning

Passenger airbag status

- When installing rearward-facing child restraints, always check that the passenger airbag is disabled.
- When installing forward-facing child restraints, always check that the passenger airbag is enabled.

Failure to follow these instructions can endanger life or lead to serious injury.

Follow the instructions

Take extra care to read all information about child safety in this manual and follow the instructions from the manufacturer of your child restraint. If you do not, the child could sustain serious injury in the event of an accident.



Important

Follow the general recommendations for any child restraint anchorage points used to install a child restraint.

1. Follow the instructions from the manufacturer to install the child restraint.

 **Note**

Installation questions

If you have installation questions, contact the manufacturer of the child restraint for more detailed instructions.

Protecting the car interior

During installation, be careful to avoid damage to the car interior caused by protruding parts or sharp edges of the child restraint.

- If the child restraint uses lower tether straps, never adjust the position of the seat after the straps have been secured to the lower tether anchorage points. Always remember to remove the straps when the child restraint is not installed.
- Fasten loose parts of child restraints, such as restraining straps, according to the manufacturer's instructions.

 **Important**

General safety recommendations

When applicable, follow the general safety recommendations regarding seatbelt use, headrest adjustment and proper seating.

Local regulations

Regulations on where and how children should be seated and secured differ between regions. Make sure that you know what applies to the region you are in.

 **Tip**

Seatbelt reminder

The seatbelt reminder may appear for a seat if a child restraint has been installed without using the car's seatbelt. You can dismiss the reminder in the driver display, but other warning indicators will remain active. Buckle the seatbelt to remove them.

^[1] Availability may vary between regions.

5.6.1.2. Child restraint anchorage points

Your car has different types of anchorage points. Be sure to use the correct anchorage points for your specific child restraint.

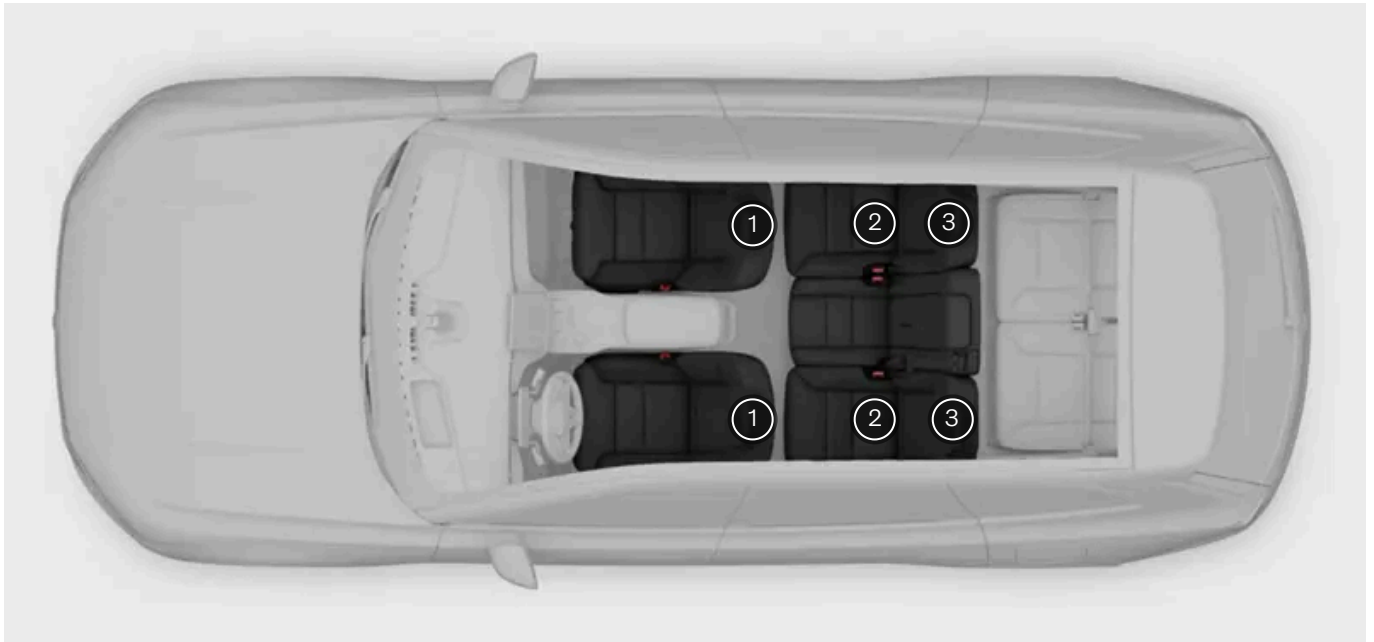

- ① Lower tether anchorage points on the floor rails of the front seats^[1]
- ② ISOFIX anchorage points between the backrests and seat cushions of the second row seats^[2]
- ③ Top tether anchorage points on the backs of the outer second row seats

Your car's various anchorage points can be used in combination with each other or along with other fastening methods to secure different types of child restraints.

The i-Size child restraint standard uses ISOFIX in combination with the top tether anchorage points or a support leg. This standard ensures that any i-Size child restraint can be used on a seat designated as i-Size approved.

Some child restraints are secured using a car seatbelt, usually in combination with other fastening methods.

i Note

Manufacturer's instructions

When using anchorage points, always follow the instructions from the manufacturer of the child restraint.

- ^[1] With the front lower tether accessory, anchorage points are also located on the sides of the front passenger seat footwell.
- ^[2] With the ISOFIX console accessory, ISOFIX anchorage points are also located between the front passenger seat's backrest and the seat cushion.

5.6.1.2.1. ISOFIX anchorage points

Your car is equipped with ISOFIX anchorage points that can be used to secure child restraints on some of the rear seats. If your car is equipped with the ISOFIX console accessory^[1], those anchorage points can be used to secure child restraints on the front passenger seat as well.

The ISOFIX anchorage points can be used in combination with other fastening methods to secure i-Size and ISOFIX child restraints. These anchorage points are part of an international standard for child restraints.

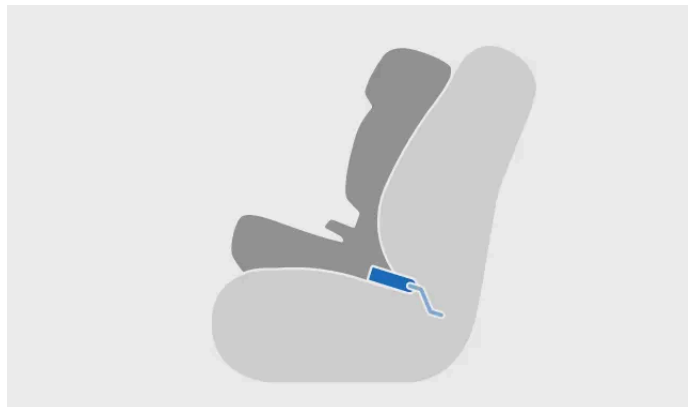

Child restraint installed using ISOFIX



Attaching to ISOFIX anchorage point

Child restraints installed on any of the outer second row seats can use these anchorage points.

Additionally, child restraints installed on the front passenger seat can use these anchorage points if your car is equipped with the ISOFIX console accessory.^[1]

Note

ISOFIX is an international standard for child restraint anchorage points. It is also known by other regional names such as LATCH and LUAS.

Anchorage point locations for the rear seats

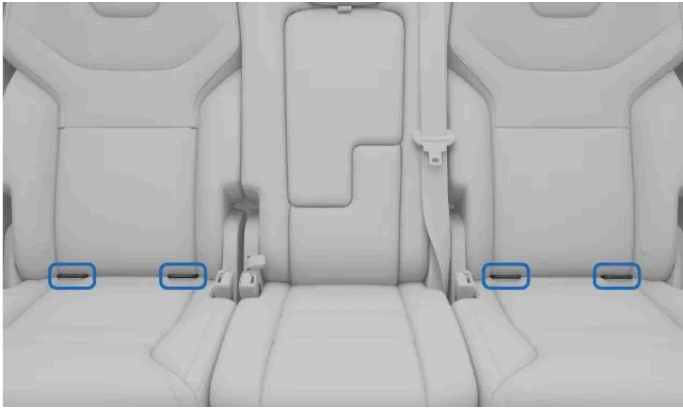

Locations of ISOFIX anchorage points for the second row seats

The ISOFIX anchorage points are located between the seat's backrest and the seat cushion. You may need to push down on the seat cushion to fully access them.

The anchorage point locations marked with the i-Size symbol are approved for i-Size child restraints.



Anchorage points for the front seat

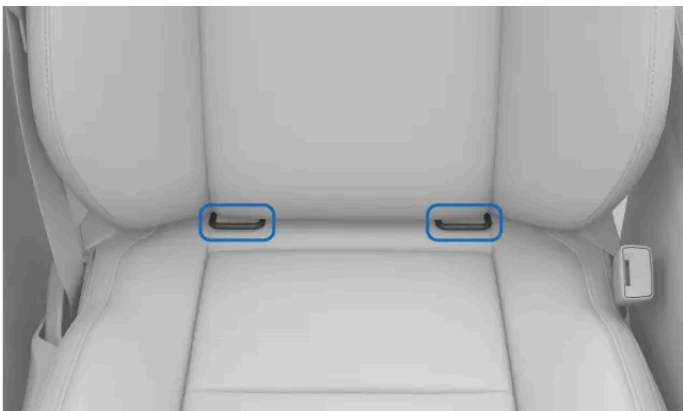

Locations of ISOFIX anchorage points for the front passenger seat

With the ISOFIX console accessory^[1], the anchorage points for the front passenger seat are located between the seat's backrest and the seat cushion.

Note

Manufacturer's instructions

When using anchorage points, always follow the instructions from the manufacturer of the child restraint.

^[1] Availability may vary between regions.

5.6.1.2.2. Top tether anchorage points

Your car is equipped with top tether anchorage points that can be used to secure child restraints on a rear seat.

Anchorage point locations for the rear seats

The top tether anchorage points are located on the back of the backrests.



The top tether anchorage point locations for the rear seats are indicated by the top tether symbol.



The top tether anchorage points can be used in combination with other fastening methods to secure different types of child restraints.

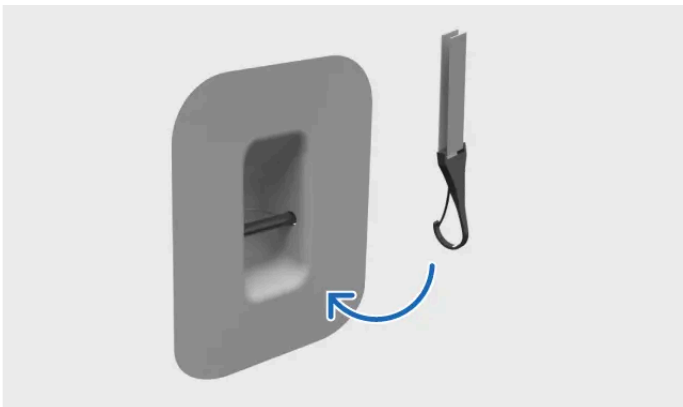

Fastening tether to top tether anchorage point

Child restraints installed on any of the outer second row seats can use these anchorage points.

 **Important**

Manufacturer's instructions

When using anchorage points, always follow the instructions from the manufacturer of the child restraint. Unless otherwise instructed, the top tether straps should be routed around the sides of the headrest support. If there is only one strap, route it around the side closest to the seatbelt retractor.

Load cover

If the load cover is installed behind the rear seats, the narrow gap between backrest and load cover can make it difficult to attach the top tether strap. If necessary, remove the load cover temporarily to make the installation easier. Always make sure the load cover is not in contact with the top tether strap.

5.6.1.2.3. Lower tether anchorage points

Your car is equipped with lower tether anchorage points that can be used to secure child restraints on a second row seat.

With the front lower tether accessory, anchorage points are also located on the sides of the front passenger seat footwell.

Anchorage points for the rear seats

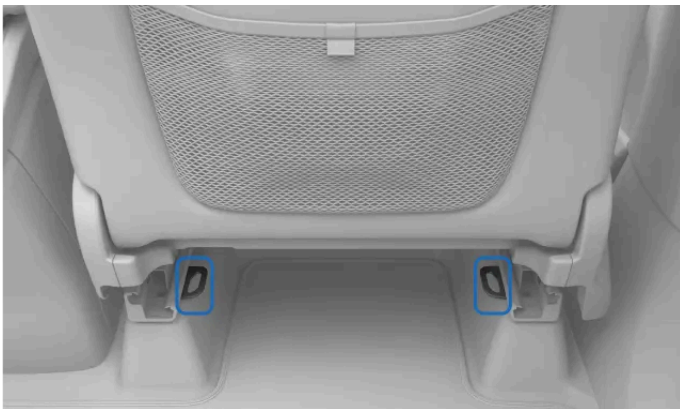

The lower tether anchorage points can be found at the back of the floor rails of the front seats.

Anchorage points for the front seat

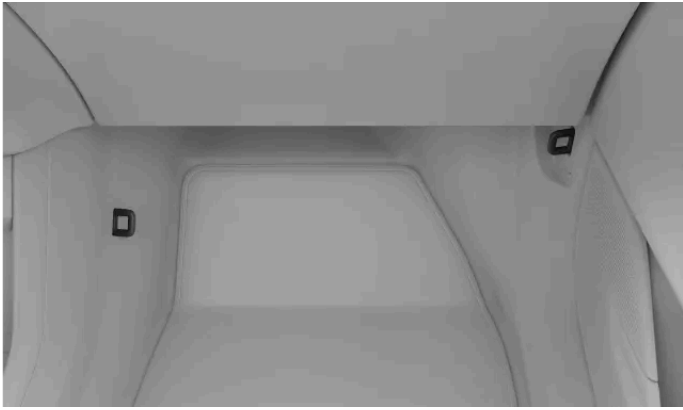

With the front lower tether accessory ^[1], the anchorage points for the front passenger seat are located on the sides of the seat's footwell.

The lower tether anchorage points can mainly be used in combination with the car's seatbelt to secure certain rearward-facing child restraints.

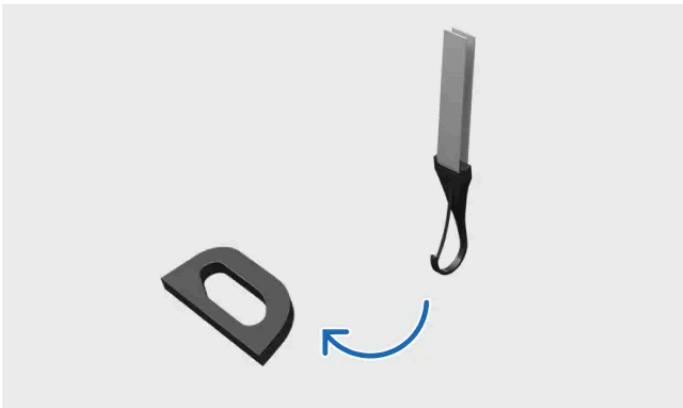

Fastening tether to lower tether anchorage point

Child restraints installed on any second row seat can use these anchorage points.

Additionally, child restraints installed on the front passenger seat can use these anchorage points if your car is equipped with the front lower tether accessory.

Tip

Shared anchorage point

It is possible to attach two lower tether straps from different child restraints to the single lower tether anchorage point closest to the centre of the car, such as when installing two rearward-facing child restraints next to each other.

Attaching the hook

Sometimes the narrow spaces can make it difficult to attach the tether hook to the anchorage point. Try to flip the hook over and attach it from another angle.

Note

Manufacturer's instructions

When using anchorage points, always follow the instructions from the manufacturer of the child restraint.

^[1] Availability may vary between regions.

5.6.1.3. Integrated child seat

Your car has an integrated child seat on the centre rear seat. This can be folded up or down to allow children to sit safely and comfortably.



The child seat is specifically designed with a child's safety needs in mind.

Before you drive with a child in the integrated child seat, make sure:

- that the child seat is safely locked into place.
- that the headrest is adjusted to the child's height.
- you've read and follow all the information about safety in this manual, especially the sections about child safety, proper seating and seatbelt use.

The integrated child seat is approved for children who weigh up to 36 kg and who are 106-145 cm in height. The child seat is not recommended for children less than 4 years old.

 **Warning**

Do not modify or repair yourself

Volvo recommends that repair or replacement of the integrated child seat is only performed by an authorised Volvo workshop. Do not make any modifications or additions to the child seat. If an integrated child seat has been subjected to a heavy load, e.g. in connection with a collision, then the seat cushion, seatbelt, backrest, or possibly the whole seat, must be replaced. Even if the child seat appears to be undamaged, it may not provide the same level of protection. This also applies if the child seat was in lowered position during a collision or similar. The child seat must also be replaced if it is heavily worn.

Follow the instructions

Take extra care to follow the instructions for the integrated child seat. If you do not, the child could sustain serious injury in the event of an accident.

 **Important**

Local regulations

Regulations on where and how children should be seated and secured differ between regions. Make sure that you know what applies to the region you are in.

 **Note**

The integrated child seat is approved according to regulation UN R129/03 as a specific vehicle booster seat.

5.6.1.3.1. Folding up the integrated child seat

The integrated child seat is part of the centre rear seat cushion and needs to be folded up before use.

1.



Pull the handle on the front of the centre seat cushion to release the lock.

- > The child seat releases with the rear end slightly angled upwards.

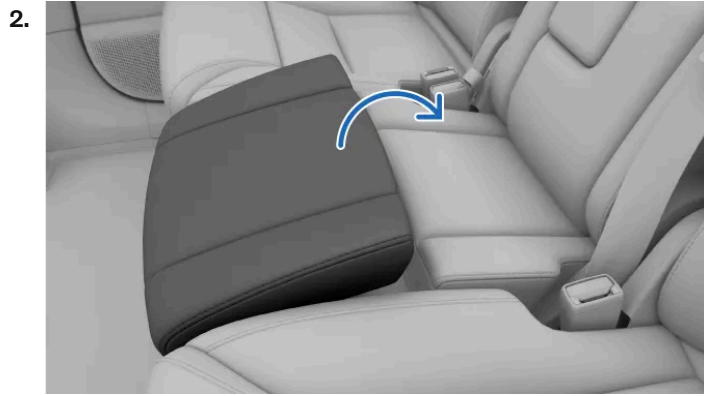

Using one hand on the front of the child seat and one on the rear, guide the child seat upwards and back all the way to the backrest of the seat.



Push down on the child seat until you hear a click.

- > The child seat locks into place.

 **Warning**

Take extra care to follow the instructions for the child seat. If you do not, it could lead to serious injury otherwise avoided in the event of a collision.

5.6.1.3.2. Folding down the integrated child seat

When the integrated child seat isn't in use, you can fold it down to allow for an adult passenger to sit in the seat.

Before you fold down the child seat, make sure there are no loose items left in the space in front of it. These could block the child seat from locking into the seat.



Pull the handle on the front of the child seat to release the lock.

> The child seat releases and moves forwards.

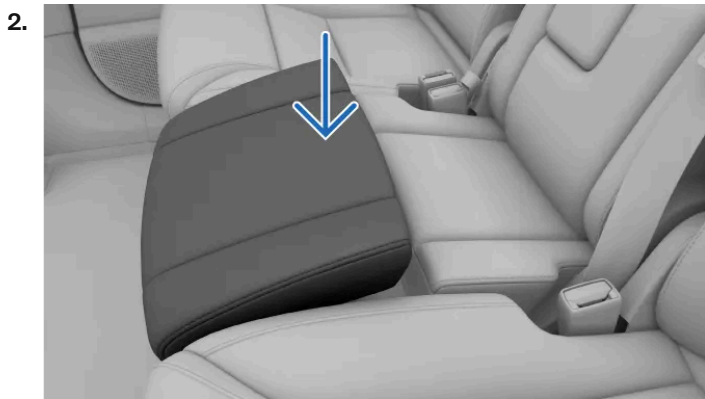

Push the child seat down until you hear a click.

> The seat locks into place.

5.6.1.4. Recommended child restraints

Only use child restraints that are recommended by Volvo, i-Size approved, universally approved or are vehicle specific approved where the car is included in the manufacturer's vehicle list.

Child restraint ^[1]	Installation type	Child size (ECE R129)
Maxi-Cosi Pearl 360 + FamilyFix 360 Base ^[2]	Rearward-facing	40–105 cm (max 17.5 kg)
Volvo Easy access ^[3]	Rearward-facing	40–105 cm (max 18 kg)
Volvo rear-facing child seat ^[4]	Rearward-facing	61–115 cm (max 25 kg)
Volvo booster seat ^[5]	Forward-facing	105–150 cm (max 36 kg)
Volvo booster cushion ^[5]	Forward-facing	138–150 cm (max 36 kg)

[1] Availability of listed child restraints may vary by region.

[2] Approval No: 030062

[3] Approval number: E1-010016

[4] Approval number: E11 129R03/08 0599 00

[5] Approval number: E1 129R03/09 0061 07

5.6.1.5. Overview table of suitable locations for child restraints

The following table provides an overview of the types of child restraints suitable for installation on each seat.



Seat position ^[1]	1	2 (with disabled airbag, only rearward-facing child restraints)	2 (with enabled airbag, only forward-facing child restraints)	3	4	5	6	7
i-Size child restraint systems	No	No	No	Yes	No	Yes	No	No
Universally approved child restraint systems secured using the car's seatbelt	No	Yes	Yes	Yes	Yes	Yes	Yes	Yes
Other child restraint system categories ^[2]	No	Yes	Yes	Yes	Yes	Yes	No	No

 **Warning**

- When forward-facing child restraints are installed on the front passenger seat (seat position 2), the passenger airbag must be enabled.
- When rearward-facing child restraints are installed on the front passenger seat (seat position 2), the passenger airbag must be disabled.

Failure to follow these instructions can endanger life or lead to serious injury.

 **Important**

Local regulations

Regulations on where and how children should be seated and secured differ between regions. Make sure that you know what applies to the region you are in.

[1] According to illustration.

[2] For more information, contact the manufacturer of the child restraint system.

6. Entry and security

Learn about the various features associated with entering and exiting the car, including how the keys and alarm work.



This section of the manual covers the different types of keys, opening and closing the doors, locking and unlocking, and the alarm.

Learn more about the different types of keys and how you can customise the way your car reacts when you lock, unlock, approach or leave it.

6.1. Keys

Your car supports several types of keys. Some keys can be sensed by the car as you approach or leave it, whereas key cards need to be placed on the driver's door handle.

Key types

! Important

Using keys is fairly straightforward, but you should be aware of the limitations of each key type for safety and security reasons. It's important to read all of the information in this manual about keys and how to use them.

Car and key wireless technologies may cause disturbances in other devices. You can find more information about these systems in the specifications section of this manual.

For safety and security reasons, never leave unattended keys in an exposed place.

The car supports the following types of keys:

The content of this manual represents the status of the user manual at the time of printing and may not be completely valid in future instances. For more information, refer to the first page for the complete disclaimer note.

- Digital key
- Key card
- Key tag

Digital keys and charged key tags are distance-capable, meaning your car can detect them when you approach or leave it. This allows for automatic locking and unlocking.

Keys without power, such as a key card or a distance-capable key with a flat battery, use NFC^[1]. This means they can only be read at specific key reading locations.

Note

Ordering new or additional keys

Your car comes with a limited number of keys. Contact Volvo support if you lose a key or simply require additional keys.

Digital key availability

The digital key for your car is currently available for certain Apple iPhone, Samsung Galaxy and Google Pixel models. Check with your device manufacturer if you're unsure about the compatibility of your device. Many manufacturers have information about compatibility and UWB capability on their website.

Tip

Key card as backup access

It's a good idea to keep a key card to hand in case a device with a digital key is lost or stolen. It can also be helpful if you need to give a service technician or roadside assistance access to your car but don't want to share your digital key.

Key reading locations

There are two ways that your car can detect your key and use it to lock or unlock:

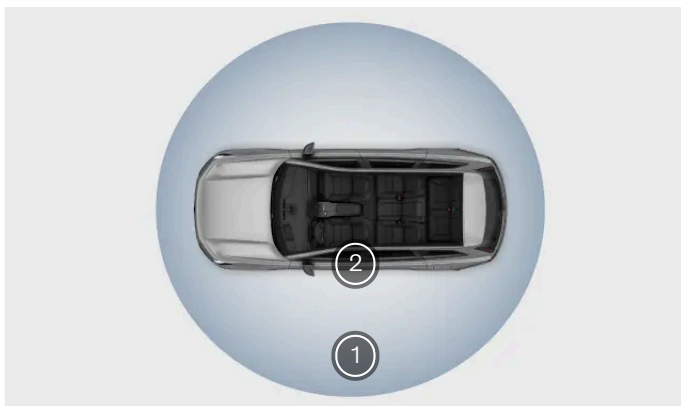

- 1 Distance-capable keys can lock or unlock the car from a distance.
- 2 Key cards lock or unlock the car when held against the key reader in the driver's door handle.

There is also a key reader between the front seats where you can place a key card or a discharged distance-capable key to start the car. The key reader is located in the same place as the wireless charger.

 **Note**

Unresponsive car

If your car doesn't respond when you approach it with your distance-capable key, try unlocking it by pulling the door handle. You can also place any of your keys on the door handle to unlock the car.

Some reasons your car doesn't respond as usual include:

- The car has been turned off for several days and needs time to turn its systems back on, to recognise the key and to give you access.
- The key's wireless signals are being blocked.
- You're using a key tag that has a low battery or has entered battery saving mode.

If the car's batteries go completely flat, it will not respond to any key.

User profiles and keys

You can assign keys to a user profile. This allows the car to automatically identify who's unlocking it and apply all of their customisations. You can read more about which customisation options are available in a separate section of this manual.

Locking keys in

If you lock the car while a distance-capable key is still inside, that key will be temporarily deactivated. You can still use one of your other keys on the door handle to enter the car.

 **Warning**

If you leave a person in the car, ensure that you do not leave a key in the car. This is especially important around children.

Improper use of car opening and starting systems can result in serious personal injury. Always take your keys with you when you leave the car, including the digital key and key tag. The car can be started and systems, such as the power windows can be operated, leading to serious personal injury. Never leave children, disabled persons or anyone who cannot help themselves in the car. The doors can be locked using a distance-capable key or by touching the capacitive lock sensor area of the door handle. This could result in people being trapped in the car in an emergency. For example, depending on the time of year, people trapped in the car can be exposed to very high or low temperatures. Never remove the key while the car is moving or while it is rolling to a stop.

 **Important**

The outer door handle contains electronic components. Protect these from rough handling. Never leave any car keys inside the car, including digital and distance-capable keys. Entry by unauthorised persons could harm the car or your car could be stolen. Always take the keys with you whenever you leave your car.

^[1] Near Field Communication

6.1.1. Key tag

You can use your key tag to lock, unlock and drive the car.



The key tag works at a distance to lock, unlock and start the car, but it can also be used in the same way as a key card.

To use it like a key card, place it on the driver's door handle with the logo facing towards you.

Charging the key tag

Use the wireless charger between the front seats or an external wireless charger^[1] to recharge the tag.

Battery level

You can see the battery status of any connected key tag in the car status view.

! Important

- If the tag is left with a flat battery for too long, you won't be able to recharge it. If the battery is completely flat and does not respond to being recharged, you can buy a new one. Contact an authorised Volvo workshop for more information.
- If the car does not detect your key tag while you are in the car, then the car won't lock when you leave. To update the key detection status, place the key on the key reader.

i Note

- To maintain optimal battery health, avoid leaving the battery fully discharged for long periods.
- If your key tag stops working at a distance, it may be due to a low battery. Be aware that the signals between the key and the car can also be affected by obstacles or interference from other signals.
- Remember that even if the key tag has a flat battery, it can still be used as a key card.

 **Warning**

The key tag includes a non-replaceable battery which can be extremely hazardous. Keep batteries out of reach of children. If you suspect a battery has been ingested or in any way inserted into the body, seek immediate medical attention. Battery fluid is also hazardous and physical contact with it should be avoided.

^[1] Qi compatible

6.1.1.1. Charging the key tag

Keep the key tag charged for optimal functionality.

Battery level

You can see the battery status of any connected key tag in the car status view.

Tag battery indicators



Key tag battery is critically low.



Key tag low battery status^[1].



Key tag is charging.



Key tag battery is fully charged.



The car does not detect the key tag. This could indicate that the battery is completely flat.

 **Warning**

The car's use of Bluetooth, UWB^[2] and NFC signals may cause disturbances in other devices at certain distances.

 **Important**

Do not place cards with NFC, such as key cards or electronic payment cards, between the wireless charger and the device when using the charging function. This could damage them.

Keep sensitive devices away from the car's sensors so that neither suffer interference nor damage.

Before charging the key tag, make sure there are no other objects on the charger.

1. Make sure the wireless charger is turned on. You do this via the centre display.
2. Place the tag on the centre of the wireless charger with the logo facing upwards.



Wireless charger

- The key tag starts charging.
While charging, the tag works like a key card.

i Tip

You can also use a Qi charger to recharge the tag.

! Important

To maintain optimal battery health, don't leave the battery fully discharged for long periods.

If the tag is left with a flat battery for too long, you won't be able to recharge it. If the battery is completely flat and does not respond to being recharged, you can buy a new one. Contact an authorised Volvo workshop for more information.

i Note

The key reader and wireless charger are located in the same place. This means that if you have any type of car key on the key reader, you have to remove it to be able to wirelessly charge a phone.

If the tag is too hot or too cold it will not charge correctly.

The car will not respond to any key if the car battery is completely flat.

Remember that even if the key tag has a flat battery, it can still be used as a key card.

^[1] The key tag won't be distance-capable until it has been recharged, but it can still be used as a key card.

^[2] Ultra-wideband

6.1.2. Key card

The content of this manual represents the status of the user manual at the time of printing and may not be completely valid in future instances. For more information, refer to the first page for the complete disclaimer note.

Your key cards can lock and unlock the car, and allow you driving access.

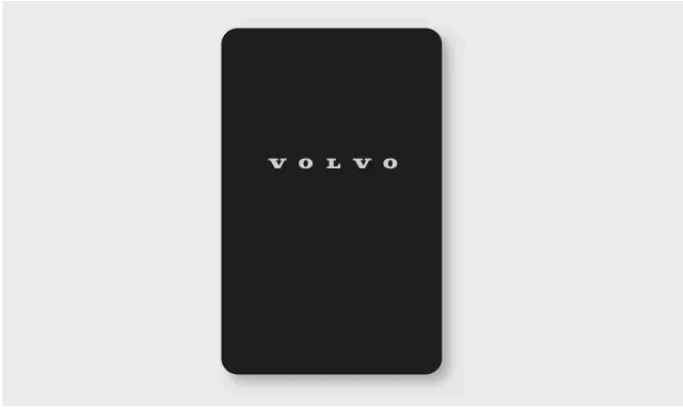

You can lock and unlock the car by placing the key card on the driver's door handle.

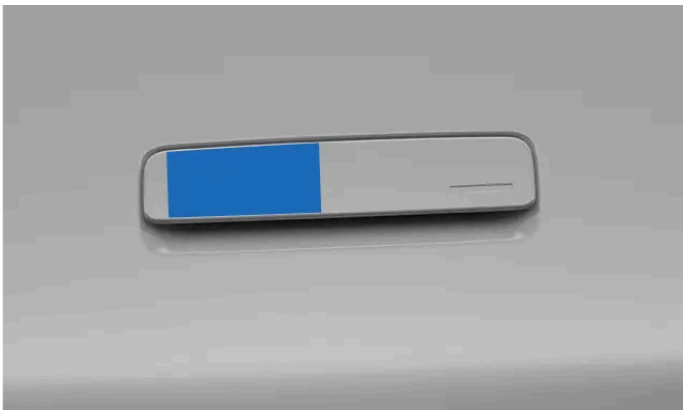

Key reading location on the driver's door handle

The key card starts the car when placed on the key reader located between the two front seats. When you start using the pedals, you can remove the card from the key reader.

If the car is stationary without a card on the key reader for a while, you will need to put the card back on the reader for the car to reactivate driving mode.

 **Warning**

The car's use of Bluetooth, UWB^[1] and NFC^[2] signals may cause disturbances in other devices at certain distances.

 **Important**

Do not place cards with NFC, such as key cards or electronic payment cards, between the wireless charger and the device when using the charging function. This could damage them.

 **Note**

The key reader and wireless charger are located in the same place. This means that if you have any type of car key on the key reader, you have to remove it to be able to wirelessly charge a phone.

i Tip

Key card as backup access

If your car is unresponsive when you try to unlock it with a distance-capable key, try unlocking the driver door with your key card. The key card is designed specifically to also act as a backup in this kind of situation. You will be able to get to any belongings inside even if the other doors don't work. If your car is unresponsive, contact Volvo support.

Keep in mind that if the car battery is flat, you won't be able to open the doors.

[1] Ultra-wideband

[2] Near Field Communication

6.1.3. Digital key

The digital key allows you to lock, unlock and start your car using a compatible phone or smart watch.

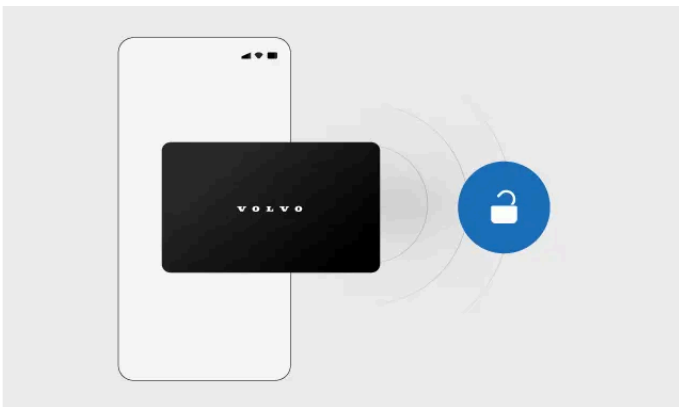

Once you've set up a digital key on your device, it works in the same way as your other keys. If your device has UWB^[1] capability, your car will be able to detect the digital key from a distance. If your device doesn't have UWB capability, the digital key works as a key card.

The car's owner can create one primary digital key. Once the primary key has been created, you can share digital keys with family and friends.

i Note

Compatible devices

The digital key for your car is currently available for certain Apple iPhone, Samsung Galaxy and Google Pixel models. Check with your device manufacturer if you're unsure about the compatibility of your device. Many manufacturers have information about compatibility and UWB capability on their website.

Using the digital key on a device with UWB

When you set up a digital key on a device with UWB capability, you can lock or unlock the car by:

- using the approach and leave feature for automatic unlocking and locking
- touching the underside of the door handle
- using your device as a key card
- using the lock and unlock button in your device's wallet app.

To get driving access, you just need to bring your device with you inside the car or place it on the key reader between the front seats. The key reader is located in the same place as the wireless charger.



Tip

Disable passive entry in wallet app

Many wallet apps have a setting that lets you disable passive entry. When this feature is disabled, your car won't unlock automatically when you get close to it while carrying a digital key. The approach unlock feature will still be available when you use your other distance-capable keys.

Using the digital key on a device without UWB

If your device doesn't have UWB capability, your digital key works as a key card. To unlock the car, open your key in the wallet app and place the device on the right-hand side of the driver's door handle. To start the car, put the device on the key reader between the front seats.

Sharing the digital key

Once you've set up a primary digital key, you can share it with family and friends. Open the digital key in your phone's wallet app to find the sharing option.



Note

The option to share your digital key may not be available in all wallet views. Make sure to open the wallet app via the app icon.



Tip

No battery

You may still be able to use your digital key as a key card even if your device has run out of battery. Contact the device's manufacturer for more information.

^[1] Ultra-wideband

6.1.3.1. Creating a digital key

The content of this manual represents the status of the user manual at the time of printing and may not be completely valid in future instances. For more information, refer to the first page for the complete disclaimer note.

The car's owner can create a primary digital key at any time via settings.

The car's owner can create a primary digital key in the setup guide. This digital key can then be shared with family and friends. You can access the guide via your car's centre display, the Volvo Cars app or the activation email you received when you created your Volvo ID.

 **Note**

Compatible devices

The digital key for your car is currently available for certain Apple iPhone, Samsung Galaxy and Google Pixel models. Check with your device manufacturer if you're unsure about the compatibility of your device. Many manufacturers have information about compatibility and UWB capability on their website.

Creating a digital key via the centre display

You need to be inside the car while setting up your digital key. You also need to make sure that:

- the car is stationary and unlocked
- you are signed in to the car's owner profile in the centre display
- both your car and your phone have a stable internet connection ^[1]
- both your car and your phone are updated to the latest software version
- Bluetooth is enabled on your phone
- mobile data usage is enabled in the wallet app on your phone
- you have access to the Volvo ID registered to the car's owner profile. ^[2]

1. Press the car symbol  in the bottom bar and go to **Settings**.
2. Go to **Profiles**.
3. Select the owner profile and go to **Car keys** → **Set up digital key**.
4. Scan the QR code in the centre display using your phone and follow the link that appears.
5. Authenticate yourself using your Volvo ID.
 - > The pairing guide appears on your phone.
6. Follow the guide on your phone.
 - > If pairing is successful, your primary digital key appears in your phone's wallet app. You can now share your digital key with family and friends.

Moving the primary digital key to another phone

If you want to move the primary digital key to another device, such as a new phone, you can do so via the centre display. In the owner's profile settings, select your primary digital key and press **Change device** to move the key to the new device.



Tip

Assigning digital keys to a profile

The primary digital key is always assigned to the car's owner profile. If you have shared a digital key with someone, make sure they assign it to their car user profile to ensure that all of their preferred settings are applied when they unlock the car.

- [1] If the car is parked in an underground garage or surrounded by obstacles such as buildings, hills or mountains, the network signal may be blocked or too weak.
- [2] If you're not the car's owner, you can't create your own digital key. You need to ask the owner to share their digital key with you instead.

6.1.3.2. Deleting a digital key

You can delete digital keys at any time, either via the centre display or your phone's wallet app.

Anyone with a digital key can delete and remove it from their phone's wallet app. The car's owner can also remove the primary key or shared keys via their wallet app or the owner's profile in the centre display.



Note

Compatible devices

The digital key for your car is currently available for certain Apple iPhone, Samsung Galaxy and Google Pixel models. Check with your device manufacturer if you're unsure about the compatibility of your device. Many manufacturers have information about compatibility and UWB capability on their website.

Grace period

When the car's owner deletes a shared key through their phone's wallet app, the key will be fully disabled after the shared key's holder finishes their last drive or 48 hours after deletion. If the shared key is deleted via the centre display, the key is instantly disabled.

Removing one or all digital keys via the centre display

If you want to remove all digital keys via the centre display, make sure you are using the car's owner profile.

1. Press the car symbol  in the bottom bar and go to **Settings**.
2. Go to **Profiles**.
3. Select the owner's profile and go to **Car keys** → **Digital keys**.
4. Select the digital key or keys you want to remove.

5. Press **Remove** and authenticate yourself using your Volvo ID.

i Note

Lost device

If a device with a digital key gets lost, it's a good idea to delete the digital key. If you can't do it via the centre display, you can delete it via the Volvo Portal website. Always keep a key card close to hand so that you can still access your car if you lose your device.

6.1.4. Key reading locations

There are some key interaction points where your car can detect your keys to let you lock, unlock or drive.

Interaction points for keys

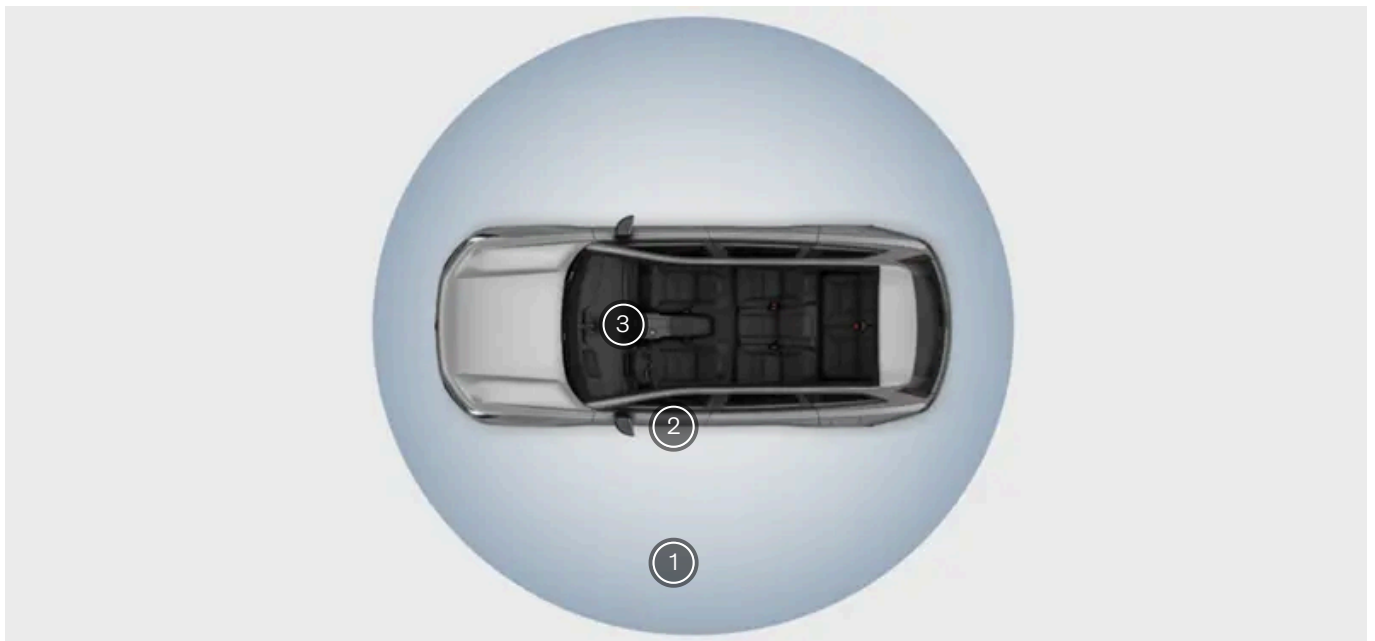

- ① Your distance-capable keys can lock and unlock the car automatically from a short distance away.
- ② Keys that are not distance-capable need to be placed on the driver's door handle to unlock the car.
- ③ Key cards or discharged keys can be placed on the key reader between the front seats to start the car.

Distance-capable keys

Digital keys and charged key tags are distance-capable, meaning your car can detect them when you approach or leave it. This allows for automatic locking and unlocking.

Go to settings to select your preferences and to turn automatic locking and unlocking on or off.

Note

NFC functionality

Your distance-capable keys also have NFC^[1] functionality. This means that even if a distance-capable key has a low or discharged battery, you can still use it as a key card. Therefore, any reference to key card functionality applies to discharged distance-capable keys too.

Exterior key reader

You can lock and unlock the car by placing any type of key on the key reading sensor. It's on the side of the driver's door handle which is closest to the front of the car.

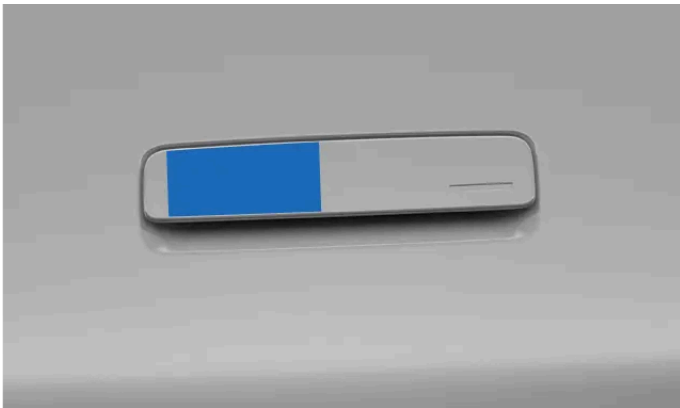

Key reading location on the driver's door handle

Make sure the card or device is laid flat against the reader. If you're using a key tag, the logo should be facing towards you.

Interior key reader

You can place your key card or a discharged key tag on the key reader between the front seats to get driving access.



The key reader between the front seats is also the wireless charger.

Note

The key reader won't work at the same time as the wireless charger.

6.2. Opening and closing

Your car has a few features and situation-specific behaviours you should be aware of when opening and closing the doors.

Opening the doors

The outer door handles stay folded in until you unlock the car.

From inside the car, the doors open using the lever near the window controls.

Tip

Soft close

If you leave the doors in a nearly-closed position, the car will attempt to close them fully.

Important

Emergency open

The doors can always be opened from the inside using the inner door lever unless the child lock is on. This can be useful in an emergency or if your car's battery is flat. To release the door latch mechanically, pull the lever all the way up twice.

Note

In rare cases, frost or ice may prevent the handles folding outwards. If this happens and the car is unlocked, you can still use the handles to open the car.

If ice buildup is preventing you from accessing the door handles, there are some steps you can try:

- Activate preconditioning in the Volvo cars app to heat the car.
- Carefully brush or tap the door handle to remove the ice manually.

Opening the bonnet

The bonnet is opened by using a lever near the driver's seat.

Opening the boot

Open the boot manually using the button on the boot hatch or via the centre display. You can also use the hands-free feature.

Open door warning

The content of this manual represents the status of the user manual at the time of printing and may not be completely valid in future instances. For more information, refer to the first page for the complete disclaimer note.

Regularly check that the bonnet, boot and doors are fully closed.



Open doors are highlighted in red on the car symbol in the bottom right of the driver display. The car will also use warning sounds to indicate improperly closed doors.

For safety reasons, the car will make it harder for you to accelerate from a low speed if the driver door isn't fully closed.

 **Important**

In the interests of safety and security, you should always check that the doors have fully closed even if your car will try to automatically close passenger compartment doors that are slightly open.

6.2.1. Opening the bonnet

Opening the bonnet requires pulling two separate release levers and provides access to the front storage compartment. Be sure to close the bonnet again before driving the car.

Locations of release levers

The lever to open the bonnet can be found below the dashboard on the driver's side, just in front of the door hinge.



The second lever is below the front edge of the bonnet.



1. Pull back the bonnet lever inside the car.

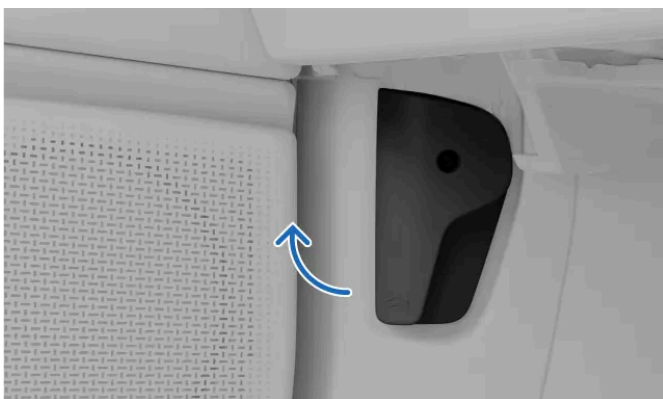

Pulling the interior release lever

- > The bonnet releases from its fully locked position. It opens slightly, which gives you access to the second lever.
2. Pull the lever that's located below the front edge of the bonnet.

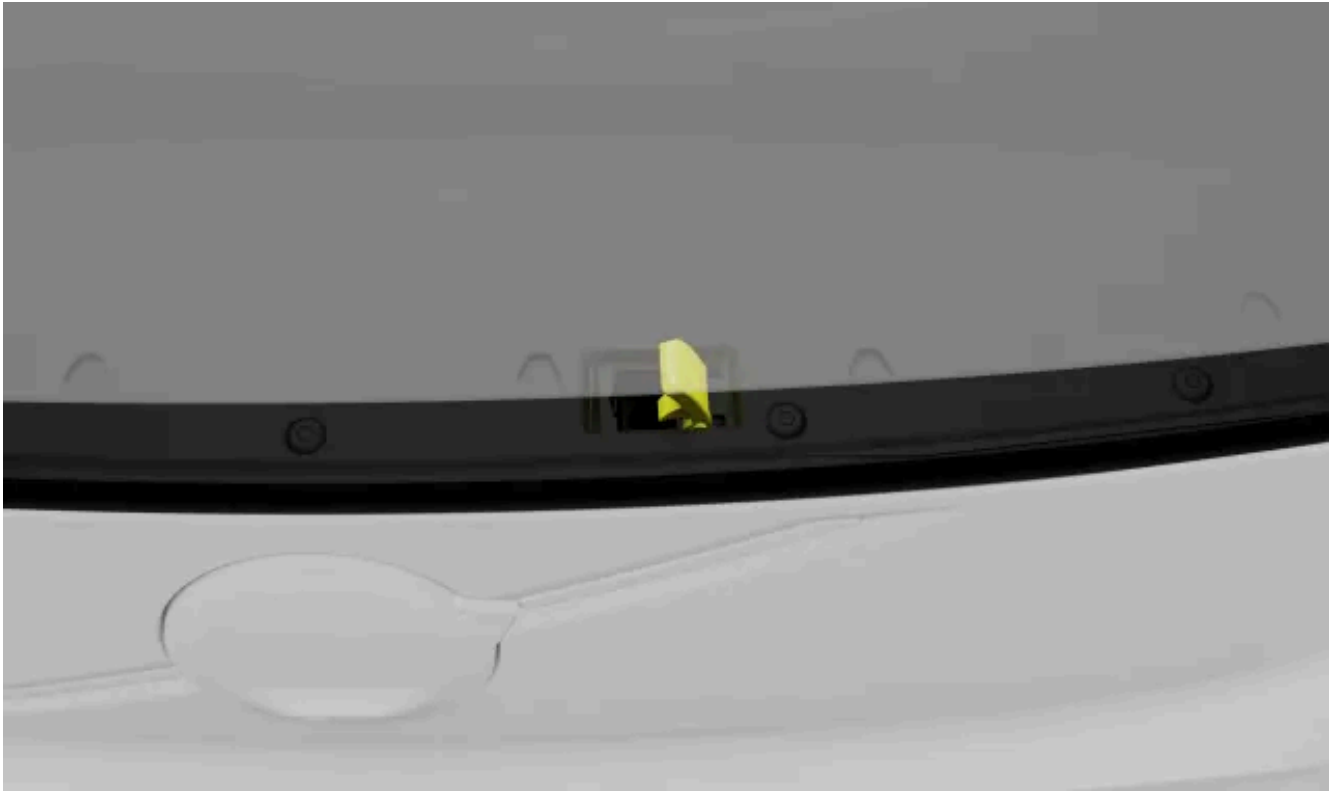

- > The bonnet releases fully.
- 3. Lift the bonnet by its front edge and open it to its fully extended height.
- > The bonnet stays in position.

Note

After closing the bonnet

If you see an open bonnet warning in the driver display, open the bonnet and check for obstructions before closing it again. Contact Volvo support if the notification doesn't go away.

Warning

Do not drive with the bonnet open

Stop the car immediately if there is any indication that the bonnet is not completely closed.

6.2.2. Closing the bonnet

Take extra care to ensure that the bonnet completely closes after being open.

Make sure nothing gets in the way of the bonnet as it closes.

 **Warning**

Pinching and crushing hazard

Keep all hands away from the bonnet's closing path. Take extra caution when children or pets are nearby.

1. From the fully opened position, simply pull the bonnet down by holding the outer edge.
2. Carefully lower the bonnet until it reaches the locking mechanism.



Where to press the bonnet down to close it

Press down with both hands on the sides of the bonnet lid's front edge.

 **Note**

Make sure the bonnet fits into the locks at the same time. Keep the front edge flat as it closes.

You should hear the bonnet lock on both sides.

4. Make sure there are no significant gaps or any indication that the bonnet is not completely closed.

 **Note**

Open bonnet warning

If you see an open bonnet warning in the driver display, open the bonnet and check for obstructions before closing it again. Contact Volvo support if the notification doesn't go away.

 **Warning**

Stop the car immediately if there is any indication that the bonnet is not completely closed.

6.2.3. Boot access

You have several options for accessing the boot hatch. For example, you can open it manually or use the hands-free feature.

Warning

Be aware when the boot is opening or closing. Make sure that no persons are in the vicinity of the boot when it is in motion. Always use the boot access functions with caution. If there is an obstruction when closing the boot, you will hear a beep.

Do not interfere with the boot's support arms, these are highly pressurised and tampering with them can result in serious injury.

After use, check the display for indications that the boot is fully closed.

Note

Pinch protection

The car can detect obstructions to the boot hatch when opening or closing. If the boot hatch tries to close with an obstruction in the way, you will hear a warning sound and the boot will open fully. If pinch protection activates while the boot hatch is opening, the boot hatch will stop moving.

Opening the boot manually

If the car is unlocked, you can simply open the boot using the button above the number plate.

Opening and closing the boot hands-free

If you're carrying a distance-capable key, you can use the hands-free feature. Make a single kicking motion under the rear bumper and the boot will open or close automatically.

Access via the centre display

You can open and close the boot via controls in the centre display. Press and hold the button to complete the boot movement.

Using the boot closing button

Press the boot closing button on the inner right side of the boot hatch to close it.



Location of the boot closing button



You can also use the closing button to adjust how far the boot opens. This is useful if you want the boot hatch to stay within easy reach or if you are somewhere with a low ceiling, such as a garage.

Locking the boot

The boot will automatically lock when you close all of the doors and lock the car as you normally would. You can also press the boot locking button on the inside of the boot hatch or lock and unlock the boot via the Volvo Cars app.



Press the boot locking button when carrying a distance-capable key to close the boot and lock the car. If the boot can't lock for some reason, you will hear three beeps.

Note

Locking with the boot open

If the boot is not properly closed when you lock the car, the alarm won't be fully enabled. In these cases, the alarm will only protect the side doors.

The car also won't detect any motion inside if you've locked it with the boot still open.

Once you close the boot, it will lock and be covered by the alarm.

6.2.3.1. Opening the boot hands-free

If your hands are full and you have your distance-capable key with you, just pass your foot under the rear bumper once to make the boot open automatically.

If your car is locked, using the hands-free feature will unlock and open the boot. You can choose whether only the boot or all of the doors unlock via the locking settings in the centre display.



The sensor picks up movement under the rear bumper. Any detected movements unlock the boot.

Make sure you have a charged distance-capable key on you.

1. Make a single kicking motion under the rear bumper and move back.
- > A short sound response indicates that it's about to open.

Note

Repeated foot movements cancel or reset the activation.

Closing the boot hands-free

You can also use the kicking motion to close the boot hands-free. When the hatch is about to close, you will hear a beeping sound. The hatch will start moving shortly after.

If you try using the hands-free feature without a distance-capable key, three beeps will indicate that the boot cannot close.

If the function appears to be unresponsive, keep in mind that any obstructions to the sensor, such as mud, may interfere with it responding properly.

6.2.3.2. Adjusting boot opening height

You can adjust how much the boot hatch opens.

If the car is often in places with a low ceiling, such as a garage, you may want to reduce the boot opening height. To have more room to access the boot, you can raise the boot opening height.

Once adjusted, the boot hatch will continue to open to the newly set height until changed.

1. Open the boot hatch.
2. Adjust the boot hatch to the desired height using the close button on the inner right side of the boot hatch.



Use the close button marked with the associated symbol.

To lower the boot hatch, move it manually to the preferred height, then press the close button to stop it. If you do not press the close button, the hatch will continue to lower until it closes.

To raise the boot hatch, move it manually to the preferred height.

3. Press and hold the close button for a few seconds to set the new height.
- > A chime sound confirms that the new height is set.

A height adjustment is saved to the profile being used at that time.

6.3. Locking and unlocking

You have several options for locking and unlocking the car, depending on what keys you use and which settings are enabled.

Locking and unlocking from a distance

Your car can unlock and lock automatically when you approach or leave it with a recognised distance-capable key. You can enable or disable this behaviour in settings.

You can use your Volvo cars app to lock or unlock your car. If you have set up a digital key on your device, you can also use the lock and unlock buttons in your device's wallet app.

! Important

It is the driver's responsibility to ensure the car is locked, even when automatic functions are enabled.

Car thieves can use frequency jamming to interfere with key functions and prevent cars from locking. When you leave your car, always check that the driver's door is locked.

i Note

Digital key and distance capability

Make sure you enable Bluetooth on your device for your car to be able to detect it from a distance.

If you're using a digital key on a device that doesn't have UWB^[1] capability, the key isn't distance-capable and can only be used as a key card.

i Tip

Disable passive entry in wallet app

Many wallet apps have a setting that lets you disable passive entry. When this feature is disabled, your car won't unlock automatically when you get close to it while carrying a digital key. The approach unlock feature will still be available when you use your other distance-capable keys.

Using the touch points on the door handles

If you want to lock or unlock your car manually while still using a distance-capable key, you can use the touch points on the door handles.

To unlock the car, touch the underside of the door handle.



Touch point on the underside of the door handle.

To lock the car, place a finger on the small indentation on the door handle.



The indentation marks the touch point where you can place your thumb or fingers to lock your car.

Note

For the touch points to work, you need to keep a recognised distance-capable key where your car can detect it.

To prevent your car from unlocking or locking automatically when you approach or leave it, be sure to disable **Unlock car when approaching** and **Lock car when leaving** in settings.

Using the key reader

You can lock or unlock your car by putting any of your keys on the NFC^[2] reader on the driver's door handle.

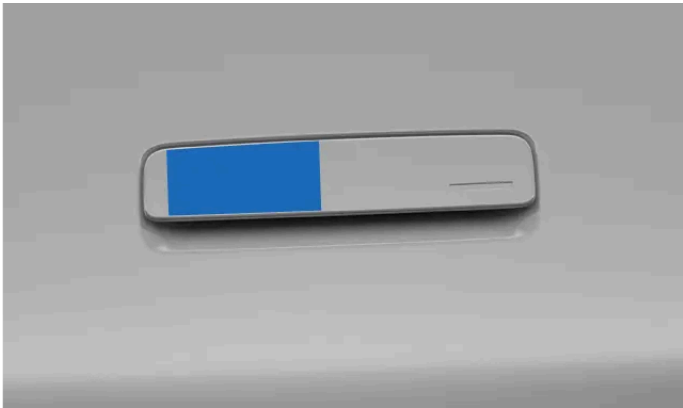

Key reading location on the driver's door handle

Make sure the card or device is laid flat against the reader. If you're using a key tag, the Volvo logo should be facing towards you. If you're using your digital key, open the key in the wallet app before placing your device on the reader.

Using the button panels

Direct controls for the door locks are located on the button panels on the inside of the front doors. The lock and unlock symbols are visible on the buttons.



Double lock

Your car is equipped with a double lock, which means that it locks the doors from the outside and the inside. This is to prevent unauthorised attempts to open the car using the inner door handles.

Double locking is enabled by default. It will be temporarily disabled if you turn occupant locking on.



Warning

Volvo recommends not leaving people or pets in a locked car. The driver is always fully responsible for the well-being and safety of anyone left inside.

Some regions have laws prohibiting people or pets being left inside a locked vehicle.

^[1] Ultra-wideband

^[2] Near Field Communication

6.3.1. Activating child lock

You can activate and deactivate the child lock in settings.



Important

When driving with children in the rear seats, check that the rear doors are secured with an active child lock.

The child lock can increase passenger safety in the rear seats. When the child lock is active, the passengers in the rear seats are unable to open the rear doors or operate the rear windows.

The driver maintains control over the windows, and the car can be opened from the outside if it is unlocked.

Activating the child lock:

1. Press the car symbol  in the bottom bar and go to **Settings**.

2. Go to **Controls** → **Locking**.

3. Press the child lock symbols   to activate the child lock.

> A child lock symbol appears in the driver display to confirm that the lock is on.



Symbol shown in the driver display indicating the child lock is active.

You can deactivate the child lock by following the same steps you took to activate it. To deactivate the child lock, the car needs to be stationary with the driver sitting in the driver's seat.

6.3.2. Settings for locking and unlocking

You can customise how your car reacts when locking or unlocking.

Note

Different settings affect how and when your car is locked. Make sure to familiarise yourself with the different options and how they affect the locking and unlocking behaviours.

Approach and leave locking

You can choose whether your car should automatically unlock when you approach it and lock when you're walking away from it with the **Unlock car when approaching** and **Lock car when leaving** settings. For these features to work, you need to carry a recognised distance-capable key.

General locking behaviour

You can customise many of your car's general locking behaviours. For example, you can turn feedback responses on or off and choose which doors unlock when you use the touch points on the driver's door handle.

It's also possible to set the car to automatically lock while driving for improved occupant safety. Enabling this setting prevents the doors from being accidentally opened when moving at speed. It triggers at a relatively low driving speed.

Occupant locking

Occupant locking is a feature designed for when you want to lock the car from the outside but still have someone inside the car. The occupants will still be able to open the car from the inside and the car's alarm won't be armed. Use this feature responsibly.



Note

Battery consumption

While occupant locking is enabled, some of the car's features remain active and consume power. This can drain the car's battery level faster than normal, even when your car is parked.

Software updates

Your car won't receive any over-the-air software updates while occupant locking is enabled. Keep this in mind if you plan to allow occupant locking for an extended period of time.



Warning

Volvo recommends not leaving people or pets in a locked car. By allowing occupant locking, it will be possible to lock the car when it has detected people or pets inside. Certain car systems can remain active and the car doors can still be opened from within. The driver remains responsible for the well-being and safety of anyone left inside.

6.3.2.1. Adjusting locking and unlocking settings

You can adjust several of your car's locking and unlocking responses and behaviours in settings.



Important

Changing locking and unlocking settings

Enabling or disabling certain features affects how and when your car locks and unlocks. Make sure you familiarise yourself with the different key types as well as the locking and unlocking features. Misunderstanding a feature might lead you to believe that your car is locked when it isn't.

It is the driver's responsibility to ensure the car is locked, even when automatic functions are enabled.

1. Press the car symbol  in the bottom bar and go to **Settings**.
2. Go to **Controls** → **Locking**.
3. Adjust your locking and unlocking settings.



Warning

Volvo recommends not leaving people or pets in a locked car.

Some regions have laws prohibiting people or pets being left inside a locked vehicle.

6.3.3. Unresponsive lock

If your car doesn't lock or unlock as expected, there are some steps you can try.

Note

If the car's batteries go completely flat, it will not respond to any key.

If the car has been turned off for a long time, it may take several seconds for it to unlock. This is because the car needs time to turn its systems back on, to recognise the key and to give you access.

Locking not working

If the car won't lock, check that all of the doors are properly closed.

If the bonnet or the boot is not properly closed when you lock the car, the car will only lock the closed doors. Once you close the bonnet or boot, that too will be locked and covered by the alarm.

Note

Occupant detection

One reason why the car won't lock may be that an occupant is detected in the car. When this happens, a message appears in the centre display.

Automatic locking not working

For the car to automatically unlock when you approach and lock when you leave, make sure that:

- **Unlock car when approaching** and **Lock car when leaving** are enabled in settings.
- your distance-capable key is charged.
- the key's wireless signals are not being blocked.

If your car doesn't respond when you approach it with your distance-capable key, you can try unlocking it by touching the underside of the door handle or placing your key on the driver door handle key reader.

Digital key not working

If you are using a digital key, you can also try:

- turning your device's Bluetooth off and on
- checking that any required access settings are selected
- making sure that your car and device are updated to the latest software version
- restarting your device
- deleting and creating the digital key again.

Rear doors not unlocking

If the rear doors don't open when you pull the inner door handles, make sure the child lock isn't active.

6.4. Anti-theft

Your car has a number of systems and features which help to make your car secure when it's locked.

When you lock the car, some of its functions and systems are either shut down or activated to help protect the car from theft. For example, the alarm is automatically armed.



Warning

Do not leave your keys unattended in your car. They can be used to disable the security systems.

Alarm

The alarm is automatically armed when you lock the car and disarmed when you unlock it.

Gear shift lock

When the car is locked, the gear shift is locked.

Immobiliser

The immobiliser is an anti-theft system that prevents your car from being driven until it's started using a valid key. If your car can't find the key or fails to authenticate it, your car will remain immobilised. If the key can't be found or has a low battery, a notification appears in the centre display. If your car is unresponsive to a battery-powered key, try using a key card. If the car appears to have no power, the cause could be flat batteries or something affecting its electrical systems.

Double lock

Your car is equipped with a double lock, which means that it locks the doors from the outside and the inside. This is to prevent unauthorised attempts to open the car using the inner door handles.

Double locking is enabled by default. It will be temporarily disabled if you turn occupant locking on.

6.4.1. Alarm

The alarm helps deter unwanted interference with your car when it's parked.

The alarm is enabled when you lock the car and disabled when you unlock it.

Attempting to open a locked door triggers the alarm. The car tells you when it is unlocked by folding out the door handles.

Note

Locking with bonnet or boot open

If the bonnet or the boot is not properly closed when you lock the car, the alarm won't be fully enabled. In these cases, the alarm will only protect the side doors.

The car also won't detect any motion inside if you've locked it with the bonnet or boot still open.

Once you close the bonnet or boot, it will lock and be covered by the alarm.

Alarm indicator

The alarm indicator is a red light located at the front centre of the car, just inside the windscreen. The indicator confirms when the alarm is enabled with a flashing red light.

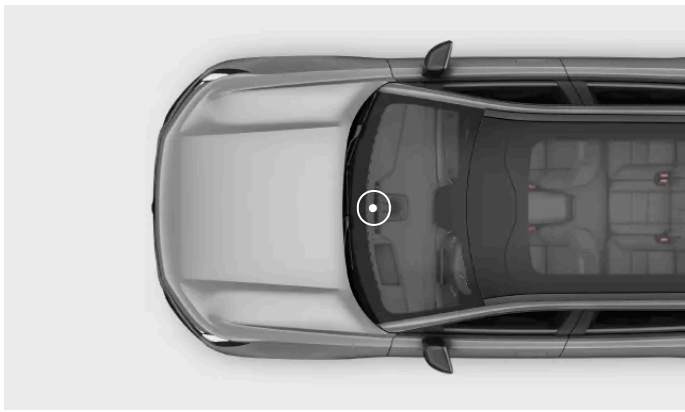

Triggering the alarm

The alarm triggers when an unauthorised attempt is made to open the bonnet, boot or any door. Movement inside the car can also trigger the alarm.

Once the alarm is triggered, the following happens:

- The alarm indicator and the warning lights flash for up to 5 minutes.
- The alarm sound starts.
- The alarm cycle restarts several times over if whatever triggered the alarm isn't resolved.

Note

To avoid any false alarms, the car's alarm is disabled while over-the-air software updates are being installed.



Tip

Alarm sensitivity

The alarm sensitivity can be lowered in settings, which is especially useful if the car is parked on a ferry where it can be affected by external motion or vibrations.

The alarm may also be triggered if you use a carjack, connect a trailer or have the car towed. In such cases, you should always activate reduced alarm sensitivity.

Stopping the alarm

Unlocking the car while the alarm is triggered will stop any alarm sounds and lights. The alarm indicator will continue to flash rapidly for a few minutes to highlight that there was a recent potential security issue.



Important

Do not make any changes or additions to the alarm system, or it may not work properly.

6.4.1.1. Reducing the alarm sensitivity

Reduce the alarm sensitivity when you expect significant movement in or around the car when parked.

This setting is especially useful if the car is parked where it can be affected by external motion, such as when travelling on a ferry.



Note

Check the alarm indicator if you are unsure about how the car is reacting.

1. Press the car symbol  in the bottom bar and go to **Settings**.
2. Go to **Controls** → **Locking** → **Reduce alarm sensitivity**.
3. Turn reduced alarm sensitivity on or off.

Reduced alarm sensitivity resets to off at the start of a new driving session.

7. Charging your car

Learn how charging works and how you can make each charging session more efficient.



In this section, you can find out more about the different charging types, charging settings, and how to start and stop charging. You can also read about other types of charging-specific information.

7.1. Charging types

Learn more about the different types of charging for your car and how to initiate charging for each type.

 **Warning**

Charging components and high voltage

- The car's charging components carry hazardous currents and voltages. They must be handled with care. Do not perform actions that are not clearly described in the user manual.
- Do not modify or make your own repairs to any charging components. Contact an authorised Volvo workshop for any required repairs or servicing.
- Installation and repairs of at-home charging equipment^[1] must be performed by a licensed electrician.
- Damage to the car's high voltage components, including the traction battery, can cause overheating, fire and serious personal injury. If there is a risk of damage, such as after battery leakage, flooding, fire or a collision, do not use the car. Contact an authorised Volvo workshop as soon as possible. If possible, leave the car outdoors and away from people, buildings, property and other objects that could catch or spread fire.

If you have a pacemaker or similar device

Charging the car may affect the function of an implanted pacemaker or other medical equipment. People with an implanted pacemaker are recommended to consult a doctor before charging the first time.

 **Note**

12 V battery charging

The car keeps the 12 V battery charged as long as the high voltage battery has sufficient charge.

Condensation during charging

During charging, condensation from the cooling system can collect under the car. This is perfectly normal and caused by the traction battery cooling down.

AC charging at a charging station or from a charging point at home

AC charging points are available at a variety of charging locations, both public and private. An AC charging point can be installed at home and is the recommended source for regular charging.

AC charging with household socket

You can charge your car from a regular household socket. This type of charging is only suitable for occasional charging and is not recommended for regular use. If you are planning to charge your car from a household socket, there are additional steps you need to take to ensure it is done safely.

 **Warning**

Do not use visibly worn or damaged electrical sockets as they could cause overheating, electric shock or personal injury.

 **Important**

- The car must only be charged from approved, earthed household sockets.
- Do not exceed the maximum permitted charging current when charging via a regular household socket. Limits imposed by local and national charging recommendations may apply.
- Ensure that the household socket fuse can handle the charging cable's specified current before you start charging. If you are uncertain, the socket must be checked by a qualified and licensed electrician.
- Never connect the charging cable when there is a risk of thunderstorm or lightning strike.

DC fast charging

DC fast charging is available at certain charging stations. These charging stations deliver very high power, as well as shorter charging times.

 **Note**

Voltage boost charging

When charging your car at a DC charging station with an output voltage below 800 V or battery maximum voltage^[2], a voltage boost charging is automatically activated. It will convert the lower voltage from the charging station to the higher voltage required by your car. This means you can still charge quickly even if the station doesn't support the battery maximum voltage. To enhance your DC charging experience, it is recommended to charge your car at a high-voltage-rated charging station.

 **Note**

Charging stations with support for fast charging are usually clearly marked CCS or Combo.

Charging cables

There are different charging cables to use when you charge your car. Mode 3 cables are the standard cable to use when charging electric cars. There are different versions of the mode 2 cable available. Mode 2 cables can be used as an emergency solution, but it is not recommended to use them as a daily charging method.

^[1] Including any work on the electric metre housing or power distribution service panel.

^[2] Your car's battery voltage can vary based on battery variant.

7.1.1. Charging cables

When using a charging cable for the first time, always check to make sure it's compatible with your car.

Charging cable recommendations and use

 **Warning**

High voltage

The cable is connected to a hazardous electrical system. Contact with high voltage current can cause fatality or serious personal injury.

Damaged cables

Do not use a charging cable that shows any signs of damage or wear. It can cause an electric shock. A damaged or malfunctioning charging cable provided by Volvo may only be repaired at an authorised workshop. Contact an authorised Volvo workshop for more information. If you are charging at a charging station, try another cable or charging point.

Excessive wear and debris

Remember to always check the charging cable's connector and the charge port for excessive wear and debris, such as ice or gravel. Do not touch the charging cable's connector or use any tools to attempt to remove debris from the charging cable. It can damage the charging cable's connector.

Public charging stations are in constant use and can be exposed to more wear and tear than a private charging station.

Cable placement

Remember to place the cable where there is minimal risk of it getting damaged or causing personal injury. A carelessly placed cable can easily get run over or tripped over.

Child safety

Keep children away from charging cables, especially when the cables are plugged in.

 **Important**

Liquids and cables

Do not submerge the charging cable or its components in liquid. If you need to clean the cable, use a clean cloth lightly dampened with water. If needed, use a mild detergent but never use chemicals or strong solvents.

Only use recommended cables

- Only use the cables originally provided with your car.
- Volvo takes no responsibility for damage or injury caused by charging equipment not recommended by Volvo.

 **Note**

Recommended cables

Volvo recommends a charging cable according to IEC 62196 and IEC 61851 that supports temperature monitoring.

Charging cable instructions

Before using a charging cable, make sure to read the instructions from the cable's manufacturer.

Some charging stations have a permanently attached charging cable. Be sure to follow the charging station's instructions on how to use it.

Mode 3 cable for charging stations

You can use this type of cable to charge your car at AC charging stations.

Mode 2 charging cables

Use a charging cable with a household plug to charge the car from an ordinary household socket, such as when no other charging options are available.

 **Important**

Do not use this type of charging as a daily charging method.

7.2. Charging view and settings

In the charging view, you can access information about the charging process, unlock the charging cable and set different charging settings. You can customise the charging settings according to your preferences. The charging view appears automatically when charging is initiated.

Note

The information content can vary depending on the current charging status.

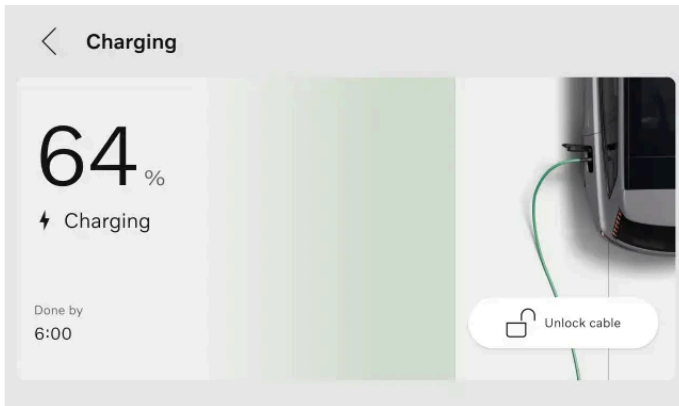

The following information, functions and settings are available in the centre display:

- Current battery level
- Target battery level
- Amperage^[1]
- Charging status
- Set a target battery level
- Limit the electrical current for AC charging
- Add and manage schedules
- Set a minimum battery level
- Unlock the charging cable
- Activate Plug & Charge

Tip

You can also access information about battery level, charging status and the charging process in the Volvo Cars app.

You can also access the charging view through the settings in the centre display.

^[1] Amperage is only shown if a limit was set.

7.2.1. Setting a target battery level for charging

You can set a target battery level by selecting a value in the charging view. This can help you to maintain good charging performance and battery longevity.

There are two preset options: **Daily drive** and **Long trip**. **Daily drive** is the recommended charging level which charges your car up to 90%. **Long trip** charges your car up to 100% and can be selected if you want the maximum range possible from your car. You can also choose to customise the target battery level value by selecting **Custom**.

 **Tip**

You can also set a target battery level for charging from the Volvo Cars app.

1. Press the car symbol  in the bottom bar and go to **Settings**.
 2. Go to **Charging** → **Target battery level**.
 3. Select your preferred battery level.
- > The target battery level value changes. The value is saved until you change it again.

7.2.2. Setting the amperage limit for charging

You can set an amperage limit for AC charging by selecting a value in the charging view.

Ampere, often written as "amp" or "A", is the unit for electric current. You can set an amperage limit in the charging view to control how much power the car uses when charging. This helps avoid overloading your home's electrical system and protects your battery from unnecessary wear and tear.

An amperage limit can be set for a specific location. The amperage limit setting is automatically applied when you charge your car in that location.

1. Press the car symbol  in the bottom bar and go to **Settings**.
 2. Go to **Charging** → **Amp limit**.
 3. Adjust the amperage limit to your preferred value.^[1]
- > The amperage limit changes and the value is saved until you change it again. When your car is charging, the amperage limit is shown in the centre display.

 **Tip**

You can also set an amperage limit in the Volvo Cars app.

 **Note**

The amperage may be limited by the charging station, charging cable or the car. There is no guarantee that the car can be charged with the specified amperage if it is higher than what is permitted by the charging station or charging cable.

^[1] Only available for AC charging.

7.2.3. Adding and managing charging schedules

You can set and activate a charging schedule for your car in the charging view. This means you can specify when you want the car to charge, such as when plugged in overnight.

 **Tip**

You can also add a charging schedule from the Volvo Cars app.

You can decide to activate either a manual or a smart schedule.

A smart schedule decides when to charge based on different parameters, for example battery health, cheapest time and user preferences.^[1] You only need to set a departure time and the system will try to meet your desired target battery level by the selected departure time. However, there are some external factors that can affect this, such as available power, type of charging cable at the charging station and the amount of time between plugging in the charging cable and the departure time. Make sure to plan accordingly and allow enough time for your car to be able to charge as planned.

A charging schedule can be set for a specific location. When you arrive at that specific location, the charging schedule is automatically applied.

1. Press the car symbol  in the bottom bar and go to **Settings**.
 2. Go to **Charging** and select either **Smart schedules** or **Manual schedules**.
 3. Press **Add** to add a charging schedule.
 4. If you added a smart schedule, select the departure time and press **Save**.
If you added a manual schedule, select start and stop times and press **Save**.
 5. Activate the schedule by turning it on.
- > The timer is active and the scheduled charging time is visible in the charging view.

You can also modify the schedule by adjusting the start and stop times or the departure time.

Deactivate the schedule by turning it off. The timer is not active and no scheduled charging is planned.

 **Note**

You can also override a charging schedule and charge straight away via the Volvo Cars app. This option is available if a charging schedule is active, your car is in park and the charging cable is connected. ^[2]

^[1] The options may vary depending on region.

^[2] The options may vary depending on region and app version.

7.2.4. Setting a minimum battery level for charging

You can set a minimum battery level by selecting a value in the charging view. This ensures that your car always charges to the minimum level, regardless of any other settings.

A minimum battery level can be set for a specific charging location. The battery level setting is automatically applied when you charge your car in that location. If a charging schedule is active, charging pauses until the scheduled start time when the minimum battery level is reached.

1. Press the car symbol  in the bottom bar and go to **Settings**.
 2. Go to **Charging** → **Minimum battery level**.
 3. Turn the function on.
 4. Adjust the minimum battery level to your preferred value.
- > The minimum battery level changes and the value is saved until you change it again.

7.2.5. Plug & Charge

Plug & Charge is an authentication and billing system that simplifies your charging experience.

Plug & Charge is enabled by ISO 15118, the international standard for charging electric cars. When using Plug & Charge, you don't need to use additional cards, apps or manual authentication steps. Instead, you can just connect the charging cable to your car. The charging station automatically recognises and authenticates your car, allowing the charging process to start.

The number of charging stations that support Plug & Charge is limited and all types of charging might not be supported. If the charging station doesn't support Plug & Charge, you need to authorise yourself at the charger.

There are other ways that can help you simplify your charging process. By using certain car parameters, you can connect the information to different apps and charging providers. Your car can then be automatically identified at the charging station, without any need for additional cards. However, the car's displays won't show any information or instructions for these methods.

7.2.5.1. Activating Plug & Charge

You can activate Plug & Charge in the charging view. This can simplify the charging process, from authentication to billing.

Note

Plug & Charge is included in the charging view but may not be available in your country. This is because e-mobility service providers^[1], charging stations and other infrastructure need to support Plug & Charge in your country before the feature can be used.

1. Press the car symbol  in the bottom bar and go to **Settings**.
2. Go to **Charging** → **Advanced settings** → **Plug & Charge**.
3. Turn the function on.
4. Press **View more** to easily copy your car's unique PCID^[2] number. Follow the instructions on how to activate Plug & Charge in the Volvo Cars app.

If you use a provider that isn't Volvo's partner, the process and instructions may vary depending on the e-mobility service provider.
5. Connect your car at a public charging station.

> The contract certificate is installed through the cable and the authorisation and payment are handled by the car and the charging station. You can see the status in the driver display and the charge port during the installation.
The charging session starts when the authorisation is finished.

 **Note**

If there are some faults related to Plug & Charge, try to reconnect the charging cable. If it still doesn't work, check the charging settings to see if there is a contract installed in your car. If there is a contract, contact your e-mobility service provider to make sure that there are no issues with the contract. If there is no contract, follow the activation steps again. If the problem persists, try normal charging. Authorise yourself at the charger and follow the instructions in the charging station's interface.



If Plug & Charge isn't working after a workshop visit, it could be because the contract certificate was removed from your car. Follow the activation steps again.

Handling Plug & Charge contract certificates

 **Note**

Removing contract certificates

After the Plug & Charge contract certificates are created, they're stored in the car and in an external server outside the car. Remember to delete both certificates when ending or transferring car ownership.

Your contract certificate in the car can be deleted from the centre display. Press the car symbol  in the bottom bar and go to **Settings** → **Charging** → **Advanced settings** → **Plug & Charge** → **Charging account**, then press the rubbish bin symbol .

To delete your contract certificate in the external server, go to the Plug & Charge settings in the Volvo Cars app.^[3]

Factory resetting of your car doesn't automatically delete the installed contract certificates. You still have to delete the contract certificate via the centre display.

Adding a new contract certificate

To add a new contract certificate, make sure Plug & Charge is on and follow the activation steps again. The most recent contract certificate will always be installed. If you want to delete the account permanently, you also need to cancel the contract with your e-mobility service provider.

^[1] An e-mobility service provider, also known as an e-MSP, is a company or organisation that offers services related to electric mobility.

^[2] Provisioning certificate ID

^[3] If you use a provider that isn't Volvo's partner, contact them as the process and instructions may vary.

7.3. Start and stop charging

You can charge your car by using either AC^[1] charging or DC^[2] charging. How you start and stop the charging process depends on the type of charging you use.

AC charging is the recommended charging mode for everyday charging as it maintains the condition of the battery over time. AC charging can be used if you are charging from a charging station, a charging point at home or a regular household socket. DC charging is available at certain charging stations and charges your car faster than AC charging. DC charging can be used when you need to recharge your battery quickly.

^[1] Alternating current

^[2] Direct current

7.3.1. Starting AC charging

AC charging can be done at certain charging stations, from a charging point at home or from a regular household socket. The cable you need depends on the charging mode.

To initiate charging, make sure:

- the car is in park.
- the charging settings are set up according to your preferences.

If you are using a regular household socket, also make sure it meets the safety requirements for charging.

 **Warning**

Do not connect any equipment other than the charging cable between the charging source and the car's charging port.^[1] It can cause malfunction, damage or electric shock.

1. Connect the charging cable to the charging source. Some charging stations have a permanently attached charging cable that you connect to your car.
2. Open the charging lid by lightly pressing on its rearmost end.



3. Remove any protective cover from the cable connector.

 **Important**

To avoid damage to the car, position the connector's protective cover so that it does not touch the car.

4. Connect the cable to the charging port.

> When the cable is fully inserted it locks into place. Charging starts within a few seconds.

You can see the charging status in the charging port and in the driver display.

Recommended action if charging does not start

First, disconnect the cable from the car's charging port, then from the charging source. Wait a moment before reconnecting it. If the problem persists, contact an authorised Volvo workshop.

^[1] This includes extension leads, socket splitters, socket adaptors, external timers, overvoltage protection devices and similar devices.

7.3.2. Starting DC charging

DC charging is available at certain charging stations.

DC charging stations have permanently attached charging cables, so you don't need to use your own.

 **Warning**

- Public charging stations are in constant use and can be exposed to more wear and tear than a private charging station. Remember to always check the charging cable's connector for excessive wear or debris.
- Do not touch the charging cable's connector or use any tools to attempt to remove debris from the charging cable. It can cause an electric shock.
- Do not use a charging cable that shows any signs of damage or wear. It can cause an electric shock. Try another cable or charging point at the charging station.
- Ensure that the charging cable's connector connects all the way into the charging port. A worn connector may prevent a safe connection to your car.

To initiate charging, make sure:

- the car is in park.
- to check the charging station for any instructions before you begin.

1. Open the charging lid by lightly pressing on its rearmost end.



2. Remove any covers from the port and cable connector.
3. Use both hands to press the cable's connector all the way into the charging port. Make a habit of pushing the charging cable upwards for a couple of seconds after inserting it to ensure connection and locking.
 - > The charging cable automatically locks in place after a few seconds.
4. After confirming that the cable is locked in place, follow the charging station's instructions for charging authorisation.
 - > Charging starts after an insulation test has been completed by the charging station. It can take a minute to complete.

You can see the charging status in the charging port and in the driver display.

7.3.3. Stopping AC charging

You can stop the charging process at any time.

 **Important**

Stop the charging session before attempting to unplug the cable from the car's charging port. If you do not, you may cause damage to the cable or to the system.

1. Stop charging by pressing the release button next to the charging port.



- > The charging is stopped and the charging cable unlocks from the charging port.
2. Unplug the charging cable from the car.

 **Note**

If the charging cable isn't unplugged within a short period of time, the cable locks again and charging resumes.

3. If available, reattach the protective cover on the cable connector.
4. Depending on the cable you have used:
 - Unplug the charging cable from the charging station.
 - Reattach the charging cable to the station's storage socket.
5. Close the charging lid.

 **Tip**

You can also stop the charging process from the charging station or by pressing the **Unlock cable** button in the car's centre display.

7.3.4. Stopping DC charging

You can stop the charging process at any time.

 **Important**

Stop the charging session before attempting to unplug the cable from the car's charging port. If you do not, you may cause damage to the cable or to the system.

1. Stop charging by pressing the release button next to the charging port.



- > The charging is stopped and the charging cable's handle unlocks. This may take a couple of seconds.
2. Unplug the charging cable from the car.
 3. If available, reattach the protective cover on the cable connector.
 4. Reattach the charging port's protective cover and close the charging lid.

**Tip**

You can also stop the charging process from the charging station or by pressing the **Unlock cable** button in the car's centre display.

7.3.5. Releasing the charging cable

If the charging cable doesn't automatically release after you have stopped the charging, there are some steps you can try.

The charging cable usually releases automatically when you have stopped the charging. However, if the charging cable is left in the charging port for a while after charging has stopped, the charging cable is automatically locked in again.^[1]

Make sure that the key is within range and that the car is unlocked.

- Stop charging by pressing the release button next to the charging port or by pressing **Unlock cable** in the centre display.
- If you're charging at a public charging station, follow the instructions in the charging station's interface to stop charging.
- Carefully wiggle the charging cable.
- Lock and unlock the car.
- Lock the car and wait until the LED on the car's charging port turns off. This can take some time. After that, unlock the car and try to stop charging via the release button or via the centre display again.

If the charging cable still doesn't release, stop charging via the charging station, charging point or household socket in one of the following ways:

- Charging via a public charging station: Contact the charging station's customer service to get help to stop the charging.
- Charging via a home charging point: Safely disconnect the power supply to your home charging point.
- Charging via a household socket: Unplug the cable from the household socket.

If the problem persists, contact an authorised Volvo workshop.

^[1] Applies to AC charging.

7.3.5.1. Using the emergency release handle for the charging cable

The content of this manual represents the status of the user manual at the time of printing and may not be completely valid in future instances. For more information, refer to the first page for the complete disclaimer note.

If the charging cable doesn't release from the car after you have stopped the charging, you can use the emergency release handle. Never use the emergency release handle when charging is in progress.

1. Open the boot and the cargo hatch.
2. Locate the emergency release handle on the left side of the boot.



3.  **Warning**
Before using the emergency release handle, check the driver display or the charging port to make sure the charging process has stopped. The emergency release handle should not be used when charging is in progress.

Carefully pull the emergency release handle until you feel resistance.

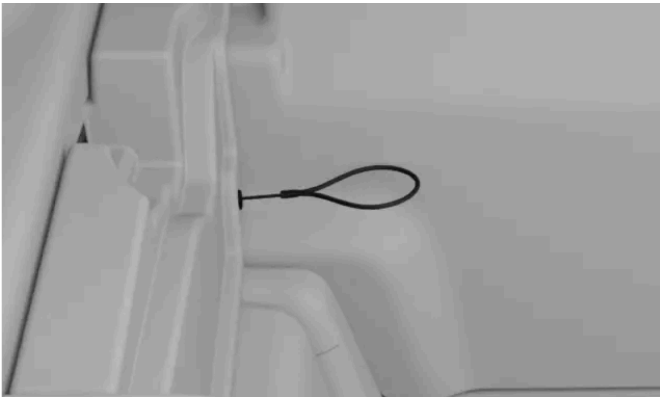

- > The charging cable unlocks from the charging port.

 **Note**

The emergency release handle automatically retracts when the next charging cycle is started.

4. Wait for about 5 seconds before unplugging the charging cable from the car.
5. Close the boot.

If the problem persists, contact an authorised Volvo workshop.

7.4. Charging time and statuses

Learn more about charging times so that you have an idea of what to expect in different situations and what the different charging statuses mean.

7.4.1. Charging times

The time it takes to charge your car depends on the charging type and several factors. The charging times mentioned are approximate.

Some examples of factors that can affect the charging time are:

- preconditioning
- the car's climate system and other active electrical loads
- ambient temperature
- battery temperature
- charging equipment
- battery size
- battery condition and car condition
- infrastructure
- charging settings such as amperage limit.

AC charging from a household socket^[1]

Current (A) ^[2]	Charging power (kW)	Charging time (hours) ^[3]
10	2.2	76
16	3.6	39
32	7.2	17
48	11	11

AC charging at a charging station or from a charging point at home

Current (A) ^[2]	Charging power (kW)	Charging time (hours) ^[3]
6	4	34
10	6.8	18
16	11	11

Fast charging from a DC charging station

Note

The charging times shown are based on rated power for compatible high-voltage charging stations. Actual charging power may be limited when using low voltage, for example 400 V DC charging stations.

Station power (kW) ^[4]	Charging time (minutes) ^[5]
50	92
150	32
300	24
350	22

Note

The battery can charge the fastest when the battery level is low. After reaching 30%, the maximum charging speed gradually decreases as the battery level increases.

Tip

When you use Google Maps to set a fast-charging station as your destination, the car preconditions the battery to improve charging performance once you get there.

Note

If data is missing it will be updated at a later stage.

^[1] Using a 200-240 V socket.

^[2] Maximum charging current may vary depending on region.

^[3] From 0-100%

^[4] Maximum power that the charging station can supply

^[5] Applies at 10-80% state of charge provided that the temperature of the battery is approximately 35 °C (95 °F). Charging times will vary and are dependent on factors such as outside temperature, charging equipment, battery condition and car condition.

7.4.1.1. Manually activating battery preconditioning

Before starting DC fast charging, you can activate battery preconditioning in the charging view. This can improve charging performance and efficiency, especially during cold conditions.

Activating battery preconditioning before DC charging means that the battery will reach the ideal temperature for maximum charging speed, leading to a reduced charging time.

i Tip

Battery preconditioning automatically activates when a DC fast charging station has been set as your destination in the navigation app.

1. Press the car symbol  in the bottom bar and go to **Settings**.
 2. Go to **Charging**.
 3. Press **Precondition battery**.
 4. Press **Start**.
- > Battery preconditioning is active for approximately 30 minutes and then automatically deactivates. The remaining time and status of preconditioning are shown in the centre display.

Press **Stop preconditioning** if you want to deactivate the preconditioning manually.

7.4.2. Charging status

The car's charging status is shown using different colours, both in the charging port and in the displays.











- ① Charging status information in the driver display
- ② Charging status information in the charging port

The charging port light only indicates the current status of the charging cycle. If you would like more comprehensive information, you can find this in the driver display. You can also access the charging view in the centre display for an even more detailed description.

7.4.2.1. Charging status in the charging port

You can see the car's current charging status in the charging port.

Colour	Colour name	Description
	White, solid	The charging cable is attached and unlocked.
	White, pulsating	The charging cable is attached and the charging process is either initiating or waiting to start.
	Green, pulsating	Charging is in progress.
	Blue, solid	Charging is scheduled.
	White, pulsating fast	The status is visible while charging is being stopped.
	Green, solid	Charging is complete.
	Red, solid	Charging fault. Check the displays for additional information. Always make sure that the charging cable is correctly connected to the car's charging port and that the power source, such as the cable or the charging station, works correctly. If an error is indicated, try to disconnect the cable from the car then reconnect it and re-initiate charging to see if the problem is solved. If the problem persists, contact an authorised Volvo workshop.
	Red, pulsating	The status is visible if you have tried to unlock the charging cable without being authorised. Unlock the car and try again.

7.4.2.2. Charging status in the driver display



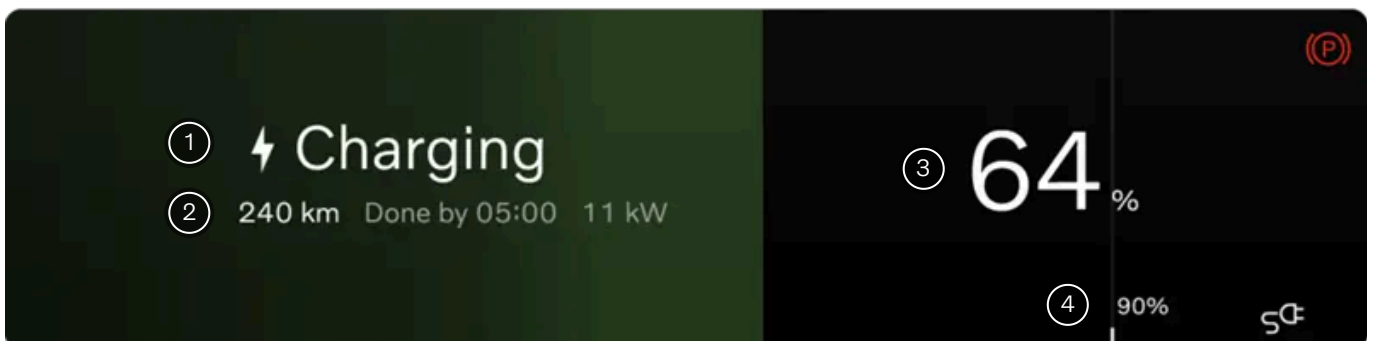







You can see the car's current charging status in the driver display.



Information available in the driver display.

- ① Charging status information
- ② Current range and charging power
- ③ Battery level information
- ④ Target battery level

The driver display contains charging status information such as status text, battery level, current range, charging power, remaining charging time and scheduled time information. Different colours of the progress bar are also visible. The information may vary depending on the charging status.

Status	Colour	Colour name	Description
Initialising		Silver, pulsating	The cable is plugged in and the car is initialising the connection.
Authorising		Silver, pulsating	The cable is plugged in and authorising the payment method when Plug & Charge is enabled.
Charging		Green, pulsating	The car is charging. If the car is charging while a navigation route is active, the navigation symbol  is visible in the display. The symbol indicates the required battery level for the route.
Ready to go		Green, pulsating	The car is charging and the battery level is sufficient to reach the next destination. The car continues to charge until it reaches the battery level target.
Done		Green, solid	Charging is complete.
Charging to %1\$s%		Green, pulsating	The car is charging to the minimum level while a schedule is active.
Scheduled		Blue, solid	The cable is plugged in and your car is scheduled to charge at a later time. Information about the scheduled time is visible in the display.
Smart charging		Green, pulsating	The cable is plugged in and the car is set to smart charging. The system is responsible for choosing when you charge.
Waiting		Silver, solid	The cable is plugged in but the car is not charging. This can occur because the charging point is using its own scheduling or if something overheated.
Charging fault		Red, solid	The cable is plugged in but there is an error in the charging connection. Depending on the error, the display shows different messages. If the problem persists, contact an authorised Volvo workshop.

8. Driving

Your car is designed for driving. This section covers the essential driver controls that allow you to start, stop, steer and change gears. You can also find information about driving characteristics and handling here.



Many of your car's driving features can be customised for a personalised experience. While some features are more directed towards comfort, others are strictly safety related. It's important to check your driving position, maintain good visibility and to always stay attentive and focused while driving.

8.1. A typical driving cycle

This description provides an overview of your car's capabilities and behaviour in the different stages of a typical driving cycle.

A driving cycle starts when you unlock your car and ends when your car is powered down after driving.

The different situations and scenarios described here have their own sections in this manual with more detailed information.

Approaching and unlocking

Your car unlocks differently depending on which type of key you use. When your car unlocks, it also powers on.

Entering

When you enter your car, it can automatically select your profile if you use a connected key. It adjusts the driver's space and applies your profile settings for features and car behaviour. Additional features can be accessed when you are seated and ready to drive, such as climate and comfort.

Beginning your drive

The type of key you are using affects how you start the car. If you are using a key card or a discharged key, it needs to be placed on the card reader for you to be able to start driving. If your car detects a distance-capable key, you just have to keep it inside of the car.

To start driving, press the brake pedal and select a gear. Your car can notify you of any open doors, unbuckled seatbelts or other issues related to driving.

Tip

There's information in this manual that might be useful, depending on what kind of journey you're about to go on. For example, you can find information about your car's stowing capabilities or what you need to think about when driving in winter conditions.

Parking

Your car will automatically apply the parking brake and enter a parked state when you leave the driver's seat. This is part of a gradual power-down as you get ready to leave the car. If you want to remain in your car after parking, with the climate and media features still available, you can adjust your climate settings to remain active after parking.

You can also manually activate the parking brake by pressing the P button on the right-hand steering wheel stalk.

Powering down, locking and leaving

When you leave and lock your car it will gradually power down. This is done automatically and the car will enter a stand-by state.

You can also manually turn your car off via the centre display.

Tip

If possible, charge your car when you leave it for longer periods of time.

8.2. Trips app

The Trips app is a driving journal that automatically logs all trips made with your car.

When this app is enabled, it automatically collects your car's identification number^[1], location and other trip-related data, such as time, distance and battery consumption.

Note

The Trips app calculates the battery consumption based on pure consumption during a trip. If you see a different value in your car's trip meter, it's because the trip meter also takes energy regeneration into account.

In the Volvo Cars app, you can:

- View, manage and delete all of your trips.
- Export your driving journal.
- Stay informed if a trip isn't uploaded due to an issue, such as network problems.

When the Trips app is enabled, all users that have paired the Volvo Cars app with the car can see the trips. If the Trips app is disabled, the car stops sending information about new trips.

 **Note**

Car location sharing

You need to enable car location sharing in the display and in the Volvo Cars app to start logging your trips.

Storage limits

When a trip is logged, it can be stored in the Trips app for up to 400 days. The app has the capacity to store approximately 500 trips. When this limit is reached, older trips are automatically deleted to free up space and make room for new trips.

 **Note**

If the journal isn't logging trips, the reasons for this might include:

- Weak or no network connection.
- The app isn't receiving GPS coordinates.
- Location permissions are disabled so the Trips app can't access the car's location.

[\[1\]](#) VIN

8.3. Starting the car

Starting your car requires a present and correctly used key along with pressing down the brake pedal and selecting a driving gear.



Your main interaction points for starting your car are the brake pedal and the gear stalk.

Your car unlocks differently depending on which type of key you are using. Once unlocked, your car gradually powers on. Many features, such as the climate system, will be accessible once you enter your car.

To start your car, press down the brake pedal and select a driving gear. If you are using a key card or a discharged distance-capable key, you must first place it on the card reader.

Before you start driving, make sure that:

- All doors are closed.
- All occupants are properly seated and wearing their seatbelts correctly.
- The driver seat, the steering wheel position and the mirrors are adjusted to your driving position.
- No charging cables are connected.
- The driver area is unobstructed and that the pedals are freely moveable.

i Tip

The car can alert you to certain conditions you should address before driving. If something is preventing you from starting the car, have a look in the driver display for guidance.

i Note

If your car is equipped with an alcohol lock, you need to take and pass a breath test before starting the car.

1. If you are using a distance-capable key, make sure to keep it with you.

If you are using a key card or a discharged distance-capable key, place it on the card reader.



The location of the key card reader, used if you start the car with a key card or a discharged distance-capable key.

2. Press and hold the brake pedal down.
 3. Select D or R using the right-hand side steering wheel stalk.
- > The selected gear is indicated in the driver display. The ready symbol also appears, emphasising the transition from parked to a driving gear.

READY

Note

The ready symbol disappears when the car's speed exceeds walking pace.

8.3.1. Start-up checks

When you select a gear to start driving, the car performs a number of self-checks of important systems and functions. This short test is indicated in the driver display.

The start-up check is indicated by several warning and indicator symbols in the driver display. If any of the warning or indicator symbols remain visible after a few seconds, it tells you that there's a fault or condition you need to address before driving.

If a fault is indicated:

- Read any related information presented in the driver display.
- For additional information about warning and indicator symbols, consult that section of the manual.
- Resolve the indicated fault before driving.
- If you cannot resolve the issue yourself, do not hesitate to contact an authorised Volvo workshop.

After the start-up check is performed, the car continues to actively monitor many of its systems and functions.

8.3.2. Alcohol lock

The alcohol lock is a safety measure to prevent driving under the influence of alcohol. If your car is equipped with an alcohol lock, you must take and pass a breath test before you can start your car.

If you have connected an alcohol lock, it will integrate with some of your car's systems. This means that you can receive messages from the alcohol lock directly in the driver display. Alcohol lock calibration should be done in accordance with the local laws and regulations on the limit value in force for driving legally.

For information about a specific alcohol lock, please refer to the relevant alcohol lock manufacturer.



Warning

The alcohol lock is an aid and does not exempt the driver from responsibility. It is always the responsibility of the driver to be sober and to drive the car safely.

Using an alcohol lock

The alcohol lock automatically activates to be ready for use when the car is unlocked. Follow the instructions included with the installation of the alcohol lock, along with the messages presented in the driver display.

After completing a driving cycle, meaning that you have driven and then stopped, your car can be restarted within 30 minutes without requiring a new breath test.



Tip

Accurate measurement

Avoid eating or drinking approximately five minutes before the breath test.

Avoid excessive windscreen washing as the alcohol in the washer fluid may affect the alcohol lock.

Emergency bypass of the alcohol lock

In the event of an emergency or if the alcohol lock is not working, it is possible to bypass the alcohol lock. To do this, see the instructions provided with the alcohol lock or contact the manufacturer.

8.4. Turning the car off

The car typically powers down automatically but you can also manually turn it off in the centre display.

Your car keeps track of certain actions after parking, such as people unbuckling seatbelts and opening their doors to get out. This allows the car to automatically turn itself off after you lock and leave it. However, in some situations, you may want to manually turn it off.

 **Note**

In some situations the automatic power-down, including locking, can be interrupted or prevented. This can happen if a door is not fully closed, a key is left in the car or movement is detected in the car.

Turning the car off manually

1. Press the car symbol  in the bottom bar and go to **Settings**.
2. Go to **Controls** → **Car modes** → **Power options**.
 - > The **Power options** menu is shown.
3. Select one of the power options.
 - > The car powers down to the selected level.

If you power your car down and remain seated in the driver's seat you can press the brake pedal to start your car again.

 **Note**

After being turned off, a number of essential systems remain available, such as key detection, alarm, internet connectivity and battery monitoring. Under normal conditions, they only use a small amount of power.

8.5. Driving characteristics

Explore the features that affect driving performance and dynamics. This can allow you to customise your driving experience.



Your car has several features that affect your car's driving dynamics and performance.

- One pedal drive** This allows you to both brake and accelerate using only the accelerator pedal. The function can be turned on or off and adjusted in the centre display.
- Automatic creeping** This allows you to drive at very low speeds without holding down the accelerator. You can enable or disable automatic creeping in settings.
- Drive modes** You can configure the car for daily driving or set a drive mode to suit your driving situation. Depending on which drive mode you select, certain driving dynamics may be affected, such as steering, suspension, braking and acceleration.
- Steering feel** Adjusting the steering feel affects the steering wheel resistance and firmness.
- Suspension feel** The suspension feel affects the ride quality and can be adjusted in the centre display.
- Electronic stability control^[1]** Your car has automatic stability control systems in place that can help to prevent skidding.



Tip

Exterior sound

Your car plays an artificial driving sound when you are driving at low speeds. This is to alert others of your presence.

^[1] ESC

8.5.1. Drive modes

The drive modes change the driving dynamics of your car and which settings are available.

The drive modes available in your car are all suitable for different scenarios and types of driving. Depending on which drive mode you select, certain driving dynamics may be affected, such as steering, suspension, braking and acceleration. Your car's

estimated range is also affected. Each drive mode allows for different adjustable settings related to both driving and climate.

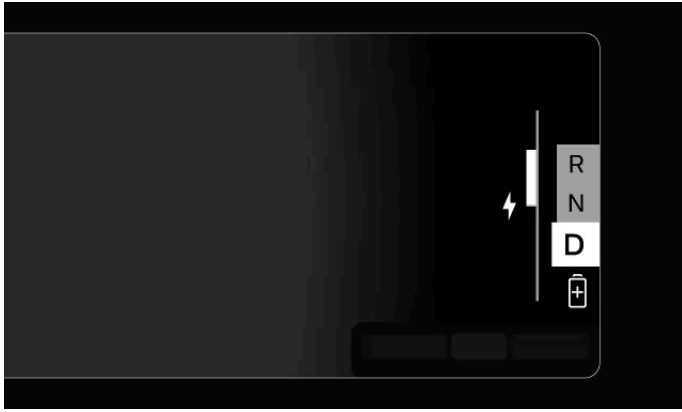

Your selected drive mode is shown below the gear in the driver display^[1].

You can select these drive modes:

- Standard** This is the default mode and is recommended for everyday use.
- Range** This mode limits climate and driving performance to maximise range.
- Performance** By prioritising performance, your car will allow for quicker acceleration and an enhanced road handling experience. This mode decreases your expected range.
- Off-road** The off-road mode is suitable for when you're driving on roads with limited accessibility or rough terrain. You can also use off-road mode when you're driving on loose surfaces as deep snow or sand. Your car's suspension is raised, giving it a higher ground clearance. The off-road mode also activates hill descent control, allowing your car to brake in a more controlled and active way when driving downhill.

Note

Default drive mode

If the car is in range mode when you turn it off, range will be selected the next time you start the car. If you are using another mode, standard mode will be selected by default.

Off-road limitations

The off-road mode has limitations and is only available below certain driving speeds. Hill descent control is available until you reach 40 km/h (25 mph). Driving at higher speeds automatically disables the off-road mode in full. If this happens while driving on a steep downhill gradient, the automatic braking effect from hill descent control will gradually decrease.

Driving with the suspension raised is only available at speeds below 25 km/h (15 mph). If you exceed this speed, your car's suspension automatically returns to its previous height.

When Pilot Assist is activated, the off-road mode can't be selected.

The off-road mode is not designed to be used on public roads.

^[1] The standard mode is not indicated in the driver display

8.5.1.1. Selecting a drive mode

You can select a drive mode in settings.

Your car is equipped with several drive modes suited for different driving conditions and situations. Selecting a drive mode adjusts the driving characteristics and dynamics of your car, which might disable certain settings. You can select a drive mode in settings.

1. Press the car symbol  in the bottom bar and go to **Settings**.
 2. Go to **Driving** → **Driving dynamics** → **Drive modes**.
 3. Select a drive mode.
- > Your car's driving characteristics and dynamics are adjusted, depending on your selected drive mode.

 **Note**

Default drive mode

If the car is in range mode when you turn it off, range will be selected the next time you start the car. If you are using another mode, standard mode will be selected by default.

8.5.2. One pedal drive

You control both braking and acceleration with the accelerator pedal when One pedal drive is active.



The braking behaviour changes through the use of the accelerator pedal. When you press the accelerator, the car accelerates as normal but releasing the pedal engages braking. The more you ease up on the pedal, the more braking action you get. By releasing the accelerator completely, you will eventually bring your car to a full stop.

You can turn One pedal drive on or off in settings. You can also select the **Auto** setting which enables One pedal drive but only allows you to brake by releasing the accelerator when you are close to a vehicle in front of you.

Regenerative braking is prioritised by One pedal drive. However, the disc brakes can be applied if the braking action demands it.

Using the One pedal drive auto setting

When the **Auto** setting is selected, you can only brake using One pedal drive when there is a vehicle detected in front of you. This means that if the road ahead is clear, releasing the accelerator pedal does not brake the car. This can make driving in light traffic for a longer time more comfortable, as you won't have to apply constant pressure on the accelerator. However, this also means that you must be ready to use the brake pedal in situations where you have to brake without a vehicle right in front of you. These situations can include, but are not limited to, stopping at a stop sign, traffic light or an intersection, or when driving on roundabouts.

Important

RadAR and camera detection conditions

When **Auto** is selected, One pedal drive uses the car's camera and radar units, which have some general limitations. The detection system cannot handle all driving, traffic, weather or road conditions. Read the separate manual sections about detection types, how they work and their limitations to better understand how the **Auto** setting's performance can be affected.

Keep the brake pedal in mind

There is a limit to the braking force that can be applied by releasing the accelerator when using One pedal drive. For hard braking you need to use the brake pedal.

You can only use One pedal drive after selecting a driving gear, D or R. When N is selected no braking force will be applied when you ease up on the accelerator, even if One pedal drive is enabled in settings.

Slippery road conditions

Using One pedal drive is not recommended during slippery road conditions.

Off-road

One pedal drive is unavailable when the off-road feature is activated.

8.5.2.1. Adjusting One pedal drive

You can adjust how much braking force One pedal drive applies when you release the accelerator.

The available settings are:

Auto Releasing the accelerator only applies braking force when you're close to a vehicle in front of you.

High When you ease up on the accelerator, the car will apply braking force until it comes to a standstill.

Low When you ease up on the accelerator, the car will apply less braking force than in the high setting.

Off Releasing the accelerator doesn't engage the brakes.



Tip

Quick access

A button for adjusting One pedal drive is also available in quick controls in the centre display when you drive. This allows you to quickly adjust One pedal drive without going into settings.

Automatic creeping

By turning One pedal drive off, you also enable automatic creeping. This means that your car can move slowly without you using the accelerator.

When automatic creeping is active you can temporarily pause it by pressing down hard on the brake pedal until your car is stopped. This activates the hold feature. If you want to initiate creeping again, simply tap the accelerator.



Warning

There is a limit to the braking force that can be applied by releasing the accelerator when using One pedal drive. For hard braking you need to use the brake pedal.

1. Press the car symbol  in the bottom bar and go to **Settings**.
2. Go to **Driving** → **Driving dynamics** → **One pedal drive**.
3. Select a One pedal drive setting.

8.5.3. Stability control

Your car has stability control systems in place that can help to prevent skidding.

Electronic stability control

Electronic stability control^[1] consists of several sub-features that can apply your car's brakes automatically to prevent skidding when the car detects a loss of traction or steering control. To do this, ESC applies the brakes to each wheel individually. When this intervention happens, the symbol for ESC flashes in the driver display.



Your car's stability control includes several other features, such as:

Anti-lock braking system^[2]

The car's anti-lock braking system prevents the brakes from locking up during hard braking. This improves braking performance and manoeuvrability and helps with stabilising the car.

Trailer stability assist

This is part of the ESC and can intervene if snaking is detected when you are towing a trailer.

Traction control^[3]

TCS is a safety feature designed to detect when the wheels lose traction or slip. The feature will then help the wheels regain traction by applying braking measures.

Regeneration stability control

Helps with preventing wheel locking when regenerative braking is applied.

[1] ESC

[2] ABS

[3] TCS

8.5.4. Suspension

Your car has suspension designed to create a pleasant driving experience.

Your car's suspension affects the comfort and handling of your drive. Some of the suspension features can be customised in the centre display, while others are automatic.

Suspension feel

You can change how stiff or soft your road contact is by adjusting the suspension feel in settings. Different suspension settings are suited for different driving situations and scenarios.

 **Important**

The suspension can only be adjusted via the centre display. The physical suspension system should only ever be handled by a trained technician.

 **Note**

Speed dependent suspension feel

Your car will automatically adjust the suspension firmness depending on your speed. This is separate from the adjustable suspension feel setting and allows you to maintain good road handling while driving at different speeds.

Suspension height

You can raise the car's suspension to increase the ground clearance of your car by activating the off-road feature. This is done in settings in the centre display.

 **Note**

Speed dependent height

Your car will automatically adjust the driving height depending on your speed. This is separate from the off-road setting and allows you to maintain good road handling while driving.

 **Warning**

The shock absorbers are gas pressurised. Do not heat or open the shock absorbers.

8.5.4.1. Adjusting suspension feel

You can change the suspension feel in settings.

Suspension affects both comfort and handling. By changing the suspension feel you affect the compression and rebound characteristics of your car's suspension.

 **Important**

The suspension can only be adjusted via the centre display. The physical suspension system should only ever be handled by a trained technician.

1. Press the car symbol  in the bottom bar and go to **Settings**.
2. Go to **Driving** → **Driving dynamics** → **Suspension feel**.
3. Select a suspension feel setting.

8.6. Range

Your car's expected range is shown in the driver display and depends on several factors.

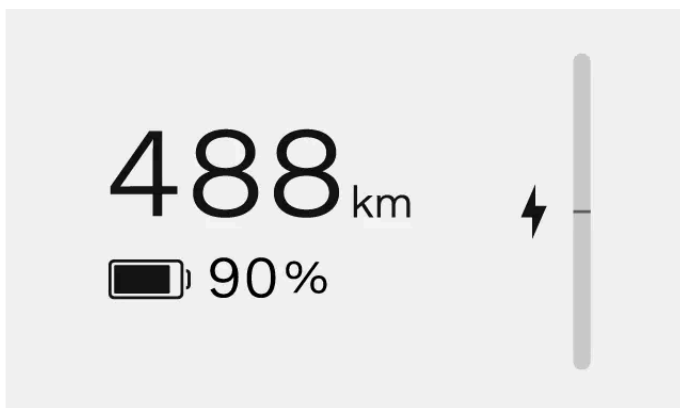

Your range is primarily related to your car's battery level and your driving practices but external conditions can also be a factor. The battery level and expected range are displayed in the driver display. The expected range is calculated based on your driving

pattern, both current and historical.

Factors that affect your car's range

How you drive your car, which settings or features are activated, weather conditions and traffic can all affect your car's range in different ways.

Speed	Driving at higher speeds drains the battery more.
City driving and traffic situation	Varying your speed by frequently accelerating and braking will increase your battery consumption compared to keeping a constant speed.
Eco driving	Keep track of your driving with help of the range assistant to drive as economically as possible.
Outside temperature	The outside temperature can affect your battery consumption and range.
Battery temperature	A cold battery is less efficient and needs more energy to be heated.
Preconditioning	By preconditioning your car, you can decrease the energy used to heat it up as well as the battery. This can be done in the climate settings.
Climate settings	Which climate features are activated and to what extent affects your battery consumption.
Tyres and tyre pressure	Tyre condition and tyre pressure can affect your range.
Road condition and topography	The condition of the road, along with any potential slopes, can affect your car's battery consumption.
Towing	Towing a trailer demands more power from your car and will therefore adversely affect battery consumption. This is relative to the type of trailer being towed.

If you want to know more about your car's range and how you can affect it you can have a look in the range and trip app, which is accessed in the app library .

Range in cold temperatures

Your car's battery can be negatively affected by cold temperatures. When the car has a cold battery, a snowflake ❄ appears next to the battery percentage. This indicates that the battery's charge capacity, performance and range are reduced compared to normal conditions. You can avoid this by always charging your car while it's parked, which can prove especially useful if you are parking in a cold climate.

When the battery warms up, for example during preconditioning of the car or when driving, the snowflake disappears from the driver display.

Factory reset and range value

After a factory reset, or when the car is delivered from the factory, the estimated range is based on a certified value. After driving your car for a while, the estimated range is instead based on your historical driving patterns.

8.6.1. Range and trip

The range and trip app can provide you with an overview of your range and energy consumption. This can help you to maintain eco driving.

You can access information about your energy consumption in the range and trip app, which is accessed in the app library .

By viewing the different tabs, **Range assistant** and **Trip information**, you can get access to different aspects of your energy consumption and range.

Range assistant



You can view your current range and energy consumption in the **Range assistant** tab. Your consumption is shown differently depending on the situation. When you are in motion it is based on distance, and when you are stationary it is based on time. The value always reflect your current consumption rate, therefore increasing during actions such as fast acceleration or uphill driving.

Your speed, climate settings and driving style all affect how much range you get. It could therefore be a good idea to keep track of your energy consumption based on these three factors if you want to maintain economical driving.

- Speed** Your average speed during the last minute.
- Driving style** Your acceleration and braking behaviour during the last few minutes.
- Climate** The expected average energy consumption from your current climate settings.

The estimated range is calculated on your driving style and the current driving conditions. In addition to this, the calculated maximum and minimum range values are shown next to the estimated range value. These indicate your possible range, based on high and low consumption.

- Maximum range** Calculation based on typical city driving with the climate system turned off.
- Minimum range** Calculation based on high speed driving with the climate system turned on.

Range optimiser

You can activate the range optimiser in the **Range assistant** tab. The range optimiser sets up the car to help you maximise range by lowering the energy consumption. When active, it enables the eco climate setting and adjusts power delivery performance to prioritise range over power.

Trip information



The **Trip information** provides an overview of your recent and current energy consumption over distance. This is also where you can reset your trip meter.

You can look at and monitor your trip information in different ways:

- Since last reset** This distance can only be manually reset. It allows you to define what a trip is. Just remember to reset it at the start of the trip you want to keep track of and to look up the driven distance when it comes to an end.
- Since last charge** This distance resets automatically when you charge the car.
- Current trip** This distance resets automatically and reflects how far you've driven on your current drive.

You can open a more detailed view by pressing each of the different trip options.

8.6.1.1. Resetting the trip meter

You can reset your car's trip meter. This is done in the range and trip app.

The trip meter can show you information of your current trip, since your last charge or since your last reset.

1. Press the app library symbol  in the bottom bar and open the **Range and trip** app.
2. Go to **Trip information** → **Since last reset** → **Reset**.
3. Reset the trip meter.

8.7. Steering

Get familiar with your car's steering-related functions.



Your car has been designed to provide a responsive and intuitive steering experience. Be sure to adjust your driving posture and select your preferred steering feel before driving.

Tip

Steering and driver support interactions

Several of your car's driver support features can affect the steering. Read the manual sections about these features for a more complete understanding of how they can interact with and affect your steering experience.

Speed-dependent steering response

The steering resistance and firmness change with the speed of the car. At low speeds, steering resistance is low for precision manoeuvring. At high speeds, the steering adapts to be firmer.

Steering feel





You can adjust the steering feel via the settings in the centre display. Steering feel affects the firmness of the steering wheel's turning.

Steering-related faults

If you notice that your steering wheel is abnormally firm, or if steering-related features^[1] are not available or working properly, this can be due to a fault related to the steering system.

If your car notices a steering-related fault it will notify you with a message in one, or both, of the displays. Be sure to read and follow the instructions in the message.

The instructions in the message depend on the nature and severity of the detected fault. The level of urgency is critical to how fast you need to act and can be communicated by the message and by use symbols.

	Steering assistance temporarily reduced	Take caution. Follow the instructions in the message. ^[2]
	Steering fault	Take caution. Follow the instructions in the message. ^[2]
	Steering fault	Immediate action required. Follow the instructions in the message with urgency and caution. Book a service as soon as possible.
	Stop safely	Immediate action required. Stop the car safely and call for assistance.

Important

Steering-related driver support features are not available if a fault is detected.

^[1] Such as lane keeping aid or Pilot Assist

^[2] If the problem persists, contact an authorised Volvo workshop.

8.7.1. Steering wheel

Get to know the steering wheel and some of its controls and features.

You can use your steering wheel for more than just steering the car.



Heated steering wheel

The steering wheel has built-in heating. The function can be turned on manually or set to automatic activation.

Adjust the steering wheel position

The steering wheel can be electronically adjusted to suit your driving posture. This is done in the centre display.

Steering wheel touch buttons

There are touch buttons on the steering wheel that can control certain settings and adjustments.

Horn

The button for the horn is located in the middle of the steering wheel and is indicated with the horn symbol .

8.7.1.1. Steering wheel controls

The steering wheel has several buttons and control surfaces. They control specific functions such as the horn, as well as certain settings, adjustments and what's shown in the driver display.



- Horn
- Touch-sensitive buttons
- Left-hand stalk
- Right-hand stalk

Touch-sensitive buttons



- ⏩ Increase set speed
- Decrease set speed
- ⊞ Alternate steering assist

- ☰ Switch between driver display views
- 🗣 Voice control
- ⬆ Increase volume or confirm
- ⬇ Decrease volume or decline
- ⏮ Media: Previous or rewind
- ⏭ Media: Next or fast forward
- 🌀 These buttons currently have no use^[1].
- 🌀 These buttons currently have no use^[1].

The buttons' functions change depending on the context and they typically control what's currently shown in the displays.

Interacting with the touch-sensitive buttons

The buttons on the right-hand side of the steering wheel often control what you see on the right-hand side of the driver display. The buttons on the left-hand side often control what you see on the left-hand side. The driver display typically shows which action each button corresponds to.

You can find the touch button zone you're looking for by moving your finger across the buttons. The displays react and show what the button's assigned behaviour or action is. When the function you want is indicated, press the button.

^[1] Buttons for a potential future function.

8.7.1.2. Adjusting the steering wheel position

You can adjust the steering wheel position to suit your driving posture. The steering wheel position you choose is stored as part of your user profile.

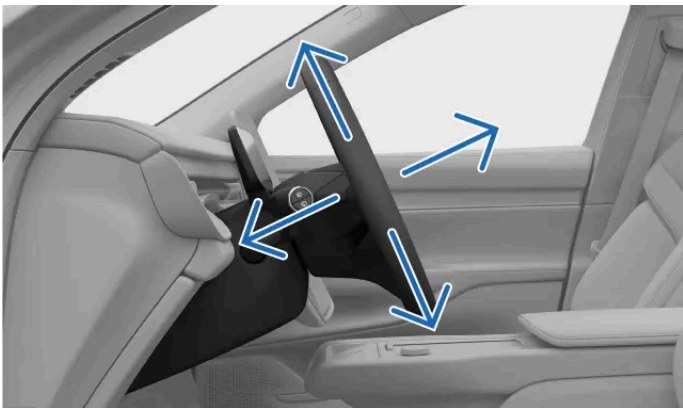

Adjusting the steering wheel position is fundamental to your driving posture, allowing you better comfort and control of the car.

The steering wheel adjustment view is accessed via the centre display. It guides you through the available settings to move the steering wheel to your preferred position.



Tip

Quick access

You can open the adjustments view using the seat adjustment knob on the side of your seat. There, you can make several adjustments related to your driving posture. You can also access certain driver adjustments in the quick controls view in the centre display. This allows you to make adjustments via the display but without heading into settings.



Warning

Make sure that you adjust your steering wheel position when you are parked as this should not be done whilst driving.



Important

Clear space around the driver display

Do not hang or place any objects on the steering column in front of or behind the driver display. You risk damaging the driver display if an object is placed there when the steering wheel position changes.

1. Press the car symbol  in the bottom bar and go to **Settings**.
 2. Go to **Controls** → **Steering wheel** → **Adjust steering wheel**.
- > The view for steering wheel adjustments appears.
3. Adjust the steering wheel position using the steering wheel buttons.



Important

Once you've finished adjusting the steering wheel position to your liking, it's important to make sure other parts of the car are aligned correctly. Your driving posture is important and is affected by more than your steering wheel adjustments, such as the position of your seat and mirrors.

8.7.2. Adjusting steering feel

You can adjust the steering wheel resistance and driving feel via settings.

A range of predefined settings are available to control the steering feel. These options are selected in the centre display.

Note

Your car has speed-dependent steering wheel resistance in addition to the manually adjusted steering feel. This means that your car automatically adjusts the steering wheel resistance in line with your driving speed, giving you enhanced control and stability.

1. Press the car symbol  in the bottom bar and go to **Settings**.
2. Go to **Driving** → **Driving dynamics** → **Steering feel**.
3. Select a steering feel setting.

8.8. Brakes

Your car has several types of braking functions, both manual and automatic.



Your car has several features and capabilities when it comes to braking.

Foot brake	Your main way of braking manually. Pressing the brake pedal may activate regenerative braking or engage the friction brakes, depending on the driving conditions.
One pedal drive	When One pedal drive is active, you control both braking and acceleration with the accelerator pedal.
Regenerative braking	Slows the car down by using the car's movement to charge the battery. ^[1]
Friction brakes	Slows the car down by engaging the disc brakes.
Parking brake	Keeps the car in place while parked.
Auto hold	Automatically applies the brake to hold the car when coming to a stop.
Automatic braking	This is a general term for the car's braking interventions. Several driver support and safety systems can intervene and perform braking manoeuvres for safety reasons or convenience.
Post-impact braking	Automatic braking after severe collisions to avoid further hazards.

Electronic stability control^[2]

Helps prevent skidding and other stability-related issues by automatically applying the brakes.

Anti-lock braking system^[3]

Prevents the brakes from locking up during hard braking. This improves the braking performance, stability and manoeuvrability of the car.

 **Important**

Brake wear indicators

Your car is equipped with electrical brake pad wear indicators that monitor the condition of the brake pads. When the brake pad thickness wears below the safe limit, the brake wear warning symbol appears in the driver display.

If the brake wear warning symbol appears, contact an authorised Volvo workshop to have the brake pads inspected and, if necessary, replaced. Driving with worn brake pads can compromise safety and damage the brake discs.

 **Note**

Brake lights

Your car's brake lights automatically light up during braking manoeuvres. The lights respond to manual braking from brake pedal use and One pedal drive, as well as automatic braking from any driver support system.

Emergency brake lights

During hard braking manoeuvres, or if the ABS system is activated, your car's emergency brake lights can activate. This causes the brake lights to flash to alert vehicles behind you. Your car's hazard warning lights can also be activated in these situations, but only after the car has slowed down to a speed below 10 km/h (6 mph).

^[1] Converts kinetic energy to electricity

^[2] ESC

^[3] ABS

8.8.1. Foot brake

The foot brake engages different types of braking mechanisms, depending on the situation.



The foot brake engages either regenerative braking or the friction brakes, depending on how hard you press the pedal. Light braking activates regenerative braking, whereas harder braking engages the friction brakes.

Electronically controlled braking ^[1]

The foot brake is electronically controlled. As the braking force is transmitted electronically rather than physically, there are no natural reaction forces travelling from the brakes to the pedal.

Anti-lock braking system ^[2]

The car's anti-lock braking system prevents the brakes from locking up during hard braking. This improves braking performance and manoeuvrability and helps with stabilising the car.

Note

P button

At high speeds, pressing and holding the P button slows the car down at a steady rate. This provides a backup alternative to braking normally. Only use the P button in this way if you are unable to brake using the brake pedal.

Start-up checks

Several brake systems are part of the car's start-up check. Make sure to resolve any indicated brake faults before driving.

Warning

Wet brakes

The car's stopping distance may be longer if the brake discs are wet. If they have been exposed to water, safely perform a braking manoeuvre to remove water from the brakes. By engaging the disc brakes while driving, they heat up and dry.

^[1] Also called brake-by-wire.

^[2] ABS

8.8.2. Parking brake

The parking brake engages when you transition from a driving gear to the car's parked state.

The parking brake locks the car's rear wheels. When parked, the car monitors and automatically tightens the grip if necessary.

By pressing the stalk button marked P, you put the car in park and the parking brake is engaged.^[1]

Your car will automatically engage the parking brake in several situations. These include:

- Your car has been stationary in auto hold for a longer period of time.
- You leave your car.
- A charging cable is connected to your car.
- At the end of an assisted parking manoeuvre.

The driver display indicates when the car is in park and the parking brake is engaged.

Warning

Avoid parking on a slope during winter conditions. The tyres might lose traction, even if the parking brake is engaged. You are always responsible for safe parking. Check the parking brake warning symbol for the parking brake status.



Automatic release

The parking brake releases automatically when you select a driving gear.

Note

P button

At high speeds, pressing and holding the P button slows the car down at a steady rate. This provides a backup alternative to braking normally. Only use the P button in this way if you are unable to brake using the brake pedal.

^[1] The car needs to be stationary to be put in park.

8.8.2.1. Engaging the parking brake

Engage the parking brake by pressing the button marked P on the right-hand steering wheel stalk.

Your car can automatically apply the parking brake in several situations. You can also apply the parking brake manually.

1. After coming to a stop, press the button marked P on the right-hand steering wheel stalk.



- > The car transitions to a parked state, which includes engaging the parking brake. The new state is indicated in the driver display.



The parking brake is automatically released when you select a driving gear.

8.8.3. Auto hold

Auto hold helps to keep the car stationary after coming to a full stop, allowing you to release the brake pedal.

When in gear D or R and the car comes to a full stop, auto hold will automatically activate if the necessary conditions are met.

To exit auto hold and continue driving in the selected gear, press the accelerator.

 **Note**

Transitioning from auto hold to parked

Your car will transition to P if auto hold is active for several minutes, if you unbuckle your seatbelt or if you open the driver door.

Auto hold conditions

Auto hold is available when you are in gear D or R. You must also have your seatbelt buckled and the driver door closed.

Auto hold is disabled when you are not using One pedal drive. By disabling One pedal drive you enable automatic creeping. You must then manually activate the hold function to keep your car stationary.

Manually activating hold

By pressing down hard on the brake pedal, you activate the hold function.^[1] This is indicated in the driver display with the hold symbol.



Hold symbol

^[1] Manually activating hold is available when you are using automatic creeping.

8.8.4. Post-impact braking

The car automatically applies the brakes when a severe collision is detected. This can reduce the risks associated with additional impacts.

In the moments after a collision, the car may still be moving at high speed. There is also a major risk that the driver is not in full control of the car, which could lead to additional impacts.

In the event of a severe collision^[1], automatic braking reduces your speed in a controlled manner, bringing the car to a halt. Reducing your speed is especially important if there are pedestrians, vehicles or objects in the car's path.

The brake lights and hazard warning lights activate during the manoeuvre. When the car comes to a stop, the hazard warning lights stay on and the parking brake activates.

 **Note**

Manual override

Pressing down on the accelerator overrides the braking manoeuvre, allowing the driver to select a safe place to stop.

Post-impact braking requires that the brake system is intact after the collision.

^[1] The severity of the collision must exceed a certain threshold for post-impact braking to activate. For example, if airbags have deployed.

8.9. Selecting gear

Select a gear with the right-hand side steering wheel stalk. The current gear is indicated in the driver display.

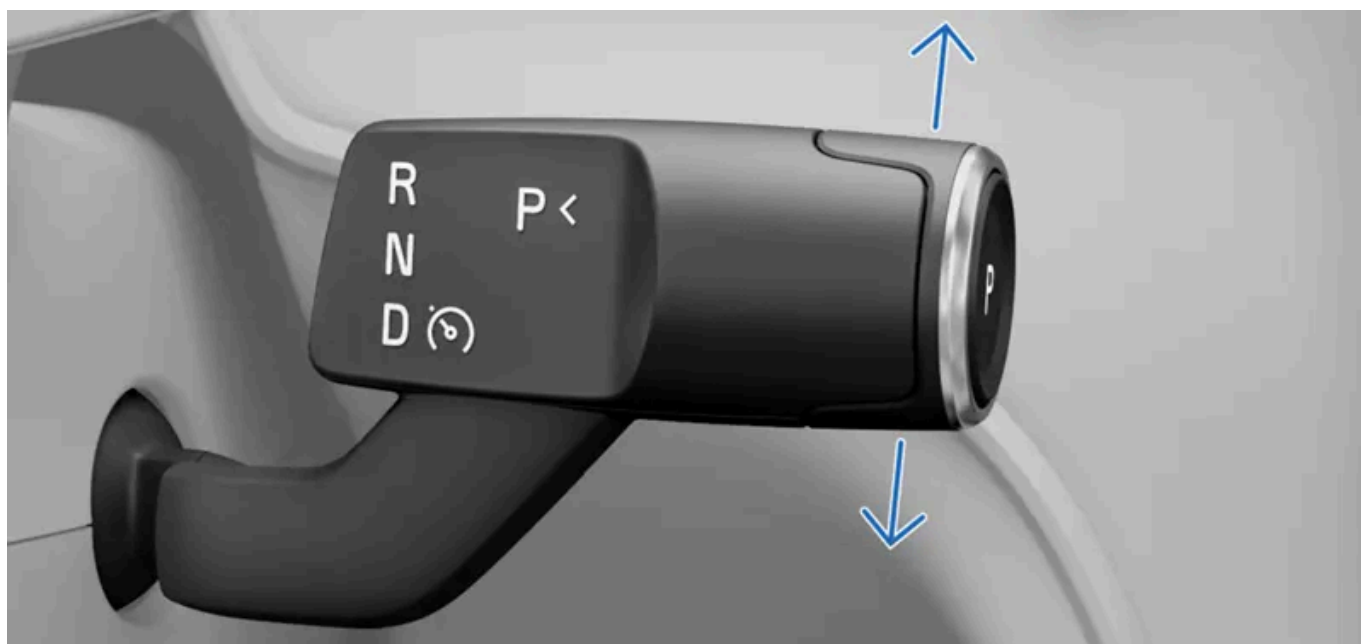

R Reverse

N Neutral

D Drive

In addition to gear selection, the right-hand stalk also controls the parking brake and certain driver support functions.

Changing gears is only possible when the car is stationary or when you are driving at walking pace. You can't change gears while charging your car.

1. Press the brake pedal^[1].
 2. Move the stalk up or down to select a gear.
- > Your selection is indicated in the driver display.

 **Note**

When moving the gear selector either up or down, you can feel that it has two positions in both directions. Select R by moving the gear selector all the way up. Move the selector all the way down to select D.

You can select the neutral gear, N, by moving the gear selector to the first position, in either direction, and holding it there for a couple of seconds. The stalk always returns to its middle position between gear selections.

^[1] only necessary if your car is stationary

9. Visibility, mirrors and exterior lights

Learn how to control your car's lights, mirrors and wipers for better visibility when the conditions call for it.



Your car is equipped with multiple features to assist you in your driving. Some are designed to improve safety, while others improve visibility. Some features are designed with both purposes in mind. Reading this section of the manual can assist in making your driving experience safer and more comfortable.

9.1. Exterior lights

Your car has a range of lighting capabilities. You can select and control the different lighting options in the centre display and on the left-hand steering wheel stalk.

 **Warning**

Car lights systems which are dependent on ambient light detection do not absolve the driver of responsibility for ensuring that proper lighting is used for all situations according to local laws and traffic regulations.

Exterior lights refers to all of the exterior illumination functions and features that affect visibility.

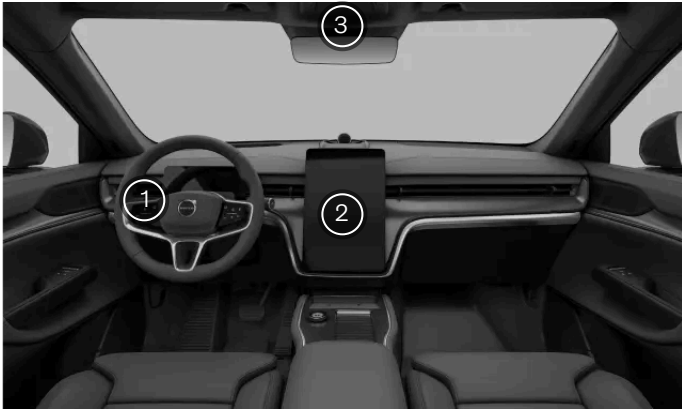

- ① You control certain driving lights, such as the high beam and the direction indicators, with the left-hand steering wheel stalk.
- ② You select primary lighting modes, additional driving lights and exterior convenience lights in the centre display.
- ③ The hazard warning lights button is located in the overhead console.

Some lighting features rely on the car's ability to sense that there are poor light conditions outside. Make sure that the car cameras are kept clean and are well-maintained. If the cameras' views are affected by dirt, they can't do their job properly. They need to be able to obtain enough information so that they can properly direct the car's responses.

i Note

Condensation

Exterior lighting may temporarily contain water from condensation. This is normal and all exterior lights are designed to withstand this. Condensation is normally vented out of the light housing after a period of time.

9.1.1. Driving lights



Driving lights mix automatic behaviours and manual controls which allow you to adapt to any situation or visibility conditions.

! Important

The driver is always responsible for ensuring that the car is driven while using a lights mode that is suitable for the current driving conditions and local traffic regulations.

Primary lighting

You can choose between several different primary lighting modes in the centre display. Your selection sets a standard lighting behaviour.

Auto	Auto	The automatic lights mode ^[1] allows your car to automatically detect and calculate which lighting mode is most suitable for the driving and environmental lighting conditions.
	Weather light	You can use the weather light in foggy or severe weather conditions. The weather light gives you greater visibility and helps your car to be seen by others.
	Passing beam	You can manually select the passing beam to keep the front lights dipped.
	Position lights	The position lights are points of illumination around the car that make it more visible to other road users when your car is stationary. ^[2]
Off	Off	Off deactivates all primary lighting modes. ^[3]

 **Note**

Lighting mode availability

Some primary lighting modes can only be used under certain conditions, such as while driving or when your car is turned off.

Adaptive features

In the automatic lights mode, additional light features are enabled to help you adapt to changing driving conditions. This can be helpful in low lighting and when entering tunnels.

Additional lights

You can control the high beam and the direction indicators with the left-hand steering wheel stalk.

The hazard warning lights help you to warn others of potential risks. You can turn them on or off by pressing the button in the display or the overhead console.

There are additional light settings available in the centre display, such as:

Rear fog light	The rear fog light warns traffic behind you of your presence in poor light conditions.
Adapt lights for left-hand traffic	If you are travelling to a region which drives on the opposite side of the road to your own, you can change the orientation of the lights to avoid blinding other drivers.

Auto-levelling

Auto-levelling automatically adjusts the vertical alignment of the passing beam to maintain good visibility and avoid dazzling other road users.

^[1] Auto

^[2] The position lights can vary in different markets and regions.

^[3] Off cannot be selected when the car is in drive.

9.1.1.1. Selecting a primary lighting mode

You can select a primary lighting mode via the centre display.

The primary lighting mode sets the car's standard lighting behaviour. In certain lighting modes, you can activate or enable additional features to help you adapt to the driving conditions.

Note

Some primary lighting modes can only be used under certain conditions, such as while driving or when your car is turned off.

1. Press the car symbol  in the bottom bar and go to **Settings**.
2. Go to **Controls** → **Lights and displays** → **Exterior lights** → **Primary lighting**.
3. Select a primary lighting mode.

The primary lighting mode will reset to automatic^[1] between drives.

^[1] Auto

9.1.1.2. High beam

The high beam is important for your driving visibility. There are different states you can use to suit your needs.

Important

Remember that your ability to see the road properly in low lighting conditions is important not just for your own safety, but for other road users and pedestrians too.

The high beam is more powerful and has a longer reach of illumination than the passing beam. To use the high beam, you must first select the automatic or passing beam primary lighting mode.

You can choose between manual and automatic high beam. However, automatic high beam is only available in the automatic lights mode^[1] and only activates in low lighting conditions.

Automatic high beam

When enabled, the automatic high beam automatically adapts the beam pattern to surrounding traffic to avoid dazzling other road users.

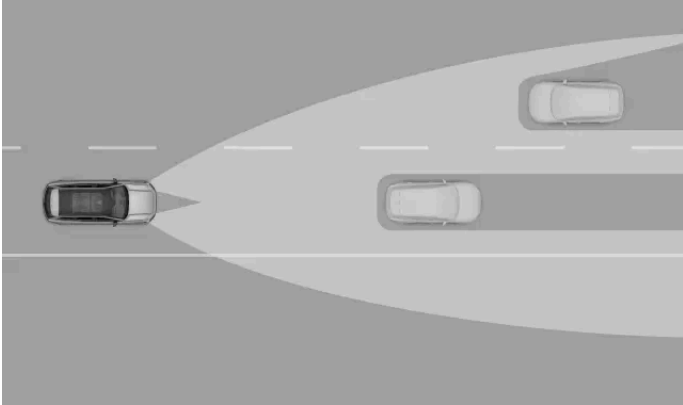

The automatic high beam's adaptive capabilities

Note

The automatic high beam only activates at speeds over approximately 20 km/h (12 mph) and in low light.

You can use the left-hand steering wheel stalk to switch between the manual high beam and the automatic high beam. There are symbols in the driver display that show which high beam setting is currently active. These include:



The manual high beam is active.



The automatic high beam is enabled but not active.^[2]



The automatic high beam is active and the lights are turned on.

Adaptive motorway light

The adaptive motorway light is part of the automatic high beam system. If you are driving at high speeds on the motorway, the adaptive motorway light adapts the beam pattern on the passenger's side of the road to surrounding traffic. The high beam on the driver's side automatically switches to passing beam if any traffic is detected.

Important

Make sure that the car cameras are well-maintained and kept clean. If the cameras' views are obscured by dirt, they will not be able to obtain enough information to properly direct the car's lighting responses.

^[1] Auto

^[2] Depending on the car's current theme, this symbol can be a different colour.

9.1.1.2.1. Operating the high beam

You can control the high beam using the left-hand steering wheel stalk.

There are several different high beam options you can choose from to suit the driving conditions.

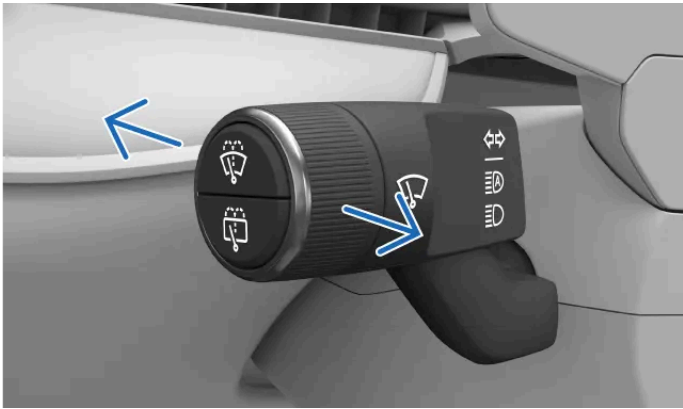

You can move the left-hand stalk forwards or backwards to switch between the different high beam options. The stalk always springs back to the neutral position.

The options available are:

- Automatic high beam
- Manual high beam
- High beam flash

Note

Primary lighting modes

When you are in the automatic primary lighting mode, the high beam becomes part of the adaptive front-light system and works in different ways depending on the outside light conditions. You can enable the automatic high beam in all lighting conditions, but both the automatic and manual high beam can only be activated in low light.

When passing beam is selected as the primary lighting mode, you can only activate the manual high beam.

The default lights setting is automatic^[1] with the automatic high beam enabled.

Enabling or activating the high beam

- When the high beam is turned off, push the stalk once to enable the automatic high beam or activate the manual high beam.

Deactivating the high beam

- Pull the stalk fully to turn the high beam off.

Flashing the high beam

- A short pull of the stalk activates the high beam flash.

Switching between manual and automatic high beam

- When the automatic primary lighting mode is selected and the high beam is activated, push the stalk once to switch between the automatic high beam and the manual high beam.

Note

If you deactivate the high beam, turning it back on during the same drive activates or enables the high beam option you last used.

The lights settings reset to their default values between drives.

Important

Make sure that the car cameras are well-maintained and kept clean. If the cameras' views are obscured by dirt, they will not be able to obtain enough information to properly direct the car's lighting responses.

[1] Auto

9.1.1.3. Operating the direction indicators

Use the direction indicators to communicate how you intend to manoeuvre your car. The controls are located on the left-hand steering wheel stalk.

The indicators have two types of activation – quick and standard. While the indicators are blinking, you will hear a ticking sound and see a direction indicator symbol in the driver display.



You can control the indicators using the left-hand stalk

Quick indication

- Move the left-hand steering wheel stalk slightly up or down and allow it to spring back to the middle.

- > The indicators blink three times before turning off.

Standard indication

- Move the left-hand steering wheel stalk up to turn the right indicator on and down to turn the left direction indicator on.
- > The stalk moves back to its original position and the indicators turn off when you straighten the steering wheel out after turning.

i Note

You can cancel the direction indicators by moving the left-hand steering wheel stalk slightly up or down in the opposite direction.

i Note

Indicator malfunction

In the event of any malfunction or damage to the direction indicators, the sound and the flashing indicator symbol will be twice as fast as normal and the malfunction symbol  appears in the driver display.

9.1.1.4. Adaptive passing beam

The adaptive passing beam reduces the risk of dazzling other road users.

The adaptive passing beam is part of the automatic primary lighting mode^[1]. When enabled, the adaptive passing beam acts as part of the adaptive front-light system and automatically adjusts to the driving conditions.

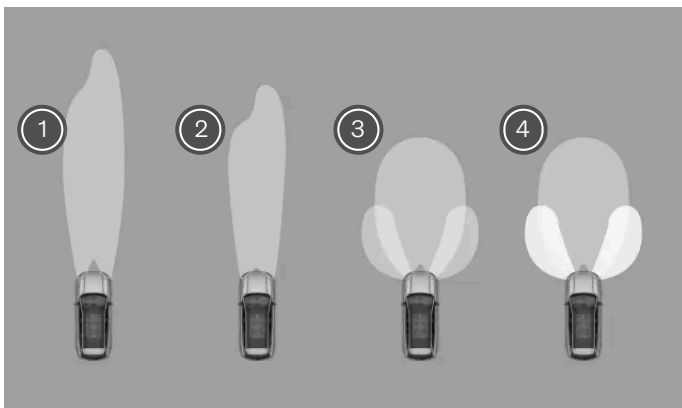

The passing beam has four automatic beam types

- ① Motorway lights give you the longest range of the passing beam modes.
- ② Country lights have a medium range and spread compared to the other two lights modes.
- ③ Town lights use a wide beam that lights up the area close to the car, with additional lights at the sides. They are designed to give good visibility with minimal disturbance to other road users.

¹ The content of this manual represents the status of the user manual at the time of printing and may not be completely valid in future instances. For more information, refer to the first page for the complete disclaimer note.

- ④ Reverse town lights use a similar wide beam pattern to town lights, but only activate when the car is in reverse.

! Important

Manual passing beam

The manual passing beam keeps the front lights dipped. You can enable it by selecting passing beam as your primary lighting mode.

[1] Auto

9.1.1.5. Cornering lights

The automatic cornering lights improve visibility in the immediate vicinity of the car.

When the passing beam is active, cornering lights trigger when driving at low speeds in poor lighting conditions.

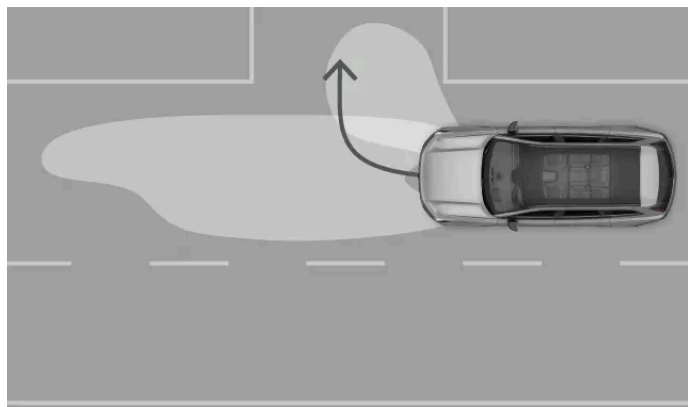

The cornering lights illuminate the area close to the car to give you better visibility when turning.

i Note

When turning without using the indicators, only the light on the side you are turning towards will illuminate.

9.1.1.6. Static bending lights

The static bending lights automatically activate when you turn your car. This is to improve the visibility of the immediate area around the car.

When either the automatic lights mode or the high beam is active in low lighting conditions, static bending lights trigger when

you turn to give you better visibility of the road you are turning into.

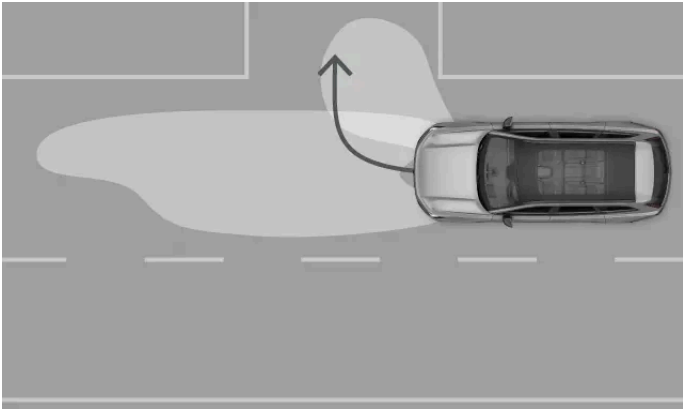

The static bending lights trigger when turning



Note

When a direction indicator is turned on while driving straight ahead, the static bending lights activate on both sides of the car. Once you begin turning, only the light on the side you are steering towards illuminates.

9.1.1.7. Activating the rear fog light

The rear fog light is designed to warn traffic behind you of your presence in bad weather with poor light conditions.

The rear fog light needs to be manually activated in the centre display.

1. Press the car symbol  in the bottom bar and go to **Settings**.
2. Go to **Controls** → **Lights and displays** → **Exterior lights** → **Rear fog light**.
3. Turn it on or off by pressing the fog light symbol .

9.1.1.8. Hazard warning lights

If there is a potential risk to surrounding traffic, you should turn the hazard warning lights on. This helps to alert other road users of the need for greater awareness.

 **Important**

It is the driver's responsibility to use hazard warning lights according to local laws and traffic regulations.

The hazard warning lights button is located in the overhead console. You can also access the lights in the bottom bar in the centre display.



The location of the hazard lights button in the overhead console



The location of the hazard lights button in the centre display

The status and interaction points to control the hazard warning lights are signified by the associated symbol.



Automatic activation

The hazard warning lights turn on automatically when the emergency brake lights are triggered due to sudden braking.

You can turn the hazard lights off with the button in the overhead console or let them turn off automatically when you begin driving again.

In the event of a collision

Your hazard warning lights will automatically turn on in the event of a collision.^[1]

There is a cool-down period which disables the option to turn the hazard warning lights off. When you can manually deactivate the lights and use them as normal again, the hazard warning lights button begins flashing.

^[1] This is dependent on local regulations and regional standards.

9.1.1.8.1. Activating the hazard warning lights

The hazard warning lights are essential for driving safety. Be sure that you know how to work them.



Hazard warning lights symbol

When you get into the car, the hazard warning lights button in the overhead console lights up, showing that you can use it. There's also a button located in the bottom bar in the centre display.

1. Press the hazard warning lights button, either in the overhead console or the centre display.
- > The hazard warning lights buttons flash simultaneously in the same rhythm as the lights. If you're driving, both of the indicator symbols in the driver display also flash and you will hear a ticking sound.

9.1.1.9. Re-orientating lights to local traffic

If you visit a region with a different driver's side to your own, you can change the orientation of the lights in settings.

When you re-orientate the lights to local traffic, the lights adjust to reduce glare and avoid dazzling other road users.

Selecting the orientation of the lights

1. Press the car symbol  in the bottom bar and go to **Settings**.
 2. Go to **Controls** → **Lights and displays** → **Exterior lights** → **Adapt lights for left-hand traffic**.
 3. Re-orientate the lights by pressing on or off.
- > A notification appears in the driver display.

 **Note**

When your lights are re-orientated to local traffic, some functions will be disabled. However, you will not see a difference in the beam pattern.

 **Important**

Until deselected, the lights remain re-orientated each time you start a new drive. Remember to deactivate it when you no longer need to change the orientation of the lights.

9.1.2. Exterior convenience lights

There are lighting functions available that make it easier to see when you are outside your car.

Greeting lights

The greeting lights display a short lights sequence and help you see your surroundings better as you lock or unlock your car. You can also enable the greeting lights to trigger when you approach or leave your car with a distance-capable key. This can be enabled in settings.

9.1.2.1. Enabling the greeting lights

The greeting lights help you see the surrounding area of your car.

You can enable the greeting lights to trigger as you approach or leave your car with a distance-capable key. If this setting is disabled or you are not using a distance-capable key, the greeting lights are triggered when you lock or unlock your car.

When the greeting lights setting is enabled, an additional light sequence will also be triggered.

1. Press the car symbol  in the bottom bar and go to **Settings**.
2. Go to **Controls** → **Locking** → **Approaching and leaving** → **Greeting lights**.
3. Turn the greeting lights on or off.

The greeting lights setting stays active until you disable it.

9.2. Mirrors

The rear-view mirror and the two wing mirrors are important for your driving awareness. Make sure that you adjust the mirrors to your needs before driving.

Rear-view mirror

You can adjust the interior rear-view mirror by moving it manually.

Wing mirrors

You can adjust the wing mirrors' positions via settings and the buttons on the right-hand side of the steering wheel. Wing mirror positions are automatically saved to the user profile.

The wing mirrors are heated to prevent ice and frost from impeding visibility.

To fold the mirrors inwards, go to settings. It's useful to do this when parked. You can also set the wing mirrors to automatically fold and unfold when you lock or unlock the car.

Note

Alerts about vehicles in blind spots

The wing mirrors have lights on them to give you greater driving awareness. They activate when vehicles are detected in or are approaching the blind spots.

Warning

The wing mirrors are curved to improve visibility. Objects may appear to be further away than they actually are.

Note

Automatic dimming

Automatic dimming can reduce the glare from strong lights in the wing mirror on the driver's side and the rear-view mirror. Auto dimming is triggered only when poor light conditions are detected outside the car. Auto dimming deactivates when reversing.

9.2.1. Adjusting wing mirrors

Before you start driving, make sure that the wing mirrors are in positions that give you good visibility.

Adjusting the wing mirrors is an important part of the driver adjustments and is fundamental to your driving posture, allowing you better visibility and control of the car.

1. Press the car symbol  in the bottom bar and go to **Settings**.
2. Go to **Controls** → **Mirrors and wipers** → **Side mirrors**.
- > The adjustment settings view appears.
3. Select the wing mirror you want to adjust.
4. Use the steering wheel buttons to adjust the selected mirror.

 **Important**

Adjustments for driving posture

Once you've finished adjusting the wing mirrors to your liking, it's important to make sure other parts of the car are aligned correctly. Your driving posture is important and is affected by more than your wing mirror adjustments, such as the position of your seat and steering wheel.

Only adjust the mirrors via the centre display

You can only adjust the wing mirrors via the centre display. It is not recommended to adjust the mirrors by hand as this might break them.

 **Tip**

Quick access to adjustment settings view

You can make several adjustments related to your driving posture in the adjustment settings view. To access this view without using the centre display, just use the seat adjustment knob on the side of your seat. You can also access certain driver adjustments in the quick controls view via the centre display. This allows you to make adjustments without going into settings.

Folding and unfolding wing mirrors

You can fold and unfold the wing mirrors in the **Mirrors and wipers** view. This can be useful to do when you are parking or driving in narrow spaces. You can also set the mirrors to automatically fold and unfold when you lock or unlock the car in the **Locking** view.

9.3. Wipers and washers

The wipers and washers work together to keep the windscreens clean and clear.

 **Important**

Before activating the wipers, ensure that the wiper blades are not frozen in place and that any snow or ice on the windscreens is removed.

Wiper and washer controls



You can control the wipers and washers using the scroll wheel and buttons on the left-hand steering wheel stalk.



Front wipers and washers



Rear wiper and washer

Washers

The washer nozzles are integrated into the wiper arms for efficient washer fluid distribution.

When the windscreen washers and headlights are on at the same time, the headlights are washed automatically. If the washer fluid level is low, the headlights washers only work when either the high beam or passing beam are on. This is to keep the windscreen washers active for as long as possible.

Your car tells you when it's time to refill the washer fluid. When washer fluid is running low, a message appears in the centre display.

Front wiper modes

The front wipers have an automatic mode as well as multiple manual speeds. Each wiper mode sets a different speed for the wiper movements, so you need to select the appropriate mode for the conditions you are driving in. You can see the current wiper mode in the driver display. Between drives, the car resets to automatic mode by default.

When automatic mode is active, the car uses information from its rain sensor to activate the wipers and control their speed. You can change the rain sensor sensitivity in settings. When the rain sensor is active, you can see a symbol in the driver display.



Active rain sensor symbol

Rear wiper

The content of this manual represents the status of the user manual at the time of printing and may not be completely valid in future instances. For more information, refer to the first page for the complete disclaimer note.

Use the left-hand steering wheel stalk to manually turn the rear wiper on or off.

The rear wiper automatically activates if the front windscreen wipers are active while you are reversing. If you change gear, the rear wiper will stop wiping the rear windscreen. In low temperatures, the rear wiper won't automatically activate while you are reversing.

 **Important**

Maintenance, refilling and replacing

- Clean the wiper blades regularly.
- Replace the wiper blades if they show signs of wear.
- Refill washer fluid when your car tells you to.
- Avoid using the wipers without lubrication from either rain or washer fluid. It can cause wear or damage.

Car wash safety

Turn the automatic wiper mode off when you enter a car wash. Otherwise, the rain sensor will cause the wipers to activate, which could lead to damage.

9.3.1. Controlling front wipers

You can manually activate the windscreen wipers or change the way they work. When the car detects rain in automatic mode, the wipers will activate.



There are different front wiper modes that you can activate by using the left-hand stalk. The modes are:

- II** High
- I** Low
- Auto** Automatic mode using rain sensor
- Off** Wipers are turned off

Single wipe

1. Press once quickly on the upper button on the end of the left-hand steering wheel stalk.



- > The wipers will swipe once across the front windscreen.

Changing wiper mode

2. Rotate the scroll wheel on the end of the left-hand steering wheel stalk.

- > The wiper menu appears in the driver display, allowing you to scroll through the wiper modes. The currently selected mode is also highlighted.

9.3.2. Controlling rear wiper

The rear wiper can be manually turned on and off. It also automatically activates if the front windscreen wipers are active while you are reversing.



Turning on and off

1. Press once quickly on the lower button on the end of the left-hand steering wheel stalk.



- > Rear windscreen interval wiping turns on or off. The current state is shown in the driver display.

2. Press the button again to turn the rear wiper off.



Tip

Activate when reversing

If the front wipers are active, the rear wiper will automatically activate while you are reversing. It automatically turns off when you change gear. The rear wiper will not activate in low temperatures.

9.3.3. Activating washers

Activate the front or rear windscreen washers using the buttons on the left-hand steering wheel stalk.



- Press and hold the button on the left-hand steering wheel stalk for the washers you want to activate. The front washers are activated by the upper button and the rear washer is activated by the lower button.



Front wipers and washers symbol



Rear wiper and washer symbol

- > The washers and wipers work together to distribute washer fluid across the windscreen. When you release the button, the wipers make a few more passes to wipe away excess fluid.

10. Driver support and navigation

Driver support features are designed to improve safety, comfort and convenience when you are using your car. They assist you with your driving, route-planning and decision-making on the road.



The collection of driver support features in this car can assist you in driving, navigating and parking. Some are exclusively designed to improve safety, others convenience. Some features are designed with both purposes in mind.

When used correctly, driver support features can reduce the effort of driving, help reduce distractions and improve safety for you and others. They often take advantage of the car's ability to monitor and keep track of its surroundings. Some features deliver that information to you for increased driver awareness, while other features provide fast reactions to hazards identified by the car.

10.1. Navigation

Use the Google Maps navigation app to get directions and traffic information as well as find the nearest charging station.

When the car is connected to the internet, it can continuously download map and traffic information to help you navigate to a destination. Navigation guidance can appear in the car's displays.

The car knows its location through GPS and shows it in the map views in the car's displays.

Navigation app



Google Maps symbol

Note

Latest app version

Be sure to update the app whenever there's a new version available. Functionality and support for old versions may vary.

Connected navigation features

Whenever your car is connected to the internet, it can get the latest navigation information.

Real-time traffic information	You can get real-time traffic information if the car is connected to the internet. For example, you can see if traffic is moving slowly. Different coloured lines that correspond to traffic situations will appear on your chosen map route. If the internet connection is lost, the lines disappear after a while. You also get information about traffic conditions along the chosen route, such as roadworks or accidents.
Alternative routes and redirected traffic	When you set a destination in the navigation app, the fastest route is suggested while also taking your navigation settings into account. For example, you can choose to avoid tolls or ferries. The chosen route can be redirected while you are driving, such as when there is an accident or a traffic condition that affects your travelling time.
Sharing information with other devices	Link your Google account to an active user profile to get the same Google Maps information in your car as on your other devices. Destinations saved to your Google account using other devices, such as home, work, favourites and last searches, are then also available in your car.

Offline maps

When you are connected to the internet, you can download map areas so that they are available in the car even if your car has poor reception or no internet connection. This feature is available in Google Maps' settings.

Displayed information

When a route is added, the following travel information about the trip is shown in the centre display:

- Travel time
- Distance to the next destination on your route, such as an extra stop
- Estimated time of arrival
- The name of the next destination on your route
- Estimated state of charge when reaching the destination

Depending on the selected display mode, the driver display shows different amounts of map and guidance information.

Navigation settings

You can change the navigation settings in the navigation app.

 **Warning**

Avoid driver distraction

Avoid any interaction with the car's system or other devices that may distract you from driving safely. Any task that does not allow you to keep your attention on the road and surrounding traffic should be performed when the car is parked.

 **Note**

Navigation limitations

- The navigation feature is from a third-party supplier. Availability, procedure and functionality may vary over time and depend on region.
- Navigation instructions can sometimes be less reliable than usual due to factors such as weather or road conditions.

Poor or no internet connection

The navigation app can have trouble finding a route or signal when you are in a location which can interfere with your internet connection, such as a tunnel or multi-storey car park.

 **Tip**

Range and charging

There are features in navigation that can help you plan your trip based on charging stations, estimated charging time, estimated battery level upon arrival and range.

10.1.1. Finding and selecting a navigation destination

Find your destination using the search field or a voice command. The car then suggests routes for you to choose from.

1. Press the app library symbol  in the bottom bar and open Google Maps.
2. Enter an address or destination in the search field.
 - > A route is suggested along with alternative routes.
3. Select your preferred route.
4. Select start.
 - > Navigation instructions start.

10.2. Detection of surroundings and traffic

This section covers the essentials of how cameras, radars and other sensors work, including their limitations. Understanding how your car perceives its surroundings can help you use features that rely on this capability.

Your car's ability to understand its surroundings is achieved through many systems and types of sensors. The car's interpretation of the data it collects helps inform its behaviour, especially for driver support features.

Cameras	Cameras work similarly to the human eye. What they capture is used for different purposes, which depends on the camera. For example, the upper front-facing camera helps the car identify things such as traffic signs and road markings, whereas what the rear parking camera captures appears in the centre display.
Radars	Radars use radio waves to collect information about the car's surroundings. They can identify the distance to objects and certain aspects of their movement. This information is essential for many features in the car.
Ultrasonic parking sensors	These sensors use sound waves to detect relatively close objects. They work by sending out ultrasound pulses that can bounce back to the sensors when they encounter an object.

How systems work together

The different detection types complement each other. They are sometimes used on their own and sometimes together.

Important

Even when used together, these detection systems cannot handle all conditions and traffic situations. This is why it's important for the driver to never rely fully on driver support features. Always be attentive to conditions and situations where driver support feature performance is affected by the features' limitations.

General detection and identification limitations

Each type of detection has its own set of limitations, but there are a few general things to consider as well.

- The car can't always handle unpredictable or strange situations. When the car finds it difficult to correctly identify the environment or traffic situation, the accuracy of its response is affected.
- Damage to the car can affect detection and features that use it. Many faults can be identified by the car, but some may not be possible to self-identify. This is why it's important to make sure that the car is in good condition and working order. Contact an authorised Volvo workshop if you suspect there is any fault or if you notice damage to the car.
- Limiting factors and conditions can, and frequently do, coincide. They can compound and interact in ways that amount to an incorrect response from the car.

Obstacle detection limitations

Obstacle detection helps the car identify certain stationary and moving objects. They can be other road users, such as pedestrians or other vehicles, animals, barriers or other objects. If they are in or close to the car's driving path, they could pose a collision risk. Depending on the circumstances, the car might be able to warn or intervene if the object is accurately identified. For all types of objects the car can identify, there are many factors that can prevent accurate identification. Examples of limiting factors, situations and events include:

- Closely spaced, overlapping or partially blocked objects and road users.
- Objects and road users that blend in with the background.

The content of this manual represents the status of the user manual at the time of printing and may not be completely valid in future instances. For more information, refer to the first page for the complete disclaimer note.

- Objects and road users that move or accelerate particularly fast.
- Uncommon vehicles, such as recumbent bicycles, combine harvesters or trailers with oddly shaped loads.
- Bicycles of a different type or size compared to a regular adult bicycle.
- New modes of transportation.
- Clothing or carried objects that alter the silhouette of a pedestrian.
- Pedestrians shorter than 80 cm (32 inches).
- Obstacles angled in ways that create an unknown silhouette.
- Size and speed of animals. Cats and dogs are often too small to reliably identify.

Note

Traffic detection examples

Examples of different traffic scenarios can help you understand some of the limitations of your car's detection systems. Real-world scenarios are often more complex than the illustrative^[1] examples in this manual.

Out of view and late detection

The various detection zones around your car are static, each with a limited range and field of view. If something enters a detection zone at an unusual angle, at high speed or very close to your car, it can cause a rapid response. This reduces safety margins compared to a situation in which earlier detection was possible.

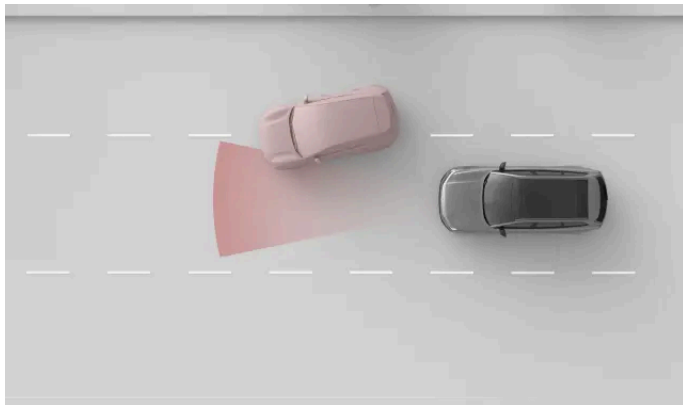

The front radar's detection zone has a limited width. If you get cut off by another vehicle, detection can occur relatively late causing a sudden response by your car.

Important

Lane placement and small vehicles

For forward detection, the middle of the lane is more favourable compared to its outer parts. Vehicles can go undetected if they don't occupy the middle of the lane. While this can happen for any vehicle, the risk is higher for small ones, such as motorcycles. They take up less of the lane's width and can move about more within the lane. Always pay extra attention to any vehicle not driving in the middle of the lane.

Shape, size and number of objects

Detection can be less reliable depending on the shape, size and number of objects in a detection zone. Identifying the distance to the closest vehicle ahead can become less accurate depending on these factors, especially if they are compounded.

- Small objects are harder to identify.
- The more objects, the harder it is to identify individual ones.
- Objects close together that overlap are harder to identify.
- Objects with non-uniform shapes, such as having overhangs or parts that stick out, are harder to identify.

The presence of a large vehicle in front can make it difficult to identify a smaller one, such as a motorcycle.

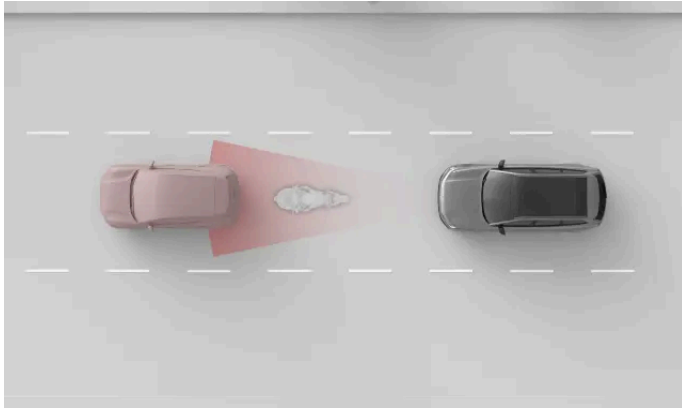

The smaller motorcycle and the car are close to each other and overlap, making detection of the motorcycle less accurate.

! Important

Trailer in front

Compared to many other vehicles on the road, the detection of trailers is often less reliable due to their shape and height. This applies, in particular, to slim trailers, low trailers and trailers with very high loading beds. These types of trailers often don't have enough surface area at the height where forward detection systems focus.

Road and infrastructure

Bends in the road can cause the car to misinterpret the traffic situation. For example, it can lose track of a vehicle or misidentify which lane a vehicle ahead is in.

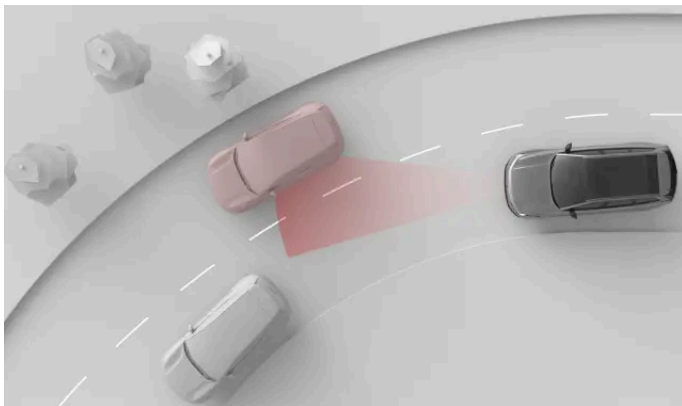

In a bend, the car ahead may slip out of the detection zone. Cars in the adjacent lane may also enter the zone, affecting your car's perception of the distance to traffic ahead.

 **Important**

Road condition and irregularities

Both common and uncommon road features can impact the effectiveness of the car's detection systems.

- Sharp bends and bumps in the road can temporarily obscure important parts of the car's surroundings, such as other vehicles or road markings.
- Non-standard or unusual road infrastructure might not be correctly identified by the car. For example, road work or traffic diversions can result in conflicting or multiple sets of road markings.
- Worn road markings or signs might not be correctly identified.

^[1] The representations of detection systems and the car's surroundings are not to scale.

10.2.1. Locations of cameras, sensors and radars

Knowing the placement of different components the car uses to map its surroundings helps you keep them free of dirt, obstructions and accidental damage.

Many of your car's driver support features rely on data from components that scan and map your car's surroundings, such as cameras, sensors and radars. This section doesn't show all components and their precise locations, but it gives you a general idea of where they are. Areas pointed out in this section are particularly important to keep clean. Damage to these areas can also affect functions that rely on components located there.

 **Warning**

Clean regularly

Camera, radar and other sensor areas on the car must be cleaned on a regular basis and kept free from labels, objects, dirt and other potential obstructions. Otherwise, car functions may respond incorrectly or become less responsive or deactivated.

Be careful when cleaning the area next to a camera to avoid scratching the lens.

Scraping the windscreen

The windscreen area in front of the front-facing camera has its own heating to defrost and remove any build-up of snow or ice. Do not use an ice scraper on this area as it can scratch the glass surface. Scratches or damage to the glass in front of the camera can interfere with or limit its detection capabilities.

Mounted accessories

Be mindful of the effects of mounted car accessories such as load carriers or exterior light accessories. The items themselves or the load you add may obstruct cameras, sensors or radars.



- ① The top-centre of the windscreen houses a front-facing camera.
- ② The side-view cameras are located on the wing mirrors, which also house rear-view cameras.
- ③ There is a camera and a radar in the emblem area in the front of the car.
- ④ The front of the car also has a radar in each corner.



- ⑤ There is a rear-view camera in the rear centre of the car.
- ⑥ The rear of the car also has a radar in each corner.

The content of this manual represents the status of the user manual at the time of printing and may not be completely valid in future instances. For more information, refer to the first page for the complete disclaimer note.



Tip

Finding the parking sensors

There are multiple ultrasonic parking sensors along the lower edge of your car. You can see their exact locations by looking for their button-like cover plates along the bumper panel.



Important

Cleaning in front of radars

If you find dirt, snow or ice, or if the car indicates that a radar is blocked, you should address it as soon as possible. Always clean and clear a large area around the radars to make their full field of view available.

10.2.2. Camera detection and limitations

The car's cameras capture the surroundings in a similar way to the human eye. This comparison is useful for understanding their capabilities and limitations.

Cameras help the car identify certain objects and surfaces that visually stand out against their backgrounds. This includes things such as road markings, traffic signs, pedestrians and other vehicles.

Camera information in the parking view can provide you with an additional way to monitor the car's surroundings.

Light conditions

Cameras need light to work and are affected by light conditions.

- Strong light sources, such as the sun, can cause glare and reflections that negatively affect camera detection.
- Low light can negatively affect certain types of camera detection.
- Some detection types require low-light conditions. When it's dark, the lights from other vehicles can be identified as they stand out against the background.



Important

Camera detection in darkness

For the car to be able to identify other vehicles when it is dark, the other vehicles must have their headlights and rear lights turned on and be clearly visible. While the car uses other types of detection as well, such as radar, it may not have enough information to reliably identify vehicles that are not seen by the cameras. Several driver support features can be affected by this, such as safety interventions, collision warnings and features that provide distance-keeping.

Visibility

Poor visibility for the driver typically means poor visibility for the cameras. Objects that are hard to detect for the human eye can sometimes be hard to detect for the cameras as well. This can include well-camouflaged objects or objects where the outlines don't stand out against the background.

- Fog, heavy rain, snow or dust storms can severely limit visibility for the cameras.
- Beware of dust, water or snow on the ground that may be disturbed and kicked up into the air by your car, other traffic or the wind.

Field of view and obstructions

Cameras see in the direction they're facing and only within their field of view. The field of view differs for each camera and depends on their intended purpose.

Obstructions limit what the camera sees. Each camera views the surroundings from where it's mounted, and anything that enters its field of view blocks what's behind the obstruction. Objects close to a camera will block more of the camera's field of view than objects that are further away. If the car detects that a camera is blocked, it can disable certain features that rely on that camera.

- Make sure that any mounted accessories, extra equipment or externally-stowed cargo don't block part of the cameras' fields of view. For example, far-extending roof loads may block part of the top view for front- and rear-facing cameras.
- Trailers, bike racks or other towbar-mounted equipment can block the rear camera view.
- Dirt, ice, snow, water droplets and condensation on camera lenses obstruct the cameras' view to some extent. In some cases, the car may be able to identify that something is in the way and notify you. However, it is still recommended to regularly inspect the cameras and make sure that they are clean and unobstructed.



Warning

Clean regularly

Camera, radar and other sensor areas on the car must be cleaned on a regular basis and kept free from labels, objects, dirt and other potential obstructions. Otherwise, car functions may respond incorrectly or become less responsive or deactivated.

Other limitations

If the cameras become too hot, they can be temporarily switched off to protect them from damage. This can happen when starting the car after being parked in high temperatures in combination with direct sunlight hitting a camera. The camera can become available again once it has sufficiently cooled down.

 **Important**

Windscreen damage

Windscreen damage in the camera area, including small chips, scratches or cracks, can negatively affect performance of the camera and features that use it. This can cause reduced functionality, unreliable responses from the car and disabling of features. If damage occurs, follow this manual's separate recommendations for handling windscreen damage.

Camera calibration

After replacing your car's cameras or any of the surrounding parts, such as the windscreen, wing mirrors or front bumper, the cameras might take a while to recalibrate themselves. This can lead to some driver support features being unavailable for a short time after having the car serviced. The calibration may be prolonged if it takes place during poor lighting conditions. You can find messages about ongoing camera calibration in the driver display.

10.2.3. Radar detection and limitations

Radars use radio waves to collect information about the car's surroundings. They can identify the distance to objects and certain aspects of their movement. It's important not to block the radars.

There are several radars aimed in different directions to collect information about the car's surroundings. This information is primarily used by driver support features in the car. Radio waves are continuously sent out and bounce back if they encounter an object in their path. As the waves return, the car can calculate the position and motion of the object, for example.

Radars are unaffected by the light conditions, working equally well on a sunny day as in complete darkness.

 **Important**

Use responsibly

Radars and features that rely on them are supplements to safe driving practices. They do not reduce or replace the need for the driver to stay attentive and focused on driving safely.

Detection zone and field of view

Each radar in the car has its own detection zone. The zone is limited by the radar's field of view and range.

Objects in the field of view block what's behind them. The closer something is to the radar, the more it blocks the radar's field of view.

- If a radar is blocked, certain features may become less effective or respond incorrectly.
- If the car detects that a radar is blocked, it may disable certain features.
- Do not place or mount anything in front of or close to the car's radars. This includes stickers, car body foil and adhesive tape.
- Paintwork damage in front of a radar can affect its performance. Contact a service point for repairs if there is any damage close to the radars. ^[1]
- Make sure that any mounted accessories, extra equipment or externally-stowed cargo don't block the car's radars.

- Trailers, bike racks or other towbar-mounted equipment can block the radar, making it and certain features unavailable.
- Radars are sensitive to buildups of dirt, ice or snow in front of them. This affects the radio waves and can reduce the radar's ability to detect objects. Radar obstruction cannot always be identified by the car. In situations where it is detected, the car communicates this via notifications in the displays. However, it is still recommended to regularly inspect the radars and make sure the areas around them are clean and free of obstructions.

 **Warning**

Clean regularly

Camera, radar and other sensor areas on the car must be cleaned on a regular basis and kept free from labels, objects, dirt and other kinds of potential obstructions. Otherwise, car functions may respond incorrectly or become less responsive or deactivated.

Other conditions and limitations

Other radar sources can cause interference and reduce the effectiveness of your car's radars.

^[1] Volvo recommends an authorised Volvo workshop for all servicing and repairs.

10.2.4. Parking sensor detection and limitations

The ultrasonic parking sensors allow the car to detect objects and their distance from the car. They operate at relatively close range during slow and tight manoeuvring, such as when parking.

Ultrasonic sensors use sound waves to detect obstacles close to the car. They work by sending out ultrasound pulses that can bounce back to the sensor when they encounter an object or barrier. This allows the car to identify the distance to obstacles in the direction of detection.

Information from these sensors is only available at low speeds. They provide distance information when the parking view is shown in the display.

 **Important**

Use responsibly

Ultrasonic parking sensors and features that rely on them are supplements to safe driving practices. They do not reduce or replace the need for the driver to stay aware of the car's surroundings and focused on driving safely.

Detection range

Ultrasonic sensors are typically located relatively low down on the bumper.

- Obstacles whose supports are outside of the detection zone can go undetected. Such obstacles include objects that are suspended from above or objects that extend far away from their ground support, such as certain barriers and gates.

- Objects in your immediate surroundings^[1] may not be detected when your car is at a standstill. However, if an object has already been detected, the car can still detect the object even if you come very close to it.

Blocked sensors

Ultrasonic sensors can get blocked, either reducing distance and obstacle detection or making it unavailable. To avoid blocked sensors or better understand when they may be unavailable, consider the following:

- If a sensor is blocked, certain features may become less effective or respond incorrectly.
- Heavy rain or snowfall can lead to unreliable detection and features relying on the ultrasonic sensors becoming unavailable.
- If the car detects that a sensor is blocked, it may disable certain features.
- Do not place or mount anything in front of or close to the car's sensors. This includes stickers, car body foil and adhesive tape.
- Bodywork damage where the sensors are located can affect their performance. Contact a service point for repairs if there is any damage in the sensor areas.^[2]
- Make sure that any mounted accessories, extra equipment or externally-stowed cargo don't block the sensors.
- Trailers, bike racks or other towbar-mounted equipment can block sensors, making detection and certain features unavailable.
- Ultrasonic sensors are sensitive to buildup of dirt, ice or snow in front of them. This can reduce their ability to detect objects. Parking sensor obstruction cannot always be identified by the car. In situations where it is detected, the car communicates this via notifications in the display. However, it is still recommended to regularly inspect the sensor locations and make sure the areas around them are clean and free of obstructions.



Warning

Clean regularly

Camera, radar and other sensor areas on the car must be cleaned on a regular basis and kept free from labels, objects, dirt and other kinds of potential obstructions. Otherwise, car functions may respond incorrectly or become less responsive or deactivated.

^[1] about 15 cm (6 inches)

^[2] Volvo recommends an authorised Volvo workshop for all servicing and repairs.

10.3. Driver behaviour detection

Certain aspects of the driver's behaviour are continuously monitored by the car. This is important for several driver support features.

Driver behaviour detection is used to verify that specific conditions are met when driving and using certain features. Two cameras, one located by the driver display and one located just above the centre display, continuously track the driver's behaviour without recording it. An important part of the monitoring system is checking that the driver's hands are on the steering wheel when driving. The information from this system is used by several driver support features.

Several aspects of the driver's behaviour are monitored, including:

- Head and body posture
- Eye movement and focus
- Signs of tiredness or fatigue

i Note

System for understanding the driver

In addition to tracking the driver's attention, the car monitors some other parts of driving. This includes keeping the doors closed and seatbelts buckled while driving. The individual detection points are combined to form a better understanding of the driver's focus, attention and behaviour.

Information from the behaviour detection system is combined to identify whether the driver's attention is focused on driving. This includes keeping track of traffic and surroundings, as well as being attentive and alert. The detection system can give you notifications in the driver display.

Reliant features and functions

The driver behaviour detection system keeps track of the driver's behaviour to decide if the car is being handled safely. If the system is blocked, or detects driver misuse, it can trigger a response from several other features or functions of the car.

Features that are affected by the driver behaviour detection system include:

Driver alert	Driver alert can notify you if you seem tired, distracted or unfocused.
Emergency stop assist	In situations where the driver is unable to continue driving, the car can perform a controlled stop to reduce the risk of a collision.
Collision warnings and mitigation	If you do not have full focus on driving, your car can warn you or intervene in dangerous situations earlier than usual.
Pilot Assist	Pilot Assist's steering assistance can be deactivated if you seem unfocused or don't respond to requests to keep your hands on the steering wheel.

Conditions and limitations

The driver behaviour detection system relies on cameras for detection and tracking. While the system is advanced, cameras have limitations connected to visibility that can affect the system's detection capabilities. Read the separate section about the conditions and limitations of your car's cameras to understand how features relying on camera detection are affected.

- Attention tracking requires an unobscured view of the driver's face.
 - The seating position can affect how clearly the cameras can detect the driver's face.
 - Environmental conditions inside the cabin, such as smoke, can reduce how clearly the cameras can detect the driver's face.
 - Improperly stowed items can obscure the view of the driver, as can dust and dirt on the camera lens. Keep the driver's space clean and clutter-free.
 - Wearing certain clothing and accessories can obstruct parts of the driver's face that need to be visible for attention tracking, such as the eyes.
- Certain conditions can affect how well your car can assess your driving and manoeuvring. This in turn affects how well it can distinguish signs of an unfocused or tired driver.
 - Features that help with lane placement can sometimes compensate for manoeuvring that would otherwise indicate a lack of driver focus. This makes it harder to identify signs of lacking focus compared to unassisted driving.

- Sudden changes in lighting conditions can temporarily affect how well your car can detect driver attention.
- Conditions such as strong winds or uneven road surfaces can affect your driving in ways similar to that of an unfocused driver. This can potentially cause warnings despite having a fully focused driver behind the wheel.

 **Important**

Affecting the system

Do not cover the cameras. The cameras can be fully or partially obscured by objects hung or placed on or around the driver display or the centre display. Objects placed on the dashboard can fall down or become misplaced so that they cover the cameras' views. If the cameras are obscured or covered, your car can notify you with a message in the driver display.

Do not intentionally try to trick the driver behaviour detection system. The system is there to keep driving as safe as possible. By limiting the system's ability to detect a dangerous situation, you also limit its ability to perform a safety intervention.

10.4. Safety interventions and warnings

Your car has features that directly or indirectly help prevent collisions. If your car detects a dangerous traffic situation, it can intervene by warning the driver or performing an evasive driving manoeuvre.

Safe driving begins with good user practices. As an additional level of protection against incidents, your car can warn you if it detects a situation that requires your immediate attention or action. In addition to making the driver aware through warnings, the car can intervene by steering or braking to avoid or mitigate a collision.

Features that are designed to provide warnings or perform interventions in different ways include:

- Collision warnings and mitigation
- Blind spot information
- Lane keeping aid
- Driver focus and alertness notifications^[1]
- Emergency stop assist
- Alerts about traffic crossing behind the car when reversing^[2]
- Automatic braking when reversing^[3]

 **Tip**

What are safety interventions?

Safety interventions are responses from the car in situations in which it identifies a high or imminent risk of collision. Warnings can be provided to alert the driver to hazards so that they can take action, but the car is also capable of performing emergency steering or braking manoeuvres depending on the situation. Some types of warnings and interventions are always enabled while others are part of features that you may be able to customise or choose to turn on or off.

Safety interventions to avoid collisions

When the car identifies a risk of collision, it reacts according to the level of urgency. It can identify objects such as pedestrians, cyclists and vehicles that are approaching or are in your driving path. Many factors can affect how early and effectively the car can detect the risk of an incident. There are situations that are beyond the car's capabilities, which is why safe driving practices are essential.

If the car identifies an increasing risk of collision, alerts can quickly escalate to evasive manoeuvres by the car. If a threat appears suddenly, the car can immediately perform evasive manoeuvres.

Collision warnings	When the car identifies that there's a risk of collision, the first step is to get the driver's attention. The car can warn you visually, with sound or with belt or brake pulses.
Braking manoeuvres	If the car determines that immediate action is required, it can brake independently of the driver's actions. This can occur at the same time as a steering manoeuvre. The amount the car brakes when intervening depends on the situation. An obstacle that suddenly appears just in front of the car may cause the brakes to be fully applied, whereas another situation might require less braking to avoid a potential collision.
Steering manoeuvres	If the car determines that immediate action is required, it can steer independently of the driver's actions. This can occur at the same time as a braking manoeuvre.

Messages about performed safety interventions are shown in the driver display.

Note

Overriding steering and braking interventions

- Steering interventions by the car can always be overridden with intentional steering by the driver.
- To override a braking intervention, you must firmly press down on the accelerator pedal. Past a certain threshold, you override the ongoing braking action.

Knowing your car's capabilities

Safety interventions by the car can occur suddenly and catch you by surprise. They can cause discomfort despite the benefit they provide. Knowledge about your car is a good way to make safety interventions feel less unsettling when they occur. Be sure to read any notifications following an intervention to better understand why the car intervened.

Reducing the amount of interventions and warnings

The amount of safety interventions and warnings you experience depends on the driving conditions and your driving style. Certain combinations of factors might result in responses you perceive to be unnecessary or too sensitive. In general, the most effective way of reducing the amount of warnings and interventions is to drive responsibly. Adapt your speed to the driving conditions and keep a safe distance to other vehicles. You can also adjust or turn off certain features in settings.

Balancing the response need

When the car suggests, guides or performs a driving action, it is considered a response. Most driver support features have some set of possible responses. For instance, automatic braking to prevent a collision with a car that suddenly brakes in front of you is a response. Features that can provide you with warnings and safety interventions are designed to limit unnecessary responses.

Your car's responses each have their own set of conditions. These conditions can be related to the traffic situation, the state of the car and driver, and information collected using the car's detection systems. For a response to occur, all of the required conditions need to be met and the car must have a high certainty that the response is needed. As a situation develops, the car con-

tinuously evaluates the conditions and response need. If the response need or conditions are uncertain, then the car won't respond.

If a potentially hazardous situation can be easily addressed by the driver, that is preferred over a response by the car. The car can delay or avoid providing a response in situations where you have the opportunity to address it using non-emergency manoeuvring. This helps reduce unnecessary warnings and safety interventions. Most potential hazards identified by the car are addressed by the driver through minor adjustments well ahead of the need for emergency evasive manoeuvring. In most instances, you perceive them as routine actions that are part of normal driving.

 **Important**

Always address driving hazards

The car can and will compensate for some, but not all, instances where you are unable to or fail to respond to a driving hazard. There are situations in which an effective response is beyond the capabilities of the car, and situations in which a response is not provided because the driver is expected to address the potential hazard. When driving, you are required to stay alert and attentive so that you can respond to hazards the same way you would driving a car without driver support features.

Conditions and limitations

 **Warning**

Never rely on safety interventions by the car to be a replacement for safe driving practices. Drive the car with the same attention to safety as required by a car without these features.

Warnings and interventions cannot be guaranteed in any situation. The car cannot handle all driving, traffic, weather and road conditions. Failure of the car to detect or respond to a hazard can happen for reasons that you may not be able to identify or predict.

The car's ability to respond to hazards varies depending on many factors. They often fall into any of the following categories:

- Your car's speed and movement.
- Size, shape, speed and movement of objects or road users around the car.
- Environmental conditions.
- The condition of the driving infrastructure.
- The complexity of the traffic situation.

Notable examples include:

- Sharp turns can cause detection to become less consistent. The car might be unable to identify hazards that appear suddenly as a result of turning sharply.
- Low traction, such as when the road is wet or icy, can reduce the effectiveness of interventions.
- Conditions and limitations affecting obstacle detection can prevent the car from accurately identifying potential hazards. Obstacle detection limitations are described in detail in the separate manual section about how surroundings and traffic is detected by the car.
- The car won't perform automatic braking interventions if you are driving forwards at or below walking pace. This is to avoid unwanted braking interventions when you are manoeuvring in tight spaces.

Important

General limitations

You have good reason to feel safe in a car capable of intervening in dangerous situations, but it's important to still do your best to drive safely and responsibly. The capabilities of the car are always limited by technological factors and constraints, the car's condition and the driving environment.

Detection capabilities

The car's ability to monitor its surroundings is used by features that can provide warnings and interventions. To better understand the limitations of such features, read the separate section about detection of traffic and surroundings. It provides an overview of how important components work, such as cameras and radars, detailing both capabilities and limitations.

Reaction times

In favourable conditions, the car can perceive and react to certain hazards, in some cases faster than a human driver can. However, this capability is not a guarantee of intervention as the car cannot detect all potential hazards that may require a response.

Availability of responses

All of the car's response types have their own set of conditions that define when they are available. This means that available responses constantly change as you drive. Certain conditions are strictly defined, such as an exact speed range, a setting being enabled or the driver wearing their seatbelt. Other conditions have more imprecise thresholds that can depend on a combination of factors. This has the effect that you cannot with certainty know if or how the car will respond in a given situation, but you can develop a sense of what responses are likely or not.

Read everything about the features you use

You are recommended to read all information about driver support features before using them. It's essential to understand both their capabilities and limitations.

Wear your seatbelt

Emergency braking interventions can occur even if the driver is not wearing their seatbelt. The risk of injury from hard braking rises significantly for unrestrained occupants. Always wear your seatbelt and make sure that any passengers also wear theirs.

Driver responsibility

Features that provide interventions and warnings are supplements to safe driving practices. They do not reduce or replace the need for the driver to stay attentive and focused on driving safely. The section covering driver responsibility is essential reading to understand the limitations of safety interventions and warnings. If you find anything unclear or have further questions, do not hesitate to contact your Volvo dealer.

[1] Distraction alert

[2] Cross Traffic Alert

[3] Rear Auto Brake

10.4.1. Collision warnings and mitigation

Your car has warning features designed to reduce the risk of a collision. If a collision cannot be avoided, early warning and response can help reduce its effects.

Collision warning features include:

- Forward collision warnings
- Warnings about vehicles cutting across your lane
- Rear collision warnings

Note

Safety interventions

If an urgent enough collision risk is identified, the car can intervene to avoid or mitigate the collision without any preceding collision warnings. The warnings will then instead be shown simultaneously to the intervention.

Warning

Never rely on collision warnings or safety interventions by the car to be a replacement for safe driving practices. Drive the car with the same attention to safety as required by a car without these features.

Forward collision warnings

Forward collision warnings can occur if you are getting too close to a vehicle in front of you. The car warns you if it identifies a collision risk that requires your immediate attention.

The situation and level of urgency affect how forward collision warnings are communicated. Warnings can be communicated visually in the driver display, with sound and with belt and brake pulses.

Warnings about vehicles cutting across your lane

Your car can warn you if you are about to be cut off, such as when a vehicle changes lanes just in front of you. Vehicles that swerve or move unpredictably in adjacent lanes can trigger these warnings as well. Your car uses messages in the driver display to warn you in these situations.

Rear collision warnings

If your car identifies a situation with a high risk of a rear collision, it can flash its rear lights to warn drivers behind you. Rear collision warnings appear automatically if you slow down suddenly^[1], such as during very hard braking. Warnings can also be provided if your car detects a vehicle rapidly approaching from behind. In this case, you do not need to be slowing down for a warning to appear. They can appear both when you're driving and when stopped, but only if your car detects a high enough risk of collision.

When you are in situations that cause rear collision warnings, your car can pretension your belt as a safety measure. If your car is at a standstill, it also applies hard braking as a precaution in case there is an unavoidable rear collision.

 **Note**

Collision response

If a collision cannot be avoided, the car can respond in other ways to protect occupants and reduce the danger to surrounding traffic. Read more about these features in the safety section of this manual.

[1] The rate of deceleration must exceed a certain threshold.

10.4.2. Interventions and warnings when reversing

Your car has specialised features that can intervene and help prevent collisions when you are reversing at low speeds, such as when parking.

Forms of detection

The car has several ways to identify objects that are in or approaching your reversing path. If it detects an object, the car can provide warnings or intervene by braking.

Ultrasonic parking sensors These sensors can identify certain obstacles immediately behind the car when reversing at low speeds.

Rear-facing radar The car's rear radars can detect traffic approaching your reversing path from the sides.

Camera Certain features may use camera detection to help identify obstacles when reversing.

 **Important**

These types of detection have limitations and cannot detect all obstacles in every situation. Be sure to read the separate manual sections about their conditions and limitations.

When you are reversing, some information from the detection systems can be communicated in the parking view.

Warning and intervention features

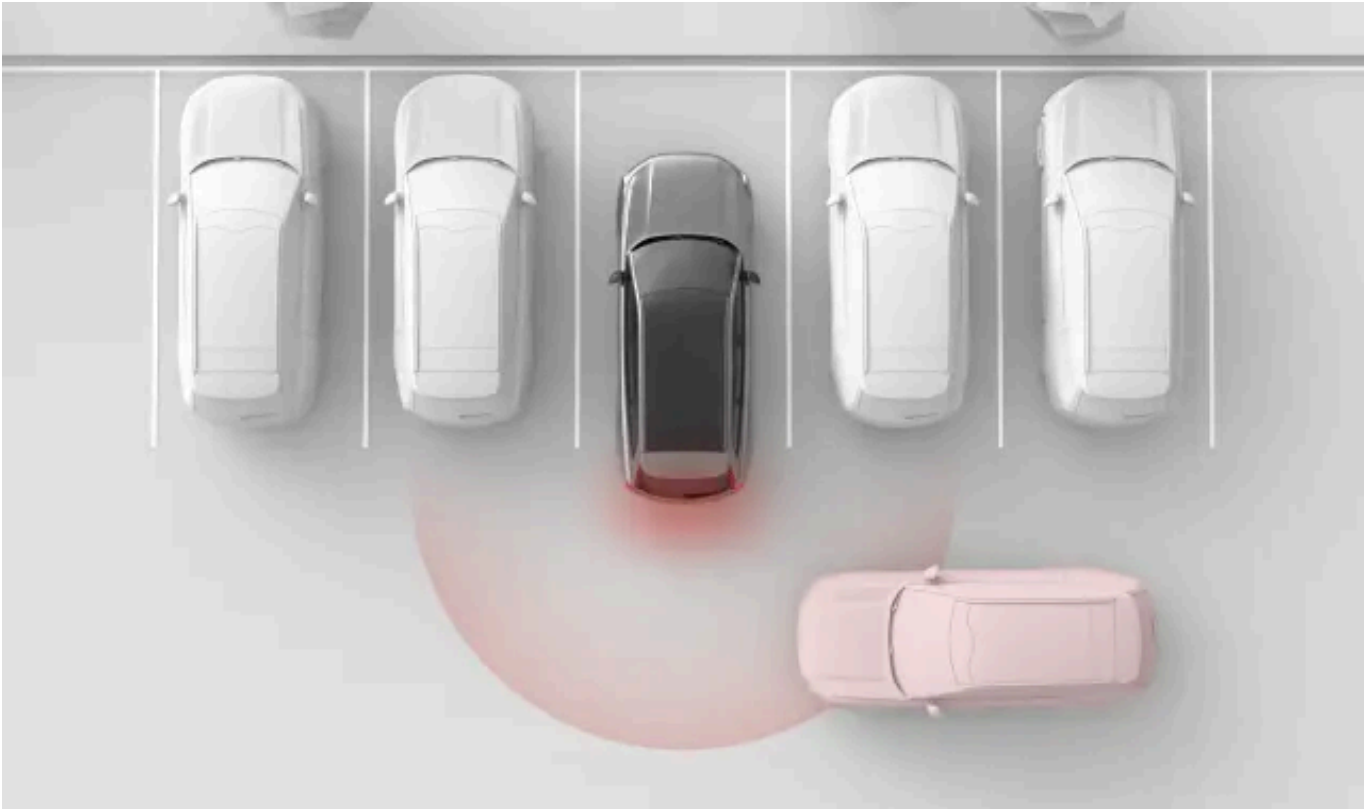

The following features are designed to react when the car identifies a risk of collision when reversing.

Alerts about traffic crossing behind the car^[1] Your car can provide visual and sound alerts if it detects traffic about to cross your reversing path.

Automatic braking when reversing^[2] The car can automatically brake to prevent a collision when reversing. This can happen if it detects an obstacle or crossing traffic behind the car.



Tip

Temporary deactivation

The rear auto brake can be temporarily turned off if the interventions are too frequent or distracting. For example, reversing in tall grass or manoeuvring in very tight spaces can cause unwanted braking interventions.

 **Important**

Use responsibly

Warnings and interventions when reversing are supplements to safe driving practices. They do not reduce or replace the need for the driver to stay attentive and focused on driving safely.

Pay attention to surroundings

The driver is always responsible for paying attention to the car's surroundings and ensuring that it is safe to manoeuvre the car.

Detection conditions

If the car deactivates the rear radars, the cross traffic alert and rear auto brake features are automatically disabled. This happens if a trailer is connected. Towbar-mounted accessories that are not connected electrically to the car does not disable the rear radars, but can obstruct them.

Detection of traffic or obstacles behind the car relies on detection by the rear radars. Be sure to read the separate section about limitations of radar detection.

Conditions for automatic braking

When and how your car performs braking interventions during low-speed reversing depends on whether a detected obstacle is stationary or not.

- If the detected obstacle is moving, such as traffic about to cross your reversing path, automatic braking is available and may intervene when you are reversing at speeds below 15 km/h (9 mph).
- If the detected obstacle is stationary, the automatic braking interventions are limited to only occur when you are reversing at speeds between 2 km/h (1 mph) and 15 km/h (9 mph). This is to avoid unwanted braking interventions during low-speed manoeuvring in tight spaces.

^[1] Cross Traffic Alert (CTA)

^[2] Rear Auto Brake (RAB)

10.4.2.1. Alerts about traffic crossing behind the car

When you're reversing at low speed, the car can warn you if it detects traffic about to pass behind you. This feature is called Cross Traffic Alert.

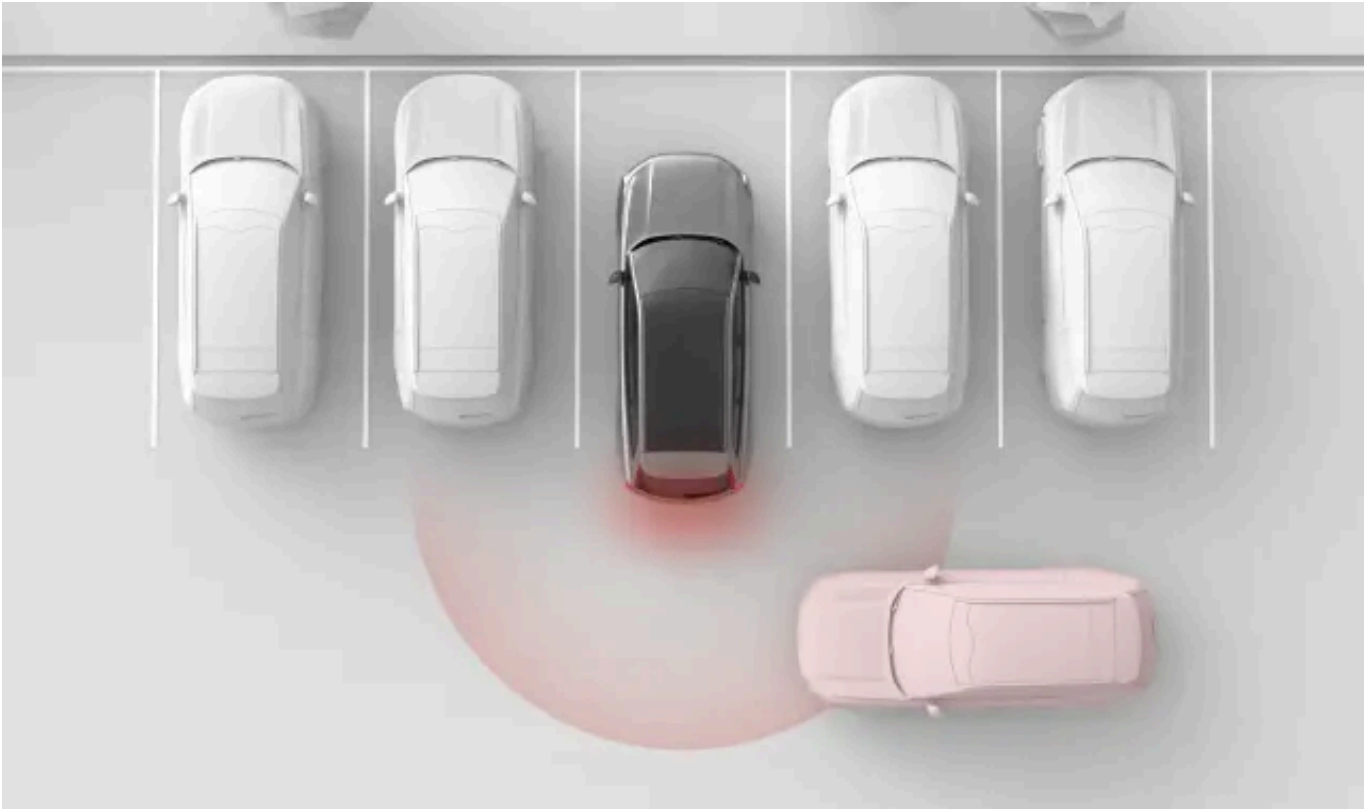

Alerts about traffic crossing behind the car are only available when the car is in reverse (R) or rolling backwards in neutral (N). This feature uses the rear radars to detect traffic. When it detects a moving vehicle, an alert appears in the centre display along with a sound.

This feature is primarily designed for detecting larger vehicles in motion, such as cars. In favourable conditions it may also be able to warn you of smaller moving objects, such as cyclists and pedestrians.

 **Important**

Driver responsibility

Alerts about traffic crossing behind are a supplement to safe driving practices. They do not reduce or replace the need for the driver to stay attentive and focused on driving safely.

 **Note**

Automatic braking for crossing traffic

If automatic braking^[1] is enabled, the car may also intervene by braking to prevent or mitigate an imminent collision with traffic detected behind you.

Detection zones

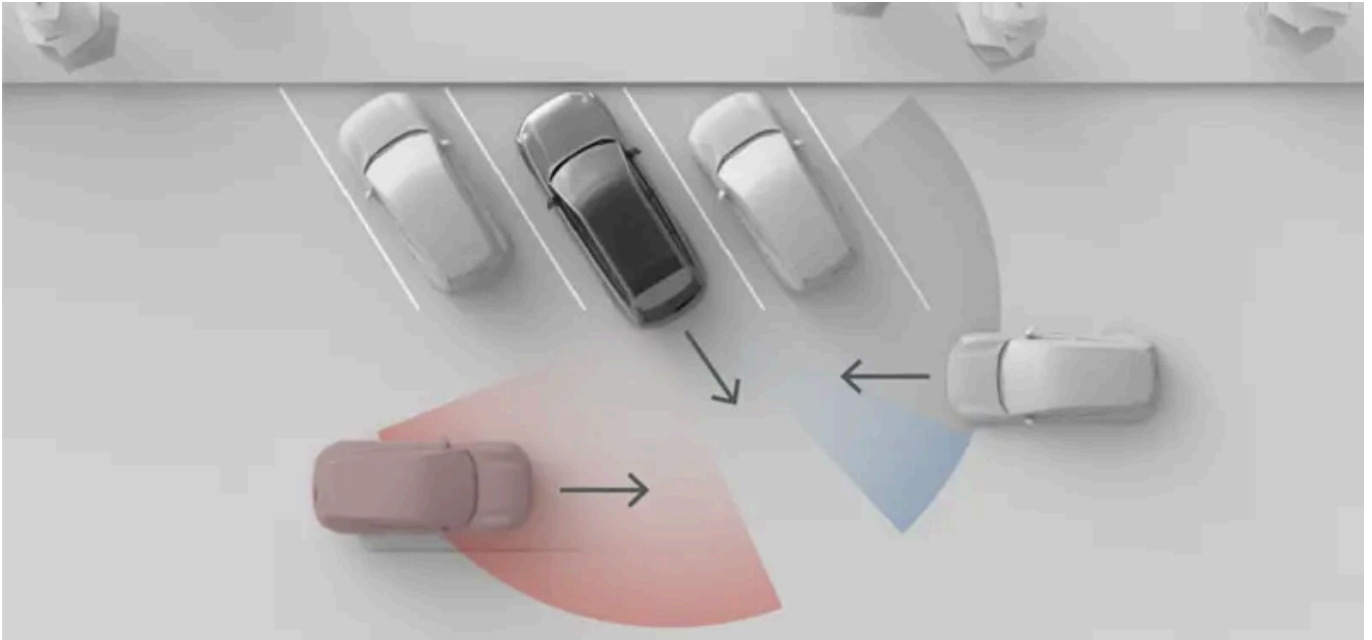

The situation shown in this image illustrates how surrounding objects, such as parked cars can limit the car's ability to detect other vehicles and traffic situations. In a situation without obstacles, the effective detection zones are the same on both sides.

i Note

Reversing out of a parking space

When parked, your rear corner radars' side views might be obstructed, which affects detection of crossing traffic. This happens when you are parked with the rear corners of your car further in than adjacent cars or other objects. This effect is particularly noticeable in angled parking spaces. However, as you reverse out of a parking space, the radars' views gradually increase, making detection possible. To minimise the risk of late or no detection when reversing out of a parking space, go slowly.

Conditions and limitations

- The alerts are only available when reversing at speeds below 15 km/h (9 mph).
- If the car deactivates the rear radars, this feature is automatically disabled. This happens if a trailer is connected. Towbar-mounted accessories that are not connected electrically to the car does not disable the rear radars, but can obstruct them.
- Detection of traffic behind the car relies on detection by the rear radars. Be sure to read the separate section about limitations of radar detection.

^[1] Rear Auto Brake (RAB)

10.4.2.2. Disabling automatic braking when reversing

The rear auto brake can be temporarily disabled in the parking view.

By disabling the rear auto brake you cancel your car's ability to perform braking interventions when you are reversing. Disabling the rear auto brake is only temporary. By default, the feature will reset to enabled between drives.

 **Important**

Changing driver support settings

Make sure that you understand how changing the car's settings affects its behaviour. It is particularly important when it comes to features that affect the level of assistance the car can provide.

1. In the parking view, press the rear auto brake button (Ⓜ).
- > Automatic braking when reversing is temporarily disabled.

10.4.3. Lane keeping aid

Lane keeping aid helps prevent accidental high-speed lane departures by providing warnings and steering interventions.

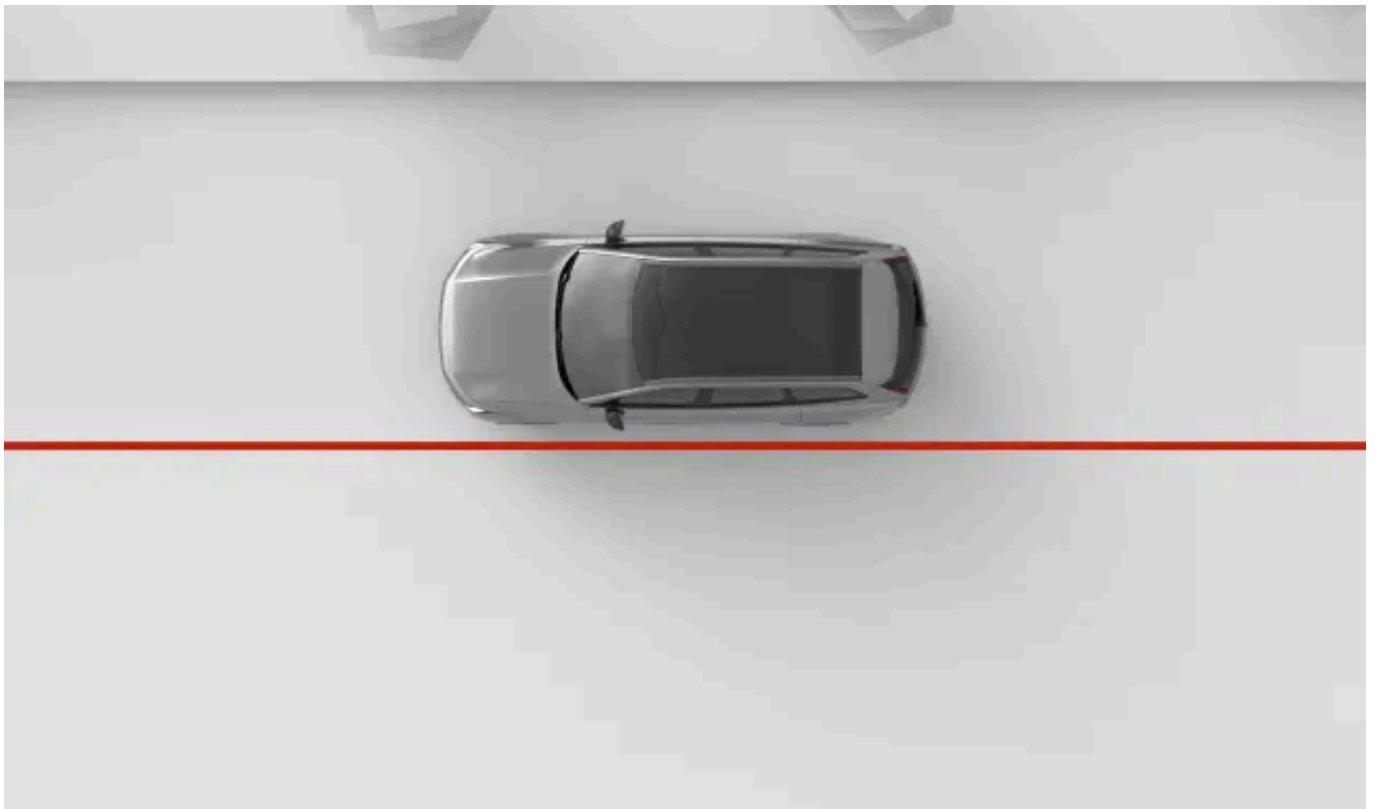

When lane keeping aid is enabled, the car can alert you if you are about to drift out of your lane. It can also perform steering interventions. Lane keeping aid depends on the car's forward-facing camera to identify road markings and your position in the lane.

The content of this manual represents the status of the user manual at the time of printing and may not be completely valid in future instances. For more information, refer to the first page for the complete disclaimer note.

 **Warning**

Lane keeping aid warnings and interventions are supplements to safe driving practices. They do not reduce or replace the need for the driver to stay attentive and focused on driving safely. Drive the car with the same attention to safety as required by a car without the ability to intervene.

Main conditions for lane keeping aid

For lane keeping aid to work, several conditions need to be met. The following are the most essential:

- Your speed must be in the range 60-180 km/h (40-110 mph).
- The lane markings must be clearly visible for the car's camera to see.
- The lane must be wide enough. A very narrow lane does not provide enough margin between the car and the road markings.

 **Important**

Steering actively

Never let go of the steering wheel when driving. Do not dismiss the car's requests for you to steer actively and keep your attention on the road.

Lane keeping aid intervention types

If you are about to cross your lane's road markings, your car can warn or intervene in either or both of the following ways:

Steering intervention The car tries to steer back into the lane and alerts you either with a symbol or a message in the driver display.

Lane departure warning The car alerts you with a symbol in the driver display and steering wheel vibrations.

 **Note**

Indicating a turn or lane change

As long as you use the turn indicators when changing lanes, the car assumes it's an intentional manoeuvre.

Cutting a corner

Lane keeping aid may allow you to briefly cut across the line at sharp corners.

Safety interventions are always enabled

Some situations can cause a steering intervention to prevent a dangerous lane departure even if lane keeping aid is turned off in settings.

Display symbols and communication

Lane keeping aid warnings and interventions are communicated in the driver display.



This symbol appears if you are coming too close to the lane markings. The symbol is mirrored during left-hand side warnings.



This symbol indicates that lane keeping aid is disabled in settings or temporarily unavailable.



This symbol appears when there is a lane keeping aid malfunction. This means that lane keeping aid and safety interventions to prevent lane departures are disabled.

When the driver display shows the surround display mode, lane keeping aid's status and actions are shown as animations and with symbols.

Important

Using surround mode

Surround mode cannot perfectly depict what is really happening on the road around you, so do not rely on it when you are driving.

Conditions and limitations

For lane keeping aid to work, road markings must be present and visible. The car identifies them using a forward-facing camera. This form of detection requires that the camera view is unobstructed and that the conditions for visual detection are present. Read the separate section about the conditions and limitations of your car's cameras to understand how features relying on camera detection are affected.

The appearance, condition and layout of road markings can affect their detection in the following ways:

- Lane divisions and mergers can cause temporary misidentification of the lane.
- Non-standard or unusual road marking layouts might not be identified correctly by the car. For example, road work or traffic diversions can result in conflicting or multiple sets of road markings.
- The car may be unable to detect deteriorated road markings, for example if they are worn, misshapen or discoloured.
- Other edges or lines can be misidentified as road markings, such as kerbs, road surface repair edges, barriers or well-defined shadows.
- Road markings must be sufficiently illuminated to be detected. In low-light conditions, they need to be illuminated by the car or street lights.

10.4.3.1. Adjusting lane keeping aid

You can adjust or temporarily disable lane keeping aid in settings.

When lane keeping aid is enabled, the car can alert you or intervene by steering if you are about to drift out of your lane. You can also adjust the car's response to lane departures.

The available settings are:

Vibration The steering wheel vibrates if you drive too close to or over the lane markings.

Steering and vibration In combination with steering wheel vibrations, your car will try to steer you back into your lane if you drive too close to or over the lane markings.

You can disable lane keeping aid in settings. This can be useful if the road markings are partially obscured or faded, which can cause unwanted warnings.

Disabling lane keeping aid is only temporary as this setting automatically resets to enabled between drives.

 **Important**

Changing driver support settings

Make sure that you understand how changing the car's settings affects its behaviour. It is particularly important when it comes to features that affect the level of assistance the car can provide.

1. Press the car symbol  in the bottom bar and go to **Settings**.
2. Go to **Driving** → **Safety assistance** → **Lane keeping aid**.
3. Adjust lane keeping aid. If you have previously disabled lane keeping aid, you must first re-enable it before you can adjust its response to lane departures.

 **Note**

Disabled

A symbol is shown in the driver display when lane keeping aid is disabled.



Safety interventions

Some situations, such as when you are about to cross a solid line or if you show signs of inattentiveness, can cause a steering intervention to prevent a dangerous lane departure even if lane keeping aid is turned off in settings.

10.4.4. Blind spot information

The blind spot information feature helps increase your awareness of vehicles in or approaching your blind spots. A light appears in the wing mirror when a vehicle is detected.

Blind spot alerts can increase your awareness of vehicles to the side of your car, which can help you avoid performing dangerous lane changes. The alerts primarily appear as a light in the wing mirror on the side of detection. They rely on your car's rear radars for detection of vehicles in adjacent lanes.

Traffic situations in which blind spot alerts appear include:

- When you are being overtaken by another vehicle.

The content of this manual represents the status of the user manual at the time of printing and may not be completely valid in future instances. For more information, refer to the first page for the complete disclaimer note.

- In some cases, they can appear before the passing vehicle reaches your blind spot. This happens if it's quickly approaching from behind in an adjacent lane.
- When you are overtaking another vehicle.

Regardless of the situation, the alert remains as long as the other vehicle is detected to your side.

If you start indicating a lane change while an alert is shown, the alert intensifies.

Alerts in the wing mirrors



When a vehicle is detected in or approaching your blind spot, a light appears in the wing mirror.

Communication in the driver display

When the driver display shows the surround display mode, blind spot information can be communicated using animations in the driver display.

! Important

Using surround mode

Surround mode cannot perfectly depict what is really happening on the road around you, so do not rely on it when you are driving.

Detection areas

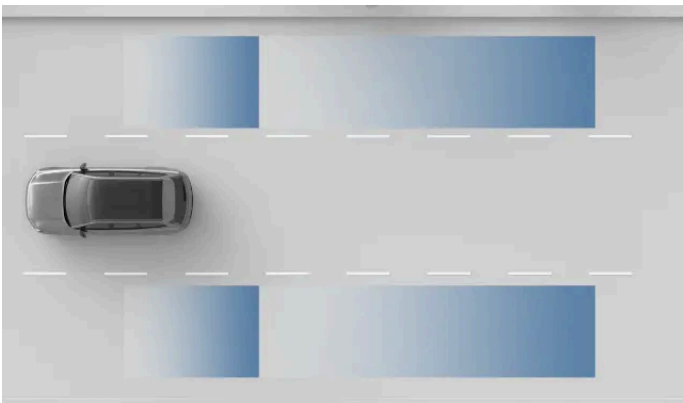

Radar detection areas.

! Important

The detection areas may not perfectly cover your own blind spots. Be sure to adjust your driving posture to allow for a good overview of surrounding traffic.

Conditions and limitations

- Blind spot information is active at speeds above 10 km/h (6 mph). It's not available when reversing.
- When passing other vehicles, the speed difference between your car and the other vehicles must be below 15 km/h (9 mph) for the alerts to appear.
- Blind spot information relies on detection by the rear radars. Be sure to read the separate section of this manual about limitations of radar detection.
- If the rear radars are obstructed, such as by an attached trailer or mounted bike rack, alerts about vehicles in the blind spots are automatically disabled.

! Important

Driver responsibility

Alerts about vehicles in the blind spots are a supplement to safe driving practices. They do not reduce or replace the need for the driver to stay attentive and focused on driving safely.

The lack of a blind spot indication is not a confirmation that it is safe to change lanes. It is one of several pieces of information that inform the driver's assessment of whether it is safe to proceed.

10.4.5. Door opening alerts

Door opening alerts are designed to make exiting your car safer. They can warn you of traffic approaching from behind so that you don't open a door in its path.

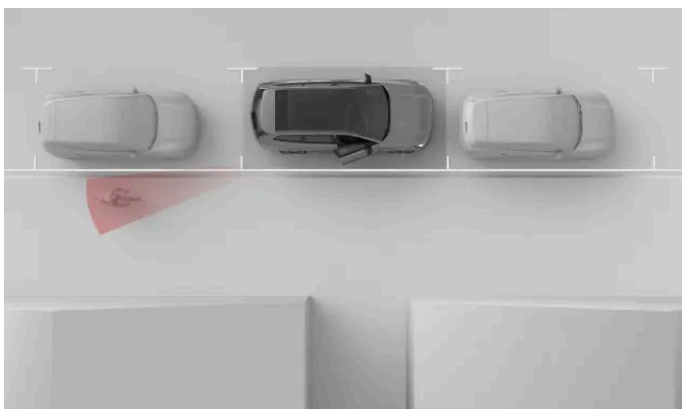

Door opening alerts are designed to warn you of passing traffic so that you don't open a door in its path. These alerts can be provided when the car is stationary or moving very slowly^[1].



When the car detects traffic that is about to pass close to the car's sides, a light appears in the wing mirror. If you begin to open the door on the side of the detected traffic, the alert intensifies. A sound alert can occur along with the visual alerts depending on how urgent the warning is.

i Tip

Door opening alerts and blind spot information

Door opening alerts are indicated in a similar way to alerts about vehicles in your blind spot. These two features also rely on the same rear radars for detection of traffic.

Limitations

The car uses its rear radar system to detect approaching traffic. Be sure to read about radar and detection conditions and limitations in their separate section of the manual.

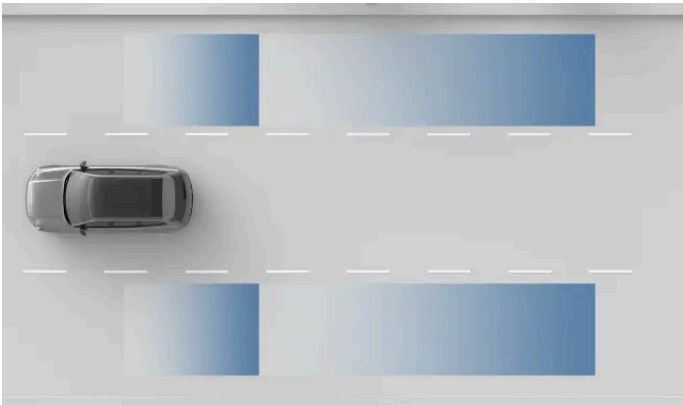

Radar detection areas.

! Important

Door opening alerts are supplements to safe user practices. The driver and passengers are fully responsible for making sure that the car doors can be safely opened.

^[1] Below 3.6 km/h (2.2 mph)

10.4.6. Driver alert

The car continuously observes your behaviour while driving and can notify you if you seem unfocused. A lack of focus can be caused by distractions or being tired.

If the car identifies signs of reduced driver focus, it will notify you with a sound and a message. The type of message depends on whether you seem tired or distracted. If you ignore the message and continue to behave in the same way, the warnings will escalate. Unresponsiveness can ultimately result in the car slowing down to perform an emergency stop manoeuvre.

The car uses different methods to assess your focus when driving.

Attention tracking Camera tracking of your face and eye movements allows the car to determine where you are directing your attention.

Manoeuvring Analysing the way you manoeuvre the car can provide an indication of lacking focus. One example of this is excessive lane drifting.

Distraction alerts

Your level of attentiveness while driving is continuously monitored by your car's internal cameras. If you seem inattentive or distracted, the car can alert you of this via messages in the driver display. The alerts disappear only after your car detects that you are attentive again. If you do not regain an acceptable level of attention and focus on your driving, the alerts can escalate to warnings. If your car finds you to be unresponsive for a certain amount of time, it can stop automatically within its current lane.



Distraction alert notifications can be temporarily disabled in settings.



Distraction alert notifications are enabled by default every time you activate Pilot Assist with steering assistance.

Alerts about a tired or drowsy driver

Your car monitors certain aspects of your driving as well. Certain driving patterns, such as excessive lane drifting, may provide indications that the driver is tired or drowsy.

If the car identifies signs of tiredness or drowsiness, it will notify you with a sound and a message in the driver display. These alerts cannot be disabled in settings.



 **Warning**

The importance of a well-rested driver

Any notifications about you showing signs of being tired should be taken seriously, as a tired driver is often unaware of their condition. If you feel tired or receive an alert about it from the car, stop as soon as possible in a suitable location for a rest. Always plan for regular breaks and start all trips with a well-rested driver.

Driving while tired is comparable to driving under the influence of alcohol.

Conditions and limitations

- Attention tracking requires an unobscured view of the driver's face.
 - Improperly stowed items can obscure the view of the driver, as can dust and dirt on the camera lens. Keep the driver's space clean and clutter-free.
 - Wearing certain clothing and accessories can obstruct parts of the driver's face that need to be visible for attention tracking, such as the eyes.
- Certain conditions can affect how well your car can assess your driving and manoeuvring. This in turn affects how well it can distinguish signs of an unfocused or tired driver.
 - Features that help with lane placement can sometimes compensate for manoeuvring that would otherwise indicate a lack of driver focus. This makes it harder to identify signs of lacking focus compared to unassisted driving.
 - Conditions such as strong winds or uneven road surfaces can affect your driving in ways similar to that of an unfocused driver. This can potentially cause warnings despite having a fully focused driver behind the wheel.

Read the separate section about conditions and limitations of your car's driver behaviour detection system and cameras to understand how features relying on these systems are affected.

 **Important**

Driver responsibility

Alerts about a lacking focus when driving are a supplement to safe driving practices. The driver is fully responsible for making sure they are able to stay alert and maintain focus when driving.

10.4.6.1. Disabling distraction alert notifications

You can enable or temporarily disable distraction alert notifications in settings.

Disabling distraction alert notifications is only temporary as this setting automatically resets to enabled between drives.

You cannot disable alerts concerning driver tiredness or drowsiness.

 **Warning**

The importance of a well-rested driver

Any notifications about you showing signs of being tired should be taken seriously, as a tired driver is often unaware of their condition. If you feel tired or receive an alert about it from the car, stop as soon as possible in a suitable location for a rest. Always plan for regular breaks and start all trips with a well-rested driver.

Driving while tired is comparable to driving under the influence of alcohol.

 **Note**

Driver responsibility

Alerts about a lacking focus when driving are a supplement to safe driving practices. They do not reduce the driver's responsibility to continuously assess whether they are too tired or unfocused to drive safely.

1. Press the car symbol  in the bottom bar and go to **Settings**.
2. Go to **Driving** → **Safety assistance** → **Distraction alert**.
3. Turn distraction alert notifications on or off.

 **Important**

Distraction alert notifications are enabled by default every time you activate Pilot Assist with steering assistance.

10.4.7. Connected safety

Your car can communicate information with other cars on the road, which can help you to be aware of or avoid accidents or traffic situations further up the road. This feature is called connected safety.

Through an internet connection, your car and other vehicles on the same road can share information about current road conditions and situations, such as:

- activated hazard warning lights
- accidents
- slippery roads
- road works
- large animals
- pedestrians and bicycles.^[1]

Connected safety can be enabled or disabled in privacy settings.

 **Warning**

Connected safety is not a replacement for safe driving practices. Drive the car with the same attention to safety as you would in a car without this feature.

Connected safety warnings

Depending on the information your car receives from other road users about situations further up the road, one of these symbols can be shown in the driver display:



A vehicle's hazard warning lights are active. This symbol also appears when there are road works, large animals, pedestrians and bicycles.



Slippery road conditions are detected.



An accident has happened.

 **Tip**

Warnings from connected safety can also be shown in the head-up display.

Conditions and limitations

For connected safety to work, these conditions need to be met:

- Connected safety must be enabled in settings.
- Other vehicles need to have connected safety available and enabled.
- Both your car and other vehicles must be connected to the internet.
- The road you're on is in the Volvo Cars database.

 **Note**

Slippery road conditions not registered

A slippery road may not always trigger a warning from connected safety. Low friction between the tyres and road surface are often used to identify a slippery road. Manoeuvres such as braking or accelerating rarely cause low-friction situations. As a result, the feature may not always detect a slippery road during these manoeuvres.

^[1] This feature aims to notify you of unexpected pedestrians and bicycles that could cause a hazard, such as on a motorway.

10.4.7.1. Enabling connected safety

You can enable or disable connected safety in settings.

Connected safety can warn you of upcoming situations on the road you're on, such as another vehicle with their hazard warning lights activated or slippery road conditions. The feature relies on communication with other road users via internet connection.

Important

Increased data transfer

Enabling connected safety increases the amount of data transferred to and from your car.

Changing driver support settings

Make sure that you understand how changing the car's settings affects its behaviour. It is particularly important when it comes to features that affect the level of assistance the car can provide.

1. Press the car symbol  in the bottom bar.
2. Go to **Settings** → **Privacy** → **Volvo privacy settings** → **Connected safety**.
3. Enable connected safety.

10.4.8. Emergency stop assist

In situations where the driver is unable to continue driving, the car can perform a controlled stop to reduce the risk of a collision.

If the car finds the driver to be unresponsive for a certain amount of time, it can stop automatically within its current lane. This can, for example, help avert an accident if the driver suffers a medical emergency while driving.

The car initiates a controlled stop if the driver doesn't respond to requests to actively drive the car. These requests can come from the driver alert feature if the driver is unfocused or shows signs of being too inattentive to drive safely. They can also be related to the driver not keeping their hands on the steering wheel.

Tip

Emergency stops are performed if the car finds the driver to be unresponsive for a certain amount of time. You can always override the stop manoeuvre by actively steering, braking or accelerating. This indicates that you are attentive again and available to continue the drive.

During the stopping manoeuvre, the car utilises all of the information it continuously collects about its surroundings to come to a controlled stop in the lane of the road you're on. It also activates the hazard warning lights to warn other drivers.

If the driver is available after the safe stop manoeuvre completes, the car should be moved to a safe spot where it does not pose a traffic hazard.

Emergency assistance

In the event of an emergency stop your car can automatically connect you to an emergency call centre.^[1] You can read more about emergency assistance in a separate section of the manual.

Warning

- Driving interventions such as performing a controlled emergency stop are supplements to safe driving practices. They do not reduce or replace the need for the driver to stay attentive and focused on driving safely.
- Do not intentionally trigger an emergency stop manoeuvre if it is not absolutely required for stopping safely.

Conditions and limitations

Your car's driver behaviour detection system constantly monitors the driver's actions. It relies on interior cameras to keep track of eye movement, attention, drowsiness and whether the driver's hands are on the steering wheel. Emergency stop assist uses information from this system to identify the driver's actions and decide when an emergency stop is necessary. It is therefore important not to try and trick the behaviour monitoring system, or cover the cameras.

Emergency stop assist relies on information from radar and camera units to identify the car's surroundings and perform a safe stop. Read the separate sections about the conditions and limitations of your car's driver behaviour detection system, cameras and radars to understand how features relying on these kinds of detection are affected.

Important

Car faults

If emergency stop assist is unavailable due to a driver support system fault, a message telling you to book a service is shown in the driver display. Contact an authorised Volvo workshop if a fault is indicated in this way or another.

Car alterations

Modifications, repairs and accessory installations can negatively affect or limit driver support features. There is a separate manual section with detailed information on this topic.

^[1] The availability of this feature may differ between regions.

10.5. Assisted driving

Assisted driving features use the car's ability to monitor its surroundings to make driving safer and less demanding.

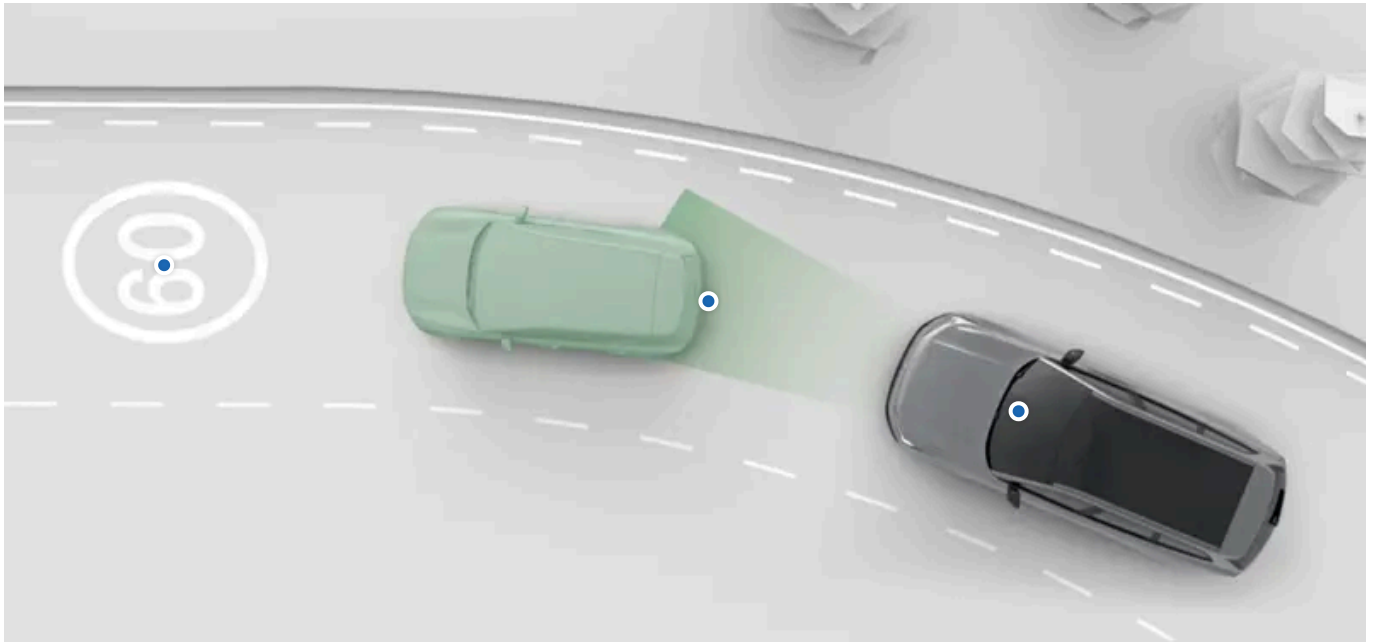

There are several forms and levels of assistance. They can actively assist you with a number of driving tasks and provide information support for better driver decision-making.

You can enable, disable or customise many of your car's assisted driving features in settings.

Pilot Assist	This feature can assist you in several driving tasks such as steering, managing speed and changing lanes. Pilot Assist can be customised in settings.
Road signs and speeding response	Several features can assist you with keeping track of the speed limit and preventing unintentional speeding. They include road sign information, which makes you aware of the speed limit, and different responses from the car designed to prevent you from exceeding the speed limit. These features can be customised in settings.



Safety interventions and warnings

Many of the driver support features are designed to improve both convenience and safety. Features that primarily provide safety interventions and warnings have their own, separate section in this manual.

Assisted parking

There is a separate section of this manual covering assisted parking features.

 **Important**

Required knowledge and driver responsibility

Assisted driving features are designed to make driving safer and less demanding, but they do not reduce the driver's responsibility to operate the car as safely as possible. Be sure to read all related information about a feature before using it. The section covering driver responsibility is essential reading to understand the capabilities and limitations of your car's assisted driving features.

If you find anything unclear or have further questions, do not hesitate to contact an authorised Volvo workshop.

Detection capabilities

The car's ability to monitor its surroundings is used by assisted driving features. To better understand the limitations of such features, read the separate section about detection of traffic and surroundings. It provides an overview of how important components work, such as cameras and radars, by detailing both capabilities and limitations.

10.5.1. Road signs and speeding response

Several features can assist you with keeping track of the speed limit and preventing unintentional speeding.

To help you maintain a legal speed, your car is designed to make you aware of the current speed limit by showing it in the driver display. It can also respond with warnings if you exceed the speed limit.

Road sign information The car can detect and display information from road signs, such as the speed limit.

Speed limit warnings Intelligent Speed Assist^[1] can warn you with sound or alter the accelerator's response if you exceed the speed limit.

Sound for new speed limit A sound alert indicates when the car detects that the speed limit changes.

 **Important**

Speed-related information and warning features are supplements to safe driving practices. They do not reduce or replace the need for the driver to stay attentive and focused on driving safely. It is the driver's responsibility to observe and maintain a legal and safe speed.

^[1] ISA

10.5.1.1. Speed limit warnings

Speed limit warnings can be provided to help prevent unintentional speeding.

Intelligent Speed Assist^[1] can give you speed limit warnings when you exceed the speed limit.

You can adjust the speeding response from ISA in settings. The following options are available:

Pedal Limits the response from the accelerator when you exceed the speed limit. If a new, lower speed limit is discovered, ISA can also slow your car down to the correct driving speed.

Sound A sound alert is played when you exceed the speed limit.

The selected speeding response is accompanied by a flashing speed limit sign in the driver display when exceeding the speed limit.

You can adjust the speeding response or temporarily disable ISA in settings.



Tip

Overriding the ISA pedal response

When the speeding response is set to **Pedal**, you can always override the feature by pressing the accelerator down further.

Quick access when driving

You can turn speed limit warnings on or off via quick controls in the centre display. This allows you to quickly enable or disable them without going into settings.



Speed limit warning symbol in quick controls.

Conditions and limitations

Speed limit warnings use road sign information to keep track of the speed limit. If information about the speed limit is unavailable for some reason, no warning can be provided.



Important

Driver responsibility

Speed limit warnings are supplements to safe driving practices. They do not reduce or replace the need for the driver to stay attentive and focused on driving safely. It is the driver's responsibility to observe and maintain a legal and safe speed.

^[1] ISA

10.5.1.1.1. Disabling Intelligent Speed Assist

Speed limit warnings from Intelligent Speed Assist^[1] can be temporarily disabled for the rest of the drive.

You can disable the alerts for exceeding the speed limit. However, they are enabled by default for each new drive.



Tip

Quick access when driving

You can turn speed limit warnings off via quick controls in the centre display. This allows you to quickly enable or disable the warnings without going into settings.



Speed limit warnings symbol in quick controls.

1. Press the car symbol  in the bottom bar and go to **Settings**.
 2. Go to **Driving** → **Intelligent speed assist**.
 3. Enable or temporarily disable speed limit warnings.
- > If you choose to disable them, alerts when exceeding the speed limit will not occur for the rest of the drive.

^[1] ISA

10.5.1.1.2. Adjusting speed limit warnings

Speed limit warnings from Intelligent Speed Assist^[1] can be adjusted in settings.

You can adjust the speeding response from ISA in settings. The following options are available:

Pedal Limits the response from the accelerator when you exceed the speed limit. If a new, lower speed limit is discovered, ISA can also slow your car down to the correct driving speed.

Sound A sound alert is played when you exceed the speed limit.



Note

When using Pilot Assist the speeding response is automatically set to be provided as sound alerts.

1. Press the car symbol  in the bottom bar and go to **Settings**.
2. Go to **Driving** → **Speeding response**.

**Note**

Intelligent Speed Assist must be enabled to access the settings for speeding response.

3. Select a speeding response.

^[1] ISA

10.5.1.2. Enabling sound alerts for speed limit changes

Your car can alert you with a sound when it detects a new speed limit. This feature can be enabled or disabled in settings.

1. Press the car symbol  in the bottom bar and go to **Settings**.
2. Go to **Driving** → **Safety assistance** → **Sound for new speed limit**.
3. Enable or disable sound alerts for speed limit changes.

10.5.1.3. Road sign information

The car can identify and display road signs as you pass them, allowing you to keep track of the speed limit. This feature combines direct detection of signs with sign information from map data.

The signs shown in the driver display come from two different sources - either from real-world signs identified by camera or from map data. The car automatically prioritises which source to use depending on the situation.

The car can only show signs that are part of the car's sign library.

How signs are shown

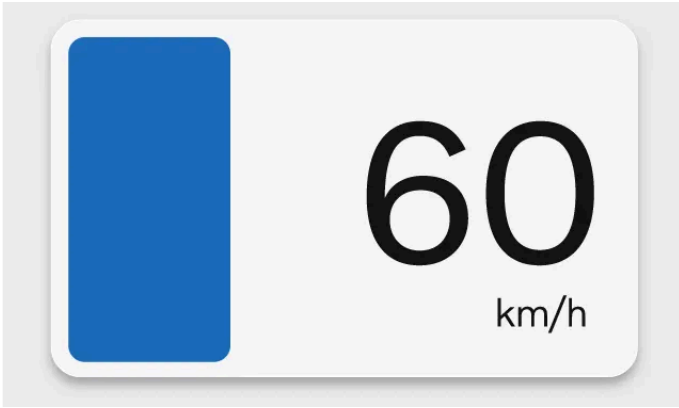

How the road sign symbols appear can sometimes depend on the current driver display mode.

The car can simultaneously display several sign types. This can include the current speed limit along with a warning sign or an additional traffic information sign. When driving with Pilot Assist, the car can also display an upcoming speed limit.

Detected road signs appear next to the speedometer in the driver display.

Displayed road signs

This list contains examples of road sign types that can be shown in the car.



i Note

Symbol availability

Road signs available to display in your car can change over time and vary between regions. The selection presented in this manual may not include every sign that can appear in your car's display.

Symbol design

Road sign styles vary between regions. The symbol style displayed by the car will not exactly match the symbol style of signs you encounter. If you have any issues interpreting a displayed sign despite the information provided in this manual, contact Volvo support.

Road sign display times

The display time for signs typically depends on the type of sign and whether you pass additional signs. Road signs can be shown in the following ways:

- Briefly as one-time alerts after passing a sign.
- Until the sign no longer applies.
- Until you pass another sign with higher display priority.

 **Note**

Lingering signs

The car might fail to identify a sign indicating the end of a traffic limitation. If this happens, a symbol for the previous limitation can linger in the driver display. It will eventually be replaced or cancelled. In the meantime, drive according to the applicable rules of the road.

Conditions and limitations

 **Important**

Driver responsibility and road signs

Road sign information is designed to help manage information while driving. It is a supplement to safe driving practices. The driver is fully responsible for remaining attentive, keeping track of road signs and following local regulations. Do not prioritise the car's road sign detection over your own observations if they conflict.

Why all signs are not shown

The car cannot detect and show every sign that is relevant to the driver.

- Not all signs are supported by the system.
- Signs may go undetected in certain conditions and traffic situations.

Conditions affecting road sign detection or identification:

- The car's forward-facing camera must be clean and free of obstructions.
- The road sign must be clearly visible and properly illuminated.
- The road sign must be within a certain distance and within the camera's field of view.
- The car may not be able to identify misaligned road signs, such as signs placed too high or at an angle.
- The car may not be able to identify damaged or worn road signs.

Conditions affecting sign information from map data:

- An internet connection is required to download map data that contains information about road signs.
- The coverage of road sign information from map data varies between regions.

 **Note**

For consistent and up-to-date road sign information in your car, be sure to accept Google's Terms of service. Contact an authorised Volvo workshop if you experience any issues with the road sign information feature.

10.5.2. Pilot Assist

The content of this manual represents the status of the user manual at the time of printing and may not be completely valid in future instances. For more information, refer to the first page for the complete disclaimer note.

Pilot Assist combines several support capabilities to make driving safer, more convenient and less demanding. It can assist you with speed management and steering guidance in a wide variety of situations.

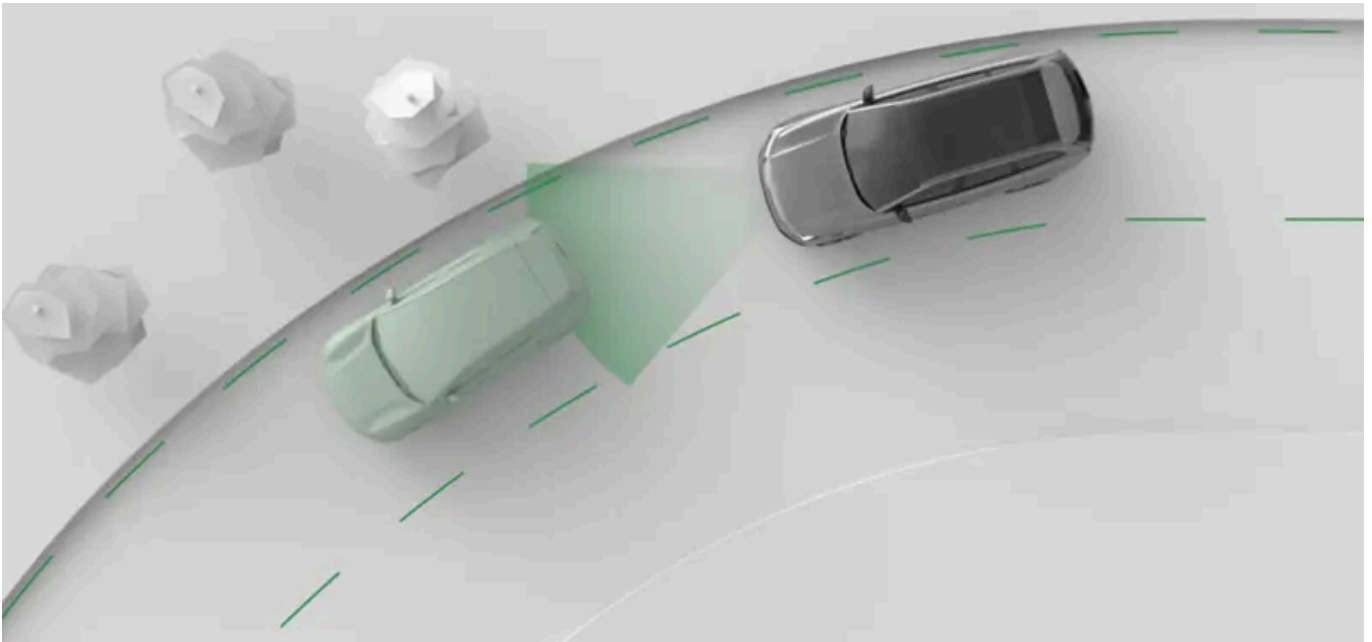

Pilot Assist actively guides your driving in a number of ways. When driving with Pilot Assist, you select the target speed. The car then manages acceleration and braking to meet that target while also adapting to surrounding traffic.

It's also capable of steering assistance. When enabled, steering assistance helps with road positioning by guiding your steering wheel movement.

Important

Before using Pilot Assist

Take the time to read everything the manual has to say about Pilot Assist before using it. Understanding its capabilities and limitations is necessary for safe use.

The driver is in control

When using Pilot Assist, you are still in control of the car. It's your responsibility to continuously assess Pilot Assist's performance. As long as you judge its input to be correct, you can let it guide your driving.

Tip

Customise Pilot Assist

Some of Pilot Assist's capabilities can be customised, either in Pilot Assist's settings or by using the steering wheel buttons. This allows you to set it up for the level of support you want.

Managing speed and distance to vehicles ahead

When you activate Pilot Assist, a set speed value appears by the speedometer. This represents the target speed that Pilot Assist tries to maintain. You can adjust the set speed with the steering wheel buttons.

When **Adapt to speed limit** is enabled in settings, Pilot Assist can adapt the set speed to changes in the speed limit. When the speed limit changes, the new speed limit appears as a suggested set speed in the driver display for you to confirm.

If your car detects a vehicle ahead that's either slower than you or a bit too close, Pilot Assist will slow down to maintain a certain distance to the vehicle in front. Once the road ahead becomes clear again, your car returns to the target speed. You can adjust the general distance to vehicles ahead in settings.

Steering assistance

The availability of active steering assistance depends on the conditions you are experiencing. For example, if you encounter a stretch of road with worn-out markings, the car may temporarily turn steering assistance off and tell you to steer the car unassisted by Pilot Assist. As soon as the necessary conditions are met again, steering assistance reactivates.

Steering assistance can be enabled in Pilot Assist's settings or using the steering wheel buttons if you are driving.

Pilot Assist features and settings

There are a number of Pilot Assist capabilities and settings to read about in this manual.

Steering assist	When driving with steering assistance, your steering is actively guided. This can help you maintain correct lane positioning.
Lane change assist	Guides lane change manoeuvres initiated by the driver.
Prevent overtaking on the left	Prevents the car from making high speed passes on the left-hand side of other vehicles.
Curve speed assist	The driving speed is adapted ahead of known road features such as curves and roundabouts. You can always override this by pressing down on the accelerator pedal.
Adapt to speed limit	If the speed limit changes, the new speed limit appears as a suggested set speed in the driver display for you to confirm.
Time interval to vehicle ahead	Adjust the target time interval to the vehicle ahead. This way, you can adjust the distance to vehicles in front of you.

Status and availability

Pilot Assist's availability is indicated in the driver display and depends on the current driving conditions. You can always see the current level of support you're getting from Pilot Assist in the driver display.

Note

Paused

In some situations, Pilot Assist can be temporarily paused. This can happen when a driver decision is needed to resume driving with Pilot Assist, such as after coming to a stop. When Pilot Assist is paused, a message with instructions for resuming is typically shown in the driver display.

Pilot Assist uses map data provided by Google. Not accepting Google's terms and conditions limits the availability and performance of Pilot Assist. You can manage your consent in privacy settings via the centre display.

10.5.2.1. Pilot Assist video guide

Watch the Pilot Assist video guide to learn more about Pilot Assist.

You can watch the video guide to get a good understanding of how the Pilot Assist feature works, when to use it and how to adjust some of its settings. However, the video guide doesn't include all information you need to know to be able to use Pilot Assist safely and correctly. Make sure you read everything about Pilot Assist in the user manual before using the feature.



10.5.2.2. Pilot Assist communication and status

Learn how Pilot Assist's status and actions are communicated in the car.

The driver display shows the status of Pilot Assist using graphics and symbols. Important information can also appear as notifications.

The primary status is shown below the gear indicator. It tells you whether Pilot Assist is active or not.



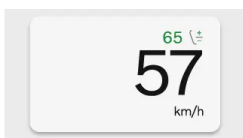



The target speed appears in green above the speedometer.



Communication with symbols

Pilot Assist's status is communicated using symbols. The symbols can show what level of support Pilot Assist is currently providing, depending on your active Pilot Assist settings.

D Pilot Assist without steering assistance is available to activate if all conditions are met.

-  Pilot Assist with steering assistance is available to activate if all conditions are met.
-  Pilot Assist is active without providing steering assistance.
-  Pilot Assist is active and providing steering assistance.
-  Lane change assist communication. The colour and direction of the arrows are different depending on the situation.
-  Steering assistance is temporarily unavailable.
-  Pilot Assist is adapting the driving speed to a vehicle ahead. The symbol is shown next to the speedometer.
-  Curve speed assist is active and Pilot Assist is adapting the driving speed to the current road features, such as a curve or roundabout. The symbol is shown next to the speedometer.

Communication in surround display mode

When the driver display shows the surround display mode, Pilot Assist's status and actions are shown as animations and with symbols. The animations can show what level of support Pilot Assist is currently providing, depending on your Pilot Assist settings. This may include speed-keeping, distance-keeping, adjusting the speed to other vehicles ahead and availability of steering assistance.

Important

Using surround mode

Surround mode cannot perfectly depict what is really happening on the road around you, so do not rely on it when you are driving.

Notifications and messages

When using Pilot Assist, notifications can appear in the driver display. They can contain important information about the status of Pilot Assist features as well as instructions for you to follow, such as not letting go of the steering wheel.

10.5.2.3. Activating Pilot Assist

You activate Pilot Assist by moving the right-hand steering wheel stalk downwards while driving. It's important to assess whether the current driving conditions allow you to use Pilot Assist safely.

When driving, a grey Pilot Assist symbol in the driver display indicates that the function is available but not yet activated. The symbol changes depending on if steering assistance is enabled in settings or not.

-  Pilot Assist with steering assistance is off but available to activate if all conditions are met.

D Pilot Assist without steering assistance is off but available to activate if all conditions are met.

! Important

Before using Pilot Assist

Take the time to read everything about Pilot Assist in this manual before using it for the first time. Understanding its capabilities and limitations is important for safe use.

Assess the situation

Make sure the traffic situation and conditions are suitable for activation. Wait until ongoing manoeuvres, such as a lane change, are completed before activating Pilot Assist.

Activating Pilot Assist when driving

1.



When appropriate, pull the right-hand steering wheel stalk all the way down.

> Activation is confirmed in the driver display.

The first time you activate Pilot Assist during a drive, your speed at the time of activation becomes the set speed.

i Tip

Resume Pilot Assist

If you recently used Pilot Assist and you want to use your previous target speed, keep the steering wheel stalk pulled down for little while longer when activating Pilot Assist. This resumes your previously set target speed upon activation.

When Pilot Assist is active, you can adjust the target speed with the steering wheel buttons.

10.5.2.4. Deactivating Pilot Assist

When you want to stop driving with Pilot Assist, you can deactivate it manually. There are also situations in which Pilot Assist deactivates automatically.

Deactivating and activating Pilot Assist is done in the same way. You simply pull the right-hand side steering wheel stalk downwards. You can also deactivate Pilot Assist by braking.

When you deactivate Pilot Assist, all of its assistance is turned off. This includes speed- and distance-keeping as well as steering assistance.

Deactivating Pilot Assist using the stalk

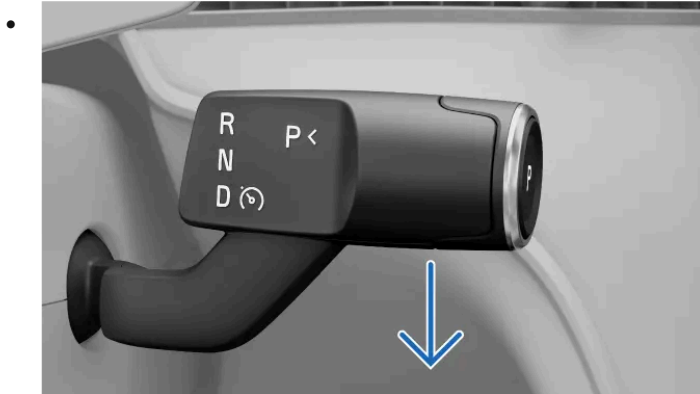

Pull the right-hand side steering wheel stalk all the way down.

> Deactivation is confirmed in the driver display.

Deactivating by braking

- Press down on the brake pedal.

> Deactivation is confirmed in the driver display.



Note

Automatic deactivation

Pilot Assist has several limitations and only works if all the necessary conditions are met. If the driving conditions change during your drive, Pilot Assist can deactivate automatically.

Scenarios where Pilot Assist may automatically deactivate include, but are not limited to, instances where:

- You are not driving actively. You must stay attentive and keep both of your hands on the steering wheel, even if steering assistance is activated.
- You open a door or unbuckle your seatbelt.
- You change gears. Pilot Assist can only support you when D is selected.
- You leave the direction indicator on for a long time when driving with steering assistance. This can indicate that you are not fully focused.
- You manually speed up and maintain a higher driving speed than the target speed. This indicates that you want to return to full manual control of your car.
- Camera or radar conditions for Pilot Assist are not met.

10.5.2.5. Adjusting the target speed for Pilot Assist

Pilot Assist can support you in keeping a set target speed. You can adjust the target speed with the steering wheel control buttons.

When you are driving with Pilot Assist active, you can select a target speed. The car then manages acceleration and braking to meet that target while also adapting to surrounding traffic.

You can adjust your set target speed by pressing the set speed adjustment buttons on your steering wheel's left-hand side control area. When this is possible, the driver display will provide information about which buttons to press.

The behaviour for changing target speed differs depending on whether your car is built for a market using km/h or mph as the standard speed unit. This behaviour doesn't change if you select a different speed unit in system settings.

For cars built for a km/h market:

Press once Adjust the target speed by 5 units.

Press and hold Adjust the target speed by 1 unit continuously by pressing and holding the button.

For cars built for a mph market:

Press once Adjust the target speed by 1 unit.

Press and hold Adjust the target speed by 5 units continuously by pressing and holding the button.

When you adjust by 5 units at a time, the target speed will default to speed increments that are divisible by five, such as 25, 30 and 35.

When **Adapt to speed limit** is enabled in settings, Pilot Assist can adapt the set speed to upcoming speed limit changes. The new speed limit then appears as a suggested set speed in the driver display for you to confirm.

1. Adjust the target speed using the buttons on the steering wheel.
- > Your new target speed is shown in green above the speedometer.

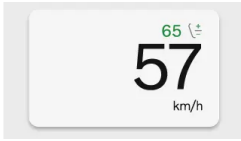

10.5.2.6. Enabling and disabling steering assistance when driving

Pilot Assist's steering assistance can be easily enabled or disabled using the steering wheel buttons. This allows you to control it without going into settings while driving.

Steering assistance is part of Pilot Assist and can only be used when Pilot Assist is active.

If steering assistance is unavailable for some reason, such as due to deteriorated lane markings, you won't be able to activate it. However, by enabling steering assistance, it will automatically activate when the required conditions are met.

1. Press the steering assistance button  on the steering wheel.
- > Steering assistance is either enabled or disabled.
- If enabled, steering assistance activates automatically when the required conditions are met.
- If disabled, Pilot Assist will remain active but mainly provide speed- and distance-keeping support.

10.5.2.7. Changing lanes with Pilot Assist

Lane change assist is a feature included in Pilot Assist that can support with lane changes to overtake other vehicles.

Pilot Assist automatically provides steering assistance during your lane changes if all conditions are met.

In addition to the general conditions for using Pilot Assist, conditions for assisted lane changes include:

- Both steering assistance and lane change assist are enabled in Pilot Assist's settings.
- Pilot Assist is active.
- The conditions for steering assistance are met.
- Your speed is in the range of 65-150 km/h (40-90 mph).

- The traffic situation allows a lane change.
 - The car checks if the conditions for an assisted lane change are met, such as the adjacent lane being available. However, the responsibility to assess and decide whether a lane change can be done safely ultimately lies with the driver.
 - There are road and driving conditions that do not supply the car with enough information for it to provide steering assistance during a lane change. In such situations, the driver can still perform unassisted lane changes. This disables steering assistance until its conditions are met again.
- You are driving on a motorway or a motorway-like road.

Lane change status is communicated via symbols and messages.

Symbols showing information about available or ongoing lane changes are shown below the gear indicator.



Lane change assist is available to use. The symbol shows an arrow to indicate the direction of a possible lane change. It can be shown for either side or both sides simultaneously. During ongoing lane changes, the arrow pointing in the direction of the lane change starts flashing.

Information about interrupted lane changes or faults affecting the car's ability to perform assisted lane changes is communicated using symbols and messages.



The ongoing lane change is interrupted. An assisted lane change manoeuvre can be interrupted if there is a change in conditions or traffic situation, or if you oppose the guided steering. The lane change is cancelled immediately. Take full control of the car as required.



Lane change assist is unavailable and any ongoing lane change is cancelled. This can happen if there is a fault affecting critical systems, such as steering assistance. Be attentive to any messages that may follow.



Warning

Lane change assist is a supplement to safe driving practices. It does not reduce or replace the need for the driver to stay attentive and focused on driving safely. Drive the car with the same attention to safety as required by a car without the ability to intervene.

1. When a lane change is available, use the turn indicator stalk to initiate the lane change.
- > The car recognises that you want to change lanes. If the necessary conditions are met, the car begins to guide your steering during the lane change.

Note

Keep your hands on the steering wheel

Keep both hands on the steering wheel during the lane change. You are responsible for intervening if needed. You can override the guidance from the car by braking, accelerating or steering at any time.

10.5.2.8. Inside overtaking prevention

The content of this manual represents the status of the user manual at the time of printing and may not be completely valid in future instances. For more information, refer to the first page for the complete disclaimer note.

Pilot Assist has a setting that, when enabled, can prevent high speed overtaking to the left of another vehicle.

You can choose how the car behaves when you are going faster than a vehicle in the adjacent lane on your right-hand side. Depending on the region, overtaking in such situations can be discouraged or even illegal.

Your car slows down to avoid overtaking another vehicle if all of the following conditions apply:

- **Prevent overtaking on the left** is enabled in settings.
- Pilot Assist is active.
- You are driving on a motorway or a motorway-like road.
- Your speed is above 80 km/h (50 mph).
- The vehicle you are approaching is in the right lane directly adjacent to you.
- The vehicle you are approaching is detected by your car.

Overriding the feature

You can easily override this feature if necessary. Just press down on the accelerator to speed up and pass the other vehicle. If there are more vehicles in front of the one you passed, your car will go past them as well.

Important

Driver responsibility

This driver support feature is a supplement to safe driving practices. It does not reduce or replace the need for the driver to stay attentive and focused on driving safely.

Driving on the other side of the road

Remember to turn off this feature if you are visiting a region where you will be driving on the other side of the road.

10.5.2.9. Adjusting Pilot Assist settings

You can adjust or change which features are enabled for Pilot Assist in settings.

Pilot Assist includes several features, some of which you can enable, disable or customise in settings. This allows you to set Pilot Assist up for the level of support you want.

The customisable settings include:

Steering assist	Guides the steering wheel movement to correctly position the car in the lane.
Lane change assist	Guides lane change manoeuvres initiated by the driver.
Prevent overtaking on the left	Prevents the car from making high speed passes on the left-hand side of other vehicles.
Curve speed assist	The driving speed is adapted ahead of known road features such as curves and roundabouts.
Adapt to speed limit	The speed limit of the road you're on appears as a suggested set speed in the driver display for you to confirm.
Time interval to vehicle ahead	Adjust the target time interval to vehicles ahead. This way, you can adjust the distance to vehicles in front of you.



Tip

Customise Pilot Assist features with the steering wheel buttons

Features such as steering assistance and target speed can be adjusted using the steering wheel buttons. The driver display typically shows what actions are available and which buttons to use.

Quick access

You can adjust the time interval to vehicles ahead via the contextual bar as well. This allows you to make quick adjustments, without going into settings.



Important

Changing driver support settings

Make sure that you understand how changing the car's settings affects its behaviour. It is particularly important when it comes to features that affect the level of assistance the car can provide.

1. Press the car symbol  in the bottom bar and go to **Settings**.
2. Go to **Driving** → **Pilot Assist**.
3. Customise the Pilot Assist settings to your preferences.



Note

Adjusting the time interval to vehicles ahead

Higher driving speeds may cause the general distance to a vehicle ahead to be longer than during lower speeds, even if the target time interval is the same. This is because the calculated distance becomes larger for the given time interval.

10.5.2.10. Pilot Assist conditions and limitations

To use Pilot Assist safely, it's important to be aware of its limitations. While it's an advanced function, there are conditions and situations that it cannot handle.

Driver responsibility when using Pilot Assist

While Pilot Assist takes over many tasks related to driving, you are still considered the driver and are responsible as such. When using the function, you are still required to actively and attentively drive the car. Pilot Assist does not know your intentions or the intentions of other drivers. It cannot predict or identify every potentially hazardous situation that an attentive driver can. It's your responsibility to continuously assess Pilot Assist's performance and act if necessary. As long as you judge its input to be correct, you can let it guide your driving.

Important

Driving conditions

Assessing Pilot Assist's performance requires that you take all driving, traffic, weather or road conditions into consideration. For example, if there is poor visibility you may need to increase the distance to vehicles ahead compared to the distance kept by Pilot Assist. The same applies to maintaining a speed that is safe for the current road and traffic conditions.

Improved safety and convenience

When used correctly, Pilot Assist can improve safety and reduce the effort of driving. In some cases, it can compensate for driver errors, such as mistakes caused by lapses of attention or distractions. This potential benefit is a supplement to safe driving practices. It does not reduce or replace the need for the driver to stay attentive and focused on driving safely.

Driver readiness

Using speed- and distance-keeping features can result in long periods of you not using the pedals. However, you must remain prepared and ready to brake or accelerate manually if necessary. Avoid changing your driving posture in ways that can delay your response time.

Hands on the wheel

Pilot Assist can guide your steering but you are still required to keep your hands on the steering wheel, just like when driving unassisted. As long as you judge the steering input to be correct, you can let Pilot Assist guide your steering.

Eyes on the road

When using Pilot Assist you must still remain attentive as a driver. This includes keeping track of your surroundings and the traffic around you, just like when driving unassisted.

Speed range for Pilot Assist

Pilot Assist is available at different speeds depending on the context of activation and use.

- When using Pilot Assist without steering assistance, you can set target speeds between 20-180 km/h (10-110 mph).
- When using Pilot Assist with steering assistance, you can set target speeds between 20-150 km/h (10-90 mph).
- Pilot Assist can be activated below 20 km/h (10 mph), but will then try to accelerate up to the minimum set speed.
- When following another vehicle, Pilot Assist can stay active below 20 km/h (10 mph).
 - In situations where you are driving slowly behind other vehicles, such as in a traffic queue, you may be able to use Pilot Assist despite driving slower than 20 km/h (10 mph). This requires a vehicle ahead whose speed your car can match. ^[1]

Activation and availability

Several conditions must be met to activate Pilot Assist. They can be related to the current traffic and road conditions or the car's system status. Some are related to the car being driving-ready, such as the driver wearing their seatbelt, keeping their hands on the steering wheel ^[2] and all doors being closed. Others relate to your current driving situation, such as driving at a speed within the speed range for Pilot Assist. Activation at a standstill requires a vehicle ahead within close distance. If activation is prevented, the specific reason is typically communicated in the driver display.

Keeping track of vehicles ahead

One of Pilot Assist's capabilities is to adapt the car's speed to a vehicle ahead and maintain a certain distance to it. Pilot Assist's behaviour and ability to track traffic ahead depends on several factors, such as your speed and the speed of the vehicle in front.

Very slow or stationary vehicles in front of you can make Pilot Assist behave differently, depending on the situation and your speed:

- If Pilot Assist follows a vehicle that comes to a stop, Pilot Assist slows your car down to a stop behind the other vehicle.
- If a stopped vehicle is detected ahead of you, Pilot Assist will slow your car down in an attempt to stop behind the other vehicle.
 - Depending on your driving speed, the car may not be able to reach a full stop behind the vehicle in front. You are always responsible for keeping track of the surrounding traffic and driving the car in a way that allows you to react and control it safely.
- When driving at high speeds, stationary vehicles in front of you can be misinterpreted by Pilot Assist, such as when catching up to a stationary traffic queue. In a situation like this, Pilot Assist will not consider the stopped cars or slow your car down. Always be attentive and available to control your car and brake when necessary.



Warning

Stopped or slow vehicles ahead

A stopped vehicle in your lane is a collision risk that requires you to act by braking or steering. ^[3]

- At speeds below 5 km/h (3 mph) Pilot Assist may pause when following another vehicle:
 - if there is uncertainty whether what's detected in front is a stopped vehicle or another object ^[4].
 - if the vehicle ahead makes a turn and leaves your driving path.

Car status and systems

Pilot Assist relies on the accurate detection and identification of surrounding traffic and road conditions. This includes using information from the cameras, radars and other sensors. The detection system cannot handle all driving, traffic, weather or road conditions. Read the separate manual sections about detection types, how they work and their limitations to better understand how Pilot Assist's performance can be affected.

Several of Pilot Assist's features depend on other systems in the car.

- To adapt the speed to vehicles ahead, the car uses a combination of radar and camera detection. Consequently, conditions and limitations of these systems can affect the availability and performance of this feature.
- Steering assistance is only available when the car can identify its position on the road through camera detection of lane markings.
 - This requires that the road conforms to certain standards.
 - Conditions and limitations of the car's camera detection can affect the availability and performance of steering assistance.
- Information about road features, such as upcoming sharp bends and roundabouts, depends on accurate map data. Availability and functionality of the map data service may vary over time and depend on region. This in turn affects the availability and performance of the curve speed assist feature.
- Not accepting Google's terms and conditions limits the availability and performance of Pilot Assist. You can manage your consent in privacy settings via the centre display.
- When Pilot Assist's target speed is set to adapt to the speed limit, the value is provided by the car's road sign information system. In some conditions, it may not be able to provide an accurate speed limit.

The content of this manual represents the status of the user manual at the time of printing and may not be completely valid in future instances. For more information, refer to the first page for the complete disclaimer note.

 **Important**

Car faults

Certain car faults can affect the availability of driver support features. Check the car status view for indicated issues if Pilot Assist is unavailable.

Car alterations

Modifications, repairs and accessory installations can negatively affect or limit driver support features. There is a separate manual section with detailed information on this topic.

Other conditions and limitations

- Pilot Assist is primarily intended for use when driving on level road surfaces. It may have difficulty keeping the correct distance to vehicles ahead on steep downhill slopes.
- Do not use Pilot Assist when driving with a trailer or heavy loads.

^[1] Pilot Assist's lowest target speed is 20 km/h (10 mph), even if your speed at activation is lower than that.

^[2] Wearing gloves can sometimes interfere with the hand-detection sensors on the steering wheel

^[3] Your car can still warn you of the collision risk and perform a safety intervention if you fail to react in time. This can happen separately from Pilot Assist's capabilities.

^[4] Such as obstacles designed to encourage slow driving.

10.6. Assisted parking

Your car has several features that can help you during parking, such as guidance through camera and sensor views. Learn how to use the different types of assistance.

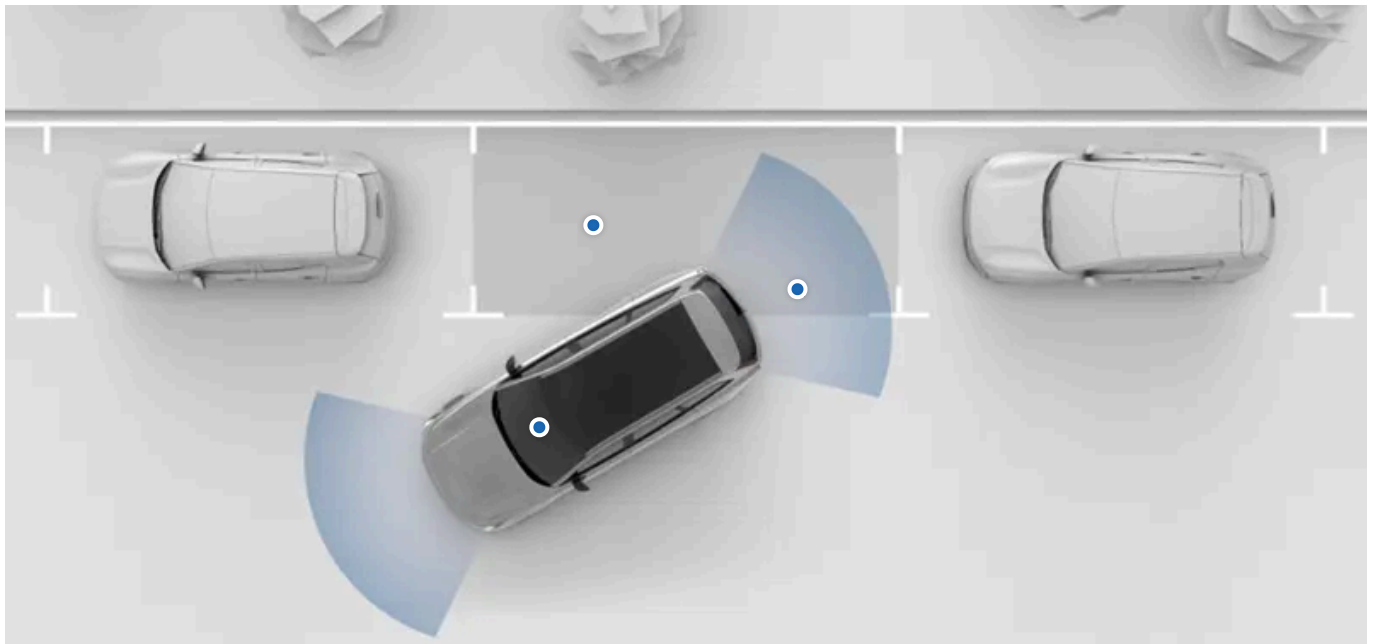

Your car's parking assistance features are available in the centre display's parking view. In most cases, the parking view opens automatically when you need it, but you can also open it manually.

The following parking assistance features are available in the parking view:

Distance and obstacle detection	The car senses the surroundings using many different sensors. It uses this information to guide you with sound, graphics and warnings when driving at low speeds.
Parking camera views	The car shows your surroundings using cameras located around the car.
Rear Auto Brake	The car can automatically brake if an obstacle is detected immediately behind the car while reversing at low speeds.
Park Pilot Assist	This feature can actively steer, brake and move in and out of parking spaces.

 **Important**

Required knowledge and driver responsibility

Assisted parking features are designed to make driving more comfortable and safer, but they do not reduce the need or responsibility of the driver to operate the car as safely as possible. Be sure to read all related information about a feature before using it. The section covering driver responsibility is essential reading for understanding the capabilities and limitations of your car's assisted driving features.

If you find anything unclear or have further questions, do not hesitate to contact Volvo support.

10.6.1. Parking view

The parking view contains both camera and parking sensor information to help improve your awareness of the car's surroundings. This can be useful when manoeuvring at low speeds, such as when parking.

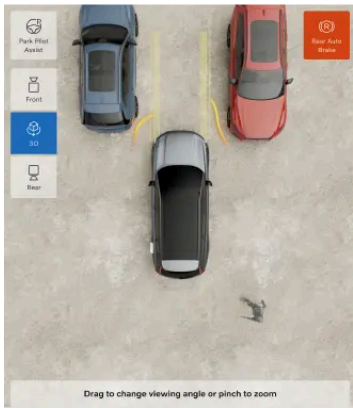

Accessing the parking view

In most cases, the parking view opens automatically when you need it. You can also access it by opening the camera app in the contextual bar.



The parking view closes automatically when you are driving above a certain speed. After parking, the parking view closes when you leave your car.

Features in the parking view

The parking view contains the following features:

- Camera views that also provides visual guidance and obstacle detection
- Rear Auto Brake, which can provide automatic braking for obstacles while reversing at low speeds
- Park Pilot Assist, which can actively steer the car in and out of parking spaces.

Camera views

There are several camera views to choose from.



Front A camera at the very front of the car provides the front view, along with a top view.



3D The car combines front, rear and side camera views to show the car in its surroundings. The standard perspective is to show the car from the top, but you can also change this view to show other perspectives.



Rear A camera at the back of the car provides the rear view, along with a top view.

Adjusting the 3D view

You can adjust the 3D view by dragging your fingers around to change the angle. You can also zoom in and out by pinching your fingers. Adjusting the view makes it easier for you to have a closer look in different angles and see things clearer in the

parking view.



Tip

Recentre the 3D view

You can always recentre the view by pressing the 3D view symbol. This allows you to return to the default 3D view again.

Automatic zoom in and out

If you approach an obstacle, the car can automatically zoom in on the part of the car that's closest to the obstacle. If you drive away from the obstacle or if the obstacle is removed, the car can automatically zoom out again.

Obstacle and distance detection

The parking view can provide visual as well as sound alerts if your car detects any obstacles in your close surroundings.

These alerts change if you go beyond a recommended stopping point. The colour of the visual indication shifts towards red and the sound changes when you get closer to the obstacle.



Important

Driver responsibility

Obstacle and distance detection is a supplement to safe driving practices. It does not reduce the need or responsibility of the driver to operate the car as safely as possible.

The driver is always responsible for paying attention to the car's surroundings and ensuring that it's safe to manoeuvre the car.

Detection limitations

The car's obstacle and distance detection capabilities have limitations. Read the separate section covering detection of car surroundings and traffic before using features that rely on these capabilities.



Note

Camera calibration

After servicing your car's parking cameras, they can sometimes take a while to re-calibrate themselves. This can lead to certain features, such as the parking view, being unavailable for a short time after having the car serviced.

10.6.2. Park Pilot Assist

Park Pilot Assist can help you manoeuvre in and out of certain parking spaces.

When active, Park Pilot Assist controls the car with high precision, allowing you to park in tight spaces. It's capable of both parking in and leaving a parallel parking space.

Important

Read everything

Read all information about the function before using it. It is important to know its proper use and limitations.

Detection of surroundings

Park Pilot Assist relies on the car's ability to detect its surroundings by using information from the parking sensors. The sensors use nearby objects to detect available parking spaces rather than road markings. For this reason, Park Pilot Assist can only identify a space if another vehicle is parked in front of it.

During Park Pilot Assist manoeuvres

Your car controls acceleration, braking and steering during parking manoeuvres. Even though Park Pilot Assist takes over the driving-related tasks of parking, you must still monitor the feature and its manoeuvres. This means that as long as you agree with what Park Pilot Assist is doing, you don't need to do anything to speed up, slow down or steer your car. However, you should always be ready to retake control of parking if you feel you need to.

Parking in a parking space

You can use Park Pilot Assist during parallel parking, when parking behind another vehicle. When you activate Park Pilot Assist, it identifies available spaces close to the car and presents one of them in the centre display. After confirming the suggested space to park in, you can let go of the steering wheel and start the parking manoeuvre by lightly tapping the brake pedal once. Your car then controls steering, braking and acceleration to park. Supervise the manoeuvre and follow any instructions provided in the centre display.

Leaving a parking space

You can use Park Pilot Assist to manoeuvre out of a parallel parking space. When you activate Park Pilot Assist, the car suggests an exit direction. Use the turn indicators to select and confirm which side you want to leave the parking space. After confirming the exit direction, you can let go of the steering wheel and lightly tap the brake pedal to start the Park Pilot Assist manoeuvre. Your car then controls steering, braking and acceleration to leave the parking space. Supervise the manoeuvre and follow any instructions provided in the centre display.

Warning

Pay attention

When using Park Pilot Assist, you must keep the same level of attention to your surroundings as if parking without assistance. Immediately take full control of the car if necessary.

Driver responsibility

The driver is always responsible for driving safely and in accordance with traffic rules and regulations. Park Pilot Assist is not a substitution for the driver's attention and judgement.

Limitations

Park Pilot Assist cannot handle all traffic, weather and road conditions. Read the separate manual section covering detection of car surroundings and traffic before using features that rely on these capabilities.

Stopping Park Pilot Assist

You can always stop an ongoing manoeuvre. Depending on how you do it, Park Pilot Assist either pauses or ends the manoeuvre.

There are several reasons to stop an ongoing Park Pilot Assist manoeuvre, such as:

- You want to take over and complete the manoeuvre on your own.
- The current placement is good and you don't need it to continue.
- You want it to stop for safety reasons.

To exit Park Pilot Assist, do any of the following:

- Press **Cancel** in the centre display.
- Start steering manually.
- Change gear.

Park Pilot Assist will stop automatically if:

- a pedestrian is detected close to the vehicle.
- the maximum allowed speed exceeds.
- the maximum number of moves exceeds.
- the slope is too steep.
- the car detects a system malfunction or failure.

You can also pause Park Pilot Assist by pressing the brake pedal.

Note

Automatic pausing of Park Pilot Assist

Park Pilot Assist may pause automatically during a manoeuvre if:

- a door is opened.
- the driver is no longer detected by the car's system.
- the car performs an emergency braking manoeuvre.

Extending a paused manoeuvre

Pressing and holding the brake pedal can pause the manoeuvre for up to a minute before it's cancelled. Releasing the brake pedal within this time resumes the manoeuvre.

Resuming a paused manoeuvre

You can resume the manoeuvre by pressing the brake pedal once. If you don't press the brake pedal after an automatic pause, the manoeuvre cancels after a short while.

10.6.2.1. Parking using Park Pilot Assist

You can activate Park Pilot Assist in the parking view. It's capable of manoeuvring the car into a parallel parking space.

The parking view often appears automatically, such as when you are reversing, but sometimes you need to open it manually. Find the Camera app in the contextual bar or the app library .



Important

Before using Park Pilot Assist

Take the time to read everything about Park Pilot Assist in this manual before using it for the first time. Understanding its capabilities and limitations is important for safe use.

Assess the situation

Make sure the traffic situation and conditions are suitable for activation. Park Pilot Assist can only assist you when parallel parking and uses nearby vehicles to help identify a suitable space. If no vehicle is parked in front of the space, the system may not detect it.

Your car controls acceleration, braking and steering during assisted parking manoeuvres. Even though Park Pilot Assist takes over the driving-related tasks of parking, you must still monitor the feature and its manoeuvres. This means that as long as you agree with what Park Pilot Assist is doing, you don't need to do anything to speed up, slow down or steer your car. However, you should always be ready to retake control of parking if you feel you need to.

Prevented activation of Park Pilot Assist

Certain events and conditions, such as a door being opened, can prevent activation of Park Pilot Assist. When the condition no longer applies, Park Pilot Assist can be activated.

Selecting an available parking space

1. In the parking view, press the Park Pilot Assist button.



- > The car begins scanning for available parking spaces.
2. Drive slowly in gear D to continuously scan for available spaces. Use the indicators to choose which side you want to park on.
 - > When the car identifies an available parking space, it's highlighted in the centre display. You need to pass a spot before it appears as available in the centre display.
 3. Stop the car and select the suggested parking space via the centre display to park there.

Starting the parking manoeuvre

The content of this manual represents the status of the user manual at the time of printing and may not be completely valid in future instances. For more information, refer to the first page for the complete disclaimer note.

4. Start the parking manoeuvre by lightly tapping the brake pedal once.

 **Note**

Your car won't begin any automatic manoeuvres until you have selected a parking space via the centre display.

5. Let go of the steering wheel and follow any further instructions in the centre display.

 **Warning**

Pay attention to your surroundings and take control of the car if necessary.

 **Note**

During Park Pilot Assist parking manoeuvres

You might experience Park Pilot Assist parking manoeuvres differently, depending on the situation. Sometimes, it might seem like the feature is a bit hesitant or that the car is going backwards and forwards a lot. This is just part of the parking process but it can be due to difficulties with detection, positioning or planning. In other cases, you might feel that the parking is very fast or straightforward. If your selected parking space becomes unavailable or the parking manoeuvre can't be completed, your car will notify you. If you don't see a notification, you can let the car continue parking as long it's safe to do so.

6. The car confirms when it has completed the manoeuvre and puts the car in park.

10.6.2.2. Leaving a parking space using Park Pilot Assist

You can activate Park Pilot Assist in the parking view. It's capable of manoeuvring the car out of a parking space when you're parallel parked.

The parking view often appears automatically, such as when you are reversing, but sometimes you need to open it manually. Find the Camera app in the contextual bar or the app library .



 **Important**

Before using Park Pilot Assist

Take the time to read everything about Park Pilot Assist in this manual before using it for the first time. Understanding its capabilities and limitations is important for safe use.

Assess the situation

Make sure the traffic situation and conditions are suitable for activation. Park Pilot Assist can only assist you when you are leaving a parallel parking space.

Your car controls acceleration, braking and steering during Park Pilot Assist manoeuvres. Even though your car takes over the driving-related tasks of leaving a parking space, you must still monitor the feature and its manoeuvres. This means that as long as you agree with what Park Pilot Assist is doing, you don't need to do anything to speed up, slow down or steer your car. However, you should always be ready to retake control if you feel you need to.

Prevented activation of Park Pilot Assist

Certain events and conditions, such as a door being opened, can prevent activation of Park Pilot Assist. When the condition no longer applies, Park Pilot Assist can be activated.

Selecting an available exit path

1. In the parking view, press the Park Pilot Assist button.



- > The car begins scanning for an exit path. Use the indicators to choose direction. When a path is identified, its direction is highlighted in the centre display.
2. Press the highlighted suggestion in the centre display to confirm the direction in which you want to exit the parking space.
3. Start the Park Pilot Assist manoeuvre by lightly tapping the brake pedal once.

 **Note**

Your car won't begin any automatic manoeuvres until you have confirmed an exit direction via the centre display.

4. Let go of the steering wheel and follow any further instructions in the centre display.

 **Warning**

Pay attention to your surroundings and take control of the car if necessary.

 **Note**

During Park Pilot Assist manoeuvres

You might experience Park Pilot Assist manoeuvres differently, depending on the situation. Sometimes, it might seem like the feature is a bit hesitant or that the car is going backwards and forwards a lot. This is just part of the process but it can be due to difficulties with detection, positioning or planning. In other cases, you might feel that the manoeuvres are very fast or straightforward. If your confirmed exit path becomes unavailable or the manoeuvres can't be completed, your car will notify you. If you don't see a notification, you can let the car continue as long it's safe to do so.

5. The car confirms when it has completed the manoeuvre and puts the car in park.

 **Note**

Due to safety reasons, the Park Pilot Assist manoeuvres won't position your car completely outside the parking space every time you use it to leave a parking spot. In most cases, the manoeuvres stop when the car reaches a good point for you to take over and continue driving. You can then fully exit the parking space without using Park Pilot Assist.

11. Scenarios and driving recommendations

The conditions you're experiencing sometimes affect how you can and should use your car. Knowing its capabilities and how you can adapt to the situation can have a significant impact on the outcome. The benefits range from avoiding outright hazards to getting the most out of your car's performance.



This section of the manual will cover specific driving scenarios. These include preparing for a long trip, wading through water and driving on icy roads. Exploring this section gives you a good idea of what features and practices can support you in demanding conditions.

11.1. Cold conditions

Driving and taking care of your car in cold conditions can be tricky. It requires different preparations and a different way of driving than a warmer climate does.

When driving in cold conditions, there are many things to take into consideration. From energy consumption and battery health to a comfortable climate and different safety aspects. Be sure to familiarise yourself with what this way of driving entails, as well as which laws and regulations may apply.

Visibility

In cold conditions, ice and condensation can obstruct visibility. Your car is equipped with defrosters, a heated rear windscreen and heated wing mirrors to prevent that from happening.

 **Warning**

Scraping the windscreen

The windscreen area in front of the front-facing camera has its own heating to defrost and remove any build-up of snow or ice. Do not use an ice scraper on this area as it can scratch the glass surface. Scratches or damage to the glass in front of the camera can interfere with or limit its detection capabilities.

Range

Your car's battery can be negatively affected by cold temperatures. When the car has a cold battery, a snowflake ❄️ appears next to the battery percentage. This indicates that the battery's charge capacity, performance and range are reduced compared to normal conditions. You can avoid this by always charging your car while it's parked, which can prove especially useful if you are parking in a cold climate.

When the battery warms up, for example during preconditioning of the car or when driving, the snowflake disappears from the driver display.

 **Tip**

Activating eco climate allows your car to make extra adjustments to increase your range.

If you feel like this makes the passenger compartment a bit too cold, you can use seat heating and steering wheel heating to keep warm, as these use less energy.

Maintenance

 **Note**

Frozen door handles

In rare cases, frost or ice may prevent the handles folding outwards. If this happens and the car is unlocked, you can still use the handles to open the car.

If ice buildup is preventing you from accessing the door handles, there are some steps you can try:

- Activate preconditioning in the Volvo app to heat the car.
- Carefully brush or tap the door handle to remove the ice manually.

Tyre pressure

As the temperature drops, the tyre pressure drops. Remember to check the tyre pressure regularly and adjust it as needed.

 **Important**

Cleaning in front of radars

If you find dirt, snow or ice, or if the car indicates that a radar is blocked, you should address it as soon as possible. Always clean and clear a large area around the radars to make their full field of view available.

Parking in cold weather

When the battery is cold, the car temporarily reduces battery performance until it's warmed up. Driving the car in a state of reduced performance doesn't harm the battery.

To avoid temporarily reduced performance from a cold battery, connect the car for charging and activate the car's preconditioning ahead of your trip. The car can then heat the battery without affecting performance and available range.

In temperatures below -30 °C (-22 °F), avoid leaving the car parked without charging for longer than 24 hours.

Important

You should always avoid completely running the battery down. If you need to leave your car in the cold, make sure it's sufficiently charged beforehand.

11.1.1. Winter driving recommendations

There are some things to keep in mind when driving in snow and on ice. Here are some tips and recommendations for safer driving and improved car system effectiveness.

Preparations for driving in winter conditions

- Cold weather is more demanding for the battery and can lead to temporarily reduced performance. For better battery performance, precondition your car before driving.
- Use washer fluid with antifreeze to avoid ice forming in the washer fluid reservoir.
- Volvo recommends that winter tyres are used when there's a risk of snow or ice.

Note

In some regions, winter tyres are required by law. However, keep in mind that not all countries allow studded tyres.

Recommendations for driving in winter conditions

Snowy and icy roads require careful driving different to that of driving on dry roads. There are a number of precautions to take that will help you drive more safely. For example:

- Remove all snow from your car before you start driving, both for your own sake and for your fellow road users. Pay special attention to the sensor areas, lights, roof and bonnet.
- Avoid any sudden steering wheel movements, strong acceleration or hard braking as it can cause the car to lose grip.
- Turn off one pedal drive or use the lowest one pedal drive setting.
- Keep a safe distance from the car in front of you, as you are likely to require a longer braking distance.
- Keep in mind that even if the sun melts the snow and ice, it can still be slippery.
- Even when other roads aren't icy, bridges can still be dangerous.

- Snow and ice can accumulate inside the mudguards, which can affect the steering. Check regularly and remove any snow, ice or debris.
- Braking capabilities can be negatively affected if snow and ice gather in the brake system. Check that the brakes work properly on a regular basis. However, only do so in a safe and careful manner.
- Sometimes, using snow chains can be a good idea. However, be sure to read the instructions on how to use them safely and effectively.

 **Warning**

Avoid parking on inclines during winter conditions. The tyres might lose traction, even if the parking brake is engaged. You are always responsible for safe parking.

 **Tip**

It's a good idea to practise driving on slippery surfaces under controlled conditions to learn how the car reacts. Visit a skidpan if you have access to one.

11.2. Wading recommendations

When driving through water, there are important limitations to consider regarding the water's depth and the driving speed.

 **Important**

Volvo recommends that wading is done with great caution and avoided when possible. It can be difficult to accurately assess the water's depth and the strength of the current. The driver is always responsible for driving in a safe manner and in compliance with all applicable rules of the road.

- If possible, determine how deep the water is before you start driving. Only attempt to drive through if you are confident it's shallow enough to safely wade through.
- Activate off-road to increase your car's ground clearance.
- The recommended deepest water level when wading is up to 45 cm (17 inches).
- Limit your speed to walking pace.
- Avoid wading in strong currents, especially if the water is deep enough to risk flowing over the car.
- Oncoming traffic can cause waves that increase how high the water reaches.
- If possible, avoid stopping when you're in the water. Carefully keep driving forward or reverse out of it.
- Avoid driving through saltwater as it can cause corrosion.



Warning

Wet brakes

The car's stopping distance is longer if the brake discs are wet. Driving through water exposes the brake discs to water, and possibly mud or other sediment. After wading, safely perform a hard braking manoeuvre to remove dirt and water from the brakes. By engaging the brake discs while driving, they heat up and dry.

11.3. Preparations for a long trip

Before you head out for a long road trip, there are a few things that are good to check.

- Make sure that the brakes work as intended.
- Check the tyres' tread depth and pressure. If there is a risk of snowy or icy roads, change to winter tyres.
- Ensure that the wipers are in good shape and change them if needed.
- Top up the washer fluid.
- Charge the car to the battery level you need for the first leg of your trip. It's a good idea to look up available charging stations along your planned route.
- Make sure that useful equipment is in place, such as charging cables, the puncture repair kit, first aid kit, a warning triangle and a reflective vest.
- If you plan to visit a region that uses different units of measurement, such as miles or kilometres per hour, you can change the car's unit settings.
- If you plan to visit a region with a different driver's side to your own, the exterior lights need to be altered. Make sure you familiarise yourself with how the car can reorient the exterior lights to match the driving situation.
- If driving to a region with other traffic laws, make sure the car is equipped as required and read up on what rules of the road differ from what you're used to.
- Remote areas may have bad or no internet connection. If you plan to drive in these areas, download the maps you need in the navigation app to be able to use them when your car is offline.

11.4. Long-term parking

Follow the long-term parking recommendations when your car will go unused for longer than one month. Remember to regularly check on the car when it's parked.

Long-term parking preparations

- When leaving your car parked for longer than one month, the recommended battery level is 40-60%. Use or charge the car to reach the recommended level.
- If you are leaving the car parked for longer than three months, it's recommended to keep it plugged in but set the battery charging limit to 50%. This is for better battery health.
- Check and adjust the tyre pressure. The recommended pressure during long-term parking is 330 kPA (48 psi).

- Choose a cool and shaded location. An environment with controlled and consistent conditions is recommended.

During long-term parking

Regularly check:

- the state of charge and that charging is working properly
- the tyre pressure.



Tip

Keep the car up to date

During periods when the car goes unused, make a habit of checking for and installing software updates.

After long-term parking

- Before driving the car, make sure all core driving controls and functions work properly, such as the brakes.
 - Install any available software updates.
-

12. Storage, stowing and towing

Your car is designed to transport people as well as luggage and other cargo. Learn about the car's stowing and towing capabilities.



The storage space under the bonnet can be used to store items, such as a puncture repair kit.

Your car's passenger compartment and boot have several areas for stowing items of different shapes and sizes safely. The boot can be expanded to create more space for larger cargo.

You can also use the roof for transporting heavy cargo and, with a towbar, you can attach a trailer.

Warning

It is important to properly store objects, even small items. Objects that are not stowed securely can be dangerous in the event of sudden braking or a collision.

Adding cargo to the car changes the car's weight and driving control properties. Always refer to the car's permitted weight regulations and guidelines.

Before towing a trailer, ensure that all connectors and safety attachments are secured. Also, be sure to follow local regulations regarding towing.

Important

Carrying loads on the roof may interfere with car sensors.

12.1. Passenger compartment storage

The content of this manual represents the status of the user manual at the time of printing and may not be completely valid in future instances. For more information, refer to the first page for the complete disclaimer note.

Find where the storage locations are in the passenger compartment.



- ① Centre seat backrest.
- ② Door panel storage compartments.
- ③ Pockets on the front seat backs.
- ④ Tunnel console.
- ⑤ Space under centre display.
- ⑥ Glove box.

There are also several small features which can be useful for storing specific items:

- Fold out the centre seat backrest to access cup holders.
- There are cup holders in the third row side panels.
- There are coat hooks by the rear seats along the inside of the roof.

i Note

The coat hooks by the third row seats should not be used.

12.1.1. Glove box

Store items that you don't immediately need in the glove box.

In the event of sudden braking or a collision, loose items can be hazardous. The glove box is useful for storing small items safely and securely.

The glove box is located in the dashboard in front of the passenger seat.

The glove box can be opened via the centre display.

12.2. Boot space and storage

The boot can be configured to accommodate cargo of different shapes and sizes.

You can adapt the boot in different ways and expand it to create a larger cargo space. This can be useful for storing larger items.



- ① Load cover
- ② Foldable rear seats
- ③ Cargo hold

You can extend and retract the load cover or remove it completely. Don't place items on the load cover.

Folding down the rear seats is ideal for loading large objects. Install a safety net when doing so to prevent objects moving into the front passenger compartment.

The cargo hold is accessed via the cargo hatch. It's useful for storing items.



Tip

Adjust boot opening height

You can adjust how much the boot hatch opens. This can be useful when you're parked in places with a low ceiling, such as a garage, and you want to reduce the boot opening height. You can also raise the boot opening height to create more room for accessing the boot.

Lower the rear for loading

To make it easier to load the boot, you can adjust the height of the rear of the car with buttons to the right in the boot.

Stowing cargo securely

You can also find options for stowing cargo securely, such as load-retaining eyelets, bag hooks and a net pocket. These features are useful for ensuring cargo doesn't move around the boot while you are driving.

12.2.1. Load cover

Use the load cover to hide items in the boot from view.

The load cover can be extended, retracted or removed.

Remove the load cover to create more space or more easily access the rear interior of the car.



Warning

Child restraints

Take care to keep the load cover and objects in the boot clear from the top tether straps of a child restraint. Contact with the straps can cause damage. Never use the child restraint if the top tethers are damaged in any way. When using a child restraint on the rearmost seats, remove the load cover. Furthermore, secure all objects in the boot.



Important

- Do not place anything on the load cover when it is extended. In the case of sudden braking or a collision, loose objects can move abruptly and cause injury.
- Do not leave the load cover in the car when it is not properly secured.
- When folding the rearmost seats down, first remove the load cover.
- When placing tall objects in the boot, it's best to remove the load cover. Instead, use the load-retaining eyelets to secure straps. You should also install a safety net.
- Keep in mind that large objects stored in the boot can reduce your driving visibility.

12.2.1.1. Installing the load cover

The load cover has a retractable screen to hide items in the boot from view.

The load cover is installed behind the second row seats. When the load cover screen is fully extended, it covers the whole of the boot storage space.

Make sure that the load cover is facing the right way up. You should be able to grasp the handle on the screen.

Fold the third row seats down to get unobstructed access to the grooves at the sides of the boot.



Keep the third row seatbelt out of the way when using the load cover. Pull the seatbelt back and hang it on the belt knob.



Remove the indentation covers in the sides of the rear boot.

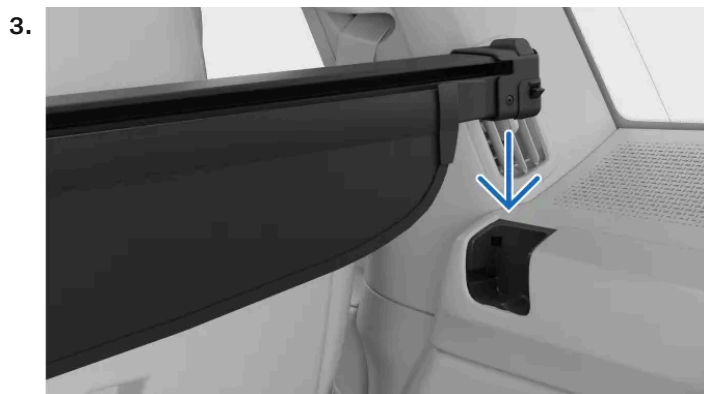

Push the load cover into the indentations until both sides of the load cover click into place. Ensure the locks are positioned so that the red marks are covered.

4. Pull the load cover screen by the handle until it is fully extended.

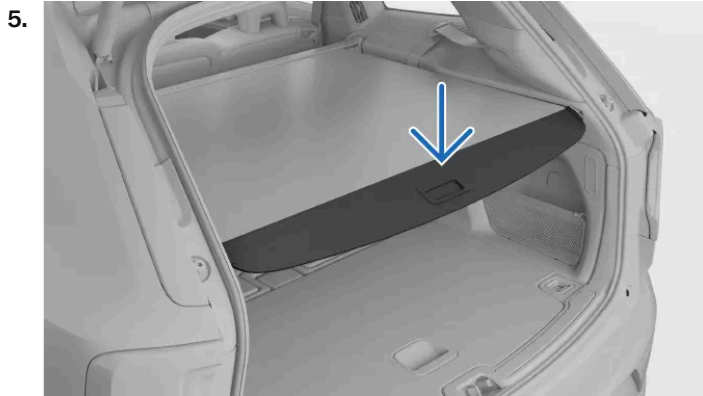

Tilt the outer edge of the load cover downwards so that it locks into position in the grooves.

! Important

It is not advisable to place objects on the load cover. They will not be secure and can cause damage in the event of a collision or sudden braking.

Large objects placed in the boot can obscure the driver's view through the rear windscreen.

12.2.1.2. Removing the load cover

The load cover can be removed to give you more space in the boot.

Retracting the load cover screen

1. Lift the end of the load cover screen upwards slightly to release it from its locked position. Keep hold of the handle while the load cover screen automatically retracts.

Removing the load cover

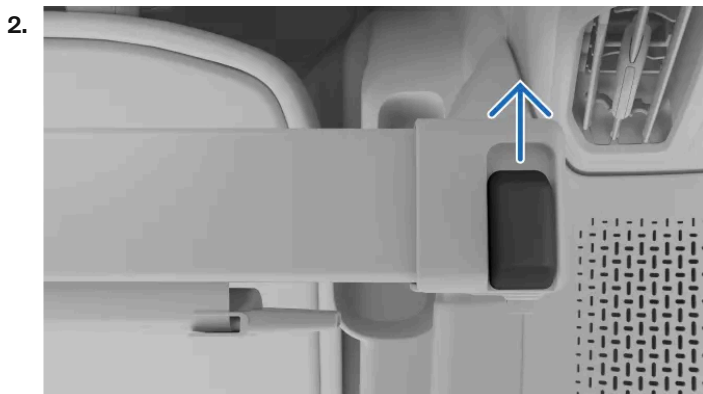

There are lock buttons at the ends of the load cover. Push the button on one side forwards and hold it in place while lifting the end of the load cover. Do this for the other end of the load cover as well.



Lift the load cover completely from the indentations at the back of the boot to remove it.

4. Put the indentation covers back on the sides of the rear boot.
5. Remove the seatbelt from the belt knob so that the seatbelt is ready to be used again.

Store the removed load cover somewhere it won't get damaged or be in the way for other people.

12.2.2. Removing the cargo hatch

You can make the boot space bigger and access the cargo hold more easily by removing the cargo hatch.

Removing the cargo hatch allows you to enlarge the boot space and easily access the cargo hold.

Clear all items from the boot to ensure that nothing will get in the way when you remove the cargo hatch.

1. Grasp the hatch handle. It is located in the middle of the cargo hatch, near the outer edge.
 2. Pull the hatch up and towards you.
- > The cargo hatch lifts out from the boot.

Place the cargo hatch where it can't get damaged or fall.

12.2.3. Installing the safety net

The safety net can be installed behind the front seats or the rear seats.

 **Warning**

There should be no occupants in the car to the rear of a safety net. A safety net can interfere with safety features such as airbags.

 **Important**

Do not use the safety net to secure large or heavy objects. Secure any large or heavy cargo with straps using the load-retaining eyelets located around the rear interior of the car.

When a safety net is in place behind a retractable seat, be careful not to recline or reposition the seat too far back.

When installing the safety net, make sure it is the right way round. The tightening straps should always be on the side facing you.

Installing behind front row seats

1. Remove the coat hooks from their sockets by twisting the hooks. Store them in a safe place for when you need the hooks again.
2. Insert each pin of the safety net into a coat hook socket. Push the pins forwards until they lock into place.



3. Fasten the lower corners of the net to the outer tether points behind the seats.



4. Tighten the straps to make the safety net tight and more secure.

- > The safety net is attached at all four points.



Installing behind second row seats



Insert each pin of the safety net into the sockets at the sides of the inner roof. Push the pins forwards until they lock into place.

6. Fasten the lower corners of the net to the load-retaining eyelets behind the seats.



7. Tighten the straps to make the safety net tight and more secure.

- > The safety net is attached at all four points.



i Tip

Removing the safety net

To remove the safety net, follow the installation steps in reverse order.

12.2.4. Stowing cargo in the boot

The boot has a number of options for stowing items. This can be useful for ensuring cargo doesn't move around the boot while you are driving.

The boot has several features to help stow items. These include:

- Load-retaining eyelets in the lower four corners of the boot for securely fastening objects with straps.
- Bag hooks for preventing shopping bags from falling over. They are located on the side panels.
- Net pocket on the side panel for storing smaller items.
- Cargo hold under the boot floor for stowing items.

Load-retaining eyelets



Load-retaining eyelets are located in the four corners of the boot. You can use the load-retaining eyelets to attach straps and secure cargo in the boot.

 **Tip**

In your boot, you can find a 12 V socket on the right-hand side. It can be useful for powering various electrical devices, such as a cool box.

12.2.4.1. Lowering the rear for loading

You can lower the rear of the car to make it easier to load items into the boot.

There are buttons for controlling the boot height adjustments on a small button panel on the right-hand side of the boot's interior. These buttons are marked with symbols.



Raising the rear of the car



Lowering the rear of the car

 **Warning**

Before adjusting the height of the rear, make sure there are no people, animals or objects under the car.

1. Press and hold a height adjustment button to start adjusting the rear of the car's height.

 **Tip**

You don't need to adjust the height again after loading the boot. The rear will return to its default height when you start driving.

 **Note**

If the bonnet or any of the doors are open, you can't adjust the rear of the car's height.

12.2.4.2. Accessing the cargo hold

You can access a storage area under the floor of the boot.

The cargo hatch can be lifted to store items in the cargo hold.

Clear all items from the boot before opening the cargo hatch.

1. Grasp the hatch handle. It is located in the middle along the outer edge.
2. Pull the hatch up.
3. Hang the cargo hatch on the bag hook by using the strap on the underside of the cargo hatch.



The hatch stays open and the cargo hold is now accessible.

12.3. Storage under the bonnet

In addition to the boot, there is storage space under the bonnet.

Examples of items that can be stored in the front cargo area include the car's warning triangle, tool kit, towing eye, charging cable and puncture repair kit.

 **Important**

Make sure the bonnet is shut properly after using the storage space.

12.4. Towing a trailer

The content of this manual represents the status of the user manual at the time of printing and may not be completely valid in future instances. For more information, refer to the first page for the complete disclaimer note.

The towbar allows you to tow a trailer with your car. Be sure to familiarise yourself with towing features and any relevant safety issues.

Before towing a trailer, consider how this will affect your journey. Make a thorough assessment based on your car's capabilities.

Trailer mode is automatically enabled when you connect a trailer to the car.

- Keep in mind that the car performs differently with added weight at the rear. This affects both handling and power usage. Expect a notable reduction in range when towing a trailer.
- Only use trailers in good working condition that comply with local regulations.
- Make sure you have read the separate section covering loading recommendations.

 **Note**

Software features connected to your towbar

Make sure that the towbar is properly installed.

When the towbar is installed but not locked, the associated symbol appears in the display.



If you've had the towbar installed after purchasing your car, a system update may be needed for the towing features to work. Contact an authorised Volvo workshop to update the software.

Maximum permitted trailer weights

The stated maximum permitted trailer weights are those permitted by Volvo. National vehicle regulations can further limit permissible trailer weights and speeds. Your towbar may be certified for a higher towing weight than the car can actually tow.

Towing preparations

1. Increase the tyre pressure to the recommended pressure for a full load. This applies regardless of the trailer weight.
2. Deploy the towbar and attach the trailer.
3. It's advisable to check that the trailer lights are in good working order.

Driving with a trailer

4. Read the recommendations for driving with a trailer thoroughly before you start driving.

 **Important**

While driving

- Maintain a low speed when driving with a trailer up long, steep ascents.
- Avoid driving with a trailer on inclines of more than 12%.
- The additional load increases the risk of overheating, which will be indicated in the driver display. Follow any instructions shown.
- Avoid parking on an incline if possible. The extra weight of the trailer can affect the parking brake's ability to securely hold the car. If you cannot avoid parking on an incline, be sure to block the wheels^[1] as a precaution.

Snaking

Snaking is a phenomenon that can occur when towing a trailer. It causes the car and trailer to resonate in a side-to-side motion, which can escalate quickly and cause loss of control. Snaking primarily occurs at high speeds, especially if the trailer load is too heavy or improperly distributed. The car continually monitors its movement and can intervene to help the driver regain control if it detects snaking.

Factors that introduce sideways motion can trigger snaking. For example:

- Sudden gusts and powerful side winds.
- Uneven road surfaces.
- Sweeping steering wheel movements from side to side.

Trailer stability assistance

The stability control system^[2] intervenes if it detects snaking when towing a trailer. The system precisely times individual braking actions for the front wheels to mitigate the snaking phenomenon. This is often enough to help the driver stabilise the car and trailer.

When the stability control system intervenes to suppress snaking, the electronic stability control symbol is shown in the driver display.



Electronic stability control symbol

^[1] If you do not have wheel chocks, you can use large stones or wooden blocks instead.

^[2] Electronic Stability Control (ESC)

12.4.1. Using the towbar

Your towbar can be extended or folded away as needed in a few quick steps.

The towbar can be used for connecting trailers or attaching objects to the car, such as bike racks. For safety reasons, it is important to carefully follow the instructions for using the towbar.

You can deploy the towbar by pressing the towbar deployment button. You can find the button on the right-hand side of the boot's interior, on the small button panel. When the towbar is available for use, the towbar symbol on the panel illuminates.



Use the same button to retract the towbar when you are done using it.

Note

Towing eye

As your car is equipped with a towbar, it only has a towing eye mount at the front of the car. The towbar replaces the need for a rear towing eye.

Tip

Status light

There is a light on the towbar release button that shows the status of the towbar.

- A constant light means that the towbar is ready to be deployed or retracted.
- A flashing light indicates that the towbar is moving.

After a while, the status light turns off to save power. Close and open the boot hatch again to restart it. If the car detects a connected trailer, the status light turns off and the towbar deployment button is disabled.

Warning

The towbar might become damaged or malfunction if it is not used correctly, or if incompatible or faulty accessories are used.

Do not press the deployment button if anything is attached to the towbar.

Do not stand too closely to the middle rear of the car while deploying the towbar.

Deploying the towbar

The content of this manual represents the status of the user manual at the time of printing and may not be completely valid in future instances. For more information, refer to the first page for the complete disclaimer note.

1. Press the towbar deployment button.

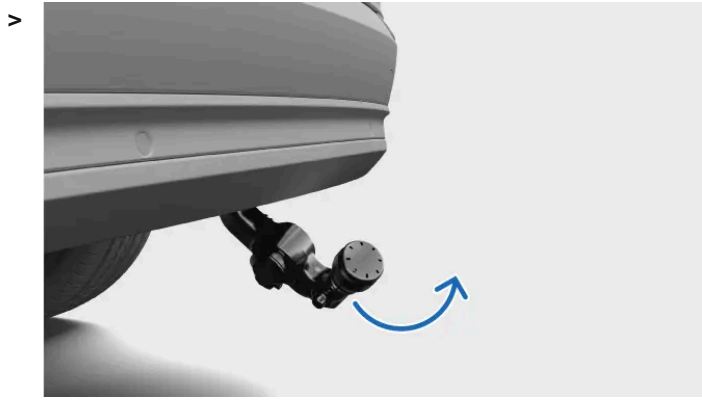

The towbar is deployed. As the towbar extends, the symbol on the deployment button flashes.

 **Warning**

Make sure the towbar is securely locked in position before attaching anything to it.

Always attach the trailer's safety wire or chain to the towbar's safety wire attachment bracket.

When you don't need the towbar anymore, retract it by pressing the towbar deployment button.

 **Important**

Make sure there is no plug or adaptor in the electrical socket when retracting the towbar.

Always ensure that the towbar is retracted when not in use.

If there appears to be any functional problems with the towbar, do not attempt to resolve the problem yourself. An authorised Volvo workshop is recommended for any repairs or servicing. Contact Volvo support to schedule an appointment.

12.5. Recommendations for loading

Proper loading is important for safety and your car's performance on the road.

Loading in general

Load weight and placement affects the car's centre of gravity, handling and performance.

 **Warning**

Unsecured loads

A loose object weighing 20 kg (44 pounds) can, in a frontal collision at a speed of 50 km/h (30 mph), carry the impact of an object weighing 1,000 kg (2,200 pounds). Always follow the loading recommendations to reduce the risk of material damage or personal injury.

- Place heavy cargo as low as possible.
- Always secure cargo to the load-retaining eyelets with straps or web lashings. Otherwise, it may shift during heavy braking or sharp turns. This is particularly important if the rear seats are folded down.
- Do not stow cargo where it may obstruct airbag deployment. If stacked cargo reaches above the upper edge of the windows, be sure to have at least 10 cm (4 inches) of clear space between the window and the cargo. Otherwise, the intended protection of the inflatable curtain, which is concealed behind the panels above the windows, may be compromised.
- Always comply with the car's specifications regarding weight and maximum permitted load.
- When loading the boot, position the cargo firmly against the rear seats' backrests.
- Avoid placing cargo against the back of the front seats. It may compromise the effectiveness of the front seat whiplash protection.
- Cover any sharp edges, corners and protrusions.
- Make sure that all cargo is secure for the duration of travel. You need to regularly check and re-tighten the straps as cargo can move during transit.
- Remove cargo you no longer need to have in the car. Reducing the car's overall weight improves both performance and range.

Roof loading

 **Important**

Any loads on the roof should not extend above the windscreen. This can interfere with car sensors.

Use a load carrier recommended by Volvo when carrying loads on the car's roof. This reduces the risk of damage to the car and helps ensure safety while travelling. Carefully follow the mounting instructions supplied with the load carriers.

Exterior loads affect the car's aerodynamics, handling and sensitivity to crosswinds. Increased drag affects energy consumption and range.

- Place heavy cargo as low as possible.
- Distribute the load evenly across the load carriers.
- For long loads that extend over the bonnet, fit the towing eye at the front of the car and use it to secure the load.
- Drive gently. Avoid heavy acceleration or braking, and sharp cornering.
- Remove the load carriers when you are not using them. It improves both performance and range. You can store the load carriers in the boot's cargo hold.

13. Care and maintenance

Keep the interior and exterior of your car in good condition with regular care and maintenance.



This section of the manual covers regular care and cleaning you can do yourself, information about some of your car's components that have specific maintenance needs and service maintenance information.

i Note

Volvo's maintenance programme

Adhering to your car's maintenance programme is highly recommended. A car in good condition contributes to traffic safety and operational reliability.

13.1. Car status

The car status view in the centre display is a useful aid for keeping track of your car's health. This is where the car shows you information about any detected issues.

The car status view shows a visual overview of your car and lists any detected issues. The issues are classified depending on severity. A minor issue may be something you can sort out on your own, such as refilling washer fluid. A critical issue may require a workshop visit before you can safely drive the car again. It's recommended to address issues as soon as they appear, especially if they're not minor.

 **Important**

The car is unable to detect and identify all types of issues that can occur. It is therefore important to regularly inspect the car's condition and address any service or maintenance needs you identify. Contact an authorised Volvo workshop for guidance if you are unsure of an issue's severity, regardless of whether it is indicated by the car or not.

To open the car status view, press the car symbol  in the bottom bar and go to **Status**.

13.2. Exterior cleaning and care

Keep your car's exterior in good condition by getting rid of dirt and taking care of any paintwork scratches as soon as you notice them. Ensure good visibility by keeping wiper blades in good condition.



Wash your car regularly, top up the washer fluid when needed and replace the wiper blades when they get worn. Taking care of your car's exterior doesn't just make it look nice, it also keeps your car in good condition.

13.2.1. Washing the exterior by hand

To avoid problems with cleaning ingrained dirt, wash the car regularly and as soon as it starts getting dirty. It reduces the risk of scratches and, of course, keeps your car looking good.

 **Important**

When and where to clean the exterior

- Clean your car as soon as it has attracted dust or dirt. This prevents the build-up of ingrained dirt, which often contains larger particles and debris that cause wear and damage, especially during cleaning.
- Remove bird droppings and tree sap or resin as soon as possible. These contain substances that can quickly damage and discolour the paintwork.
- Avoid washing your car in direct sunlight. This can cause cleaning agents or wax to dry out and act as abrasives.
- If the car has been exposed to corrosive substances, such as acid rain, salt, chemicals, iron powder, soot or ash, it needs to be cleaned as soon as possible to prevent damage. In areas with a lot of industrial emissions, more frequent washing is recommended.
- Clean the car in a dedicated cleaning area that collects the wastewater and make sure the water is treated according to environmental regulations. Make sure that there is an oil separator in the cleaning area.

High-pressure washing

- Make sure that doors, windows and hatches are closed.
- Use a circular motion and keep the nozzle at least 30 cm (1 foot) from the car's surface.
- Do not spray directly onto openings or sensitive areas such as locks, cameras, trim, air intakes or the charging port.

Do not wash while charging

Do not wash your car if the charging cable is connected.

 **Note**

- Be gentle and use the right cleaning equipment for the type of surface you are washing.
- Only use cleaning agents and car care products recommended by Volvo, and follow each product's accompanying instructions.

Full exterior washing

1. Start by rinsing the underbody, including the wheel housings and bumpers.
2. Rinse the entire car to dissolve and wash away dirt. For particularly dirty surfaces, you can use a cold degreasing agent.
3. Then use a sponge, car shampoo and plenty of lukewarm water to wash the entire car.
4. Dry the car with a clean, soft chamois cloth or a gentle squeegee. This reduces the risk of stains from dried water droplets, which require additional polishing.
5. Remove dirt from the drainage holes in the doors and clean out the door sills after washing the car.
6. If any bitumen stains from the road surface tarmac remain, use a tar remover to get rid of them.

If there are particularly stubborn dirt patches or if you don't get the desired result when cleaning your car, contact Volvo support for advice.

13.2.2. Washing the car in an automatic car wash

Volvo recommends that you wash the car by hand so that you can properly reach all parts of the car. However, an automatic car wash is a simple way to quickly clean your car as soon as it gets dirty.

Note

Volvo recommends that you do not use an automatic car wash during the first few months, when the car is still new. This allows the paintwork to harden properly.

Important

Before using an automatic car wash

- Make sure that doors, windows and hatches are closed.
- To avoid the door handles unfolding while in the car wash, lock the car.
- Reduce the alarm sensitivity if you won't be inside the car while it's being washed.
- Change wiper mode to off.
- Fold the wing mirrors in.
- Secure any auxiliary lights.
- Activate air recirculation.
- Deactivate driver support functions so that the car does not automatically brake or give unnecessary warnings.

1. Follow the instructions to drive into the automatic car wash and stop at the designated location.
2. If you are using a tunnel car wash:
 - Put the gear in N and take your foot off the brake. Do not apply the parking brake.If you are using a rollover car wash:
 - Put the gear in P to engage the parking brake.
3. When the wash is complete, follow the instructions and drive out.
4. Be sure to reset any functions you changed before you drove in.

 **Warning**

Always test the brakes after washing, including the parking brake. This helps prevent moisture from causing corrosion, which could reduce the brakes' performance.

If there are particularly stubborn dirt patches or if you don't get the desired result when cleaning your car, contact Volvo support for advice.

13.2.3. Polishing and waxing

If your car loses its lustre, it's time for a new coat of polish and wax. This gives the paintwork extra protection.

Feel free to wax your car whenever necessary, but you shouldn't need to polish it during its first year.

 **Important**

Be careful

- Do not polish or use products intended for high-gloss paintwork on surfaces that have matte paintwork. This may create a permanent gloss on the surface.
- Polishing glossy trim mouldings could wear away or damage the glossy surface layer.
- Avoid using polish or wax on rubber and unpainted plastic components.

Contact Volvo support for information on recommended cleaning agents and car care products.

1. Make sure the car is protected from direct sunlight. The surface should be no more than 45 °C (113 °F) when applying polish or wax.
2. Wash and dry the car thoroughly.
3. First polish the car, then wax it. Follow the instructions on the packaging carefully. Many products contain both polish and wax.

13.2.4. Touching up paintwork damage

Taking care of your car's paintwork helps to maintain the exterior. Inspect it regularly and repair damage straightaway to avoid further problems.

Common damage that may occur includes stone chips, scratches and marks along the edges of doors or bumpers.

 **Important**

Paintwork damage in front of a radar can affect the radar's detection capabilities. Contact a service point for repairs if you find any damage close to the radars. ^[1] If you're unsure about where your car's radars are, you can find an overview of their locations in a separate section of this manual.

 **Note**

Paint batches and brands may differ slightly in colour even if the colour code is the same. Therefore, even though you can touch up paintwork damage on your own, Volvo recommends that you always contact an authorised Volvo workshop to get help with any paintwork damage.

- Contact a Volvo dealer for recommendations on touch-up pens and spray paints.
 - The surface must be clean and dry before doing any touch-ups.
 - The temperature of the surface should be at least 15 °C (59 °F).
 - Follow the instructions for the touch-up pen or paint you're using.
1. Apply masking tape over the damaged area. Then peel it off to remove all loose paint.
 2. If there are uneven edges, you may need to gently polish around the damaged area using a very fine abrasive cloth. Clean the area thoroughly afterwards and let it dry.
 3. If the damage:
 - has not reached the metal and an undamaged layer of paint remains, you can apply touch-up paint directly to the cleaned surface.
 - has reached the metal, first use a primer.
 - is on a plastic surface, first use an adhesive primer for better results. Spray into the lid of the spray can and brush on a thin layer.
 - is a long scratch, use masking tape around the damaged area to protect the undamaged paintwork.
 4. Stir the primer thoroughly and apply with a fine brush, matchstick or something similar. Let it dry.
 5. Finish with a basecoat and clearcoat.

^[1] Volvo recommends an authorised Volvo workshop for all servicing and repairs.

13.2.4.1. Finding the paint colour code

You can find the car body paint colour code on the product label located on a pillar between the front and rear doors.

If there is damage to your car's paintwork, or it needs repairing or repainting, you need to know the exact colour of the paint.

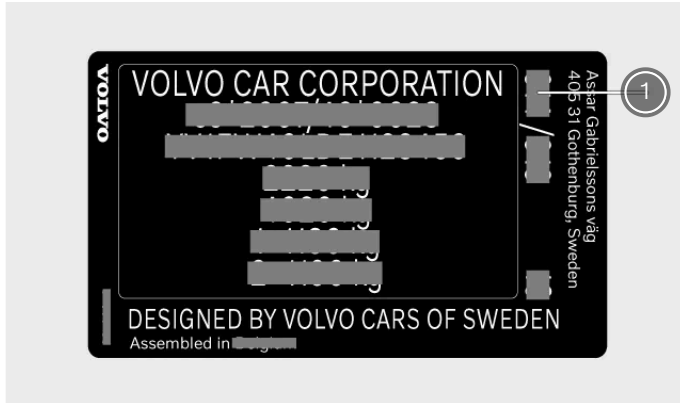

① Paint colour code

1. Go to the right-hand side of the car.
 2. Open the front and rear doors.
 3. Find the door pillar located between the front and rear doors.
- > The product label containing the colour code is located on the outer side of the door pillar, near the bottom of it.



13.2.5. Windscreen damage

It's important to repair a damaged windscreen as soon as possible. If you take immediate action, minor chips and cracks can often be repaired without replacing the entire windscreen.

Small cracks or chips

Small windscreen cracks or chips can quickly spread, turning it from minor to severe damage. Contact an authorised Volvo workshop if you notice glass damage. Repair the windscreen as soon as possible.

 **Important**

Camera and sensor area

Any windscreen damage in the camera and sensor area, including small chips, scratches or cracks, can negatively affect forward detection and features that use it.

- Any windscreen damage in this area requires inspection by a service technician.
- Volvo recommends not repairing small damage in the camera and sensor area. Instead, the entire windscreen should be replaced.

Severe glass damage

If the windscreen suffers severe damage, the entire glass panel needs to be replaced.

 **Warning**

Compromised safety

Do not drive the car if there is structural damage to the windscreen. Weakened glass can degrade very quickly, impair visibility and seriously compromise safety.

 **Note**

Compatibility of new windscreen

It's important that the new windscreen and its installation meet Volvo's specifications for safety and compatibility with the car's features.

Calibration

When a windscreen is installed, the forward-facing camera behind the glass requires function checks and calibration by a service technician to ensure that it works correctly.

13.2.6. Refilling washer fluid

The washer fluid reservoir cap is located under the bonnet. Be sure to use good quality washer fluid.

The car notifies you when the washer fluid level is getting low.^[1]

Note

Reservoir capacity

Your car can hold 10.2 litres (approximately 10.8 US quarts) of washer fluid.

Important

Washer fluid quality

- Use washer fluid with a pH between 6 and 8.
- If you use concentrated washer fluid, dilute it as instructed on the packaging and use clean pH-neutral water.
- Volvo recommends washer fluid with frost protection in cold conditions, especially in temperatures below freezing. This is to prevent damage caused by the fluid freezing inside the pump, reservoir and hoses.

1. Open your car's bonnet.

2.



Locate the blue cap with the washer fluid symbol and open it.

3. Pour the washer fluid into the reservoir. Avoid spillage if possible.

4. Close the cap and bonnet.

^[1] When there is about 1 litre (1 quart) left.

13.2.7. Cleaning wipers

Dirt, dust, sand, insects and different weather conditions are just a few of the things your wipers take care of. It's important to clean your wipers regularly to maintain good visibility and prolong the blades' service life.

1. Activate the wiper service position via settings in the centre display. This gives you better access to the front wiper blades.
2. Rinse the area with water to get rid of any loose dust and dirt.
3. Use a soft sponge with a lukewarm soap solution or car shampoo to clean the area. Lift the wiper arms from the windscreen for better access.
4. Use a clean, soft cloth to dry the wipers.
5. Make sure the wiper arms are folded back down against the windscreen, and then deactivate the wiper service position.

 **Important**

Test the wipers before driving. Use plenty of washer fluid when the wipers are in motion. The windscreen must be wet for the wipers to work properly.

13.2.8. Replacing front wiper blades

Your front wiper blades' service life is affected by the water, dirt and debris that they sweep off your windscreen. The wiper blades need to be replaced when they show signs of wear.

1. Activate the wiper service position via settings in the centre display.

2.



Fold the wipers up and away from the windscreen.

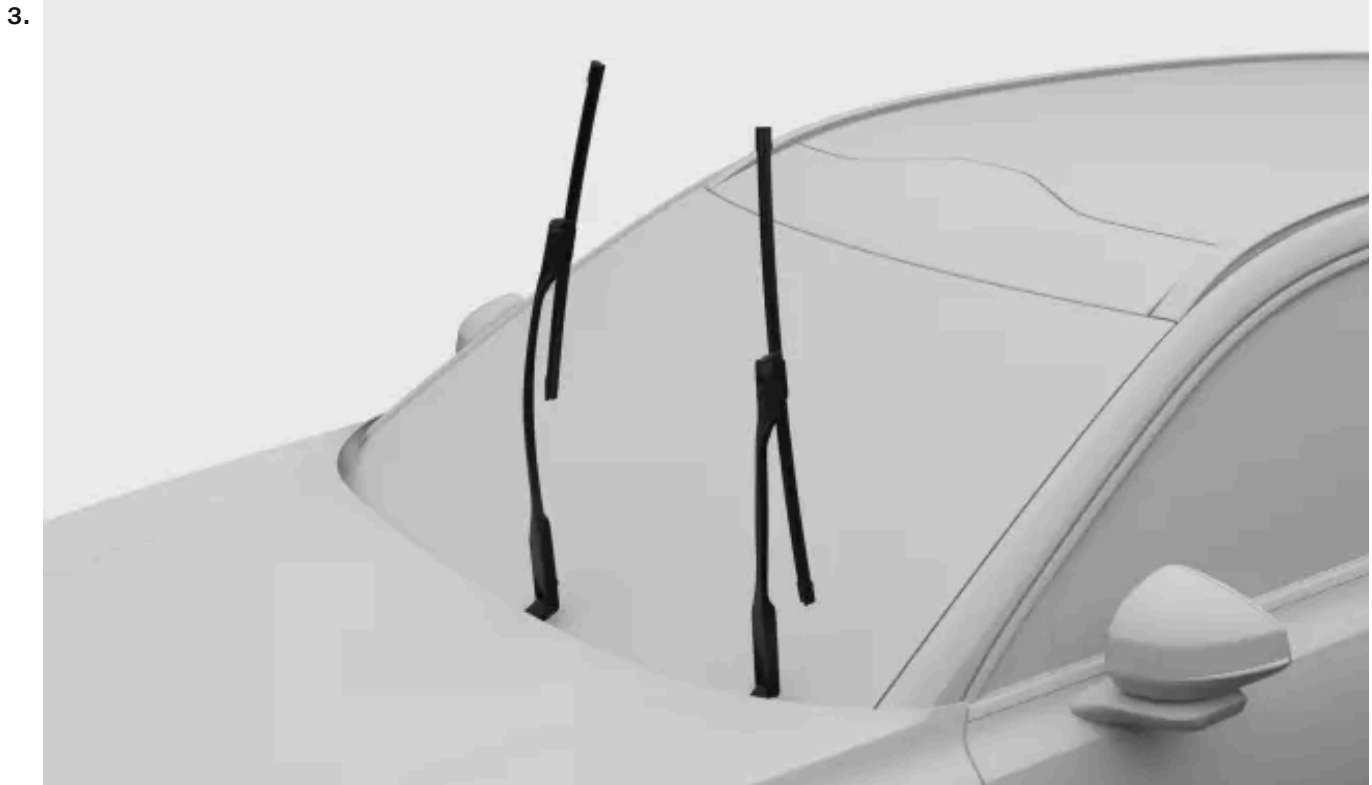

Carefully pull the lower half of the wiper blade upwards until the blade is horizontal.



Remove the wiper blade from the wiper arm.

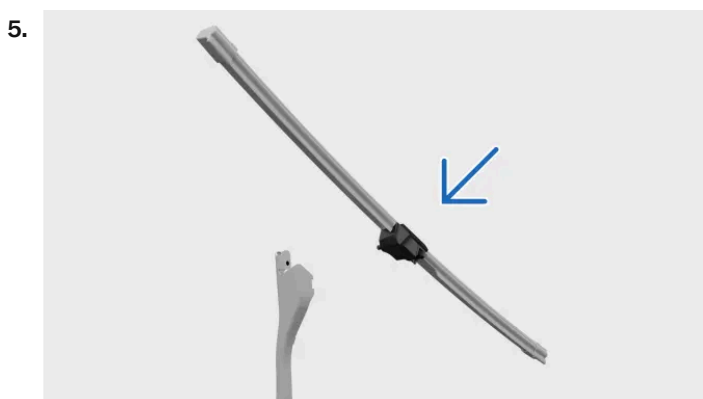

Make sure that the blade for the driver side is longer than the blade for the passenger side. Whilst keeping the wiper blade horizontal, slide the wiper blade onto the wiper arm. Ensure that the pin on the wiper arm goes into the hole on the wiper blade.

6. Grasp the lower part of the wiper blade and move it back down so that the blade is vertical. Push the blade into the wiper arm until you hear a click sound.

The content of this manual represents the status of the user manual at the time of printing and may not be completely valid in future instances. For more information, refer to the first page for the complete disclaimer note.

7. Check that the blade is firmly attached.
8. Fold the wiper arms back down against the windscreen.
9. Deactivate the wiper service position.

13.2.9. Replacing the rear wiper blade

Your rear wiper blade's service life is affected by the water, dirt and debris that it sweeps off your rear windscreen. The wiper blade needs to be replaced when it shows signs of wear.

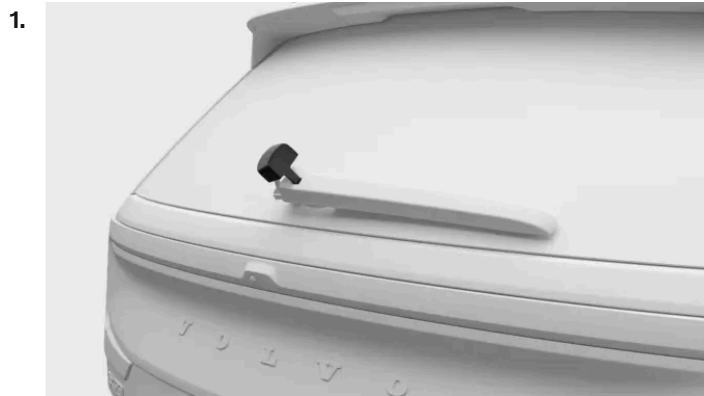

Find the plastic cover where the wiper arm attaches to the car. Loosen the side of the cover closest to you first and then the side furthest away from you. Lift the plastic cover up fully. This will give you access to the hose connector.



The content of this manual represents the status of the user manual at the time of printing and may not be completely valid in future instances. For more information, refer to the first page for the complete disclaimer note.

Disconnect the hose from the connector. You might need to wiggle it to get it loose.

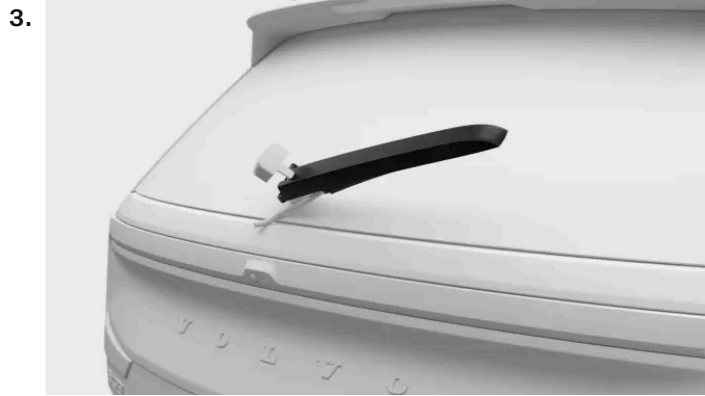

Grasp the centre of the wiper arm and lift it up and away from the rear windscreen. You may feel some resistance halfway – this is the lock position. You need to pull the wiper arm past the lock position so that it doesn't fall back onto the windscreen.



Pull the blade down until it loosens and comes away from the wiper arm.



Press the new blade into place until you hear a click.

6. Check that the blade is firmly attached to the wiper arm.

7.

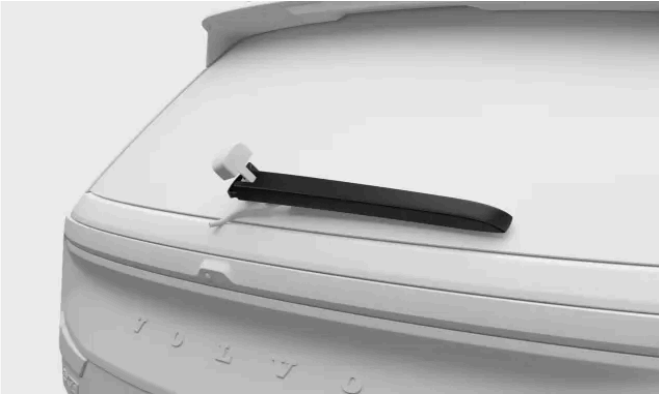

Fold the arm back down against the windscreen.

8.



Connect the wiper blade's hose to the hose connector. Lower the plastic cover back down.

Note

Make sure that the hose is positioned in such a way that it won't become trapped or pinched when the plastic cover is lowered back down.

13.2.10. Activating the wiper service position

The wiper service position allows you to clean or replace the front wiper blades. When activated, the wipers move to a more accessible position on the windscreen.

1. Press the car symbol  in the bottom bar and go to **Settings**.
 2. Go to **Controls** → **Mirrors and wipers** → **Wipers** → **Wiper service position**.
 3. Activate the service position.
- > The wipers move to a more accessible position and can be lifted up from the windscreen for servicing.

 **Important**

Fold the wipers down

Be sure to fold the wipers back down against the windscreen after servicing them. Activation of the wipers when they are in an elevated position can damage the car.

Once you have folded the wipers back down, deactivate the service position. This can be done by either of these options:

- The setting in the centre display.
- Start driving.
- Start using the wipers or washers.

13.2.11. Corrosion protection

A good way to reduce the risk of corrosion is to keep your car clean. Your car also has durable corrosion protection.

Normally, the corrosion protection doesn't require maintenance apart from regular cleaning and washing, which removes corrosive substances. Avoid using strong alkaline or acidic cleaning solutions on glossy trim components as they can cause corrosion. Road surfaces with gravel or small stones can lead to paint chips that can act as entry points for corrosion. Deal with such damage as soon as you notice it.

The car body's corrosion and abrasion protection consists of:

- protective coatings, both on the sheet metal and applied in a high-quality painting process
- shielding with plastic components
- corrosion-resistant cast aluminium used for exposed components of the wheel suspension.

13.3. Interior cleaning and care

The content of this manual represents the status of the user manual at the time of printing and may not be completely valid in future instances. For more information, refer to the first page for the complete disclaimer note.

Keep the interior of your car in good condition by taking care of its materials and keeping them clean.

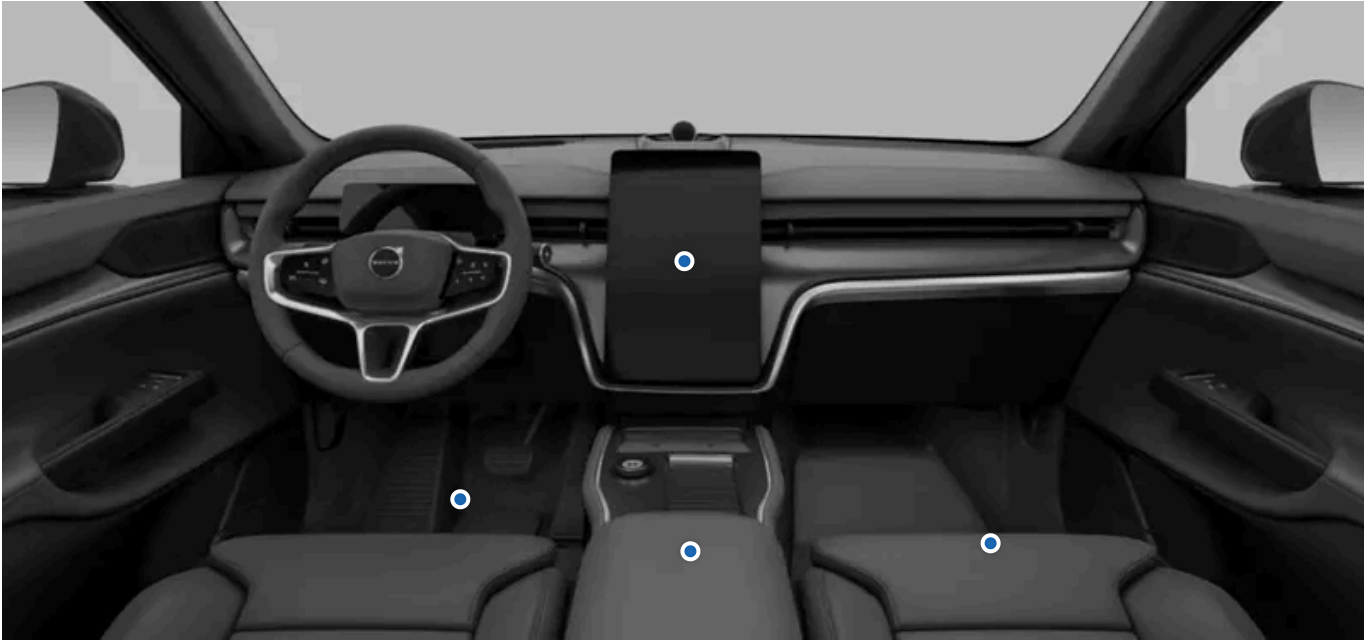

Use the passenger compartment's storage areas and the cup holders to keep your car tidy. Always take care of stains and dirt as soon as you notice them to avoid permanent staining.

If there are particularly stubborn dirt patches, or if you don't get the desired result when cleaning your car, contact Volvo support for advice.

13.3.1. Cleaning fabrics and textiles

If you get a stain on the car's interior, such as on the headlining or seat upholstery, clean it as soon as possible.

These recommendations apply to various interior fabrics.

 **Important**

When cleaning upholstery

- Never scrape or rub dirty surfaces. Instead, use gentle circular motions. Remember that sharp objects or abrasive materials can damage the car.
- Always clean the entire upholstery. Cleaning only spots on the upholstery can leave water rings or other marks.
- Do not remove surface upholstery during cleaning.
- Certain clothes, such as jeans or suede, can discolour the textile upholstery.
- Be careful when cleaning the headliner as harsh treatment may damage it.
- Only use cleaning agents and car care products recommended for cleaning textiles, and follow each product's accompanying instructions.

 **Warning**

Seats with side airbags

Never spray a cleaning agent directly on the sides of seats with side airbags. Instead, wipe them clean with a cloth lightly dampened with a suitable cleaning agent.

1. Vacuum clean or dust off the area to remove loose dust and dirt.
2. Clean the area with a neutral-coloured, clean and lint-free microfibre cloth that is lightly dampened with water or a colourless, mild cleaning agent. Use gentle circular motions.

 **Tip**

To wash the textile upholstery, an upholstery cleaning machine is recommended for extracting the cleaning solution and performing a water rinse.

3. Let the material dry fully before use.

 **Important**

Cleaning seatbelts

When cleaning a seatbelt, keep it extended until fully dry.

13.3.2. Cleaning leather and vinyl

The leather and vinyl in your car can be impacted by dirt and coloured garments over time. You need to clean and treat the surface to make it more resistant to damage.

These leather cleaning recommendations only apply to real leather details.

 **Important**

When cleaning upholstery

- Never scrape or rub dirty surfaces. Instead, use gentle circular motions. Remember that sharp objects or abrasive materials can damage the car.
- Do not use a steam cleaner on leather.
- Do not remove surface upholstery during cleaning.
- Do not use leather and vinyl cleaner on textile surfaces.
- Only use cleaning agents and car care products recommended by Volvo, and follow each product's accompanying instructions. Contact Volvo support for more information.

 **Warning**

Seats with side airbags

Never spray a cleaning agent directly on the sides of seats with side airbags. Instead, wipe them clean with a cloth lightly dampened with a suitable cleaning agent.

1. Vacuum clean or dust off the area to remove loose dust and dirt.
2. Use a neutral-coloured, clean micro fibre cloth lightly dampened with cleaning agent and clean the area with gentle circular motions.
3. Let the upholstery dry fully before further use or applying any treatments.

13.3.3. Cleaning glass and glossy surfaces

Clean surfaces such as displays, mirrors and touch buttons regularly and gently.

 **Important**

When cleaning glass and glossy surfaces

Do not scrape or use any abrasive cleaning agent on displays, mirrors and touch buttons. This can damage the reflective surface.

1. Vacuum clean or dust off the area to remove loose dust and dirt.
2. Use a clean microfibre cloth lightly dampened with water and clean the area with gentle circular motions.

3. Let the surface dry fully before use.

13.3.4. Cleaning interior plastic, metal and wood components

Clean panels and controls regularly, and deal with stains straightaway.

 **Important**

Be gentle

Never scrape or rub dirty surfaces. Instead, use gentle circular motions. Remember that sharp objects or abrasive materials can damage the car.

1. Vacuum or dust the area to remove loose dust and dirt.
2. Use a clean microfibre cloth lightly dampened with water and clean the area with gentle circular motions.

 **Important**

Never spray fluids directly on electrical components, such as buttons or controls.

3. Let the material dry fully before use.

13.3.5. Cleaning mats

Clean the mats regularly and always make sure they are properly in place.

 **Important**

Be gentle

Never scrape or rub dirty surfaces. Instead, use gentle circular motions. Remember that sharp objects or abrasive materials can damage the car.

1. Remove the mats for separate cleaning and access to the floor. Grasp the mat by the fastening pins and lift it straight up.

2. Vacuum the mats and floor to remove loose dust and dirt. Do not shake or beat the mats to remove dust and dirt as they can crack.
3. Clean the area with a neutral-coloured, clean microfibre cloth that is lightly dampened with water or a colourless, mild cleaning agent. Use gentle circular motions.
4. Let the mat dry fully before putting it back. Fix it into place by pressing down near each pin.

 **Warning**

Only use one mat for each seat and make sure the mats are properly fastened using all pins. If the driver's mat is not properly attached, it can move around and endanger your driving by getting caught near or under the driver pedals.

13.4. Wheels and tyres

The tyres' purpose is to carry your car's load, grip the underlying surface well, reduce vibration and protect the wheel rim from wear. Get familiar with the recommendations to get the most out of your wheels and tyres.



Familiarise yourself with tasks such as how to maintain a correct tyre pressure and how to change wheels so you are comfortable in these situations.

13.4.1. Wheel and tyre recommendations

Volvo recommends that you only use wheel rims and tyres that have been tested and approved by Volvo and are genuine Volvo accessories. A complete wheel refers to when tyres are fitted onto wheel rims.

Recommended tyres

On delivery, the car is equipped with Volvo original tyres that have the VOL marking on their sides^[1]. These tyres are carefully adapted to the car. It is therefore important that if you change tyres, the new tyres also have this marking in order to maintain the car's driving characteristics, comfort and electricity consumption.

Original tyres

Your car is originally equipped with tyres according to the label found on the pillar by the driver door.

The tyres have good roadholding properties and provide good driving characteristics on dry and wet road surfaces. Remember, however, that the tyres have been developed to provide these properties on roads that are free from ice and snow. Even if the car is equipped with stability systems or all-wheel drive, these tyres are not designed for winter driving. Change to winter tyres when the weather requires you to.

Some cars are equipped with a combination of tyres and wheel rims with extra-high performance. They are designed to be capable on dry road surfaces and with resistance against aquaplaning. These may be more sensitive to damage on the road surface and, depending on conditions, may have a shorter service life.

"All-season" tyres provide slightly better roadholding on slippery road surfaces than tyres without the "all-season" classification. However, for good roadholding on icy or snow-covered roads, Volvo recommends winter tyres on all four wheels.

Tyre age

Volvo recommends that tyres should be changed after 6 years from the date when they are first used. If you are unable to determine the date, use the DOT^[2] marking on the tyre sidewall. Tyres age and deteriorate over time, even if they are rarely used. The function can therefore be affected. Heat caused by hot climates, frequently carrying heavy loads or exposure to ultraviolet (UV) radiation may accelerate the ageing process. Cracks or discolouration are examples of external signs which indicate that the tyre is unsuitable for use. A tyre that has visible signs of deterioration should be changed immediately.

Replacing tyres

Note that the front and rear pairs of wheels have different dimensions. Never switch originally fitted wheels between the front and rear axles.

When you replace your tyres, you must make sure that all four tyres have the right size designation for their corresponding axle, are of the same type (radial) and are preferably from the same manufacturer as the original tyres. Volvo recommends that you use VOL marked tyres. Otherwise there is a risk of changing the car's roadholding properties and driving characteristics.

If the wheels are fitted incorrectly, the car's braking characteristics and capacity to deflect rain and slush are adversely affected.

Wheel rims and tyre sizes

 **Warning**

- Your Volvo's wheel rim and tyre sizes are specified to meet stringent requirements for stability and driving characteristics. Unapproved combinations of wheel rim size and tyre size may have a negative effect on the car's stability and driving characteristics.
- Any damage caused by the fitting of unapproved combinations of wheel rim size and tyre size are not covered by the new car warranty. Volvo accepts no liability for death, personal injury or any costs caused by such installations.
- Do not use steel or aluminium wheel rims which are damaged, cracked or deformed, which have extensive corrosion damage, or which have been welded or repaired.

^[1] There may be deviations for certain tyre dimensions.

^[2] Department of Transportation

13.4.1.1. Tyres and wheel storage

To keep them in good condition, you should always store wheels that are not in use in a cool, dry and dark place. How you place them, as well as avoiding exposure to chemicals, is also important.

When you store wheels that are not in use, it's important to keep them from direct sunlight, rain, water, heat sources or sparks. They should never be stored near solvents, petrol, oils or similar substances. Especially flammable ones.

Store wheels^[1] hung up or lying on their sides on the floor. If you store tyres not fitted on rims, you should never hang them up. Be sure to store them standing upright or lying on their sides. If you hang up rimless tyres they may become deformed.

^[1] Tyres fitted on rims

13.4.1.2. Tyre economy

To preserve your tyres as much as possible, there are some things you should keep in mind.

- Correct tyre pressure reduces uneven wear. It's important to check the pressure regularly.
- Hard acceleration, heavy braking and driving in a way which causes screeching tyres lead to increased tyre wear.
- Tyre wear increases with speed.
- Unbalanced wheels cause uneven and excessive tyre wear as well as reduced ride comfort.
- Wheels must have the same direction of rotation during their entire service life.
- The rear tyre grip should always be equal to, or better than, the front tyre grip to reduce the risk of oversteering in case of heavy braking.
- Tyres or wheel rims may be damaged permanently if you hit kerb stones or drive into deep holes.
- Driving style, road conditions and climate affect the tyre wear.

The content of this manual represents the status of the user manual at the time of printing and may not be completely valid in future instances. For more information, refer to the first page for the complete disclaimer note.

13.4.2. Designations on tyre sidewall

There are many digits, numbers and symbols that may be found on a tyre's sidewall. Here are some examples and explanations of what they indicate.

Note

Be aware that the following tyre designations are only examples. Not all of these designations may be available for your tyres and there may be designations on your tyres which are not included here.

Tyre dimensions

All tyres have a designation of dimensions, such as: 265/40 R21 98 W.

- 265** Tyre width (mm).
- 40** Ratio between tyre wall height and tyre width (%).
- R** Radial ply. The designation RF and symbol specify that the car is equipped with puncture-resistant tyres.
- 21** Rim diameter (inches).
- 98** Codes for the maximum permitted tyre load, Load Index.
- W** Speed rating for maximum permitted speed, Speed Symbol.

Wheel rim dimensions

All wheel rims have a designation of dimensions, such as: 8J x 19 x 50.

- 8** Rim width (inches).
- J** Rim flange profile.
- 19** Rim diameter (inches).
- 50** Offset in mm (distance from wheel centre to wheel contact surface against the hub).

Weather condition classification

Here are some classification examples. Weather capabilities can also be defined with certain symbols.

- M+S or M/S** Mud and Snow.
- AT** All Terrain.
- AS** All Season.

Tyre age

DOT YLX2 0819 Tyre Identification Number or TIN. This information helps the tyre manufacturer identify tyres in the event of safety recalls.

1. DOT^[1]
2. The first two or three characters are the code for the plant where the tyre was manufactured.
3. The next two characters are the tyre's size code.

4. The last four digits specify the week and year the tyre was manufactured. For example, 0819 means that the tyre was manufactured during week 08, year 2019.

Any numbers or letters shown in between are market codes chosen by the manufacturer.

Max load and pressure

Max load 685 kg (1610 lbs). Specifies the maximum load that the tyre can carry.

Max pressure 240 kPa (35 psi). The maximum tyre pressure that the tyre should ever be subjected to. This limit is specified by the tyre manufacturer.

Minimum permitted load index and speed rating



Warning

The minimum permitted load index (LI) and speed rating (SS) for the tyres for each respective motor variant are shown in the specifications sections. If a tyre with too low a load index or speed rating is used, it may overheat and become damaged.

Type, materials and tyre rotation

P	Indicates that the tyre is for passenger vehicles.
VOL	Volvo original tyres.
Plies: Tread 2 polyester, 2 steel, 1 polyamide. Sidewall 2 polyester.	States the number of cord layers or number of layers with rubber-coated fabric in the tyre's tread and sidewall. The tyre manufacturers must also state the layer materials used in the tyre and sidewall, which may be steel, nylon, polyester and certain other materials.
Arrow symbol	Tyres with a tread pattern designed to only turn in one direction have the direction of rotation marked with an arrow.

Classification of uniform tyre quality

Treadwear grade 200	The treadwear grade is a comparative rating based on the wear-rate of the tyre in a standardised test. A higher value is better.
Traction grade AA	The traction grade is based on standardised straight-ahead braking traction tests. The traction grades, from highest to lowest, are AA, A, B and C.
Temperature grade A	The temperature grade reflects the thermal performance of a tyre that is properly inflated and not overloaded. The temperature grades, from highest to lowest, are A, B and C.

^[1] Department of Transportation

13.4.2.1. Tyre tread wear indicators

There are tread wear indicators to show the status of the tyre's tread depth.



The narrow grooves that run lengthways across the tyre's tread pattern are tread wear indicators. On the side of the tyre are the letters TWI^[1].

! Important

- Tyres should be changed before wearing them down to the tread wear indicators to avoid poor traction in rain and snow.
- Volvo recommends that winter tyres have a greater tread depth than 4 millimetres (1/8 inch) and summer tyres 1.6 millimetres (1/16 inch).

^[1] Tread Wear Indicator

13.4.3. Changing wheels

If you need to change a wheel, it's important to follow the recommended procedure.

! Warning

Raising the car to change a wheel

Changing a wheel requires that you raise the wheel off the ground. Carefully follow the separate instructions for raising the car safely.

- If you are changing a wheel in or close to traffic, make sure you and the car are clearly visible to others. Activate the hazard warning lights, put out a warning triangle in a visible but safe place and wear a reflective vest.
- Designate a safe space for passengers to wait, away from both the car and traffic.
- You are responsible for safety around the car while it is raised. Do not allow people inside or close to the car.
- Never get under the car, or let anyone reach under it with any part of their body, while it is raised with a jack.

 **Note**

You must activate jack mode before raising the car off the ground.

Before removing the wheel

The wheels on your car are fastened with wheel bolts. For extra security, you can use lockable bolts.

 **Important**

- Make sure that the dimensions of the replacement wheel are approved for your car.^[1]
- Make sure you read through all the instructions before you start. Get all the tools you need before the car is raised.^[2]

Removing the wheel

1. Remove the wheel fastener cap manually. You don't need any tools to do this.
2. While your car is still on the ground, use the wheel wrench to loosen the wheel fasteners approximately 0.5-1 turn. Press the wrench downwards while the wrench is extended to the left to avoid personal injury. The anticlockwise rotation loosens the fastener. If you have fasteners that are lockable bolts, start with them.
3. Follow the instructions on how to safely raise the car. Be sure to activate jack mode.
4. Raise the car high enough so that the wheel you want to remove is off the ground. Remove the fasteners and lift off the wheel.

 **Tip**

When switching wheels between winter and summer, mark which side they were mounted on, for example L for left and R for right.

Mounting the wheel

5. Clean the surfaces between the wheel and hub.
6. Mount the wheel. Make sure you tighten the fasteners. However, the final tightening to the specified torque is done when the wheel is back on the ground and unable to rotate while you do it.

 **Warning**

- The front and rear wheels have different sizes. Make sure you put them on the correct axle. Incorrectly mounted wheels can affect the car's handling.
- Never use lubricant on the threads of wheel fasteners. It could cause the wheel fasteners to loosen after tightening.

7. Lower the car back to the ground.
8. Fasten the fasteners crosswise. If you are using lockable bolts, finish with those.

It's very important that the fasteners are properly secured. Tighten to 140 Nm (103 lb-ft). Check the tightening torque with a torque wrench. Overtightened or loosely tightened fasteners may damage the fastening threads or the wheel itself.

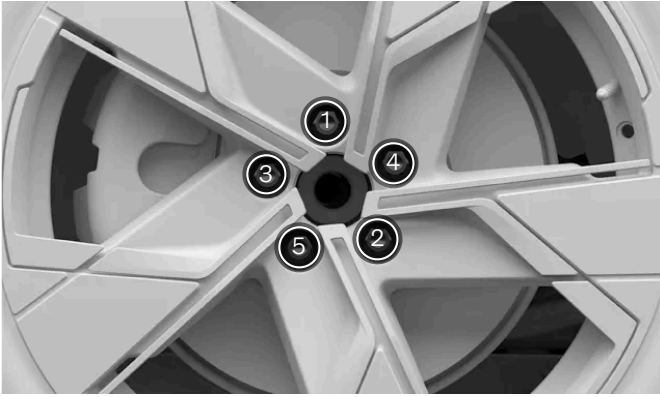

Tighten the wheel fasteners crosswise.

9. Place the wheel fastener cap back over the fasteners, using the guide markers to position it correctly then press it into place. Ensure that it's securely fastened.
10. Check the tyre pressure and store a new reference value in the tyre pressure monitoring system.

 **Warning**

Check the wheel fasteners

The wheel fasteners may need to be re-tightened a few days after the wheel has been changed. Temperature differences and vibrations may cause them to loosen.

Wheel properties after a wheel change

Be attentive to signs of incorrectly fitted wheels. This could affect the car's braking characteristics and the ability to deflect rain and slush.

When you have changed the type or size of the wheels, you should drive carefully at first. The dynamics and driving characteristics of the wheels may have changed.

^[1] Some spare wheels have different dimensions. If your car is approved for the spare wheel you intend to use, the difference in dimensions is okay.

^[2] Use tools that are designed for your car model.

13.4.3.1. Spare wheel

If you get a punctured tyre, a spare wheel^[1] can be temporarily used until the original wheel can be replaced or repaired.

The spare wheel is only designed for temporary use. You should replace the spare wheel with an ordinary wheel as soon as possible.

When not in use, you should store the spare wheel in a bag on the floor of the boot. It must be secured by two straps that are tensioned crosswise over the wheel and attached to the car's four load-retaining eyelets.

 **Warning**

Before driving with a spare wheel

- Only use a spare wheel that your car is approved for.
- Never drive your car with more than one spare wheel fitted.
- Snow chains cannot be used if the spare wheel is fitted on the front axle.
- The spare wheel should never be repaired.
- Make sure to follow the spare wheel manufacturer's recommendations regarding tyre pressure.

Driving with a spare wheel

- Never drive faster than 80 km/h (50 mph) when a spare wheel is fitted to your car.
- Your car's driving characteristics may be affected by using a spare wheel. It is important to replace the spare wheel with an original wheel as soon as possible.

 **Important**

The spare wheel is smaller than your car's original wheels. This will affect the car's ground clearance. Pay attention to high kerbs and do not wash your car in an automatic car wash.

 **Note**

While a spare wheel is used, the tyre pressure monitoring system might not work correctly.

^[1] The spare wheel must be of the type Temporary Spare.

13.4.3.2. Winter tyres

Winter tyres are designed for driving in road conditions with ice and snow. Your winter tyres' tread depth should be deeper than that of regular tyres.

Dimensions

When driving with winter tyres, it's important that all four tyres are of the correct type. Contact a Volvo dealer for advice.

Studded tyres

Studded winter tyres should be run-in gently for 500-1,000 km (300-600 miles) so that the studs settle properly into the tyres. This gives the tyre, and especially the studs, a longer service life.

 **Note**

Legal regulations for the use of studded tyres may vary. Make sure your fitted tyres are in full compliance with local regulations and laws.

Tread depth

Road conditions with ice, slush, snow and low temperatures put higher demands on your tyres than summer conditions. Volvo recommends that winter tyres have a tread depth of at least 4 millimetres (0.15 inch).

 **Note**

Speed rating

Winter tyres^[1] are allowed to have a lower speed rating than your car's top speed. However, if your winter tyres do have a lower speed rating than your car's top speed, you are not allowed to drive faster than the tyres' speed rating.

^[1] Both studded and stud-free tyres

13.4.3.3. Using snow chains

Using snow chains can help to improve traction in winter conditions. However, there are some restrictions you have to keep in mind.

 **Warning**

Snow chains can be used on your car with the following restrictions:

- Use genuine Volvo snow chains or equivalent chains designed for the car model, tyre and wheel rim dimensions.
- Only single-sided snow chains are permitted.
- The wrong snow chains may cause serious damage to the car and lead to an accident.

 **Note**

Using snow chains may result in malfunction of the tyre pressure monitoring system.

Fitting snow chains

- Make sure you are in a safe place when fitting or removing the snow chains.
- Always comply with local regulations and laws regarding the use of snow chains.
- Always carefully follow the mounting instructions from the manufacturer.
- Always use the same type of chains on left and right-hand side tyres.
- Volvo recommends that snow chains are not used on wheel dimensions greater than 20 inches.
- Make sure you use the correct size in relation to the wheels.
- Snow chains must only be used on the rear wheels.^[1]
- If wheels of a different size than the original wheels are fitted, certain snow chains must not be used.
- There needs to be sufficient distance between the chains and the car's brakes, suspension and body components. Chains that risk interfering with brake components must not be used.
- If you need to move your car while fitting or removing chains, do not let the wheels run over the chains' attachments.
- Fit the chains as tensioned as possible and tension them at regular intervals.



Tip

Practise fitting the snow chains before winter comes.

Driving with snow chains

- Once the snow chains are fitted, drive about 200 metres (650 feet). Then stop the car and check again that the chains are firmly attached.
- Never exceed the chain manufacturer's specified speed limit. You must never exceed 50 km/h (30 mph) under any circumstances.
- While improving grip in certain conditions, snow chains negatively affect other driving characteristics. If possible, avoid driving over uneven ground, such as bumps or holes. Also avoid fast or sharp turns as well as hard braking.
- Avoid driving on ground not covered in snow or ice as this wears out both the snow chains and wheels.
- Always have all-wheel drive^[2] enabled in the settings when driving with snow chains.

Contact a Volvo dealer for more information.

^[1] This also applies to all-wheel drive cars.

^[2] AWD

13.4.4. Checking the brake discs for wear

The brake discs on your car wear with use over time. Check them to ensure that the braking system is working properly.

Each brake disc has a minimum thickness value engraved or printed on the brake disc itself. Measuring the thickness of the brake discs with vernier callipers or an equivalent tool from time to time can help you determine whether they need to be replaced.

 **Warning**

Raising the car to remove a wheel

Removing a wheel requires that you raise the wheel off the ground. Carefully follow the separate instructions for raising the car safely.

- If you are removing a wheel in or close to traffic, make sure you and the car are clearly visible to others. Activate the hazard warning lights, put out a warning triangle in a visible but safe place and wear a reflective vest.
- Designate a safe space for passengers to wait, away from both the car and traffic.
- You are responsible for safety around the car while it is raised. Do not allow people inside or close to the car.
- Never get under the car, or let anyone reach under it with any part of their body, while it is raised with a jack.

 **Note**

You must activate jack mode before raising the car off the ground.

1. Remove the wheel.
2. Inspect the surface of the brake disc for wear and measure its thickness.

 **Warning**

If the thickness of brake disc is less than what is indicated by the minimum thickness value, the brake disc should be replaced immediately. Continuing to use worn components beyond this limit can reduce braking performance and compromise safety.

 **Important**

Brake wear indicators

Your car is equipped with electrical brake pad wear indicators that monitor the condition of the brake pads. When the brake pad thickness wears below the safe limit, the brake wear warning symbol appears in the driver display.

If the brake wear warning symbol appears, contact an authorised Volvo workshop to have the brake pads inspected and, if necessary, replaced. Driving with worn brake pads can compromise safety and damage the brake discs.

13.4.5. Punctures

If you suffer a punctured tyre, there are several actions to take to recover safely, especially if it happens while you are driving.

If the puncture occurs while you are driving, it's important to think about safety first. Activate the hazard warning lights and, if possible, move the car away from immediate danger. If necessary, call roadside assistance.

Warning

- Do not drive the car if it has a punctured tyre. It is not safe and will damage the car.
- If possible, exit your car from the side with the least traffic to avoid causing an accident.
- Place a warning triangle so that others are warned well in advance of passing your car. Remember to first put on a reflective vest if you have one.

Tip

If your car is equipped with a temporary puncture repair kit, be sure to read its instructions before you use it.

13.4.5.1. Temporary puncture repair

Your car is equipped with a temporary puncture repair kit ^[1] which can be used to repair a minor puncture in a tyre. The kit includes a bottle of sealant fluid and a compressor.

Warning

Read through all of the instructions before using the repair kit.

You should not drive faster than 80 km/h (50 mph) after the repair kit has been used on your tyres.



Compressor

The content of this manual represents the status of the user manual at the time of printing and may not be completely valid in future instances. For more information, refer to the first page for the complete disclaimer note.

The compressor is intended to be used for temporary tyre repair and is approved by Volvo. You can also use the compressor to check and adjust the tyre pressure on your original tyres when needed.

The compressor is an electrical device. When it's time to dispose of it, be sure to follow local regulations related to waste management.

Sealant fluid

The sealant fluid works as a temporary repair. It is effective at sealing a tread puncture but should not be used to seal a puncture in the sidewall of the tyre. If the tyre has larger slits, cracks or similar damage, you should not use the sealant to repair it.

The bottle of sealant fluid needs to be replaced if the expiration date has passed^[2]. The old bottle is considered hazardous waste.

^[1] Also called temporary mobility kit or TMK

^[2] See expiration date on bottle.

13.4.5.1.1. Using the temporary puncture repair kit

When using the temporary puncture repair kit, there are a number of important steps you need to follow. Make sure you read and understand each step before proceeding.

i Note

These instructions apply to the temporary puncture repair kit supplied by Volvo.



Overview of the temporary puncture repair kit's compressor

- ① Pressure gauge
- ② Pressure-reducing valve
- ③ Label, maximum permitted speed
- ④ Air hose

5 Electrical cable



Sealing fluid bottle

Warning

Sealing fluid can be harmful

The sealing fluid contains substances that are harmful if swallowed. The contents can also cause allergic reactions or be otherwise harmful to the respiratory tract, the skin, the central nervous system and the eyes.

Precautions

- Store the kit out of reach of children.
- Avoid prolonged or repeated contact with the skin. If you get sealing fluid on your clothes, remove them.
- Wash hands thoroughly after handling.

First aid

- Ingestion: Do not induce vomiting unless directed to do so by medical personnel. Get medical attention.
- Skin: Wash affected areas of skin with soap and water. Get medical attention if symptoms occur.
- Eyes: Flush with plenty of water for least 15 minutes, occasionally lifting the upper and lower eyelids. Get medical attention if symptoms occur.
- Inhalation: Move the exposed person to fresh air. If irritation persists, get medical attention.

- Make sure the compressor's power button is in the off position before starting.
- Don't remove the air hose during repair.
- If the puncture was caused by a nail or similar and it's still in the tyre, leave it in. This helps to seal the puncture.
- If the repair is carried out in an area where there might be other vehicles, activate the hazard warning lights and use a warning triangle, if you have one.

Preparations

1. Place the label showing maximum speed so that it is clearly visible as a reminder for the driver, for example in the windscreen. You find it on the compressor.

2. Remove the TMK label from the sealing fluid bottle and place it on the rim of the tyre. This helps you remember which one to replace.
3. Screw the bottle to the bottom of the bottle holder, which is located on the compressor where you originally found the label showing maximum speed. There is a reverse catch to prevent leakage. When the bottle is attached it cannot be removed again. Removal must only be carried out by a workshop^[1].
4. Attach one end of the air hose to the top of the sealing fluid bottle where you found the TMK label.
5. Unscrew the tyre valve's dust cap and attach the other end of the air hose to the tyre. Screw the air hose connector as far down the thread as possible.

Begin puncture repairs

6. Connect the compressor to the car's 12 V socket and ensure that the socket works and is supplying current.^[2]
7. Start the compressor by pressing the power button.
- > The compressor pressure increases. The pressure may temporarily reach as high as 6 bar (87 psi) before settling after about 30 seconds.

 **Warning**

Never stand next to the tyre while the compressor is on. If cracks or bumps appear, the compressor must be turned off immediately. Stop and contact Volvo Assistance for safe recovery.

8. Inflate the tyre for 7 minutes or until the pressure reaches 3.5 bar (51 psi).

 **Important**

To avoid overheating, do not run the compressor for more than 10 minutes.

9. Shut the compressor off to check the pressure on the pressure gauge. Minimum pressure is 1.8 bar (26 psi) and maximum is 3.5 bar (51 psi). Use the pressure-reducing valve if the pressure is too high.

 **Warning**

If the pressure is below 1.8 bar (26 psi), the hole in the tyre is too big. Do not continue and contact Volvo Assistance for safe recovery.

10. Unplug the compressor from the 12 V socket.
11. Unscrew the air hose from the tyre and use the protective cap to avoid leakage of the remaining sealing fluid.
12. Refit the tyre valve's dust cap.
13. As soon as possible, drive for 10 minutes^[3] and let the fluid seal the tyre. After that, perform a follow-up check.

Follow-up check

14. With the compressor shut off, connect the air hose to the tyre's air valve.
15. Check the tyre pressure on the pressure gauge.

- > • If it is below 1.3 bar (19 psi) then the tyre is insufficiently sealed. Stop and contact Volvo Assistance for safe recovery.
- If the tyre pressure is higher than 1.3 bar (19 psi), the tyre must be inflated to the pressure specified on the tyre pressure label on the driver's side door pillar. The pressure must be at least 2.0 bar (29 psi) to continue driving. If the pressure is below 2.0 bar (29 psi), call Volvo Assistance. If the pressure is too high, release air using the pressure-reducing valve.

16. Refit the tyre valve's dust cap.

- Replace the sealing fluid bottle and hose after use. Contact a Volvo dealer to do so.
- Volvo recommends replacing or repairing the damaged tyre as soon as possible. Inform the workshop that the tyre contains sealing fluid.

Warning

Maximum mileage with tyres containing sealing fluid is 200 km (120 miles).

[1] An authorised Volvo workshop is recommended.

[2] The socket no longer supplies power 10 minutes after the driver has got out of the car. To resume power, just re-enter the car.

[3] Or 3 kilometres (2 miles)

13.4.5.1.2. Inflating tyre with the puncture repair compressor

Your car's tyres can be inflated with the compressor that is included in the temporary puncture repair kit.

Make sure the compressor's power button is in the off position before starting.

1. Attach one end of the air hose to the compressor where the speed limit label is located. Unscrew the tyre valve's dust cap and attach the other end of the air hose to the tyre. Screw the air hose connector as far down the thread as possible.
2. Connect the compressor to the car's 12 V socket and ensure that the socket works and is supplying current. [1]
3. Start the compressor by pressing the power button.

Important

To avoid overheating, do not run the compressor for any longer than 10 minutes at a time.

4. Check the tyre pressure on the compressor's pressure gauge [2]. Use the pressure-reducing valve if the pressure is too high.
5. Turn off the compressor and unplug it from the 12 V socket.

6. Unscrew the air hose from the tyre.

7. Refit the tyre valve's dust cap.

Return the kit to its storage location.

[1] The socket no longer supplies power 10 minutes after the driver has got out of the car. To resume power, just re-enter the car.

[2] The recommended tyre pressure for the car's original tyres can be found on a label on the driver's side door pillar.

13.4.6. Tyre pressure

A correct tyre pressure helps to improve driving stability, lower energy consumption and extend the lifespan of the tyre.

With time, the tyre pressure decreases. The pressure also varies depending on environmental conditions. All of this is normal. However, if you drive with an incorrect tyre pressure, the tyres may overheat and become damaged. The tyre pressure affects ride comfort, noise levels and handling characteristics.

Make it a habit to check the tyre pressure monthly and before longer trips. Always make sure you use a reliable pressure gauge. To keep the tyres in good shape, use the recommended tyre pressure for cold tyres.

Warning

If the tyre pressure is too high or too low, the tyres can sustain severe damage. The tyres can explode while you are driving and cause you to lose control of the car.

Tip

A correct tyre pressure will help you take advantage of your car's full loading capacity.

13.4.6.1. Tyre pressure monitoring

Your car can detect and indicate if the tyre pressure is low. Tyre pressure monitoring cannot be disabled. If the system is unable to detect low tyre pressure, it will indicate that there's a malfunction.

For the tyre pressure monitoring system to provide updated information, you need to drive the car above 30 km/h (20 mph) for

several minutes.



An indicator symbol lights up if a low tyre pressure is detected in any of the tyres. It will stay illuminated until the problem is resolved.

In addition to messages in the driver display, you can also find information about the tyre pressure monitoring in the centre display's car status view.

 **Warning**

No advance warning possible

The system cannot give you any advance warning of potential tyre damage.

Ensure correct tyre pressure immediately

When the low tyre pressure symbol is lit, stop and check the tyre pressures as soon as possible. Driving with underinflated tyres can cause tyre failure.

If the tyre pressure monitoring system is not working correctly, the driver display's indicator symbol will first flash for approximately one minute and then remain lit. A message also appears on the driver display. If the fault is permanent, a service is required.^[1]

Remember:

- The system does not replace the need for regular tyre inspection and maintenance.
- The indication symbol for low tyre pressure won't disappear until the low tyre pressure has been corrected.
- If the recommended tyre pressure has changed, such as when changing tyres or loads, you need to save a new tyre pressure reference value.

 **Note**

Tyre pressure monitoring sensors need to be mounted on all wheels, including winter tyres. If you use a spare wheel or other wheel without the sensor, a fault message will appear in the driver display after a few minutes of driving.

Remember to make sure that new wheels have the sensor to avoid a system malfunction warning.

Status

You will find information about any issues detected by the tyre pressure monitoring in the centre display's car status view.

Red indicator symbol The tyre pressure is very low. Stop immediately and check the tyres.

Yellow indicator symbol The tyre pressure is low. Stop and check the tyres as soon as possible.

Warning triangle Tyre pressure monitoring system status needs to be checked.

System description

The content of this manual represents the status of the user manual at the time of printing and may not be completely valid in future instances. For more information, refer to the first page for the complete disclaimer note.

The following information is phrased according to external legal requirements.

Each tyre, including the spare (if provided), should be checked monthly when cold and inflated to the inflation pressure recommended by the vehicle manufacturer on the vehicle placard or tyre inflation pressure label. (If your vehicle has tyres of a different size than the size indicated on the vehicle placard or tyre inflation pressure label, you should determine the proper tyre inflation pressure for those tyres.)

As an added safety feature, your vehicle has been equipped with a tyre pressure monitoring system (TPMS) that illuminates a low tyre pressure telltale when one or more of your tyres is significantly under-inflated. Accordingly, when the low tyre pressure telltale illuminates, you should stop and check your tyres as soon as possible, and inflate them to the proper pressure. Driving on a significantly under-inflated tyre causes the tyre to overheat and can lead to tyre failure. Under-inflation also reduces fuel efficiency and tyre tread life, and may affect the vehicle's handling and stopping ability.

Please note that the TPMS is not a substitute for proper tyre maintenance, and it is the driver's responsibility to maintain correct tyre pressure, even if under-inflation has not reached the level to trigger illumination of the TPMS low tyre pressure telltale.

Your vehicle has also been equipped with a TPMS malfunction indicator to indicate when the system is not operating properly. The TPMS malfunction indicator is combined with the low tyre pressure telltale. When the system detects a malfunction, the telltale will flash for approximately one minute and then remain continuously illuminated. This sequence will continue upon subsequent vehicle start-ups as long as the malfunction exists. When the malfunction indicator is illuminated, the system may not be able to detect or signal low tyre pressure as intended. TPMS malfunctions may occur for a variety of reasons, including the installation of replacement or alternate tyres or wheels on the vehicle that prevent the TPMS from functioning properly. Always check the TPMS malfunction telltale after replacing one or more tyres or wheels on your vehicle to ensure that the replacement or alternate tyres and wheels allow the TPMS to continue to function properly.

^[1] Volvo recommends an authorised Volvo workshop for any repair or service needs.



13.4.6.1.1. Saving a new reference value for tyre pressure monitoring

The tyre pressure monitoring system needs a reference value to work from. This means that the value needs to be updated in certain circumstances for the system to work properly.

Whenever the tyre pressure is adjusted, a new reference value needs to be saved. This could be when certain changes are made, such as every time you change to wheels that require a different recommended tyre pressure. The reference value may also need to be updated when there is a significant change in the car's weight due to loading or unloading.

Even when you are handling a low tyre pressure warning and inflating to the previous reference value, you need to save the tyre pressure value again to account for any temperature related changes.

To save a new reference value, the car needs to be turned on and stationary.

1. Inflate the tyres to the correct tyre pressure.^[1]
2. Press the car symbol  in the bottom bar and go to **Status** → **Tyre pressure**.
3. Press  to get to settings.

The content of this manual represents the status of the user manual at the time of printing and may not be completely valid in future instances. For more information, refer to the first page for the complete disclaimer note.

4. Select your reference tyre pressure and press **Save**.

 **Note**

Save button unavailable

For safety reasons, the **Save** button is only available when the car is turned on and stationary.

The button is also unavailable if there is a warning about very low tyre pressure in the driver display. This is to avoid accidentally saving a low value as reference. In this case, you need to inflate the tyres to correct reference tyre pressure and then start driving the car. Once the warning in the driver display disappears you can stop the car and continue with saving a new reference value.

5. Confirm that you want to save a new value. The confirmation step is needed to avoid saving a new reference value by mistake.
 - > This overwrites the previous tyre pressure and temperature and enters a new reference value.
6. Start driving the car at a speed above 30 km/h (20 mph).

^[1] See the tyre pressure label on the driver's side door pillar for information on recommended tyre pressure for your car.

13.4.6.2. Adjusting tyre pressure

The tyre pressure may need to be adjusted if you're changing wheels or planning to drive with an unusually heavy load. It's normal for tyre pressure to decrease over time. Adjusting it so that you have the correct pressure for the current situation helps ensure an even tyre wear and high performance.

The tyres need to be at ambient temperature when the pressure is checked and adjusted. This is referred to as having cold tyres. Never release air from a warm tyre. When it cools down, the internal air pressure drops, which can lead to underinflated or even entirely deflated tyres.

The tyres can warm up very quickly and should be considered warm if driven for longer than approximately 1.5 km (1 mile). They often need about 3 hours of cooling down before reaching ambient temperature again.

The recommended pressure for factory-fitted tyres is shown on the door pillar on the driver's side.

1. Remove the tyre valve's dust cap and then press the tyre pressure gauge firmly onto the valve.
2. Check the gauge to see what the current tyre pressure is.
3. Inflate the tyre to the correct tyre pressure.

i Note

Low pressure warning

If you received a low pressure warning, inflate the tyre to the last saved pressure value.

Changed conditions

If you need to adjust the tyre pressure for changed conditions, such as when changing a tyre, inflate to the recommended tyre pressure.

4. Refit the dust cap^[1] to avoid damage to the valve.
5. Inspect the tyre for stuck debris, such as nails or other objects, that could puncture the tyre.
6. Check the sidewalls for any cavities, cuts, bumps or other irregularities.
7. Save the tyre pressure reference value in the centre display once you've adjusted the pressure.

If you accidentally over-inflate the tyre, press the metal pin in the middle of the valve to let out the excess air. Then check the pressure again.

i Note

Spare wheels may have recommended pressures that are different from those of the original tyres. Always use the pressure recommended by the spare wheel manufacturer.

i Tip

You can use the compressor from the temporary puncture repair kit to check and adjust the tyre pressure on your original tyres when needed.

^[1] Only use original Volvo dust caps or plastic ones as metal dust caps may corrode and stick to the valve.

13.5. Car electrics and batteries

Your car has a specialised electrical system that delivers electricity to and from the batteries. There are both high-voltage and low-voltage circuits for different electrical functions.

There is information about several of your car's electrical components in this section of the manual. This includes:

- Traction battery
- 12 V battery
- Emergency 12 V supply terminal

- Fuses

 **Important**

12 V terminal

In the event of a total loss of power, the car can't be unlocked as the locks are electrically operated. To access the car and charge it, the car can be powered for a short time using the externally accessible 12 V terminal. It is accessed by removing a small panel by the front-left wheel housing.

Before any use of the 12 V terminal, consider the following:

- Volvo recommends that the 12 V terminal is only used by service technicians for the purpose of accessing the car as part of immobilisation recovery.
- The external 12 V terminal on your car should only be used to make your car accessible. Do not attempt to charge another car or similar external source from this point.
- Only use a 12 V charger with a maximum charging current below 30 A.
- Do not connect another 12 V battery to the terminal.
- Connecting any power source that delivers currents higher than 30 A blows the terminal's fuse, thereby disabling it.
- Only use the 12 V terminal for short amounts of time. This is not meant as a way of powering the car continuously.
- Make sure to follow the positive and negative markings on the terminals as reversing the polarity of the low voltage system can lead to damaging the low voltage system components or blowing the 30 A fuse.

 **Tip**

Car charging

Features and equipment related to charging, such as the charging port and cables, have their own section.

Convenience features

Power-related features, such as USB ports and wireless charging of devices, are covered in other sections.

 **Warning**

- Do not handle or modify the car's electrical components. Only perform actions that are clearly described in the user manual.
- High-voltage components can produce or conduct lethal currents and must only be handled by authorised technicians.
- Do not perform repairs on the car's electrical system or components. Contact an authorised Volvo workshop for any required repairs or servicing.

13.5.1. Traction battery

Your car's traction battery is the central energy and power source for your car. It powers all electric propulsion and indirectly powers the rest of the car by keeping the smaller 12 V battery charged.

The traction battery sits low in the underbody of the car.

Battery care and health

How you use your car affects the traction battery's condition. Over time its capacity decreases. There are recommended user practices that can help extend the battery's service life. These user practices cover events and conditions that can cause battery damage.

Important

Leaving the car with a low battery level can lead to battery damage. Make sure to charge the car as soon as possible if the battery level is near empty.

Tip

There are separate sections in this manual about battery health and what you can do to recover from a low-power scenario.

Battery service and maintenance

The traction battery is a high-voltage component that only authorised technicians are equipped to service safely.

Warning

- Do not handle or modify the car's electrical components. Only perform actions that are clearly described in the user manual.
- High-voltage components can produce or conduct lethal currents and must only be handled by authorised technicians.
- Do not perform repairs on the car's electrical system or components. Contact an authorised Volvo workshop for any required repairs or servicing.

Battery passport

You can find out more about your car's traction battery by scanning the battery passport QR code. It is located on the inside of the door pillar on the driver's side and is visible when the door is opened.

13.5.1.1. Managing battery health and performance

There are user practices that can help maintain the traction battery's condition and performance over time. Some scenarios can lead to battery damage and should always be avoided.

Low battery level and flat battery

Important

The traction battery can sustain severe damage if it is not charged after the battery level reaches 0%. The car draws a small amount of power when parked. Therefore, leaving the car with a low battery level without charging can lead to a flat battery and battery damage. If the battery level is below 20% when parked, it is recommended that the car is connected for charging as soon as possible.

If the battery level reaches 0%, the battery is considered flat or empty. The car then needs to be charged as soon as possible to reduce the risk of battery damage.

The smaller 12 V battery is also at risk of going flat if the traction battery can't supply it with power. If both batteries have gone flat, the car will have no power at all and no ability to initiate charging.

High state of charge

Important

The traction battery can sustain damage if the car's battery level is kept very high for a long period of time.

For regular charging, battery wear can be reduced by selecting a target battery level lower than 100%. Only charge to 100% if the full range is needed for your next trip.

If you are leaving the car plugged in for charging without any immediate plans to drive it, select the target battery level recommended in the car's charging view.

Charging habits

AC charging is the recommended charging mode for everyday charging. This helps maintain the condition of the battery over time. DC charging causes more wear.

Long-term parking

When leaving your car parked for longer than one month, the recommended battery level is 40-60%. Use or charge the car to reach the recommended level.

If you are leaving the car parked for longer than three months, it's recommended to keep it plugged in but set a battery charging limit of 50%. This is for better battery health.

Regularly check the battery level and that charging is working.

Tip

There is a separate section in this manual with more recommendations for long-term parking.

Parking in hot weather

 **Important**

Avoid exposing the car to extreme temperatures. Avoid leaving the car parked for longer than 24 hours if the temperature is at risk of reaching 55 °C (131 °F).

During warmer periods of time, you're recommended to plug in the car during parking. High temperatures cause battery damage, especially when the car is exposed to hot weather for prolonged periods. The car can actively cool the battery while it's parked, but that uses energy. When you're returning to your parked car, the battery level could be noticeably lower than before. If the car is plugged in for charging, it can cool the battery without lowering the battery level and risking a flat battery.

In hot temperatures, it is recommended that you park in a shaded spot. Strong sunlight combined with high temperatures can lead to very high battery temperatures and excessive cooling needs.

Parking in cold weather

When the battery is cold, the car temporarily reduces battery performance until it's warmed up. Driving the car in a state of reduced performance doesn't harm the battery.

To avoid temporarily reduced performance from a cold battery, connect the car for charging and activate the car's preconditioning ahead of your trip. The car can then heat the battery without affecting performance and available range.

In temperatures below -30 °C (-22 °F), avoid leaving the car parked without charging for longer than 24 hours.

13.5.1.2. Powertrain cooling system

Your car has an advanced temperature regulation system.

The system actively regulates the temperature of the traction battery while you're parked, charging or driving your car. This happens if your car experiences high or low temperatures and during preconditioning.

 **Important**

Never attempt to add coolant yourself

The cooling system is a closed system. A trained technician must perform any required maintenance of the cooling system.^[1]

^[1] Volvo recommends an authorised Volvo workshop.

13.5.2. 12 V battery

The 12 V battery powers everything in your car except the electric propulsion.

Servicing and replacement

The 12 V battery is maintenance-free.

Contact an authorised Volvo workshop if the 12 V battery needs to be replaced.

Important

12 V terminal

In the event of a total loss of power, the car can't be unlocked as the locks are electrically operated. To access the car and charge it, the car can be powered for a short time using the externally accessible 12 V terminal. It is accessed by removing a small panel by the front-left wheel housing.

Before any use of the 12 V terminal, consider the following:

- Volvo recommends that the 12 V terminal is only used by service technicians for the purpose of accessing the car as part of immobilisation recovery.
- The external 12 V terminal on your car should only be used to make your car accessible. Do not attempt to charge another car or similar external source from this point.
- Only use a 12 V charger with a maximum charging current below 30 A.
- Do not connect another 12 V battery to the terminal.
- Connecting any power source that delivers currents higher than 30 A blows the terminal's fuse, thereby disabling it.
- Only use the 12 V terminal for short amounts of time. This is not meant as a way of powering the car continuously.
- Make sure to follow the positive and negative markings on the terminals as reversing the polarity of the low voltage system can lead to damaging the low voltage system components or blowing the 30 A fuse.

12 V battery specifications

Battery type	H5 AGM
Voltage	12 V
Dimensions (length × width × height)	242 × 175 × 190 mm (9.5 × 6.9 × 7.5 in)
Capacity	60 Ah
Cold start capacity ^[1]	680 A

^[1] CCA

13.5.2.1. Battery labels

Low-voltage car batteries have labels containing information for safe handling.

Symbols



Avoid sparks and naked flames.

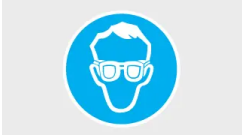

Use protective goggles.



Store the battery out of reach of children.



The battery contains corrosive acid.



More information in the car's user manual.



Risk of explosion.



The battery must be disposed of properly to be recycled.



Recycle properly.

 **Note**

Depicted labels

Labels depicted in this manual are generic representations of those found around your car. The manual only contains their location and what kind of information they hold. Find the actual label for specific information about your car.

13.5.3. Battery recycling

Used batteries must be recycled in an environmentally sound manner.

Consult Volvo support if you're unsure of how to dispose of batteries. The traction battery must only be handled by authorised technicians.

13.5.4. Fuses

Electrical fuses protect different parts of the car's electrical system by cutting the power if the current exceeds the fuse's threshold. A blown fuse must be replaced to restore functionality.

A blown fuse may be an indicator of an underlying electrical fault. Contact Volvo support if your car indicates that a fuse has blown.

 **Important**

- If a fuse is incorrectly replaced it can cause severe damage to the electrical system.
- A replacement fuse must have the correct specifications, such as type and ampere value.
- Volvo recommends an authorised Volvo workshop for fuse replacements.

13.6. Tools and equipment

Your car is equipped with some tools that may be useful in certain situations. For example, if you need to change a wheel.

The tools and equipment in your car are stored in different places, such as under the bonnet, in the glove box and in the boot. Be sure to familiarise yourself with where everything is stored so you don't have to search for something when you need it.

 **Warning**

Store tools appropriately

Always store loose tools and equipment in designated storage areas when not in use. Otherwise, they can cause damage or injury in the event of a collision.

Read all instructions before using tools

Before use, make sure you read and understand all the relevant instructions for tools and equipment, where available.

Contact Volvo support for recommendations concerning tools and equipment for your car.

Warning triangle



If your car should be immobilised in an area where there might be other vehicles, you can place the warning triangle on the ground to alert others before they reach your car.

First aid kit



Your car is equipped with a first aid kit. Some regions require that it's always available in your car.

Towing eye



The towing eye can be attached to the car's bumper to enable towing. It can also be used to secure roof-loaded objects that are longer than the roof.

Lockable wheel bolt tool



This tool is for unlocking the wheel bolt and makes it possible to change the wheel.

Temporary puncture repair kit



Your car is equipped with a temporary puncture repair kit which can be used to repair a minor puncture in a tyre.

13.6.1. Using a warning triangle

Assemble and set out a warning triangle if your car is immobilised in an area where there might be other vehicles. The warning triangle's purpose is to give other drivers advance notice of your car or other stationary hazards.



The folded warning triangle in its case.

i Note

Local rules and regulations

Rules and regulations about how and when to put out a warning triangle vary between regions. You are responsible for knowing and following what applies in your location.

i Tip

- If it's dark when you set out the warning triangle, wear a reflective vest if you have one in the car. If you don't have one, you can hold the warning triangle so that its reflective parts are visible as you carry it.
- You can use the case as a reminder to retrieve the warning triangle when you leave by placing it on the driver's seat.

1. Activate the hazard warning lights.
2. Take out the warning triangle from its case, unfold it and connect its ends.
3. Fold out the triangle's support legs.
4. Position the warning triangle in a suitable place in regard to traffic and at a distance which ensures that other drivers are alerted in good time before they reach your car.

Remember to retrieve the warning triangle before you drive off again.

13.6.2. Attaching the towing eye

Use the towing eye to attach a winch wire when towing.

On the right-hand side of the car, the towing eye is screwed into a threaded socket behind a cover located on the front bumper. As your car is equipped with a towbar, it only has a towing eye mount at the front of the car. The towbar replaces the need for a rear towing eye.

Important

Be sure to read about towing and its limitations before you start.

Fetch the towing eye so you have it at hand.

1.

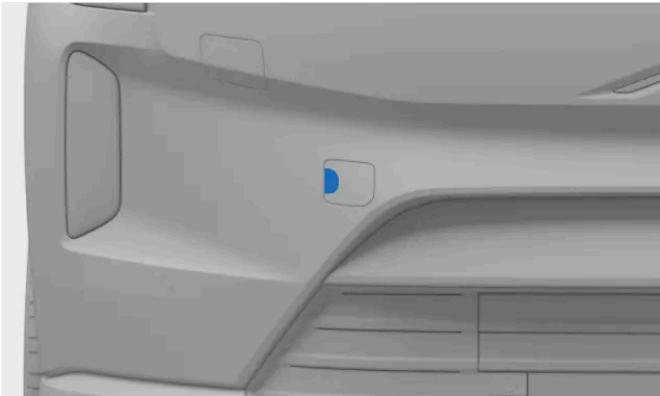

Front towing eye fastening cover

To attach in the front: Remove the cover by pushing in the centre of its left side. The cover pivots and can then be removed.

2. Screw the towing eye all the way into the socket.

Important

It is important that the towing eye is firmly screwed into place. Putting something through the towing eye, such as a wheel wrench, can give extra leverage.

After you're done, remember to remove the towing eye again and return it to its storage location.

13.7. Raising the car

You can raise one wheel off the ground at a time using a jack. Be sure to read all instructions before raising the car.

 **Important**

It is very important to place the jack on the jacking points or the battery may get damaged.

Recommended or supplied equipment

- The instructions for raising the car presume use of a jack recommended or supplied^[1] by Volvo.
- Only use tools and equipment designed for your car model. Contact a Volvo dealer for tool recommendations.
- Volvo recommends an authorised Volvo workshop for tasks not described in this manual.
- A portable jack designed for occasional and limited use is only suitable for short and urgent tasks, such as handling a puncture. A workshop jack is recommended for frequent or extended use.
- Only raise the car using its jacking points.

Other lifting equipment

- If using lifting equipment not supplied by Volvo^[2], carefully read their instructions before raising the car. Ensure that the equipment is compatible with the car.
- Use additional safety equipment such as axle stands and wheel blocks when applicable.
- When using workshop jacks or other lifting equipment designed for frequent and extended use, you should use separate lifting areas instead of the ones described in this instruction.

 **Warning**

Safety around the car

- If you are changing a wheel in or close to traffic, make sure you and the car are clearly visible to others. Activate the hazard warning lights, put out a warning triangle in a visible but safe place and wear a reflective vest.
- Designate a safe area for passengers to wait, away from both the car and traffic.
- You are responsible for safety around the car while it is raised. Do not allow people to stay inside of or close to the car.

Raising the car

- Never get under the car, or let anyone reach under it with any part of their body, while it is raised.
- Do not place any object between the ground and the jack, nor between the jack and the car's jacking point.
- Do not use lifting equipment that shows any sign of damage.

Before raising the car:

- Gather the tools and parts needed for your planned work.
- Make sure that the jack is in good condition, and that its threads are properly lubricated and free from dirt.
- To avoid accidentally triggering the alarm, reduce your car's alarm sensitivity.

1. Activate the parking brake.

2. Activate jack mode in settings.
3. Place wheel blocks to reduce the risk of car movement while raised. Large stones or wooden blocks work well. Place them both in front of and behind each wheel that will remain on the ground.
4. Locate the intended jacking point on the car's underbody.

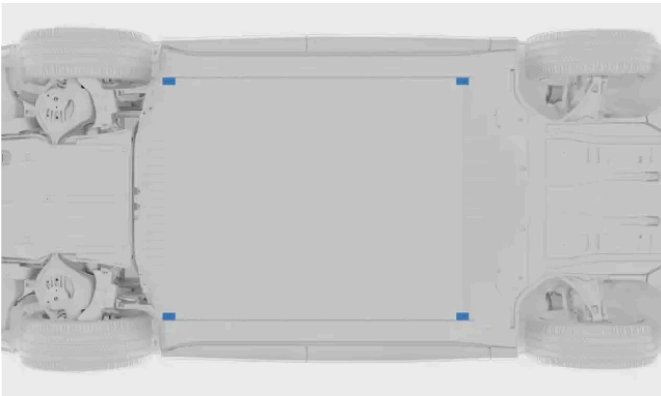

There are two jacking points on each side of the car.

5. Place the jack under the car's jacking point. The surface it stands on must be firm, non-slippery and level. Position the jack with the crank handle pointing away from the car.
6. Crank the jack up until its head slots into the car's jacking point. Ensure that the jack head's protruding piece fits into the jacking point slot.

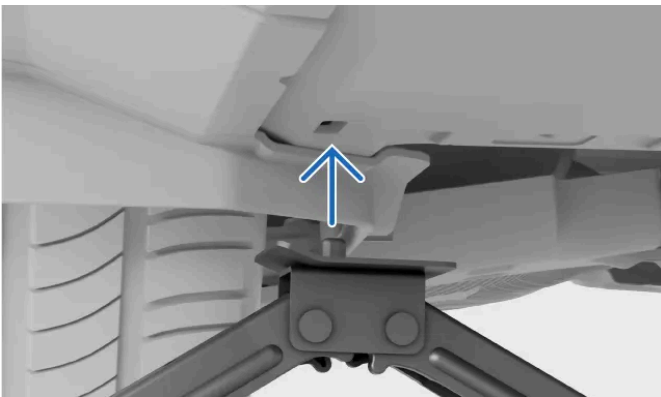

7. Make a final alignment. Make sure that:
 - the jack is not leaning in any direction
 - the base of the jack is centred under the jacking point
 - the jack head meets the jacking point correctly.



8. Raise the car to an appropriate height. Do not raise it higher than what's necessary for the work you're doing.

The content of this manual represents the status of the user manual at the time of printing and may not be completely valid in future instances. For more information, refer to the first page for the complete disclaimer note.

 **Warning**

Do not leave the car unsupervised when raised.

Carefully lower the car when you have finished your work. Remember to test important car functions that may have been affected by the work you performed.

Put the jack back in its storage place.

Jack mode will deactivate as soon as you start to drive.

^[1] Depending on market, a jack for occasional and limited use may be included with the car.

^[2] Such as workshop jacks or other lifting equipment designed for frequent and extended use

13.7.1. Workshop lifting areas

You can use a workshop jack or lifting equipment designed for frequent and extended use when you raise the car off the ground. However, when you do, you need to ensure that it's placed on the car's lifting areas.

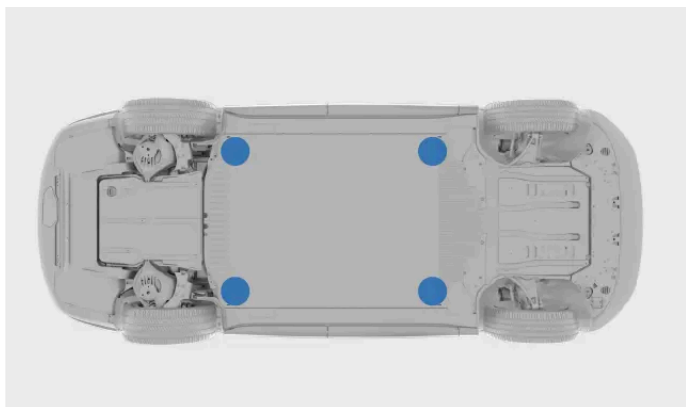

Lifting areas used for workshop equipment.

The lifting areas to use along with workshop equipment are placed by the outer corners of the battery tray. They are just behind the regular jacking points, close to the ribbed area.

 **Important**

It is very important to place the workshop jack on the car's lifting areas or the battery may get damaged.

If you're using a workshop jack, make sure that the jack plate is fitted with a rubber guard to protect the car as well as ensure that the car remains stable.

To avoid accidentally triggering the alarm, reduce your car's alarm sensitivity before lifting it.

 **Note**

You must activate jack mode before raising the car off the ground.

13.7.2. Activating jack mode

If you need to raise a wheel off the ground, for example when changing a wheel, you first need to activate jack mode.

Your car is equipped with air suspension which will automatically level the car if the ground is uneven. The air suspension has to be turned off when you use a jack to raise a wheel off the ground. If you don't, the car will try to maintain a level position.

1. Press the car symbol  in the bottom bar and go to **Settings**.
2. Go to **Controls** → **Car modes** → **Jack mode**.
3. Activate jack mode.

Jack mode will automatically deactivate when you start driving again.

13.8. Maintenance and repairs

Properly performed maintenance and repairs are essential for keeping your car in good working condition.

Your car keeps track of when you last had a maintenance appointment and it tells you when it's time to make a new one. It can self-diagnose many types of faults and notify you if you need to take action.

If you notice any maintenance or repair needs that have not been detected by the car, contact Volvo support.

Volvo recommends an authorised Volvo workshop for all maintenance and repair needs.

 **Important**

Faults and notifications

If a notification in the car calls for a maintenance, make an appointment as soon as you can. The car status view in the centre display also contains information about detected issues.

 **Warning**

- Do not handle or modify the car's electrical components. Only perform actions that are clearly described in the user manual.
- High-voltage components can produce or conduct lethal currents and must only be handled by authorised technicians.
- Do not perform repairs on the car's electrical system or components. Contact an authorised Volvo workshop for any required repairs or servicing.

Volvo's recommended maintenance programme

Volvo recommends engaging an authorised Volvo workshop to perform any repair and maintenance work. Volvo workshops have the personnel, special tools and service literature required to provide high-quality servicing. Volvo's recommended maintenance programme has been developed to give your car a long service life. Maintaining your car according to its customised maintenance programme may be a prerequisite for coverage under Volvo's warranties. Your car's service and warranty information ^[1] contains more details about service and warranty terms and conditions.

^[1] This is a separate publication included with your car.

13.8.1. Booking maintenance or repairs

Volvo support handles bookings when you need a maintenance or repair appointment. Authorised Volvo workshops have specialised training and equipment to take care of your car.

Your car notifies you when it's time for maintenance.

1. Contact Volvo support to book an appointment. They can locate your closest service point.

If you're unable to reach Volvo support and urgently need maintenance or repairs, contact a roadside assistance service available in your location.

13.8.2. On-board diagnostic port

Your car has a diagnostic port that allows a workshop to connect to the car and communicate with its systems. Do not connect equipment that has not been authorised by Volvo.

The diagnostic port is of the type OBDII.

The diagnostic port is located on the underside of the dashboard, close to the bonnet release lever.

Improper use of the diagnostic port can negatively affect the car's systems and software. This includes connecting unauthorised equipment^[1] and installation of software or diagnostic tools.

 **Warning**

Volvo accepts no liability if unauthorised equipment is connected to the on-board diagnostic port. Contact an authorised Volvo workshop for more information.

^[1] Equipment not approved by Volvo.

14. Immobilised car and recovery

If you can't drive your car, it's considered to be immobilised. You can always contact an authorised Volvo workshop if you're unable to find a solution in the manual or if you are uncertain about how to proceed.

Depending on the nature of the problem, you may be able to solve it on your own or with assistance from an authorised Volvo workshop or other services. In this part of the manual, you will find a number of scenarios and how to handle them safely.

In a situation where there are injuries or risk of injury, prioritise safety and medical needs over car recovery. Don't hesitate to contact emergency services if necessary.

The following scenarios have their own manual sections that can help you identify the underlying issue and what the necessary steps for recovery are.

- The car malfunctions and the car can't be used as intended.
- The battery is flat and the car is unresponsive.
- There is physical damage to the car. The damage can make the car unsuitable to drive or cause immobilisation. Even superficial damage needs to be evaluated to ensure that you can safely use the car.

14.1. Damaged car

If your car is damaged, it is important to identify the extent and severity of the damage to determine how to handle the car safely.

Damage can immobilise your car or make it unsafe to drive.

Contact an authorised Volvo workshop if your car has been damaged or if it shows signs of damage sustained while parked. If the damage immobilises or severely impairs the car's performance, recovery through a roadside assistance and recovery service is necessary.

Important

Minor damage

Your car can self-diagnose many defects, but it can't detect all types of damage or predict their consequences. A small impact resulting in superficial damage can disturb components behind the affected area, such as misaligning a parking sensor behind a bumper. It is therefore important to have seemingly minor or superficial damage examined by a trained technician to determine the full extent of the damage.

Immobilising damage

There are several types of damage that can immobilise the car. They include, but are not limited to:

- Collision damage
- Puncture
- Windscreen damage

The content of this manual represents the status of the user manual at the time of printing and may not be completely valid in future instances. For more information, refer to the first page for the complete disclaimer note.

- Water damage
- Mechanical failure

Collision damage

After a severe enough collision, your car enters safety mode and needs to be recovered.

Important

If possible, do not try to drive or move the car after a severe collision. If the car poses an acute traffic hazard, an exception can be made to move it a short distance out of immediate danger if the state of the car allows it.

Water damage

Water damage can cause permanent damage to your car and severely affect how well it works.

Important

Simply drying the car out or allowing it to dry will often be insufficient to resolve significant water damage. A trained technician should examine any water damage to determine its full extent and severity.

Mechanical damage

The best way to avoid mechanical failures is to follow the intended use and to regularly maintain your car. It is important to continuously perform check-ups of your car.

14.2. Malfunction

When part of your car or one of its features is not working as designed, that counts as a malfunction.^[1] It may not be safe to use your car at all, depending on what type of malfunction the car is experiencing.

Note

Immobilised car

You should consider the car to be immobilised if a malfunction prevents you from driving safely.

Unresponsive car

There is a separate section in this manual for power-related issues.

General advice for malfunctions

If a function doesn't work properly, try the following actions:

- Read what the manual has to say about the function. Make sure that you are aware of what's required for it to work properly. The cause of the problem might be that you are unaware of a limitation of a specific function.
- Restart all related devices and systems. This applies to the car itself but can also include your phone or an app.
- If there is more than one way to use a function or perform a task, try the alternatives.

***i* Note**

Changes after software updates

Software updates can introduce changes to functions that affect how they work. Be sure to read the information provided with each update so that you understand why the car may behave differently.

Possible causes

When a function isn't working the way you expect it to, there are several possible causes:

- The car's settings have been changed.
- Environmental conditions are affecting the car and its systems.
- Signal interference is affecting connectivity and wireless systems.
- A fuse has blown and needs to be replaced.
- Software error.
- Mechanical failure.

Contact an authorised Volvo workshop if needed

If you can't solve the problem using the information in the manual, contact an authorised Volvo workshop.

Take note of what happened around the time the problem appeared. It may help identify the cause. A key event could be:

- Damage to the car.
- Exposure to extreme conditions.
- Recently performed servicing, maintenance or replacement of a component.
- Recently updated software.
- Any other faults or malfunctions.

^[1] In some cases, a suspected fault or failure may instead be an intentional limitation under the conditions experienced by the car.

14.3. Powerless or unresponsive car

If your car is unresponsive or appears to have no power, the cause could be flat batteries or something affecting its electrical systems.

If the car's batteries are flat, the car will not respond to some of your actions. This includes trying to unlock or start it.

If the car doesn't respond due to low power, there are several recovery options depending on the situation.

The following situations can lead to both batteries in the car going flat:

- The car is driven to 0% battery level and is then not immediately recharged.
- The car is left with a low battery level. If not plugged in for charging, the battery level drops further as the car uses a small amount of power while parked.
- The car is left without being charged for a long time, which allows the battery level to drop.
- Low temperatures temporarily reducing battery capacity below the required level to keep the car powered.

Conditions or uses that increase power consumption and result in a faster-than-expected drop in battery level include:

- Use of accessories or power-consuming car functions.
- High temperatures triggering battery cooling.

Recovery from a flat traction battery

If only the traction battery is flat, the car's systems have power but it can't be started or driven. The car shows that the battery level is at 0%. In this situation, the 12 V battery can power the systems needed to initiate charging of the traction battery. It's important to conserve energy in the 12 V battery so that you can access and charge the car.

Car recovery actions:

- If you can charge your car where it's parked, do so immediately.
- If your car can't be charged at your current location, have the car recovered and transported to a charging source. In the meantime, try to conserve the remaining power in the 12 V battery. This is important for battery health, but also keeps essential functionality available for you to use in an emergency.

Recovery from total loss of power

If the 12 V battery goes flat, the car will be completely unresponsive. This can happen if something prevents the traction battery from keeping the 12 V battery charged, such as allowing the traction battery to go flat and then not charging the car in time. If both batteries are flat, the car is entirely unresponsive and cannot be charged as usual.

Recovery actions:

- Contact an authorised Volvo workshop or a recovery and roadside assistance service.
- If there is a charging source where the car is immobilised, it may be possible to temporarily power the car using a special exterior 12 V terminal. This can allow you to initiate charging.
- If the car can't be charged where it is, it needs to be transported to a location with a charging source. An authorised Volvo workshop has the equipment to power the car and charge it.

 **Important**

12 V terminal

In the event of a total loss of power, the car can't be unlocked as the locks are electrically operated. To access the car and charge it, the car can be powered for a short time using the externally accessible 12 V terminal. It is accessed by removing a small panel by the front-left wheel housing.

Before any use of the 12 V terminal, consider the following:

- Volvo recommends that the 12 V terminal is only used by service technicians for the purpose of accessing the car as part of immobilisation recovery.
- The external 12 V terminal on your car should only be used to make your car accessible. Do not attempt to charge another car or similar external source from this point.
- Only use a 12 V charger with a maximum charging current below 30 A.
- Do not connect another 12 V battery to the terminal.
- Connecting any power source that delivers currents higher than 30 A blows the terminal's fuse, thereby disabling it.
- Only use the 12 V terminal for short amounts of time. This is not meant as a way of powering the car continuously.
- Make sure to follow the positive and negative markings on the terminals as reversing the polarity of the low voltage system can lead to damaging the low voltage system components or blowing the 30 A fuse.

Other no-power scenarios

There may be cases where you are fairly sure that the battery level is not low. In these cases, a lack of power indicates that the 12 V battery isn't receiving power from the traction battery or can't deliver power to the car.

Possible scenarios that affect the 12 V power delivery are:

- A fuse has blown and needs to be replaced.
- The 12 V battery is defective.
- There is an electrical, hardware or software fault preventing the car from turning on.

If you can't identify the cause of the problem or solve it by referring to the manual, contact an authorised Volvo workshop.

14.4. Recovery

Recovery of your car typically requires transporting it with a recovery vehicle. This is necessary if the car is immobilised and its functions cannot be restored where it is.

Contact an authorised Volvo workshop if you need to recover your car.^[1]

The recommended recovery procedure depends on the conditions and state of the car. If your car is undamaged and has power, tow mode can be activated to pull the car onto a recovery vehicle's platform. If the car is damaged, unresponsive or in safety mode, it should be lifted onto the recovery vehicle's platform.

 **Important**

Wheels off the ground

Regardless of the car's condition, it must be transported with all wheels off the ground when recovered. Forced wheel rotation during transportation can severely damage the car.

Keep a safe distance

Do not allow anyone to stand directly behind your car as it is pulled onto the recovery vehicle.

^[1] For urgent recovery needs, you can also directly contact a recovery and roadside assistance service.

14.5. Safety mode

If your car detects damage that compromises safety, it can enter safety mode.

Safety mode limits the available functions when your car has sustained damage. The car must undergo damage assessment and repairs^[1] if safety mode has been activated. Contact an authorised Volvo workshop if safety mode has been activated for any reason.

The displays clearly indicate when the car is in safety mode, if they are still functioning.

When safety mode is active, you cannot drive the car. However, if you need to move the car out of immediate danger you can exit safety mode via the centre display. Driving the car after safety mode has been deactivated should be done with caution and only for very short distances, such as to the side of the road.

 **Note**

When you exit safety mode, the car performs a safety check-up. This is then communicated in the driver display. If the check-up fails, you cannot exit safety mode to move the car.

 **Warning**

- Do not use or stay in the car when it is in safety mode. The only exception is to move it a short distance if it poses an immediate danger in traffic.
- Do not tow the car without first activating tow mode. This is done in the centre display.
- Resetting the car's status without performing damage assessment and repairs can result in further damage to the car as well as personal injury.

^[1] Volvo recommends an authorised Volvo workshop

14.6. Having your car towed

Your car can be towed short distances if necessary. For this, tow mode must first be activated.

Important

Before having your car towed

- To avoid accidentally triggering the alarm, reduce your car's alarm sensitivity before towing it.
- You can only access tow mode if the car has power. If the car can't be powered on, it will need a full recovery.
- Be sure to read all information about having your car towed before you activate tow mode.
- You should only tow your car short distances, such as to the side of the road or onto a recovery vehicle. Towing your car longer distances can damage the car by causing the battery to charge incorrectly.

To tow your car you must first activate tow mode, which involves attaching the towing eye and the winch wire. Make sure that you have all the necessary equipment ready.

1. Activate tow mode in the centre display.
 - > Tow mode activation confirmation appears.
2. Tow your car onto a recovery vehicle or to a safe place, such as the side of the road.
3. When the car is in the necessary place, engage the parking brake.
 - > Tow mode deactivates.
4. If necessary, remove the towing eye and winch wire.

Important

Always use a recovery vehicle to transport the car whenever it cannot be driven. Forced wheel rotation during transportation can severely damage your car. Make sure the car is only transported by a recovery vehicle such as a flatbed, so that the car's wheels do not touch the ground while being transported.

14.6.1. Activating tow mode

If your car needs to be towed onto a flatbed recovery vehicle, you first need to activate tow mode in settings.

 **Important**

- Having your car towed without activating tow mode may damage it. Be sure to follow the instructions in the display until you have received confirmation that tow mode is active before your car is towed.
- Tow mode can only be accessed if the car has power. If the car can't be powered on, it will need a full recovery.
- Be sure to read all information about having your car towed before you activate tow mode.

 **Note**

Tow mode is only used when having your car towed. Do not activate it when towing other vehicles or trailers.

1. Press the car symbol  in the bottom bar and go to **Settings**.
 2. Go to **Controls** → **Car modes** → **Tow mode**.
- > The tow mode tutorial appears in the centre display.
3. Follow the tutorial until you get confirmation that tow mode is active.

Tow mode deactivates when you engage the parking brake.

15. Specifications

These specifications describe your car in technical terms and figures. You might need to find some of these details, such as when buying new tyres.

This information is divided up in the following manner, with some examples of their content to help guide you.

- General car characteristics – dimensions, weights and type designations.
 - Powertrain specifications – performance, electric motor, range and electric consumption.
 - Wheel and tyre specifications – approved tyre pressures and tyre sizes.
 - Fluid specifications – brake fluid and air conditioning coolant.
 - Certificates and type approvals
-

15.1. General car characteristics

These are the basic facts about your car. This data helps you determine your car's specific set-up.

You may need to know these things about your car for a number of reasons. For example, to be able to order the correct spare parts or accessories.

15.1.1. Car dimensions

Here you can find your car's measurements, such as length and height.

Locate the measurement you're looking for in the images first, then check the corresponding letter in the table below.

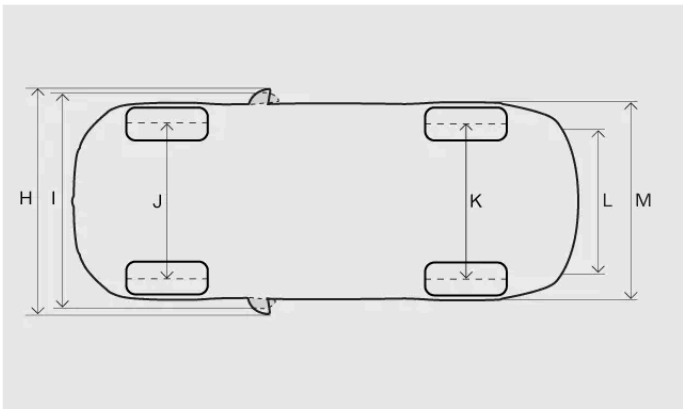
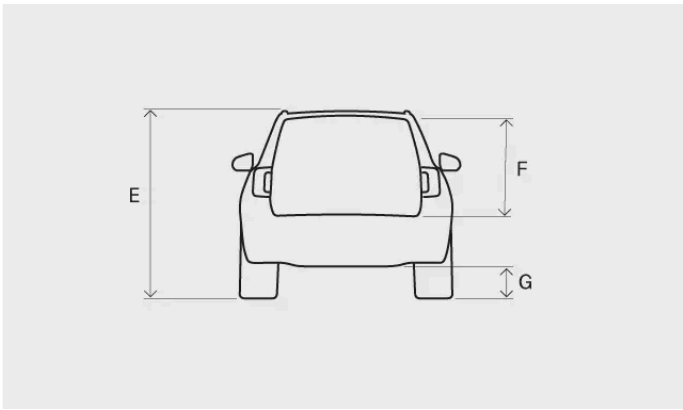
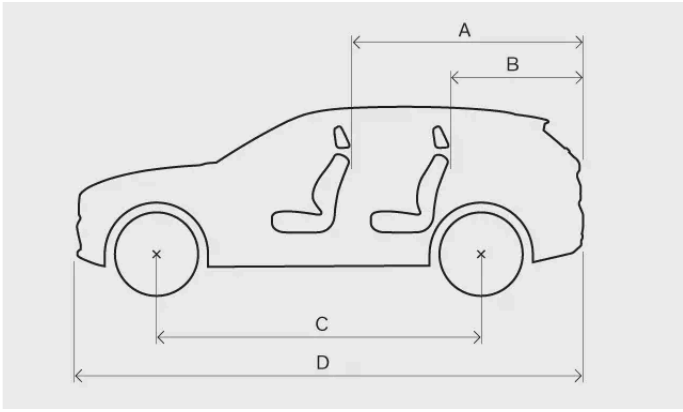

Measurement		Millimetres	Inches
A	Load length, floor, folded seat	2051 1276 ^[1]	80.7 50.2 ^[1]
B	Load length, floor	569	22.4
C	Wheelbase	2985	117.5
D	Length	5037	198.3
E	Height ^[2]	1741	68.5
F	Load height	779	30.7
G	Ground clearance ^[2]	213	8.4
H	Width including folded-out wing mirrors	2113	83.2
I	Width including folded-in wing mirrors	2039	80.3

Measurement		Millimetres	Inches
J	Front track ^[2]	1672–1676 ^[3]	65.8–66.0 ^[3]
K	Rear track ^[2]	1666–1677 ^[3]	65.6–66.0 ^[3]
L	Load width, floor	1138	44.8
M	Width	1964	77.3

^[1] From the second seat row in a car with 6 or 7 seats.

^[2] At kerb weight plus one person.

^[3] Depending on rim size.

15.1.2. Weights

Your car's maximum gross vehicle weight can be read on a label in the car.

Weight terminology

Kerb weight Weight of the car, including the driver, all oils, fluids and standard equipment. This does not include passengers, cargo, optional equipment or towball load when there is a trailer connected.

Permitted maximum load Gross vehicle weight - Kerb weight

Maximum gross vehicle weight Kerb weight + cargo + passengers

The documented kerb weight applies to cars in the standard version, such as a car without extra equipment or accessories. This means that for every accessory added, the loading capacity of the car is reduced correspondingly by the weight of the accessory.

Weighing the car is a sure way to determine the kerb weight of your own particular car.



Warning

The car's driving characteristics change depending on how heavily it is loaded and how the load is distributed.

Maximum load

Maximum load See your car's registration document.

Maximum roof load 100 kg

Label weights

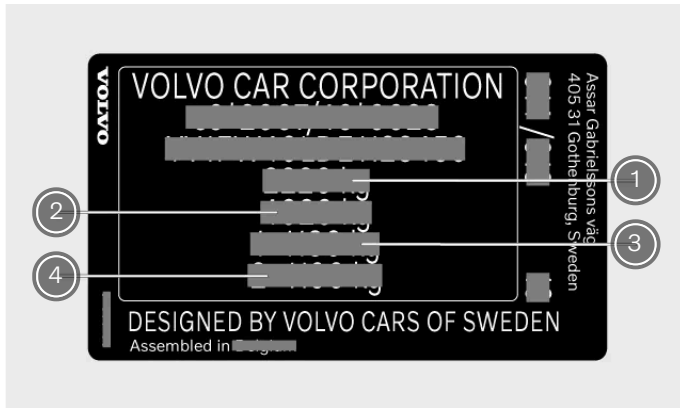

The label is located on the right-hand door pillar and will be visible when the door is opened.

- ① Maximum gross vehicle weight
- ② Maximum train weight (car+trailer)
- ③ Maximum front axle load
- ④ Maximum rear axle load

15.1.3. Towing specifications and capabilities

Towing weights and towball loads for driving with a trailer can be viewed below.

! Important

Always follow local rules and regulations when driving with a trailer, such as speed for the vehicle combination.

Braked trailer

Max. trailer weight 2200 kg

Max. towball load 100 kg

Unbraked trailer

Max. trailer weight 750 kg

15.1.4. Towbar specifications

Here you can find measurements related to your towbar.

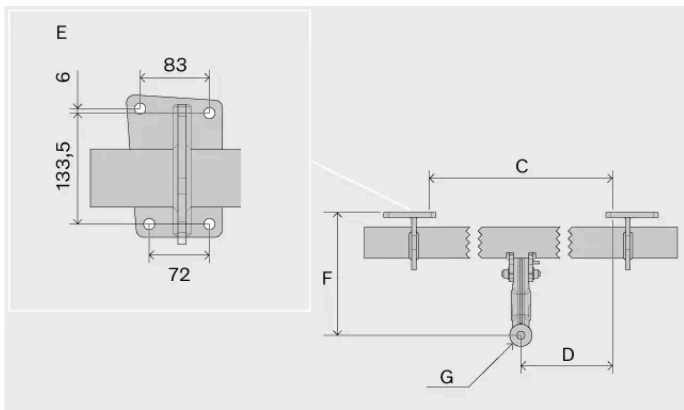
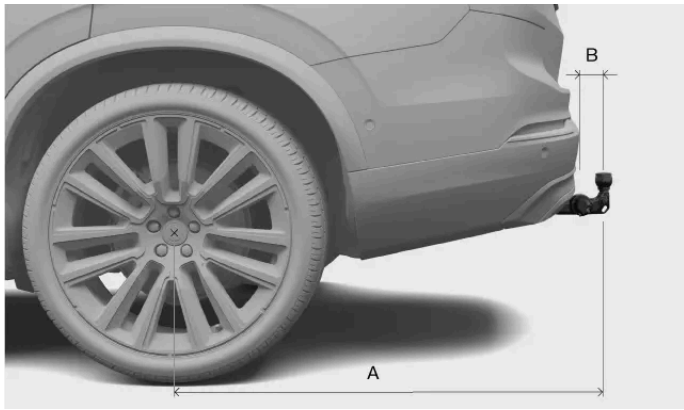

Dimensions, mounting points in millimetres (inches)

A 1204 (47.4)

B 73 (2.9)

C 876 (34.5)

D 438 (17.2)

E See above image

F 312 (12.3)

G Ball centre

15.1.5. Type designations

Knowing the car's detailed information can help facilitate contact with a Volvo dealer and when ordering spare parts and accessories.

Product label



The product labels are located on the right-hand door pillar. One product label is located at the bottom of the pillar and the other one is on the front side of the pillar. The labels will be visible when the door is opened.

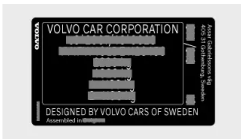

Product label – 1

Examples of information you can find on the label:

- Type approval number
- Vehicle identification number
- Weight information
- Code designation for exterior colour



Product label – 2

Examples of information you can find on the label:

- Type approval number
- Vehicle identification number

Note

Labels depicted in this manual are generic representations of those found around your car. The manual only contains their location and what kind of information they hold. Find the actual label for specific information about your car.

Tip

For many markets, more information can also be found in the car's registration document.

15.2. Powertrain specifications

Find the specifications regarding your car's propulsion.

These specifications provide details about what your car is capable of and certified for. They also specify data on relevant charging cables.

15.2.1. Electric motor specifications

Your car is powered by two electric motors (front and rear) and you can find the specifications here.

Twin Motor Performance			
Front	Electric motor type		Asynchronous motor
	Electric motor model		F22DA
	Max. power output	kW	220
		hp	299
	Rated power (continuous power)	kW	N/A
	Max. torque	Nm	390
lb-ft		288	
Rear	Electric motor type		Synchronous motor with permanent magnet
	Electric motor model		R31DA
	Max. power output	kW	280
		hp	381
	Rated power (continuous power)	kW	N/A
	Max. torque	Nm	480
lb-ft		354	
Total car (system)	Max. power output	kW	500
		hp	680
	Rated power (continuous power)	kW	N/A
	Max. torque	Nm	870
		lb-ft	642

 **Note**

If data is missing it will be updated at a later stage.

15.2.2. Performance

You can find the car's top speed and acceleration time below.

Top speed	180 km/h (112 mph)
Acceleration time 0-100 km/h (0-60 mph)	4.2 seconds (4.0 seconds)

Note

If data is missing it will be updated at a later stage.

15.2.3. The car's certified values for range and electricity consumption

These are the certified values for your car's range and use of electrical power. However, range and electricity consumption vary according to the circumstances and driving conditions. These values should not be interpreted as an expected range but should primarily be used to compare different cars.

Procedure used to establish the values

The values in the table below are established in accordance with WLTP^[1], which is an international test method performed in a laboratory environment. The method uses drive cycles to simulate an average driving run of the car. Every drive cycle is determined by different conditions such as speed, time and mileage.

The standard is based on four drive cycle profiles with different average speeds:

Urban driving	Low speed
Suburban driving	Medium speed
Extra-urban driving	High speed
Motorway driving	Extra high speed

Symbol explanation

This is an explanation of the symbols used in the specification table below.



Certified value for the car's potential range (km)^[2].



Urban and suburban driving.



Average value over all four drive cycle phases (urban, suburban, extra-urban and motorway driving).









Certified value for the car's electricity consumption (kWh/100 km). The value is an average over all four drive cycle phases (urban, suburban, extra-urban and motorway driving).



Low value.

 High value.

Specifications for range and electricity consumption

Twin Motor Performance			
	 η_{ec}	 Range	
			
	19.4	781	617
	22.8	659	521

Note

If data is missing in the table, it will be updated at a later date.

Certified values and actual values

When driving, the car's range and electricity consumption can differ from the certified value indications. Some reasons for this may be:

- Driving style.
- Extra equipment and cargo affect the car's weight or air resistance.
- Non-standard wheels can increase rolling resistance and air resistance.
- High speed causes increased air resistance.
- Road, traffic and weather conditions.
- The general condition of the car.

[1] Worldwide Harmonised Light-Duty Vehicles Test Procedure

[2] The value should not be interpreted as an expected range. The range is difficult to achieve during normal driving.

15.2.4. Charging cable specifications

These specifications provide details about mode 2 charging cables. Mode 2 charging cables can be purchased from the Volvo Extras shop.

Ambient temperature -32 °C to 50 °C (-25 °F to 122 °F)

The content of this manual represents the status of the user manual at the time of printing and may not be completely valid in future instances. For more information, refer to the first page for the complete disclaimer note.

Residual-current device

Mode 2 charging cables have a built-in residual-current device that protects the car and the user from electric shocks caused by system faults.

Warning

The residual-current device helps to protect the car's charging system, but there is no guarantee that an overload never occurs.

Important

The residual-current device does not protect the household socket.

Temperature monitoring

The mode 2 cable is also equipped with a control unit, which has a built-in overtemperature monitoring function. This monitors the temperature of both the cable and the household socket.

Important

- Avoid exposing the control unit and its plug connector to direct sunlight. The overheating protection in the plug connector may otherwise reduce or stop the charging of your car.
- If charging is unintentionally stopped, both the charging cable and the car's charging system should be checked by a trained and qualified Volvo service technician. The household socket should also be checked by a licensed electrician.

15.2.5. Charging port labels and identifiers

Your car has a label with identifiers that provide information about charging compatibility.

Charging compatibility identification

You can find out if your car and the charging point are compatible by looking at the identification labels. The labels are given in accordance with the EN 17186 standard. The identification labels include a letter or letters. If a letter on the charging point match a letter on your car's identification label, it means that they are compatible.



The identification label are located on the inside of the charging lid.

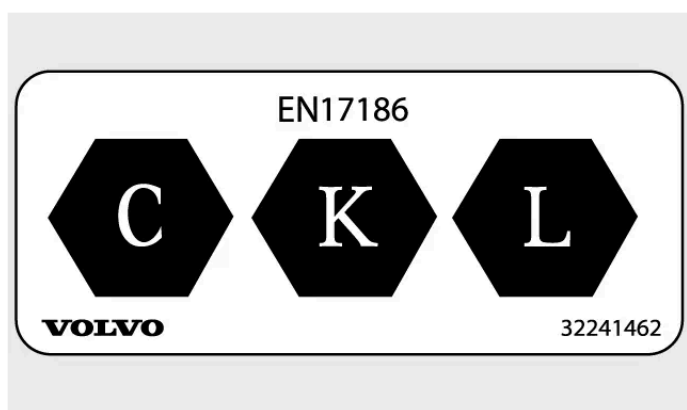

Charging compatibility identification label.

The letters indicate the types of charging point your car is compatible with. Your car has three letters defining compatibility. Details can be found in the EN 17186 standard.

Identification label	Charging type
C	AC ^[1] charging type 2
K and L	DC ^[2] charging (including Combined Charging System (CCS) Combo 2)

^[1] Alternating current

^[2] Direct current

15.3. Wheel and tyre specifications

Here you can find specific data for wheels and tyres applicable to your car.

 **Note**

There are more recommendations regarding wheels and tyres that are important to be aware of.

15.3.1. Approved tyre pressures

You can find the approved tyre pressures for your car in the table below.

The recommended pressure for approved tyres can be found on the tyre pressure label. It's located on the door pillar on the driver's side and is visible when the door is opened.

Tyre size	Speed	Load 1-3 persons		Max load		ECO pressure
		Front kPa (psi)	Rear kPa (psi)	Front kPa (psi)	Rear kPa (psi)	Front/rear kPa (psi)
255/50 R20 285/45 R20 265/45 R21 295/40 R21	0-180 km/h (0-112 mph)	280 (41)	280 (41)	280 (41)	280 (41)	280 (41) / 280 (41)
265/40 R22 295/35 R22	0-180 km/h (0-112 mph)	280 (41)	280 (41)	290 (42)	290 (42)	290 (42) / 290 (42)
Temporary Spare Tyre	max 80 km/h (max 50 mph)	420 (60)	420 (60)	420 (60)	420 (60)	420 (60)

 **Important**

Never switch the front and rear wheels around.

15.3.2. Approved wheel and tyre sizes

In some countries, approved sizes are not indicated by the car's registration documents. However, you can find all approved combinations of wheel rims and tyres below.

Front

Tyre	Wheel rim
255/50 R20	8.5x20x40.5
265/45 R21	9x21x38.5
265/40 R22	9x22x38.5

Rear

Tyre	Wheel rim
285/45 R20	9.5x20x39

The content of this manual represents the status of the user manual at the time of printing and may not be completely valid in future instances. For more information, refer to the first page for the complete disclaimer note.

Tyre	Wheel rim
295/40 R21	10x21x44.5
295/35 R22	10x22x44.5

 **Important**

Never switch the front and rear wheels around.

15.3.3. Minimum permitted load index and speed rating for tyres

All tyres have specific speed and load limitations. Tyres must have a speed rating that is equal to or higher than your car's maximum speed. The tyres must also have a load index that is equal to or higher than the load index that is specified by Volvo as the minimum permitted for your car's weight.

Your tyre's specification must be at least equal to or greater than:

Minimum permitted load index (LI), front 106

Minimum permitted load index (LI), rear 108

Minimum permitted speed rating (SS) H

 **Warning**

If a tyre with a speed rating that is too low is used, it may overheat and become damaged.

 **Note**

Winter tyres

Winter tyres^[1] are allowed to have a lower speed rating than your car's top speed. However, if your winter tyres do have a lower speed rating than your car's top speed, you are not allowed to drive faster than the tyres' speed rating.

^[1] Both studded and stud-free tyres.

15.4. Fluid specifications

Your car has fluids to help different systems function properly. When it is time to refill or perform maintenance, you may need to know the specific data for them.

For some fluids, it is recommended that they are changed or filled by an authorised Volvo workshop. Check this section for the fluid you need information on and, if necessary, contact an authorised Volvo workshop to schedule an appointment.

15.4.1. Brake fluid specifications

The medium in your car's brake system is called brake fluid.

Prescribed grade Volvo Original or equivalent brake fluid that fulfils a combination of the Dot 4, 5.1 and ISO 4925 class 6 classifications.

Important

It is recommended that brake fluid is changed or filled by an authorised Volvo workshop.

15.4.2. Climate system specifications

Here you find the information about the refrigerant quantity and the prescribed quality and volume for compressor oil.

Climate system label

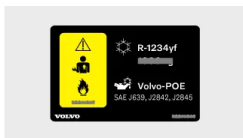

The label with information on climate system fluids is located on the underside of the bonnet.

On this label you can find:

- Refrigerant type (R1234yf)
- Refrigerant quantity

Label symbols



Caution



A trained and certified technician is required to service the mobile air conditioning system^[1]



Flammable refrigerants



Mobile air conditioning system^[1]



Lubricant type

Compressor oil

Volume 150 ml (5.07 US fl oz) (5.28 UK fl oz)

Prescribed grade POE V100

Servicing and repair of the climate system

Warning

Servicing and repair

The climate system contains pressurised refrigerant. The climate system must only be serviced and repaired by trained and certified technicians in order to ensure the safety of the system ^[2]. Volvo recommends an authorised Volvo workshop for any repair or service needs.

Important

Repairing the evaporator

The climate system's evaporator must never be repaired or replaced with a previously used evaporator. A new evaporator must be certified and labelled in accordance with SAE J2842.

[1] MAC

[2] In accordance with SAE J2845 (Technician Training for Safe Service and Containment of Refrigerants Used in Mobile A/C System).

15.5. Certificates and type approvals

This documentation shows that your car meets certain standards and specifications.

User manuals are required by law to provide documentation of certain certificates and type approvals.

For more information, contact Volvo support.

15.5.1. Detailed child restraint information

The table provides detailed information for manufacturers of child restraint systems regarding which locations in the car are appropriate for different kinds of child restraints.

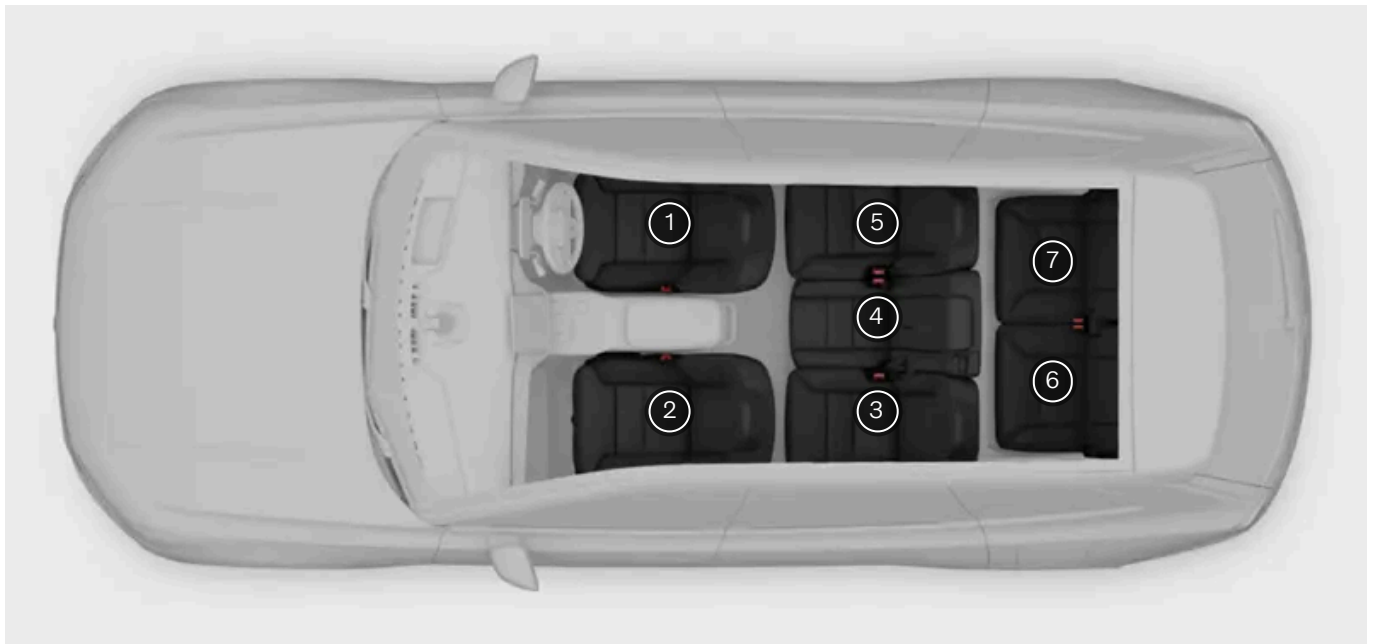

Seat position ^[1]	1	2 (with disabled airbag, only rearward-facing child restraints) ^[2]	2 (with enabled airbag, only forward-facing child restraints) ^[2]	3	4	5	6	7
Seat position suitable for universal category restraints which are attached using the car's seatbelt (Yes/No)	No	Yes ^[3]	Yes ^[3]	Yes	Yes	Yes	Yes	Yes
Seat position for i-Size (Yes/No)	No	No	No	Yes	No	Yes	No	No
Seat position lateral fixture (L1/L2/No)	No	No	No	No	No	No	No	No
Largest suitable rearward-facing fixture (R1/R2/R3/No)	No	R3 ^{[4] [5] [6]}	No	R3	No	R3	No	No
Largest suitable forward-facing fixture (F2/F2x/F3/No)	No	No	F3 ^{[4] [5] [6]}	F3	No	F3	No	No
Largest suitable booster fixture (B2/B3/No)	No	No	B3 ^[7]	B3 ^[7]	B3 ^[8]	B3 ^[7]	B3	B3

^[1] According to illustration.

^[2] The seat cushion extension must always be retracted when installing child restraints.

^[3] Adjust the backrest to a more upright position when necessary.

^[4] Works for the installation of ISOFIX child restraints that are vehicle specific approved if the car is equipped with the ISOFIX console accessory (availability may vary between regions). Top tether anchorage points are not available for this seat.

^[5] Adjust the backrest so that the seat headrest does not touch the child restraint.

^[6] Do not fit support legs to any raised or uneven floor surfaces, footrests or other objects. Adjust seat position if necessary to avoid.



^[7] Adjust belt height adjuster to its highest point.

^[8] Adjust headrest when necessary.

15.5.2. Exterior radar type approvals



Find the exterior radar type approval you're looking for among the ones listed here.





Front centre radar

Region	Labels and symbols	Specification
Argentina	 C-22292	C-22292
Australia		
Brazil		Este equipamento não tem direito à proteção contra interferência prejudicial e não pode causar interferência em sistemas devidamente autorizados. Para mais informações, consulte o site da ANATEL – https://www.gov.br/anatel/pt-br [https://www.gov.br/anatel/pt-br]
Canada		<p>Advanced Radar Sensor, ARS5-B IC: 4135A-ARS5B</p> <p>This device contains licence-exempt transmitter(s)/receiver(s) that comply with Innovation, Science and Economic Development Canada's licence-exempt RSS(s). Operation is subject to the following two conditions:</p> <p>(1) This device may not cause interference.</p> <p>(2) This device must accept any interference, including interference that may cause undesired operation of the device.</p> <p>L'émetteur/récepteur exempt de licence contenu dans le présent appareil est conforme aux CNR d'Innovation, Sciences et Développement économique Canada applicables aux appareils radio exempts de licence. L'exploitation est autorisée aux deux conditions suivantes:</p> <p>(1) L'appareil ne doit pas produire de brouillage;</p> <p>(2) L'appareil doit accepter tout brouillage radioélectrique subi, même si le brouillage est susceptible d'en compromettre le fonctionnement.</p> <p>Radiofrequency radiation exposure Information: This equipment complies with radiation exposure limits set forth for an uncontrolled environment. This equipment should be installed and operated with minimum distance of 20 cm between the radiator and the body of any persons, user or bystander.</p> <p>Informations sur l'exposition aux rayonnements radiofréquences: Cet équipement est conforme aux limites d'exposition aux rayonnements établies pour un environnement non contrôlé. Cet équipement doit être installé et utilisé avec un minimum de 20 cm de distance entre la source de rayonnement et votre corps.</p>

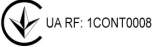

Region	Labels and symbols	Specification
		<p>ental.automotive-approvals.com/ Sagedusriba(d), millel raadioseade töötab: 76–77 GHz Raadioseadme töösagedus(t)el edastatav maksimaalne saatevõimsus: 2.0 W (33dBm RMS EIRP)</p> <p>Greek Με την παρούσα ο/η ADC Automotive Distance Control Systems GmbH, δηλώνει ότι ο ραδιοεξοπλισμός ARS5-B πληροί την οδηγία 2014/53/ΕΕ. Το πλήρες κείμενο της δήλωσης συμμόρφωσης ΕΕ διατίθεται στην ακόλουθη ιστοσελίδα στο διαδίκτυο: http://continental.automotive-approvals.com/ Οι ζώνες συχνοτήτων στις οποίες λειτουργεί ο ραδιοεξοπλισμός: 76–77 GHz η μέγιστη ραδιοηλεκτρική ισχύς στις ζώνες συχνοτήτων στις οποίες λειτουργεί ο ραδιοεξοπλισμός: 2.0 W (33dBm RMS EIRP)</p> <p>French Le soussigné, ADC Automotive Distance Control Systems GmbH, déclare que l'équipement radioélectrique du type ARS5-B est conforme à la directive 2014/53/UE. Le texte complet de la déclaration UE de conformité est disponible à l'adresse internet suivante : http://continental.automotive-approvals.com/ Bandes de fréquences utilisées par l'équipement radioélectrique : 76–77 GHz Puissance de radiofréquence maximale transmise sur les bandes de fréquences utilisées par l'équipement radioélectrique : 2.0 W (33dBm RMS EIRP)</p> <p>Croatian ADC Automotive Distance Control Systems GmbH ovime izjavljuje da je radijska oprema tipa ARS5-B u skladu s Direktivom 2014/53/EU. Cjeloviti tekst EU izjave o sukladnosti dostupan je na sljedećoj internetskoj adresi: http://continental.automotive-approvals.com/ Frekvencijski pojas (frekvencijski pojasi) u kojem (kojima) radijska oprema radi: 76–77 GHz Najveća radiofrekvencijska snaga koja se prenosi u frekvencijskom pojasu (frekvencijskim pojasi) u kojem (kojima) radijska oprema radi: 2.0 W (33dBm RMS EIRP)</p> <p>Italian Il fabbricante, ADC Automotive Distance Control Systems GmbH, dichiara che il tipo di apparecchiatura radio ARS5-B è conforme alla direttiva 2014/53/UE. Il testo completo della dichiarazione di conformità UE è disponibile al seguente indirizzo Internet: http://continental.automotive-approvals.com/ Bande di frequenza di funzionamento dell'apparecchiatura radio: 76–77 GHz Massima potenza a radiofrequenza trasmessa nelle bande di frequenza in cui opera l'apparecchiatura radio: 2.0 W (33dBm RMS EIRP)</p> <p>Latvian Ar šo ADC Automotive Distance Control Systems GmbH deklarē, ka radioiekārta ARS5-B atbilst Direktīvai 2014/53/ES. Pilns ES atbilstības deklarācijas teksts ir pieejams šādā interneta vietnē: http://continental.automotive-approvals.com/ Frekvenču joslu(-as), kurā(-ās) radioiekārtas darbojas: 76–77 GHz Frekvenču josla(-ās), kurā(-ās) darbojas radioiekārtas, maksimālo pārraidītā signāla jaudu.: 2.0 W (33dBm RMS EIRP)</p> <p>Lithuanian Aš, ADC Automotive Distance Control Systems GmbH, patvirtinu, kad radijo įrenginių tipas ARS5-B atitinka Direktyvą 2014/53/ES. Visas ES atitikties deklaracijos tekstas prieinamas šiuo interneto adresu: http://continental.automotive-approvals.com/ Dažnių juosta (-os), kurioje (-iose) veikia radijo įrenginiai: 76–77 GHz Didžiausia radijo dažnių galia, perduodama toje (tose) dažnių juostoje (-ose), kurioje (-iose) veikia radijo įrenginiai: 2.0 W (33dBm RMS EIRP)</p> <p>Hungarian ADC Automotive Distance Control Systems GmbH igazolja, hogy a ARS5-B típusú rádióberendezés megfelel a 2014/53/EU irányelvnek. Az EU-megfelelőségi nyilatkozat teljes szövege elérhető a következő internetes címen: http://continental.automotive-approvals.com/ Az(ok) a frekvenciasáv(ok), amely(ek)en a rádióberendezés működik: 76–77 GHz Az abban a frekvenciasávban vagy azokban a frekvenciasávokban továbbított maximális jelerősség, amely(ek)ben a rádióberendezés üzemel: 2.0 W (33dBm RMS EIRP)</p> <p>Maltese B'dan, ADC Automotive Distance Control Systems GmbH, niddikjara li dan it-tip ta' tagħmir tar-radju ARS5-B huwa konformi mad-Direttiva 2014/53/UE. It-test kollu tad-dikjarazzjoni ta' konformità ta-UE huwa disponibbli f'dan l-indirizz ta-Internet li ġej: http://continental.automotive-approvals.com/ Il-medda/meded tal-frekwenza li jaħdem fihom it-tagħmir tar-radju: 76–77 GHz Il-potenza massima tal-frekwenza tar-radju trażmessa fil-medda/meded tal-frekwenza li jaħdem fihom it-tagħmir tar-radju: 2.0 W (33dBm RMS EIRP)</p> <p>Dutch Hierbij verklaar ik, ADC Automotive Distance Control Systems GmbH, dat het type radioapparatuur ARS5-B conform is met Richtlijn 2014/53/EU. De volledige tekst van de EU-conformiteitsverklaring kan worden geraadpleegd op het volgende internetadres: http://continental.automotive-approvals.com/ Frequentieband(en) waarin de radioapparatuur functioneert: 76–77 GHz Maximaal radiofrequent vermogen uitgezonden in de frequentieband(en) waarin de radioapparatuur functioneert: 2.0 W (33dBm RMS EIRP)</p> <p>Polish ADC Automotive Distance Control Systems GmbH niniejszym oświadczam, że typ urządzenia radiowego ARS5-B jest zgodny z dyrektywą 2014/53/UE. Pełny tekst deklaracji zgodności UE jest dostępny pod następującym adresem internetowym: http://continental.automotive-approvals.com/ Zakresu(-ów) częstotliwości, w którym (których) pracuje urządzenie radiowe: 76–77 GHz</p>

Region	Labels and symbols	Specification
		<p>Maksimalnej mocy częstotliwości radiowej emitowanej w zakresie(-ach) częstotliwości, w którym (których) pracuje urządzenie radiowe: 2.0 W (33dBm RMS EIRP)</p> <p>Portuguese</p> <p>O(a) abaixo assinado(a) ADC Automotive Distance Control Systems GmbH declara que o presente tipo de equipamento de rádio ARS5-B está em conformidade com a Diretiva 2014/53/UE. O texto integral da declaração de conformidade está disponível no seguinte endereço de Internet: http://continental.automotive-approvals.com/</p> <p>A(s) banda(s) de frequências em que o equipamento de rádio funciona: 76–77 GHz</p> <p>A potência máxima de radiofrequências transmitida na(s) banda(s) de frequências em que o equipamento de rádio funciona: 2.0 W (33dBm RMS EIRP)</p> <p>Romanian</p> <p>Prin prezenta, ADC Automotive Distance Control Systems GmbH declară că tipul de echipamente radio ARS5-B este în conformitate cu Directiva 2014/53/UE. Textul integral al declarației UE de conformitate este disponibil la următoarea adresă internet: http://continental.automotive-approvals.com/</p> <p>Banda (benzile) de frecvențe în care funcționează echipamentul radio: 76–77 GHz</p> <p>Puterea maximă de radiofrecvență transmisă în banda (benzile) de frecvențe în care funcționează echipamentul radio: 2.0 W (33dBm RMS EIRP)</p> <p>Slovak</p> <p>ADC Automotive Distance Control Systems GmbH týmto vyhlasuje, že rádiové zariadenie typu ARS5-B je v súlade so smernicou 2014/53/EÚ. Úplné EÚ vyhlásenie o zhode je k dispozícii na tejto internetovej adrese: http://continental.automotive-approvals.com/</p> <p>Frekvenčné pásmo resp. pásma, v ktorých rádiové zariadenie pracuje: 76–77 GHz</p> <p>Maximálny vysokofrekvenčný výkon prenášaný vo frekvenčnom pásme, resp. pásmach, v ktorých rádiové zariadenie pracuje: 2.0 W (33dBm RMS EIRP)</p> <p>Slovenian</p> <p>ADC Automotive Distance Control Systems GmbH potrjuje, da je tip radijske opreme ARS5-B skladen z Direktivo 2014/53/EU. Celotno besedilo izjave EU o skladnosti je na voljo na naslednjem spletnem naslovu: http://continental.automotive-approvals.com/</p> <p>Frekvenčni pas ali pasovi, na katerih deluje radijska oprema: 76–77 GHz</p> <p>Največja energija za radijsko frekvenco, preneseno po frekvenčnem pasu ali pasovih, na katerih radijska oprema deluje: 2.0 W (33dBm RMS EIRP)</p> <p>Finnish</p> <p>ADC Automotive Distance Control Systems GmbH vakuuttaa, että radiolaitetyyppi ARS5-B on direktiivin 2014/53/EU mukainen. EU-vaatimusten mukaisuusvakuutuksen täysimittainen teksti on saatavilla seuraavassa internetosoitteessa: http://continental.automotive-approvals.com/</p> <p>Radiotaaajuudet, joilla radiolaitte toimii: 76–77 GHz</p> <p>Suurin mahdollinen lähetysteho radiotaaajuuksilla, joilla radiolaitte toimii: 2.0 W (33dBm RMS EIRP)</p> <p>Swedish</p> <p>Härmed försäkrar ADC Automotive Distance Control Systems GmbH att denna typ av radioutrustning ARS5-B överensstämmer med direktiv 2014/53/EU. Den fullständiga texten till EU-försäkran om överensstämmelse finns på följande webbadress: http://continental.automotive-approvals.com/</p> <p>Det eller de frekvensband där radioutrustningen arbetar: 76–77 GHz</p> <p>Den maximala radiofrekvenseffekt som överförs inom det eller de frekvensband där radioutrustningen arbetar: 2.0 W (33dBm RMS EIRP)</p> <p>EFTA countries</p> <p>Icelandic</p> <p>Hér með lýsir ADC Automotive Distance Control Systems GmbH því yfir, að fjarskiptabúnaðurinn að gerð ARS5-B er í samræmi við tilskipun 2014/53/ESB. Textinn í fullri lengd um Samræmisýfirlýsingu ESB er aðgengilegur á eftirfarandi veffangi: http://continental.automotive-approvals.com/</p> <p>Bandbreidd(ir), sem fjarskiptabúnaðurinn starfar í: 76–77 GHz</p> <p>Hámarks fjarskiptatíðni sendistyrkleika í bandbreiddinni/bandbreiddunum sem fjarskiptabúnaðurinn starfar í: 2.0 W (33dBm RMS EIRP)</p> <p>Custom Union Agreement between EU and Turkey</p> <p>Turkish</p> <p>İşbu belge ile, ADC Automotive Distance Control Systems GmbH şirketi ARS5-B tipi radyo ekipmanının 2014/53/AB sayılı direktife uygun olduğunu beyan eder. AB uygunluk beyanının tam metni aşağıdaki İnternet adresinde mevcuttur: http://continental.automotive-approvals.com/</p> <p>Radyo cihazının çalıştığı frekans bandı/bantları: 76–77 GHz</p> <p>Radyo ekipmanının çalıştığı frekans bandında/bantlarında iletilen maksimum radyo frekansı gücü: 2.0 W (33dBm RMS EIRP)</p> <p>Additional languages</p> <p>Albanian</p> <p>Nëpërmjet këtij dokumenti, "ADC Automotive Distance Control Systems GmbH" deklaron se radiopajisja e llojit ARS5-B është në pajtim me direktivën 2014/53/BE. Teksti i plotë i deklaratës së konformitetit të BE-së disponohet në adresën e mëposhtme të internetit: http://continental.automotive-approvals.com/</p> <p>Brezat e frekuencës në të cilat punon radiopajisja: 76–77 GHz</p> <p>Fuqia maksimale e radiofrekuencës e transmetuar në brezat e frekuencës në të cilat punon radiopajisja: 2.0 W (33 dBm RMS EIRP)</p> <p>Bosnian</p>

Region	Labels and symbols	Specification
		<p>Ovim putem kompanija ADC Automotive Distance Control Systems GmbH potvrđuje da je tip radio opreme ARS5-B u skladu s Direktivom 2014/53/EU. Cjelokupni tekst EU izjave o usklađenosti je dostupan na sljedećoj web adresi: http://continental.automotive-approvals.com/</p> <p>Frekvencijski pojasevi na kojima funkcioniра radio oprema: 76–77 GHz</p> <p>Maksimalna snaga radiofrekvencije koja se prenosi putem frekvencijskih pojaseva na kojima funkcioniра radio oprema: 2.0 W (33 dBm RMS EIRP)</p> <p>Georgian</p> <p>ამით, ADC Automotive Distance Control Systems GmbH აცხადებს, რომ ARS5-B ტიპის რადიომონყობილობა შეესაბამება 2014/53/EU დირექტივას. ევროკავშირის შესაბამისობის დეკლარაციის სრული ტექსტი ხელმისაწვდომია შემდეგ ინტერნეტმისამართზე: http://continental.automotive-approvals.com/ სიხშირის დიაპაზონ(ებ)ი, რომელშიც/რომლებშიც რადიომონყობილობა მუშაობს: 76–77 გჰც რადიოსიხშირის მაქსიმალური სიმძლავრე, გადაცემული სიხშირის დიაპაზონ(ებ)ში, რომელშიც/რომლებშიც რადიომონყობილობა მუშაობს: 2.0 ვტ (33 დბმვ RMS EIRP)</p> <p>Macedonian</p> <p>ADC Automotive Distance Control Systems GmbH изјавува дека радио опремата од типот ARS5- B е во сообразност со Директивата 2014/53/EU. Целосниот текст на Декларацијата за сообразност на ЕУ е достапен на следната интернет-адреса: http://continental.automotive-approvals.com/</p> <p>Фреквентно поле(иња) во кои радио опремата функционира: 76–77 GHz</p> <p>Максимална моќност на радиофреквенција која се пренесува во фреквентното поле(иња) во кои радио опремата функционира: 2.0 W (33 dBm RMS EIRP)</p>
Ghana		AR2-0M-GE2-114
Indonesia	<p>For products manufactured in China:</p> 	
Israel		<p>מספר זיהוי היבואן 510485261</p> <p>חל איסור לבצע פעולות במכשיר שיש בהן כדי לשנות את תכונותיו האלחוטיות של המכשיר, ובכלל זה שינוי תוכנה, החלפת אנטנה מקורית או הוספת אפשרות לחיבור לאנטנה חיצונית, בלא קבלת אישור משרד התקשורת, בשל החשש להפרעות אלחוטיות.</p>
Jordan		<p>ARS5-B</p> <p>ADC Automotive Distance Control Systems GmbH Peter-Dornier-Strasse 10, 88131 Lindau, Germany Continental</p>
Malaysia		
Mexico		IFETEL: RCPCOAR18-1800
Moldova		<p>Romanian</p> <p>DECLARAȚIA UE DE CONFORMITATE SIMPLIFICATĂ</p> <p>Prin prezenta, ADC Automotive Distance Control Systems GmbH declară că tipul de echipamente radio ARS5-B este în conformitate cu Reglementarea tehnică „Punerea la dispoziție pe piață a echipamentelor radio”. Textul integral al declarației de conformitate este disponibil la următoarea adresă de Internet: http://continental.automotive-approvals.com/</p> <p>Banda (benzile) de frecvențe în care funcționează echipamentul radio: 76–77 GHz</p> <p>Puterea maximă de radiofrecvență transmisă în banda (benzile) de frecvențe în care funcționează echipamentul radio: 2.0 W (33dBm RMS EIRP)</p>
Morocco		<p>AGREE PAR L'ANRT MAROC</p> <p>Numéro d'agrément: MR 17505 ANRT 2018</p> <p>Date d'agrément: 14/09/2018</p>

Region	Labels and symbols	Specification
		
Ukraine		<p>US RF: 1CONT0008</p> <p>Ukrainian</p> <p>Цим ADC Automotive Distance Control Systems GmbH заявляє, що радіобладнання типу ARS5-B відповідає вимогам Директиви 2014/53/EU. Повний текст декларації ЄС про відповідність доступний за наступною адресою в мережі Інтернет: http://continental.automotive-approvals.com/</p> <p>Частотний діапазон(-и), в якому працює радіобладнання: 76–77 ГГц</p> <p>Максимальна потужність радіочастотного сигналу, що передається у частотному діапазоні(-ах), в якому працює радіобладнання: 2.0 Вт (33 дБм середньоквадратична ефективна потужність випромінювання)</p>
United Kingdom		<p>Model: ARS5-B</p> <p>FCC ID: OAYARS5B</p> <p>Contact information</p> <p>Volvo Car UK, Scandinavia House, Norreys Drive, Maidenhead, SL6 4FL, UK.</p> <p>Phone number: +441628 422200</p> <p>Simplified UK declaration of conformity</p> <p>Hereby, ADC Automotive Distance Control Systems GmbH declares that the radio equipment type ARS5-B is in compliance with the Radio Equipment Regulations 2017, SI 2017:1206 (as amended). The full text of the UK declaration of conformity is available at the following internet address: http://continental.automotive-approvals.com/</p> <p>Frequency band(s) in which the radio equipment operates: 76–77 GHz</p> <p>Maximum radio-frequency power transmitted in the frequency band(s) in which the radio equipment operates: 2.0 W (33 dBm RMS EIRP)</p>
United States		<p>Model: ARS5-B</p> <p>FCC ID: OAYARS5B</p> <p>Radiofrequency radiation exposure information: This equipment complies with FCC radiation exposure limits set forth for an uncontrolled environment. This equipment should be installed and operated with minimum distance of 20 cm between the radiator and your body. This transmitter must not be co-located or operating in conjunction with any other antenna or transmitter. Changes or modifications not expressly approved by the party responsible for compliance could void the user's authority to operate the equipment.</p>
Vietnam		
Zambia		

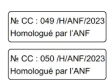
Front corner radars



Region	Labels and symbols	Specification
Argentina		
Algeria	 <p>N° CC : 049 /HIANF/2023 Homologué par l'ANF</p> <p>N° CC : 050 /HIANF/2023 Homologué par l'ANF</p>	
Brazil		<p>Este equipamento não tem direito à proteção contra interferência prejudicial e não pode causar interferência em sistemas devidamente autorizados.</p>

Region	Labels and symbols	Specification
Canada		<p>This device contains licence-exempt transmitter(s)/receiver(s) that comply with Innovation, Science and Economic Development Canada's licence-exempt RSS(s). Operation is subject to the following two conditions:</p> <p>(1) This device may not cause interference.</p> <p>(2) This device must accept any interference, including interference that may cause undesired operation of the device.</p> <p>L'émetteur/récepteur exempt de licence contenu dans le présent appareil est conforme aux CNR d'Innovation, Sciences et Développement économique Canada applicables aux appareils radio exempts de licence. L'exploitation est autorisée aux deux conditions suivantes :</p> <p>1) L'appareil ne doit pas produire de brouillage;</p> <p>2) L'appareil doit accepter tout brouillage radioélectrique subi, même si le brouillage est susceptible d'en compromettre le fonctionnement.</p>



Region	Labels and symbols	Specification
		<p>Tehniline informatsioon: Sagedusriba: 76 ... 77 GHz Edastusvõimsus: 20 dBm (keskmise) EIRP Tootja ja aadress: HELLA GmbH & Co. KGaA Rixbecker Straße 75, 59552 Lippstadt, Saksamaa</p> <p>Greek Με την παρούσα ο/η HELLA GmbH & Co. KGaA, δηλώνει ότι ο ραδιοεξοπλισμός RS5.3 πληροί την οδηγία 2014/53/ΕΕ. Το πλήρες κείμενο της δήλωσης συμμόρφωσης ΕΕ διατίθεται στην ακόλουθη ιστοσελίδα στο διαδίκτυο: www.hella.com/vcc Τεχνικές πληροφορίες: Ζώνη συχνότητας: 76 ... 77 GHz Ισχύς μετάδοσης: 20 dBm (μέση) EIRP Κατασκευαστής και Διεύθυνση: HELLA GmbH & Co KGaA Rixbecker Straße 75, 59552 Lippstadt, Γερμανία</p> <p>French Le soussigné, HELLA GmbH & Co. KGaA, déclare que l'équipement radioélectrique du type RS5.3 est conforme à la directive 2014/53/UE. Le texte complet de la déclaration UE de conformité est disponible à l'adresse internet suivante: www.hella.com/vcc Informations techniques: Bande de fréquence : 76 ... 77 GHz Puissance d'émission : 20 dBm (moyenne) EIRP Fabricant et adresse : HELLA GmbH & Co. KGaA Rixbecker Straße 75, 59552 Lippstadt, Allemagne</p> <p>Gaelic Leis seo, dearbhaíonn Hella GmbH & Co. KGaA go gcomhlíonann an cineál trealaimh raidió RS5.3 Treoir 2014/53 / AE. Tá téacs iomlán dhearbú comhréireachta an AE ar fáil ag an seoladh idirlín seo a leanas: www.hella.com/vcc Gwybodaeth dechnegol: Band amledd: 76 ... 77 GHz Pŵer trosglwyddo: 20 dBm (cyfartaledd) EIRP Gwneuthurwr a Chyfeiriad: HELLA GmbH & Co. KGaA Rixbecker Straße 75, 59552 Lippstadt, yr Almaen</p> <p>Croatian HELLA GmbH & Co. KGaA ovime izjavljuje da je radijska oprema tipa RS5.3 u skladu s Direktivom 2014/53/EU. Cjeloviti tekst EU izjave o sukladnosti dostupan je na sljedećoj internetskoj adresi: www.hella.com/vcc Tehničke informacije: Frekvencijski pojas: 76 ... 77 GHz Snaga prijena: 20 dBm (prosječno) EIRP Proizvođač i adresa: HELLA GmbH & Co. KGaA Rixbecker Straße 75, 59552 Lippstadt, Njemačka</p> <p>Italian Il fabbricante, HELLA GmbH & Co. KGaA, dichiara che il tipo di apparecchiatura radio RS5.3 è conforme alla direttiva 2014/53/UE. Il testo completo della dichiarazione di conformità UE è disponibile al seguente indirizzo Internet: www.hella.com/vcc Informazioni tecniche: Banda di frequenza: 76 ... 77 GHz Potenza di trasmissione: 20 dBm (media) EIRP Produttore e indirizzo: HELLA GmbH & Co. KGaA Rixbecker Straße 75, 59552 Lippstadt, Germania</p> <p>Latvian Ar šo HELLA GmbH & Co. KGaA deklarē, ka radioiekārta RS5.3 atbilst Direktīvai 2014/53/ES. Pilns ES atbilstības deklarācijas teksts ir pieejams šādā interneta vietnē: www.hella.com/vcc Tehniskā informācija: Frekvenču josla: 76 ... 77 GHz Raidīšanas jauda: 20 dBm (vidēji) EIRP Ražotājs un adrese: HELLA GmbH & Co. KGaA Rixbecker Straße 75, 59552 Lippstadt, Vācija</p> <p>Lithuanian Aš, HELLA GmbH & Co. KGaA, patvirtinu, kad radijo įrenginių tipas RS5.3 atitinka Direktyvą 2014/53/ES. Visas ES atitikties deklaracijos tekstas prieinamas šiuo interneto adresu: www.hella.com/vcc Technine informacija: Dažnių juosta: 76 ... 77 GHz Perdavimo galia: 20 dBm (vidutinis) EIRP Gamintojas ir adresas: HELLA GmbH & Co. KGaA Rixbecker Straße 75, 59552 Lippstadt, Vokietija</p> <p>Hungarian HELLA GmbH & Co. KGaA igazolja, hogy a RS5.3 típusú rádióberendezés megfelel a 2014/53/EU irányelvnek. Az EU-megfelelőségi nyilatkozat teljes szövege elérhető a következő internetes címen: www.hella.com/vcc Technikai információ: Frekvenciasáv: 76 ... 77 GHz Átviteli teljesítmény: 20 dBm (átlag) EIRP Gyártó és cím: HELLA GmbH & Co. KGaA Rixbecker Straße 75, 59552 Lippstadt, Németország</p> <p>Maltese B'dan, HELLA GmbH & Co. KGaA, niddikjara li dan it-tip ta' tagħmir tar-radju RS5.3 huwa konformi mad-Direttiva 2014/53/UE. It-test kollu tad-dikjarazzjoni ta' konformità tal-UE huwa disponibbli f'dan l-indirizz tal-Internet li ġej: www.hella.com/vcc Informazzjoni teknika: Faxxa tal-frekwenza: 76 ... 77 GHz</p>

Region	Labels and symbols	Specification
		<p>Qawwa tat-trażmissjoni: 20 dBm (medja) EIRP Manifattur u Indirizz: HELLA GmbH & Co KGaA Rixbecker Straße 75, 59552 Lippstadt, il-Ġermanja</p> <p>Dutch Hierbij verklaar ik, HELLA GmbH & Co. KGaA, dat het type radioapparatuur RS5.3 conform is met Richtlijn 2014/53/EU. De volledige tekst van de EU-conformiteitsverklaring kan worden geraadpleegd op het volgende internetadres: www.hella.com/vcc Technische informatie: Frequentieband: 76 ... 77 GHz Zendvermogen: 20 dBm (gemiddeld) EIRP Fabrikant en adres: HELLA GmbH & Co. KGaA Rixbecker Straße 75, 59552 Lippstadt, Duitsland</p> <p>Polish HELLA GmbH & Co. KGaA niniejszym oświadcza, że typ urządzenia radiowego RS5.3 jest zgodny z dyrektywą 2014/53/UE. Pełny tekst deklaracji zgodności UE jest dostępny pod następującym adresem internetowym: www.hella.com/vcc Specyfikacja: Pasma częstotliwości: 76...77 GHz Moc transmisji: 20 dBm (średnia) EIRP Producent i adres: HELLA GmbH & Co. KGaA Rixbecker Straße 75, 59552 Lippstadt, Niemcy</p> <p>Portuguese O(a) abaixo assinado(a) HELLA GmbH & Co. KGaA declara que o presente tipo de equipamento de rádio RS5.3 está em conformidade com a Diretiva 2014/53/UE. O texto integral da declaração de conformidade está disponível no seguinte endereço de Internet: www.hella.com/vcc Informação técnica: Banda de frequência: 76 ... 77 GHz Potência de transmissão: 20 dBm (média) EIRP Fabricante e Endereço: HELLA GmbH & Co. KGaA Rixbecker Straße 75, 59552 Lippstadt, Alemanha</p> <p>Romanian Prin prezenta, HELLA GmbH & Co. KGaA declară că tipul de echipamente radio RS5.3 este în conformitate cu Directiva 2014/53/UE. Textul integral al declarației UE de conformitate este disponibil la următoarea adresă de internet: www.hella.com/vcc Informații tehnice: Banda de frecvență: 76 ... 77 GHz Puterea de transmisie: 20 dBm (medie) EIRP Producător și adresa: HELLA GmbH & Co. KGaA Rixbecker Straße 75, 59552 Lippstadt, Germania</p> <p>Slovak HELLA GmbH & Co. KGaA týmto vyhlasuje, že rádiové zariadenie typu RS5.3 je v súlade so smernicou 2014/53/EÚ. Úplné EÚ vyhlásenie o zhode je k dispozícii na tejto internetovej adrese: www.hella.com/vcc Technická informácia: Frekvenčné pásmo: 76 ... 77 GHz Vysielací výkon: 20 dBm (priemer) EIRP Výrobca a adresa: HELLA GmbH & Co. KGaA Rixbecker Straße 75, 59552 Lippstadt, Nemecko</p> <p>Slovenian HELLA GmbH & Co. KGaA potrjuje, da je tip radijske opreme RS5.3 skladen z Direktivo 2014/53/EU. Celotno besedilo izjave EU o skladnosti je na voljo na naslednjem spletnem naslovu: www.hella.com/vcc Tehnične informacije: Frekvenčni pas: 76 ... 77 GHz Oddajna moč: 20 dBm (povprečje) EIRP Proizvajalec in naslov: HELLA GmbH & Co. KGaA Rixbecker Straße 75, 59552 Lippstadt, Nemčija</p> <p>Finnish HELLA GmbH & Co. KGaA vakuuttaa, että radiolaitetyypin RS5.3 on direktiivin 2014/53/EU mukainen. EU-vaatimustenmukaisuusvakuutuksen täysimittainen teksti on saatavilla seuraavassa internetosoitteessa: www.hella.com/vcc Tekninen informaatio: Taajuuskaista: 76 ... 77 GHz Lähetysteho: 20 dBm (keskimääräinen) EIRP Valmistaja ja osoite: HELLA GmbH & Co. KGaA Rixbecker Straße 75, 59552 Lippstadt, Saksa</p> <p>Swedish Härmed förklarar HELLA GmbH & Co. KGaA att radioutrustningen av typen RS5.3 överensstämmer med direktiv 2014/53/EU. Den fullständiga texten till EU-försäkran om överensstämmelse finns tillgänglig på följande internetadress: www.hella.com/vcc Teknisk information: Frekvensband: 76 ... 77 GHz Sändningseffekt: 20 dBm (medel) EIRP Tillverkare och adress: HELLA GmbH & Co. KGaA Rixbecker Straße 75, 59552 Lippstadt, Tyskland</p> <p>Turkish HELLA GmbH & Co. KGaA, işbu belgeyle RS5.3 tipi radyo ekipmanının 2014/53/AB sayılı direktife uygun olduğunu beyan eder.</p>

Region	Labels and symbols	Specification
		<p>AB uygunluk beyanının tam metni, aşağıdaki internet adresinde mevcuttur: www.hella.com/vcc</p> <p>Teknik Bilgiler: Frekans bandı: 76 ... 77 GHz İletim gücü: 20 dBm (ortalama) EIRP Üretici ve Adres: HELLA GmbH & Co. KGaA Rixbecker Straße 75, 59552 Lippstadt, Almanya</p> <p>Icelandic Hér með lýsir HELLA GmbH & Co. KGaA því yfir að útlarpsbúnaður af gerðinni RS5.3 sé í samræmi við tilskipun 2014/53/ESB. Heildartexti ESB-samræmisýfirlýsingarinnar er fáanlegur á eftirfarandi netfangi: www.hella.com/vcc Tæknilegar upplýsingar: Tíðnisvið: 76 ... 77 GHz Sendingarkraftur: 20 dBm (meðaltal) EIRP Framleiðandi og heimilisfang: Hella GmbH & Co. KGaA Rixbecker Straße 75, 59552 Lippstadt, Þýskaland</p> <p>Norwegian HELLA GmbH & Co. KGaA erklærer herved at radioutstyret av typen RS5.3 samsvarer med direktiv 2014/53/EU. Den fullstendige teksten til EU-samsvarserklæringen er tilgjengelig på følgende internetadresse: www.hella.com/vcc Teknisk informasjon: Frekvensbånd: 76 ... 77 GHz Overføringsytelse: 20 dBm (gjennomsnittlig) EIRP Produsent og adresse: Hella GmbH & Co. KGaA Rixbecker Straße 75, 59552 Lippstadt, Tyskland</p> <p>Serbian Ovim putem HELLA GmbH & Co. KGaA izjavљуje da je radio-oprema tipa RS5.3 usklađena sa Uredbom 2014/53/EU. Kompletan tekst EU Deklaracije o usaglašenosti dostupan je na sledećoj internet adresi: www.hella.com/vcc Tehničke informacije: Frekvencijski opseg: 76 ... 77 GHz Snaga prenosa: 20 dBm (prosečno) EIRP Proizvođač i adresa: HELLA GmbH & Co. KGaA Rixbecker Straße 75, 59552 Lippstadt, Nemačka</p> <p>Albanian Me anë të kësaj, Hella GmbH & Co. KGaA deklaron se pajisjet e radios tip RS5.3 janë në përputhje me Direktivën 2014/53 / EU. Teksti i plotë i deklaratës së konformitetit të BE është në dispozicion në adresën e mëposhtme të internetit: www.hella.com/vcc Informacion teknik: Fasha e frekuencës: 76 ... 77 GHz Fuqia e transmetimit: 20 dBm (mesatare) EIRP Prodhuesi dhe Adresa: Hella GmbH & Co. KGaA Rixbecker Straße 75, 59552 Lippstadt, Gjermani</p> <p>Bosnian Ovime kompanija Hella GmbH & Co. KGaA izjavљуje da je radijska oprema tipa RS5.3 u skladu s Direktivom 2014/53/EU. Puni tekst EU Izjave o sukladnosti dostupan je na sljedećoj internet adresi: www.hella.com/vcc Tehničke informacije: Raspon frekvencije: 76 ... 77 GHz Snaga prijena: 20 dBm (prosječno) EIRP (efektivna izotropna snaga zračenja) Proizvođač i adresa: Hella GmbH & Co. KGaA Rixbecker Straße 75, 59552 Lippstadt, Njemačka</p> <p>Macedonian Со ова Hella GmbH & Co. KGaA декларира дека радиоопремата од тип RS5.3 е во согласност со Директивата 2014/53/EU. Целосниот текст на декларацијата за сообразност на ЕУ е достапна на следната интернет-адреса: www.hella.com/vcc Технички информации: Појас на фреквенција: 76 ... 77 GHz Моќност на трансмисија: 20 dBm (просечна) EIRP Производител и адреса: Hella GmbH & Co. KGaA Rixbecker Straße 75, 59552 Lippstadt, Германија</p>
Ghana		NCA Approved: 7E5-7M-156-RDR

Region	Labels and symbols	Specification
United States of America		This device complies with Part 95M of the FCC Rules. Operation is subject to the following two conditions: (1) this device may not cause harmful interference, and (2) this device must accept any interference received, including interference that may cause undesired operation. CAUTION TO USERS Changes or modifications not expressly approved by the party responsible for compliance could void the user's authority to operate the equipment.
Vietnam		
Zambia		

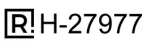
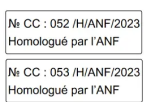

Rear corner radars

Region	Labels and symbols	Specification
Argentina		
Algeria		
Australia		
Brazil		Este equipamento não tem direito à proteção contra interferência prejudicial e não pode causar interferência em sistemas devidamente autorizados.
Canada		This device contains licence-exempt transmitter(s)/receiver(s) that comply with Innovation, Science and Economic Development Canada's licence-exempt RSS(s). Operation is subject to the following two conditions: (1) This device may not cause interference. (2) This device must accept any interference, including interference that may cause undesired operation of the device. L'émetteur/récepteur exempt de licence contenu dans le présent appareil est conforme aux CNR d'Innovation, Sciences et Développement économique Canada applicables aux appareils radio exempts de licence. L'exploitation est autorisée aux deux conditions suivantes : 1) L'appareil ne doit pas produire de brouillage; 2) L'appareil doit accepter tout brouillage radioélectrique subi, même si le brouillage est susceptible d'en compromettre le fonctionnement.

Region	Labels and symbols	Specification
		<p>Tehniline informatsioon: Sagedusriba: 76 ... 77 GHz Edastusvõimsus: 23 dBm (keskmise) EIRP Tootja ja aadress: HELLA GmbH & Co. KGaA Rixbecker Straße 75, 59552 Lippstadt, Saksamaa</p> <p>Greek Με την παρούσα ο/η HELLA GmbH & Co. KGaA, δηλώνει ότι ο ραδιοεξοπλισμός RS5.5 πληροί την οδηγία 2014/53/ΕΕ. Το πλήρες κείμενο της δήλωσης συμμόρφωσης ΕΕ διατίθεται στην ακόλουθη ιστοσελίδα στο διαδίκτυο: www.hella.com/vcc Τεχνικές πληροφορίες: Ζώνη συχνότητας: 76 ... 77 GHz Ισχύς μετάδοσης: 23 dBm (μέση) EIRP Κατασκευαστής και Διεύθυνση: HELLA GmbH & Co KGaA Rixbecker Straße 75, 59552 Lippstadt, Γερμανία</p> <p>French Le soussigné, HELLA GmbH & Co. KGaA, déclare que l'équipement radioélectrique du type RS5.5 est conforme à la directive 2014/53/UE. Le texte complet de la déclaration UE de conformité est disponible à l'adresse internet suivante: www.hella.com/vcc Informations techniques: Bande de fréquence : 76 ... 77 GHz Puissance d'émission : 23 dBm (moyenne) EIRP Fabricant et adresse : HELLA GmbH & Co. KGaA Rixbecker Straße 75, 59552 Lippstadt, Allemagne</p> <p>Gaelic Leis seo, dearbhaíonn Hella GmbH & Co. KGaA go gcomhlíonann an cineál trealaimh raidió RS5.5 Treoir 2014/53 / AE. Tá téacs iomlán dhearbú comhréireachta an AE ar fáil ag an seoladh idirlín seo a leanas: www.hella.com/vcc Gwybodaeth dechnegol: Band amledd: 76 ... 77 GHz Pŵer trosglwyddo: 23 dBm (cyfartaledd) EIRP Gwneuthurwr a Chyfeiriad: HELLA GmbH & Co. KGaA Rixbecker Straße 75, 59552 Lippstadt, yr Almaen</p> <p>Croatian HELLA GmbH & Co. KGaA ovime izjavljuje da je radijska oprema tipa RS5.5 u skladu s Direktivom 2014/53/EU. Cjeloviti tekst EU izjave o sukladnosti dostupan je na sljedećoj internetskoj adresi: www.hella.com/vcc Tehničke informacije: Frekvencijski pojas: 76 ... 77 GHz Snaga prijenosa: 23 dBm (prosječno) EIRP Proizvođač i adresa: HELLA GmbH & Co. KGaA Rixbecker Straße 75, 59552 Lippstadt, Njemačka</p> <p>Italian Il fabbricante, HELLA GmbH & Co. KGaA, dichiara che il tipo di apparecchiatura radio RS5.5 è conforme alla direttiva 2014/53/UE. Il testo completo della dichiarazione di conformità UE è disponibile al seguente indirizzo Internet: www.hella.com/vcc Informazioni tecniche: Banda di frequenza: 76 ... 77 GHz Potenza di trasmissione: 23 dBm (media) EIRP Produttore e indirizzo: HELLA GmbH & Co. KGaA Rixbecker Straße 75, 59552 Lippstadt, Germania</p> <p>Latvian Ar šo HELLA GmbH & Co. KGaA deklarē, ka radioiekārta RS5.5 atbilst Direktīvai 2014/53/ES Pilns ES atbilstības deklarācijas teksts ir pieejams šādā interneta vietnē: www.hella.com/vcc Tehniskā informācija: Frekvenču josla: 76 ... 77 GHz Raidīšanas jauda: 23 dBm (vidēji) EIRP Ražotājs un adrese: HELLA GmbH & Co. KGaA Rixbecker Straße 75, 59552 Lippstadt, Vācija</p> <p>Lithuanian Aš, HELLA GmbH & Co. KGaA, patvirtinu, kad radijo įrenginių tipas RS5.5 atitinka Direktyvą 2014/53/ES. Visas ES atitikties deklaracijos tekstas prieinamas šiuo interneto adresu: www.hella.com/vcc Technine informacija: Dažnių juosta: 76 ... 77 GHz Perdavimo galia: 23 dBm (vidutinis) EIRP Gamintojas ir adresas: HELLA GmbH & Co. KGaA Rixbecker Straße 75, 59552 Lippstadt, Vokietija</p> <p>Hungarian HELLA GmbH & Co. KGaA igazolja, hogy a RS5.5 típusú rádióberendezés megfelel a 2014/53/EU irányelvnek. Az EU-megfelelőségi nyilatkozat teljes szövege elérhető a következő internetes címen: www.hella.com/vcc Technikai információ: Frekvenciasáv: 76 ... 77 GHz Átviteli teljesítmény: 23 dBm (átlag) EIRP Gyártó és cím: HELLA GmbH & Co. KGaA Rixbecker Straße 75, 59552 Lippstadt, Németország</p> <p>Maltese B'dan, HELLA GmbH & Co. KGaA, niddikjara li dan it-tip ta' tagħmir tar-radju RS5.5 huwa konformi mad-Direttiva 2014/53/UE. It-test kollu tad-dikjarazzjoni ta' konformità tal-UE huwa disponibbli f'dan l-indirizz tal-Internet li ġej: www.hella.com/vcc Informazzjoni teknika: Faxxa tal-frekwenza: 76 ... 77 GHz</p>





Region	Labels and symbols	Specification
		<p>Qawwa tat-trażmissjoni: 23 dBm (medja) EIRP Manifattur u Indirizz: HELLA GmbH & Co KGaA Rixbecker Straße 75, 59552 Lippstadt, il-Ġermanja</p> <p>Dutch Hierbij verklaar ik, HELLA GmbH & Co. KGaA, dat het type radioapparatuur RS5.5 conform is met Richtlijn 2014/53/EU. De volledige tekst van de EU-conformiteitsverklaring kan worden geraadpleegd op het volgende internetadres: www.hella.com/vcc Technische informatie: Frequentieband: 76 ... 77 GHz Zendvermogen: 23 dBm (gemiddeld) EIRP Fabrikant en adres: HELLA GmbH & Co. KGaA Rixbecker Straße 75, 59552 Lippstadt, Duitsland</p> <p>Polish HELLA GmbH & Co. KGaA niniejszym oświadcza, że typ urządzenia radiowego RS5.5 jest zgodny z dyrektywą 2014/53/UE. Pełny tekst deklaracji zgodności UE jest dostępny pod następującym adresem internetowym: www.hella.com/vcc Specyfikacja: Pasma częstotliwości: 76...77 GHz Moc transmisji: 23 dBm (średnia) EIRP Producent i adres: HELLA GmbH & Co. KGaA Rixbecker Straße 75, 59552 Lippstadt, Niemcy</p> <p>Portuguese O(a) abaixo assinado(a) HELLA GmbH & Co. KGaA declara que o presente tipo de equipamento de rádio RS5.5 está em conformidade com a Diretiva 2014/53/UE. O texto integral da declaração de conformidade está disponível no seguinte endereço de Internet: www.hella.com/vcc Informação técnica: Banda de frequência: 76 ... 77 GHz Potência de transmissão: 23 dBm (média) EIRP Fabricante e Endereço: HELLA GmbH & Co. KGaA Rixbecker Straße 75, 59552 Lippstadt, Alemanha</p> <p>Romanian Prin prezenta, HELLA GmbH & Co. KGaA declară că tipul de echipamente radio RS5.5 este în conformitate cu Directiva 2014/53/UE. Textul integral al declarației UE de conformitate este disponibil la următoarea adresă de internet: www.hella.com/vcc Informații tehnice: Banda de frecvență: 76 ... 77 GHz Puterea de transmisie: 23 dBm (medie) EIRP Producător și adresa: HELLA GmbH & Co. KGaA Rixbecker Straße 75, 59552 Lippstadt, Germania</p> <p>Slovak HELLA GmbH & Co. KGaA týmto vyhlasuje, že rádiové zariadenie typu RS5.5 je v súlade so smernicou 2014/53/EÚ. Úplné EÚ vyhlásenie o zhode je k dispozícii na tejto internetovej adrese: www.hella.com/vcc Technická informácia: Frekvenčné pásmo: 76 ... 77 GHz Vysielací výkon: 23 dBm (priemer) EIRP Výrobca a adresa: HELLA GmbH & Co. KGaA Rixbecker Straße 75, 59552 Lippstadt, Nemecko</p> <p>Slovenian HELLA GmbH & Co. KGaA potrjuje, da je tip radijske opreme RS5.5 skladen z Direktivo 2014/53/EU. Celotno besedilo izjave EU o skladnosti je na voljo na naslednjem spletnem naslovu: www.hella.com/vcc Tehnične informacije: Frekvenčni pas: 76 ... 77 GHz Oddajna moč: 23 dBm (povprečje) EIRP Proizvajalec in naslov: HELLA GmbH & Co. KGaA Rixbecker Straße 75, 59552 Lippstadt, Nemčija</p> <p>Finnish HELLA GmbH & Co. KGaA vakuuttaa, että radiolaitetyypin RS5.5 on direktiivin 2014/53/EU mukainen. EU-vaatimustenmukaisuusvakuutuksen täysimittainen teksti on saatavilla seuraavassa internetosoitteessa: www.hella.com/vcc Tekninen informaatio: Taajuuskaista: 76 ... 77 GHz Lähetysteho: 23 dBm (keskimääräinen) EIRP Valmistaja ja osoite: HELLA GmbH & Co. KGaA Rixbecker Straße 75, 59552 Lippstadt, Saksa</p> <p>Swedish Härmed förklarar HELLA GmbH & Co. KGaA att radioutrustningen av typen RS5.5 överensstämmer med direktiv 2014/53/EU. Den fullständiga texten till EU-försäkran om överensstämmelse finns tillgänglig på följande internetadress: www.hella.com/vcc Teknisk information: Frekvensband: 76 ... 77 GHz Sändningseffekt: 23 dBm (medel) EIRP Tillverkare och adress: HELLA GmbH & Co. KGaA Rixbecker Straße 75, 59552 Lippstadt, Tyskland</p> <p>Turkish HELLA GmbH & Co. KGaA, işbu belgeyle RS5.5 tipi radyo ekipmanının 2014/53/AB sayılı direktife uygun olduğunu beyan eder.</p>

Region	Labels and symbols	Specification
		<p>AB uygunluk beyanının tam metni, aşağıdaki internet adresinde mevcuttur: www.hella.com/vcc</p> <p>Teknik Bilgiler: Frekans bandı: 76 ... 77 GHz İletim gücü: 23 dBm (ortalama) EIRP Üretici ve Adres: HELLA GmbH & Co. KGaA Rixbecker Straße 75, 59552 Lippstadt, Almanya</p> <p>Icelandic Hér með lýsir HELLA GmbH & Co. KGaA því yfir að útlarpsbúnaður af gerðinni RS5.5 sé í samræmi við tilskipun 2014/53/ESB. Heildartexti ESB-samræmisýfirlýsingarinnar er fáanlegur á eftirfarandi netfangi: www.hella.com/vcc Tæknilegar upplýsingar: Tíðnisvið: 76 ... 77 GHz Sendingarkraftur: 23 dBm (meðaltal) EIRP Framleiðandi og heimilisfang: Hella GmbH & Co. KGaA Rixbecker Straße 75, 59552 Lippstadt, Þýskaland</p> <p>Norwegian HELLA GmbH & Co. KGaA erklærer herved at radioutstyret av typen RS5.5 samsvarer med direktiv 2014/53/EU. Den fullstendige teksten til EU-samsvarserklæringen er tilgjengelig på følgende internetadresse: www.hella.com/vcc Teknisk informasjon: Frekvensbånd: 76 ... 77 GHz Overføringsytelse: 23 dBm (gjennomsnittlig) EIRP Produsent og adresse: Hella GmbH & Co. KGaA Rixbecker Straße 75, 59552 Lippstadt, Tyskland</p> <p>Serbian Ovim putem HELLA GmbH & Co. KGaA izjavљуje da je radio-oprema tipa RS5.5 usklađena sa Uredbom 2014/53/EU. Kompletan tekst EU Deklaracije o usaglašenosti dostupan je na sledećoj internet adresi: www.hella.com/vcc Tehničke informacije: Frekvencijski opseg: 76 ... 77 GHz Snaga prenosa: 23 dBm (prosečno) EIRP Proizvođač i adresa: HELLA GmbH & Co. KGaA Rixbecker Straße 75, 59552 Lippstadt, Nemačka</p> <p>Albanian Me anë të kësaj, Hella GmbH & Co. KGaA deklaron se pajisjet e radios tip RS5.5 janë në përputhje me Direktivën 2014/53 / EU. Teksti i plotë i deklaratës së konformitetit të BE është në dispozicion në adresën e mëposhtme të internetit: www.hella.com/vcc Informacion teknik: Fasha e frekuencës: 76 ... 77 GHz Fuqia e transmetimit: 23 dBm (mesatare) EIRP Prodhuesi dhe Adresa: Hella GmbH & Co. KGaA Rixbecker Straße 75, 59552 Lippstadt, Gjermani</p> <p>Bosnian Ovime kompanija Hella GmbH & Co. KGaA izjavљуje da je radijska oprema tipa RS5.5 u skladu s Direktivom 2014/53/EU. Puni tekst EU Izjave o sukladnosti dostupan je na sljedećoj internet adresi: www.hella.com/vcc Tehničke informacije: Raspon frekvencije: 76 ... 77 GHz Snaga prijensa: 23 dBm (prosječno) EIRP (efektivna izotropska snaga zračenja) Proizvođač i adresa: Hella GmbH & Co. KGaA Rixbecker Straße 75, 59552 Lippstadt, Njemačka</p> <p>Macedonian Со ова Hella GmbH & Co. KGaA декларира дека радиоопремата од тип RS5.5 е во согласност со Директивата 2014/53/EU. Целосниот текст на декларацијата за сообразност на ЕУ е достапна на следната интернет-адреса: www.hella.com/vcc Технички информации: Појас на фреквенција: 76 ... 77 GHz Моќност на трансмисија: 23 dBm (просечна) EIRP Производител и адреса: Hella GmbH & Co. KGaA Rixbecker Straße 75, 59552 Lippstadt, Германија</p>
Ghana		NCA Approved: 7E5-7M-151-RDR

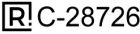





Region	Labels and symbols	Specification
United States of America		This device complies with Part 95M of the FCC Rules. Operation is subject to the following two conditions: (1) this device may not cause harmful interference, and (2) this device must accept any interference received, including interference that may cause undesired operation. CAUTION TO USERS Changes or modifications not expressly approved by the party responsible for compliance could void the user's authority to operate the equipment.
Vietnam		
Zambia		



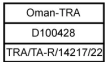
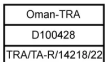
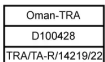
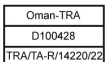

Radars for detecting foot movement below the rear bumper

Region	Labels and symbols	Specification
Argentina		C-28726
Canada/ FCC (US)		<p>Contains FCC ID: 2AQ6KA1003</p> <p>FCC Part15 and ISSED(IC) This device complies with part 15 of FCC Rules and Innovation, Science and Economic Development Canada's licence-exempt RSS(s). Operation is subject to the following two conditions: (1) this device may not cause harmful interference, and (2) this device must accept any interference received, including interference that may cause undesired operation.</p> <p>FCC Part15 FCC CAUTION Changes or modifications not expressly approved by the party responsible for compliance could void the user's authority to operate the equipment.</p> <p>FCC Part15 This transmitter must not be co-located or operated in conjunction with any other antenna or transmitter.</p> <p>SAR(Specific Absorption Rate) This equipment complies with radio frequency exposure limits set forth by the FCC and Industry Canada for an uncontrolled environment. This equipment should be installed and operated with a minimum distance of 20 cm between the device and the user or bystanders. This device must not be co-located or operating in conjunction with any other antenna or transmitter.</p> <p>Le présent appareil est conforme à la partie 15 des règles de la FCC et aux normes des CNR d'Innovation, Sciences et Développement économique Canada applicables aux appareils radio exempts de licence. L'exploitation est autorisée aux deux conditions suivantes: (1) l'appareil ne doit pas produire de brouillage, et (2) l'appareil doit accepter tout brouillage subi, même si le brouillage est susceptible d'en compromettre le fonctionnement.</p> <p>Cet équipement est conforme aux limites d'exposition aux radiofréquences définies par la FCC et Industrie Canada pour un environnement non contrôlé. Cet équipement doit être installé et utilisé avec un minimum de 20 cm de distance entre le dispositif et l'utilisateur ou des tiers. Ce dispositif ne doit pas être utilisé à proximité d'une autre antenne ou d'un autre émetteur.</p>
CE		<p>Manufacturer's name & Manufacturer's registered trade name or registered trade mark: ALPS ALPINE CO., LTD.</p> <p>Manufacturer's postal address:6-3-36, Nakazato, Furukawa, Osaki-city, Miyagi-pref., JAPAN 989-6181.</p> <p>Specification: frequency band(s) in which the radio equipment operates; 57 - 64GHz maximum radio-frequency power transmitted in the frequency band(s) in which the radio equipment operates; 13dBm e.i.r.p peak (This Value conforms to European standard ETSI EN 305 550 measurement method).</p> <p>Declaration of conformity: UK SIMPLIFIED EU DECLARATION OF CONFORMITY. Hereby, ALPS ALPINE CO., LTD. declares that the radio equipment type B2101 is in compliance with the relevant statutory requirements. The full text of the UK declaration of conformity is available at the following internet address: https://www.alpsalpine.com/common/pdf/Kick_Sensor/B2101.pdf</p>
China		<p>20mW(e.i.r.p) 24-24.5GHz H 20mW(e.i.r.p) ECM ISM 5000 16</p>

Region	Labels and symbols	Specification
Albania, Andorra, Austria, Belgium, Bolivia, Bosnia and Herzegovina, Bulgaria, Canary Islands, Croatia, Cyprus, Czech Republic, Denmark, Egypt, Estonia, Finland, France, Georgia, Germany, Greece, Grenada, Honduras, Hungary, Iceland, Ireland, Italy, Latvia, Libya, Liechtenstein, Lithuania, Luxembourg, Macedonia, Malta, Mauritius, Monaco, Montenegro, Netherlands, Norway, Poland, Portugal, Romania, San Marino, Slovakia, Slovenia, Spain, Sweden, Switzerland, Turkey, Zimbabwe		<p>frequency band(s) in which the radio equipment operates; 57 - 64GHz maximum radio-frequency power transmitted in the frequency band(s) in which the radio equipment operates; 13dBm e.i.r.p peak (This Value conforms to European standard ETSI EN 305 550 measurement method)</p> <p>Simplified EU declaration of conformity</p> <p>OHC2101 Hereby, ALPS ALPINE CO., LTD. declares that the radio equipment type OHC2101 is in compliance with Directive 2014/53/EU. The full text of the EU declaration of conformity is available at the following internet address: https://www.alpsalpine.com/common/pdf/Interior_Sensor/OHC2101.pdf</p> <p>OHLC2101 Hereby, ALPS ALPINE CO., LTD. declares that the radio equipment type OHLC2101 is in compliance with Directive 2014/53/EU. The full text of the EU declaration of conformity is available at the following internet address: https://www.alpsalpine.com/common/pdf/Interior_Sensor/OHLC2101.pdf</p> <p>OHRL2101 Hereby, ALPS ALPINE CO., LTD. declares that the radio equipment type OHRL2101 is in compliance with Directive 2014/53/EU. The full text of the EU declaration of conformity is available at the following internet address: https://www.alpsalpine.com/common/pdf/Interior_Sensor/OHRL2101.pdf</p> <p>OHR2101 Hereby, ALPS ALPINE CO., LTD. declares that the radio equipment type OHR2101 is in compliance with Directive 2014/53/EU. The full text of the EU declaration of conformity is available at the following internet address: https://www.alpsalpine.com/common/pdf/Interior_Sensor/OHR2101.pdf</p>
Argentina	<p> C-28730</p> <p>OHC2101</p> <p> C-28727</p> <p>OHLC2101</p> <p> C-28729</p> <p>OHRL2101</p> <p> C-28728</p> <p>OHR2101</p>	
Brazil		<p>"Este equipamento não tem direito à proteção contra interferência prejudicial e não pode causar interferência em sistemas devidamente autorizados". Para consultas, visite: www.anatel.gov.br</p>
Canada, Guyana, Puerto Rico, United States		<p>Contains FCC ID: 2AQ6KA1003</p> <p>FCC Part15 and ISSED(C) This device complies with part 15 of FCC Rules and Innovation, Science and Economic Development Canada's licence-exempt RSS(s). Operation is subject to the following two conditions: (1) this device may not cause harmful interference, and (2) this device must accept any interference received, including interference that may cause undesired operation.</p> <p>FCC Part15 FCC CAUTION Changes or modifications not expressly approved by the party responsible for compliance could void the user's authority to operate the equipment.</p> <p>FCC Part15 This transmitter must not be co-located or operated in conjunction with any other antenna or transmitter.</p> <p>SAR: Specific Absorption Rate This equipment complies with radio frequency exposure limits set forth by the FCC and Industry Canada for an uncontrolled environment. This equipment should be installed and operated with a minimum distance of 20 cm between the device and the user or bystanders. This device must not be co-located or operating in conjunction with any other antenna or transmitter.</p> <p>Le présent appareil est conforme à la partie 15 des règles de la FCC et aux normes des CNR d'Innovation, Sciences et Développement économique Canada applicables aux appareils radio exempts de licence. L'exploitation est autorisée aux deux conditions suivantes : (1) l'appareil ne doit pas produire de brouillage, et (2) l'appareil doit accepter tout brouillage subi, même si le brouillage est susceptible d'en compromettre le fonctionnement.</p> <p>Cet équipement est conforme aux limites d'exposition aux radiofréquences définies par la FCC et Industrie Canada pour un environnement non contrôlé. Cet équipement doit être installé et utilisé avec un minimum de 20 cm de distance entre le dispositif et l'utilisateur ou des tiers. Ce dispositif ne doit pas être utilisé à proximité d'une autre antenne ou d'un autre émetteur.</p>

Region	Labels and symbols	Specification
Ghana		<p>frequency band(s) in which the radio equipment operates; 57 - 64GHz maximum radio-frequency power transmitted in the frequency band(s) in which the radio equipment operates; 13dBm e.i.r.p peak (This Value conforms to European standard ETSI EN 305 550 measurement method)</p> <p>Certification number</p> <p>OHC2101 NCA APPROVED:7M-7E7-X33-DSR OHLC2101 NCA APPROVED:7M-7E7-X31-DSR OHRL2101 NCA APPROVED:HS-7E7-X2F-DSR OHRR2101 NCA APPROVED:7M-7E7-X2D-DSR</p>
Israel		<p style="text-align: center;"><small>סימולציה – "שירותי תח"ם"</small></p> <p style="text-align: center;"><small>התקנת מערכת התקשורת על ידי ציוד זה אינה מאפשרת לציוד להיות מוגדר כציוד תקשורת. לפרטים נוספים, אנא פנה למוקד הלקוחות של חברת התקשורת.</small></p>
Kazakhstan, Kyrgyzstan		<p>Frequency band ; 57 - 64GHz, Operating Power Supply voltage: 9 V to 16 V</p> <p>OHC2101, OHLC2101, OHRL2101, OHRR2101</p> <p>ООО<<СТАНДА СЕРТ>></p> <p>Место нахождения РА, г. Ереван, Аван, Нарекаци 42/45</p> <p>номер государственной регистрации 282.110.1052305</p> <p>УНН 00918006</p> <p>номер телефона +37493306330</p>
Malaysia	 <p>OHC2101, OHLC2101, OHRL2101, OHRR2101</p>	
Mexico		<p>'IFT:VOALOH22-25083 La operación de este equipo está sujeta a las siguientes dos condiciones: (1) es posible que este equipo o dispositivo no cause interferencia perjudicial y (2) este equipo o dispositivo debe aceptar cualquier interferencia, incluyendo la que pueda causar su operación no deseada.</p>

Region	Labels and symbols	Specification
Moldova		<p>frequency band(s) in which the radio equipment operates; 57 - 64GHz maximum radio-frequency power transmitted in the frequency band(s) in which the radio equipment operates; 13dBm e.i.r.p peak (This Value conforms to European standard ETSI EN 305 550 measurement method)</p> <p>Simplified Moldova declaration of conformity</p> <p>OHC2101 Prin prezenta, ALPS ALPINE CO., LTD. declară că tipul de echipamente radio OHC2101 este în conformitate cu Reglementarea tehnică „Punerea la dispoziție pe piață a echipamentelor radio”. Textul integral al declarației de conformitate este disponibil la următoarea adresă de Internet: https://www.alpsalpine.com/common/pdf/Interior_Sensor/OHC2101.pdf [https://www.alpsalpine.com/common/pdf/Interior_Sensor/OHC2101.pdf]</p> <p>OHLC2101 Prin prezenta, ALPS ALPINE CO., LTD. declară că tipul de echipamente radio OHLC2101 este în conformitate cu Reglementarea tehnică „Punerea la dispoziție pe piață a echipamentelor radio”. Textul integral al declarației de conformitate este disponibil la următoarea adresă de Internet: https://www.alpsalpine.com/common/pdf/Interior_Sensor/OHLC2101.pdf [https://www.alpsalpine.com/common/pdf/Interior_Sensor/OHLC2101.pdf]</p> <p>OHRL2101 Prin prezenta, ALPS ALPINE CO., LTD. declară că tipul de echipamente radio OHRL2101 este în conformitate cu Reglementarea tehnică „Punerea la dispoziție pe piață a echipamentelor radio”. Textul integral al declarației de conformitate este disponibil la următoarea adresă de Internet: https://www.alpsalpine.com/common/pdf/Interior_Sensor/OHRL2101.pdf [https://www.alpsalpine.com/common/pdf/Interior_Sensor/OHRL2101.pdf]</p> <p>OHRR2101 Prin prezenta, ALPS ALPINE CO., LTD. declară că tipul de echipamente radio OHRR2101 este în conformitate cu Reglementarea tehnică „Punerea la dispoziție pe piață a echipamentelor radio”. Textul integral al declarației de conformitate este disponibil la următoarea adresă de Internet: https://www.alpsalpine.com/common/pdf/Interior_Sensor/OHRR2101.pdf [https://www.alpsalpine.com/common/pdf/Interior_Sensor/OHRR2101.pdf]</p>
Oman	 <p>OHC2101</p>  <p>OHLC2101</p>  <p>OHRL2101</p>  <p>OHRR2101</p>	
Paraguay	 <p>OHC2101</p>  <p>OHLC2101</p>  <p>OHRL2101</p>  <p>OHRR2101</p>	
Serbia		

Region	Labels and symbols	Specification
United Kingdom		<p>frequency band(s) in which the radio equipment operates; 57 - 64GHz maximum radio-frequency power transmitted in the frequency band(s) in which the radio equipment operates; 13dBm e.i.r.p peak (This Value conforms to European standard ETSI EN 305 550 measurement method)</p> <p>UK Simplified declaration of conformity</p> <p>OHC2101 Hereby, ALPS ALPINE CO., LTD. declares that the radio equipment type OHC2101 is in compliance with the relevant statutory requirements. The full text of the UK declaration of conformity is available at the following internet address: https://www.alpsalpine.com/common/pdf/Interior_Sensor/OHC2101.pdf [https://www.alpsalpine.com/common/pdf/Interior_Sensor/OHC2101.pdf]</p> <p>OHLC2101 Hereby, ALPS ALPINE CO., LTD. declares that the radio equipment type OHLC2101 is in compliance with the relevant statutory requirements. The full text of the UK declaration of conformity is available at the following internet address: https://www.alpsalpine.com/common/pdf/Interior_Sensor/OHLC2101.pdf [https://www.alpsalpine.com/common/pdf/Interior_Sensor/OHLC2101.pdf]</p> <p>OHRL2101 Hereby, ALPS ALPINE CO., LTD. declares that the radio equipment type OHRL2101 is in compliance with the relevant statutory requirements. The full text of the UK declaration of conformity is available at the following internet address: https://www.alpsalpine.com/common/pdf/Interior_Sensor/OHRL2101.pdf [https://www.alpsalpine.com/common/pdf/Interior_Sensor/OHRL2101.pdf]</p> <p>OHRR2101 Hereby, ALPS ALPINE CO., LTD. declares that the radio equipment type OHRR2101 is in compliance with the relevant statutory requirements. The full text of the UK declaration of conformity is available at the following internet address: https://www.alpsalpine.com/common/pdf/Interior_Sensor/OHRR2101.pdf [https://www.alpsalpine.com/common/pdf/Interior_Sensor/OHRR2101.pdf]</p>
Vietnam	 <p>OHC2101, OHLC2101, OHRL2101, OHRR2101</p>	
Zambia	 <p>OHC2101</p>  <p>OHLC2101</p>  <p>OHRL2101</p>  <p>OHRR2101</p>	

15.5.4. Type approvals for Telematic Connectivity Antenna Module

Find the type approvals for the Telematic Connectivity Antenna Module^[1] listed here.

Manufacturer

Harman Becker Automotive Systems GmbH

Becker-Goering-Strasse 16

The content of this manual represents the status of the user manual at the time of printing and may not be completely valid in future instances. For more information, refer to the first page for the complete disclaimer note.

76307 Karlsbad

Germany

Local importer (UK)

Volvo Car UK Limited

Scandinavia House, Morrey's Drive

Maidenhead SL6 4FL

United Kingdom

Local representative (UK)

Harman International Industries Inc.

26-27 London's St. Vita Basingstoke RG21 7PG

United Kingdom

European Union: Declaration of Conformity ^[2]

Frequency band(s) in which the radio equipment operates:

RF Interface	Transmission Frequency Bands (MHz)	Reception Frequency Bands (MHz)
GSM900	880-915	925-960
GSM1800	1710-1785	1805-1880
WCDMA band I	1920-1980	2110-2170
WCDMA band III	1710-1785	1805-1880
WCDMA band VIII	880-915	925-960
LTE FDD band 1	1920-1980	2110-2170
LTE FDD band 3	1710-1785	1805-1880
LTE FDD band 7	2500-2570	2620-2690
LTE FDD band 8	880-915	925-960
LTE FDD band 20	832-862	791-821
LTE FDD band 28	703-748	758-803
LTE FDD band 32 (Rx)	-	1452-1496
LTE TDD band 34	2010-2025	2010-2025
LTE TDD band 38	2570-2620	2570-2620
LTE TDD band 40	2300-2400	2300-2400
LTE TDD band 42	3400-3600	3400-3600
5G NR n1	1920-1980	2110-2170
5G NR n3	1710-1785	1805-1880
5G NR n7	2500-2570	2620-2690
5G NR n8	880-915	925-960

RF Interface	Transmission Frequency Bands (MHz)	Reception Frequency Bands (MHz)
5G NR n20	832-862	791-821
5G NR n28	703-748	758-803
5G NR n38	2570-2620	2570-2620
5G NR n41	2496-2690 (restricted to 2570-2620 MHz)	2496-2690 (restricted to 2570-2620 MHz)
5G NR n77	3300-4200 (restricted to 3400-3800MHz)	3300-4200 (restricted to 3400-3800MHz)
5G NR n78	3300-3800 (restricted to 3400-3800MHz)	3300-3800 (restricted to 3400-3800MHz)
Bluetooth	2400-2483.5	2400-2483.5
GNSS (Rx)	-	1559-1610
ISM (Rx)	-	433.05 -434.79

Maximum radio-frequency power transmitted in the frequency band(s) in which the radio equipment operates.

Bluetooth LE RF Transmitter Output Power: <5 dBm

NAD Module RF Transmitter Output Power:

GSM:

Class 4 (+33 dBm ± 2 dB) for EGSM 900

Class 1 (+30 dBm ± 2 dB) for GSM 1800

Class E2 (+27 dBm ± 3 dB) for GSM 900 8-PSK





Class E2 (+26 dBm + 3/- 4 dB) for GSM 1800 8-PSK

UMTS: Class 3 (+24 dBm + 1/- 3 dB)

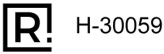

LTE: Class 3 (+23 dBm ± 2 dB)

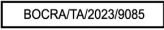
5G: Class 3 (+23 dBm+2/-3 dB) ^[3]



Telematic Connectivity Antenna Module (TCAM2)

Region(s)	Labels	Specifications
Argentina	 H-30059	H-30059
Australia, New Zealand		R-NZ
Botswana		BOCRA/TA/2023/9085
Brazil	 05732-24-07978	05732-24-07978 Este produto está homologado pela ANATEL de acordo com os procedimentos regulamentados para avaliação da conformidade de produtos para telecomunicações e atende aos requisitos técnicos aplicados, incluindo os limites de exposição da Taxa de Absorção Específica referente a campos elétricos, magnéticos e eletromagnéticos de radiofrequência. O máximo valor medido da Taxa de Absorção Específica referente à exposição localizada na cabeça foi de 0,786 W/kg. Para maiores informações, consulte o site da ANATEL – www.anatel.gov.br Products subject to Resolution 680/2017: Este equipamento não tem direito à proteção contra interferência prejudicial e não pode causar interferência em sistemas devidamente autorizados Marcações do Ato 4084 (Act 4084 Marking) Produtos para consumidor final: Para maiores informações, consulte o site da ANATEL – www.anatel.gov.br

Region(s)	Labels	Specifications
Canada		<p>FCC/ISED statements</p> <p>Model: TCAM2 IC: 6434A-TCAM2 Contains IC: 6434A-SAN9200</p> <p>This device complies with part 15 of the FCC Rules and Industry Canada license-exempt RSS standard(s). Operation is subject to the following two conditions:</p> <p>(1) This device may not cause harmful interference, and (2) This device must accept any interference received, including interference that may cause undesired operation.</p> <p>Le présent appareil est conforme aux CNR d'Industrie Canada applicables aux appareils radio exempts de licence. L'exploitation est autorisée aux deux conditions suivantes :</p> <p>(1) l'appareil ne doit pas produire de brouillage, et (2) l'utilisateur de l'appareil doit accepter tout brouillage radioélectrique subi, même si le brouillage est susceptible d'en compromettre le fonctionnement.</p> <p>Modification statement:</p> <p>The party responsible for the compliance has not approved any changes or modifications to this device by the user. Any changes or modifications could void the user's authority to operate the equipment.</p> <p>Le responsable de l'homologation de ce produit n'approuve aucune modification apportée à l'appareil par l'utilisateur, quelle qu'en soit la nature. Tout changement ou modification peuvent annuler le droit d'utilisation de l'appareil par l'utilisateur.</p> <p>Wireless notice:</p> <p>This device complies with FCC/ISED radiation exposure limits set forth for an uncontrolled environment and meets the FCC radio frequency (RF) Exposure Guidelines and RSS-102 of the ISED radio frequency (RF) Exposure rules. This transmitter must not be co-located or operating in conjunction with any other antenna or transmitter. The closer distance between the Cellular internal antennas and the head of the closest passenger will be 86.5 mm and the minimum distance between the BTLE internal antenna and the head of the closest passenger will be 118.0 mm. The device has been tested placed at the centre of the flat phantom with its back side facing the flat phantom surface simulating the normal use conditions at a conservative testing distance of 40 mm according to manufacturer request.</p> <p>Le présent appareil est conforme à l'exposition aux radiations FCC / ISED définies pour un environnement non contrôlé et répond aux directives d'exposition de la fréquence de la FCC radiofréquence (RF) et RSS-102 de la fréquence radio (RF) ISED règles d'exposition. L'émetteur ne doit pas être colocalisé ni fonctionner conjointement avec à autre antenne ou autre émetteur. La distance la plus courte entre les antennes internes cellulaires et la tête du passager le plus proche sera de 86,5 mm et la distance minimale entre l'antenne interne BTLE et la tête du passager le plus proche sera de 118,0 mm. Le dispositif a été testé au centre du fantôme plat, sa face arrière faisant face à la surface du fantôme plat, simulant les conditions d'utilisation normales à une distance d'essai prudente de 40 mm, conformément à la demande du fabricant.</p> <p>Compliance of host devices based on modular approval</p> <p>The module has been evaluated in mobile stand-alone conditions: "The antenna used for this transmitter must be installed to provide a separation distance of at least 20 cm from all persons and must not be co-located or operating in conjunction with any other antenna or transmitter." Since the module is intended for use in a portable device () and co-located with other transmitter (Bluetooth), additional testing is performed to satisfy the SAR requirements of FCC Part 2.1093 (RF Co-location and SAR).</p> <p>Le module a été évalué dans des conditions d'autonomie mobile : "L'antenne utilisée pour cet émetteur doit être installée de manière à assurer une distance de séparation d'au moins 20 cm de toutes les personnes et ne doit pas être installée ou fonctionner en conjonction avec une autre antenne ou un autre émetteur. Étant donné que le module est destiné à être utilisé dans un appareil portable () et qu'il est situé au même endroit qu'un autre émetteur (Bluetooth), des tests supplémentaires sont effectués pour satisfaire aux exigences SAR de la partie 2.1093 de la FCC (Co-localisation RF et SAR).</p> <p>CAN ICES-3 (B) / NMB-3 (B)</p> <p>This Class B digital apparatus complies with Canadian ICES-003. Cet appareil numérique de classe B est conforme à la norme canadienne ICES-003.</p> <p>FCC Class B digital device notice</p> <p>This equipment has been tested and found to comply with the limits for a Class B digital device, pursuant to part 15 of the FCC Rules. These limits are designed to provide reasonable protection against harmful interference in a residential installation. This equipment generates, uses and can radiate radio frequency energy and, if not installed and used in accordance with the instructions, may cause harmful interference to radio communications. However, there is no guarantee that interference will not occur in a particular installation. If this equipment does cause harmful interference to radio or television reception, which can be determined by turning the equipment off and on, the user is encouraged to try to correct the interference by one or more of the following measures:</p> <ul style="list-style-type: none"> - Reorient or relocate the receiving antenna. - Increase the separation between the equipment and receiver. - Connect the equipment into an outlet on a circuit different from that to which the receiver is connected. - Consult the dealer or an experienced radio/TV technician for help.
China		<p>CMII ID: 2023CJ18966 RTM: Real-Time Monitoring 3.0</p>

Region(s)	Labels	Specifications
		
Costa Rica		00094-2024
European Union & EFTA		<p>English Hereby, Harman Becker Automotive Systems GmbH declares that the radio equipment type Telematics Connectivity Antenna Module is in compliance with Directive 2014/53/EU. The full text of the EU declaration of conformity is available at the following internet Address: http://www.harman.com/compliance</p> <p>Bulgarian С настоящото Harman Becker Automotive Systems GmbH декларира, че този тип радиосъоръжение Telematics Connectivity Antenna Module е в съответствие с Директива 2014/53/ЕС. Цялостният текст на ЕС декларацията за съответствие може да се намери на следния интернет адрес: http://www.harman.com/compliance</p> <p>Croatian Harman Becker Automotive Systems GmbH ovime izjavljuje da je radijska oprema tipa Telematics Connectivity Antenna Module u skladu s Direktivom 2014/53/EU. Cjeloviti tekst EU izjave o sukladnosti dostupan je na sljedećoj internetskoj adresi: http://www.harman.com/compliance</p> <p>Czech Tímto Harman Becker Automotive Systems GmbH prohlašuje, že typ rádiového zařízení Telematics Connectivity Antenna Module je v souladu se směrnicí 2014/53/EU. Úplné znění EU prohlášení o shodě je k dispozici na této internetové adrese: http://www.harman.com/compliance</p> <p>Danish Hermed erklærer Harman Becker Automotive Systems GmbH, at radioudstyrtypen Telematics Connectivity Antenna Module er i overensstemmelse med direktiv 2014/53/EU. EU-overensstemmelseserklæringens fulde tekst kan findes på følgende internetadresse: http://www.harman.com/compliance</p> <p>Dutch Hierbij verklaar ik, Harman Becker Automotive Systems GmbH, dat het type radioapparatuur Telematics Connectivity Antenna Module conform is met Richtlijn 2014/53/EU. De volledige tekst van de EU-conformiteitsverklaring kan worden geraadpleegd op het volgende internetadres: http://www.harman.com/compliance</p> <p>Estonian Käesolevaga deklareerib Harman Becker Automotive Systems GmbH, et käesolev raadioseadme tüüp Telematics Connectivity Antenna Module vastab direktiivi 2014/53/EL nõuetele. ELi vastavusdeklaratsiooni täielik tekst on kättesaadav järgmisel internetiaadressil: http://www.harman.com/compliance</p> <p>Finnish Harman Becker Automotive Systems GmbH vakuuttaa, että radiolaitetyyppi Telematics Connectivity Antenna Module on direktiivin 2014/53/EU mukainen. EU-vaatimustenmukaisuusvakuutuksen täysimittainen teksti on saatavilla seuraavassa internetosoitteessa: http://www.harman.com/compliance</p> <p>French Le soussigné, Harman Becker Automotive Systems GmbH, déclare que l'équipement radioélectrique du type Telematics Connectivity Antenna Module est conforme à la directive 2014/53/UE. Le texte complet de la déclaration UE de conformité est disponible à l'adresse internet suivante: http://www.harman.com/compliance Avertissement: a compter du 1er juillet 2020, conformément au « Décret n°2019-1186 relatif à l'affichage du Débit d'Absorption Spécifique des équipements radio » (NOR : SSAP1834791D), la valeur du débit d'absorption spécifique (DAS) pour tout équipement radio dont le rendement est supérieur à 20 mW et qui est susceptible d'être utilisé de manière raisonnablement prévisible à proximité de la tête ou à une distance inférieure ou égale à 20 cm du corps humain doit être fourni de manière lisible, intelligible et visible dans le manuel d'utilisation. L'exigence n'est actuellement applicable qu'aux appareils de téléphonie mobile, conformément au « Décret n° 2010-1207 relatif à l'affichage du débit d'absorption spécifique des équipements terminaux radio (NOR : SASP1011528D).</p> <p>German Hiermit erklärt Harman Becker Automotive Systems GmbH, dass das Gerät mit Funkfunktion Telematics Connectivity Antenna Module der Richtlinie 2014/53/EU entspricht. Der vollständige Text der EU-Konformitätserklärung ist unter der folgenden Internetadresse verfügbar: http://www.harman.com/compliance</p> <p>Greek Με την παρούσα ο/η Harman Becker Automotive Systems GmbH, δηλώνει ότι ο ραδιοεξοπλισμός Telematics Connectivity Antenna Module πληροί την οδηγία 2014/53/ΕΕ. Το πλήρες κείμενο της δήλωσης συμμόρφωσης ΕΕ διατίθεται στην ακόλουθη ιστοσελίδα στο διαδίκτυο: http://www.harman.com/compliance</p> <p>Hungarian Harman Becker Automotive Systems GmbH igazolja, hogy a Telematics Connectivity Antenna Module típusú rádióberendezés megfelel a 2014/53/EU irányelvnek. Az EU-megfelelőségi nyilatkozat teljes szövege elérhető a következő internetes címen: 2014.5.22. L 153/104 Az Európai Unió Hivatalos Lapja HU: http://www.harman.com/compliance</p> <p>Italian </p>

The content of this manual represents the status of the user manual at the time of printing and may not be completely valid in future instances. For more information, refer to the first page for the complete disclaimer note.

Region(s)	Labels	Specifications
		<p>Il fabbricante, Harman Becker Automotive Systems GmbH, dichiara che il tipo di apparecchiatura radio Telematics Connectivity Antenna Module è conforme alla direttiva 2014/53/UE. Il testo completo della dichiarazione di conformità UE è disponibile al seguente indirizzo Internet: http://www.harman.com/compliance</p> <p>Latvian Ar šo Harman Becker Automotive Systems GmbH deklarē, ka radioiekārta Telematics Connectivity Antenna Module atbilst Direktīvai 2014/53/ES. Pilns ES atbilstības deklarācijas teksts ir pieejams šādā interneta vietnē: http://www.harman.com/compliance</p> <p>Lithuanian Aš, Harman Becker Automotive Systems GmbH, patvirtinu, kad radijo įrenginių tipas Telematics Connectivity Antenna Module atitinka Direktyvą 2014/53/ES. Visas ES atitikties deklaracijos tekstas prieinamas šiuo interneto adresu: http://www.harman.com/compliance</p> <p>Maltese B'dan, Harman Becker Automotive Systems GmbH, niddikjara li dan it-tip ta' tagħmir tar-radju Telematics Connectivity Antenna Module huwa konformi mad-Direttiva 2014/53/UE. It-test kollu tad-dikjarazzjoni ta' konformità ta-UE huwa disponibbli f'dan l-indirizz ta-Internet li ġej: http://www.harman.com/compliance</p> <p>Polish Harman Becker Automotive Systems GmbH niniejszym oświadcza, że typ urządzenia radiowego Telematics Connectivity Antenna Module jest zgodny z dyrektywą 2014/53/UE. Pełny tekst deklaracji zgodności UE jest dostępny pod następującym adresem internetowym: http://www.harman.com/compliance</p> <p>Portuguese O(a) abaixo assinado(a) Harman Becker Automotive Systems GmbH declara que o presente tipo de equipamento de rádio Telematics Connectivity Antenna Module está em conformidade com a Diretiva 2014/53/UE. O texto integral da declaração de conformidade está disponível no seguinte endereço de Internet: http://www.harman.com/compliance</p> <p>Romanian Prin prezenta, Harman Becker Automotive Systems GmbH declară că tipul de echipamente radio Telematics Connectivity Antenna Module este în conformitate cu Directiva 2014/53/UE. Textul integral al declarației UE de conformitate este disponibil la următoarea adresă internet: http://www.harman.com/compliance</p> <p>Slovak Harman Becker Automotive Systems GmbH týmto vyhlasuje, že rádiové zariadenie typu Telematics Connectivity Antenna Module je v súlade so smernicou 2014/53/EÚ. Úplné EÚ vyhlásenie o zhode je k dispozícii na tejto internetovej adrese: http://www.harman.com/compliance</p> <p>Slovenian Harman Becker Automotive Systems GmbH potrjuje, da je tip radijske opreme Telematics Connectivity Antenna Module skladen z Direktivo 2014/53/EU. Celotno besedilo izjave EU o skladnosti je na voljo na naslednjem spletnem naslovu: http://www.harman.com/compliance</p> <p>Spanish Por la presente, Harman Becker Automotive Systems GmbH declara que el tipo de equipo radioeléctrico Telematics Connectivity Antenna Module es conforme con la Directiva 2014/53/UE. El texto completo de la declaración UE de conformidad está disponible en la dirección Internet siguiente: http://www.harman.com/compliance</p> <p>Swedish Härmed försäkras Harman Becker Automotive Systems GmbH att denna typ av radioutrustning Telematics Connectivity Antenna Module överensstämmer med direktiv 2014/53/EU. Den fullständiga texten till EUförsäkran om överensstämmelse finns på följande webbadress: http://www.harman.com/compliance</p> <p>Turkish Harman Becker Automotive Systems GmbH işbu, radyo işlevli CONBOX-HIGH cihazı 2014/53 / ABDirektifi ile uyumlu olduğunu beyan eder. AB-uygunluk beyanının tam metnisi aşağıdaki İnternet adresinde mevcuttur: http://www.harman.com/compliance</p>
Indonesia	  <p>Dilarang melakukan perubahan spesifikasi yang dapat menimbulkan gangguan fisik dan/atau elektromagnetik terhadap lingkungan sekitarnya</p>	<p>100947/SDPPI/2024 13809</p>

Part name	Toxic and hazardous substances and elements					
	Pb	Hg	Cd	Cr (VI)	PBB	PBDE
<p>This table was developed according to the provisions of SJ/T 11364.</p> <p>O: The content of such hazardous substance in all homogeneous materials of such component is below the limit required by GB/T 26572</p> <p>X: the content of such hazardous substance in a certain homogeneous material of such component is beyond the limit required by GB/T 26572</p> <p>(Enterprises may further explain the technical reasons for ticking "X" in the table above according to their actual situation herein.</p>						

- [1] TCAM2 and TCAM3
- [2] DoC
- [3] For most bands. Some exceptions exist, per 3GPP standard
- [4] China RoHS

15.5.5. Type approval for TPMS sensor radio frequency

Here you find the radio frequency type approvals for the tyre pressure monitoring system sensor.

Region	Specification
Albania	Hereby, Baolong Huf Shanghai Electronics Co., Ltd declares that the radio equipment type TMSS6A4 is in compliance with Directive 2014/53/EU. The full text of the EU declaration of conformity is available at the following internet address: https://www.bh-sens.com/conformity Frequency band: 433.92 MHz Maximum Transmit Power:<10 mW Manufacturer: Baolong Huf Shanghai Electronics Co., Ltd, 1st Floor, Building 5, 5500 Shenzhuan Rd, Songjiang, Shanghai
Andorra	Hereby, Baolong Huf Shanghai Electronics Co., Ltd declares that the radio equipment type TMSS6A4 is in compliance with Directive 2014/53/EU. The full text of the EU declaration of conformity is available at the following internet address: https://www.bh-sens.com/conformity Frequency band: 433.92 MHz Maximum Transmit Power:<10 mW Manufacturer: Baolong Huf Shanghai Electronics Co., Ltd, 1st Floor, Building 5, 5500 Shenzhuan Rd, Songjiang, Shanghai
Angola	Hereby, Baolong Huf Shanghai Electronics Co., Ltd declares that the radio equipment type TMSS6A4 is in compliance with Directive 2014/53/EU. The full text of the EU declaration of conformity is available at the following internet address: https://www.bh-sens.com/conformity Frequency band: 433.92 MHz Maximum Transmit Power:<10 mW Manufacturer: Baolong Huf Shanghai Electronics Co., Ltd, 1st Floor, Building 5, 5500 Shenzhuan Rd, Songjiang, Shanghai
Argentina	Hereby, Baolong Huf Shanghai Electronics Co., Ltd, declares that this TPMS sensor is in compliance with the essential requirements and provisions of ENACOM.
Armenia	Hereby, Baolong Huf Shanghai Electronics Co., Ltd, declares that this TPMS sensor is in compliance with the essential requirements and provisions of AR COC.
Australia	Hereby, Baolong Huf Shanghai Electronics Co., Ltd, declares that this TPMS sensor is in compliance with the essential requirements and provisions of RCM.
Austria	Hereby, Baolong Huf Shanghai Electronics Co., Ltd declares that the radio equipment type TMSS6A4 is in compliance with Directive 2014/53/EU. The full text of the EU declaration of conformity is available at the following internet address: https://www.bh-sens.com/conformity Frequency band: 433.92 MHz Maximum Transmit Power:<10 mW Manufacturer: Baolong Huf Shanghai Electronics Co., Ltd, 1st Floor, Building 5, 5500 Shenzhuan Rd, Songjiang, Shanghai
Azerbaijan	Hereby, Baolong Huf Shanghai Electronics Co., Ltd, declares that this TPMS sensor is in compliance with the essential requirements and provisions of AZ COC.
Bahrain	Hereby, Baolong Huf Shanghai Electronics Co., Ltd, declares that this TPMS sensor is in compliance with the essential requirements and provisions of TRA.

Region	Specification
Belgium	Hereby, Baolong Huf Shanghai Electronics Co., Ltd declares that the radio equipment type TMSS6A4 is in compliance with Directive 2014/53/EU. The full text of the EU declaration of conformity is available at the following internet address: https://www.bh-sens.com/conformity Frequency band: 433.92 MHz Maximum Transmit Power:<10 mW Manufacturer: Baolong Huf Shanghai Electronics Co., Ltd, 1st Floor, Building 5, 5500 Shenzhuan Rd, Songjiang, Shanghai
Bolivia	Hereby, Baolong Huf Shanghai Electronics Co., Ltd, declares that this TPMS sensor is in compliance with the essential requirements and provisions of ATT
Bosnia-Herzegovina	Hereby, Baolong Huf Shanghai Electronics Co., Ltd declares that the radio equipment type TMSS6A4 is in compliance with Directive 2014/53/EU. The full text of the EU declaration of conformity is available at the following internet address: https://www.bh-sens.com/conformity Frequency band: 433.92 MHz Maximum Transmit Power:<10 mW Manufacturer: Baolong Huf Shanghai Electronics Co., Ltd, 1st Floor, Building 5, 5500 Shenzhuan Rd, Songjiang, Shanghai
Botswana	Hereby, Baolong Huf Shanghai Electronics Co., Ltd, declares that this TPMS sensor is in compliance with the essential requirements and provisions of BOCAR.
Brazil	Hereby, Baolong Huf Shanghai Electronics Co., Ltd, declares that this TPMS sensor is in compliance with the essential requirements and provisions of ANATEL.
Bulgaria	Hereby, Baolong Huf Shanghai Electronics Co., Ltd declares that the radio equipment type TMSS6A4 is in compliance with Directive 2014/53/EU. The full text of the EU declaration of conformity is available at the following internet address: https://www.bh-sens.com/conformity Frequency band: 433.92 MHz Maximum Transmit Power:<10 mW Manufacturer: Baolong Huf Shanghai Electronics Co., Ltd, 1st Floor, Building 5, 5500 Shenzhuan Rd, Songjiang, Shanghai
Cambodia	Hereby, Baolong Huf Shanghai Electronics Co., Ltd, declares that this TPMS sensor is in compliance with the essential requirements and provisions of TRC.
Canada	Hereby, Baolong Huf Shanghai Electronics Co., Ltd, declares that this TPMS sensor is in compliance with the essential requirements and provisions of ISED.
Chile	 <p>El equipo previamente individualizado cumple con las disposiciones establecidas en la Norma Técnica de Equipos de alcance reducido, aprobada por la resolución exenta N° 1.985, de 2017, de la Subsecretaría de Telecomunicaciones.</p>
China	Hereby, Baolong Huf Shanghai Electronics Co., Ltd, declares that this TPMS sensor is in compliance with the essential requirements and provisions of SRRC.
Colombia	Hereby, Baolong Huf Shanghai Electronics Co., Ltd, declares that this TPMS sensor is in compliance with the essential requirements and provisions of CRC.
Costa Rica	Hereby, Baolong Huf Shanghai Electronics Co., Ltd, declares that this TPMS sensor is in compliance with the essential requirements and provisions of SUTEL.
Croatia	Hereby, Baolong Huf Shanghai Electronics Co., Ltd declares that the radio equipment type TMSS6A4 is in compliance with Directive 2014/53/EU. The full text of the EU declaration of conformity is available at the following internet address: https://www.bh-sens.com/conformity Frequency band: 433.92 MHz Maximum Transmit Power:<10 mW Manufacturer: Baolong Huf Shanghai Electronics Co., Ltd, 1st Floor, Building 5, 5500 Shenzhuan Rd, Songjiang, Shanghai
Cyprus	Hereby, Baolong Huf Shanghai Electronics Co., Ltd declares that the radio equipment type TMSS6A4 is in compliance with Directive 2014/53/EU. The full text of the EU declaration of conformity is available at the following internet address: https://www.bh-sens.com/conformity Frequency band: 433.92 MHz Maximum Transmit Power:<10 mW Manufacturer: Baolong Huf Shanghai Electronics Co., Ltd, 1st Floor, Building 5, 5500 Shenzhuan Rd, Songjiang, Shanghai
Czech Republic	Hereby, Baolong Huf Shanghai Electronics Co., Ltd declares that the radio equipment type TMSS6A4 is in compliance with Directive 2014/53/EU. The full text of the EU declaration of conformity is available at the following internet address: https://www.bh-sens.com/conformity Frequency band: 433.92 MHz Maximum Transmit Power:<10 mW Manufacturer: Baolong Huf Shanghai Electronics Co., Ltd, 1st Floor, Building 5, 5500 Shenzhuan Rd, Songjiang, Shanghai
Denmark	Hereby, Baolong Huf Shanghai Electronics Co., Ltd declares that the radio equipment type TMSS6A4 is in compliance with Directive 2014/53/EU. The full text of the EU declaration of conformity is available at the following internet address: https://www.bh-sens.com/conformity Frequency band: 433.92 MHz Maximum Transmit Power:<10 mW Manufacturer: Baolong Huf Shanghai Electronics Co., Ltd, 1st Floor, Building 5, 5500 Shenzhuan Rd, Songjiang, Shanghai

Region	Specification
Dominican Republic	Hereby, Baolong Huf Shanghai Electronics Co., Ltd, declares that this TPMS sensor is in compliance with the essential requirements and provisions of INDOTEL.
Egypt	Hereby, Baolong Huf Shanghai Electronics Co., Ltd, declares that this TPMS sensor is in compliance with the essential requirements and provisions of NTRA.
Estonia	Hereby, Baolong Huf Shanghai Electronics Co., Ltd declares that the radio equipment type TMSS6A4 is in compliance with Directive 2014/53/EU. The full text of the EU declaration of conformity is available at the following internet address: https://www.bh-sens.com/conformity Frequency band: 433.92 MHz Maximum Transmit Power:<10 mW Manufacturer: Baolong Huf Shanghai Electronics Co., Ltd, 1st Floor, Building 5, 5500 Shenzhuan Rd, Songjiang, Shanghai
Faroe Islands	Hereby, Baolong Huf Shanghai Electronics Co., Ltd declares that the radio equipment type TMSS6A4 is in compliance with Directive 2014/53/EU. The full text of the EU declaration of conformity is available at the following internet address: https://www.bh-sens.com/conformity Frequency band: 433.92 MHz Maximum Transmit Power:<10 mW Manufacturer: Baolong Huf Shanghai Electronics Co., Ltd, 1st Floor, Building 5, 5500 Shenzhuan Rd, Songjiang, Shanghai
Finland	Hereby, Baolong Huf Shanghai Electronics Co., Ltd declares that the radio equipment type TMSS6A4 is in compliance with Directive 2014/53/EU. The full text of the EU declaration of conformity is available at the following internet address: https://www.bh-sens.com/conformity Frequency band: 433.92 MHz Maximum Transmit Power:<10 mW Manufacturer: Baolong Huf Shanghai Electronics Co., Ltd, 1st Floor, Building 5, 5500 Shenzhuan Rd, Songjiang, Shanghai
France	Hereby, Baolong Huf Shanghai Electronics Co., Ltd declares that the radio equipment type TMSS6A4 is in compliance with Directive 2014/53/EU. The full text of the EU declaration of conformity is available at the following internet address: https://www.bh-sens.com/conformity Frequency band: 433.92 MHz Maximum Transmit Power:<10 mW Manufacturer: Baolong Huf Shanghai Electronics Co., Ltd, 1st Floor, Building 5, 5500 Shenzhuan Rd, Songjiang, Shanghai
Georgia	Hereby, Baolong Huf Shanghai Electronics Co., Ltd declares that the radio equipment type TMSS6A4 is in compliance with Directive 2014/53/EU. The full text of the EU declaration of conformity is available at the following internet address: https://www.bh-sens.com/conformity Frequency band: 433.92 MHz Maximum Transmit Power:<10 mW Manufacturer: Baolong Huf Shanghai Electronics Co., Ltd, 1st Floor, Building 5, 5500 Shenzhuan Rd, Songjiang, Shanghai
Germany	Hereby, Baolong Huf Shanghai Electronics Co., Ltd declares that the radio equipment type TMSS6A4 is in compliance with Directive 2014/53/EU. The full text of the EU declaration of conformity is available at the following internet address: https://www.bh-sens.com/conformity Frequency band: 433.92 MHz Maximum Transmit Power:<10 mW Manufacturer: Baolong Huf Shanghai Electronics Co., Ltd, 1st Floor, Building 5, 5500 Shenzhuan Rd, Songjiang, Shanghai
Greece	Hereby, Baolong Huf Shanghai Electronics Co., Ltd declares that the radio equipment type TMSS6A4 is in compliance with Directive 2014/53/EU. The full text of the EU declaration of conformity is available at the following internet address: https://www.bh-sens.com/conformity Frequency band: 433.92 MHz Maximum Transmit Power:<10 mW Manufacturer: Baolong Huf Shanghai Electronics Co., Ltd, 1st Floor, Building 5, 5500 Shenzhuan Rd, Songjiang, Shanghai
Greenland	Hereby, Baolong Huf Shanghai Electronics Co., Ltd declares that the radio equipment type TMSS6A4 is in compliance with Directive 2014/53/EU. The full text of the EU declaration of conformity is available at the following internet address: https://www.bh-sens.com/conformity Frequency band: 433.92 MHz Maximum Transmit Power:<10 mW Manufacturer: Baolong Huf Shanghai Electronics Co., Ltd, 1st Floor, Building 5, 5500 Shenzhuan Rd, Songjiang, Shanghai
Guadeloupe	Hereby, Baolong Huf Shanghai Electronics Co., Ltd declares that the radio equipment type TMSS6A4 is in compliance with Directive 2014/53/EU. The full text of the EU declaration of conformity is available at the following internet address: https://www.bh-sens.com/conformity Frequency band: 433.92 MHz Maximum Transmit Power:<10 mW Manufacturer: Baolong Huf Shanghai Electronics Co., Ltd, 1st Floor, Building 5, 5500 Shenzhuan Rd, Songjiang, Shanghai
Guatemala	Hereby, Baolong Huf Shanghai Electronics Co., Ltd, declares that this TPMS sensor is in compliance with the essential requirements and provisions of SIT.
Hong Kong	Hereby, Baolong Huf Shanghai Electronics Co., Ltd declares that the radio equipment type TMSS6A4 is in compliance with Directive 2014/53/EU. The full text of the EU declaration of conformity is available at the following internet address: https://www.bh-sens.com/conformity Frequency band: 433.92 MHz Maximum Transmit Power:<10 mW Manufacturer: Baolong Huf Shanghai Electronics Co., Ltd, 1st Floor, Building 5, 5500 Shenzhuan Rd, Songjiang, Shanghai

Region	Specification
Hungary	Hereby, Baolong Huf Shanghai Electronics Co., Ltd declares that the radio equipment type TMSS6A4 is in compliance with Directive 2014/53/EU. The full text of the EU declaration of conformity is available at the following internet address: https://www.bh-sens.com/conformity Frequency band: 433.92 MHz Maximum Transmit Power:<10 mW Manufacturer: Baolong Huf Shanghai Electronics Co., Ltd, 1st Floor, Building 5, 5500 Shenzhuan Rd, Songjiang, Shanghai
Iceland	Hereby, Baolong Huf Shanghai Electronics Co., Ltd declares that the radio equipment type TMSS6A4 is in compliance with Directive 2014/53/EU. The full text of the EU declaration of conformity is available at the following internet address: https://www.bh-sens.com/conformity Frequency band: 433.92 MHz Maximum Transmit Power:<10 mW Manufacturer: Baolong Huf Shanghai Electronics Co., Ltd, 1st Floor, Building 5, 5500 Shenzhuan Rd, Songjiang, Shanghai
India	Hereby, Baolong Huf Shanghai Electronics Co., Ltd, declares that this TPMS sensor is in compliance with the essential requirements and provisions of WPC.
Indonesia	Hereby, Baolong Huf Shanghai Electronics Co., Ltd, declares that this TPMS sensor is in compliance with the essential requirements and provisions of SDPPI.
Ireland	Hereby, Baolong Huf Shanghai Electronics Co., Ltd declares that the radio equipment type TMSS6A4 is in compliance with Directive 2014/53/EU. The full text of the EU declaration of conformity is available at the following internet address: https://www.bh-sens.com/conformity Frequency band: 433.92 MHz Maximum Transmit Power:<10 mW Manufacturer: Baolong Huf Shanghai Electronics Co., Ltd, 1st Floor, Building 5, 5500 Shenzhuan Rd, Songjiang, Shanghai
Israel	Hereby, Baolong Huf Shanghai Electronics Co., Ltd, declares that this TPMS sensor is in compliance with the essential requirements and provisions of MOC.
Italy	Hereby, Baolong Huf Shanghai Electronics Co., Ltd declares that the radio equipment type TMSS6A4 is in compliance with Directive 2014/53/EU. The full text of the EU declaration of conformity is available at the following internet address: https://www.bh-sens.com/conformity Frequency band: 433.92 MHz Maximum Transmit Power:<10 mW Manufacturer: Baolong Huf Shanghai Electronics Co., Ltd, 1st Floor, Building 5, 5500 Shenzhuan Rd, Songjiang, Shanghai
Ivory Coast	Hereby, Baolong Huf Shanghai Electronics Co., Ltd, declares that this TPMS sensor is in compliance with the essential requirements and provisions of ARTCI.
Japan	Hereby, Baolong Huf Shanghai Electronics Co., Ltd, declares that this TPMS sensor is in compliance with the essential requirements and provisions of MIC. 
Jordan	Hereby, Baolong Huf Shanghai Electronics Co., Ltd, declares that this TPMS sensor is in compliance with the essential requirements and provisions of TRC.
Kazakhstan	Hereby, Baolong Huf Shanghai Electronics Co., Ltd, declares that this TPMS sensor is in compliance with the essential requirements and provisions of EAC.
Kenya	Hereby, Baolong Huf Shanghai Electronics Co., Ltd, declares that this TPMS sensor is in compliance with the essential requirements and provisions of CAK.
Korea	Hereby, Baolong Huf Shanghai Electronics Co., Ltd, declares that this TPMS sensor is in compliance with the essential requirements and provisions of KC.
Kosovo	Hereby, Baolong Huf Shanghai Electronics Co., Ltd declares that the radio equipment type TMSS6A4 is in compliance with Directive 2014/53/EU. The full text of the EU declaration of conformity is available at the following internet address: https://www.bh-sens.com/conformity Frequency band: 433.92 MHz Maximum Transmit Power:<10 mW Manufacturer: Baolong Huf Shanghai Electronics Co., Ltd, 1st Floor, Building 5, 5500 Shenzhuan Rd, Songjiang, Shanghai
Kuwait	Hereby, Baolong Huf Shanghai Electronics Co., Ltd, declares that this TPMS sensor is in compliance with the essential requirements and provisions of CITRA.
La Réunion	Hereby, Baolong Huf Shanghai Electronics Co., Ltd declares that the radio equipment type TMSS6A4 is in compliance with Directive 2014/53/EU. The full text of the EU declaration of conformity is available at the following internet address: https://www.bh-sens.com/conformity Frequency band: 433.92 MHz Maximum Transmit Power:<10 mW Manufacturer: Baolong Huf Shanghai Electronics Co., Ltd, 1st Floor, Building 5, 5500 Shenzhuan Rd, Songjiang, Shanghai

Region	Specification
Latvia	Hereby, Baolong Huf Shanghai Electronics Co., Ltd declares that the radio equipment type TMSS6A4 is in compliance with Directive 2014/53/EU. The full text of the EU declaration of conformity is available at the following internet address: https://www.bh-sens.com/conformity Frequency band: 433.92 MHz Maximum Transmit Power:<10 mW Manufacturer: Baolong Huf Shanghai Electronics Co., Ltd, 1st Floor, Building 5, 5500 Shenzhuan Rd, Songjiang, Shanghai
Lebanon	Hereby, Baolong Huf Shanghai Electronics Co., Ltd, declares that this TPMS sensor is in compliance with the essential requirements and provisions of MOT.
Liechtenstein	Hereby, Baolong Huf Shanghai Electronics Co., Ltd declares that the radio equipment type TMSS6A4 is in compliance with Directive 2014/53/EU. The full text of the EU declaration of conformity is available at the following internet address: https://www.bh-sens.com/conformity Frequency band: 433.92 MHz Maximum Transmit Power:<10 mW Manufacturer: Baolong Huf Shanghai Electronics Co., Ltd, 1st Floor, Building 5, 5500 Shenzhuan Rd, Songjiang, Shanghai
Lithuania	Hereby, Baolong Huf Shanghai Electronics Co., Ltd declares that the radio equipment type TMSS6A4 is in compliance with Directive 2014/53/EU. The full text of the EU declaration of conformity is available at the following internet address: https://www.bh-sens.com/conformity Frequency band: 433.92 MHz Maximum Transmit Power:<10 mW Manufacturer: Baolong Huf Shanghai Electronics Co., Ltd, 1st Floor, Building 5, 5500 Shenzhuan Rd, Songjiang, Shanghai
Luxembourg	Hereby, Baolong Huf Shanghai Electronics Co., Ltd declares that the radio equipment type TMSS6A4 is in compliance with Directive 2014/53/EU. The full text of the EU declaration of conformity is available at the following internet address: https://www.bh-sens.com/conformity Frequency band: 433.92 MHz Maximum Transmit Power:<10 mW Manufacturer: Baolong Huf Shanghai Electronics Co., Ltd, 1st Floor, Building 5, 5500 Shenzhuan Rd, Songjiang, Shanghai
Macedonia	Hereby, Baolong Huf Shanghai Electronics Co., Ltd declares that the radio equipment type TMSS6A4 is in compliance with Directive 2014/53/EU. The full text of the EU declaration of conformity is available at the following internet address: https://www.bh-sens.com/conformity Frequency band: 433.92 MHz Maximum Transmit Power:<10 mW Manufacturer: Baolong Huf Shanghai Electronics Co., Ltd, 1st Floor, Building 5, 5500 Shenzhuan Rd, Songjiang, Shanghai
Malaysia	Hereby, Baolong Huf Shanghai Electronics Co., Ltd, declares that this TPMS sensor is in compliance with the essential requirements and provisions of SIRIM.
Malta	Hereby, Baolong Huf Shanghai Electronics Co., Ltd declares that the radio equipment type TMSS6A4 is in compliance with Directive 2014/53/EU. The full text of the EU declaration of conformity is available at the following internet address: https://www.bh-sens.com/conformity Frequency band: 433.92 MHz Maximum Transmit Power:<10 mW Manufacturer: Baolong Huf Shanghai Electronics Co., Ltd, 1st Floor, Building 5, 5500 Shenzhuan Rd, Songjiang, Shanghai
Martinique	Hereby, Baolong Huf Shanghai Electronics Co., Ltd declares that the radio equipment type TMSS6A4 is in compliance with Directive 2014/53/EU. The full text of the EU declaration of conformity is available at the following internet address: https://www.bh-sens.com/conformity Frequency band: 433.92 MHz Maximum Transmit Power:<10 mW Manufacturer: Baolong Huf Shanghai Electronics Co., Ltd, 1st Floor, Building 5, 5500 Shenzhuan Rd, Songjiang, Shanghai
Morocco	Hereby, Baolong Huf Shanghai Electronics Co., Ltd, declares that this TPMS sensor is in compliance with the essential requirements and provisions of ANRT.
Mexico	Modelo del producto: TMSS6A4 Marca: BH SENS IFT: VOBHTM23-23595 La operación de este equipo está sujeta a las siguientes dos condiciones: (1) es posible que este equipo o dispositivo no cause interferencia perjudicial y (2) este equipo o dispositivo debe aceptar cualquier interferencia, incluyendo la que pueda causar su operación no deseada.
Moldova	Hereby, Baolong Huf Shanghai Electronics Co., Ltd declares that the radio equipment type TMSS6A4 is in compliance with Directive 2014/53/EU. The full text of the EU declaration of conformity is available at the following internet address: https://www.bh-sens.com/conformity Frequency band: 433.92 MHz Maximum Transmit Power:<10 mW Manufacturer: Baolong Huf Shanghai Electronics Co., Ltd, 1st Floor, Building 5, 5500 Shenzhuan Rd, Songjiang, Shanghai
Monaco	Hereby, Baolong Huf Shanghai Electronics Co., Ltd declares that the radio equipment type TMSS6A4 is in compliance with Directive 2014/53/EU. The full text of the EU declaration of conformity is available at the following internet address: https://www.bh-sens.com/conformity Frequency band: 433.92 MHz Maximum Transmit Power:<10 mW Manufacturer: Baolong Huf Shanghai Electronics Co., Ltd, 1st Floor, Building 5, 5500 Shenzhuan Rd, Songjiang, Shanghai
Mozambique	Hereby, Baolong Huf Shanghai Electronics Co., Ltd, declares that this TPMS sensor is in compliance with the essential requirements and provisions of INCM.

Region	Specification
Namibia	Hereby, Baolong Huf Shanghai Electronics Co., Ltd, declares that this TPMS sensor is in compliance with the essential requirements and provisions of CRAN.
Netherlands	Hereby, Baolong Huf Shanghai Electronics Co., Ltd declares that the radio equipment type TMSS6A4 is in compliance with Directive 2014/53/EU. The full text of the EU declaration of conformity is available at the following internet address: https://www.bh-sens.com/conformity Frequency band: 433.92 MHz Maximum Transmit Power:<10 mW Manufacturer: Baolong Huf Shanghai Electronics Co., Ltd, 1st Floor, Building 5, 5500 Shenzhuan Rd, Songjiang, Shanghai
New Zealand	Hereby, Baolong Huf Shanghai Electronics Co., Ltd, declares that this TPMS sensor is in compliance with the essential requirements and provisions of RCM.
Norway	Hereby, Baolong Huf Shanghai Electronics Co., Ltd declares that the radio equipment type TMSS6A4 is in compliance with Directive 2014/53/EU. The full text of the EU declaration of conformity is available at the following internet address: https://www.bh-sens.com/conformity Frequency band: 433.92 MHz Maximum Transmit Power:<10 mW Manufacturer: Baolong Huf Shanghai Electronics Co., Ltd, 1st Floor, Building 5, 5500 Shenzhuan Rd, Songjiang, Shanghai
Oman	Hereby, Baolong Huf Shanghai Electronics Co., Ltd, declares that this TPMS sensor is in compliance with the essential requirements and provisions of TRA.
Pakistan	Hereby, Baolong Huf Shanghai Electronics Co., Ltd, declares that this TPMS sensor is in compliance with the essential requirements and provisions of PTA.
Panama	Hereby, Baolong Huf Shanghai Electronics Co., Ltd, declares that this TPMS sensor is in compliance with the essential requirements and provisions of ASEP.
Paraguay	Hereby, Baolong Huf Shanghai Electronics Co., Ltd, declares that this TPMS sensor is in compliance with the essential requirements and provisions of CONATEL. 
Peru (Maquinaria)	Hereby, Baolong Huf Shanghai Electronics Co., Ltd, declares that this TPMS sensor is in compliance with the essential requirements and provisions of MTC.
Philippines	Hereby, Baolong Huf Shanghai Electronics Co., Ltd, declares that this TPMS sensor is in compliance with the essential requirements and provisions of NTC.
Poland	Hereby, Baolong Huf Shanghai Electronics Co., Ltd declares that the radio equipment type TMSS6A4 is in compliance with Directive 2014/53/EU. The full text of the EU declaration of conformity is available at the following internet address: https://www.bh-sens.com/conformity Frequency band: 433.92 MHz Maximum Transmit Power:<10 mW Manufacturer: Baolong Huf Shanghai Electronics Co., Ltd, 1st Floor, Building 5, 5500 Shenzhuan Rd, Songjiang, Shanghai
Portugal	Hereby, Baolong Huf Shanghai Electronics Co., Ltd declares that the radio equipment type TMSS6A4 is in compliance with Directive 2014/53/EU. The full text of the EU declaration of conformity is available at the following internet address: https://www.bh-sens.com/conformity Frequency band: 433.92 MHz Maximum Transmit Power:<10 mW Manufacturer: Baolong Huf Shanghai Electronics Co., Ltd, 1st Floor, Building 5, 5500 Shenzhuan Rd, Songjiang, Shanghai
Puerto Rico	Hereby, Baolong Huf Shanghai Electronics Co., Ltd, declares that this TPMS sensor is in compliance with the essential requirements and provisions of FCC.
Qatar	Hereby, Baolong Huf Shanghai Electronics Co., Ltd, declares that this TPMS sensor is in compliance with the essential requirements and provisions of CRA.
Romania	Hereby, Baolong Huf Shanghai Electronics Co., Ltd declares that the radio equipment type TMSS6A4 is in compliance with Directive 2014/53/EU. The full text of the EU declaration of conformity is available at the following internet address: https://www.bh-sens.com/conformity Frequency band: 433.92 MHz Maximum Transmit Power:<10 mW Manufacturer: Baolong Huf Shanghai Electronics Co., Ltd, 1st Floor, Building 5, 5500 Shenzhuan Rd, Songjiang, Shanghai
San Marino	Hereby, Baolong Huf Shanghai Electronics Co., Ltd declares that the radio equipment type TMSS6A4 is in compliance with Directive 2014/53/EU. The full text of the EU declaration of conformity is available at the following internet address: https://www.bh-sens.com/conformity Frequency band: 433.92 MHz Maximum Transmit Power:<10 mW Manufacturer: Baolong Huf Shanghai Electronics Co., Ltd, 1st Floor, Building 5, 5500 Shenzhuan Rd, Songjiang, Shanghai
Saudi Arabia	Hereby, Baolong Huf Shanghai Electronics Co., Ltd, declares that this TPMS sensor is in compliance with the essential requirements and provisions of CST.

Region	Specification
Serbia/Montenegro	Hereby, Baolong Huf Shanghai Electronics Co., Ltd, declares that this TPMS sensor is in compliance with the essential requirements and provisions of RS COC.
Singapore	Hereby, Baolong Huf Shanghai Electronics Co., Ltd, declares that this TPMS sensor is in compliance with the essential requirements and provisions of IMDA.
Slovak Republic	Hereby, Baolong Huf Shanghai Electronics Co., Ltd declares that the radio equipment type TMSS6A4 is in compliance with Directive 2014/53/EU. The full text of the EU declaration of conformity is available at the following internet address: https://www.bh-sens.com/conformity Frequency band: 433.92 MHz Maximum Transmit Power:<10 mW Manufacturer: Baolong Huf Shanghai Electronics Co., Ltd, 1st Floor, Building 5, 5500 Shenzhuan Rd, Songjiang, Shanghai
Slovenia	Hereby, Baolong Huf Shanghai Electronics Co., Ltd declares that the radio equipment type TMSS6A4 is in compliance with Directive 2014/53/EU. The full text of the EU declaration of conformity is available at the following internet address: https://www.bh-sens.com/conformity Frequency band: 433.92 MHz Maximum Transmit Power:<10 mW Manufacturer: Baolong Huf Shanghai Electronics Co., Ltd, 1st Floor, Building 5, 5500 Shenzhuan Rd, Songjiang, Shanghai
South Africa	Hereby, Baolong Huf Shanghai Electronics Co., Ltd, declares that this TPMS sensor is in compliance with the essential requirements and provisions of ICASA.
Spain	Hereby, Baolong Huf Shanghai Electronics Co., Ltd declares that the radio equipment type TMSS6A4 is in compliance with Directive 2014/53/EU. The full text of the EU declaration of conformity is available at the following internet address: https://www.bh-sens.com/conformity Frequency band: 433.92 MHz Maximum Transmit Power:<10 mW Manufacturer: Baolong Huf Shanghai Electronics Co., Ltd, 1st Floor, Building 5, 5500 Shenzhuan Rd, Songjiang, Shanghai
Sri Lanka	Hereby, Baolong Huf Shanghai Electronics Co., Ltd, declares that this TPMS sensor is in compliance with the essential requirements and provisions of TRCSL.
Sweden	Hereby, Baolong Huf Shanghai Electronics Co., Ltd declares that the radio equipment type TMSS6A4 is in compliance with Directive 2014/53/EU. The full text of the EU declaration of conformity is available at the following internet address: https://www.bh-sens.com/conformity Frequency band: 433.92 MHz Maximum Transmit Power:<10 mW Manufacturer: Baolong Huf Shanghai Electronics Co., Ltd, 1st Floor, Building 5, 5500 Shenzhuan Rd, Songjiang, Shanghai
Switzerland	Hereby, Baolong Huf Shanghai Electronics Co., Ltd declares that the radio equipment type TMSS6A4 is in compliance with Directive 2014/53/EU. The full text of the EU declaration of conformity is available at the following internet address: https://www.bh-sens.com/conformity Frequency band: 433.92 MHz Maximum Transmit Power:<10 mW Manufacturer: Baolong Huf Shanghai Electronics Co., Ltd, 1st Floor, Building 5, 5500 Shenzhuan Rd, Songjiang, Shanghai
Taiwan	Hereby, Baolong Huf Shanghai Electronics Co., Ltd, declares that this TPMS sensor is in compliance with the essential requirements and provisions of NCC.
Thailand	Hereby, Baolong Huf Shanghai Electronics Co., Ltd, declares that this TPMS sensor is in compliance with the essential requirements and provisions of NBTC.
Trinidad and Tobago	Hereby, Baolong Huf Shanghai Electronics Co., Ltd, declares that this TPMS sensor is in compliance with the essential requirements and provisions of TATT.
Tunisia	Hereby, Baolong Huf Shanghai Electronics Co., Ltd, declares that this TPMS sensor is in compliance with the essential requirements and provisions of CERT.
Türkiye	Hereby, Baolong Huf Shanghai Electronics Co., Ltd declares that the radio equipment type TMSS6A4 is in compliance with Directive 2014/53/EU. The full text of the EU declaration of conformity is available at the following internet address: https://www.bh-sens.com/conformity Frequency band: 433.92 MHz Maximum Transmit Power:<10 mW Manufacturer: Baolong Huf Shanghai Electronics Co., Ltd, 1st Floor, Building 5, 5500 Shenzhuan Rd, Songjiang, Shanghai
United Arab Emirates	Hereby, Baolong Huf Shanghai Electronics Co., Ltd, declares that this TPMS sensor is in compliance with the essential requirements and provisions of TDRA.
Ukraine	справжнім Baolong Huf Shanghai Electronics Co., Ltd заявляє, що тип радіобладнання TMSS6A4 відповідає Технічному регламенту радіобладнання;повний текст декларації про відповідність доступний на веб-сайті за такою адресою: https://www.bh-sens.com/conformity
United Kingdom	Hereby, Baolong Huf Shanghai Electronics Co., Ltd declares that the radio equipment type TMSS6A4 is in compliance with radio regulation 2017. The full text of the UK declaration of conformity is available at the following internet address: https://www.bh-sens.com/conformity Frequency band: 433.92 MHz Maximum Transmit Power:<10 mW Manufacturer: Baolong Huf Shanghai Electronics Co., Ltd, 1st Floor, Building 5, 5500 Shenzhuan Rd, Songjiang, Shanghai

Region	Specification
Uruguay	Hereby, Baolong Huf Shanghai Electronics Co., Ltd, declares that this TPMS sensor is in compliance with the essential requirements and provisions of URSEC.
United States	Hereby, Baolong Huf Shanghai Electronics Co., Ltd, declares that this TPMS sensor is in compliance with the essential requirements and provisions of FCC.
Uzbekistan	Hereby, Baolong Huf Shanghai Electronics Co., Ltd, declares that this TPMS sensor is in compliance with the essential requirements and provisions of MiTC.
Vatican City	Hereby, Baolong Huf Shanghai Electronics Co., Ltd declares that the radio equipment type TMSS6A4 is in compliance with Directive 2014/53/EU. The full text of the EU declaration of conformity is available at the following internet address: https://www.bh-sens.com/conformity Frequency band: 433.92 MHz Maximum Transmit Power:<10 mW Manufacturer: Baolong Huf Shanghai Electronics Co., Ltd, 1st Floor, Building 5, 5500 Shenzhuan Rd, Songjiang, Shanghai
Vietnam	Hereby, Baolong Huf Shanghai Electronics Co., Ltd, declares that this TPMS sensor is in compliance with the essential requirements and provisions of MIC.
Zambia	Hereby, Baolong Huf Shanghai Electronics Co., Ltd, declares that this TPMS sensor is in compliance with the essential requirements and provisions of ZICTA.
Zimbabwe	Hereby, Baolong Huf Shanghai Electronics Co., Ltd, declares that this TPMS sensor is in compliance with the essential requirements and provisions of POTRAZ.

15.5.6. Type approvals for wireless charger and NFC

What follows are the technical specifications and certificates for the wireless charger.

Manufacturer

Molex CVS Bochum GmbH

Address: Meesmannstr. 103, 44807 Bochum, Germany

Phone: +49 234 51668 0

Technical specification





Wireless charger







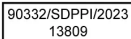

- Frequency Band: 127,55kHz
- Maximum Magnetic Field Strength: 55,77dBµA/m



NFC card reader

- Frequency Band 13.56MHz
- Maximum Magnetic Field Strength: 42dBµA/m

Declaration of conformity

Denmark, Norway	Hermed erklærer Molex CVS Bochum GmbH, at radioudstyrstypen WCH-303 er i overensstemmelse med direktiv 2014/53/EU. EU-overensstemmelseserklæringens fulde tekst kan findes på følgende internetadresse: http://www.molex.com/doc
Estonia	Käesolevaga deklareerib Molex CVS Bochum GmbH, et käesolev raadioseadme tüüp WCH-303 vastab direktiivi 2014/53/EL nõuetele. ELi vastavusdeklaratsiooni täielik tekst on kättesaadav järgmisel internetiaadressil: http://www.molex.com/doc
Finland	Molex CVS Bochum GmbH vakuuttaa, että radiolaitetyyppi WCH-303 on direktiivin 2014/53/EU mukainen. EU-vaatimustenmukaisuusvakuutuksen täysimittainen teksti on saatavilla seuraavassa internetosoitteessa: http://www.molex.com/doc
France, Belgium, Luxembourg, Switzerland	Le soussigné, Molex CVS Bochum GmbH, déclare que l'équipement radioélectrique du type WCH-303 est conforme à la directive 2014/53/UE. Le texte complet de la déclaration UE de conformité est disponible à l'adresse internet suivante: http://www.molex.com/doc
Ghana	
Greece, Cyprus	Με την παρούσα ο/η Molex CVS Bochum GmbH, δηλώνει ότι ο ραδιοεξοπλισμός WCH-303 πληροί την οδηγία 2014/53/ΕΕ. Το πλήρες κείμενο της δήλωσης συμμόρφωσης ΕΕ διατίθεται στην ακόλουθη ιστοσελίδα στο διαδίκτυο: http://www.molex.com/doc
Indonesia	 <p>Dilarang melakukan perubahan spesifikasi yang dapat menimbulkan gangguan fisik dan/atau elektromagnetik terhadap lingkungan sekitarnya</p> <p>China:</p>   <p>Mexico:</p>  
Israel	51-9279 : מספר אישור התאמה מטעם משרד התקשורת : חל איסור לבצע פעולות במכשיר אשר יש בהן כדי לשנות את תכונותיו האלחוטיות של המכשיר, ובכלל זה החלפת אנטנה מקורית או הוספת אפשרות לחיבור לאנטנה חיצונית ללא קבלת אישור משרד התקשורת, בשל חשש להפרעות אלחוטיות.
Italy, Switzerland	Il fabbricante, Molex CVS Bochum GmbH, dichiara che il tipo di apparecchiatura radio WCH-303 è conforme alla direttiva 2014/53/UE. Il testo completo della dichiarazione di conformità UE è disponibile al seguente indirizzo Internet: http://www.molex.com/doc
Latvia	Ar šo Molex CVS Bochum GmbH deklarē, ka radioiekārta WCH-303 atbilst Direktīvai 2014/53/ES. Pilns ES atbilstības deklarācijas teksts ir pieejams šādā interneta vietnē: http://www.molex.com/doc
Lithuania	Aš, Molex CVS Bochum GmbH, patvirtinu, kad radijo įrenginių tipas WCH-303 atitinka Direktyvą 2014/53/ES. Visas ES atitikties deklaracijos tekstas prieinamas šiuo interneto adresu: http://www.molex.com/doc



Hungary	Molex CVS Bochum GmbH igazolja, hogy a WCH-303 típusú rádióberendezés megfelel a 2014/53/EU irányelvnek. Az EU-megfelelőségi nyilatkozat teljes szövege elérhető a következő internetes címen: http://www.molex.com/doc
Malaysia	 MCMC HIDF15000171
Malta	B'dan, Molex CVS Bochum GmbH, niddikjara li dan it-tip ta' tagħmir tar-radju WCH-303 huwa konformi mad-Direttiva 2014/53/UE. It-test kollu tad-dikjarazzjoni ta' konformità ta-UE huwa disponibbli f'dan l-indirizz ta-Internet li ġej: http://www.molex.com/doc
Mexico	IFT approval: VOMOWC23-11195
Oman	 Oman - TRA R/15237/23 D202897
Pakistan	 Approved by PTA 1999/2011 PTA Communication Commission
Paraguay	 CONATEL IN 5223-56--0356
Poland	Molex CVS Bochum GmbH niniejszym oświadcza, że typ urządzenia radiowego WCH-303 jest zgodny z dyrektywą 2014/53/UE. Pełny tekst deklaracji zgodności UE jest dostępny pod następującym adresem internetowym: http://www.molex.com/doc
Portugal	O(a) abaixo assinado(a) Molex CVS Bochum GmbH declara que o presente tipo de equipamento de rádio WCH-303 está em conformidade com a Diretiva 2014/53/UE. O texto integral da declaração de conformidade está disponível no seguinte endereço de Internet: http://www.molex.com/doc
Romania, Moldova	Prin prezenta, Molex CVS Bochum GmbH declară că tipul de echipamente radio WCH-303 este în conformitate cu Directiva 2014/53/UE. Textul integral al declarației UE de conformitate este disponibil la următoarea adresă internet: http://www.molex.com/doc
Kazakhstan, Kyrgyzstan	Модель: WCH-303 Изготовитель: Molex Сделано в Китае Сделано в Мексике Электропитание : 12V 1.8A 
Serbia	 И005 23
Singapore	 Complies with IMDA Standards DB107713
Slovenia	Molex CVS Bochum GmbH potrjuje, da je tip radijske opreme WCH-303 skladen z irektivo 2014/53/EU. Celotno besedilo izjave EU o skladnosti je na voljo na naslednjem spletnem naslovu: http://www.molex.com/doc
Slovakia	Molex CVS Bochum GmbH týmto vyhlasuje, že rádiové zariadenie typu WCH-303 je v súlade so smernicou 2014/53/EÚ. Úplné EÚ vyhlásenie o zhode je k dispozícii na tejto internetovej adrese: http://www.molex.com/doc
South Africa	 ICASA TA-2022/3446 APPROVED



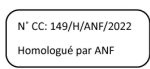
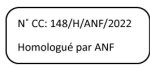

Ukraine	<p>СПРОЩЕНА ДЕКЛАРАЦІЯ ПРО ВІДПОВІДНІСТЬ Molex CVS Vochum GmbH заявляє, що тип радіообладнання WCH-303 відповідає Технічному регламенту радіообладнання; повний текст декларації про відповідність доступний на веб-сайті за такою адресою: http://www.molex.com/doc</p> 
Vietnam	
Zambia	

15.5.7. Door NFC certification

The outer door handle electronics are part of a keyless driver authorisation system using NFC^[1]. The following information relates to legal, health and safety warnings, and/or standards compliance reference.

Model DH421

Concerning region	Product origin	Label image or cert. number	Regulatory compliance	Other
Algeria	China		N° CC: 149/H/ANF/2022 Homologué par ANF	
Algeria	USA		N° CC: 148/H/ANF/2022 Homologué par ANF	
Brazil			Este equipamento não tem direito à proteção contra interferência prejudicial e não pode causar interferência em sistemas devidamente autorizados. Para maiores informações, consulte o site da ANATEL – www.anatel.gov.br	Modelo: DH421
Cambodia	China	RF-TA-2022-0450		TRC identifier (RF-TA-2022-XXXX)

Concerning region	Product origin	Label image or cert. number	Regulatory compliance	Other
Cambodia	USA	RF-TA-2022-0451		
China (Hong Kong)				OFCA label
Indonesia	China			
Indonesia	USA			
Malaysia				

conditionssuivantes: (1) l'appareil ne doit pas produire de brouillage, et (2) l'appareil doit accepter tout brouillage radioélectrique subi, même si le brouillage est susceptible d'en compromettre le fonctionnement.

According 15.21 WARNING: Changes or modifications made to this equipment not expressly approved by WITTE Automotive; WITTE-Velbert GmbH & Co. KG may void the FCC authorization to operate this equipment.

The DH421 (outer door handle electronic) is a part of a Keyless driver authorization system with NFC as a new and additional feature (system will be assembled inside of the outer door handle). The system combines the Keyless-Go feature based on capacitive sensors (lock-/ unlock-/ request-) and the contactless communication standard NFC (Near-Field-Communication at 13.56 MHz). The product is safe with regards to RF exposure to humans of the general public if a distance of 10 cm or more is maintained at all times where there is no intention to trigger the lock function.

 **Warning**

Improper use of vehicle opening can result in serious personal injury. Always take the key (also digital key) with you when you leave the vehicle. The engine can be started and vehicle systems such as the power windows can be operated leading to serious personal injury. Never leave children, disabled persons or anyone who cannot help themselves in the vehicle. The doors can be locked using the remote control key or touching the capacitive lock sensor area of the door handle. This could result in people being trapped in the vehicle in an emergency. For example, depending on the time of year, people trapped in the vehicle can be exposed to very high or low temperatures. Never remove the key from steering lock while the vehicle is moving or while it is rolling to a stop. The steering wheel column will lock up and you will not be able to steer or control the vehicle.

 **Note**

The outer door handle contains electronic components. Protect these from rough handling. Never leave any vehicle keys (also digital keys) inside the vehicle. Entry by unauthorized persons could harm the vehicle or your vehicle could be stolen. Always take the keys with you whenever you leave your vehicle.

^[1] Near field communication

15.5.8. Key systems certification





Here you can find certification for compliance to standards for distance-capable keys and the associated key readers.



Key systems

Country/Region	Homologation type	Compliance	Label
EU Accession State Albania, Andorra, San Marino, Vatican City, Bosnia and Herzegovina, Macedonia, Monaco, Moldova, Montenegro, Turkey, Kosovo, Greenland, Faroe Islands	WAN00, YBN00	<p>UWB Reader (UWBR): Model: WAN00 Manufacturer: DENSO CORPORATION Address: 1-1, Showa-cho, Kariya-shi, Aichi-ken, 448-8661 Japan Operation frequency: CH5: 6240.0 - 6739.2 MHz CH9: 7737.6 - 8236.8 MHz. Maximum output power: -41.3 dBm/MHz or less Radio Frequency Key (RFK) Model: YBN00 Manufacturer: DENSO CORPORATION Address: 1-1, Showa-cho, Kariya-shi, Aichi-ken, 448-8661 Japan UWB Operation frequency: CH5: 6240.0 - 6739.2 MHz. CH9: 7737.6 - 8236.8 MHz. Maximum output power: -41.3 dBm/MHz or less Key system Manufacturer: DENSO CORPORATION Address: 1-1, Showa-cho, Kariya-shi, Aichi-ken, 448-8661 Japan Bluetooth Operation frequency: 2402 - 2480 MHz. Maximum output power: 0 dBm or less NFC Operation frequency: 13.56 MHz Qi Operation frequency: 110 - 205 kHz Hereby, DENSO CORPORATION declares that the radio equipment type is in compliance with Directive 2014/53/EU. The full text of the EU declaration of conformity is available at the following internet address: https://contact-us.denso.com/form/global/en/contact-us/doc/ [https://contact-us.denso.com/form/global/en/contact-us/doc/] DENSO CORPORATION vakuuttaa, että radiolaitetyyppi on direktiivin 2014/53/EU mukainen. EU-vaatusten mukaisuusvakuutuksen täysimittainen teksti on saatavilla seuraavassa internetosoitteessa: https://contact-us.denso.com/form/global/en/contact-us/doc/ [https://contact-us.denso.com/form/global/en/contact-us/doc/] Hierbij verklaar ik, DENSO CORPORATION, dat het type radioapparaat conform is met Richtlijn 2014/53/EU. De volledige tekst van de EU-conformiteitsverklaring kan worden geraadpleegd op het volgende internetadres: https://contact-us.denso.com/form/global/en/contact-us/doc/ [https://contact-us.denso.com/form/global/en/contact-us/doc/] Le soussigné, DENSO CORPORATION, déclare que l'équipement radioélectrique du type est conforme à la directive 2014/53/UE. Le texte complet de la déclaration UE de conformité est disponible à l'adresse internet suivante: https://contact-us.denso.com/form/global/en/contact-us/doc/ [https://contact-us.denso.com/form/global/en/contact-us/doc/] Härmed försäkrar DENSO CORPORATION att denna typ av radioutrustning överensstämmer med direktiv 2014/53/EU. Den fullständiga texten till EU-försäkran om överensstämmelse finns på följande webbadress: https://contact-us.denso.com/form/global/en/contact-us/doc/ [https://contact-us.denso.com/form/global/en/contact-us/doc/] Hermed erklærer DENSO CORPORATION, at radioudstyrstypen er i overensstemmelse med direktiv 2014/53/EU. EU-overensstemmelseserklæringens fulde tekst kan findes på følgende internetadresse: https://contact-us.denso.com/form/global/en/contact-us/doc/ [https://contact-us.denso.com/form/global/en/contact-us/doc/] Hiermit erklärt DENSO CORPORATION, dass der Funkanlagentyp der Richtlinie 2014/53/EU entspricht. Der vollständige Text der EU-Konformitätserklärung ist unter der folgenden Internetadresse verfügbar: https://contact-us.denso.com/form/global/en/contact-us/doc/ [https://contact-us.denso.com/form/global/en/contact-us/doc/] Με την παρούσα ο/η DENSO CORPORATION, δηλώνει ότι ο ραδιοεξοπλισμός πληροί την οδηγία 2014/53/ΕΕ. Το πλήρες κείμενο της δήλωσης συμμόρφωσης ΕΕ διατίθεται στην ακόλουθη ιστοσελίδα στο διαδίκτυο: https://contact-us.denso.com/form/global/en/contact-us/doc/ [https://contact-us.denso.com/form/global/en/contact-us/doc/] Il fabbricante, DENSO CORPORATION, dichiara che il tipo di apparecchiatura radio è conforme alla direttiva 2014/53/UE. Il testo completo della dichiarazione di conformità UE è disponibile al seguente indirizzo Internet: https://contact-us.denso.com/form/global/en/contact-us/doc/ [https://contact-us.denso.com/form/global/en/contact-us/doc/] Por la presente, DENSO CORPORATION declara que el tipo de equipo radioeléctrico es conforme con la Directiva 2014/53/UE. El texto completo de la declaración UE de conformidad está disponible en la dirección Internet siguiente: https://contact-us.denso.com/form/global/en/contact-us/doc/ [https://contact-us.denso.com/form/global/en/contact-us/doc/] O(a) abaixo assinado(a) DENSO CORPORATION declara que o presente tipo de equipamento de rádio está em conformidade com a Diretiva 2014/53/UE. O texto integral da declaração de conformidade está disponível no seguinte endereço de Internet: https://c</p>	

Country/Region	Homologation type	Compliance	Label
		<p>contact-us.denso.com/form/global/en/contact-us/doc/ [https://contact-us.denso.com/form/global/en/contact-us/doc/]</p> <p>B'dan, DENSO CORPORATION, niddikjara li dan it-tip ta' tagħmir tar-radju huwa konformi mad-Direttiva 2014/53/UE. It-test kollu tad-dikjarazzjoni ta' konformità tal-UE huwa disponibbli f'dan l-indirizz tal-Internet li ġej: https://contact-us.denso.com/form/global/en/contact-us/doc/ [https://contact-us.denso.com/form/global/en/contact-us/doc/]</p> <p>Käesolevaga deklareerib DENSO CORPORATION, et käesolev raadioseadmee tüüp vastab direktiivi 2014/53/EL nõuetele. ELi vastavusdeklaratsiooni täielik tekst on kättesaadav järgmisel internetiaadressil: https://contact-us.denso.com/form/global/en/contact-us/doc/ [https://contact-us.denso.com/form/global/en/contact-us/doc/]</p> <p>DENSO CORPORATION igazolja, hogy a típusú rádióberendezés megfelel a 2014/53/EU irányelvnek. Az EU-megfelelőségi nyilatkozat teljes szövege elérhető a következő internetes címen: https://contact-us.denso.com/form/global/en/contact-us/doc/ [https://contact-us.denso.com/form/global/en/contact-us/doc/]</p> <p>Me aně tě kěsajet deklarati, subjekti DENSO CORPORATION deklarati se pajsjet radio eshtē nē pērupthje me kētē rregull teknik pēr pajsjet radio dhe fundore tē komunikimeve elektronike. Teksti i plotē i Deklaratēs sē Konformitetit eshtē i disponueshēm nē adresēn e mēposhtme tē internetit: https://contact-us.denso.com/form/global/en/contact-us/doc/ [https://contact-us.denso.com/form/global/en/contact-us/doc/]</p> <p>Prin prezenta, DENSO CORPORATION declarā cā tipul de echipamente radio este în conformitate cu Reglementarea tehnică „Punerea la dispoziție pe piață a echipamentelor radio”. Textul integral al declarației de conformitate este disponibil la următoarea adresă de Internet: https://contact-us.denso.com/form/global/en/contact-us/doc/ [https://contact-us.denso.com/form/global/en/contact-us/doc/]</p> <p>DENSO CORPORATION týmto vyhlasuje, že rádiové zariadenie typu je v súlade so smernicou 2014/53/EÚ. Úplné EÚ vyhlásenie o zhode je k dispozícii na tejto internetovej adrese: https://contact-us.denso.com/form/global/en/contact-us/doc/ [https://contact-us.denso.com/form/global/en/contact-us/doc/]</p> <p>Tímto DENSO CORPORATION prohlašuje, že typ rádiového zařízení je v souladu se směrnicí 2014/53/EU. Úplné znění EU prohlášení o shodě je k dispozici na této internetové adrese: https://contact-us.denso.com/form/global/en/contact-us/doc/ [https://contact-us.denso.com/form/global/en/contact-us/doc/]</p> <p>DENSO CORPORATION potvrjuje, da je tip radijske opreme skladen z Direktivy 2014/53/EU. Celotno besedilo izjave EU o skladnosti je na voljo na naslednjem spletnem naslovu: https://contact-us.denso.com/form/global/en/contact-us/doc/ [https://contact-us.denso.com/form/global/en/contact-us/doc/]</p> <p>Aš, DENSO CORPORATION, patvirtinu, kad radijo įrenginių tipas atitinka Direktyvą 2014/53/ES. Visas ES atitikties deklaracijos tekstas prieinamas šiuo interneto adresu: https://contact-us.denso.com/form/global/en/contact-us/doc/ [https://contact-us.denso.com/form/global/en/contact-us/doc/]</p> <p>Ar šo DENSO CORPORATION deklarē, ka radioiekārta atbilst Direktīvai 2014/53/ES. Pilns ES atbilstības deklarācijas teksts ir pieejams šādā interneta vietnē: https://contact-us.denso.com/form/global/en/contact-us/doc/ [https://contact-us.denso.com/form/global/en/contact-us/doc/]</p> <p>DENSO CORPORATION niniejszym oświadcza, że typ urządzenia radiowego jest zgodny z dyrektywą 2014/53/UE. Pełny tekst deklaracji zgodności UE jest dostępny pod następującym adresem internetowym: https://contact-us.denso.com/form/global/en/contact-us/doc/ [https://contact-us.denso.com/form/global/en/contact-us/doc/]</p> <p>Hér með lýsir DENSO CORPORATION yfir því að er í samræmi við grunnkröfur og aðrar kröfur, sem gerðar eru í tilskipun 2014/53/EU. Samræmisýfirlýsing er einnig aðgengileg á eftirfarandi vefslóð: https://contact-us.denso.com/form/global/en/contact-us/doc/ [https://contact-us.denso.com/form/global/en/contact-us/doc/]</p> <p>DENSO CORPORATION erklærer at er i overensstemmelse med direktiv 2014/53/EU. Samsvarserklæringen i fulltekst er tilgjengelig på følgende internetadresse: https://contact-us.denso.com/form/global/en/contact-us/doc/ [https://contact-us.denso.com/form/global/en/contact-us/doc/]</p> <p>С настоящото DENSO CORPORATION декларира, че този тип радиосъоръжение е в съответствие с Директива 2014/53/ЕС. Цялостният текст на ЕС декларацията за съответствие може да се намери на следния интернет адрес: https://contact-us.denso.com/form/global/en/contact-us/doc/ [https://contact-us.denso.com/form/global/en/contact-us/doc/]</p> <p>DENSO CORPORATION ovime izjavljuje da je radijska oprema tipa u skladu s Direktivom 2014/53/EU. Cjeloviti tekst EU izjave o sukladnosti dostupan je na sljedećoj internetskoj adresi: https://contact-us.denso.com/form/global/en/contact-us/doc/ [https://contact-us.denso.com/form/global/en/contact-us/doc/]</p>	

Country/Region	Homologation type	Compliance	Label
		<p>Овиме, DENSO CORPORATION изјављује да је радио опрема тип усаглашена са Директивом 2014/53/EU. Цео текст ЕУ декларације о усаглашености доступан је на следећој интернет адреси: https://contact-us.denso.com/form/global/en/contact-us/doc/ [https://contact-us.denso.com/form/global/en/contact-us/doc/]</p> <p>Amb aquest document, DENSO CORPORATION declara que el tipus d'equipament radioelèctric es conforme a la Directiva 2014/53/UE. El text complet de la declaració UE de conformitat està disponible en la següent adreça d'Internet: https://contact-us.denso.com/form/global/en/contact-us/doc/ [https://contact-us.denso.com/form/global/en/contact-us/doc/]</p> <p>İşbu belge; DENSO CORPORATION telsiz ekipmanı tipinin 2014/53/AB sayılı Direktif'e uygun olduğunu beyan eder. AB uygunluk beyanının tam metni aşağıdaki internet adresinde mevcuttur: https://contact-us.denso.com/form/global/en/contact-us/doc/ [https://contact-us.denso.com/form/global/en/contact-us/doc/]</p>	
Georgia	WAN00, YBN00	<p>გადამცემი მოდელი: WAN00 მუშაობის სიხშირე: CH5: 6240.0 - 6739.2 MHz CH9: 7737.6 - 8236.8 MHz. მაქსიმალური გამომავალი სიმძლავრე: -41.3 dBm/MHz ან ნაკლები გადამცემი მოდელი: YBN00 UWB მაქსიმალური გამომავალი სიმძლავრე: -41.3 dBm/MHz ან ნაკლები Bluetooth მუშაობის სიხშირე: 2402 - 2480 MHz მაქსიმალური გამომავალი სიმძლავრე: 0 dBm ან ნაკლები NFC მუშაობის სიხშირე: 13.56 MHz Qi მუშაობის სიხშირე: 110 - 205 kHz მუშაობის სიხშირე: CH5: 6240.0 - 6739.2 MHz CH9: 7737.6 - 8236.8 MHz. მაქსიმალური გამომავალი სიმძლავრე: -41.3 dBm/MHz ან ნაკლები მწარმოებელი: DENSO CORPORATION ათები: 1-1, Showa-cho, Kariya-shi, Aichi-ken, 448-8661 წინამდებარე დეკლარაციით, DENSO CORPORATION ვაცხადებ, რომ რადიომონწყობილობის ტიპი შეესაბამება რადიომონწყობილობის შესახებ ტექნიკური რეგლამენტის მოთხოვნებს. შესაბამისობის დეკლარაციის სრული ტექსტი ხელმისაწვდომია შემდეგ ინტერნეტმისამართზე: https://contact-us.denso.com/form/global/en/contact-us/doc/ [https://contact-us.denso.com/form/global/en/contact-us/doc/]</p>	
Israel	WAN00, YBN00	<p>חל איסור לבצע פעולות במכשיר שיש בהן כדי לשנות את תכונותיו האלחוטיות של המכשיר, ובכלל זה שינויי תוכנה, החלפת אנטנה מקורית או הוספת אפשווח לחיבור לאנטנה חיצונית, בלא קבלת אישור משרד התקשורת, בשל החשש להפרעות אלחוטיות.</p> <p>DENSO : סימן רשום ראה מוצר : שנת ייצור קורא : מוצר UWB)UWB) WAN00 : דגם ראה מוצר : ארץ ייצור חנת המפרים של המוצר : מוצר (RFK) YBN00 : דגם ראה מוצר : ארץ ייצור</p>	

Country/Region	Homologation type	Compliance	Label
Nigeria	WAN00, YBN00	Model:WAN00/YBN00 Connection and use of this communications equipment is permitted by the Nigerian Communications Commission.	
Paraguay	WAN00, YBN00	[Para los vehículos que se venden en Paraguay]. Nombre del proveedor en Paraguay: Rider & Cia. Dirección: Av. José Gervasio Artigas 1945 Altos and Central Asunción, 001202	 <small>NR: 2021-124-0724 DENSO WAN00</small>  <small>NR: 2022-124-0752 DENSO YBN00</small>
Saudi Arabia	WAN00, YBN00	<p>الاسم وبيانات المورد شركة إلكترومين المحدودة العنوان: شارع الأمير سلطان، حي المحمدية، جدة، المملكة العربية السعودية – 23618</p> <p>اسم وبيانات الصانع DENSO CORPORATION 1-1, Showa-cho, Kariya-shi, Aichi-ken, 448-8661, Japan</p> <p>العلامة التجارية DENSO الموديل الصناعي للمنتج WAN00 بلد المنشأ الولايات المتحدة، الصين</p> <p>النطاق أو النطاقات الترددية 6240.0 - 6739.2 MHz 7737.6 - 8236.8 MHz قدرة الخرج القصوى لكل نطاق -41.3 dBm/MHz</p> <p>الاسم وبيانات المورد شركة إلكترومين المحدودة العنوان: شارع الأمير سلطان، حي المحمدية، جدة، المملكة العربية السعودية – 23618</p> <p>اسم وبيانات الصانع DENSO CORPORATION 1-1, Showa-cho, Kariya-shi, Aichi-ken, 448-8661, Japan</p> <p>العلامة التجارية DENSO الموديل الصناعي للمنتج YBN00 بلد المنشأ اليابان</p> <p>النطاق أو النطاقات الترددية UWB 6240.0 - 6739.2 MHz 7737.6 - 8236.8 MHz قدرة الخرج القصوى لكل نطاق -41.3 dBm/MHz</p> <p>النطاق أو النطاقات الترددية Bluetooth 2402 - 2480 MHz قدرة الخرج القصوى لكل نطاق 0 dBm</p> <p>النطاق أو النطاقات الترددية NFC 13.56 MHz</p> <p>النطاق أو النطاقات الترددية Qi 110 - 205 kHz</p>	
Serbia	WAN00, YBN00		 DENSO WAN00, DENSO YBN 00  <small>0011 23</small> DENSO WAN00, DENSO YBN 00

Country/Region	Homologation type	Compliance	Label
United Arab Emirates	YBN00	UAE: ER17320/23 DENSO YBN00	
Ukraine	WAN00, YBN00	<p>UWB Reader (UWBR): модель: WAN00 смугу радіочастот: CH5: 6240.0 - 6739.2 МГц, CH9: 7737.6 - 8236.8 МГц максимальну потужність випромінювання: -41.3 дБм/МГц або менше</p> <p>Radio Frequency Key (RFK): модель: YBN00 UWB смугу радіочастот: CH5: 6240.0 - 6739.2 МГц, CH9: 7737.6 - 8236.8 МГц максимальну потужність випромінювання: -41.3 дБм/МГц або менше</p> <p>Bluetooth смугу радіочастот: 2402 - 2480 МГц максимальну потужність випромінювання: 0 дБм/МГц або менше</p> <p>NFC смугу радіочастот: 13.56 МГц</p> <p>Qi смугу радіочастот: 110 - 205 кГц виробник: DENSO CORPORATION адреса: 1-1, Showa-cho, Kariya-shi, Aichi-ken, 448-8661, Japan справжнім DENSO CORPORATION заявляє, що тип радіообладнання відповідає Технічному регламенту радіообладнання; повний текст декларації про відповідність доступний на веб-сайті за такою адресою: https://www.denso.com/global/en/contact-us/doc/ [https://www.denso.com/global/en/contact-us/doc/]</p>	 
United Kingdom	WAN00, YBN00	<p>UWB Reader (UWBR) Model: WAN00 Manufacturer: DENSO CORPORATION Address: 1-1, Showa-cho, Kariya-shi, Aichi-ken, 448-8661 Japan Operation frequency: CH5: 6240.0 - 6739.2 MHz. CH9: 7737.6 - 8236.8 MHz. Maximum output power: -41.3 dBm/MHz or less Radio Frequency Key (RFK) Model: YBN00</p> <p>Hereby, DENSO CORPORATION declares that the radio equipment type is in compliance with Directive 2014/53/EU. The full text of the EU declaration of conformity is available at the following internet address: https://www.denso.com/global/en/contact-us/doc/ [https://www.denso.com/global/en/contact-us/doc/]</p> <p>Hereby, DENSO CORPORATION declares that the radio equipment type is in compliance with the relevant statutory requirements. The full text of the UK declaration of conformity is available at the following internet address: https://www.denso.com/global/en/contact-us/doc/ [https://www.denso.com/global/en/contact-us/doc/]</p> <p>Manufacturer: DENSO CORPORATION Address: 1-1, Showa-cho, Kariya-shi, Aichi-ken, 448-8661 Japan UWB Operation frequency: CH5: 6240.0 - 6739.2 MHz. CH9: 7737.6 - 8236.8 MHz. Maximum output power: -41.3 dBm/MHz or less Key system Manufacturer: DENSO CORPORATION Address: 1-1, Showa-cho, Kariya-shi, Aichi-ken, 448-8661 Japan Bluetooth Operation frequency: 2402 - 2480 MHz. Maximum output power: 0 dBm or less NFC Operation frequency: 13.56 MHz Qi Operation frequency: 110 - 205 kHz</p>	

Country/Region	Homologation type	Compliance	Label
United States, Puerto Rico	WAN00, YBN00	<p>UWB Reader</p> <p>NOTE: This device complies with part 15 of the FCC Rules. Operation is subject to the following two conditions: (1) This device may not cause harmful interference, and (2) this device must accept any interference received, including interference that may cause undesired operation.</p> <p>Radio Frequency Key</p> <p>NOTE: This device complies with part 15 and part 18 of the FCC Rules. Operation is subject to the following two conditions: (1) This device may not cause harmful interference, and (2) this device must accept any interference received, including interference that may cause undesired operation.</p> <p>This equipment has been tested and found to comply with the limits for a wireless power charger, pursuant to part 18 of the FCC Rules. This equipment generates, uses and can radiate radio frequency energy and, if not installed and used in accordance with the instructions, may cause harmful interference to radio communications. However, there is no guarantee that interference will not occur in a particular installation.</p> <p>If this equipment does cause harmful interference to radio communications, which can be determined by turning the equipment off and on, the user is encouraged to try to correct the interference by one or more of the following measures:</p> <ul style="list-style-type: none"> • Reorient or relocate the receiving antenna. • Increase the separation between the equipment and receiver. • Connect the equipment into an outlet on a circuit different from that to which the receiver is connected. <p>FCC Warning: Changes or modifications not expressly approved by the party responsible for compliance could void the user's authority to operate the equipment.</p> <p>Radiofrequency radiation exposure information: This equipment complies with FCC radiation exposure limits set forth for an uncontrolled environment and meets the FCC radio frequency (RF) Exposure Guidelines as this equipment has very low levels of RF energy.</p>	
Vietnam	WAN00, YBN00	CÔNG TY TNHH SWEDEN AUTO. B2100176	
Zambia	WAN00, YBN00	WAN00 ZMB/ZICTA/TA/2021/12/9 YBN00 ZMB/ZICTA/TA/2023/3/4	

Safety standard for RFK

Country/RegionEU Accession
State

English

Do not expose to excessive heat, such as sunshine, fire, etc., or low temperatures. This may cause explosion or leakage of flammable liquids or gases during use, storage, transportation or disposal. Do not throw battery into fire or hot stove, do not crush or cut mechanically as this may cause explosion. Do not expose the battery to extremely low air pressure at high altitude, which may cause explosion or leakage of flammable liquids or gases.

Swedish

Får inte exponeras för överdriven värme, t.ex. solsken, eld, etc., eller låga temperaturer eftersom detta kan orsaka explosion eller läckage av brandfarliga vätskor eller gaser under användning, lagring, transport och bortskaflande. Kasta inte batteriet i eld eller en het ugn, krossa eller skär det inte mekaniskt eftersom detta kan orsaka explosion. Ackumulatorm får inte utsättas för extremt lågt lufttryck på hög höjd eftersom detta kan orsaka explosion eller läckage av brandfarliga vätskor eller gaser.

Finnish

Älä altista liialliselle kuumuudelle, kuten auringonpaisteelle, tulelle tai vastaavalle; tai alhaiselle lämpötilalle, joka voi aiheuttaa räjähdyksen tai syttyvän nesteen tai kaasun vuotamisen käytön, varastoinnin tai kuljetuksen tai hävittämisen aikana. Älä heitä akkua tuleen tai kuumaan uuniin äläkä purista tai leikkaa akkua mekaanisesti, mikä voi aiheuttaa räjähdyksen. Älä altista äärimmäisen alhaiselle ilmanpaineelle suuressa korkeudessa, mikä voi aiheuttaa räjähdyksen tai syttyvän nesteen tai kaasun vuotamisen.

Danish

Må ikke udsættes for lave temperaturer eller overdreven varme såsom solskin, ild osv., da dette kan forårsage eksplosion eller lækage af brændbare væsker eller gasser under brug, opbevaring, transport og bortskaflelse. Batteriet må ikke smides i ild eller i en varm ovn, det må ikke knuses eller skæres mekanisk, da dette kan forårsage eksplosion. Akkumulatoren må ikke udsættes for ekstremt lavt lufttryk i stor højde, da dette kan forårsage eksplosion eller lækage af brændbare væsker eller gasser.

Dutch

Niet blootstellen aan overmatige hitte zoals zonneschijn, vuur, enz. of lage temperaturen. Dit kan explosie of lekkage van brandbare vloeistoffen of gassen veroorzaken tijdens gebruik, opslag, vervoer of verwijdering. Gooi de batterij niet in het vuur of in een hete oven, plet of knip de batterij niet mechanisch, want dat kan een explosie veroorzaken. Stel de batterij niet bloot aan extreem lage luchtdruk op grote hoogten, wat explosie of lekkage van brandbare vloeistoffen of gassen kan veroorzaken.

German

Nicht übermäßiger Hitze, wie Sonnenschein, Feuer etc., sowie niedrigen Temperaturen aussetzen. Dieses kann zur Explosion oder zum Austreten von entflammenden Flüssigkeiten oder Gasen während des Gebrauchs, der Lagerung, des Transports oder der Entsorgung führen. Batterie nicht ins Feuer oder in einen heißen Ofen werfen, nicht mechanisch zerdrücken oder zerschneiden, da dies zur Explosion führen kann. Den Akku nicht extrem niedrigem Luftdruck in großer Höhe aussetzen, was zur Explosion oder zum Austreten von brennbaren Flüssigkeiten oder Gasen führen kann.

French

Ne pas exposer à une chaleur excessive, comme la lumière du soleil, le feu, etc. ou à de basses températures. Cela peut entraîner une explosion ou une fuite de liquides ou de gaz inflammables pendant l'utilisation, le stockage, le transport ou l'élimination. Ne pas jeter la batterie dans le feu ou dans un four chaud, ne pas l'écraser ou la couper mécaniquement, car cela pourrait entraîner une explosion. Ne pas exposer l'accumulateur à une pression atmosphérique extrêmement faible en haute altitude, ce qui pourrait entraîner une explosion ou une fuite de liquides ou de gaz inflammables.

Greek

Ο φορτιστής να μη εκτίθεται σε υπερβολική ζέση, όπως στον ήλιο, στη φωτιά κλπ., αλλά ούτε σε χαμηλές θερμοκρασίες. Τουτό μπορεί να επιφέρει έκρηξη ή διαρροή φλεγόμενων υγρών ή αερίων κατά τη διάρκεια της χρήσης, της αποθήκευσης, της μεταφοράς ή της διάθεσης απορριμμάτων. Μη ρίχνετε μπαταρίες στη φωτιά ή σε αναμμένο φούρνο, μη συμπιέζετε και μη κόβετε αυτές κατά μηχανικό τρόπο, επειδή τούτο μπορεί να επιφέρει ανάφλεξη μέχρι και έκρηξη. Ο φορτιστής να μη εκτίθεται σε υπερβολικά χαμηλή ατμοσφαιρική πίεση σε μεγάλο ύψος, επειδή τούτο μπορεί να προκαλέσει έκρηξη ή διαρροή φλεγόμενων υγρών ή αερίων.

Slovak

Nevystavujte batériu nadmernému teplu, napríklad slnečnému žiareniu, ohňu atď., ani nízkym teplotám. To môže spôsobiť výbuch alebo únik horľavých kvapalín alebo plynov počas používania, skladovania, prepravy alebo likvidácie. Batériu nevhadzujte do ohňa alebo horúcej pece (rúry), nedrťte ju ani mechanicky nerozrezávajte, pretože to môže spôsobiť výbuch. Nevystavujte batériu extrémne nízkemu tlaku vzduchu vo vysokých nadmorských výškach, ktorý môže spôsobiť výbuch alebo únik horľavých kvapalín alebo plynov.

Latvian

Nepakļaujiet pārmērīgam karstumam, piemēram, saules, uguns iedarbībai vai tamlīdzīgi; vai zemai temperatūrai, kas lietošanas, uzglabāšanas, transportēšanas vai utilizācijas laikā var izraisīt eksploziju vai uzliesmojoša šķidrums, gāzes noplūdi. Akumulatora likšana ugunī, karstā cepeškrāsnī vai mehāniska tā saspišana vai griešana var izraisīt eksploziju. Nepakļaujiet ekstrēmi zemam gaisa spiedienam lielā augstumā, kas var izraisīt eksploziju vai uzliesmojoša šķidrums, gāzes noplūdi.

Czech

Nevystavovat nadměrnému teplu jako je sluneční záření, oheň nebo podobným vlivům, či nízkým teplotám, které by mohly způsobit výbuch, únik hořlavé kapaliny nebo plynu během používání, skladování nebo přepravy či likvidace. Nevyhazovat baterii do ohně nebo horkých kamen, ani ji mechanicky nedrtit nebo nerozřezávat, což může vést k výbuchu. Nevystavovat baterii extrémně nízkému tlaku vzduchu ve velké nadmořské výšce, který může mít za následek výbuch nebo únik hořlavé kapaliny či plynu.

Polish

Nie wystawiać na działanie nadmiernego ciepła, takiego jak światło słoneczne, ogień itp.; lub niską temperaturą, która może spowodować wybuch lub wyciek łatwopalnej cieczy lub gazu podczas użytkowania, przechowywania, transportu lub utylizacji. Nie wrzucać baterii do ognia lub gorącego piekarnika, ani nie poddawać mechanicznemu kruszeniu lub cięciu baterii, co może spowodować wybuch. Nie jest przeznaczona do ekstremalnie niskich ciśnień powietrza powietrza na dużej wysokości, które może spowodować wybuch lub wyciek łatwopalnej cieczy lub gazu.

Slovenian

Ne izpostavljajte niti visokim temperaturam kot je sonce, ogenj in podobno niti nizkim temperaturam, ker lahko pride do eksplozije in uhajanja vnetljive tekočine ali plina med uporabo, shranjevanjem, prevozom ali odlaganjem. Baterije ne odlagajte v ogenj ali vročo pečico, ne je stiskati ali rezati, ker lahko eksplodira. Ne izpostavljajte izjemno nizkemu zračnemu tlaku na visoki nadmorski višini, ker lahko eksplodira ali pa povzroči uhajanje vnetljive tekočine ali plina.

Icelandic

Látið ekki nærri miklum hita svo sem sólskini, eldi eða álíka; eða lágu hitastigi. Það getur valdið sprengingu eða leka á eldfimum vökva eða gasi við notkun, geymslu, flutning eða förgun. Fargið ekki rafhlöðunni með eldi, varast skal að kremja eða skera, það getur valdið sprengingu. Látið ekki vera í

Country/Region

mjög lágum loftþrýstingi í mikilli hæð. Það getur valdið sprengingu eða leka á eldfimum vökva eða gasi.

Lithuanian

Nelaikykite per didelio karščio, pvz., saulės, ugnies ar pan.; arba žema temperatūra, dėl kurios naudojimo, sandėliavimo, transportavimo ar šalinimo metu gali įvykti sprogimas arba degių skysčių ar dujų nuotėkis. Nemeskite akumulatoriaus į ugnį ar įkaitusią orkaitę ir nemeskite akumulatoriaus mechanškai sutraikštyti ar įpjauti, nes tai gali sukelti sprogimą. Nelaikykite labai žemo oro slėgio dideliame aukštyje, nes gali įvykti sprogimas arba degių skysčių ar dujų nuotėkis.

Italian

Non esporre a calore eccessivo come luce solare, fuoco o simili, o a bassa temperatura poiché possono provocare un'esplosione o la fuoriuscita di liquidi o gas infiammabili durante l'uso, lo stoccaggio o il trasporto o lo smaltimento. Non smaltire una batteria nel fuoco o in un forno caldo, né schiacciare o tagliare meccanicamente una batteria, può provocare un'esplosione. Non sottoporre ad una pressione dell'aria estremamente bassa ad alta quota, poiché potrebbe provocare un'esplosione o la fuoriuscita di liquidi o gas infiammabili.

Estonian

Ärge jätke toodet liigse kuumuse (nt otsese päikesekiirguse, leegi vms) või madala temperatuuri mõju kätte. See võib lõppeda kasutamise, ladustamise, transpordi või kõrvaldamise ajal tuleohtliku vedeliku või gaasi plahvatuse või lekkega. Ärge visake akut tulle ega muljuge või lõigake seda, sest see võib põhjustada plahvatuse. Ärge viige suurele kõrgusele või väga madala õhurõhuga keskkonda. See võib lõppeda tuleohtliku vedeliku või gaasi plahvatuse või lekkega.

Spanish

No exponga a calor excesivo como por ejemplo exposición directa al sol, fuego o similar; ni tampoco a bajas temperaturas, que puedan provocar una explosión o la fuga de líquidos o gases inflamables durante el uso, almacenamiento, transporte o desecho de la batería. No arroje la batería al fuego o a un horno caliente, ni la aplaste o corte mecánicamente, ya que puede producir explotar. No someta la batería a una presión de aire extremadamente baja a causa de una gran altitud ya que puede provocar una explosión o la fuga de líquido o gas inflamable.

Hungarian

Ne tegye ki túlzott hőhatásnak, például napsütésnek, tűznek vagy hasonlónak; vagy alacsony hőmérsékletnek ami robbanást vagy gyűlékony folyadék vagy gáz szivárgását okozhatja használat, tárolás, szállítás vagy ártalmatlanítás során. Ne dobja az akkumulátort tűzbe vagy forró sütőbe, és ne tegye mechanikusan összetörni vagy vágni az akkumulátort, mert ez robbanást okozhat. Ne tegye ki rendkívül alacsony légnyomásnak nagy magasságban, ami robbanást vagy gyűlékony folyadék vagy gáz szivárgását okozhatja.

Portuguese

Não expor ao calor excessivo, como sol, fogo, etc., ou baixas temperaturas. Isto pode resultar na explosão ou vazamento de líquidos ou gases inflamáveis durante a utilização, armazenamento, transporte ou eliminação. Não atirar a bateria ao fogo ou forno quente, não a esmagar ou cortar mecanicamente, pois isto pode causar uma explosão. Não expor o acumulador a pressão de ar extremamente baixa a grande altitude, o que pode causar explosão ou vazamento de líquidos ou gases inflamáveis.

Bulgarian

Да не се излага на прекомерна топлина, като слънце, огън или подобни; или на ниска температура. В противен случай това може да доведе до избухване или до изтичане на запалими течности или газове по време на употреба, складиране, преносване или изхвърляне. Не изхвърляйте батерията в огън, нито се опитвайте да я смачкате или срежете. Това може да доведе до избухване. Да не се излага на прекомерно ниско атмосферно налягане на висока надморска височина, което може да доведе до избухване или теч на запалими течности или газове.

Maltese

Tesponix għal sħana eċċessiva bħal xemx, nar jew simili; jew temperatura baxxa, li tista 'tirrizulta fi splużjoni jew it-tnixxija ta' likwidu jew gass li jaqbad waqt l-użu, il-ħażna jew it-trasport jew ir-rimi. Tarmix batterija fin-nar jew f'forn jaħraq, jew tagħti tgħaffiġ jew qtugh mekkaniku ta' batterija, li jista' jirrizulta fi splużjoni. Tghamix suġġett għal pressjoni ta 'arja estremament baxxa f'altitudni għolja li tista' tirrizulta fi splużjoni jew tnixxija ta 'likwidu jew gass li jaqbad.

Romanian

Nu expuneți la căldură excesivă, cum ar fi soarele, focul sau condiții asemanătoare; sau temperatură scăzută, care poate cauza o explozie sau scurgerea de lichid sau gaz inflamabil în timpul utilizării, depozitării, transportului sau eliminării. Nu aruncați bateria în foc sau într-un cuptor încins și nu provocați zdrobirea sau tăierea mecanică a bateriei, care poate duce la explozie. Nu expuneți la presiune extrem de scăzută a aerului la altitudine mare, care poate duce la explozie sau la scurgerea lichidului sau emiterea de gaz inflamabil.

Croatian

Nemojte izlagati visokim temperaturama poput sunca, vatre ili slično, niti niskim temperaturama, koje mogu uzrokovati eksploziju i curenje zapaljive tekućine ili plina tijekom upotrebe, skladištenja, transporta ili odlaganja. Ne odlagati baterije u vatru ili vruću pećnicu, nemojte je stiskati ili rezati, jer može dovesti do eksplozije. Ne izlažite baterije ekstremno niskom tlaku zraka na velikoj nadmorskoj visini, jer može eksplodirati ili izazvati curenje zapaljive tekućine ili plina.

Albanian

Mos e ekspozoni ndaj nxehtësisë së tepërt si rrezet e diellit, zjarrit etj. dhe temperaturave të ulëta. Kjo mund të shkaktoj një shpërthim ose rrjedhje të lëngut ose gazit të ndezshëm gjatë përdorimit, ruajtjes, transportit ose asgjësimit. Mos e hidhni baterinë në zjarr ose në furrë të nxehtë, mos e shtypni ose preni mekanikisht pasi kjo mund të shkaktoj një shpërthim. Mos e ekspozoni baterinë ndaj presionit jashtëzakonisht të ulët të ajrit në lartësi të madhe, gjë që mund të shkaktoj një shpërthim ose rrjedhje të lëngut ose gazit të ndezshëm.

Serbian

Nemojte izložiti izrazito visokim temperaturama (sunčevi zraci, vatra, ili slično) ili izrazito niskim temperaturama. Može doći do eksplozije ili curenja zapaljive tečnosti ili gasa prilikom korišćenja, skladištenja, i otpada. Nemojte odstraniti bateriju u vatru, nemojte je drobiti ili seći, jer može doći do eksplozije. Nemojte izložiti ekstremno niskom vazдушnom pritisku na velikim visinama. Može doći do eksplozije ili curenja zapaljive tečnosti ili gasa.

Catalan

No exposi a una calor excessiva com ara exposició directa al sol, foc o similar; ni tampoc a baixes temperatures, que puguin provocar una explosió o la fuga de líquids o gasos inflamables durant l'ús, l'emmagatzematge, el transport o el rebuig de la bateria. No llenci la bateria al foc o a un forn calent, ni l'aixafi o la talli mecànicament, ja que podria explotar. No sotmeti la bateria a una pressió d'aire extremadament baixa a causa d'una gran altitud, ja que podria provocar una explosió o la fuga de líquid o gas inflamable.

Turkish

Country/Region	
	Güneş ışığı, ateş vb. aşırı ısı ve düşük sıcaklıklara maruz bırakmayınız. Bu durum; kullanım, depolama, nakliye veya imha sırasında yanıcı sıvı veya gazın patlamasına veya sızıntısına neden olabilir. Pili ateşe veya sıcak fırına atmayınız, ayrıca patlamaya neden olabileceğinden mekanik olarak ezmeyin veya kesmeyiniz. Bataryayı yüksek irtifada düşük hava basıncına maruz bırakmayınız, bu durum da patlamaya veya yanıcı sıvı veya gaz sızıntısına neden olabilir.
Georgia	არ გაუშვათ ზედმეტი სიცხე, როგორცაა მზე, ხანძარი და ა.შ., ან დაბალ ტემპერატურაზე. ამან შეიძლება გამოიწვიოს აალებადი სითხეების ან აირების აფეთქება ან გაჟონვა გამოყენების, შენახვის, ტრანსპორტირებისა თუ განადგურების დროს. არ ჩააგდოთ ბატარეა ცეცხლში ან ცხელ ლუმელში, არ დაამტვრიოთ ან გაჭრათ მექანიკურად, რადგან ამან შეიძლება აფეთქება გამოიწვიოს. არ დაუშვათ ბატარეა ჰაერის უკიდურესად დაბალ წნევაზე მაღალ სიმაღლეზე, რამაც შეიძლება გამოიწვიოს აალებადი სითხეების ან აირების აფეთქება ან გაჟონვა.
United Kingdom	Do not expose to excessive heat, such as sunshine, fire, etc., or low temperatures. This may cause explosion or leakage of flammable liquids or gases during use, storage, transportation or disposal. Do not throw battery into fire or hot stove, do not crush or cut mechanically as this may cause explosion. Do not expose the battery to extremely low air pressure at high altitude, which may cause explosion or leakage of flammable liquids or gases.

Battery

Battery TYPE: CP1254 A4 WC

Manufacturer

- Manufacturer Name: VARTA Microbattery GmbH
- Trade Name: VARTA
- Address: VARTA-Platz 1, 73479 Elwangen, Germany
- URL: <https://www.varta-microbattery.com/en> [<https://www.varta-microbattery.com/en>]

Importer

- Importer Name: Volvo Car Corporation
- Trade Name: VOLVO
- Address: 405 31 Göteborg, Sweden
- URL: [volvocars.com](https://www.volvocars.com) [<https://www.volvocars.com>]



15.5.9. Candidate List Substance Information (CL) in accordance with the REACH Regulation, Article 33.1

Volvo Cars supports the underlying goals of the REACH regulation in general, and Article 33 in particular, which are consistent with our own commitment to promote the responsible manufacturing, handling and use of our products.

The content of this manual represents the status of the user manual at the time of printing and may not be completely valid in future instances. For more information, refer to the first page for the complete disclaimer note.

In accordance with Article 33.1 of the REACH Regulation (Reg. EC 1907/2006),^[1] professional customers must be informed of Substances of Very High Concern (SVHC^[2]) in products supplied by Volvo Cars. The intention is to facilitate the safe handling of the constituent components affected in order to protect people and the environment.

Presence of candidate list substances

The articles in the "Candidate List Substances Table" below contain substances at greater than 0.1% w/w in the candidate list (CL) for the specific car. The information on substances in the candidate list (CL) is based on the data obtained from our suppliers and our own product data.

General Safe Use Information for Articles

Every car from Volvo Cars is provided with a user manual, which includes safe use information for owners, drivers and users of the car. Volvo Cars information on the repair and servicing of cars and genuine parts also includes safe use information for service personnel.

Where present in parts of this car, the Candidate List substances shown in the relevant "Candidate List Substances Table" for the specific car are incorporated in such a way that potential exposure to customers as well as risks for people or the environment can be minimised as long as the car and its parts are used as intended, and any repairs, servicing and maintenance are carried out following technical instructions for those activities, and industry standard good practices.

An end-of-life vehicle may only be disposed of legally in the European Union at an Authorised Treatment Facility (ATF). Vehicle parts should be disposed in accordance with locally applicable laws and local authority guidance.

Candidate List Substances Table







More details are available in a PDF file, see Support / Car information / Regulatory information.



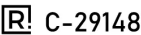







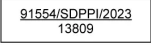
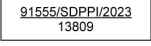

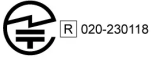
^[1] REACH - The European Union's chemicals legislation, which entered into force on 1 June 2007, Regulation (EC) No. 1907/2006 concerning the Registration, Evaluation, Authorisation and Restriction of Chemicals (REACH).



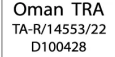

^[2] SVHC - Substances of Very High Concern, which are included in the current candidate list (CL).

15.5.10. Certifications for radio and entertainment system

You can find the certifications and labels for the radio and entertainment system listed here.

Region	Labels and symbols	Specification
Argentina		C-29148
Australia		
Belarus		
Botswana		REGISTERED No: BOCRA/TA/2023/8267
Brazil		20252-23-10187 Atendimento à Regulamentação Anatel Este equipamento não tem direito à proteção contra interferência prejudicial e não pode causar interferência em sistemas devidamente autorizados. Este produto está homologado pela ANATEL, de acordo com os procedimentos regulamentados pela Resolução 242/2000, e atende aos requisitos técnicos aplicados. Para maiores informações, consulte o site da ANATEL www.anatel.gov.br
Brunei		DTA-022618
China		CMIIT ID: 2023DJ11659 [Placeholder text for Chinese regulatory information]
European Union (CE (RED))		Simplified EU declaration of conformity, radio Hereby, Aptiv Services Deutschland GmbH, 42367 Wuppertal, declares that DHU 1.0 is in compliance with Directive 2014/53/EU. The full text of the EU declaration of conformity is available at the following internet address: https://www.aptiv.com/automotive-homologation
Generic		<ul style="list-style-type: none"> • Product name: Display head unit • Model Name: DHU 1.0 • Manufacturer: Aptiv Services Deutschland GmbH, Am Technologiepark 1, 42119 Wuppertal Germany • Brand: Aptiv
Ghana		NCA APPROVED: 7EA-M1-163-SRD
India		ETA-SD-20221210313

Region	Labels and symbols	Specification
Indonesia (SDPPI)	<p>For display head units manufactured in China:</p>  <p>For display head units manufactured in Mexico:</p> 	
Israel		51-88586
Japan (Radio)		020-230118
Japan (Telecom)		D230032020
Malaysia	 	VOLVO CAR MANUFACTURING MALAYSIA SDN. BHD.: HIDF21000141 VOLVO CAR MALAYSIA SDN. BHD.: HIDF15000171
Mexico	<p>IFT: VOAPDH23-39393</p> 	<p>IFT: VOAPDH23-39393</p> <p>La operación de este equipo está sujeta a las siguientes dos condiciones:</p> <p>(1) Es posible que este equipo o dispositivo no cause interferencia perjudicial y</p> <p>(2) Este equipo o dispositivo debe aceptar cualquier interferencia, incluyendo la que pueda causar su operación no deseada.</p> <p>Model Name: DHU 1.0</p> <p>Brand: Aptiv</p>
Morocco		MR 00035090 ANRT 2022
New Zealand		
Oman		TA-R/14553/22 D100428
Paraguay		<p>NR: 2022-10-I-0659</p> <p>Importer: Rieder & Cia.</p> <p>Address: Avda España c/ Dr. Morra.</p> <p>Local phone number of the importer/dealer in Paraguay: +595 021-2190 700</p>
Philippines		ESD-RCE-2231790
Russia (EAC)		

Region	Labels and symbols	Specification
United States of America and Canada		<p>FCC ID: LTQDHU1 IC: 3659A-DHU1 FCC § 15.19 Labelling requirements</p> <p>This device complies with part 15 of the FCC Rules and ISSED license-exempt RSS standard(s). Operation is subject to the following two conditions: (1) This device may not cause harmful interference, and (2) this device must accept any interference received, including interference that may cause undesired operation.</p> <p>Le présent appareil est conforme aux CNR d'ISED applicables aux appareils radio exempts de licence. L'exploitation est autorisée aux deux conditions suivantes: (1) l'appareil ne doit pas produire de brouillage, et (2) l'utilisateur de l'appareil doit accepter tout brouillage radioélectrique subi, même si le brouillage est susceptible d'en compromettre le fonctionnement.</p> <p>FCC § 15.21 Information to user</p> <p>Changes or modifications not expressly approved by the party responsible for compliance could void the user's authority to operate the equipment. NOTE: THE MANUFACTURER IS NOT RESPONSIBLE FOR ANY RADIO OR TV INTERFERENCE CAUSED BY UNAUTHORIZED MODIFICATIONS TO THIS EQUIPMENT. SUCH MODIFICATIONS COULD VOID THE USER'S AUTHORITY TO OPERATE THE EQUIPMENT.</p> <p>RF Exposure Requirements</p> <p>This equipment complies with FCC RF radiation exposure and Industry Canada RSS-102 RF exposure limits set forth for an uncontrolled environment. This device and its antenna must not be co-located or operating in conjunction with any other antenna or transmitter. To comply with FCC RF exposure and Industry Canada RSS-102 RF exposure compliance requirements, this grant is applicable to only Mobile Configurations. The antennas used for this transmitter must be installed to provide a separation distance of at least 20 cm from all persons and must not be co-located or operating in conjunction with any other antenna or transmitter.</p> <p>Cet équipement est conforme aux limites d'exposition aux rayonnements énoncées pour un environnement non contrôlé et respecte les règles d'exposition aux fréquences radioélectriques (RF) CNR-102 de l'IC. Cet équipement doit être installé et utilisé en gardant une distance de 20 cm ou plus entre le radiateur et le corps humain (à l'exception des extrémités : mains, poignets, pieds et chevilles).</p>
Vietnam		<p>Name: BD CONSULTANT Code: A00282014</p>
Zambia		ZMB/ZICTA/TA/2022/10/39
Bluetooth		
Waste		

Frequency bands and output power for European Union CE (RED) certification

Application	Frequency	Maximum output power
FM	87.5-108 MHz	
DAB	174.0-240.0 MHz	
Bluetooth	2400-2483.5 MHz	4 dBm (2.5 mW)
Bluetooth Low Energy	2400-2483.5 MHz	5 dBm (3.2 mW)
WLAN 2.4 GHz	2400-2483.5 MHz	14 dBm (25 mW)
WLAN 5 GHz	5150-5250 MHz	14 dBm (25 mW)
WLAN 5 GHz	5725-5850 MHz	14 dBm (25 mW)

Information for Taiwan (BSMI) certification

□□□□: □□□□ (BT/WLAN)

The content of this manual represents the status of the user manual at the time of printing and may not be completely valid in future instances. For more information, refer to the first page for the complete disclaimer note.

???: DHU 1.0

?: / ?

Connection points description and RoHS table for Taiwan (BSMI) certification

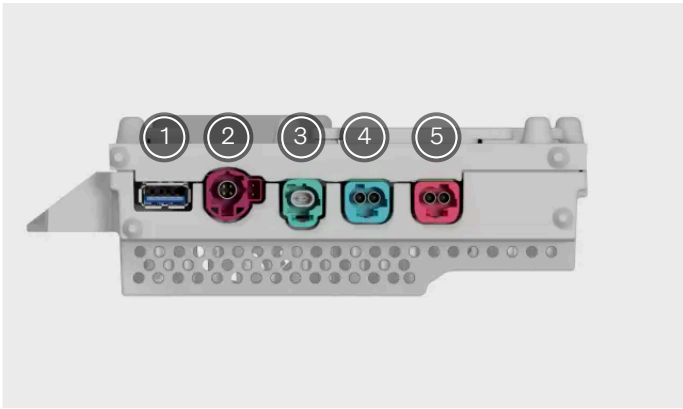

- ① USB Debug
- ② USB 2.0
- ③ (Ethernet)
- ④ (Centre Display Connection)
- ⑤ (Parking Assistance Camera)

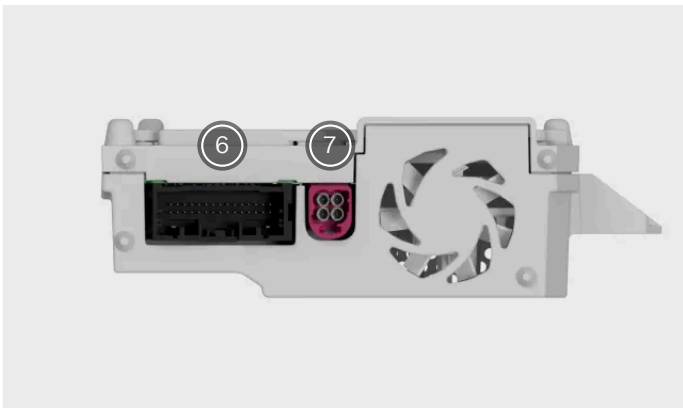

- ⑥ (Main Connector)
- ⑦ FM/DAB

RoHS table						
(BT/WLAN) : DHU 1.0						
	(Pb)	(Hg)	(Cd)	(Cr+6)	(PBB)	(PBDE)
	-	o	o	o	o	o
	-	o	o	o	o	o
	-	o	o	o	o	o
	o	o	o	o	o	o

1. 0.1 wt %
2. 0.01 wt %
3.

15.6. Labels

Your car has a number of labels that provide information about the car and its use, such as specifications and warnings.

Warning label

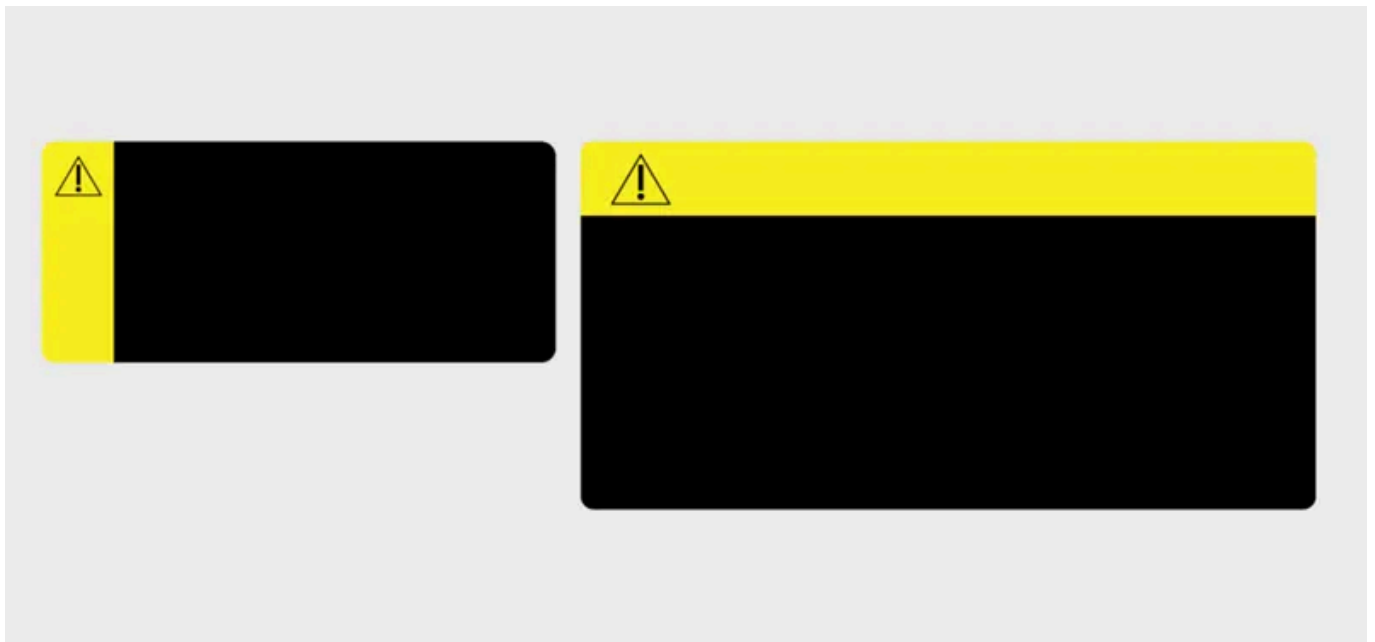

Yellow signal panel with warning symbol.

Indicates a potentially hazardous situation which, if not avoided, could result in death or serious injury.

Notice label



Notice symbol in signal panel.

Indicates a hazardous situation which, if not avoided, could result in minor or moderate damage to property.

Information label



Label with no signal panel.

Indicates important information but no risk for personal injury or damage to property.

 **Note**

Depicted labels

Labels depicted in this manual are generic representations of those found around your car. The manual only contains their location and what kind of information they hold. Find the actual label for specific information about your car.