

# XC40 Mild Hybrid 2025 (24w46) User Manual

Version 2026-04-09

## Disclaimer

Due to the dynamic nature of our software-based product, the content of this PDF represents the most up-to-date version of the user manual as of the time of printing. As we continuously update and improve our product, certain content may not reflect the most up-to-date information in a future instance. Therefore, we strongly recommend utilising the digital user manual app in your car's centre display for the most accurate and up-to-date information. You can also access information in the Volvo Cars mobile app.

Please note that if you choose to print the manual, we cannot guarantee the validity of the information in future instances, as updates may have occurred since the time of printing. To ensure the highest level of safety and optimal product usage, we strongly advise relying on the digital user manual, which can be easily accessed through your car's centre display.

This printable version is generic and does not correspond to your car. If there are discrepancies between this printable manual and the manual you see in your car's centre display, the latter takes precedence.

## Contents

1. [Consumer information](#)
  - 1.1 [About the user manual](#)
    - 1.1.1 [Reading the user manual](#)
  - 1.2 [Customer support and contact information](#)
  - 1.3 [Driver responsibility](#)
  - 1.4 [Modifications, repairs and accessory installations](#)
  - 1.5 [Finding the vehicle identification number](#)
  - 1.6 [Approval of terms and conditions and data collection](#)
  - 1.7 [Handling of recorded and collected data](#)
  - 1.8 [About connected services and fair use policy](#)
  - 1.9 [Changing ownership of the car](#)
  - 1.10 [Resetting user data](#)
  - 1.11 [Recommendations when changing regions](#)
2. [User accounts, profiles and services](#)
  - 2.1 [Setting up your car for the first time](#)
  - 2.2 [Volvo ID](#)
    - 2.2.1 [Creating a Volvo ID](#)
  - 2.3 [Volvo Cars app](#)
  - 2.4 [Getting started with Google services](#)
  - 2.5 [Customisation and settings](#)
  - 2.6 [Car user profiles](#)
    - 2.6.1 [Switching profiles](#)
    - 2.6.2 [Adding a profile](#)
    - 2.6.3 [Removing a profile](#)
    - 2.6.4 [Assigning a key to a profile](#)
    - 2.6.5 [Managing keys assigned to profiles](#)
    - 2.6.6 [Restricting access to a profile](#)
    - 2.6.7 [Adding an account to a profile](#)
  - 2.7 [Volvo Assistance](#)
    - 2.7.1 [Calling Volvo Assistance for roadside assistance](#)
  - 2.8 [Emergency assistance](#)

The content of this manual represents the status of the user manual at the time of printing and may not be completely valid in future instances. For more information, refer to the first page for the complete disclaimer note.

- 2.8.1 Calling emergency services with SOS button
- 2.8.2 Changing emergency call recipient
- 3. Displays, software and phone
  - 3.1 Displays
    - 3.1.1 Centre display
      - 3.1.1.1 Centre display views
      - 3.1.1.2 Status symbols in the centre display
      - 3.1.1.3 Restarting the centre display
      - 3.1.1.4 Keyboard
        - 3.1.1.4.1 Changing keyboard language
        - 3.1.1.4.2 Adding and removing keyboard languages
    - 3.1.2 Driver display
      - 3.1.2.1 Warning and indicator symbols
      - 3.1.2.2 Fuel meter
    - 3.1.3 System settings
      - 3.1.3.1 Changing time and date
      - 3.1.3.2 Changing system language
      - 3.1.3.3 Changing system units
  - 3.2 Phone
    - 3.2.1 Connecting your phone to the car
    - 3.2.2 Using your phone in the car
    - 3.2.3 Switching between paired phones
    - 3.2.4 Apple CarPlay
    - 3.2.5 Android Auto™
  - 3.3 Sound and media
    - 3.3.1 Radio
      - 3.3.1.1 Adding radio favourites
      - 3.3.1.2 Linking DAB and FM stations
    - 3.3.2 Sound settings
    - 3.3.3 Media players
  - 3.4 In-car apps
    - 3.4.1 Downloading apps
    - 3.4.2 Uninstalling apps
  - 3.5 Connectivity and software
    - 3.5.1 Internet connection
      - 3.5.1.1 Connecting to the internet via a Bluetooth-connected phone
      - 3.5.1.2 Connecting to the internet via Wi-Fi
    - 3.5.2 Restarting the car's connectivity module
    - 3.5.3 Over-the-air updates
  - 3.6 Voice control
    - 3.6.1 Using voice control
- 4. Interior comfort and climate
  - 4.1 Interior
    - 4.1.1 Using the wireless charger
    - 4.1.2 Enabling the wireless charger
    - 4.1.3 USB ports
    - 4.1.4 12 V socket
    - 4.1.5 Sun visors
  - 4.2 Climate
    - 4.2.1 Climate controls
      - 4.2.1.1 Activating seat heating
      - 4.2.1.2 Activating the steering wheel heating

- 4.2.2 Climate settings
- 4.2.3 Temperature and air conditioning
  - 4.2.3.1 Activating air conditioning
  - 4.2.3.2 Setting temperature
  - 4.2.3.3 Synchronising temperature
- 4.2.4 Air distribution and climate modes
  - 4.2.4.1 Adjusting air vents
  - 4.2.4.2 Activating auto climate mode
  - 4.2.4.3 Activating manual climate mode
- 4.2.5 Ice, condensation and defrosters
  - 4.2.5.1 Defrosting the front windscreen and windows
  - 4.2.5.2 Activating rear windscreen and wing mirror heating
- 4.2.6 Interior climate when parked
  - 4.2.6.1 Keeping heating active after parking
- 4.2.7 Air quality
  - 4.2.7.1 Air quality indication
  - 4.2.7.2 Air cleaning
  - 4.2.7.3 CleanZone
  - 4.2.7.4 Activating air recirculation
- 4.2.8 Climate system
  - 4.2.8.1 Climate zones
  - 4.2.8.2 Perceived and actual temperature
  - 4.2.8.3 Climate sensors
- 4.3 Windows and glass panes
  - 4.3.1 Operating the windows
  - 4.3.2 Operating the panoramic roof
  - 4.3.3 Pinch protection
  - 4.3.4 Resetting windows
- 4.4 Seats
  - 4.4.1 Front seats
    - 4.4.1.1 Adjusting front seats
    - 4.4.1.2 Saving a preset seat adjustment
  - 4.4.2 Rear seats
    - 4.4.2.1 Adjusting centre rear seat headrest
    - 4.4.2.2 Folding down the outer rear seat headrests
    - 4.4.2.3 Folding down the outer rear seats
    - 4.4.2.4 Rear seat centre armrest
- 4.5 Interior lighting
  - 4.5.1 Adjusting the reading lights
  - 4.5.2 Adjusting interior lights
  - 4.5.3 Disabling interior auto lights
  - 4.5.4 Activating all interior lights
- 5. Safety
  - 5.1 Collision response
  - 5.2 Proper seating
  - 5.3 Seatbelts
    - 5.3.1 Fastening and adjusting seatbelt
    - 5.3.2 Seatbelt reminder
  - 5.4 Airbags
    - 5.4.1 Airbag deployment
    - 5.4.2 Front airbags
      - 5.4.2.1 Disabling and enabling front passenger airbag

- 5.4.3 Side airbags
  - 5.4.4 Inflatable curtains
  - 5.4.5 Airbag maintenance and servicing
  - 5.4.6 Airbag labels
  - 5.5 Child safety
    - 5.5.1 Child restraints
      - 5.5.1.1 Installing child restraints
        - 5.5.1.1.1 Installing child restraints on the outer rear seats
        - 5.5.1.1.2 Installing child restraints on the centre rear seat
        - 5.5.1.1.3 Installing child restraints on the front passenger seat
      - 5.5.1.2 Child restraint anchorage points
        - 5.5.1.2.1 ISOFIX anchorage points
        - 5.5.1.2.2 Top tether anchorage points
        - 5.5.1.2.3 Lower tether anchorage points
      - 5.5.1.3 Recommended child restraints
      - 5.5.1.4 Overview table of suitable locations for child restraints
6. Entry and security
  - 6.1 Keys
    - 6.1.1 Standard key
      - 6.1.1.1 Detachable key blade
    - 6.1.2 Care Key
      - 6.1.2.1 Setting a speed limitation for the Care Key
    - 6.1.3 Key tag
    - 6.1.4 Replacing the standard key's battery
  - 6.2 Opening and closing
    - 6.2.1 Opening the bonnet
    - 6.2.2 Closing the bonnet
    - 6.2.3 Boot access
      - 6.2.3.1 Opening the boot hands-free
      - 6.2.3.2 Adjusting boot opening height
  - 6.3 Locking and unlocking
    - 6.3.1 Keyless locking and unlocking
    - 6.3.2 Locking and unlocking using the key buttons
    - 6.3.3 Locking and unlocking using the detachable key blade
    - 6.3.4 Locking and unlocking from inside the car
    - 6.3.5 Activating child lock
    - 6.3.6 Settings for locking and unlocking
      - 6.3.6.1 Adjusting locking and unlocking settings
  - 6.4 Anti-theft
    - 6.4.1 Alarm
      - 6.4.1.1 Activating and deactivating the alarm
      - 6.4.1.2 Reducing the alarm sensitivity
7. Refuelling
  - 7.1 Refuelling your car
  - 7.2 Fuel/Petrol information
8. Driving
  - 8.1 Trips app
  - 8.2 Starting the car
    - 8.2.1 Start-up checks
    - 8.2.2 Alcohol lock
  - 8.3 Turning the car off

- 8.4 Driving characteristics
  - 8.4.1 Drive modes
    - 8.4.1.1 Selecting a drive mode
  - 8.4.2 Using the launch feature
  - 8.4.3 Activating start and stop
  - 8.4.4 Stability control
  - 8.4.5 Suspension
- 8.5 Range
  - 8.5.1 Trip meter
    - 8.5.1.1 Resetting the trip meter
- 8.6 Steering
  - 8.6.1 Steering wheel
    - 8.6.1.1 Steering wheel controls
    - 8.6.1.2 Adjusting the steering wheel position
  - 8.6.2 Adjusting steering feel
- 8.7 Brakes
  - 8.7.1 Foot brake
  - 8.7.2 Parking brake
    - 8.7.2.1 Engaging the parking brake
  - 8.7.3 Auto hold
    - 8.7.3.1 Enabling auto hold
  - 8.7.4 Post-impact braking
- 8.8 Gearbox
  - 8.8.1 Selecting gear
  - 8.8.2 Shifting gears manually
- 9. Visibility, mirrors and exterior lights
  - 9.1 Exterior lights
    - 9.1.1 Driving lights
      - 9.1.1.1 Operating the driving lights
      - 9.1.1.2 High beam
      - 9.1.1.3 Passing beam
        - 9.1.1.3.1 Activating the passing beam
        - 9.1.1.3.2 Cornering lights
      - 9.1.1.4 Activating the front fog lights
      - 9.1.1.5 Activating the rear fog light
      - 9.1.1.6 Activating the position lights
      - 9.1.1.7 Re-orientating lights to local traffic
      - 9.1.1.8 Hazard warning lights
        - 9.1.1.8.1 Activating the hazard warning lights
    - 9.1.2 Operating the direction indicators
    - 9.1.3 Exterior convenience lights
      - 9.1.3.1 Greeting lights
        - 9.1.3.1.1 Enabling the greeting lights
      - 9.1.3.2 Guidance light
        - 9.1.3.2.1 Activating the guidance light
  - 9.2 Mirrors
    - 9.2.1 Enabling automatic dimming
    - 9.2.2 Adjusting wing mirrors
    - 9.2.3 Folding wing mirrors
    - 9.2.4 Resetting wing mirrors' positions
  - 9.3 Wipers and washers
    - 9.3.1 Controlling front wipers

9.3.2 Controlling rear wiper

9.3.3 Activating washers

## 10. Driver support and navigation

### 10.1 Navigation

10.1.1 Finding and selecting a navigation destination

### 10.2 Detection of surroundings and traffic

10.2.1 Locations of cameras, sensors and radars

10.2.2 Camera detection and limitations

10.2.3 Radar detection and limitations

10.2.4 Parking sensor detection and limitations

### 10.3 Driver behaviour detection

### 10.4 Safety interventions and warnings

10.4.1 Collision warnings and mitigation

10.4.2 Interventions and warnings when reversing

10.4.2.1 Alerts about traffic crossing behind the car

10.4.2.2 Disabling automatic braking when reversing

10.4.3 Lane keeping aid

10.4.3.1 Adjusting lane keeping aid

10.4.4 Blind spot information

10.4.5 Driver alert

10.4.5.1 Disabling distraction alert notifications

10.4.6 Connected safety

10.4.6.1 Enabling connected safety

10.4.7 Ready to drive notification

10.4.7.1 Enabling ready to drive notification

### 10.5 Assisted driving

10.5.1 Road signs and speeding response

10.5.1.1 Speed limit warnings

10.5.1.1.1 Disabling Intelligent Speed Assist

10.5.1.1.2 Adjusting speed limit warnings

10.5.1.2 Enabling sound alerts for speed limit changes

10.5.1.3 Enabling sound alerts for speed cameras

10.5.1.4 Road sign information

10.5.1.4.1 Enabling road sign information

10.5.2 Pilot Assist

10.5.2.1 Pilot Assist communication and status

10.5.2.2 Activating Pilot Assist

10.5.2.3 Deactivating Pilot Assist

10.5.2.4 Adaptive cruise control

10.5.2.5 Switching between Pilot Assist and adaptive cruise control while driving

10.5.2.6 Adjusting the target speed for Pilot Assist

10.5.2.7 Adjusting the time interval to vehicles ahead

10.5.2.8 Selecting Pilot Assist as default driver support

10.5.2.9 Pilot Assist conditions and limitations

### 10.6 Assisted parking

10.6.1 Parking view

10.6.1.1 Disabling assisted parking sound alerts

## 11. Scenarios and driving recommendations

### 11.1 Cold conditions

11.1.1 Winter driving recommendations

### 11.2 Wading recommendations

### 11.3 Preparations for a long trip

The content of this manual represents the status of the user manual at the time of printing and may not be completely valid in future instances. For more information, refer to the first page for the complete disclaimer note.

- 12. Storage, stowing and towing
  - 12.1 Passenger compartment storage
    - 12.1.1 Glove box
  - 12.2 Boot space and storage
    - 12.2.1 Parcel shelf
      - 12.2.1.1 Removing and storing the parcel shelf
    - 12.2.2 Removing the cargo hatch
    - 12.2.3 Installing the safety net
    - 12.2.4 Opening the ski hatch
    - 12.2.5 Stowing cargo in the boot
      - 12.2.5.1 Accessing the cargo hold
  - 12.3 Towing a trailer
  - 12.4 Recommendations for loading
- 13. Care and maintenance
  - 13.1 Car status
  - 13.2 Exterior cleaning and care
    - 13.2.1 Washing the exterior by hand
    - 13.2.2 Washing the car in an automatic car wash
    - 13.2.3 Polishing and waxing
    - 13.2.4 Touching up paintwork damage
      - 13.2.4.1 Finding the paint colour code
    - 13.2.5 Windscreen damage
    - 13.2.6 Refilling washer fluid
    - 13.2.7 Cleaning wipers
    - 13.2.8 Replacing front wiper blades
    - 13.2.9 Replacing the rear wiper blade
    - 13.2.10 Activating the wiper service position
    - 13.2.11 Corrosion protection
  - 13.3 Interior cleaning and care
    - 13.3.1 Cleaning fabrics and textiles
    - 13.3.2 Cleaning leather or vinyl
    - 13.3.3 Cleaning glass and glossy surfaces
    - 13.3.4 Cleaning interior plastic, metal and wood components
    - 13.3.5 Cleaning mats
  - 13.4 Wheels and tyres
    - 13.4.1 Wheel and tyre recommendations
      - 13.4.1.1 Tyres and wheel storage
      - 13.4.1.2 Tyre economy
    - 13.4.2 Designations on tyre sidewall
      - 13.4.2.1 Tyre tread wear indicators
    - 13.4.3 Changing wheels
      - 13.4.3.1 Spare wheel
      - 13.4.3.2 Winter tyres
      - 13.4.3.3 Using snow chains
    - 13.4.4 Punctures
      - 13.4.4.1 Temporary puncture repair
        - 13.4.4.1.1 Using the temporary puncture repair kit
        - 13.4.4.1.2 Inflating tyre with the puncture repair compressor
    - 13.4.5 Tyre pressure
      - 13.4.5.1 Tyre pressure monitoring
        - 13.4.5.1.1 Saving a new reference value for tyre pressure monitoring
      - 13.4.5.2 Adjusting tyre pressure

- 13.5 [Engine compartment](#)
  - 13.5.1 [Engine cooling system](#)
    - 13.5.1.1 [Refilling engine coolant](#)
  - 13.5.2 [Engine oil](#)
    - 13.5.2.1 [Refilling engine oil](#)
- 13.6 [Car electrics and batteries](#)
  - 13.6.1 [12 V battery](#)
    - 13.6.1.1 [Battery labels](#)
  - 13.6.2 [48 V battery](#)
  - 13.6.3 [Battery recycling](#)
  - 13.6.4 [Fuses](#)
    - 13.6.4.1 [Replacing a fuse](#)
    - 13.6.4.2 [Fuse box under the bonnet](#)
    - 13.6.4.3 [Fuse box underneath the left front seat](#)
- 13.7 [Replacing light bulbs](#)
  - 13.7.1 [Replacing rear fog light bulb](#)
  - 13.7.2 [Replacing rear indicator light bulb](#)
  - 13.7.3 [Replacing brake light bulb](#)
- 13.8 [Tools and equipment](#)
  - 13.8.1 [Using a warning triangle](#)
  - 13.8.2 [Attaching the towing eye](#)
- 13.9 [Raising the car](#)
  - 13.9.1 [Workshop lifting areas](#)
- 13.10 [Servicing and repairs](#)
  - 13.10.1 [Booking service or repairs](#)
  - 13.10.2 [On-board diagnostic port](#)
- 14. [Immobilised car and recovery](#)
  - 14.1 [Damaged car](#)
  - 14.2 [Malfunction](#)
  - 14.3 [Powerless or unresponsive car](#)
    - 14.3.1 [Jump starting your car](#)
  - 14.4 [Recovery](#)
  - 14.5 [Safety mode](#)
  - 14.6 [Having your car towed](#)
- 15. [Specifications](#)
  - 15.1 [General car characteristics](#)
    - 15.1.1 [Car dimensions](#)
    - 15.1.2 [Weights](#)
    - 15.1.3 [Towing specifications and capabilities](#)
    - 15.1.4 [Towbar specifications](#)
    - 15.1.5 [Type designations](#)
  - 15.2 [Powertrain specifications](#)
    - 15.2.1 [Engine specifications](#)
    - 15.2.2 [Fuel consumption and CO2 emissions](#)
    - 15.2.3 [Fuel tank volume](#)
  - 15.3 [Wheel and tyre specifications](#)
    - 15.3.1 [Approved tyre pressure](#)
    - 15.3.2 [Approved wheel and tyre sizes](#)
    - 15.3.3 [Minimum permitted load index and speed rating for tyres](#)
  - 15.4 [Fluid specifications](#)
    - 15.4.1 [Engine oil specifications](#)
    - 15.4.2 [Transmission fluid specifications](#)

- 15.4.3 Brake fluid specifications
- 15.4.4 Climate system specifications
- 15.5 Certificates and type approvals
  - 15.5.1 Type approvals for radar
  - 15.5.2 Type approvals for radio equipment
  - 15.5.3 Type approvals for wireless charger and NFC
  - 15.5.4 Type approval for on-board diagnostics port
  - 15.5.5 Type approval for anti-theft systems
  - 15.5.6 Key systems certification
  - 15.5.7 Candidate List Substance Information (CL) in accordance with the REACH Regulation, Article 33.1
  - 15.5.8 Driver display licence agreements
  - 15.5.9 Detailed information for child restraint manufacturers
  - 15.5.10 Table for location of child seats using the car's seatbelts
  - 15.5.11 Table for location of i-Size child seats
  - 15.5.12 Table for location of ISOFIX child seats
- 15.6 Labels

# 1. Consumer information

There's a lot to learn about your Volvo. This section covers some essential topics, such as where you can find support if you need it and information about certain consumer rights and responsibilities.



Tip

## Where to start?

Technically, the whole manual is recommended reading for anyone new to the car. However, you can start by reading the information about how this manual works so you know how to find what you need.

## Driver responsibility

The information about driver responsibility is also a good place to start reading. It covers some general principles for safe use of the car and its features.

## 1.1. About the user manual

Learn about how the user manual applies to your car's use, where you can find it and how to navigate its content.

### An important part of your car

Your car is a highly advanced product. However, as a well-designed product, advanced doesn't have to mean it's difficult to use. The aim here is to give you an intuitive experience, with natural interactions that work for both driver and passenger alike. This manual is designed to be a part of the car, giving you information for safe and effective use. It's your resource on the car's functions and features.



Tip

## New user

If you are new to this car, take some time to explore the different areas in the manual. Knowing the car's capabilities and limitations is your responsibility and a necessity for safe and effective use.

### Keep the manual up to date

Make sure that you keep the manual up to date by always having the latest version. Take a look any time a software update introduces changes or new features.

### A guide to your car's intended use

The manual establishes the car's intended use, as defined by Volvo. Whenever you are directed to the manual, consider it an instruction to make absolutely sure that you are using the car as intended. This is the recommendation, as both the descriptive and prescriptive parts of the manual provide important knowledge that contributes to safe and effective use.

**The content of this manual represents the status of the user manual at the time of printing and may not be completely valid in future instances. For more information, refer to the first page for the complete disclaimer note.**

**Note**

### Intended use

If you use the car in a manner which Volvo has not intended, it can negatively affect how it works. This includes shortening the car's service life and limiting your ability to use the car safely and effectively. It may also affect the validity of the vehicle warranty.

Volvo is not the only authority that defines proper use of the car. It is your responsibility to use the car in accordance with local laws and restrictions.

## Accuracy in representing your car

The primary goal is that this manual accurately describes how your car works. However, certain differences between produced cars are not reflected in the manual, such as the colours, materials and certain equipment.

**Note**

Cars are equipped and adapted to meet specific market needs as well as local legislation and requirements. Certain regional variations in configuration may not be reflected in the manual's content.

## Where to find the manual

Your car's user manual is available as an app in the car's display, via the mobile app for the car and at [volvocars.com/intl/support](https://www.volvocars.com/intl/support) [<https://www.volvocars.com/intl/support>].

**Note**

### Volvo's support site

The version of the user manual on Volvo's support site is for a fully-equipped car with all of the available options, functions and features. Therefore, it may differ from this user manual due to what's available in your car.<sup>[1]</sup>

### Printed supplements

The manual is fully digital, but a selection of its content may be included with your car as a printed supplement. The inclusion of printed supplements depends on region and how your car is configured.

## Applicability

 **Important**

- Maintain and handle the car according to Volvo's recommendations in the user manual. Volvo accepts no responsibility for damage or accidents if you disregard the instructions in this manual.
- It is recommended that you read all the user information before you drive for the first time.
- If you find information through other channels, such as the Volvo website, that differs from the information in your car, it is always the user information in the car's display that is valid.
- Volvo works continuously to improve the quality of the user information and make it more accessible and useful. This means that descriptions and illustrations may change. Volvo reserves the right to make changes without prior notice.
- The original version of this user manual is written in British English. Therefore, there may be certain differences between the descriptions in the manual and the actual car.
- The descriptions in this manual are based on general usage conditions. Remember that they can change depending on location, environment and driving behaviour.
- No illustrations or texts in this manual may be copied without permission from Volvo.

<sup>[1]</sup> Availability may vary between regions and equipment levels.

---

## 1.1.1. Reading the user manual

Learn how this user manual's content is organised so that you can find what you need, when you need it.

Your car's user manual is designed to guide you, both when you're looking for a specific piece of information and when you're simply exploring to learn more about your car.

### Structure

This manual is a large network of informational pages. Each page has its own content and might have a list of links that take you to related pages. The links can take you to sub-sections of the one you're in or to other sections with a connection to what you're currently reading.

 **Tip**

#### Find the right level of information

Sometimes the answer to what you're looking for might not lie in the details. Moving up a level or two in the structure might provide the context and perspective you need, or just a better idea of where to look.

#### Search for information

You can use the search field for quicker access to what you are looking for.

#### All main areas

To get you started, the related information links on this page include all of the main sections in this user manual.

## Navigate through interactive images

Some of the manual's pages have images with interactive markers. You can tap these markers to reveal links to relevant parts of the manual. These interactive markers allow you to explore the user manual in a more visual way.



**Tip**

### Animated introductions

Some pages show a short animation as an introduction. This provides you with a few visual hints of what you can expect to find in that part of the user manual.

## Images and videos

Images in the user manual are sometimes schematic and intended to give an overview or an example. Images can differ from your car due to equipment level or market requirements.

## Highlighted content

You can find content that is highlighted in various ways throughout this user manual.



**Warning**

Content highlighted like this primarily informs of conditions or use with obvious potential to cause severe harm to health.



**Important**

Content highlighted like this primarily informs of conditions or use with a clear potential to cause material damage.



**Note**

Content highlighted like this primarily contains information that can help avoid incorrect use, or information that is easily missed or misunderstood.



**Tip**

Content highlighted like this primarily provides tips for use or where to find related content.

## Equipment, accessories and features

Some equipment, accessories and features might be limited or only available for certain car configurations or markets. Even if the information is available to you, it does not guarantee that the specific equipment, accessory or feature described is available in your car.

 **Note**

There may be differences in terminology between the manual and materials for marketing, sales and advertisements.

For more information on standard and optional equipment, contact Volvo support.

---

## 1.2. Customer support and contact information

Should you have any questions regarding your car, you can find answers or solutions in a number of places. In addition to searching the user manual you are reading now, you can visit Volvo's website, Volvo's support site or contact Volvo Assistance.

### Website and support site

Volvo's website [volvocars.com](https://www.volvocars.com) [<https://www.volvocars.com>] has several customer support resources.

The support section [volvocars.com/intl/support](https://www.volvocars.com/intl/support) [<https://www.volvocars.com/intl/support>] provides contact information, software news and answers to frequently asked questions. You can also find your closest Volvo dealer or contact Volvo via phone or chat.

### Volvo Assistance

Volvo Assistance can offer help in the event of a breakdown or if your car unexpectedly becomes immobilised. This includes roadside assistance. Volvo Assistance is available 24 hours a day, 7 days a week.

Press the assist button  in the car's ceiling or use the mobile app for the car to contact Volvo Assistance.

---

## 1.3. Driver responsibility

As a driver, you are responsible for doing everything possible to ensure your own safety as well as that of your passengers and other road users.

Your knowledge, decisions and actions determine how safely you drive. Your car has features that, in certain situations, can compensate for mistakes and lapses in judgement. However, they do not change where the responsibility lies. They are a supplement to good driver practices, which you are responsible for as a driver.

You have likely studied and trained to ensure you have the necessary knowledge and abilities to be a safe driver. This section covers a few essentials you may recognise, such as:

- Driving and using driver support functions
- Knowing the car's capabilities and limitations
- Driver distraction
- Driver fatigue
- Laws and regulations

**The content of this manual represents the status of the user manual at the time of printing and may not be completely valid in future instances. For more information, refer to the first page for the complete disclaimer note.**

## Driving and using driver support functions

You are responsible for adapting your driving to the current conditions, even when using driver support functions. This includes adapting your distance to other vehicles and speed as well as being ready to react to traffic and road hazards. The car's safety interventions and warnings rely on accurate detection and identification of surrounding traffic and road conditions. The detection systems cannot handle all driving, traffic, weather and road conditions.

### Note

#### Driver support

Driver support functions can assist you with certain driving tasks and improve driving awareness. When used correctly, they can improve safety and convenience, but they are not a replacement for safe driving practices. Drive the car with the same attention to safety as required by a car without these functions.

## Knowing the car's capabilities and limitations

Before driving, all drivers are recommended to familiarise themselves with the car and any functions and features they might use. The driver has a responsibility to ensure they have sufficient knowledge of the car to use it safely.

If you are uncertain about any of the car's functions or have questions about its intended use, consult the manual. If you can't find the information you need, contact Volvo support.

## Driver distraction

Distractions reduce your attentiveness and focus when driving. As a driver, you are always responsible for assessing whether a task is safe to perform. Your assessment should take the situation as a whole into account, as well as specific conditions and circumstances that can cause distraction. It might be safe to adjust the volume when you're driving on a straight empty road, but not in more demanding situations such as when overtaking.

### Warning

#### Avoid distractions

Any task that prevents you from keeping your attention on the road and surrounding traffic should only be performed when the car is parked. A few examples include:

- Do not hold your phone while driving. Local laws often restrict or forbid phone use while driving.
- Do not manually change the navigation route while driving.
- Do not change detailed sound settings while driving.

#### Driver responsibility and safety features

Your car has several safety features designed to reduce the risk of an accident. They do not reduce the driver's responsibility to remain attentive, nor the need to operate the car as safely as possible.



Tip

### Help from passengers

Tasks that risk distracting the driver can often be done by a passenger instead. However, certain actions are simply not available in the car when driving, such as reading this manual in the centre display. For these actions, you need to be parked.

### Voice commands

Voice commands can, in some situations, be less distracting than manually doing the same task.

## Driver fatigue

The driver is always responsible for being well-rested. Your car has some functions with abilities to warn you if you show signs of fatigue. It's important to always stop and take a break at the slightest feeling of fatigue, regardless of whether a function has given you a warning.

## Laws and regulations

The driver is always responsible for knowing and following local laws and regulations. If you drive to a region with other traffic laws, make sure that the car is equipped as required and read up on which traffic laws differ from what you're used to.

---

# 1.4. Modifications, repairs and accessory installations

Modifications<sup>[1]</sup>, repairs and installation of accessories or extra equipment requires proper knowledge and quality of both work and parts. Otherwise, they risk impairing your car's functionality and safety. Contact a Volvo dealer before making any alterations to your car.

For any alterations<sup>[2]</sup> to the car, Volvo strongly recommends that:

- you seek prior advice of a trained and qualified Volvo service technician.
- work is only carried out by trained and qualified Volvo service technicians.
- installed parts and accessories are approved by Volvo.<sup>[3]</sup>
- parts and accessories are fitted according to their installation instructions.
- they comply with local laws and regulations.<sup>[4]</sup>

Contact a Volvo dealer for more information.

 **Warning**

### Systems can be negatively affected

Unapproved or incorrectly installed accessories can negatively affect your car's performance, communication and safety systems. Certain accessories only work with associated software that needs to be installed in the car.

### Electrical installations

For additional electrical installations, it is essential that appropriate connection points are used to ensure the integrity of the car's electrical system. The car has a specific ground attachment point designated for aftermarket installations, which is separate from those reserved for critical components. Volvo recommends an authorised Volvo workshop for any electrical installations.

### End-of-life handling

Some parts of the car are dangerous to handle. Special handling is required when servicing, or scrapping after the car has reached its end-of-life.

- Electrical components in the car<sup>[5]</sup> may contain harmful substances and can deliver lethal electrical currents if handled incorrectly.
- Components such as airbag modules, seatbelt tensioners, adaptable steering columns and button cell batteries may contain perchlorate materials.

 **Note**

### Non-approved changes and liability

Volvo does not accept any liability for damage, incurred cost, personal injury or death that is caused by changes to the car<sup>[6]</sup> not approved by Volvo.

<sup>[1]</sup> Modifications include changes to the car's software, including but not limited to tuning.

<sup>[2]</sup> Meaning modifications, repairs and installation of accessories and extra equipment.

<sup>[3]</sup> Accessories that are not approved by Volvo may not have been specifically tested for use with your car.

<sup>[4]</sup> Applies to both the act of making the alteration and subsequent use of the altered car.

<sup>[5]</sup> Such as batteries

<sup>[6]</sup> Including but not limited to modification, repair and installation of accessories or extra equipment.

## 1.5. Finding the vehicle identification number

There are several ways to find your car's unique vehicle identification number.<sup>[1]</sup> You might need your car's VIN if you contact Volvo about any questions or problems regarding your car.

Find the number in one of the following ways:

- In the centre display.

**The content of this manual represents the status of the user manual at the time of printing and may not be completely valid in future instances. For more information, refer to the first page for the complete disclaimer note.**

- On a label on the dashboard, close to the windscreen's lower edge. It can typically be read from outside the car.
- In the car's registration documentation.
- By contacting a service technician who can retrieve it through the on-board diagnostics socket.

#### In the centre display

1. Press the car symbol  in the bottom bar and go to **Settings**.
2. Go to **System** → **About** → **VIN number**.

<sup>[1]</sup> VIN

---

## 1.6. Approval of terms and conditions and data collection

You will see messages about different terms and conditions and data collection <sup>[1]</sup> in the centre display. Your agreement is necessary for certain apps and services to work properly.

The first time you use your car, a guide opens in the centre display to assist you to make various settings. In connection with the guide, you are prompted to give your agreement to different types of terms and conditions and collection of information. You can do this later in privacy settings as well.

You may also need to give your consent in other situations, such as when you:

- Use an app or service for the first time.
- Add a new profile.
- Delete a profile.
- Change the ownership of the car.
- Reset user data or do a factory reset.

If you decide not to accept privacy settings, you may not experience full functionality from apps and services.

#### Manage privacy settings

1. Press the car symbol  in the bottom bar and go to **Settings**.
2. Go to **Privacy**.
3. Select the privacy setting you want to change and follow the instructions in the centre display.

 **Note**

### Sharing data with Volvo

You can manage your consent to sharing data with Volvo in privacy settings.

### Before using the internet

The terms of use must be accepted once per car in order to use the internet.

### Car location sharing

You need to enable location sharing in your car to use certain apps and functions. For example, location sharing is required to use remote vehicle services via Volvo Assistance and for apps such as Find my car and the Trips app.<sup>[2]</sup> Map features also rely on location sharing. If you disable location sharing via the privacy settings, location sharing is also disabled for any features or apps that use it.

 **Note**

### General Privacy Notice

Depending on your market, Volvo Cars may collect and process different types of personal data for various purposes. You can find more information about how Volvo Cars processes your personal data in the Volvo Cars Privacy General Privacy Notice available at Volvo's website. If there are any differences between the user manual and the privacy notice related to the processing of personal data, the privacy notice takes precedence.

<sup>[1]</sup> Data is collected to provide better car, safety and app functions.

<sup>[2]</sup> The Trips app can then collect data such as the car's position, speed, mileage and power consumption.

---

## 1.7. Handling of recorded and collected data

Certain information about the car's status and operation is recorded and collected for quality and safety reasons. This can provide an understanding of the circumstances around traffic accidents involving the car and other usage scenarios.

### Event Data Recorder (EDR)

This vehicle is equipped with an Event Data Recorder. Its primary purpose is to register and record data related to traffic accidents or collision-like situations, such as times when the airbag deploys or the vehicle strikes an obstacle in the road. The data is recorded in order to increase understanding of how vehicle systems work in these types of situations. The EDR is designed to record data related to vehicle dynamics and safety systems for a short time, usually 30 seconds or less.

The EDR in this car is designed to record data related to the following in the event of traffic accidents or collision-like situations:

- How the various systems in the car worked.

- Whether the driver and passenger seatbelts were fastened or tensioned.
- The driver's use of the accelerator or brake pedal.
- The travel speed of the car.

This creates a better understanding about the circumstances in which traffic accidents, injuries and damage occur. The EDR only records data when a non-trivial collision situation occurs. The EDR does not record any data during normal driving conditions. Similarly, the system never registers who is driving the vehicle, or the geographic location of the accident or collision-like situation. However, other parties, such as the police, could use the recorded data in combination with the type of personally identifiable information routinely collected after a traffic accident. Special equipment and access to either the car or the EDR is required to be able to interpret the registered data.

## Additional recorded data

In addition to the EDR, the car is equipped with a number of computers designed to continually check and monitor the function of the car. They can record data during normal driving conditions, but in particular register faults affecting the car's operation and functionality, or upon activation of the car's active driver support function.

Some of the recorded data is required to enable service and maintenance technicians to diagnose and remedy any faults that occurred in the car. The registered information is also needed to enable Volvo to satisfy legal requirements laid out in laws and by government authorities. Information registered in the car is stored in its computer until the car is serviced or repaired.

In addition to the above, the registered information can be used in combined form for research and product development with the aim of continuously improving the safety and quality of Volvo cars.

Volvo will not contribute to the above-described information being disclosed to third parties without the car owner's consent. To comply with national legislation and regulations, Volvo may be forced to disclose information of this nature to the police or other authorities who may assert a legal right to access such information. Special technical equipment which Volvo and workshops that have entered into agreements with Volvo have access to is required to be able to read and interpret the recorded data. Volvo is responsible for ensuring that the information, which is transferred to Volvo during servicing and maintenance, is securely stored and managed and that its management complies with relevant legal requirements. For further information, contact a Volvo dealer.

## TCAM

Cars equipped with TCAM can share data with Volvo on the car's safety functions as well as other functions in the car. Data are collected for product development, quality follow-up and safety work, as well as to improve and monitor the car's quality and its safety functions. The purpose of data collection is also to manage Volvo Car Corporation's warranty undertakings, as well as to meet legal requirements related to engine emissions data.

---

# 1.8. About connected services and fair use policy

Use of your car's connected services is subject to certain conditions.

## Fair use policy

Your use of connectivity services which are part of your vehicle is subject to this fair use policy.

When using these services you agree not to:

- submit content that is unlawful, obscene, libellous, threatening, harassing, hateful, racially or ethnically offensive or otherwise inappropriate
- use the services in breach of any applicable law
- use the services for commercial purposes.

Your access to these services is part of a shared access. Volvo reserves the right to suspend your access to or use of the services if your use involves very high volumes of data, disproportionate to other users. Volvo may also suspend your access for technical reasons or to protect other functions of your vehicle.

---

## 1.9. Changing ownership of the car

The driver of the car must be registered with Volvo in order to use all available functions and services. Therefore, in connection with a change of ownership, the current owner needs to be removed to give the new owner access.

The current owner needs to end their ownership by removing the car connection in the Volvo Cars app or by visiting a Volvo dealer. The new owner can also get help with registering their ownership by contacting a Volvo dealer or Volvo support.

### Note

#### Reset the car

When the current owner has ended the ownership, an automatic factory reset of the car takes place. This means that profiles, user data and other individual settings are removed.

#### No owner?

If the car doesn't have an owner, you can claim the ownership by connecting your Volvo ID to your profile in profile settings via the centre display. Make sure that you have two keys in the car as you will need both of them for the setup process.

---

## 1.10. Resetting user data

You can reset the user data and system settings in the centre display.

You can reset the app settings or network settings to their standard values or do a complete factory reset. If you do a factory reset, you will delete profiles, user data and other customised settings.

 **Note**

### Owner

Only the owner can reset the network settings and do a factory reset.

### App connection

If you do a factory reset in the car, the app will still be connected and may recreate your profile using cloud data. To avoid this, you need to remove the car connection in the Volvo Cars app.

1. Press the car symbol  in the bottom bar and go to **Settings**.
2. Go to **System** → **Reset options**.
3. Select what you want to reset and follow the instructions in the centre display.

---

## 1.11. Recommendations when changing regions

When relocating or importing your car to a new region, you need to register your car and Volvo ID there. This is to make sure that digital services work correctly and that the car follows local laws and regulations.

To get help registering your car in a new region, contact Volvo support.

 **Note**

### Available services

Available services can vary over time and depend on region. This may also have an effect when you're visiting another region temporarily.

## 2. User accounts, profiles and services

Get more out of your car by customising it using profiles and connecting it to the phone app. This gives you access to more features and services, such as support if you're having issues on the road.

### Note

Some of the services available for your car require a registered personal account, such as your Volvo ID.

To get the most out of your car experience:

- Connect your Volvo ID
- Download and sign in to the Volvo Cars app on your phone
- Set up your user profile and customise the car's settings, such as the ergonomic settings and other preferences
- Sign in with your Google account

---

### 2.1. Setting up your car for the first time

There is a guide that helps you set your car up the first time you use it.

The setup guide for your car automatically starts in the centre display. It guides you through setting up the owner profile and other essential settings.

### Tip

#### Before getting your car

Before you start, you will need to create a Volvo ID and download the Volvo Cars app. This makes the in-car setup faster.

The setup guide covers the following:

- Important settings, such as your car's system language
- Connecting the car to your Volvo ID and the Volvo Cars app
- Consent to terms and conditions for various car services, including third party services
- Setting up internet access
- Consent to software updates
- Setting up your profile

 **Note**

### Stay parked during setup

The car needs to be stationary and in P when you go through the setup guide.

### Complete setup

It's advisable to complete the setup before driving the car. If you exit the guide before going through the necessary steps, certain features will be unavailable until you complete the process. You will be reminded about the setup the next time you drive the car. You can also go to profile settings and complete it whenever you want to.

### No guide?

If the car has already been set up by someone else, such as a previous owner, you can reset the car by ending the ownership. This will allow you to access the setup guide again.

---

## 2.2. Volvo ID

Your Volvo ID is a personal account that gives you access to various services connected to your car. You can connect your Volvo ID to your profile in profile settings.

You will need your Volvo ID when you use remote features via the Volvo Cars app.

 **Note**

Available services can vary over time and depend on both region and equipment level.

 **Tip**

You can also connect your Volvo ID to your profile in settings.

---

### 2.2.1. Creating a Volvo ID

Create your Volvo ID in the Volvo Cars app on your phone or on Volvo's website.

If you want to use the Volvo Cars app to create your Volvo ID, make sure that you have the latest version installed on your phone.

1. Open the app on your phone or go to [volvocars.com](https://www.volvocars.com) [<https://www.volvocars.com>].

**Note**

If you use the website, make sure that you are signed in.

2. Select the option to create a new Volvo ID and follow the instructions.

**Note**

After creating your Volvo ID, you may need to confirm your email address to fully activate your account.

## 2.3. Volvo Cars app

The Volvo Cars app allows you to control certain functions and interact with the car via your phone.

The Volvo Cars app is available for iPhone and Android phones. You can download it for free from your phone's app store. The app is updated regularly, so make sure that you have the latest version on your phone.

**Note**

### Sign in with your Volvo ID

You need to sign in to the app and the car using the same Volvo ID.

### Give your consent

Give your consent to Volvo services in privacy settings to be able to connect the app to the car.

### Check the internet connection

The Volvo Cars app and your car need to be connected to the internet for all services to work properly.

Here are a few things you can do in the Volvo Cars app: <sup>[1]</sup>

- Check the fuel level, lock status and other car statuses
- Lock and unlock doors
- Start and stop parking climate control
- Contact Volvo for more assistance
- View your account information

**Note**

If you haven't used your car for a few days, you will not be able to use the remote functions via the app. The functions will be available again when you start your car.

[1] Available services can vary over time and depend on region.

---

## 2.4. Getting started with Google services

Signing in with your Google account gives you a personalised experience when using Google services and apps such as Maps.

To sign in to your Google account and take full advantage of Google services, the car needs to be connected to the internet.

1. If you don't already have a Google account, go to [accounts.google.com/signup](https://accounts.google.com/signup) and create one.
  2. Sign in using your Google account via the car's centre display and follow the instructions.
- 

## 2.5. Customisation and settings

You can customise many of your car's features and behaviours by accessing its settings.

### Where to find settings

Settings and adjustments are available in the following places:

- The settings tab in the display contains most of your car's settings and adjustments. To access it, press the car symbol  in the bottom bar and go to **Settings**. There are several categories to explore within the tab.
- Some views and in-car apps have their own settings sections. Open the app or view and look around to find available customisation options.
- The mobile app for the car has settings related to remote and connected features.

## Setting types

Your car's settings apply differently depending on their type. Most settings are specific to a user profile, but some apply to all users of the car. A few settings are only available to adjust when the owner profile, which has administrative privileges, is in use.



Tip

### Customised experience

Set up user profiles for all drivers to get a customised experience. There are many profile-specific settings that are applied automatically when you select your profile.

Some settings apply indefinitely from the moment you change them, while others may only be temporarily applied, such as until the end of the current drive.

---

## 2.6. Car user profiles

For a more customised experience, you can set up user profiles for different drivers.

To access all of your car's features, you need to set up the owner profile. You can then add co-driver profiles for more users. Having individual user profiles allows each driver to save customised settings and adjustments which are automatically applied when their profile is selected.

Profile type	Who uses it?
--------------	--------------

<b>Owner</b>	The permanent user profile for the owner of the car.
<b>Guest</b>	A guest user profile that's available for temporary users of the car.
<b>Co-driver</b>	Up to five additional user profiles for regular users of the car.

The owner has all the administrative privileges while the co-drivers have some of them. The guest can make some adjustments but that profile resets when you start using another profile.

You can find the profile settings in settings, where you can do the following:

- Add and switch profiles
- Restrict access to your profile
- Connect the Volvo Cars app to the car
- Connect keys to your profile
- Change your profile name
- Sign out from a profile
- Remove your profile, if you are a co-driver

The owner can also do the following:

- Remove co-driver profiles.
- Enable a Care key and set a speed limitation for it.

**The content of this manual represents the status of the user manual at the time of printing and may not be completely valid in future instances. For more information, refer to the first page for the complete disclaimer note.**

---

## 2.6.1. Switching profiles

You can switch between profiles in the centre display.

 **Note**

**Only available while stationary**

It's only possible to switch profiles when the car is stationary and in P. It's also unavailable during certain tasks.

**Can't switch?**

If you have problems switching to another profile, you will just stay in the current profile. Try again later.

**Locked profile?**

You might need a PIN or pattern to unlock a profile before using it. If it's not your profile, you can switch to your own profile instead or create a new profile.

1. Press the car symbol  in the bottom bar and go to **Settings**.
2. Go to **Profiles**.
3. Select your profile.

 **Tip**

You can also switch profiles by opening the notification centre and selecting your profile from the profile picker.

---

## 2.6.2. Adding a profile

You can add new profiles in the centre display.

When you add a new profile, the setup guide starts automatically in the centre display. It guides you through all of the essential settings.

 **Note**

If you don't complete the setup guide, some features and services will be unavailable.

 **Tip**

The owner can invite new co-drivers in the Volvo Cars app. The car then automatically creates a new profile for that co-driver's Volvo ID in the car.

#### Add a profile in profile settings

1. Press the car symbol  in the bottom bar and go to **Settings**.

 **Tip**

You can also press the profile symbol at the top for quicker access to profile settings.

2. Go to **Profiles**.
3. Press **Add new** and follow the instructions in the centre display.

## 2.6.3. Removing a profile

You can remove your user profile in the centre display.

 **Note**

You cannot remove the owner or the guest profile, but you can reset them. If you want to reset the owner profile, you need to do a factory reset. The owner profile also resets when you end your ownership. The guest profile resets when you switch to another profile.

1. Press the car symbol  in the bottom bar and go to **Settings**.

 **Tip**

You can also press the profile symbol at the top for quicker access to profile settings.

2. Go to **Profiles**.
  3. Select **Remove this profile**.
- > The car will switch to the guest profile automatically.

 **Tip**

The owner can remove co-driver profiles in the car by going to **Manage other profiles** in profile settings. The owner can also remove user profiles from the car via the Volvo Cars app. This only works if a profile is connected to a Volvo ID, otherwise it won't show up in the mobile app.

---

## 2.6.4. Assigning a key to a profile

You can assign keys to your profile.

### In the setup guide

You can assign a key to your profile during the setup guide. When it's time, place your key on the backup key reader and follow the instructions in the centre display. You can also do it later in profile settings.

 **Tip**

Assign a key to your profile so that your profile is automatically selected when you unlock the car or open the driver door using the key. If you use a key that's not assigned to any profile, the most recently used profile will be selected.

### Assigning a key to a profile in Profile settings

1. Press the car symbol  in the bottom bar and go to **Settings**.

 **Tip**

You can also press the profile symbol at the top for quicker access to profile settings.

2. Go to **Profiles** → **Car keys**.
3. Select the key you want to assign and follow the instructions in the centre display.

 **Note**

If the key is already assigned to another profile, it will be moved to your profile instead.

---

## 2.6.5. Managing keys assigned to profiles

You can manage your assigned keys in profile settings.

 **Note**

You can only remove keys that are connected to your own profile.

1. Press the car symbol  in the bottom bar and go to **Settings**.

 **Tip**

You can also press the profile symbol at the top for quicker access to profile settings.

2. Go to **Profiles** → **Car keys**.  
> You will see a list of all the assigned keys.
3. Select the key you want to manage and follow the instructions in the centre display.

---

## 2.6.6. Restricting access to a profile

You can restrict access to a profile by adding a profile lock in the centre display. When a profile lock is active, you need a PIN or pattern to unlock the profile.

1. Press the car symbol  in the bottom bar and go to **Settings**.

 **Tip**

You can also press the profile symbol at the top for quicker access to profile settings.

2. Go to **Profiles** → **Profile lock**.
3. Select your preferred lock type and follow the instructions in the centre display.

---

## 2.6.7. Adding an account to a profile

You can add different accounts to your profile, such as your Volvo ID and accounts from third-party apps.

 **Tip**

You can also connect your Volvo ID to your profile in profile settings.

Adding your Volvo ID to your profile allows you to access the car via the mobile app.

1. Press the car symbol  in the bottom bar and go to **Settings**.
  2. Go to **System** → **Accounts**.
  3. Select **Add account**.
- > You will see a list of possible accounts to add.
4. Select the account you want to add and follow the instructions in the centre display.

If you want to remove an account from your profile, select the account and press **Remove**.

---

## 2.7. Volvo Assistance

Volvo Assistance is a service that provides assistance and remote access to certain car features. You can contact a Volvo Assistance service centre at any time for assistance.

If you experience any unpredictable problems on the road, you can call Volvo Assistance. This includes if:

- your car doesn't start
- your car breaks down
- you get a puncture.

Volvo Assistance is available in the Volvo Cars app and by pressing the assist button  in the car's ceiling.

 **Note**

### Not for emergencies

If you need assistance in an emergency situation, press the SOS button instead. Situations that could require immediate emergency assistance include traffic accidents, acute illness and external threats.

### Stolen car

If your car has been stolen and you need help with tracking it down, contact Volvo Assistance.<sup>[1]</sup>

## An included service

Volvo Assistance is included with new Volvo cars for the first few years of ownership.<sup>[2]</sup> For more information regarding your car, contact Volvo support or a Volvo dealer.

**Note**

If you don't have a Volvo Assistance agreement, you will still be able to use the service for an extra cost.

## Terms and conditions

Volvo Assistance is intended to be active for as long as the car is used and the technology it relies on is supported, such as the car's mobile network connectivity.

Certain information, including personal data, needs to be shared with Volvo in order to use Volvo Assistance.

**Note**

Volvo reserves the right to reduce Volvo Assistance functionality that is deemed no longer practically possible to maintain.

If a car remains unused for more than one year, it is considered no longer in use.

If you need any help or have any questions regarding Volvo Assistance, contact Volvo support.

<sup>[1]</sup> Availability and inclusion varies between regions.

<sup>[2]</sup> Availability and inclusion with new cars varies between regions.

## 2.7.1. Calling Volvo Assistance for roadside assistance

You can press the assist button in the car's ceiling to contact Volvo Assistance for roadside assistance<sup>[1]</sup>. You might want to do this if you experience any unpredictable problems on the road, such as if your car doesn't start, your car breaks down or you get a puncture.

**Note**

### Not for emergencies

If you need assistance in an emergency situation, press the SOS button instead. Situations that could require immediate emergency assistance include traffic accidents, acute illness and external threats.

### Using Volvo Assistance abroad

If you press the assist button  when you are abroad, you will reach Volvo Assistance in your home country.

 Tip

You can also use the mobile app for the car to contact Volvo Assistance.



The assist button is located in the ceiling, on the right side of the overhead console.

1. Press and hold the assist button for at least 2 seconds.



- > The car makes a voice call to Volvo Assistance. It also sends information such as its location and status. The Volvo Assistance call centre tries to communicate with the people in the car to find out what kind of help you need.

If the voice call fails, the Volvo Assistance call centre has the ability to respond based on information sent by the car.

<sup>[1]</sup> Availability depends on region.

---

## 2.8. Emergency assistance

In an emergency, the car can connect you to an emergency call centre. This is done automatically in response to severe collisions or manually by pressing the SOS button in the ceiling. <sup>[1]</sup>

 **Note**

### Strictly for emergencies

Situations that could require immediate emergency assistance include traffic accidents, acute illness and external threats.

### Built to work after a collision

Calling an emergency call centre after a collision requires that the system is not critically damaged. The system is designed to survive severe collisions and has its own backup battery in case the regular power supply fails.

When an emergency call is made, the following happens:

1. The car makes a voice call to an emergency call centre. It also sends information such as its location and status.
2. The emergency call centre tries to communicate with the people in the car to find out what kind of help you need.
3. If the voice call fails, the emergency call centre has the ability to respond based on information sent by the car.

## Automatic emergency response

The car automatically attempts to contact an emergency call centre if it registers a collision above a certain level of severity.<sup>[2]</sup>

## Using the SOS button

The SOS button is located in the ceiling, on the left side of the overhead console. You can read more about using the SOS button in a separate section of the manual.

When the system is working normally, the SOS button LED is white. In other cases, the light may change to red or flash with varying intervals.

LED behaviour	Description
Blinking	The system is performing a self-check.
Solid red with SOS symbol showing in the driver display	The system had detected a critical fault. Immediate service is recommended.
Moderate flashing	An emergency call is starting.
Rapid flashing	The system is transmitting data to the emergency services.
Slow flashing	The system is connected to the emergency services.
Solid white	The system is working normally.

 **Note**

### Not an emergency?

If you need help on the road but aren't in an emergency situation, press the assist button  to call Volvo Assistance instead. Volvo Assistance can help you in certain situations, such as if your car doesn't start, your car breaks down or you get a puncture.

<sup>[1]</sup> Availability varies between regions. Contact Volvo support for more information.

<sup>[2]</sup> For example, when safety features such as airbags or seatbelt pretensioners have deployed.

## 2.8.1. Calling emergency services with SOS button

A long press of the SOS button in the car's ceiling connects you to an emergency call centre. <sup>[1]</sup>

### Note

#### Strictly for emergencies

Situations that could require immediate emergency assistance include traffic accidents, acute illness and external threats.

#### Not an emergency?

If you need help on the road but aren't in an emergency situation, press the assist button  to call Volvo Assistance instead. Volvo Assistance can help you in certain situations, such as if your car doesn't start, your car breaks down or you get a puncture.

#### Using the SOS button abroad

If you press the SOS button when you are abroad, you will reach the local emergency services.



The SOS button is located in the ceiling, on the left side of the overhead console.

1. Press and hold the SOS button for at least 2 seconds.



- > The car makes a voice call to an emergency call centre. It also sends information such as its location and status. The emergency call centre tries to communicate with the people in the car to find out what kind of help you need.

If the voice call fails, the emergency call centre has the ability to respond based on information sent by the car.

<sup>[1]</sup> Availability varies between regions.

## 2.8.2. Changing emergency call recipient

When pressing the SOS button, your car will make a call to a Volvo emergency service by default. If you want your car to call an emergency centre instead, you need to change it in your profile settings.

### Note

#### Default settings

In some regions, the car calls an emergency centre by default instead of Volvo's emergency service.

#### Unable to change recipient?

The ability to change emergency call recipient depends on your region and may vary over time.

1. Press the car symbol  in the bottom bar and go to **Settings**.
2. Go to **Controls** → **More** → **SOS button calls Volvo Cars emergency service**.
3. Select one of the options.

## 3. Displays, software and phone

Explore how to interact with your car. Here's where you can find more information on your car's displays, connectivity features, sound and media, in-car apps, software and voice control.



You can access many of your car's functions via its displays, but there's also plenty you can do by using your phone.

An internet-connected car makes remote access possible and keeps the car up to date by downloading software updates. Learn how it's all connected.

---

### 3.1. Displays

The different displays show you information related to the car and your driving. You can also control many of the car's functions by interacting with the displays.



Locations of the displays

- ① Driver display
- ② Centre display

---

### 3.1.1. Centre display

Interact with the centre display to control and view information about many of the car's features and functions.



The centre display sits in the middle of the dashboard and automatically activates when the driver's door is opened.

Frequently used features such as climate, settings and the app library can be accessed by pressing the symbols at the bottom of the display.

 **Tip**

Two people, such as the driver and front passenger, can use the centre display at the same time.

Examples of functions that can be viewed and controlled via the centre display are:

- Navigation
- Media players
- In-car apps
- Phone

 **Important**

Do not use sharp objects on the centre display as they may cause damage.

---

## 3.1.1.1. Centre display views

Learn about some of the views that you can see in the centre display.

The different bars provide status information, display shortcuts to apps or quick controls, and allow you to navigate around the centre display views. The main views let you use and access navigation information, in-car apps, climate and settings. There are also some specialised views for managing specific car functions.

### Centre display bars

The status bar at the top of the centre display shows you symbols relating to the car's status and apps, along with the time and outside temperature. The bottom bar is your main way of navigating around the centre display views. By pressing the symbols, you can get to other views and functions. The status bar and bottom bar are always visible, regardless of which view you are looking at.

In some views, you will see the contextual bar appear above the bottom bar. This bar contains shortcuts to recently used functions or apps that only appear when you can use them. Sometimes these shortcuts are replaced by quick controls which allow you to control ongoing phone calls and media when the associated views or widgets aren't visible.

### Main views

The following list contains the main views that you will see and use in the centre display.

**Home view** The home view shows a large navigation map and so it also works as the navigation view. There are widgets with quick controls for media and phone underneath the map. The home view is accessed from other views by pressing the home button  underneath the bottom bar.

- App library** You can access the manual, in-car apps and the app store in this view. To get to this view, press the app library symbol  in the bottom bar.
- Climate view** You can change a variety of climate settings in this view, such as activating or deactivating defrosters and adjusting settings for air conditioning. The climate view is accessed by pressing the fan symbol  in the bottom bar.
- Car overview** This view gives you access to the quick controls and settings views as well as user profiles. These come together to give you an overview of the car which can be accessed by pressing the car symbol  in the bottom bar.
- Quick controls view** This view gives you quick and easy access to some of the car's functions, such as folding the headrests. You can get to the quick controls view by pressing the car symbol  in the bottom bar.
- Settings view** This view is where you can access all of the different settings tabs and views for your car. You can get to the settings view by pressing the car symbol  in the bottom bar.

## Specialised views

The following views are related to specific functions in the car.

- Seat adjustments view** You can adjust the seats in the adjustments view. For example, you can adjust the side support as well as the lumbar support and seat cushion extension.
- Parking view** The parking view contains features that help you park. When shown, it takes up most of the centre display. If the parking view doesn't automatically appear when you need it to, you can open it yourself by pressing the camera symbol  in the contextual bar above the bottom bar.

### Note

#### Driver distraction overlay

What you can see and do in the centre display sometimes depends on whether the car is moving or not. To minimise driver distraction while the car is moving, some views become unavailable, such as certain settings. If this happens, the centre display shows the driver distraction overlay. When the car stops moving, the overlay disappears and you can interact with the view again.

## 3.1.1.2. Status symbols in the centre display

Status symbols are shown in the status bar at the top of the centre display. The symbols tell you important information about your car's system status.

### Symbol types

Some status symbols, such as the clock, will always be visible in the status bar. Others are only visible when a particular function is active, such as wireless charging, or even disabled. You will also see symbols that tell you when there is an error, such as when you have an internet connection issue.

### Note

Make sure you look up any status symbols that you are unfamiliar with. They might not appear with any extra information or notifications.

This is a list of some status symbols that can appear in the status bar. It is not an exhaustive list and you might also see status symbols in the status bar from third-party apps.

	Clock	The clock shows you the current time. You can choose whether to display the time in the 12-hour or 24-hour format.
	Mobile internet signal	Mobile internet is active and being used by the car. The number of bars indicates signal strength.
	Mobile internet error	There is an issue with the mobile internet connection. If you see this symbol with a type of connection next to it, such as 3G or LTE, it means that the car is connected to a network but doesn't have a working internet connection.
	No internet connection	The car is not connected to the internet.
	LTE mobile internet signal	Your car has an active LTE mobile internet connection.
	EDGE mobile internet signal	Your car has an active EDGE mobile internet connection.
	3G mobile internet signal	Your car has an active 3G mobile internet connection.
	4G mobile internet signal	Your car has an active 4G mobile internet connection.
	Roaming active	Roaming is active.
	Wi-Fi signal	Wi-Fi is enabled and active. The number of bars indicates the signal strength. If no bars are shown, this indicates that a Wi-Fi connection is active but there is no signal.
	Wi-Fi internet error	There is an issue with the Wi-Fi internet connection.
	Bluetooth connected	Bluetooth is enabled and a device is connected to the car.
	Location	Your location is being shared.
	Wireless charging active	A device is charging on the wireless charger.

### 3.1.1.3. Restarting the centre display

You can restart the centre display using the home button underneath the bottom bar.

If you are having problems with the centre display, such as it freezing or issues with connectivity, restarting it might be a way to resolve these issues.

1. Press and hold the home button  underneath the centre display's bottom bar until the display turns off.
- > The centre display shows the Volvo logo to indicate that it's restarting.

## 3.1.1.4. Keyboard

The centre display's keyboard appears when you can write text or numbers. You can customise many of its features in settings.

You can use the on-screen keyboard to write text or numbers. For example, when searching for a destination in the navigation app or putting the password in for a Wi-Fi network.

The keyboard's layout can change depending on the type of input field you are writing in.

The keyboard supports some alternative ways of inputting text. These include:

- Glide typing
- Speech to text
- Handwriting



Tip

You can download other keyboards to use by going to the app store in the app library.

### 3.1.1.4.1. Changing keyboard language

You can change the language for the centre display's keyboard on the keyboard itself.

Change the keyboard language when you want to write text in a different language. This can be useful when you are driving abroad and need to search for a destination or address in the local language.



Note

To be able to change the keyboard language, you need to have more than one language available for the keyboard. If you only have one language available, the languages symbol won't be shown on the keyboard.

#### Changing language to the next available language

1. Press the languages symbol  at the bottom of the keyboard.
- > The keyboard language switches to the next one in the available languages list.

#### Changing language to any available language

2. Press and hold the languages symbol  at the bottom of the keyboard.
- > A list of available languages appears.
3. Select the language you want to use.

> The keyboard language changes to the one you selected.

---

## 3.1.1.4.2. Adding and removing keyboard languages

You can add and remove keyboard languages in settings.

You can add languages to the centre display's on-screen keyboard if you want to write in a language that isn't already available. Languages can also be removed from the keyboard if you find that you no longer need them.

1. Press the car symbol  in the bottom bar and go to **Settings**.
2. Go to **System** → **Languages and input** → **Keyboard**.
3. Choose the keyboard you want to make changes to.
4. Select **Languages**.

### Adding a language

5. Press the add symbol  above the currently available languages and search for your desired language.
6. Select the language you want to add, then press the download symbol .

> The language is added to the list of languages available to use on your keyboard.

### Removing a language

7. Press the edit symbol  above the list of currently available languages.
8. Select the language you want to remove from the list of available languages, then press the rubbish bin symbol .

> The language is removed from the list of languages available to use on your keyboard.

---

## 3.1.2. Driver display

The driver display shows you notifications and information related to your driving and the car itself.



The driver display is located in front of the driver, behind the steering wheel.

The driver display activates as soon as you open a door and turns off if it isn't used for a short period of time. To turn it back on, either open a door or turn the start knob clockwise and quickly let it go.

Use the steering wheel buttons to interact with the display and control what's shown on it.

Examples of information that can be shown in the driver display are:

- Warning and indicator symbols
- Speed
- Navigation
- Notification messages
- Fuel meter
- Trip meter

## Display modes

There are two driver display modes that you can choose from: calm and map. Use the driver display mode button  on the steering wheel to change the display mode.

**Calm** This displays essential information, such as speed, as well as warning and indicator symbols.

**Map** The driver display shows your current navigation route on a map as well as essential driving and car information.

 **Warning**

If the driver display turns off, doesn't turn on or is only partially legible, you must not use the car. This is because the driver will not receive warnings and car status information shown in the driver display, such as warnings and information relating to brakes, airbags or other safety systems. If there is an issue with the driver display, contact an authorised Volvo workshop.

 **Tip**

You can change driver display settings in the centre display.

## 3.1.2.1. Warning and indicator symbols

The driver display symbols tell you the status of different systems in your car. Some indicate whether a system is active and operating as it should, and others alert you to important information or detected faults.

### Symbol types and colours

Some symbols are warnings that require immediate action, while others indicate the current status of specific functions. The symbol colour roughly signifies the level of importance. Red symbols are the most critical while amber symbols represent less urgent warnings and alerts. Symbols of other colours typically convey status information about the car's functions.

 **Tip**

Be sure to look up the meaning of symbols you are unfamiliar with. Many symbols will appear with a notification providing more information.



Warning

A fault is detected that could affect safety or your car's ability to drive.



Brake system warning

A fault is detected in the brake system. Take immediate action and contact an authorised Volvo workshop.



Parking brake warning

Continuous illumination indicates that the parking brake is engaged. Flashing indicates a parking brake fault.



Electrical system fault warning

A fault is detected in the car's electrical system. Take immediate action and contact an authorised Volvo workshop.



Emergency call

There is an issue with the emergency call system.



Seatbelt reminder

Someone in the car isn't wearing their seatbelt.



SRS warning

A fault is detected with the airbags or related safety systems. Take immediate action and contact an authorised Volvo workshop.

	Collision risk warning	There is a risk of collision with another vehicle, a pedestrian, a cyclist or a large animal.
	High engine temperature	The engine is too hot.
	Low oil pressure	The engine's oil pressure is too low.
	Information	A problem has occurred in one of the car's systems.
	Brake system warning	A fault is detected in the brake system.
	Anti-lock braking system warning	The anti-lock braking system is disengaged. The friction brakes still function but without anti-lock braking.
	Emission control system warning	A fault is detected in the emission control system. Contact an authorised Volvo workshop and have the car checked.
	Lane keeping aid fault	There is a fault with the lane keeping aid system. <sup>[1]</sup>
	Left lane keeping aid warning	You are too close to or crossing over the lane markings on the left-hand side of the car.
	Right lane keeping aid warning	You are too close to or crossing over the lane markings on the right-hand side of the car.
	Tyre pressure warning	Constant illumination indicates low tyre pressure. Flashing followed by constant illumination indicates a system fault or inability to measure the tyre pressure.
	Stability system alert	A flashing symbol indicates that the stability system is intervening. A fault in the system is indicated by a constant glow.
	Stability system off	The stability system is turned off.
	Collision risk system issue	The collision risk system is not available or is working with reduced performance.
	Rear fog light on	The rear fog light is on.
	Headlight system malfunction	There is an issue with the headlight system.
	Automatic high beam active	The automatic high beam is active.
	Manual high beam on	The manual high beam is on.
	Automatic hold	The automatic hold braking function is active. The car automatically brakes while stationary.
	Left-hand direction indicator	The left direction indicator is active and indicating a left turn.
	Right-hand direction indicator	The right direction indicator is active and indicating a right turn.
	Position lights	The position lights are on.

	Automatic high beam enabled	The automatic high beam is enabled.
	Car key not detected	The car couldn't detect the key when the car was started.
	Driver alert	The Driver alert function is active.
	Lane keeping aid active and left road markings detected	Lane keeping aid is active and has detected the road markings on the left-hand side of the car.
	Lane keeping aid active and right road markings detected	Lane keeping aid is active and has detected the road markings on the right-hand side of the car.
	Lane keeping aid active and road markings detected	Lane keeping aid is active and has detected the road markings on both sides of the car.
	Lane keeping aid active and no road markings detected	Lane keeping aid is active and has not detected the road markings.
	Lane keeping aid off	Lane keeping aid is turned off.
	Rain sensor	The rain sensor is active.

[1] When a fault is indicated, the function is disabled.

## 3.1.2.2. Fuel meter

The fuel meter indicates how much fuel you have left in your fuel tank as well as an estimated fuel range.

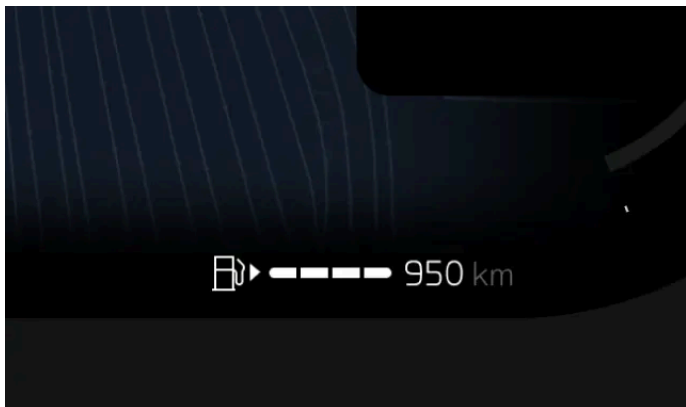

The driver display shows the fuel meter at all times.

### Remaining fuel

The fuel meter indicates the amount of fuel left in your car's tank. When the car's tank is low on fuel, the fuel pump symbol changes colour.

The meter also displays an estimated fuel range for how much further you can drive before the tank becomes empty. This range is calculated by the trip meter based on your average fuel consumption over the last 30 km (20 miles) and how much fuel is left in the tank. When you can see a dotted line instead of a range, it means that there isn't enough remaining fuel to calculate the range and you should refuel as soon as possible.

 **Note**

Your driving style can have different effects on the estimated fuel range.

---

## 3.1.3. System settings

You can change the system settings so that the car displays information in a way that suits you.

There are a number of system settings that you can change, including:

- System language
- Time and date
- Units of measurement
- Keyboard languages

---

### 3.1.3.1. Changing time and date

You can manually change the time, date and local time zone in settings.

By default, your car uses information from the internet to automatically change the time, date and local time zone for you. You can also manually change these yourself as well as the time format in settings.

1. Press the car symbol  in the bottom bar and go to **Settings**.
  2. Go to **System** → **Date and time**.
  3. If **Automatic date and time** and **Automatic time zone** are enabled, turn them off.
  4. Select your desired setting and make any changes.
- > The changes are shown in the displays.  
The clock in the centre display's status bar updates if you made changes to the time settings.



Tip

You can change the time format so that it's displayed in the 24-hour or 12-hour format.

---

## 3.1.3.2. Changing system language

You can change the language of the car's system in settings.

If you want the car's system to be in a language that is different from the current language, you need to change the system language.



Important

Only select a system language that you can fully understand. The car communicates safety-critical information and notifications to you through messages, so you need to be able to understand them at all times.



Note

When you change the system language, the digital assistant's language also changes.

1. Press the car symbol  in the bottom bar and go to **Settings**.
  2. Go to **System** → **Languages and input** → **Languages**.
  3. Choose the language you want to change to.
- > The new language is shown in the displays.

---

## 3.1.3.3. Changing system units

You can change the units of measurement, such as for speed and distance, in settings.



Tip

When driving abroad, it can be useful to change the car's units of measurement to match the local ones. It can be especially helpful if road signs display distances and speeds in units that are different to those currently displayed in your car.

1. Press the car symbol  in the bottom bar and go to **Settings**.
  2. Go to **System** → **Units**.
  3. Select the units of measurement you want the car to display.
- > The car displays units in the new format.
- 

## 3.2. Phone

Connect your phone to the car via Bluetooth to be able to use it while driving. When you are away from your car, you can also use your phone to read the manual or use some car features remotely via the Volvo Cars app.

### Connect your phone to your car

Connecting your phone to the car via Bluetooth allows you to use it through the car's interface. You can also stream media directly from your phone to the car as well as share its internet connection.

You can use voice control or the centre display to search for your contacts, make and receive phone calls, and respond to text messages<sup>[1]</sup> without even touching your phone.

### Other uses for your phone

Using your phone with your car isn't limited to just when you're inside the car. Download the Volvo Cars app to remotely use certain car functions or read the manual when you're away from the car.

<sup>[1]</sup> Only applies to Android phones or phones with iOS 13 or later.

---

### 3.2.1. Connecting your phone to the car

Connect your phone to the car via Bluetooth to use your phone through the car's interface.

Bluetooth must be enabled for both the car and your phone for them to be able to pair. You can turn Bluetooth on in settings. Make sure that your phone is set as discoverable so that the car can find it when pairing.

1. Press the car symbol  in the bottom bar and go to **Settings**.
2. Go to **Connectivity** → **Bluetooth**.

3. Choose the device you want to pair the car with from the list of available devices.
  4. Check that the confirmation code in the centre display matches the one shown on your phone.
  5. Accept the settings and permission requests that appear on your phone.<sup>[1]</sup>
- > Your phone is now connected to the car. It will automatically connect next time, as long as Bluetooth is enabled on your phone.

 **Note**

You can have multiple phones paired with the car, but only one can be connected to the car at a time. To change the active phone, select it from the list of paired devices or add a new device.

## Issues with connecting?

If you have issues with connecting your phone to the car via Bluetooth, try connecting another phone to check whether the problem is with your phone or the car. If the problem persists, remove all saved devices in the car's Bluetooth settings and try to connect your phone again.

- <sup>[1]</sup> You can still connect your phone to the car even if you skip over permission requests, but there will be reduced functionality.

---

## 3.2.2. Using your phone in the car

You can use your phone via the centre display and voice control.

 **Important**

Make sure that you comply with all local laws and regulations regarding mobile phone use while driving.

 **Note**

You need to connect your phone to the car via Bluetooth and accept the corresponding phone settings permissions to be able to use these features.





## Calling

There are some different ways you can make and receive phone calls while in your car. You can:

- answer and decline incoming calls using the centre display
- call someone while driving by asking the digital assistant to make the call for you

- use the in-car phone app via the centre display to call contacts or type a phone number in using the on-screen keypad.

When you have an ongoing call, it will be shown in the centre display. If you open the in-car phone app when you have an ongoing call, you can:

- mute and unmute your microphone 
- change the sound input and output, such as through the car or your mobile phone's microphone and speakers 
- end the call 
- use the keypad to input numbers, such as when asked to select an option in a service menu .

If you receive a second phone call while in the middle of an ongoing call, answering the second phone call automatically puts the first one on hold. You can switch between the two calls by pressing the switch symbol .

## Messaging

You can write and send text messages via the digital assistant using voice control<sup>[1]</sup>. If you receive a text message, a notification will appear in the centre display with the following options:

- **Play** to hear the digital assistant read the message out loud.
- **Mute** to stop receiving new message notifications from this specific conversation for the rest of the time you are in the car.

You can also ignore the notification and view it later in the notification centre.

## Looking through and searching for your contacts

Use the in-car phone app to search for a specific contact by:

- pressing the search symbol 
- going to the contacts tab and typing their name
- going to the keypad tab and putting their number in.

You can also just ask the digital assistant to find the contact you are looking for.

<sup>[1]</sup> Only applies to Android phones or phones with iOS 13 or later.

---

### 3.2.3. Switching between paired phones

You can change which Bluetooth-paired phone the car is connected to in settings.

The car can connect to and remember multiple phones, but it can only be actively connected to one phone at a time.

If you want to switch the Bluetooth connection to a new device, you need to pair it with the car first. You can do this in settings.

Before trying to switch to a different paired device, make sure that Bluetooth is enabled on the device you want to switch to.

1. Press the car symbol  in the bottom bar and go to **Settings**.
2. Go to **Connectivity** → **Bluetooth**.
3. Press the name of the phone you want to connect to.
4. Select the services you want the phone to be used for, such as media or phone services.

 **Tip**

You can also switch devices in the centre display's phone view by pressing the switch device symbol .

If you can't see the device you want to switch to in the paired devices list, try pairing it with the car again.

## 3.2.4. Apple CarPlay

Connect your phone via a USB cable and activate Apple CarPlay to use your iPhone via the car.

Apple CarPlay gives you another way of using your iPhone via the car's interface. You can use certain communication, navigation and media apps on your iPhone via the centre display as well as the steering wheel buttons and voice control.

 **Important**

### Local laws and regulations

Make sure that you comply with all local laws and regulations regarding mobile phone use while driving.

### CarPlay content

Volvo does not accept responsibility for the content available in Apple CarPlay.

 **Note**

### Phone compatibility and supported apps

Apple CarPlay only works with iPhones but it doesn't work with all iPhone models. To find out if your iPhone is compatible or to learn more about which apps are supported, go to Apple's website [www.apple.com/ios/carplay](https://www.apple.com/ios/carplay) [<https://www.apple.com/ios/carplay>].



Tip

### CarPlay not installed?

If your car doesn't come with CarPlay, you can install it at a later time. Contact a Volvo dealer to ask about installing CarPlay in your car.

### Keep your phone updated

Keep your iPhone and apps updated to the latest versions.

## Connect your iPhone and start CarPlay



Note

### Disable Bluetooth to use CarPlay

CarPlay can't be enabled at the same time as your car's Bluetooth. To use CarPlay, you need to turn the car's Bluetooth off.

### Activate Siri and have an internet connection

To be able to use CarPlay, you need to activate Siri on your iPhone and have an active internet connection.

Connect your iPhone to the car by plugging a USB-C to lightning cable into your iPhone and the car's USB port which has a white highlight around it. If you are using CarPlay for the first time, you need to accept the terms and conditions in the centre display, then CarPlay will start. If you have used CarPlay before, it will automatically start when you connect your phone to the car.

## CarPlay view

You can access the CarPlay view by opening the CarPlay app in the app library. If the CarPlay symbol  is shown in the contextual bar, you can also access the view by pressing this symbol.

Once active, the CarPlay view takes up the whole of the centre display. However, the bottom bar, contextual bar and status bar will still be visible at all times if you want to return to the car's own system.

## Navigation with CarPlay

You can use navigation apps on your iPhone via Apple CarPlay. If you start a navigation route via CarPlay, you can see the guidance in the centre display's CarPlay view as well as in the driver display. If you are following a navigation route in the car's own navigation app and then start another navigation route in CarPlay, the driver display navigation for the car's own app will end.

## Using Siri

If you want to use Siri instead of the car's in-built digital assistant, press and hold the voice control button  on the steering wheel while CarPlay is active.

You can use Siri to read out, write and send messages. Siri will read and write messages in the language selected in the Siri settings on your iPhone. If you write a message via Siri, the centre display won't show you your message but it will be displayed on your iPhone.

## 3.2.5. Android Auto™

Connect your phone via a USB cable and activate Android Auto™ to use your Android™ phone via the car.

Android Auto gives you another way of using your Android phone via the car's interface. With Android Auto, you can safely access your phone's communication, navigation and media apps via the centre display as well as the steering wheel buttons.

### Important

#### Local laws and regulations

Make sure that you comply with all local laws and regulations regarding mobile phone use while driving.

#### Android Auto content

Volvo does not accept responsibility for the content available in Android Auto.

### Note

#### Phone compatibility and supported apps

Android Auto only works with Android phones but it doesn't work with all phone models. To find out if your phone is compatible or to learn more about which apps are supported, go to Android Auto's website [www.android.com/auto/](https://www.android.com/auto/) [<https://www.android.com/auto/>].

#### Google Trademarks and compatibility

Google, Android and Android Auto are trademarks of Google LLC. Compatible Android phone and compatible active data plan required.

### Tip

#### Keep your phone updated

Keep your phone and apps updated to the latest versions.

## Connect your phone and start Android Auto

### Note

#### Install Android Auto on your phone and have an active internet connection

To be able to use Android Auto, you need to have the Android Auto app installed on your phone and an active internet connection.

Connect your phone to the car by plugging a suitable USB cable into your phone and the car's USB port which has a white highlight around it. If you are using Android Auto for the first time, you need to accept the terms and conditions in the centre

**The content of this manual represents the status of the user manual at the time of printing and may not be completely valid in future instances. For more information, refer to the first page for the complete disclaimer note.**

display, then Android Auto will start. If you have used Android Auto before, it will automatically start when you connect your phone to the car.

## Android Auto view

You can access the Android Auto view by opening the Android Auto app in the app library. If the Android Auto symbol  is shown in the contextual bar, you can also access the view by pressing this symbol.

Once active, the Android Auto view takes up the whole of the centre display. However, the bottom bar, contextual bar and status bar will still be visible at all times if you want to return to the car's own system.

## Navigation with Android Auto

You can use navigation apps on your phone via Android Auto. If you start a navigation route via Android Auto, you can see the guidance in the centre display's Android Auto view as well as in the driver display. If you are following a navigation route in the car's own navigation app and then start another navigation route in Android Auto, the driver display navigation for the car's own app will end.

## Using Google Assistant

Talk to Google Assistant on Android Auto to carry out tasks with your voice so that you can keep your focus on driving. To use Google Assistant, just say "Hey Google" or press and hold the voice control button  on the steering wheel while Android Auto is active.

You can use Google Assistant to carry out tasks such as sending messages, getting directions or controlling media.

---

## 3.3. Sound and media

Listen to music and media through the car's sound system. You can adjust how it sounds in settings.

### Sound settings

There is a variety of sound settings for you to customise your sound experience.

### Radio and media players

You can listen to live radio via the pre-installed radio app and stream media from your phone to the car via the Bluetooth media player.



Tip

You can find and download more third-party media apps via the car's app store.

### Controlling media playback

You can control media playback in a number of ways by using:

- media playback controls in the centre display

**The content of this manual represents the status of the user manual at the time of printing and may not be completely valid in future instances. For more information, refer to the first page for the complete disclaimer note.**

- the media knob and buttons underneath the centre display
  - the steering wheel buttons
  - voice control.
- 

## 3.3.1. Radio

Use the pre-installed radio app to listen to live radio in your car.

### Link DAB and FM radio stations

DAB and FM linking allows the car to automatically select the strongest reception between the DAB or FM sources of linked stations. You can turn linking on or off in the radio app settings.

### Radio announcements

When listening to the radio, you might hear some announcements which interrupt what you're listening to. They are accompanied by a notification in the centre display. You can stop the announcement and continue listening to the radio by dismissing the notification.

You can choose which radio announcements you want to hear in radio settings. Press the settings symbol  at the top of the radio app, then turn the announcements on or off.

### Radio favourites

You can add stations to your radio favourites list for quicker access.



Tip



You can find and download other radio apps via the app store.

---

### 3.3.1.1. Adding radio favourites

You can add radio stations to the favourites list in the radio app.

Add the radio stations you listen to frequently to the favourites list for quicker access.

1. Press the app library symbol  in the bottom bar and open the radio app.
2. Find the station you want to add as a favourite from the list of currently available radio stations.
3. Press the star symbol  to the right of the station name.

- > The appearance of the station's star symbol changes and the radio station appears in the favourites list.



If you want to remove a station from the favourites list, just press the star next to its name.

---

## 3.3.1.2. Linking DAB and FM stations

Turn DAB and FM linking on or off in the radio app settings.

When an FM station has a corresponding DAB station, and vice versa, they can often be linked in the radio app. Linking the two radio sources allows the car to automatically switch between the DAB and FM stations to play the source with the strongest reception.

1. Press the app library symbol  in the bottom bar and open the radio app.
  2. Press the settings symbol  to go to radio settings.
  3. Turn DAB and FM linking on or off.
- > When turned on, the radio app shows one radio station tab.  
When turned off, the radio app shows separate DAB and FM station tabs.

 **Note**

It might not be possible to link some corresponding DAB and FM stations, so these will appear as separate stations.

---

## 3.3.2. Sound settings

You can change and adjust a variety of sound options in settings.

### Focus

You can choose from four sound focus settings: all, driver, front and rear. All is the default setting and doesn't focus the sound in a particular direction. It provides a neutral sound focus where occupants in the front and rear seats have the same sound experience. The driver setting focuses sound towards the driver. The front setting focuses sound towards the front seats whereas the rear setting focuses it towards the rear seats.

If you select all or driver as your preferred sound focus, you can also turn surround sound on and adjust it.

### Tone

Customise how your media sounds by adjusting the values for the different tone qualities.

## Volume

You can adjust the volume of a variety of sounds via the centre display, such as:

- Media
- Ringtone
- Calls
- Voice assistant
- Navigation
- Notifications
- Parking assistance



Tip

There are other ways to adjust the sound volumes in your car. You can turn the media knob underneath the centre display or press the buttons on the right-hand side of the steering wheel.

---

### 3.3.3. Media players

Your car comes with a pre-installed media player. You can download more third-party media apps from the app store in the app library.

Your car comes with the Bluetooth media player pre-installed in the app library.

Use the Bluetooth media app to stream media from a Bluetooth-connected device straight to the car.

---

## 3.4. In-car apps

All of the car's apps can be found in the app library.

You can access the app library by pressing its symbol in the bottom bar.



App library symbol

Some apps are pre-installed, such as Bluetooth media, Google Maps and Google Assistant. You can search for and download new apps via Google Play, which can be accessed in the app library.

---

## 3.4.1. Downloading apps

Download more apps to your car from the app store in the app library.

Your car comes with some apps pre-installed, but you can find and download more in the app store.

To be able to download apps, your car must be at a standstill and connected to the internet.

1. Press the app library symbol  in the bottom bar.
2. Press **Get more apps** to go to the app store.

 **Note**

To be able to open Google Play, the current user profile must be signed in to a Google account.

3. Search for the app you want to download.
  4. Download and install your desired app.
- > If the app is successfully downloaded and installed, it appears in the app library.

---

## 3.4.2. Uninstalling apps

You can uninstall apps you no longer want or use in the app library.

 **Note**

Pre-installed apps, such as phone and radio, can't be uninstalled.

1. Press the app library symbol  in the bottom bar.
  2. Find the app you want to uninstall, then press and hold the app until a menu appears.
  3. Select **Uninstall** from the menu.
  4. Press **Uninstall** to continue uninstalling the app.
- > The app is uninstalled and it disappears from the app library.



Tip

You can also uninstall apps by going to the privacy settings, pressing **Show all apps** and selecting the app you want to uninstall.

---

## 3.5. Connectivity and software

Connect your car to the internet to get more from your car and receive over-the-air software updates.

### Internet connectivity

Connect your car to the internet via Wi-Fi, a Bluetooth-connected mobile phone or the car's built-in mobile network connection<sup>[1]</sup>.

### Software updates

Over-the-air updates keep your car's software up to date.

<sup>[1]</sup> Availability may vary between regions.

---

### 3.5.1. Internet connection

Connecting your car to the internet gives you access to certain features and over-the-air software updates.

There are several ways to connect your car to the internet. When the car can access the internet in more than one way, it prioritises them in the following order:

- Wi-Fi network
- Bluetooth-connected phone tethering
- Mobile network<sup>[1]</sup>

#### Wi-Fi

You can connect the car to a Wi-Fi network for internet access. The car can automatically connect to the network whenever it's within range.

#### Bluetooth-connected phone tethering

When a phone is connected to the car via Bluetooth, the car can use the phone's mobile internet connection. To do this, Bluetooth tethering needs to be enabled for the phone in the car's connectivity settings. Both the phone and the mobile network provider need to support sharing an internet connection through tethering.

## Mobile network<sup>[1]</sup>

Your car has a built-in modem for connecting to a mobile network. The mobile internet connection is set up before you get your car and is included for a certain number of years. As long as the car has an active mobile network service plan and it's in an area with network reception, it can connect to the internet. Contact an authorised Volvo workshop for information about mobile connectivity services for your car.

The car supports mobile networks up to, and including, 4G.

### Note

#### Internet consent

You need to accept the internet terms and conditions before using the mobile network internet. Just go to **Internet terms of service** in the privacy settings to accept and also check that you have accepted the terms and conditions.

#### Mobile network connectivity conditions and limitations

- The car needs to be in an area with mobile network reception.
- Mobile connectivity services must be active for the region in which the car is located.
- Obstacles such as buildings, hills and mountains can weaken or block the mobile network signal.

## Internet connection settings

You can find the connectivity settings in the centre display.

<sup>[1]</sup> Availability may vary between regions.

---

### 3.5.1.1. Connecting to the internet via a Bluetooth-connected phone

Connect your phone to the car via Bluetooth and share its internet connection.

### Note

Sharing your phone's mobile internet connection with the car will affect the amount of mobile data you use. Some mobile data providers might not allow this kind of data use. It's possible that the available amount will be limited or the providers may charge you extra money for it. Make sure you check your provider's conditions for data usage before activating Bluetooth tethering.

You need to connect your phone to the car via Bluetooth before you can share your phone's internet connection.

1. Press the car symbol  in the bottom bar and go to **Settings**.

2. Go to **Connectivity** → **Bluetooth**.
  3. Press the Bluetooth tethering symbol  for the phone that you want to share the internet connection from.
  4. Press **Accept** to continue with the tethering activation.
- > The Bluetooth tethering symbol changes colour, indicating that tethering is now active.

---

## 3.5.1.2. Connecting to the internet via Wi-Fi

Connect your car to a Wi-Fi network for internet access.

 **Note**

You can only connect to a new Wi-Fi network while the car is stationary. If you are driving and want to connect to a Wi-Fi network, you can only connect to a saved network.

1. Press the car symbol  in the bottom bar and go to **Settings**.
  2. Go to **Connectivity** → **Wi-Fi**.
  3. Enable Wi-Fi if it is disabled.
  4. Select the Wi-Fi network you want to connect to.
  5. Enter the Wi-Fi network password using the centre display's keyboard and press **Done**.
- > The car connects to the Wi-Fi network.

---



## 3.5.2. Restarting the car's connectivity module

You can restart the car's connectivity module using the max defroster button in the button panel underneath the centre display.

If you are having problems with the car's connectivity, such as losing internet connection, restarting it might be a way to resolve any issues.

### **Warning**

You must park your car when restarting the connectivity module because the automatic collision alarm related to emergency assistance will be disabled during the restart.

1. Press and hold the max defroster button  in the button panel underneath the centre display. Keep pressing the button until the SOS button in the car's ceiling starts to flash.
2. Stop pressing the max defroster button .
- > The connectivity module restarts.
3. Wait a few minutes for connectivity to come back.

## Internet connection still not working?

If the internet connection still isn't working after two days, try restarting the connectivity module again. If this doesn't resolve the issue, contact an authorised Volvo workshop.

## 3.5.3. Over-the-air updates

Over-the-air updates keep your car's software up to date.

When your car is connected to the internet, it can receive over-the-air<sup>[1]</sup> updates to keep the car's software up to date. The car will tell you when there is an update available to download and install by displaying a notification.

You can also check for new software updates by going to **System** → **System details** → **Software update** in settings.

### Downloading software updates

To be able to download a software update, your car must be connected to mobile internet and you must have approved the use of connected services. Your car downloads the update using a mobile network.

### **Note**

You might incur data usage charges when downloading software updates. This depends on what data usage is included in your mobile internet contract.

### Installing software updates

When a new software update is available, the car will download the update but it won't install it for you. You need to start the installation yourself, either via a notification in the centre display or in the software update view. You can also choose to postpone the update so that it installs at a later time.

You can't use your car's functions while a software update is installing, so make sure that you don't need to use your car at all while installing the update. The installation process only starts after you get out of your car and lock it. If you don't lock your car within a few minutes of starting the installation, the update will be cancelled and you can try to install it again later.

**i Note**

If you really need to access your car during the installation process, you need to use the standard key's detachable key blade to open the car.

**i Note**

### Installation issues

There might be updates that you can't install yourself. If this happens, you will see a notification in the centre display telling you what to do next.

### Don't use the diagnostic port

Don't use the diagnostic port while a software update is installing. Using the diagnostic port during an installation might affect the car's systems and the software update.

### Alarm disabled

To avoid any false alarms, the car's alarm is disabled during the software installation process.

[1] OTA

---

## 3.6. Voice control

Keep your hands on the wheel and use your voice to interact with the car via the digital assistant.

With the help of the digital assistant, you can use voice control to carry out tasks, such as searching the internet and getting weather forecasts. You can also use your voice to interact with the car and control a number of its functions, including:

- Media player
- Phone
- Navigation
- Climate

### Speaking to the digital assistant

The assistant understands everyday speech, so you don't need to know any specific voice commands to use it. You can ask the assistant anything and it responds by confirming what you said, then doing what you asked. It will let you know if it doesn't understand you.

 **Note**

- The voice control feature is from a third-party supplier. Availability, how to use it and how it works may vary over time and between regions.
- A poor internet connection may limit the number of available functions.

---

## 3.6.1. Using voice control

Use your voice to control and interact with a number of the car's functions via the digital assistant.

The only time you need to use specific voice commands to interact with the digital assistant is when you activate it. After activating the assistant, just speak or give instructions to it using everyday phrases.

 **Note**

Google Assistant isn't available in every language yet. Find out more at [support.google.com](https://support.google.com) [<https://support.google.com>] or try to use another language if you can.

1. Say "Ok Google" or "Hey Google" to activate Google Assistant.  
  
> The assistant confirms that it's listening.
2. Speak or give instructions to the digital assistant using everyday phrases.

 **Tip**

### Other ways to activate

You can also activate the digital assistant by pressing the voice control button on the steering wheel  and via the centre display.

### Sign in to your Google account

If you sign in with a Google account, Google Assistant will be more personalised when the car is online. For example, you can easily call contacts stored in your Google contacts or check what's in your Google Calendar.

## 4. Interior comfort and climate

Get familiar with your car's interior and the controls for seat adjustment, climate and windows.



Your car is equipped with multiple features to assist you in your driving. While some features are mainly for comfort, others improve visibility. Reading this section of the manual can assist in making your driving experience more comfortable.

---

### 4.1. Interior

Get to know the interior's layout and its practical features, such as cup holders and charging ports for your devices.

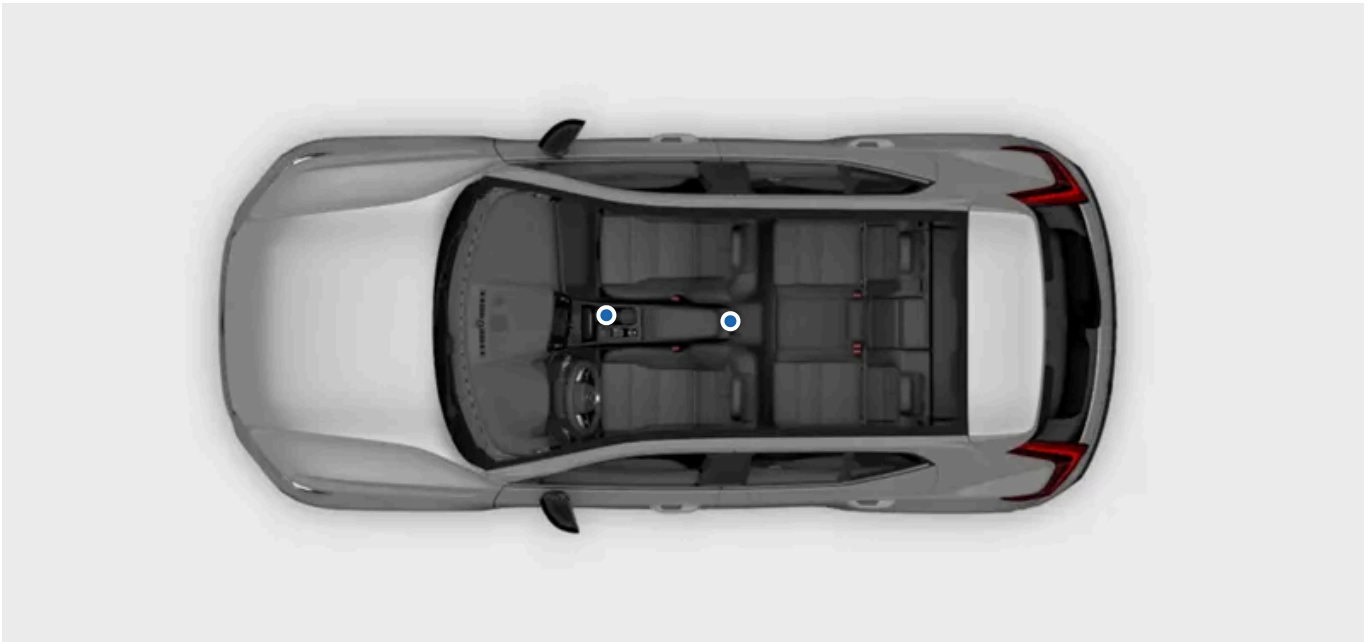

## Interior walk-through

There are a few places and components whose names and locations are good to know, as they are referenced throughout the manual.

<b>Passenger compartment</b>	The passenger compartment is divided into the front and rear passenger compartment.	
<b>Boot</b>	The boot, or cargo area, is the space behind the rear seats, which you typically access from behind the car.	
<b>Dashboard</b>	The dashboard refers to the whole set of panels and components in front of the driver and front passenger. It has some of your car's main interaction areas, such as the displays, steering wheel, air vents and glove box.	
<b>Tunnel console</b>	The tunnel console sits between the front seats. Here you'll find a storage compartment, a wireless charger, an electrical socket, USB sockets and a cup holder.	There are also USB ports in the front and rear parts of the tunnel console.
<b>Door control panel</b>	Each door has its own set of controls for windows and locks.	

### *i* Note

There's a backup key reader in the bottom of the tunnel console's cup holder.

One of the detectors for the alarm is located under the reader. Avoid leaving coins, keys and other metal objects on the reader as this may trigger the alarm.

## 4.1.1. Using the wireless charger

Use the wireless charger to charge Qi-certified devices, such as a phone.



To use the wireless charger, your device should be certified to the Qi wireless charging standard. Also make sure that wireless charging is enabled on both the device<sup>[1]</sup> and on the charger itself. You can enable the charger in the centre display.

 **Warning**

Wireless charging may affect the operation of a pacemaker or other implanted medical devices. If you have one, consult your doctor before using the wireless charging system.

 **Important**

**NFC cards and charging**

Do not place cards with NFC<sup>[2]</sup>, such as electronic payment cards, between the wireless charger and the device when using the charging function. This could damage them.

If you have any cards or other sensitive items in your phone case, remove them before charging or make sure that they aren't between your phone and the charger.

Before charging a device, make sure there are no other objects on the charger.

1. Place the device in the middle of the charger.

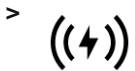

The device starts charging and the charging symbol appears in the centre display's status bar.

 **Warning**

Never leave your phone on the wireless charger when you leave the car.

 **Note**

- You may experience differing results when charging different devices. For example, the time it takes before charging starts and how quickly a device is fully charged.
- Your device might get hot during charging. This is normal and nothing to worry about. If the device's battery temperature becomes too high, charging is deactivated.

## If the device doesn't charge

A notification appears in the centre display if the charging system detects something wrong with the charging. If this happens, there are some steps you can try:

- Make sure you have enabled the charger in the centre display.
- Make sure there are no items on the charger apart from the device you want to charge.
- Lift the device and then place it back in the middle of the charger.
- Remove any cases or covers from the device.
- Disable the device's NFC function if it has one.

<sup>[1]</sup> Many Qi-certified devices are always enabled

<sup>[2]</sup> Near Field Communication

---

## 4.1.2. Enabling the wireless charger

You can enable or disable the wireless charger in the centre display.

The charger has to be enabled before you start using it.

1. Press the car symbol  in the bottom bar and go to **Settings**.
2. Go to **Controls** → **More** → **Wireless device charging**.
3. Turn the charger on.

---

## 4.1.3. USB ports

You can use your car's USB ports to charge a phone, tablet or other device.

### Location of the USB ports

The content of this manual represents the status of the user manual at the time of printing and may not be completely valid in future instances. For more information, refer to the first page for the complete disclaimer note.

There are two USB ports inside the storage space in the tunnel console.



There are also two USB ports in the rear part of the tunnel console.



## Using the USB ports

Some devices may become hot during charging. This is normal.

The ports are usually disabled if you leave the car. If you leave the car unlocked, the ports will remain active for a while longer.

### Important

When using the USB ports, make sure you place the connected device where it won't injure any of the passengers in the event of heavy braking or a collision.

### Note

Always disconnect devices from the ports when not in use.

Devices connected to a 12 V socket may be activated even when the car is turned off.

### Tip

You can also activate reduced alarm sensitivity to keep the ports active for a while after leaving the car.

## USB port specifications

The power output of the USB ports depends on the device you are charging. The voltage and current is modulated to what is accepted by your device.

- Type C socket
  - Version 3.1
  - Voltage supply 5 V
  - Current supply max. 3.0 A
- 

### 4.1.4. 12 V socket

You can use a 12 V socket to power various electrical devices, such as a cooler box.



The 12 V electrical socket in the tunnel console



The 12 V electrical socket on the right-hand side in the boot

For the socket to supply current, turn the ignition on. The socket is then active as long as the 12 V battery level doesn't become too low.

The car turns off power to the socket automatically when the engine is switched off and you lock the car. If you leave the car unlocked, the socket remains active for a while longer.

The socket also stays active for a few more minutes if you turn on reduced alarm sensitivity before locking and leaving the car.

**Note**

Always disconnect devices from the socket and close the cover when not in use.  
Devices connected to a 12 V socket may be activated even when the car is turned off.

Some devices may become hot when charged through the 12 V socket. This is normal for many devices.

**Warning**

Failure to observe the following instructions could cause damage or personal injury.

- Do not use electrical devices with large, heavy plugs. They can damage the socket or come loose while driving.
- Do not use electrical devices that could interfere with the car's systems, such as the radio receiver.
- Only connect undamaged and fully working devices that meet all relevant safety standards<sup>[1]</sup>.
- Keep an eye on connected devices to prevent damage or injury if they malfunction.
- Do not connect adaptors or extension cables to the 12 V socket as these can override the socket's safety features.
- Do not expose the socket, connectors or connected devices to water or other liquids.
- Do not touch or use the socket if it appears to be damaged or has come into contact with water or other liquids.

## Power rating

**Important**

The maximum power draw is 120 W (10 A).

<sup>[1]</sup> CE marking, UL marking or similar compliance marking.

## 4.1.5. Sun visors

There are sun visors overhead in front of the driver's seat and the front passenger seat.



The visors can be folded down and angled to the side when necessary.

There is a covered mirror in the sun visor. The mirror light comes on automatically when you open the cover.

There is also a clip on the sun visor which can be used to conveniently place cards or tickets, for example.

---

## 4.2. Climate

Your car has the ability to provide a comfortable climate in the passenger compartment. It will cool, heat and dehumidify the air for you when needed. There are also built-in features which will provide good air quality.



This section of the manual covers the various climate features in your car, such as air conditioning, climate modes and heating options.

---

### 4.2.1. Climate controls

You can control the car's interior climate through various means, from both inside the car as well as from your phone.



Centre display and defroster buttons on the button panel below the centre display

You can control the car's interior climate here:

- The centre display
- The button panel below the centre display.

---

## 4.2.1.1. Activating seat heating



You can activate the seat heating via the comfort view in the centre display. There are three levels of heating to choose from.

In colder temperatures, it's nice to heat your seat for a more comfortable driving experience. You can activate and adjust the seat heating via the centre display.

### **Warning**

Seat heating should not be used by individuals who:

- have difficulties sensing temperature shifts due to sensory loss.
- have trouble controlling the seat heating settings.

1. Open the comfort view for the seat by pressing the corresponding seat symbol   in the bottom bar.
2. Select your preferred heating level.

To close the comfort view, press the downward arrowhead symbol in the bottom bar.



Tip

### Rear seat heating

Passengers can control their seat heating via physical buttons on the back of the tunnel console. Their seat heating can also be controlled from the centre display. Press the fan symbol  in the bottom bar and go to **Rear** to access the seat heating settings.

### Automatic seat heating

In cold weather you may appreciate the automatic seat heating. Go to climate settings to turn on automatic activation.

---

## 4.2.1.2. Activating the steering wheel heating

Steering wheel heating can be controlled via the centre display. You can activate it manually or set it to automatic activation.

In colder temperatures, it's nice to heat your steering wheel for a more comfortable driving experience. You can activate and adjust the steering wheel heating via the centre display.

1. Press the driver side's seat symbol in the bottom bar .
2. Select your preferred steering wheel heating level.



Tip



### Automatic steering wheel heating

In cold weather you may appreciate the automatic steering wheel heating. Go to climate settings to turn on automatic activation.

---

## 4.2.2. Climate settings

In climate settings, you can choose which functions should automatically activate when the car turns on.

You can access the climate settings by pressing the fan symbol  in the bottom bar and go to settings .

There are a number of climate functions you can set to automatically turn on and set the heat level for. These include:

- Seat heating
- Steering wheel heating

- Front defroster
  - Rear defroster
- 

## 4.2.3. Temperature and air conditioning

By using the automatic climate settings, your car's climate system aims to always provide you with a comfortable interior environment. However, if you want to, you can always make adjustments to your liking.

The auto climate mode provides a comfortable interior environment in most circumstances. However, adjustments can always be made. For example, you can make changes to the temperature settings, let different climate zones have their own settings and change the settings for the air conditioning.

---

### 4.2.3.1. Activating air conditioning

The air conditioning cools and dehumidifies the incoming air.

When you select the air conditioning it automatically activates or deactivates to maintain the set temperature.

For the air conditioning to work efficiently, windows, doors and the boot need to be closed.

1. Press the fan symbol  in the bottom bar.
  2. Press the air conditioning symbol *A/C*.
- 



### 4.2.3.2. Setting temperature

You can change the temperature in the passenger compartment via the centre display.

1. Press the temperature in the bottom bar.
  2. Use the plus or minus symbol to adjust the temperature.
-

### 4.2.3.3. Synchronising temperature

By default, the driver's temperature setting is used for all climate zones. However, each climate zone can also have its own individual setting. You can switch between the two options by desynchronising and synchronising the temperature.

1. Press the temperature setting in the bottom bar.
2. Press the synchronisation symbol  to desynchronise the temperature.
  - > The climate zones are desynchronised and the desynchronisation symbol appears.
3. Press the desynchronisation symbol  to resynchronise the temperature.

#### Tip

The temperature setting is also desynchronised when the passenger sets a different temperature on their side.

### 4.2.4. Air distribution and climate modes

The general air distribution is decided by the selected climate mode and settings. There are also air vents that offer additional adjustability of the airflow throughout the car.

#### Adjustable air vents



The locations of the adjustable air vents

The adjustable air vents can be redirected to control the direction of the airflow.

#### Climate modes

There are two climate modes – automatic and manual. The automatic mode takes care of most adjustments and climate functions for you. However, in manual mode, you can control more of the available adjustments and functions yourself.

You can also turn the climate system off completely.

 **Important**

### Condensation risk

Turning the climate system off completely may cause condensation on the windows, which could affect visibility.

The climate modes and their settings are available in the centre display's climate view.

---

## 4.2.4.1. Adjusting air vents

Adjustments to the air vents are done in the centre display as well as by using the physical air vent knobs.

You can change the air flow direction via the climate view in the centre display or physically using the air vent knobs on the air vents.

To open the air vent, turn the physical air vent knob. This allows the air to flow.

### Redirecting air flow via the centre display

1. Press the fan symbol  in the bottom bar.
2. Press the air flow symbols to select your preferred air flow direction.

### Redirecting the air flow physically

3. Move the physical air vent knobs to redirect the airflow.

 **Tip**

If you choose a specific air flow direction in the centre display while auto climate mode is active, the climate system will change to manual mode. You can always go back to auto climate mode again by selecting **Auto** in the climate view.

---

## 4.2.4.2. Activating auto climate mode

When you activate auto climate mode, the climate system controls several of its functions automatically.

 **Note**

The automatically-regulated climate control system is deactivated when the air distribution is changed manually or when maximum defroster is activated.

1. Press the fan symbol  in the bottom bar.
2. Press **Auto**.
3. You can change the fans' power level and the temperature if you prefer.

---

### 4.2.4.3. Activating manual climate mode

If you activate manual climate mode, you can set your preferred airflow direction.

1. Press the fan symbol in the bottom bar .
2. Select **Manual**.
3. Choose your preferred airflow direction and fan power level.

---

### 4.2.5. Ice, condensation and defrosters

In cold conditions, ice and condensation can obstruct visibility. Your car is equipped with defrosters, a heated rear windscreen and heated wing mirrors to prevent that from happening.

There are defrosters placed by the windows and windscreen. The wing mirrors heat up at the same time as the rear windscreen. Combined, these functions aim to ensure good visibility.

 **Important**

Always make sure the windows and windscreens have good visibility before you start driving.

---

#### 4.2.5.1. Defrosting the front windscreen and windows

The content of this manual represents the status of the user manual at the time of printing and may not be completely valid in future instances. For more information, refer to the first page for the complete disclaimer note.

To quickly remove condensation and ice from the front windscreen and windows, you can activate max defroster.



Max defroster button on the button panel below the centre display

Max defroster raises the fan speed and temperature. Air conditioning is activated and air recirculation is unavailable while max defroster is active. When max defroster is turned off again, the climate settings return to their previous levels.

**Note**

When max defroster uses the high fan speed, the noise level of the fans increases.



Your car also has a heated windscreen to help remove condensation and ice.

You can activate the max defroster and the heated windscreen via the centre display or the button panel below the centre display.

**Activating via the button panel**

1. Press the max defroster button  once to activate the heating of the windscreen.
2. Press the button again to activate the max defroster as well.
3. Press the button a third time to turn both off.

**Activating via the centre display**

4. Press the fan symbol in the bottom bar .
5. Press the max defroster symbol  to activate the max defroster.  
Press the heated windscreen symbol  to activate the heated windscreen.
6. Press the symbol again to turn it off.

**i Tip**

### Automatic heated windscreen

In climate settings, you can set the heated windscreen to automatically turn on when you start the car in cold conditions.

Press  in the climate view and go to **Electric front defroster**.

## 4.2.5.2. Activating rear windscreen and wing mirror heating



Activate the rear windscreen and wing mirror heating to get rid of condensation and ice.



Rear defroster button on the button panel below the centre display

You can activate the rear windscreen and wing mirror heating via both the centre display and the button panel below the centre display.

### Activating via the centre display

1. Press the fan symbol in the bottom bar .
2. Press the rear defroster symbol .

### Activating via the button panel

3. Press the rear defroster button .

**i Tip**

### Automatic rear defroster

In climate settings, you can set the rear defroster to automatically turn on when you start the car in cold conditions.

Press  in the climate view and go to **Rear defroster**.

## 4.2.6. Interior climate when parked

Your car can maintain a comfortable interior climate when parked.

### Keeping heating active after parking

You can keep the passenger compartment warm after parking by using the heat generated from your drive. You can activate the function via the centre display.

#### Note

Parking climate functions automatically turn off when their maximum running time is reached.

#### Warning

Never leave a child or pet unattended in your car. You are responsible for their safety and well-being. Some regions have laws prohibiting people or pets being left inside a locked vehicle.

### 4.2.6.1. Keeping heating active after parking

You can keep the passenger compartment warm after parking by using the heat generated from your drive.

When the engine is off and you want to stay in the car, you can choose to use the heat generated from your drive to keep the passenger compartment warm.

#### Note

The amount of residual heat available limits how long the passenger compartment can stay heated in a cold climate.

1. Press the fan symbol in the bottom bar .
  2. Press **Use heat from drive**.
- > The car uses heat generated from your drive to keep the passenger compartment warm.

Press **Stop using heat from drive** to turn it off.

The heating is automatically turned off when you lock and leave the car.

## 4.2.7. Air quality

Your car is designed to provide a pleasant and healthy interior climate. Air filtering helps to remove odours, substances and particles from the passenger compartment.

### Passenger compartment air filter

The air going into the passenger compartment is first filtered through the climate control system. To ensure high performance, the filter needs to be replaced regularly. If the filter is exposed to intense use, such as prolonged driving through areas of smog or dust clouds, then the filter needs to be changed more frequently. If you are uncertain about what kind of filter to use, contact Volvo support.

### Air quality system

The air in the passenger compartment is purified by:

- filtering allergy and asthma-inducing substances.
- removing gases and particles to reduce odours.
- removing air contaminants such as particles.

If the air quality sensors detect contaminants in the outside air, the air intake closes and internal air recirculation activates.

### CleanZone

CleanZone indicates whether conditions for good air quality are met or not.

---

## 4.2.7.1. Air quality indication

The air quality tab in the centre display's climate view provides you with information on the air quality both inside and outside of the car.

Information in the air quality tab indicates the quality of the inside and outside air. A sensor measures the content of particles smaller than 2.5 µm in the passenger compartment. The information on the content of contaminants outside the car is provided by an external service and is based on modelled data.



Tip

For some regions, information on pollen levels is available. Press **Air quality and pollen** to see more detailed information.

---

## 4.2.7.2. Air cleaning

To provide good air quality, your car is equipped with different air cleaning capabilities.

Your car has multiple functions to ensure good air quality. Some of these are passive and some can be controlled in the centre display.

---

### 4.2.7.3. CleanZone

CleanZone is an air quality function that controls and indicates whether all conditions for providing good air quality are met or not.

You can find information regarding the air quality in the climate view. CleanZone is obtained if all conditions to provide a good air quality in the passenger compartment are met. If it can't be obtained, you can see in the centre display which condition is still not met.

---

### 4.2.7.4. Activating air recirculation

Air recirculation helps you keep out harmful or foul-smelling air from the passenger compartment. In some cases, it's activated automatically but you can also activate it manually in the climate view.

By default, the climate system automatically decides whether to recirculate the air depending on certain environmental conditions. If the air quality sensor notices that the exterior air is polluted, your car will automatically close the air intake and instead recycle the air in the passenger compartment. You can also manually activate constant air recirculation to close the air intake if you want to.

#### Important



If the air is recirculated for a long period of time, condensation can fog up the windows, which can affect visibility.

#### Note

Air recirculation is unavailable while max defroster is active.

If activated manually, air recirculation will time out after a while.

In colder climates, air recirculation may not activate due to a risk of mist.

1. Press the fan symbol  in the bottom bar.
2. Press the recirculation symbol .

## 4.2.8. Climate system

Your car's climate system aims to provide everyone in the car with a comfortable environment using electronic climate control.

All climate control system functions are controlled via the centre display.

Your car uses sensors to automatically control different capabilities that are designed to offer a comfortable interior climate at all times.

---

### 4.2.8.1. Climate zones

Your car's passenger compartment is divided into different climate zones. These zones enable passengers to set their own preferred temperature to enjoy a comfortable environment.

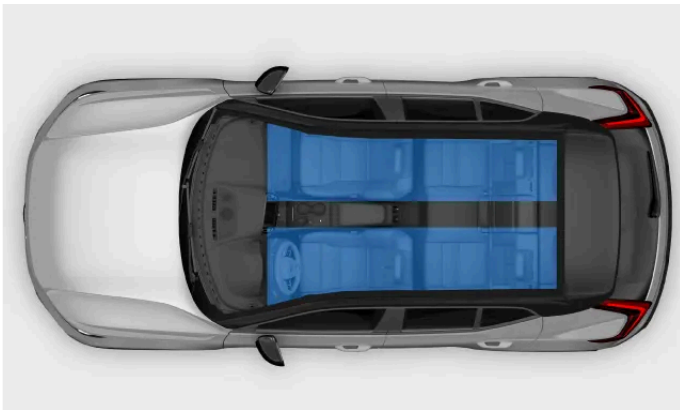

Climate zones

There are different climate zones in your car's passenger compartment. All zones are directly synced to the driver's preferred climate settings by default. However, the rear zones can have their own individual temperature setting.

---

### 4.2.8.2. Perceived and actual temperature

Your temperature perception is affected by more factors than the actual temperature of the air around you. Knowing the difference between perceived and actual temperature can benefit your climate comfort experience.

Whether the air in your car feels warm or cold depends on its temperature as well as several other factors. These factors include your own body temperature, airflow and humidity in the car and whether you're exposed to direct sunlight. When you adjust the temperature setting, the car considers some of the factors contributing to your perceived temperature. The car then continuously adapts its climate functions to make the interior climate feel like the temperature you selected. This means that the actual temperature in your car can differ from the temperature you selected, giving you a more consistent climate comfort experience.

Your car takes exposure to sunlight into consideration when regulating the climate in the car. For example, if the sun hits the driver's side, it can adjust the airflow and temperature to balance the perceived temperature on that side.

---

### 4.2.8.3. Climate sensors

There are several climate sensors located inside and outside of your car. These sensors help to provide a comfortable climate in the passenger compartment.

For the interior sensors to be able to perform as intended, it's important that you don't cover them.



The interior climate sensors

- ① Moisture sensor in the rear-view mirror console.
- ② Sunlight sensor on the upper side of the dashboard.
- ③ Passenger compartment temperature sensor under the centre display.
- ④ Airborne particulate matter sensor on the underside of the glove box.

The exterior ambient temperature sensor is located in the right wing mirror.

---

## 4.3. Windows and glass panes

Your car has several different windows and glass panes. The windscreen is laminated for added safety and security.

Any laminated windows, except for the windscreen and panoramic roof, are labelled with a laminated glass symbol.



### Panoramic roof

The panoramic roof is divided into two glass sections. You can open the front part vertically or horizontally using the control in the overhead console, whereas the rear section is fixed roof glass.

---

## 4.3.1. Operating the windows

You can use the power switches in the door panels to operate the windows. The switches in the driver door can control all of the windows in your car.

### **Warning**

Always consider the safety risks while operating the windows. The car's moving parts can cause injury to children or other occupants, as well as damage to objects.

- Make sure you have a clear view of the windows you operate.
- Do not allow children to play with the window controls.
- Never leave children alone in the car.
- Always switch off the power supply to the power windows by turning the ignition off. Take the key with you when leaving the car.
- Never put an object or body part through an open window, even if the car's electrical system is fully disconnected.

All of the windows have built-in pinch protection to help prevent injuries. Be sure to read the relevant information on pinch protection in its separate section of the manual.

To use the power windows, you need to turn the ignition on. However, if you turn the ignition off and don't open any of the doors, the windows may still work for a few minutes.

### **Note**

Situations where the windows can't be opened

- The windows cannot be opened at speeds above approximately 180 km/h (112 mph) but they can be closed.
- At very low temperatures, the windows might freeze in place and you won't be able to operate them.

1.



Use the switches to open or close the windows:

- A slight push or pull allows you to manually operate the window until you release the switch.
- If you push or pull the switch fully, the window automatically moves even if you release the switch. Stop it by moving the switch in the opposite direction.

**The content of this manual represents the status of the user manual at the time of printing and may not be completely valid in future instances. For more information, refer to the first page for the complete disclaimer note.**

**i Tip**

### Operating all of the windows at the same time

If you're carrying a key, you can open or close all of the windows at the same time by holding a finger against the indentation on the outside of the door handle. You can also press and hold the locking button on your standard key.

### Noise reduction

One way to reduce wind noise when the rear windows are open is to also open the front windows slightly.

### Child lock

You can disable the rear window controls. This prevents rear seat passengers from operating the windows.

**i Note**

If automatic window movement or pinch protection isn't working properly, you may need to reset the windows. You can learn how to do this in a separate section of the manual.

## 4.3.2. Operating the panoramic roof

You can open and close the panoramic roof and the sun blind to control how much air or sunlight you let in.

You can operate the panoramic roof and the sun blind by using the touch-sensitive control in the overhead console.



By touching or swiping over the control in different ways you can:

- open and close the sun blind
- tilt the front part of the panoramic roof to open it in the vent position
- retract the panoramic roof partially or fully
- close the panoramic roof.

 **Note**

- Remember to remove ice and snow before opening the panoramic roof. Take care not to scratch surfaces or damage trims.
- At very low temperatures, the panoramic roof might freeze in place and you won't be able to operate it.

**Opening the vent position**

- Tap anywhere on the control.
- > The panoramic roof tilts open to the vent position.

**Closing the vent position**

- From the vent position, tap anywhere on the control.
- > The panoramic roof closes.

**Opening the sun blind**

- Swipe backwards once over the control.
- > The sun blind opens.

**Opening the panoramic roof**

- Swipe backwards twice over the control.
- > The roof opens partially.
- Swipe backwards three times over the control.
- > The roof opens fully.

**Closing the sun blind and panoramic roof**

- Swipe forwards over the control.
- > The sun blind and the panoramic roof close.

 **Tip**

**Closing the sun blind automatically**

You can turn on **Auto-close sunroof curtain** in settings to make the sun blind close automatically after 15 minutes if the car is parked and locked in warm weather. This helps ensure a comfortable passenger compartment temperature and protects the car's upholstery from fading in the sun.

**Operating all of the windows at the same time**

If you're carrying a key, you can open or close all of the windows at the same time by holding a finger against the indentation on the outside of the door handle. You can also press and hold the locking button on your standard key.

 **Warning**

Always consider the safety risks while operating the panoramic roof. The car's moving parts can cause injury to children or other occupants, as well as damage to objects.

- Make sure you have a clear view of the panoramic roof when operating it.
- Do not allow children to play with the panoramic roof controls.
- Never leave children alone in the car.
- Always switch off the power supply to the power windows by turning the ignition off. Take the key with you when leaving the car.
- Never put an object or body part through an open window or panoramic roof, even if the car's electrical system is fully disconnected.
- Do not open the panoramic roof when load carriers are fitted.
- Do not place any heavy objects on the panoramic roof.

 **Note**

If pinch protection for the panoramic roof isn't working properly, contact an authorised Volvo workshop.

### 4.3.3. Pinch protection

To help prevent injuries from power-operated windows and other moving parts, your car has a built-in pinch protection system. Occupants should also keep proper user practices in mind to reduce the risk of getting caught between moving or closing parts.

If something is blocking the window or panoramic roof when it's closing, it will stop and then slightly reverse, allowing you to remove what's in the way. The boot is covered by pinch protection in a similar way when opening or closing.

 **Warning**

Always consider the safety risks while operating the windows. The car's moving parts can cause injury to children or other occupants, as well as damage to objects.

- Make sure you have a clear view of the windows you operate.
- Do not allow children to play with the window controls.
- Never leave children alone in the car.
- Never put an object or body part through an open window, even if the car's electrical system is fully disconnected.

If the automatic closing of a window stops due to obstructions, such as ice, you can still try to close the window manually by continuing to pull the control switch. However, always try to remove the source of the obstruction first and make sure nothing is blocking the path of the window before trying to close it again.

If there is a problem with the pinch protection for the power windows, you can try to solve the issue by resetting them.

If pinch protection for the panoramic sun roof isn't working properly, contact an authorised Volvo workshop.

 **Warning**

The power window pinch protection may not work properly if the car loses track of the current window position. The window positions are recalibrated when you reset the automatic window movement. Always reset it to make sure the window positions are correctly calibrated if:

- the car has lost power, for instance if the 12 V battery has been disconnected.
- the automatic window movement does not work properly.

This restores the automatic window functionality and re-enables the pinch protection function.

---

## 4.3.4. Resetting windows

If you're experiencing issues with a power-operated window, you may need to reset it. This allows the car to recalibrate their position, restoring both pinch protection and automatic movement.

 **Warning**

The pinch protection system might not work properly until the window has been reset after losing calibration.

If the 12 V battery has been disconnected, a reset is required for pinch protection to work.

 **Note**

If the panoramic roof isn't working properly, contact an authorised Volvo workshop.

Before resetting a window, make sure it's fully closed.

### Resetting window

1. Pull the window switch upwards to the manual position three times, towards the closed position.
- > Recalibration is now done, re-enabling both pinch protection and the automatic window movement.

Check to make sure that the window operates correctly after following the reset steps. The window should close completely when you pull the switch all the way and release. If the problem persists, contact an authorised Volvo workshop.

## 4.4. Seats

The seats are all designed to provide comfort and safety. Adjust the seats, activate comfort functions, and make sure to sit properly.



The seats of the car have a range of features to provide comfort, safety and flexibility.

In this section of the manual, you'll get to know the comfort features and adjustments available for the car seats. This includes features such as the seats' positional adjustments and how to fold the rear seats to get more space for stowing. At the same time, you will learn the essentials of how to use these features safely and properly.

For more information about the passive safety functions of the seats and to learn how to accommodate them through proper seating, there is a separate safety section in this manual.

---

### 4.4.1. Front seats

The front seats have plenty of adjustability to increase comfort.



#### Adjustability

The content of this manual represents the status of the user manual at the time of printing and may not be completely valid in future instances. For more information, refer to the first page for the complete disclaimer note.

The seats have the following adjustment options:

- Driver seat cushion tilt
- Extending seat cushion
- Seat position
- Lumbar support
- Seat height
- Backrest tilt

**i Tip**

You can also adjust the headrest up or down by pressing the button and manually moving the headrest to the desired position.

## Features

The front seats also have the following comfort features:

**Heating** The seats have three levels of heating available.

### 4.4.1.1. Adjusting front seats

The car's front seats have a variety of settings to enhance comfort.

#### Seat adjustment controls



Controls on the side of the seat

- ① Lumbar support control
- ② Seat cushion control
- ③ Seat position control
- ④ Backrest control

 **Tip**

You can adjust the length of the seat cushion manually by using the handle on the front of the seat.

 **Warning**

Never adjust the seat while driving. This can cause dangerous distraction and loss of control. Instead, be sure to make all necessary adjustments to the seat before starting a drive.

#### Adjusting lumbar support

1. Press the four-way control upwards, downwards, forwards or backwards to adjust the lumbar support.

#### Adjusting seat cushion tilt

2. Tilt the seat cushion control up or down to adjust the seat cushion.

#### Adjusting seat position

3. Move the seat position control left or right, up or down to adjust the position of the seat.

#### Adjusting backrest tilt

4. Tilt the backrest control in the same direction you want to tilt the backrest.

 **Important**

Once you've finished adjusting the seat to your liking, it's important to make sure other parts of the car are aligned correctly. Your driving posture is important and is affected by more than your seat adjustments, such as the position of your steering wheel and mirrors.

After adjusting, folding or raising a seat, make sure all parts of the seat are properly locked in place.

## 4.4.1.2. Saving a preset seat adjustment

You can save preset seat adjustments for the front seats.

 **Warning**

- Because the driver's seat can be adjusted with the ignition off, children should never be left unattended in the vehicle.
- Movement of the seat can be STOPPED at any time by pressing any button on the power seat control panel.
- Do not adjust the seat while driving.
- Make sure there is nothing under the seats when they are being adjusted.

By using the preset seat adjustment buttons, you can easily sit in your preferred position again without needing to adjust the seat yourself. The buttons are located on the inside of either one or both front doors.

When you save a preferred position for the driver seat, it automatically saves your current positions for the wing mirrors. However, saved positions for the passenger seat do not affect wing mirrors.



Location of the preset seat adjustment buttons

1. Adjust the seat to your preferred position.
2. Press the M button.
  - > The button's indicator light turns on.
3. Press and hold down one of the memory buttons within three seconds of pressing the M button.
  - > When the position has been saved, you will hear a sound signal and the indicator light turns off.

**Note**

If none of the memory buttons are pressed within three seconds, the M button turns off and no position is saved. The seats must be readjusted before a new position can be set.

Your preferred positions are saved in the active user profile.

### Use a saved seat position

A saved position can be used with the front door open or closed. However, the process for activating the saved seat position differs.

If your front door is open, you can activate a saved position by pressing one of the memory buttons. The seat moves and stops in the saved position.

If your front door is closed, press and hold one of the memory buttons until the seat stops in the saved position.

If you want to change a saved seat position, adjust the seat to your preferred position and repeat the process again. A new seat position is saved on the selected memory button.

## 4.4.2. Rear seats

You can adjust the rear seats in a number of ways to get more space or use the additional features to better suit your needs.

The rear seats of the car are divided into the second and third row, each supporting its own set of features and adjustments. Both rows have two seats that can be folded separately.



There are several adjustments and features you can use in the rear seats to increase comfort or meet your need of stowing space.

<b>Foldable headrests</b>	The outer seats have foldable headrests. This can give you more space when you fold the seats.
<b>Adjustable centre headrest</b>	You can adjust the height of the centre headrest to fit the passenger, or set it to its lowest position when the seat is not in use.
<b>Foldable backrests</b>	You can fold the rear seats to create more cargo space. The left seat can fold on its own whereas the centre and right seats fold together.
<b>Seat heating</b>	The outer seats have access to three levels of heating. You can control this from the panel on the back of the tunnel console or from the centre display.



Tip

### Rear seat centre armrest

Fold out the centre seat backrest to access cup holders and get additional arm support.

## 4.4.2.1. Adjusting centre rear seat headrest

The centre seat headrest should be adjusted according to your height and fully support back of your head if possible.

A correctly adjusted headrest can help prevent neck injury during collisions. It's important to align the headrest to cover as much as possible of the back of the head.



Correct headrest level

Upward movement of the headrest is not locked.

1. Pull the headrest upwards to a level that fits your height.

To lower the headrest, press and hold the button at the base of the right support to release the lock. Then, carefully push the headrest down.



**i Tip**

Make a habit of lowering the headrest when the centre seat is not used. When it's down, it doesn't risk obstructing the rear view.

## 4.4.2.2. Folding down the outer rear seat headrests

You can fold down the outer second row seat headrests to improve rear visibility.

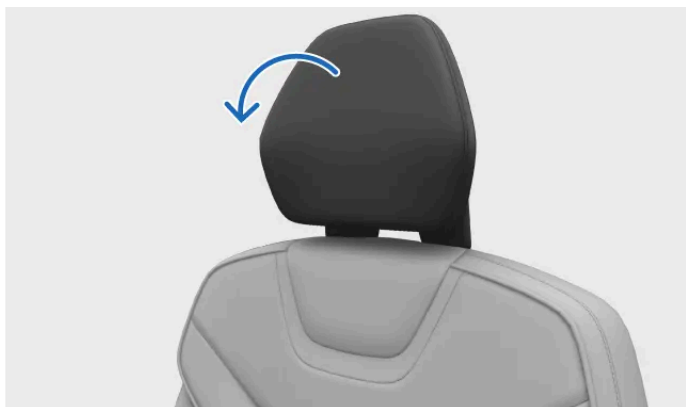

Folding motion of the headrest

**! Warning**

Never fold a headrest while a passenger is using the seat. This can cause serious injury.

**i Note**

You will not be able to fold the headrests if the child lock is active.

**! Important**

Before folding the headrests, make sure:

- there are no loose items left on the seats.
- the seatbelts are not buckled.

The headrest must always be raised when a child restraint is installed on the seat.

1. Press the car symbol  in the bottom bar and go to **Quick controls**.

2. Press the headrest fold button .

> The headrest folds down.

To raise the headrest again, manually move the headrest back until you hear a click.

---

### 4.4.2.3. Folding down the outer rear seats

You can fold the outer rear seats to get more stowing space. The left seat can be folded on its own while the centre and right seats fold together.

 **Important**

Before folding the seats, make sure:

- there are no objects on the seats.
- the seatbelts are not buckled.
- there is enough space to fold the seats down. If needed, move the seats in front forwards.

 **Warning**

If any of the rear seats are folded down, they must not be in contact with the seats in front. This can impede the safety of other occupants.



Pull the handle on the seat backrest.

> The backrest and headrest release and tilt forwards.

- Guide the backrest down to its folded position.

Manually push the backrests to their upright position when you no longer need the extra cargo space. Make sure the backrest locks into place. Finally, move the headrest back to its locked position.

**!** **Important**

After adjusting, folding or raising a seat, make sure all parts of the seat are properly locked in place.

---

## 4.4.2.4. Rear seat centre armrest

Part of the centre rear seat backrest can be folded out to act as an armrest.

Pull down the armrest.



Rear centre armrest with cup holder.

The centre armrest can provide additional arm support but also contains a cup holder with two slots.

---

## 4.5. Interior lighting

The lights in your car's passenger compartment provide illumination for different purposes. There are lights for reading as well as for general illumination and lighting up storage areas.

### Reading lights

The front and rear seats have reading lights. You can adjust their intensity to suit your needs. In the rear, they also work as the general lighting.

### General illumination

Your car has lights to provide general illumination of the passenger compartment, such as when you get into the car. General illumination can be activated both manually and automatically.

## Ambience lights

The ambience lights in the car can provide a comfortable illumination of the passenger compartment when it's dark outside.

## Storage area lights

There are lights in different storage areas, such as the boot and door pockets, to make it easier to find what you're looking for.

---

### 4.5.1. Adjusting the reading lights

There are reading lights available for the front and rear seats. You can adjust the brightness according to your needs.

The front seat reading lights are located in the overhead console and the rear reading lights can be found over the rear doors.

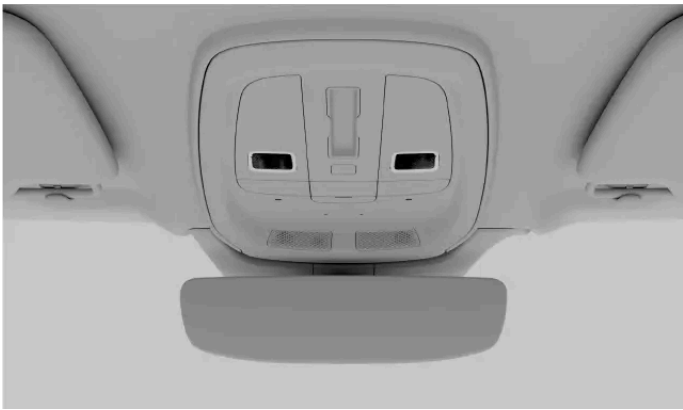

The front reading lights in the overhead console

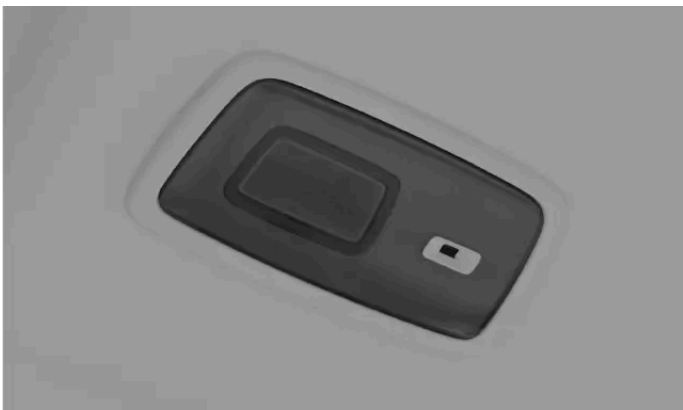

The rear seat reading lights

1. Press the reading light you want to turn on or off.
2. Hold the button down to adjust the brightness.

---

## 4.5.2. Adjusting interior lights

You can adjust the brightness of the interior lights to your liking.

You adjust the brightness of the interior lighting via the centre display.

1. Press the car symbol  in the bottom bar and go to **Settings**.
2. Go to **Controls** → **Lights and displays** → **Interior lights**.
3. Adjust the brightness or select your preferred intensity.

---

## 4.5.3. Disabling interior auto lights

The auto lights off function keeps the interior lights off, even when you are entering or exiting your car.



The auto lights off button in the overhead console

The interior auto lights function, sometimes called courtesy lights, turns the interior lights on automatically when a door is opened. The auto lights can make entering and exiting the car easier if it's dark outside. However, there may also be situations in which you don't want the lights to turn on, such as when passengers are sleeping in the car.

The auto lights off button is located in the overhead console and is marked with an auto lights symbol.



When the function is turned off, the button illumination changes colour.

1. Press and hold the button to turn the auto lights function on or off.

**i Tip**

A short press of the auto lights button switches on general lighting, such as the overhead and footwell lights.

## 4.5.4. Activating all interior lights

Activating all interior lights turns on most of the interior lights. This can be helpful when you're looking for something in the passenger compartment.



All interior lights on button in the overhead console

The activate all interior lights button is located in the overhead console and is marked with a light symbol.



1. Press the button to turn all interior lights on or off.

**i Note**

Holding the button down will disable the auto lights and the button will change colour. Even if auto lights have been disabled, the lights will still turn on if you use the lights all on function.

## 5. Safety

Get to know your car's collision-protection features and what's required for safe use of the car.

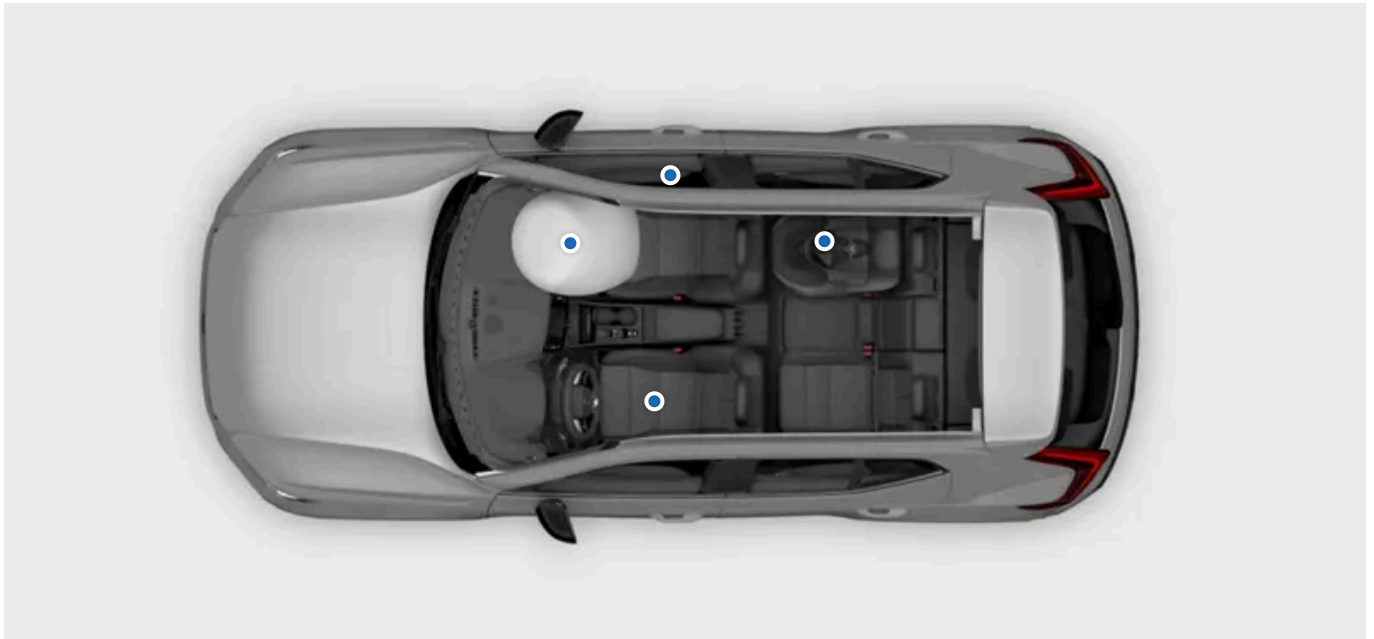

The safety section describes features designed to reduce the risk of serious injury in the event of a collision. The safety features include seatbelts, airbags, child restraints and other components or functions that can help save lives when used correctly.

Your car is designed to promote and provide the conditions for safe use. Safety features never replace the need for safe user practice. This not only applies to features directly related to safety, but also to the rest of your car. It's your responsibility to use the car's functions safely.

### **Warning**

#### Safety synergy

The safety features are designed to work together to increase the safety of all occupants in the car. No feature replaces the need for another unless the manual explicitly states so. For example, the presence of airbags in no way reduces the need to wear a seatbelt.

#### SRS warning

Sensors in the car can detect if there is something wrong with the airbags or related safety systems. A red warning symbol will appear in the driver display to alert you if any faults are found.



#### SRS warning symbol

If the red SRS warning symbol appears in the driver display, immediately contact an authorised Volvo workshop.

 **Note**

### Safety-related areas

Some driver support functions are related to safety. Instead of keeping you safe in the event of an accident, they are designed to prevent them in the first place. Get to know those functions as well for a safer trip.

## 5.1. Collision response

In the event of a collision, your car has many features designed to help mitigate the effects. Your car's response to a collision happens before, during and after the impact.

 **Tip**

You can find information related to collision response in many places throughout this manual. Therefore, this section exists to provide a more cohesive overview of your car's capabilities in this area.

### Before

Before an impact, several driver support functions can work to avoid the collision or reduce its effects. If the car perceives a collision to be likely or unavoidable, it has the ability to pre-emptively activate protective systems, such as seatbelt pretensioning, before the impact occurs.

### During

During the collision, sensors throughout the car continuously provide information about the states of the car and its occupants. The car uses the information to selectively time and activate protective functions such as airbag deployment and seatbelt pretensioning. Collisions are complex events that can unfold in several stages, where the first impact isn't necessarily the most severe. Good timing is essential for the best chance of effective protection.

The car's safety systems work in synergy with passive safety features. In the event of a collision, your car's construction distributes forces to specific structural components. It also takes advantage of crumple zones that absorb energy from the impact. Using similar principles, the exterior has been designed with the protection of pedestrians in mind.

### After

After a collision, the car tries to stop in a controlled and safe manner. It can also make an automated call for emergency response.

 **Note**

### Safety mode

During a collision, the safety systems of the car may deactivate certain functions. This is to protect both the occupants and the car itself from potential damage caused by collision. At the same time, the car enters safety mode. When safety mode is active, you cannot drive the car. However, depending on the severity of the collision, you may be able to exit safety mode by restarting the car if you need to move the car out of immediate danger. This in turn reactivates the necessary functions and enables short distance driving.

 **Important**

Your car is designed around safety, but no protective system is 100% effective in all situations. Safety features never replace the need for safe user practice.

## 5.2. Proper seating

Appropriate seating and proper seatbelt use are essential for the safety and comfort of everyone in the car. There are also specific recommendations for pregnancy and child seating.

 **Important**

### Importance of proper seating

Safety features, such as seatbelts and airbags, require that all occupants are properly seated for the best chance of effective protection in a collision. Failure to follow the seating instructions can endanger life or lead to serious injury.

### Pregnancy

Take extra care to follow all seating recommendations if the occupant is pregnant. The following are either additions or of extra importance:

- Make sure that the seatbelt does not cross the belly. The hip strap should be under the belly and the shoulder section should pass above it.
- If seated in the driver's seat, avoid sitting closer to the steering wheel than necessary. Adjust the seat to create as much distance between the belly and wheel as possible while also keeping all driver controls comfortably within reach.

### Child seating needs

Always seat children with extra care and attention to their needs. Make sure you have the required child restraint, that it's installed correctly and that the child remains safely seated throughout the entire trip. For children travelling forward-facing, the same seating recommendations apply as for adults. Always make sure the seatbelt is properly adjusted and that the headrest is at a height suitable for the child when possible.

**Note**

### Physical limitations

Physical limitations can prevent an occupant from following the seating recommendations. The car may need modifications to accommodate safe use. Contact an authorised Volvo workshop for information about Volvo-approved modifications.

## Sitting posture

Both sitting posture and proper seatbelt adjustment are important for safety. Avoid irregular sitting postures.

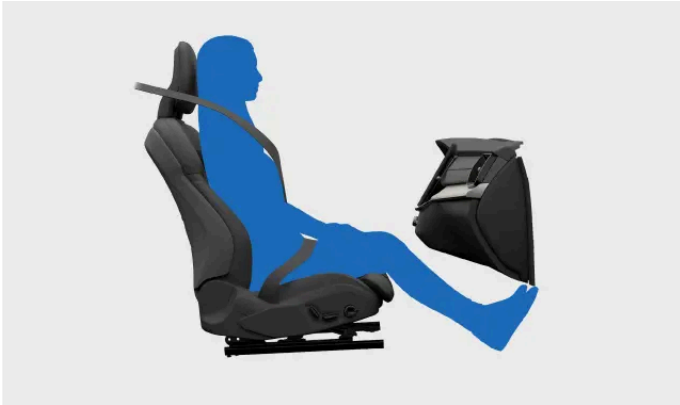

A correctly seated occupant. Do not adopt other postures when the car is moving.

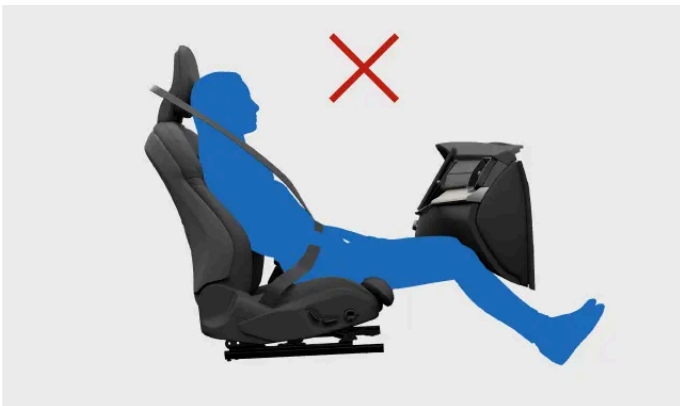

Do not slide forward in the seat. The lower back should have contact with the backrest.

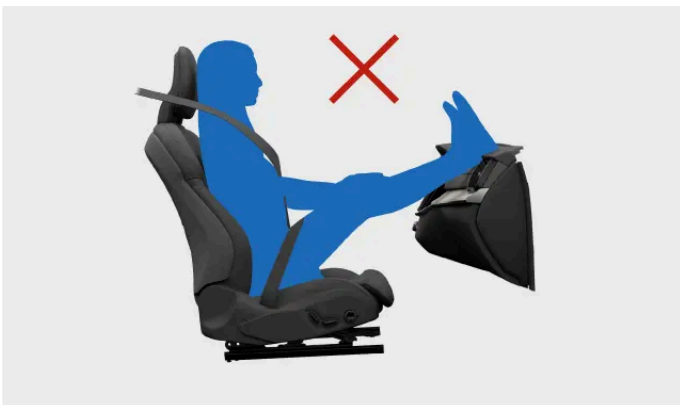

Keep both feet planted on the floor.



Do not tilt the backrest to a lying position. The seatbelt must remain tensioned against the shoulder.

## Whiplash protection considerations

Proper headrest use is essential to reduce the risk of neck injuries in a collision. All of the car's headrests are designed to help protect the head and neck when used correctly. As an added safety feature, the front seats' construction can reduce the risk of whiplash injuries in certain collisions. These seats are designed to shift in a way that lowers whiplash-associated forces.

- Keep the back of your head against the headrest.
- Make sure occupants have correctly adjusted headrests where possible.
- Avoid stowing luggage against the back of the front seats. It can prevent the seat from moving as intended in the event of a collision.

---

## 5.3. Seatbelts

When you use seatbelts correctly, they can help prevent serious injury in situations ranging from sudden braking to severe collisions.

## Seatbelt features



The seatbelt locks itself to act as a safety restraint under certain conditions, such as sudden and forceful pulling of the belt, if the car is driven aggressively and if the car is on a steep incline.

The seatbelt can also adjust as a safety precaution in a high-risk situation.

Built-in seatbelt pretensioners can tighten the seatbelts extremely quickly in response to a collision.

## Seatbelt reminder

The car uses built-in sensors to detect if the driver or any of the passengers aren't using their seatbelts. The system alerts the driver with a warning sound and the seatbelt reminder symbol appears in the overhead console.



Seatbelt reminder symbol

 **Important**

## Wearing seatbelts

These are the essentials for wearing seatbelts properly. There is also more detailed information in other sections of the manual covering proper seating and seatbelt adjustments.

- Make sure that everyone in the car wears their seatbelt and that all belts are properly adjusted.
- Adjust the upper anchor point of the seatbelt to fit the wearer's size.
- Wear the seatbelt closely against the body.
- Minimise slack in all belt segments.
- Allow the belt to run as straight as possible between its three anchor points.<sup>[1]</sup>
- Have the backrest in an upright position.
- Follow all seating and posture recommendations.<sup>[2]</sup>
- Do not wear the seatbelt in ways other than those described in this manual.
- Always use seatbelts when driving.
- Never use the same seatbelt for more than one individual at a time.

 **Warning**

## Seatbelt care and maintenance

- Never modify or repair seatbelts or related parts, such as fittings and hooks, yourself. Any service or replacement must be done by a trained technician with access to type-approved parts.<sup>[3]</sup>
- Contact an authorised Volvo workshop if the seatbelt or a related part shows signs of damage or wear.
- Replace the seatbelt if it has been subjected to a heavy load, such as in a collision. It may have lost protective properties even if there is no apparent damage.
- Clean the seatbelt as soon as possible if anything is spilled onto it. The spilled substance can enter the mechanism and deteriorate the material.

<sup>[1]</sup> For example, never wrap around or attach it to other items or fittings in the car.

<sup>[2]</sup> There are general seating recommendations as well as specific recommendations for children and pregnant occupants.

<sup>[3]</sup> Volvo recommends an authorised Volvo workshop.

## 5.3.1. Fastening and adjusting seatbelt

A correctly fastened and adjusted seatbelt is important for your safety as well as comfort.



Correctly fastened and adjusted seatbelt.

**i Note**

These instructions apply to adults and children who are seated normally or are using a booster seat or booster cushion. Read the separate section covering child safety for detailed information about child seating and different types of child restraints.

### Fastening the seatbelt

1. Pull the seatbelt out by the latch plate. If you pull too fast, the locking mechanism will engage.
  2. While extended, check the belt for twists, knots or damage.
  3. Insert the latch plate into the buckle.
- > The latch plate clicks into place.

**! Warning**

#### Check when seatbelt is fastened

- The seatbelt should run directly and as straight as possible between its three anchor points. Any unnecessary slack increases the risk of injury.
- Make sure everyone in the car is wearing their seatbelt correctly.
- Use the correct buckle for each rear seatbelt. Using the wrong buckle can lead to a seatbelt malfunction or failure.

### Adjusting the seatbelt

4. For occupants in the front seats, adjust the height of the seatbelt's upper anchor point.



Seatbelt upper anchor point

1. Hold the button on the upper anchor point down to allow it to slide up and down.
  2. Place it as high as possible without the belt touching the throat or neck.
5. Tension the hip strap to remove slack by pulling upwards on the diagonal chest strap. It should be as straight and low as possible, running below the abdomen.

 **Important**

### Pregnancy

Take extra care to follow all seating recommendations if the occupant is pregnant. Make sure that the seatbelt does not cross the belly. The hip strap should be under the belly and the shoulder section should pass above it.

#### Releasing the seatbelt

6. Release the seatbelt by pressing the buckle button.
7. Guide the seatbelt back to its retracted position.

 **Important**

Make sure the seatbelt retracts fully after using it. Closing a door with the seatbelt caught in the gap can damage both the seatbelt and the door.

## 5.3.2. Seatbelt reminder

The car uses built-in sensors to detect if the driver or any of the passengers aren't using their seatbelts.

If the car detects any occupants that are not wearing their seatbelts, the system alerts the driver with a warning sound and the seatbelt reminder symbol appears in the overhead console as well as the driver display.



Seatbelt reminder symbol

You can find information about which seatbelts aren't fastened in the driver display.



Car overview in the driver display

If the reminder appears, buckle the indicated seatbelts as soon as possible in a safe manner. Stop the car, if necessary, to avoid distracted driving.

In some cases, the sensors may mistake an object on the seat for a passenger and alert you if the seatbelt hasn't been fastened. If you dismiss these reminders in the driver display, the large graphic will disappear but the other warning indicators will remain active. Buckle the seatbelt to remove them.



**Warning**

Always make sure everyone in the car wears their seatbelt.

## 5.4. Airbags

There are several airbags that your car can deploy in a collision. They can help reduce the impact forces experienced by occupants.



The image shows a selection of available airbags. Continue reading for details on the airbags in your car.

The airbags are designed to work with the rest of the car's safety features. Their effectiveness particularly relies on proper seating and seatbelt use. An airbag deployment is a sudden, forceful but controlled event that can significantly lower the risk of serious injury for correctly seated occupants.



### Warning

The airbags cannot work as intended if an occupant is incorrectly seated in the event of a collision. Always use seatbelts.

Sensors throughout your car allow it to deploy different airbags based on information about the collision itself, as well as the status of the car and its occupants.

## Airbag types

Your car has the following airbag types:

- Front airbags** Frontal collision airbags for the front occupants.
- Side airbags** Seat-integrated side-on collision airbags for the front occupants.
- Inflatable curtains** Ceiling-mounted airbags for occupants seated by a window.

### 5.4.1. Airbag deployment

If an airbag has deployed, your car needs to be recovered and serviced.

When the car deploys an airbag, it inflates almost instantly with considerable force accompanied by a loud noise. After that point, it behaves differently depending on the type of airbag. The front and side airbags deflate as they are compressed and provide controlled cushioning for a single severe impact. The inflatable curtains stay inflated longer to protect against repeated impacts.



### Warning

#### Airbag-related injuries

No safety feature can prevent all possible injuries in a collision. The airbags are designed to reduce the risk of severe injuries. Impacting an airbag often results in some form of injury, and several factors affect the type and severity of the injury. Reading the manual allows you to recognise and avoid practices known to increase the risk of injury.

To reduce the risk of airbag-related injuries in a collision:

- Follow the manual's instructions for proper seating and use of seatbelts.
- Learn the placement of all airbags and how they affect the use of your car.
- Properly stow loose objects when driving and do not place or mount any objects around the airbag deployment areas.
- Do not make any modifications to the interior or electrical systems of your car that are not approved by Volvo.

**Note**

### Deployment conditions

Not all airbags may deploy in a collision. This is because different airbags require different conditions and forces to deploy. The severity of damage to the car after a collision is not a reliable indicator of whether any airbags should have deployed.

### Airbag gases and smoke

- The gas inside an airbag contains smoke that releases into the interior compartment when the airbag deflates.
- Always be attentive to signs of fire after a severe collision, but keep in mind that some smoke is normal if an airbag has deployed.

## After airbag deployment

After a collision in which the airbags have deployed, prioritise the safety and medical needs of those involved in the accident. Before handling the car, contact an authorised Volvo workshop. Follow the manual's instructions for safe handling and recovery of a car that's immobilised or in safety mode.

**Important**

Do not try to drive or move the car if any of the airbags have deployed. If the car poses an acute traffic hazard and is able to move, an exception can be made to move it a short distance out of immediate danger.

## 5.4.2. Front airbags

The front airbags are designed to deploy in certain frontal collisions. The front passenger airbag can be disabled to accommodate certain rearward-facing child restraints.

The front airbags can help protect the driver and front passenger from severe injury if they are properly seated during a collision. The airbags on each side deploy independently of one another.



The driver side has two front airbags. The upper airbag is packed inside the steering wheel and the knee airbag is packed behind a panel below the steering wheel.

**The content of this manual represents the status of the user manual at the time of printing and may not be completely valid in future instances. For more information, refer to the first page for the complete disclaimer note.**

The passenger side has a single front airbag. The airbag is packed behind a panel above the glove box.

All front airbag locations are marked with the text AIRBAG or SRS AIRBAG.

 **Warning**

### Do not block the front airbags

- Do not place luggage, children or pets in the space between the seated occupant and the front airbags, including in the occupant's lap.
- Legs or feet must never be placed on the dashboard. This could endanger life or lead to serious injury.
- Do not place or mount any items on the dashboard. Even small objects can become dangerous projectiles in a collision and end up between inflating airbags and occupants.

### Blocking airbags in general

Keep all airbag locations and expansion spaces free of obstructions. Obstructions can reduce airbag effectiveness and cause serious injury.

- Follow the instructions for a correct sitting posture.
- Properly stow luggage and other objects. The car has several luggage compartments for safe stowing.
- Do not modify or mount accessories to any panel covering an airbag or adjacent panels.

## Passenger airbag switch

You can enable or disable the front passenger airbag using the airbag switch. In addition to the passenger airbag, the switch also controls the status of the passenger seat's side airbags and parts of the seatbelt pretensioner. The passenger airbag needs to be disabled before you install a rearward-facing child restraint on the front passenger seat. Read all information about airbags and child safety before installing a child restraint.

## Passenger airbag status

The passenger airbag status is shown in the overhead console.



This icon indicates that the passenger airbag is enabled and can be deployed by the car.



This icon indicates that the passenger airbag is disabled and cannot be deployed by the car.

 **Warning**

### Child restraints and front passenger seat

NEVER use a rearward facing child restraint on a seat protected by an ACTIVE AIRBAG in front of it, DEATH or SERIOUS INJURY to the CHILD can occur.

 **Tip**

### Read everything about airbags

There is more information about airbags and safety in general. Make sure you have read everything about these topics so that you understand the capabilities and limitations of your car's safety features.

## 5.4.2.1. Disabling and enabling front passenger airbag

To use a rearward-facing child restraint in the front passenger seat, you must first disable the seat's airbags using the passenger airbag switch. When disabled, the airbags will not deploy in a collision.

### Switch location and positions



Location of the passenger airbag switch

The airbag switch is located on the side of the dashboard and is accessible when the front passenger door is open.

It has two positions. They are marked with both symbols and text indicating whether the front passenger airbags are enabled or disabled.



Airbags enabled. Always use this position when a forward-facing passenger, either child or adult, is in the seat.

In the position marked ON, the airbags are enabled and can be deployed by the car.



Airbags disabled. Always use this position when a rearward-facing child restraint is installed in the front passenger seat.

In the position marked OFF, the airbags are disabled and cannot be deployed by the car.

 **Important**

Read all information about front airbags, side airbags and child seating before changing the passenger airbag status.

**Changing the airbag switch position**

1. Pull the switch outwards and turn it to position ON or OFF.
- > The driver display confirms the status change.  
If set to ON, the message **Passenger airbag on** appears. The airbags are enabled.  
If set to OFF, the message **Passenger airbag off** appears. The airbags are disabled.

 **Note**

The overhead console always shows the current passenger airbag status. Make a habit of regularly checking it before driving, especially if a rearward-facing child restraint has recently been installed or removed.

## 5.4.3. Side airbags

The side airbags are designed to deploy in the event of a side-on collision.

The side airbags can help protect the driver and front passenger, if they are properly seated. The side airbags will typically only deploy on the collision side of each front seat.



Side collision airbags for the front occupants.

The side airbags are placed on the side of each front seat that is closest to the door. The airbags are packed into the seat's back frame.

Both front seats have markings with the text AIRBAG where the airbags are placed.

### Warning

#### Do not block the side airbags

- Do not place any objects on the side of the front seats. Objects between the seats and the door panel can interfere with the side airbags.
- Do not use seat covers that have not been approved by Volvo.

#### Blocking airbags in general

Keep all airbag locations and expansion spaces free of obstructions. Obstructions can reduce airbag effectiveness and cause serious injury.

- Follow the instructions for a correct sitting posture.
- Properly stow luggage and other objects. The car has several luggage compartments for safe stowing.
- Do not modify or mount accessories to any panel covering an airbag or adjacent panels.



Tip

### Read everything about airbags

There is more information about airbags and safety in general. Make sure you have read everything about these topics so that you understand the capabilities and limitations of your car's safety features.

## 5.4.4. Inflatable curtains

Your car's inflatable curtains help protect occupants seated by a window in certain collisions. They are placed above the doors on both sides of the car.

The inflatable curtains are designed to help protect the head of a properly seated and secured occupant. Unlike conventional airbags, the inflatable curtains stay inflated for an extended time after deployment.



Inflatable curtain deployed on one side of the car.

The inflatable curtains are packed behind panels along the ceiling's edges on both sides of the car. The panels are marked IC AIRBAG.

### **Warning**

#### Do not block the inflatable curtains

- Do not hang heavy items from the ceiling hooks or handles. The hooks are meant for light coats and jackets.
- Do not modify or mount accessories to the panels covering the inflatable curtains, the ceiling, pillars or adjacent panels.

#### Blocking airbags in general

Keep all airbag locations and expansion spaces free of obstructions. Obstructions can reduce airbag effectiveness and cause serious injury.

- Follow the instructions for a correct sitting posture.
- Properly stow luggage and other objects. The car has several luggage compartments for safe stowing.
- Do not modify or mount accessories to any panel covering an airbag or adjacent panels.

### **Tip**

#### Read everything about airbags

There is more information about airbags and safety in general. Make sure you have read everything about these topics so that you understand the capabilities and limitations of your car's safety features.

## 5.4.5. Airbag maintenance and servicing

Contact an authorised Volvo workshop if there is any indication of faults or damage to the airbags or other safety systems.

Any servicing or repairs of the airbags and related safety systems must be performed by authorised service technicians.<sup>[1]</sup> Never attempt to alter or repair any part of the car's safety systems yourself. Incorrectly performed repairs can lead to malfunctions and serious injury. Contact an authorised Volvo workshop when your car needs servicing or repairs.

### Note

A warning appears in the driver display if the car detects any airbag faults. Immediately contact an authorised Volvo workshop if this happens.



Red SRS warning symbol

<sup>[1]</sup> Volvo recommends an authorised Volvo workshop for any repairs or servicing.

---

## 5.4.6. Airbag labels

The airbag labels in your car provide essential information about the airbags or can act as airbag location markers.

### Airbag location labels

Places in your car marked either AIRBAG, IC AIRBAG or SRS AIRBAG indicate that there is an airbag in that location.

### Warning

#### Airbag label locations

The airbag label locations tell you where your car's airbags are located. Keep these locations and the space around them free of objects. Obstructions can interfere with airbag deployment, reduce their effectiveness and cause serious injury.

The airbags section contains more detailed information about use and conditions that can affect the airbags.

## Airbag information labels



This label is located on the front passenger seat's sun visor.

### Warning

#### Child restraints and front passenger seat

NEVER use a rearward facing child restraint on a seat protected by an ACTIVE AIRBAG in front of it, DEATH or SERIOUS INJURY to the CHILD can occur.

## 5.5. Child safety

Several features in the car aim to increase child safety, including anchorage points for child restraint installation and child locks.

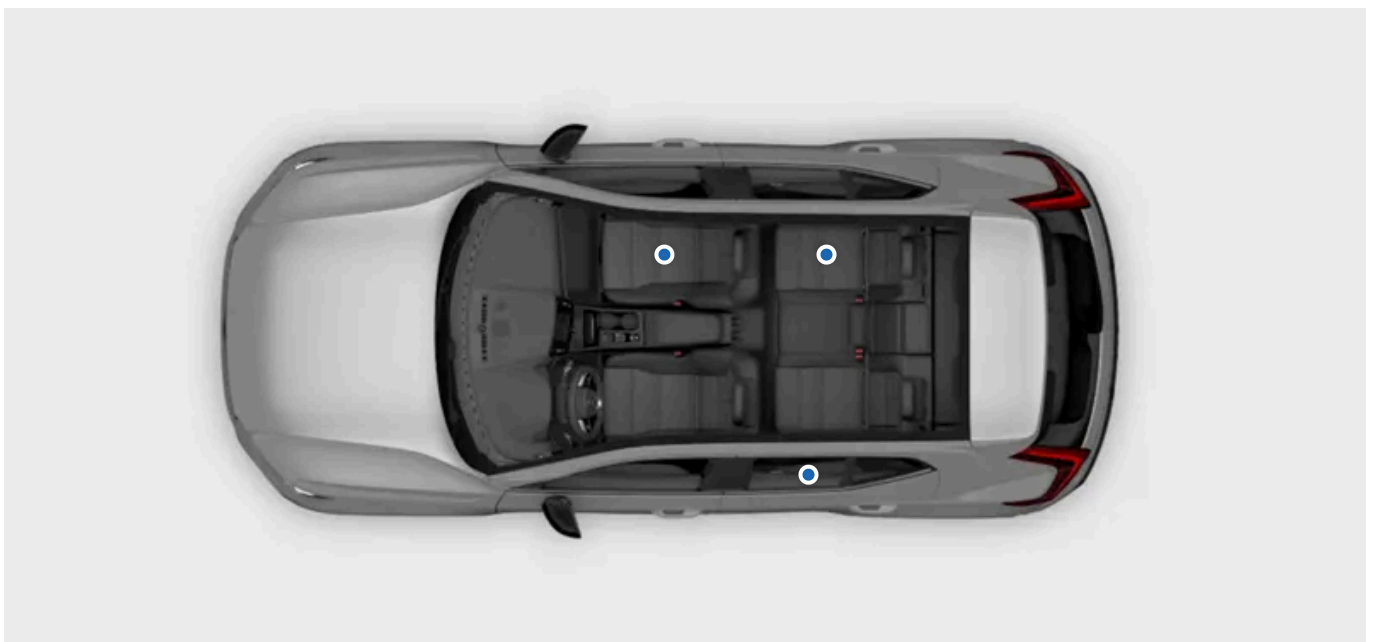

Children in the car should always be securely seated and kept under adult supervision. Follow the recommendations in this manual as well as the local regulations and recommendations that apply to you.



### Warning

#### Securely seated

- Children should be securely seated in a child restraint or with the car's seatbelt depending on their age and size. Never let a child sit in the lap of another passenger or in a location not intended for passengers.
- Other occupants in the car should be properly seated and use the seatbelts correctly. This can help prevent serious injury to children in the car in situations ranging from sudden braking to severe collisions.

#### Under supervision

- Never leave children alone in the car. Children may be exposed to potentially harmful temperatures on hot or cold days, or may lock themselves in.
- Do not allow children to play in the car or play with any of the car's controls. This reduces the risk of injury to the child or inadvertent activation or deactivation of the car's features.

## 5.5.1. Child restraints

Children should always use suitable child restraints and be securely seated in the car according to given recommendations.

Different types of child restraints are specifically designed for certain age and height ranges. Your car is equipped with child restraint anchorage points that suit different types of child restraints.

Volvo recommends that children use rearward-facing child restraints for as long as possible, until at least the age of four. After that, children should use forward-facing child restraints, preferably a booster seat using the car's seatbelt to secure the child. Children should use a child restraint until they reach at least 140 centimetres (4 feet 7 inches) in height.

Child restraints are classified into different approval levels:

<b>i-Size</b>	The i-Size child restraint standard uses ISOFIX in combination with the top tether anchorage points or a support leg. This standard ensures that any i-Size child restraint can be used on a seat designated as i-Size approved.
<b>Universal</b>	A child restraint of this approval level can be installed on a seat in any car model, as long as the car seat position is suitable for universally approved child restraints according to the car's manual.
<b>Vehicle specific</b>	A child restraint of this approval level can be installed on a seat in specific car models, as long as the child restraint manufacturer has included the car model in the type list for the specific restraint.

 **Warning**

### Child restraints and front passenger seat

NEVER use a rearward facing child restraint on a seat protected by an ACTIVE AIRBAG in front of it, DEATH or SERIOUS INJURY to the CHILD can occur.

### Damaged and old child restraints

Never use or reuse a child restraint:

- if the restraint has been involved in an accident or is damaged in any way
- if the expiry date or service life of the restraint has been exceeded
- if you don't know the full history of the restraint.

 **Important**

### Loose child restraints

Never leave a loose child restraint in the passenger compartment. When not in use, keep it installed according to the manufacturer's instructions or store it securely in the boot. A loose child restraint can cause damage in the event of a collision or sudden braking.

### General safety recommendations

When applicable, follow the general safety recommendations regarding seatbelt use, headrest adjustment and proper seating.

### Local regulations

Regulations on where and how children should be seated and secured differ between regions. Make sure that you know what applies to the region you are in.

## Airbag information labels



This label is located on the front passenger seat's sun visor.

## 5.5.1.1. Installing child restraints

When installing and using a child restraint, there is a number of things to keep in mind, depending on the location of the child restraint in your car.

### **Warning**

#### Follow the instructions

Take extra care to read all information about child safety in this manual and follow the instructions from the manufacturer of your child restraint. If you do not, the child could sustain serious injury in the event of an accident.

#### Child restraints and front passenger seat

NEVER use a rearward facing child restraint on a seat protected by an ACTIVE AIRBAG in front of it, DEATH or SERIOUS INJURY to the CHILD can occur.

### **Important**

#### Local regulations

Regulations on where and how children should be seated and secured differ between regions. Make sure that you know what applies to the region you are in.

#### Manufacturer's instructions

Always follow the instructions from the manufacturer of the child restraint.

---

### 5.5.1.1.1. Installing child restraints on the outer rear seats

To securely install a child restraint on either of the outer rear seats, there is important information to read and recommendations to follow.

ISOFIX, top and lower tether anchorage points can be used when installing a child restraint on the outer rear seats.

These seats are approved for i-Size child restraints.

### **Tip**

Long-term use of a child restraint may cause wear and tear on the car interior. Use a kick guard accessory to protect the car interior.

#### Allowed child restraints

- Only use child restraints that are recommended by Volvo, i-Size approved, universally approved or are vehicle specific approved where the car is included in the child restraint manufacturer's vehicle list.

## Seat preparations

- Remove cushion extenders, leg supports and other accessories from the seat before installing a child restraint. If you use a kick guard accessory, this can remain on the seat.
- Any support legs of a child restraint should always be fitted directly to the floor. Do not fit support legs to any raised or uneven floor surfaces, footrests or other objects.
- Loose objects should not be stored around any support legs of a child restraint.
- Any restraining straps of a child restraint should always be secured to designated anchorage points. Do not secure restraining straps to seat rails, handles or other parts of the interior.
- When installing an adjustable, rearward-facing child restraint, adjust the child restraint according to the child's age. Older children should be seated in a more upright position than younger ones.

## Seatbelt use

- When installing a child restraint secured using the car's seatbelt or when the car's seatbelt is used to secure a child, ensure that brackets or other parts of the restraint do not come into contact with the seatbelt buckle button.



### Warning

#### Follow the instructions

Take extra care to read all information about child safety in this manual and follow the instructions from the manufacturer of your child restraint. If you do not, the child could sustain serious injury in the event of an accident.



### Important

Follow the general recommendations for any child restraint anchorage points used to install a child restraint.

1. Follow the instructions from the manufacturer to install the child restraint.



### Note

#### Installation questions

If you have installation questions, contact the manufacturer of the child restraint for more detailed instructions.

#### Protecting the car interior

During installation, be careful to avoid damage to the car interior caused by protruding parts or sharp edges of the child restraint.

- Fasten loose parts of child restraints, such as restraining straps, according to the manufacturer's instructions.

 **Important**

### Raised headrest

The headrest must always be raised when a child restraint is installed.

### General safety recommendations

When applicable, follow the general safety recommendations regarding seatbelt use, headrest adjustment and proper seating.

### Local regulations

Regulations on where and how children should be seated and secured differ between regions. Make sure that you know what applies to the region you are in.

## 5.5.1.1.2. Installing child restraints on the centre rear seat

To securely install a child restraint on the centre rear seat, there is important information to read and recommendations to follow.

There are no anchorage points available when installing a child restraint on the centre seat.

 **Tip**

Long-term use of a child restraint may cause wear and tear on the car interior. Use a kick guard accessory to protect the car interior.

### Allowed child restraints

- Only use child restraints that are recommended by Volvo, universally approved or are vehicle specific approved where the car is included in the manufacturer's vehicle list.
- Child restraints that use support legs are not allowed on the centre rear seat.

### Seat preparations

- Remove cushion extenders, leg supports and other accessories from the seat before installing a child restraint. If you use a kick guard accessory, this can remain on the seat.
- When installing an adjustable, rearward-facing child restraint, adjust the child restraint according to the child's age. Older children should be seated in a more upright position than younger ones.
- When installing a forward-facing child restraint, make sure you adjust the headrest of the seat to the child's height. Even if the child restraint includes a head support, it might not have been built to withstand the forces involved in a collision.

### Seatbelt use

- When installing a child restraint secured using the car's seatbelt or when the car's seatbelt is used to secure a child, ensure that brackets or other parts of the restraint do not come into contact with the seatbelt buckle button.

 **Warning**

### Follow the instructions

Take extra care to read all information about child safety in this manual and follow the instructions from the manufacturer of your child restraint. If you do not, the child could sustain serious injury in the event of an accident.

 **Important**

Follow the general recommendations for any child restraint anchorage points used to install a child restraint.

1. Follow the instructions from the manufacturer to install the child restraint.

 **Note**

### Installation questions

If you have installation questions, contact the manufacturer of the child restraint for more detailed instructions.

### Protecting the car interior

During installation, be careful to avoid damage to the car interior caused by protruding parts or sharp edges of the child restraint.

- Fasten loose parts of child restraints, such as restraining straps, according to the manufacturer's instructions.

 **Important**

### General safety recommendations

When applicable, follow the general safety recommendations regarding seatbelt use, headrest adjustment and proper seating. Make sure you read these sections of the manual before installing a child restraint.

### Local regulations

Regulations on where and how children should be seated and secured differ between regions. Make sure that you know what applies to the region you are in.

---

## 5.5.1.1.3. Installing child restraints on the front passenger seat

To securely install a child restraint on the front passenger seat, there is important information to read and recommendations to follow.

Lower tether anchorage points<sup>[1]</sup> can be used when installing a child restraint on the front passenger seat.

 **Tip**

Long-term use of a child restraint may cause wear and tear on the car interior. Use a kick guard accessory to protect the car interior.

#### Allowed child restraints

- Only use child restraints that are recommended by Volvo, universally approved or are vehicle specific approved where the car is included in the manufacturer's vehicle list.

#### Seat preparations

- Retract the seat cushion extension and remove cushion extenders, leg supports and other accessories from the seat before installing a child restraint. If you use a kick guard accessory, this can remain on the seat.
- Any support legs of a child restraint should always be fitted directly to the floor. Do not fit support legs to any raised or uneven floor surfaces, footrests or other objects. Adjust the seat position if needed.
- Loose objects should not be stored around any support legs of a child restraint.
- Any restraining straps of a child restraint should always be secured to designated anchorage points. Do not secure restraining straps to seat rails, handles or other parts of the interior.
- When installing a child restraint using the lower tether anchorage points, never adjust the seat position to tighten the straps.
- When installing rearward-facing child restraints, adjust the seat to its lowest position.
- When installing adjustable, rearward-facing child restraints, adjust the child restraint according to the child's age. Older children should be seated in a more upright position than younger ones.

#### Seatbelt use

- When installing a child restraint secured using the car's seatbelt or when the car's seatbelt is used to secure a child, ensure that brackets or other parts of the restraint do not come into contact with the seatbelt buckle button.
- When securing a child with the car's seatbelt, always start with the seatbelt's upper anchorage point adjusted to its highest level. Then lower it as needed to properly position the belt against the shoulder.

 **Warning**

### Passenger airbag status

- When installing rearward-facing child restraints, always check that the passenger airbag is disabled.
- When installing forward-facing child restraints, always check that the passenger airbag is enabled.

Failure to follow these instructions can endanger life or lead to serious injury.

### Follow the instructions

Take extra care to read all information about child safety in this manual and follow the instructions from the manufacturer of your child restraint. If you do not, the child could sustain serious injury in the event of an accident.

 **Important**

Follow the general recommendations for any child restraint anchorage points used to install a child restraint.

1. Follow the instructions from the manufacturer to install the child restraint.

 **Note**

### Installation questions

If you have installation questions, contact the manufacturer of the child restraint for more detailed instructions.

### Protecting the car interior

During installation, be careful to avoid damage to the car interior caused by protruding parts or sharp edges of the child restraint.

- If the child restraint uses lower tether straps, never adjust the position of the seat after the straps have been secured to the lower tether anchorage points. Always remember to remove the straps when the child restraint is not installed.
- Fasten loose parts of child restraints, such as restraining straps, according to the manufacturer's instructions.

 **Important**

### General safety recommendations

When applicable, follow the general safety recommendations regarding seatbelt use, headrest adjustment and proper seating.

### Local regulations

Regulations on where and how children should be seated and secured differ between regions. Make sure that you know what applies to the region you are in.

<sup>[1]</sup> Accessory on some markets

## 5.5.1.2. Child restraint anchorage points

Your car has different types of anchorage points. Be sure to use the correct anchorage points for your specific child restraint.



- ① Lower tether anchorage points on the floor rails of the front seats and on the sides of the front passenger seat footwell<sup>[1]</sup>
- ② ISOFIX anchorage points between the backrests and seat cushions of the rear seats
- ③ Top tether anchorage points on the backs of the second row seats

Your car's various anchorage points can be used in combination with each other or along with other fastening methods to secure different types of child restraints.

The i-Size child restraint standard uses ISOFIX in combination with the top tether anchorage points or a support leg. This standard ensures that any i-Size child restraint can be used on a seat designated as i-Size approved.

Some child restraints are secured using a car seatbelt, usually in combination with other fastening methods.

**Note**

**Manufacturer's instructions**

When using anchorage points, always follow the instructions from the manufacturer of the child restraint.

[1] Option/Accessory

### 5.5.1.2.1. ISOFIX anchorage points

Your car is equipped with ISOFIX anchorage points that can be used to secure child restraints on a rear seat.

The ISOFIX anchorage points can be used in combination with other fastening methods to secure i-Size and ISOFIX child restraints. These anchorage points are part of an international standard for child restraints.

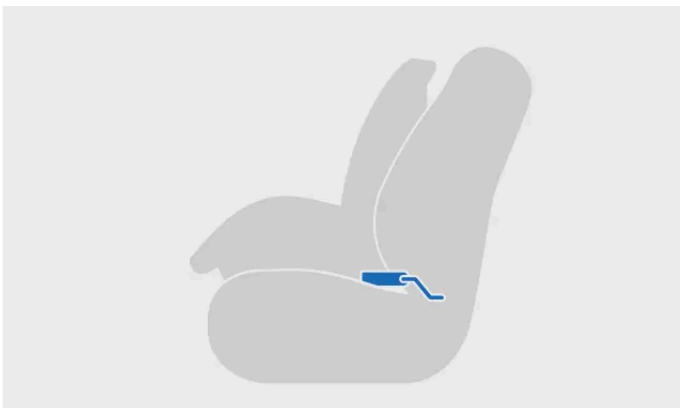

Child restraint installed using ISOFIX



Attaching to ISOFIX anchorage point

Child restraints installed on either of the outer rear seats can use these anchorage points.

**Note**

ISOFIX is an international standard for child restraint anchorage points. It is also known by other regional names such as LATCH and LUAS.



Locations of ISOFIX anchorage points for the outer rear seats

The ISOFIX anchorage points for the rear seats are located behind covers in the lower part of the backrest on the outer rear seats. The covers need to be lifted to access the anchorage points behind them.

The anchorage locations are indicated by the ISOFIX symbol.

The anchorage point locations marked with the i-Size symbol are approved for i-Size child restraints.



**Note**

**Manufacturer's instructions**

When using anchorage points, always follow the instructions from the manufacturer of the child restraint.

## 5.5.1.2.2. Top tether anchorage points

Your car is equipped with top tether anchorage points that can be used to secure child restraints on a rear seat.

The top tether anchorage points can be used in combination with other fastening methods to secure different types of child

restraints.

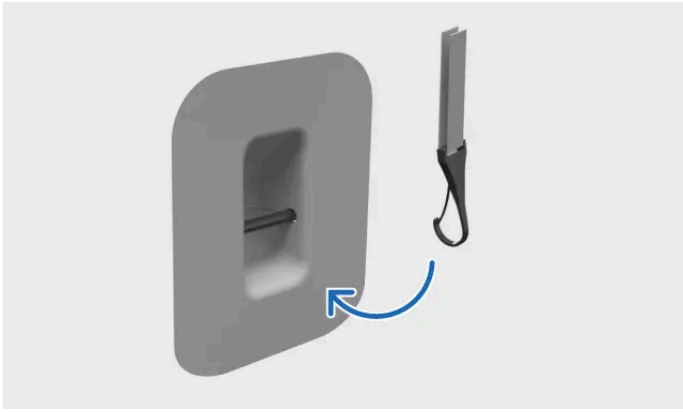

Fastening tether to top tether anchorage point

Child restraints installed on the outer rear seats can use these anchorage points.

## Anchorage point locations for the rear seats

The top tether anchorage points are located on the back of the backrests.



The top tether anchorage point locations for the rear seats are indicated by the top tether symbol.



### **Warning**

#### Headrest and top tether straps

The top tether straps should be routed through the hole in the car seat headrest before they are secured to the anchorage point. If this is not possible, follow the recommendations from the manufacturer of the child restraint.

**Note**

### Parcel shelf

To use the rear seat top tether anchorage points, you first have to remove the parcel shelf. You can learn more on how to do this in a separate section of the manual.

### Manufacturer's instructions

When using anchorage points, always follow the instructions from the manufacturer of the child restraint.

## 5.5.1.2.3. Lower tether anchorage points

Your car is equipped with lower tether anchorage points that can be used to secure child restraints on a rear seat.

If your car is equipped with the front lower tether accessory, those anchorage points can be used to secure child restraints on the front passenger seat as well.

The lower tether anchorage points can mainly be used in combination with the car's seatbelt to secure certain rearward-facing child restraints.

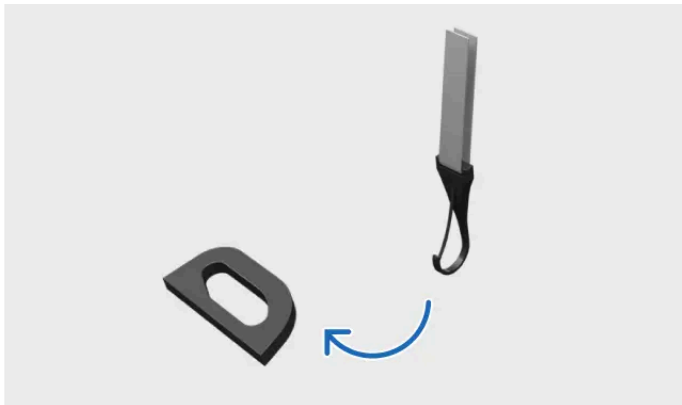

Fastening tether to lower tether anchorage point

Child restraints installed on any outer rear seat can use these anchorage points.

Additionally, child restraints installed on the front passenger seat can use these anchorage points if your car is equipped with the front lower tether accessory.

## Anchorage points for the rear seats



The lower tether anchorage points can be found at the back of the floor rails of the front seats.

## Anchorage points for the front seat

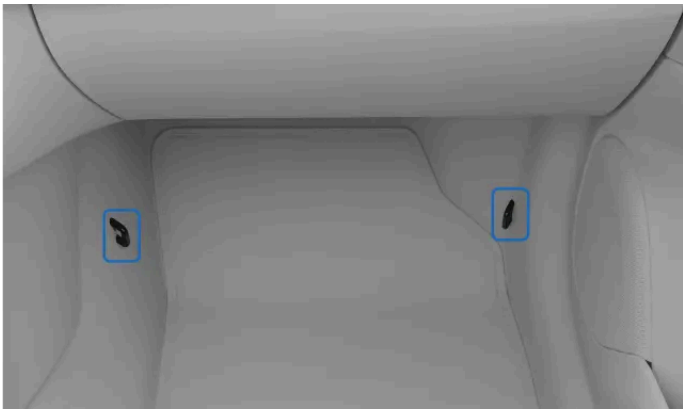

The lower tether anchorage points for the front passenger seat are located on the sides of the seat's footwell.

### Note

#### Manufacturer's instructions

When using anchorage points, always follow the instructions from the manufacturer of the child restraint.

## 5.5.1.3. Recommended child restraints

Only use child restraints that are recommended by Volvo, i-Size approved, universally approved or are vehicle specific approved where the car is included in the manufacturer's vehicle list.

Child restraint <sup>[1]</sup>	Installation type	Child size (ECE R129)
Volvo Easy access <sup>[2]</sup>	Rearward-facing	40–105 cm (max 18 kg)
Volvo rear-facing child seat <sup>[3]</sup>	Rearward-facing	61-115 cm (max 25 kg)
Volvo booster seat <sup>[4]</sup>	Forward-facing	105–150 cm (max 36 kg)

The content of this manual represents the status of the user manual at the time of printing and may not be completely valid in future instances. For more information, refer to the first page for the complete disclaimer note.

Child restraint <sup>[1]</sup>	Installation type	Child size (ECE R129)
Volvo booster cushion <sup>[4]</sup>	Forward-facing	138–150 cm (max 36 kg)

<sup>[1]</sup> Availability of listed child restraints may vary by region.

<sup>[2]</sup> Approval number: E1-010016

<sup>[3]</sup> Approval number: E11 129R03/08 0599 00

<sup>[4]</sup> Approval number: 0061 01

## 5.5.1.4. Overview table of suitable locations for child restraints

The following table provides an overview of the types of child restraints suitable for installation on each seat.

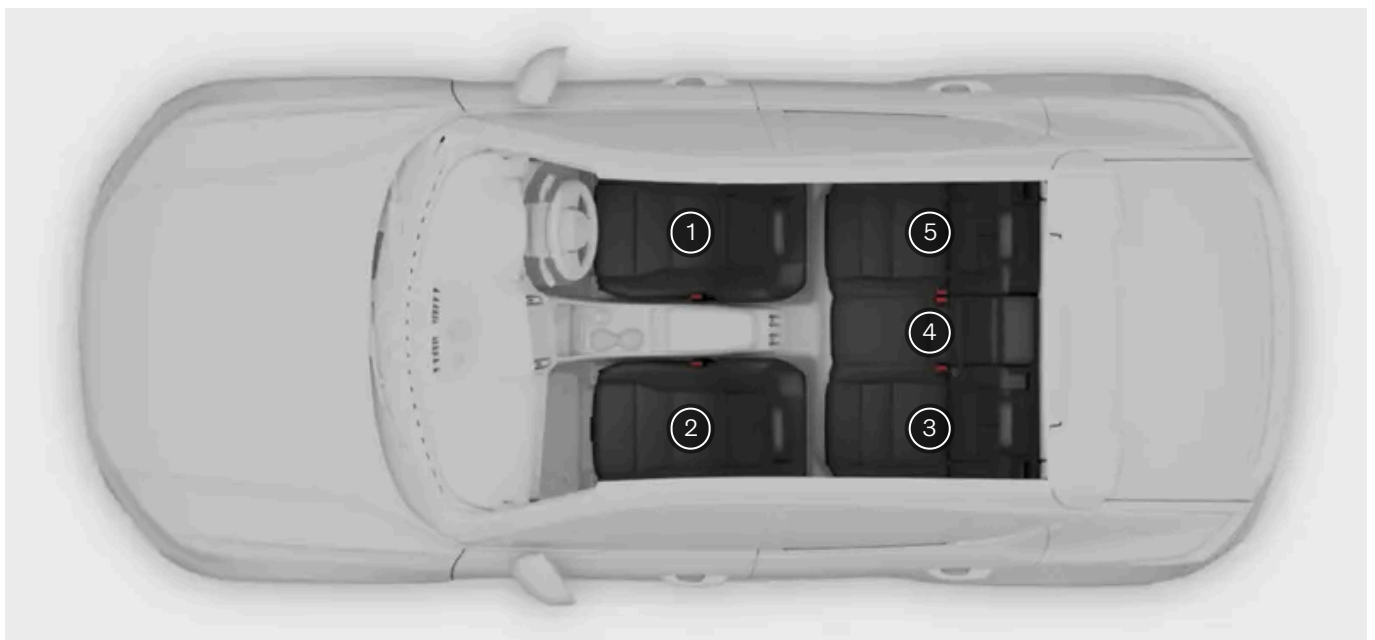

	i-Size child seats	Universally approved child seats secured using the car's seatbelt	Other child seat categories <sup>[1]</sup>
Seat position <sup>[2]</sup>	3, 5	2 <sup>[3]</sup> , 3, 4, 5	2 <sup>[3]</sup> , 3, 5

<sup>[1]</sup> For more information, contact the child seat manufacturer.

<sup>[2]</sup> According to the numbering above.

<sup>[3]</sup> Activated airbag for front-facing child seats. Deactivated airbag for rear-facing child seats.

## 6. Entry and security

Learn about the various features associated with entering and exiting the car, including how the keys and alarm work.



This section of the manual covers opening and closing the doors, locking and unlocking, and the alarm.

Learn more about how the different types of keys work and how you can customise the way your car reacts when you lock and unlock it.

---

### 6.1. Keys

Your car supports three types of keys. The keys are recognised automatically when you bring them with you inside the car.



Standard key, key tag and Care Key

Your car supports the following types of keys:

- Standard key
- Care Key
- Key tag

The car detects when there's a key in the passenger compartment and gives you driving access.

 **Important**

Using keys is fairly straightforward, but you should be aware of the limitations of each key type for safety and security reasons. Therefore, it is important to read the whole section about keys and how to use them.

Wireless key and car technologies may cause disturbances in other devices. You can find more information about these systems in the specifications section of this manual.

For safety and security reasons, never leave unattended keys in an exposed place.

## Standard key and Care Key

The standard key has four buttons:

- Locking button
- Unlocking button
- Boot hatch button
- Panic button

If you prefer, you can use keyless locking. This means you lock or unlock the car using the door handles instead of using the key buttons.

The standard key also has a detachable key blade inside it. This lets you open the driver door even if the key's buttons aren't working or if its battery has gone flat.

The Care Key works just like a standard key, but it lets you set a speed limitation for the car while the key is being used.

## Key tag

The key tag is buttonless and lets you automatically lock and unlock the car by touching the door handles when you are within the key detection range.

## Key detection range

Your car can detect your key from a short distance away, which allows you to use the keyless lock and unlocking function. This means that you can lock and unlock the car by touching the door handle, without having to use the standard key's buttons or key blade.

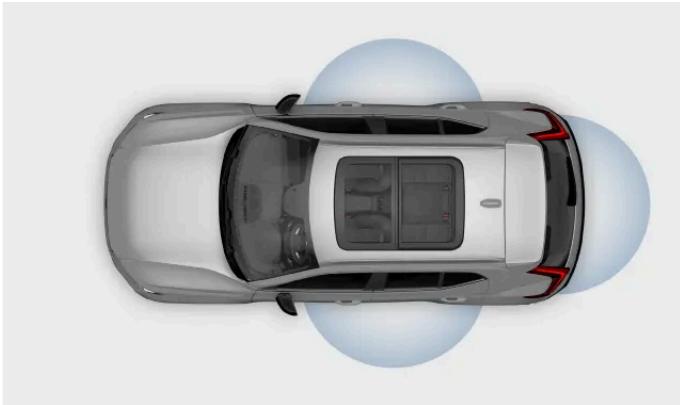

The standard key's buttons have a long range of detection. If your car doesn't respond to a button being pressed, try moving closer.

**Note**

The key functions can be disrupted by external factors such as surrounding radio waves, buildings and topographical conditions. If this happens, you can still lock and unlock the car using the standard key's detachable key blade.

**Important**

Avoid storing the car's keys close to metal objects or electronics such as mobile phones, tablets, laptops or chargers.

## User profiles and keys

You can assign keys to specific user profiles. This allows the car to automatically identify who's unlocking it and apply their customisations. Read about profiles for more information.

## Locking keys in

If you lock the car while a key is still inside, that key is temporarily deactivated. If anyone is inside the car when this happens, they will still be able to open the doors. The locked-in key will be activated again when you unlock the car with another valid key.

**Note**

### Additional keys

Your car comes with a limited number of keys. Contact a Volvo dealer or an authorised Volvo workshop if you lose a key or simply require additional keys.

 **Warning**

The keys include a battery. Keep new and used batteries out of reach of children and pets. If batteries are ingested, they can cause serious health issues. If a battery or the key itself is damaged, the item should not be used. Keep defective items out of reach of children and pets.

If you leave a person in the car, ensure that you do not leave a key in the car. This is especially important around children.

Improper use of car opening and starting systems can result in serious personal injury. Always take your keys with you when you leave the car. The car can be started and systems, such as the power windows, can be operated, leading to serious personal injury. Never leave children, disabled persons or anyone who cannot help themselves in the car. The doors can be locked which could result in people being trapped in the car in an emergency. For example, depending on the time of year, people trapped in the car can be exposed to very high or low temperatures. Never remove the key while the car is moving or while it is rolling to a stop.

## 6.1.1. Standard key

The standard key lets you lock and unlock the car either from a distance or using the detachable key blade.



The standard key has four buttons:



Locking button



Unlocking button



Boot hatch button



Panic function

It also has a detachable key blade. This lets you open the driver door even if the standard key's buttons aren't working or if its battery has gone flat.

### Locking button

The locking button can be used in the following ways:

**The content of this manual represents the status of the user manual at the time of printing and may not be completely valid in future instances. For more information, refer to the first page for the complete disclaimer note.**

- Press once to lock the car and arm the alarm.
- Press and hold to close all of the windows as well as the panoramic roof.

## Unlocking button

The unlocking button can be used in the following ways:

- Press once to unlock the car and disarm the alarm.
- Press and hold to open all of the windows.

## Boot hatch button

Press the button once to disarm the alarm and unlock the boot hatch. Press and hold it to open or close the boot hatch.

## Panic function

Use the panic function button to attract attention in case of an emergency. When you press and hold the button, or press it twice in quick succession, the car will activate the indicators and the horn.

You can turn the panic function off manually by pressing the unlock button, or the car will turn them off automatically after a few minutes.

## Detachable key blade

Your standard key has a detachable key blade that can be used as a backup if the buttons aren't working. For example, the key's signals can be disrupted by electromagnetic fields. If this happens, or if your key runs out of battery, you can still unlock and lock the car by using the detachable key blade.

---

### 6.1.1.1. Detachable key blade

You can use the detachable key blade as a backup if your key runs out of battery.

There's a detachable key blade inside the standard key.

If your standard key or key tag isn't working, you can use this key blade to:

- open the left-hand front door
- lock a door.

If you use the detachable key blade to unlock the car, you can deactivate the alarm and start the car by placing your key on the backup key reader.

The backup reader is located in the tunnel console's storage compartment.

---

### 6.1.2. Care Key

The content of this manual represents the status of the user manual at the time of printing and may not be completely valid in future instances. For more information, refer to the first page for the complete disclaimer note.

A Care Key can be used in the same way as a standard key, with the only difference being that you can have a specific speed limitation tied to it.

The Care Key works just like a standard key when it comes to locking and unlocking, starting your car and most of the other standard actions. The big difference is that you can set a speed limitation for the car when the Care Key is being used. This can be useful when you need to lend your car to an inexperienced driver or give it to a valet or workshop.

When a Care Key with a connected speed limitation is being used, it's indicated with a symbol in the driver display.



Care Key speed limitation symbol

It's also possible to use the Care Key without connecting it to a speed limitation. In that case, it works just like a standard key.

## Changing the speed limitation setting

The car automatically detects when you unlock it using a Care Key and applies the speed limitation if you have set one.

When you've unlocked the car using a Care Key, you can't change or remove the speed limitation. To access the speed limitation setting again, relock the car and unlock it using a standard key or key tag and select the owner profile.

---

### 6.1.2.1. Setting a speed limitation for the Care Key

You can set a maximum permitted speed for a Care Key or turn the speed limitation off to use it like a standard key.

Make sure you unlock the car using a standard key or key tag to be able to access the speed limitation settings.

1. Press the car symbol  in the bottom bar and go to **Settings**.
  2. Go to **Profiles** → **Care key**.
  3. Turn the speed limitation on and select the desired maximum speed.
- > A speed limitation symbol appears in the driver display. A dotted line on the speedometer shows the current speed limitation.

---

### 6.1.3. Key tag

You can use your key tag to lock, unlock and drive the car without using any buttons on the key.

The key tag lets you use the keyless locking and unlocking feature. It's smaller and lighter than the standard key which makes it particularly useful when you have limited space for carrying items.

If you leave the key tag in the car and lock the car with your standard key, the tag will be disabled until the car is unlocked again.

## Key tag battery

The battery in the key tag isn't rechargeable and can't be replaced.

### Note

A discharged key tag could still be used to start the car via back-up start. For this reason, hand in any discharged key tag to an authorised Volvo workshop so that it can be deleted from the car's system.

### Warning

The key tag includes a non-replaceable battery which can be extremely hazardous. Keep batteries out of reach of children. If you suspect a battery has been ingested or in any way inserted into the body, seek immediate medical attention. Battery fluid is also hazardous and physical contact with it should be avoided.

## 6.1.4. Replacing the standard key's battery

You can replace the battery in your standard key when it goes flat.

Your car will let you know when the battery in your standard key is running low via a message in the driver display. Another sign that the battery level is low is if you notice a decreased range when locking or unlocking the car.

You can replace the battery yourself. The key requires a flat 3 V CR2032 disc battery.

### Important

- For safety reasons and to ensure optimal battery performance, use hand protection such as a medical glove when handling a new battery.
- Used batteries must be recycled in an environmentally sound manner.

Hold the key with the Volvo logo facing upwards.

### Detaching the front shell

1. Slide the small catch on the keyring bracket to the side, then slide the front shell away from the bracket.



> The front shell detaches.

2. Lift the front shell off and locate the other small catch underneath it.

#### Detaching the rear shell

3. Use the small catch to slide the rear shell away from the bracket.



> The rear shell detaches.

4. Lift the rear shell off to find the battery cover.

#### Removing the battery cover

- 5.



Using a suitable tool, such as a screwdriver or a coin, turn the battery cover anticlockwise to release it.

#### Replacing the battery

6. Loosen the battery by pressing on its edge and lift it out.

7. Place the new battery in the slot, making sure the positive side of the battery is facing upwards. Position the edge of the battery under the two outer plastic catches, then press down on the battery so that it is held in place by the upper plastic catch.
8. Refit the battery cover, rear shell and front shell on the key.

 **Warning**

Check that the battery is fitted correctly with the correct polarity. If the key will not be used for a long time, remove the battery to avoid battery leakage and damage. Batteries with damage or leaks may cause corrosive injury on contact with the skin. Therefore, use protective gloves when handling old or damaged batteries.

- Keep batteries out of the reach of children.
- Do not leave batteries lying around as they can be swallowed by children or pets.
- Batteries must not: be dismantled, short-circuited or thrown into open flames.
- Do not try to charge non-rechargeable batteries. They may explode.
- Check battery-operated products for signs of damage on a regular basis. The key should not be used if anything indicates that it or its battery has been damaged or has started to leak.
- Keep defective products out of the reach of children.

---

## 6.2. Opening and closing

Your car has a few features and situation-specific behaviours you should be aware of when opening and closing the doors.

### Opening the doors

You open the doors manually, but you can set how the doors open and under which conditions via the centre display.

### Opening the bonnet

The bonnet is opened by using a lever near the driver's seat.

### Opening the boot

You open the boot manually using the button on the boot hatch or by using the button on your standard key.

Your car also has a hands-free feature that lets you access the boot using foot movement.

### Open door warning

Regularly check that the bonnet, boot hatch and doors are fully closed.

Open doors and hatches are highlighted in the driver display. If you see an open door warning, stop the car in a safe place as soon as possible and make sure the relevant door or hatch is properly closed.

---

## 6.2.1. Opening the bonnet

To open the bonnet, you need to pull two separate release levers. Be sure to close the bonnet again before driving the car.

### Locations of release levers

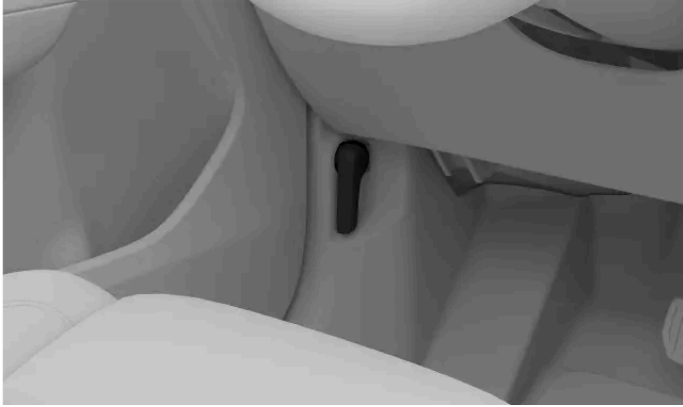

The first lever is below the dashboard on the driver's side, just in front of the door hinge.



The second lever is below the front edge of the bonnet on the driver's side.

### Releasing the bonnet

1. Find the first lever below the dashboard on the driver's side and pull it back.

- > The bonnet releases from its fully locked position. It opens slightly, which gives you access to the second lever.

2.

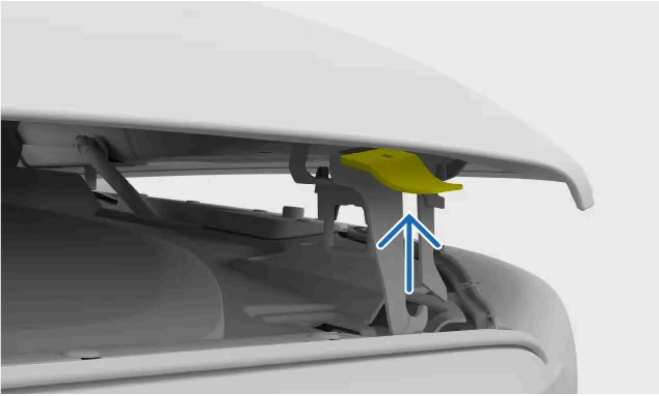

Locate the second lever on the underside of the bonnet and push it upwards.

- > The bonnet releases fully.
3. Lift the bonnet and open it to its fully extended height.
- > The bonnet stays in position.

 **Warning**

Do not drive with the bonnet open

Stop the car immediately if there is any indication that the bonnet is not completely closed.

 **Note**

Open bonnet warning

If you see an open bonnet warning in the driver display, open the bonnet and check for obstructions before closing it again. Contact Volvo support if the notification doesn't go away.

## 6.2.2. Closing the bonnet

Take extra care to ensure that you close the bonnet completely after opening it.

Make sure nothing gets in the way of the bonnet as it closes.

 **Warning**

Pinching and crushing hazard

Keep all hands away from the bonnet's closing path. Take extra caution when children or pets are nearby.

1. From the fully-opened position, carefully lower the bonnet until it reaches the locking mechanism.
2. Press down with both hands on the sides of the bonnet lid's front edge.



Where to press the bonnet down to close it

***i* Note**

Make sure the bonnet fits into the locks at the same time. Keep the front edge flat as it closes.

You should hear the bonnet lock on both sides.

3. Make sure there are no significant gaps or any indication that the bonnet is not completely closed.

** Warning**

Do not drive with the bonnet open

Stop the car immediately if there is any indication that the bonnet is not completely closed.

***i* Note**

Open bonnet warning

If you see an open bonnet warning in the driver display, open the bonnet and check for obstructions before closing it again. Contact Volvo support if the notification doesn't go away.

## 6.2.3. Boot access

You can open or close the boot in several different ways, from both inside and outside of the car.

 **Warning**

Be aware when the boot is opening or closing. Make sure that no persons are in the vicinity of the boot when it is in motion. Always use the boot access functions with caution.

Do not interfere with the boot's support arms, these are highly pressurised and tampering with them can result in serious injury.

After use, ensure that the boot is fully closed.

Never leave children alone in the car. Children may be exposed to potentially harmful temperatures on hot or cold days, or may lock themselves in.

Do not allow children to play in the car or play with any of the car's controls. This reduces the risk of injury to the child or inadvertent activation or deactivation of the car's features.

Never drive with the boot hatch open.

## Manual access

If you're carrying a key with you, you can unlock the boot by gently pressing the rubberised button underneath the handle at the bottom of the boot hatch. Once unlocked, you can open the boot using the same handle.

 **Important**

Handle the rubberised button with care to avoid damaging its electrical contact.

When opening boot, use the handle to lift the boot hatch rather than the rubberised button.

## Using the standard key button

The standard key has a boot hatch button which lets you lock, unlock, open and close the boot from a distance.

## Hands-free opening

The hands-free feature lets you open the boot using foot movement. You can learn more about this feature in a separate section of this manual.

## Buttons on the boot's interior

Press the boot closing button on the inner right side of the boot hatch to close it.



You can also use the closing button to adjust how far the boot opens. This is useful if you want the boot hatch to stay within easy reach or if you are somewhere with a low ceiling, such as a garage.

To close the boot and lock the car, press the boot locking button. If the boot can't lock for some reason, you will hear three beeps.



**Note**

To ensure that your car locks when you press the boot locking button, make sure your key is somewhere where the car can detect it and that all of the car's side doors are closed.

## Dashboard button

You can unlock and open the boot from inside the car using a button on the dashboard, next to the steering wheel.

Press the dashboard button once to unlock the boot or press and hold it for a few seconds to open the hatch. The same button can then be used to close the hatch.

## Pinch protection

The car can detect obstructions to the boot hatch when opening or closing. When pinch protection activates, you will hear a warning sound.

If the boot hatch tries to close with an obstruction in the way, the boot will open fully. If pinch protection activates while the boot hatch is opening, the hatch will stop moving.

**Note**

If you don't open the boot hatch within a couple of minutes of unlocking it, it locks and arms the alarm automatically.

## 6.2.3.1. Opening the boot hands-free

If your hands are full and you have your key with you, just pass your foot under the rear bumper once to open the boot.



The sensor picks up movement under the rear bumper. Any detected movements unlock the boot.

Make sure you have your key with you.

#### Opening the boot

1. Make a single kicking motion under the rear bumper and move back.
- > A short sound response indicates that the boot is about to open.

 **Note**

Repeated foot movements cancel or reset the activation.

## Closing the boot

When you want to use the hands-free feature for closing the boot, repeat the kicking motion once. A short sound response indicates that it's about to close.

If the function appears to be unresponsive, keep in mind that any obstructions to the sensor, such as mud, may interfere with it responding properly.

---

## 6.2.3.2. Adjusting boot opening height

You can adjust how much the boot hatch opens.

If you often park in places with a low ceiling, such as a garage, you may want to lower the boot opening height. You can also raise the boot opening height to have more room to access the boot.

Once adjusted, the boot hatch will continue to open to the newly set height until changed again.

1. Open the boot hatch to the desired height.

 **Note**

To set a new boot opening height, the hatch needs to be opened at least halfway.

2. Press and hold the hatch closing button on the bottom of the boot hatch for a few seconds to set the new height.



Hatch closing button

The content of this manual represents the status of the user manual at the time of printing and may not be completely valid in future instances. For more information, refer to the first page for the complete disclaimer note.

- > You will hear two confirmation sounds when the new height has been set.

If you want to reset the max opening height, open the hatch manually to the fully open position. Then, press and hold the closing hatch button until you hear the confirmation sounds.

---

## 6.3. Locking and unlocking

The car can be locked and unlocked in several different ways.

You can lock and unlock the car in the following ways:

- with the buttons on the standard key or Care Key
- using the detachable key blade on the standard key
- using the keyless function <sup>[1]</sup>
- from the inside of the car with the door handles and lock buttons
- with the Volvo Cars app.

### Note

#### Automatic locking while driving

The doors and boot hatch lock automatically when you start driving, but the doors can still be opened from the inside. You can select which doors can be unlocked in settings.

You can also turn the automatic lock while driving setting on or off.

If you want to prevent the rear doors from being opened from the inside, activate the child lock.

When you use keyless locking, all of the doors need to be closed before the car can lock.

If you lock the car using your standard key, only the driver's door needs to be closed. Once you close the rest of the doors and hatches, your car will indicate that it's locked.

## Lock indications

Your car has a number of ways it can indicate whether the doors are locked. These include:

- The hazard lights flashing twice when the car locks. You can turn more locking feedback responses on or off in settings.
- Any locked doors being indicated with a small light next to the lock buttons in the door panels. The light turns off if that door is opened.
- The front door indication lights illuminating if all of the doors are locked. The lights turn off if any of the doors are opened.

 **Warning**

Volvo recommends not leaving people or pets in a locked car. The driver is always fully responsible for the well-being and safety of anyone left inside. Some regions have laws prohibiting people or pets being left inside a locked vehicle.

[1] The car detects that a key is within range and lets you lock and unlock by touching the door handles or boot hatch handle.

## 6.3.1. Keyless locking and unlocking

The car's keyless locking and unlocking system allows you to lock and unlock the car by interacting with touch-sensitive areas on the door handles.

To use the keyless function, you just need to carry your key with you. As long as the key is within your car's detection range and it has a sufficient battery level, you can lock and unlock the car by interacting with the different touch-sensitive areas on the door handles.

 **Important**

Keyless locking and unlocking can be triggered when you wash your car if a key is in range.

### Keyless locking

When carrying your key, you can lock the car by touching the small indentation on the outer part of the door handle.

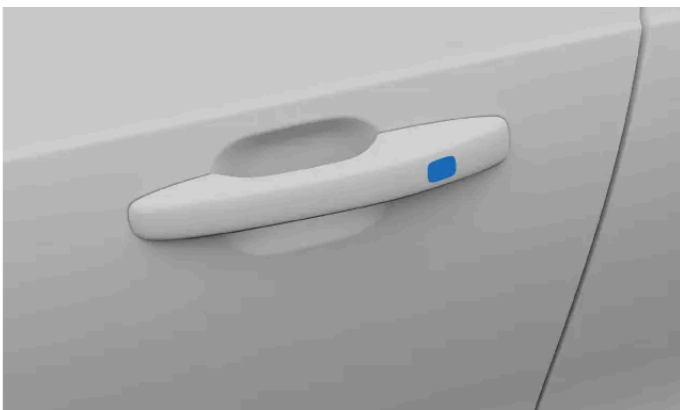

To lock the boot hatch without using a key, you can use the locking button on the lower edge of the hatch. If you press this button, the car will lock once the boot is closed.



Boot hatch locking button

It's also possible to lock the doors while the boot hatch is still open. Once you've locked the rest of the car using the door handle, the boot hatch will lock too once it's closed.

**i Tip**

### Closing the windows with keyless locking

You can close all of the side windows and the panoramic roof at the same time by holding a finger against the indentation on the outside of the door handle.

## Keyless unlocking

With keyless unlocking, your car unlocks automatically when you pull the door handle while carrying your key.

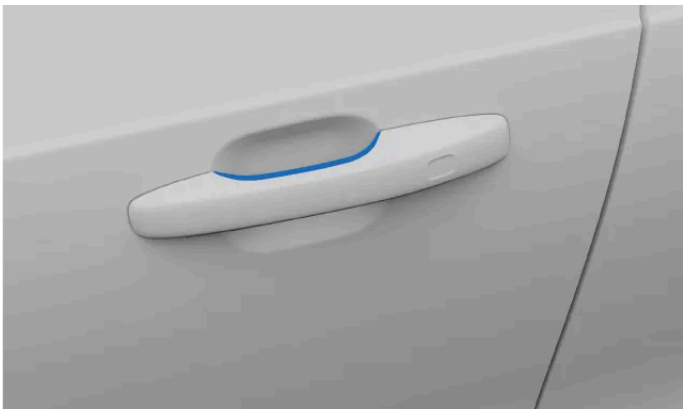

Door handle touchpoint

There is also a rubberised button under the boot hatch's handle which you can press to unlock the car.

**i Note**

Make sure to only touch one of the touch-sensitive areas on the door handle at a time, either the one for locking or the one for unlocking. If you grip the handle while touching the lock surface, the keyless function might not work properly.

## 6.3.2. Locking and unlocking using the key buttons

You can use the buttons on the standard key and Care Key to lock or unlock the car, including the fuel filler flap.

**i Tip**

Pressing the key's buttons once controls the locking and unlocking behaviours. Pressing and holding the different buttons controls different features related to opening and closing, such as opening the boot and automatic window closing. You can learn more about these features in the relevant section of the manual.

## Locking the car



Close the driver's door and press the locking button.

- > The car locks. Any open doors or hatches will be locked once you close them.  
The alarm is armed.

### Note

If you lock the car while a key is still inside, that key is temporarily deactivated. If anyone is inside the car when this happens, they will still be able to open the doors. The locked-in key will be activated again when you unlock the car with another valid key.

If you press the lock button with the boot hatch still open, make sure you don't leave the key inside the car when you close the hatch. If the car detects that the key is still inside, the boot will not lock.

## Unlocking the car



Press once on the unlocking button.

- > The car unlocks.
- > The alarm is disarmed.

### Note

#### Automatic relocking

If you don't open any of the doors or the boot hatch for a couple of minutes after unlocking, the car relocks automatically so that you don't accidentally leave it unlocked.

## Unlocking the boot hatch



Press once on the boot hatch button.

- > The boot unlocks.  
The alarm remains armed on the side doors.

## If the key isn't working

If the car doesn't respond to the key's buttons, try changing the key battery. As a backup, you can use the detachable key blade to lock or unlock the car.

### 6.3.3. Locking and unlocking using the detachable key blade

There's a detachable key blade inside the standard key that you can use as a backup for locking and unlocking.

**Note**

When you unlock and open the car using the detachable key blade, the alarm will be triggered.

#### Finding the key blade

1. Hold the key with the Volvo logo facing upwards.

Slide the small catch on the keyring bracket to the side and slide the front shell away from the bracket.



> The front shell detaches.

2. Lift the front shell off and locate the key blade underneath it.

#### Unlocking with the key blade

3. Go to the front door on the left-hand side of the car. Pull out the door handle to its end position.
4. Turn the key clockwise 45 degrees clockwise so that it is pointing straight backwards.



5. Turn the key back 45 degrees anticlockwise back to its starting position and remove it.

- > The door can be opened.  
The alarm triggers.

#### Deactivating the alarm

6. Place the key on top of the key symbol in the backup reader.



Location of the backup reader inside the tunnel console's storage compartment

#### *i* Note

When using the backup reader, make sure that the area is free of other car keys, metal objects and electronics such as mobile phones, tablets, laptops or chargers. Such objects could disrupt the reader.

7. Press the start button.

- > The alarm deactivates.

#### Locking with the key blade

8.

#### *i* Note

You can lock the front door on the left-hand side in the same way that you unlocked it.

Each of the other doors has a lock reset in their side that needs to be pressed in using the key blade.

Insert the key blade into the keyhole to reset the lock. Make sure it's fully inserted.

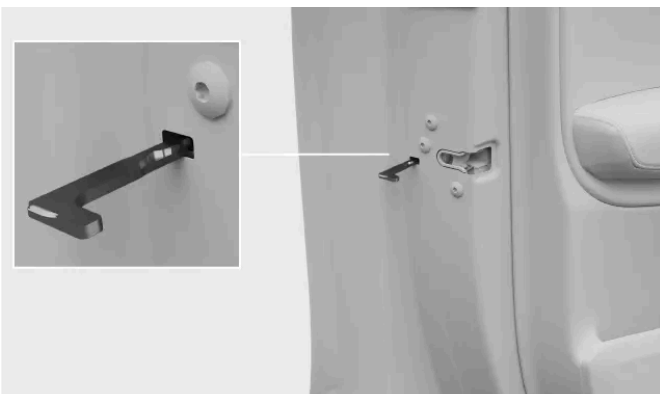

**!** Important

- A door's lock reset only locks that particular door, not all doors.
- If the child lock is active when you lock a rear door with the key blade, that door can't be opened from the outside or the inside. To unlock it, you need to use the buttons on the key, the central locking button, the keyless locking system or the Volvo Cars app.

## 6.3.4. Locking and unlocking from inside the car

You have several options for locking or unlocking the car from the passenger compartment.

The central lock can be controlled from the front seats using the buttons on each respective door.



### Locking the whole car

- Press the lock symbol  on the central lock button.
- > All of the doors, the boot hatch and the fuel filler flap are locked.

### Unlocking the whole car

- Press the unlock symbol  on the central lock button.
- > Depending on your settings, only the selected door or all doors unlock, as well as the boot hatch and fuel filler flap.

### Unlocking with the front door handles

- Pull the front door handle.
- > Depending on your settings, only the selected door or all doors unlock, as well as the boot hatch and fuel filler flap.

### Unlocking a rear door with the door handle

**Note**

The child lock needs to be deactivated to unlock the rear doors.

Pull the rear door handle once.

- > The door unlocks and opens.

## 6.3.5. Activating child lock

You can activate and deactivate the child lock with a button in the driver's door.

**Important**

When driving with children in the rear seats, check that the rear doors are secured with an active child lock.

The child lock can increase passenger safety in the rear seats. When the child lock is active, the passengers in the rear seats are unable to open the rear doors or operate the rear windows.

The driver maintains control over the windows, and the car can be opened from the outside if it is unlocked.

### Activating child lock

1.



Location of the child lock button in the door panel

With the ignition turned on, press the child lock button in the door panel.

- > The child lock is activated.
- > The indication light on the child lock button illuminates and a message is shown in the driver display to confirm that the lock is on.

You can deactivate the child lock by following the same steps you took to activate it.

If the child lock is active when you switch the car off, it will remain active the next time the car is started.

---

## 6.3.6. Settings for locking and unlocking

You can customise how your car reacts when locking or unlocking.

### Note

Different settings affect how and when your car is locked. Make sure to familiarise yourself with the different options and how they affect the locking and unlocking behaviours.

You can customise many of your car's general locking behaviours. For example, you can turn feedback responses on or off. You can also choose whether only one or all of the doors should unlock when you use the touch points on the door handles.

### Tip

#### Closing the sun blind automatically

You can turn on **Auto-close sunroof curtain** in settings to make the sun blind close automatically after 15 minutes if the car is parked and locked in warm weather. This helps ensure a comfortable passenger compartment temperature and protects the car's upholstery from fading in the sun.

---

## 6.3.6.1. Adjusting locking and unlocking settings

You can adjust several of your car's locking and unlocking responses and behaviours in settings.

### Important

#### Changing locking and unlocking settings

Enabling or disabling certain features affects how and when your car locks and unlocks. Make sure you familiarise yourself with the different key types as well as the locking and unlocking features. Misunderstanding a feature might lead you to believe that your car is locked when it isn't.

1. Press the car symbol  in the bottom bar and go to **Settings**.
2. Go to **Controls** → **Locking**.
3. Adjust your locking and unlocking settings.

### Warning

Volvo recommends not leaving people or pets in a locked car.

Some regions have laws prohibiting people or pets being left inside a locked vehicle.

## 6.4. Anti-theft

Your car has systems and features which help to make your car secure when it's locked.

When the car is locked, some functions and systems are either shut down or activated to help protect the car from theft.

### Warning

Do not leave your keys unattended in your car. They can be used to disable the security systems.

### Alarm

The alarm is automatically armed when you lock the car from the outside. It's also disarmed automatically when you unlock the car using the standard key's buttons or the key tag.

If you unlock the door using the detachable key blade, you need to deactivate the alarm manually.

### Immobiliser

The immobiliser is an anti-theft system that prevents your car from being driven until it's started using a valid key. If your car can't find the key or fails to authenticate it, your car will remain immobilised. If the key can't be found or has a low battery, a notification appears in the centre display.

## Double lock

The double lock feature allows you to simultaneously lock your car from the outside and the inside. This is to prevent unauthorised attempts to open the car using the inner door handles.

It activates with a delay of a few seconds after the car is locked from the outside. Once the car is double-locked, it can't be unlocked from the inside. If a door is opened within the delay time, double lock is disabled and the alarm is deactivated.

### Warning

Do not lock the car from the outside if anyone is still inside it. Double locking means that the vehicle cannot be unlocked or opened from the inside.

The driver remains responsible for the well-being and safety of anyone left in the car.

Some regions have laws prohibiting people or pets being left inside a locked vehicle.

## 6.4.1. Alarm

The alarm helps deter unwanted interference with your car when it's parked.

The alarm is automatically enabled when you lock the car and disabled when you unlock the car with the standard key or key tag.

If you unlock the car using the detachable key blade, the alarm will sound until you put the key on the backup key reader in the tunnel console's cup holder.

### Alarm indicator



The alarm indicator is a light located in the centre of the dashboard, just in front of the windscreen. The indicator confirms when the alarm is enabled with a flashing red light.

### Triggering the alarm

The content of this manual represents the status of the user manual at the time of printing and may not be completely valid in future instances. For more information, refer to the first page for the complete disclaimer note.

When armed, the alarm will trigger if:

- a door, the bonnet or the boot is opened.
- movement is detected in the passenger compartment.
- the car is raised or towed.
- the battery or siren is disconnected.

Once the alarm is triggered, the following happens:

- The alarm sound starts.
- The alarm indicator and the warning lights will flash for up to 5 minutes.
- The alarm cycle restarts several times over if whatever triggered the alarm isn't resolved.

## Stopping the alarm

Unlocking the car while the alarm is triggered will stop any alarm sounds and lights. The alarm indicator will continue to flash rapidly for some time to highlight that there was a recent potential security issue.



Tip

### Avoid triggering the alarm by mistake

Some steps you can take to avoid unintentionally triggering the alarm are:

- Closing all of the windows when you leave the car.
- Closing the panoramic roof.
- Reducing the alarm sensitivity in settings.
- Aiming the airflow so that it doesn't point upwards in the passenger compartment.



Important

Do not make any changes or additions to the alarm system, or it may not work properly.

## 6.4.1.1. Activating and deactivating the alarm

In most cases, you can use your key to turn the alarm on or off. If this isn't working, you can turn the alarm off manually.

Unlocking the car to disarm it usually works. However, in certain situations, you need to disable it manually.

**Note**

### Reducing the alarm sensitivity

It's not possible to lock the car without enabling the alarm. You can, however, reduce the alarm sensitivity in settings.

### Switching off a triggered alarm

If the alarm has been triggered, you can turn it off using the unlock button on your standard key or Care Key. If your key's buttons don't work, you have to disable the alarm manually.

#### Disabling the alarm manually

1. Place the key on top of the key symbol in the backup reader.

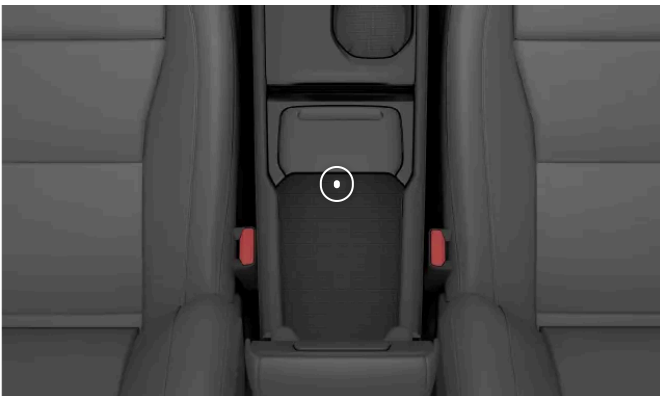

Location of the backup reader inside the tunnel console's storage compartment

**Note**

When using the backup reader, make sure that the area is free of other car keys, metal objects and electronics such as mobile phones, tablets, laptops or chargers. Such objects could disrupt the reader.

2. Press the start button.

> The alarm deactivates.

## 6.4.1.2. Reducing the alarm sensitivity

Reduce the alarm sensitivity when you expect significant movement in or around the car when parked.

This setting is especially useful if the car is parked where it can be affected by external motion, such as when travelling on a ferry.

 **Note**

Check the alarm indicator if you are unsure about how the car is reacting.

1. Press the car symbol  in the bottom bar and go to **Settings**.
2. Go to **Controls** → **Locking** → **Reduce alarm sensitivity**.
3. Turn reduced alarm sensitivity on or off.

Reduced alarm sensitivity resets to off at the start of a new driving session.

---

# 7. Refuelling

Learn about fuel and how you refuel your car.

In this section, you can find out more about fuel, different octane ratings and how you refuel your car.

---

## 7.1. Refuelling your car

It is important to use the correct fuel for your car and to avoid spilling it.

### Important

Only use petrol from well-known manufacturers. Never refuel your car if you aren't sure about the quality.

Always use the correct fuel. Even small amounts of the wrong type of fuel could damage the fuel system and engine.

Avoid spilling petrol when refuelling. In addition to causing harm to the environment, petrol containing alcohol can cause damage to painted surfaces.

1. Turn off the car and open the fuel filler flap with a gentle press on the rear of the flap<sup>[1]</sup>.
2. Insert the pump nozzle into the fuel filler opening. The filler pipe has two opening caps. The pump nozzle must be pushed past both caps before refuelling starts.

### Tip

#### Refuelling from a fuel container

If you are refuelling from a fuel container, be sure to use the funnel located in the foam block in the boot's cargo hold.

3. Refuel your car. Only fill the tank until the pump nozzle cuts out the first time.

### Note

Do not overfill the tank. An overfilled tank can overflow, especially in high temperatures and hot weather.

4. When you are done refuelling your car, gently press the flap to close it.

<sup>[1]</sup> Your car must be unlocked before the fuel filler flap can be opened.

## 7.2. Fuel/Petrol information

It's important to use the correct fuel when refuelling your car. Petrol is available with different octane ratings that are adapted for different types of driving.

### **Warning**

Never swallow fuel. Fuels such as petrol, bioethanol and mixtures of these are very toxic and can cause permanent injury or even death if they are swallowed. Seek medical attention immediately if you have swallowed fuel.

Always take precautions to avoid inhaling fuel fumes and getting fuel splashed in your eyes.

If you get fuel in your eyes, remove contact lenses if applicable, rinse your eyes thoroughly with water for at least 15 minutes and seek medical attention.

Carbon monoxide is a toxic, colourless and odourless gas. It is present in all exhaust gases. If you ever notice the smell of exhaust inside the car, make sure the passenger compartment is ventilated and contact an authorised Volvo workshop for any required repairs or servicing.

Avoid any fires, such as from cigarette lighters and lit cigarettes.

When refuelling your car, always follow your local restrictions.

### **Important**

#### Refuelling your car

Only use petrol from well-known manufacturers. Never refuel your car if you aren't sure about the fuel's quality.

Always use the correct fuel. Look at the label on the inside of the fuel filler flap. Even small amounts of the wrong type of fuel could damage the fuel system and engine.

Always follow the warning signs posted at the petrol station.

Close all doors and windows before you start refuelling.

#### Additives and quality

To avoid damage to the engine, only use unleaded petrol.

Do not use fuel containing methanol.

Except for the use of antifreeze for fuel lines during the winter, do not use solvents, thickeners or other additives in the car's fuel, cooling or lubrication systems. Overuse may damage your engine, and some of these additives contain organically volatile chemicals. Do not needlessly expose yourself to these chemicals.

## Octane rating

There are different octane ratings of petrol that are adapted for different types of driving.

When driving in climates warmer than +38°C (100°F), the highest possible octane number is recommended for an adapted performance and fuel consumption.

Fuel with octane rating:

- lower than RON 95 cannot be used.

## Petrol identifiers

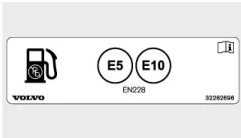

Petrol with the following identifiers may be used in cars with a petrol engine:



### Important

#### Fuel with ethanol

Fuel containing up to 10% ethanol by volume is allowed.

You can use EN 228 E10 petrol.

You cannot use ethanol higher than E10.

## Petrol particle filter

Cars that use petrol are equipped with a particle filter for more efficient emissions control. During normal driving, the particles in the exhaust gases are collected in the filter. In normal driving conditions, passive regeneration is used to oxidise the particles and burn them away. This empties the filter.

If you drive your car at low speeds or repeatedly try to start your car in low outside temperatures, active regeneration may be necessary. Regeneration of the particulate filter starts automatically and normally takes about 10-20 minutes. The fuel consumption may increase during regeneration.

The capacity of the emissions system is affected by how the car is driven. If you drive your car for short distances at low speed or in cold climates where the engine does not reach normal operating temperature, it can lead to problems that eventually can cause a malfunction and trigger a warning message. If you mostly drive your car in city traffic, it is important to regularly drive at higher speeds to allow the emissions system to regenerate.

## 8. Driving

Your car is designed for driving. This section covers the essential driver controls that allow you to start, stop, steer and change gears. You can also find information about driving characteristics and handling here.



Many of your car's driving features can be customised for a personalised experience. While some features are more directed towards comfort, others are strictly safety related. It's important to check your driving position, maintain good visibility and to always stay attentive and focused while driving.

---

### 8.1. Trips app

The Trips app is a driving journal that automatically logs all trips made with your car.

When this app is enabled, it automatically collects your car's identification number<sup>[1]</sup>, location and other trip-related data, such as time, distance and battery consumption.

#### Note

The Trips app calculates the battery consumption based on pure consumption during a trip. If you see a different value in your car's trip meter, it's because the trip meter also takes energy regeneration into account.

In the Volvo Cars app, you can:

- View, manage and delete all of your trips.
- Export your driving journal.
- Stay informed if a trip isn't uploaded due to an issue, such as network problems.

The content of this manual represents the status of the user manual at the time of printing and may not be completely valid in future instances. For more information, refer to the first page for the complete disclaimer note.

When the Trips app is enabled, all users that have paired the Volvo Cars app with the car can see the trips. If the Trips app is disabled, the car stops sending information about new trips.

**Note**

### Car location sharing

You need to enable car location sharing in the display and in the Volvo Cars app to start logging your trips.

## Storage limits

When a trip is logged, it can be stored in the Trips app for up to 400 days. The app has the capacity to store approximately 500 trips. When this limit is reached, older trips are automatically deleted to free up space and make room for new trips.

**Note**

If the journal isn't logging trips, the reasons for this might include:

- Weak or no network connection.
- The app isn't receiving GPS coordinates.
- Location permissions are disabled so the Trips app can't access the car's location.

[1] VIN

## 8.2. Starting the car

You start the car by pressing the brake pedal and pressing the start button. Starting the car also requires a present and correctly used key.

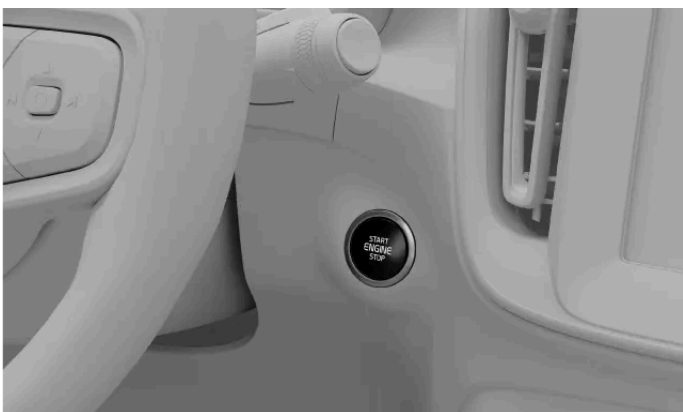

Press the start button to start your car.

Before you start driving, make sure that:

- All doors are closed.
- All occupants are properly seated and wearing their seatbelts correctly.

**The content of this manual represents the status of the user manual at the time of printing and may not be completely valid in future instances. For more information, refer to the first page for the complete disclaimer note.**

- The driver seat, the steering wheel position and the mirrors are adjusted to your driving position.
- The driver area and the pedals are not obstructed.

 **Tip**

The car can alert you to certain conditions you should address before driving. If something is preventing you from starting the car, have a look in the driver display for guidance.

1. Make sure you have a key with you.
2. Press and hold the brake pedal down.
3. Press the start button.

> The engine starts.

 **Note**

If you want to turn the ignition on without starting the engine, press the start button without pressing the brake pedal. This lets you operate the windows or adjust the climate settings, for example. Keep in mind that having the ignition on drains the battery.

4. Select gear D or R using the gear selector.

> The selected gear is indicated in the driver display. The ready symbol also appears, emphasising the transition from parked to a driving gear.

 **Note**

The ready symbol disappears when the car's speed exceeds walking pace.

 **Warning**

Don't leave the car running in an enclosed space. The fumes can cause serious harm to people or animals.

If the engine doesn't start after three attempts, try again after a few minutes. Waiting a while before trying again allows the 12V battery to recover.

## 8.2.1. Start-up checks

When you select a gear to start driving, the car performs a number of self-checks of important systems and functions. This short test is indicated in the driver display.

The start-up check is indicated by several warning and indicator symbols in the driver display. If any of the warning or indicator symbols remain visible after a few seconds, it tells you that there's a fault or condition you need to address before driving.

If a fault is indicated:

- Read any related information presented in the driver display.
- For additional information about warning and indicator symbols, consult that section of the manual.
- Resolve the indicated fault before driving.
- If you cannot resolve the issue yourself, do not hesitate to contact an authorised Volvo workshop.

After the start-up check is performed, the car continues to actively monitor many of its systems and functions.

---

## 8.2.2. Alcohol lock

The alcohol lock is a safety measure to prevent driving under the influence of alcohol. If your car is equipped with an alcohol lock, you must take and pass a breath test before you can start your car.

If you have connected an alcohol lock, it will integrate with some of your car's systems. This means that you can receive messages from the alcohol lock directly in the driver display. Alcohol lock calibration should be done in accordance with the local laws and regulations on the limit value in force for driving legally.

For information about a specific alcohol lock, please refer to the relevant alcohol lock manufacturer.

### **Warning**

The alcohol lock is an aid and does not exempt the driver from responsibility. It is always the responsibility of the driver to be sober and to drive the car safely.

## Using an alcohol lock

The alcohol lock automatically activates to be ready for use when the car is unlocked. Follow the instructions included with the installation of the alcohol lock, along with the messages presented in the driver display.

After completing a driving cycle, meaning that you have driven and then stopped, your car can be restarted within 30 minutes without requiring a new breath test.

### **Tip**

#### Accurate measurement

Avoid eating or drinking approximately five minutes before the breath test.

Avoid excessive windscreen washing as the alcohol in the washer fluid may affect the alcohol lock.

## Emergency bypass of the alcohol lock

In the event of an emergency or if the alcohol lock is not working, it is possible to bypass the alcohol lock. To do this, see the instructions provided with the alcohol lock or contact the manufacturer.

---

## 8.3. Turning the car off

You turn the car off using the start button.



Press the start button to turn your car off.

1. To turn the car off, press the start button.

If the car is moving or is not in gear P, press the start button and hold it until the car turns off. Then release the start button.

---

## 8.4. Driving characteristics

Explore the features that affect driving performance and dynamics. This can allow you to customise your driving experience.



Your car has several features that affect the driving dynamics and performance.

- Drive modes** Your car has different drive modes to choose from, which are suited for different kinds of driving. Selecting a drive mode changes the driving dynamics and can sometimes affect what settings are available.
- Manual gear shifting** Even though your car has an automatic gearbox, you can enable manual gear shifting by selecting gear M.
- Start and stop** The start and stop feature reduces fuel consumption and emissions by letting you temporarily turn the engine off during brief stops while keeping the car's systems active.
- Launch feature** Launch can be used when you need maximum acceleration from a standstill, such as when starting your car on a steep incline.
- Steering feel** Adjusting the steering feel affects the steering wheel resistance and firmness.
- Electronic stability control<sup>[1]</sup>** Your car has automatic stability control systems in place that can help to prevent skidding.

<sup>[1]</sup> ESC

---

## 8.4.1. Drive modes

The drive modes change the driving dynamics of your car and which settings are available.

The different drive modes available in your car are all suitable for different scenarios and types of driving. Depending on which drive mode you select, certain driving dynamics may be affected, such as steering, suspension, braking and acceleration.

Different drive modes also allow for different adjustable settings, both related to both driving and climate.

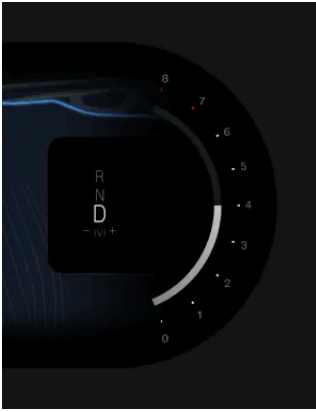

Your selected drive mode is shown above the selected gear in the driver display<sup>[1]</sup>.

Your car has two drive modes:

**Standard** This is the default mode and is recommended for everyday use. It's also selected automatically every time you start the car.

**Off-road** The off-road mode is suitable for when you're driving on roads with limited accessibility or rough terrain. You can also use off-road mode when you're driving on loose surfaces as deep snow or sand. It activates hill descent control, allowing your car to brake in a more controlled and active way when driving downhill.

**Note**

**Off-road**

The off-road mode is only available at speeds below 40 km/h (25 mph). Driving at higher speeds automatically disables the off-road mode. If this happens while driving on a steep downhill gradient, the automatic braking effect from hill descent control will gradually decrease.

Your fuel consumption may increase when driving with the off-road mode selected.

Selecting the off-road mode disables the start and stop feature.

The off-road mode is not designed to be used on public roads.

<sup>[1]</sup> The comfort mode is not indicated in the driver display, as it is your standard mode

## 8.4.1.1. Selecting a drive mode

You can select a drive mode in settings.

Your car is equipped with different drive modes for different driving conditions and situations. Selecting a drive mode allows your car to adjust the driving characteristics and dynamics for the intended use, which might disable certain settings. You can select a drive mode in settings.

The comfort drive mode is selected by default every time you start your car.

1. Press the car symbol  in the bottom bar and go to **Settings**.

The content of this manual represents the status of the user manual at the time of printing and may not be completely valid in future instances. For more information, refer to the first page for the complete disclaimer note.

2. Go to **Driving** → **Drive modes**.

3. Select a drive mode.

> Your car's driving characteristics and settings are adjusted, depending on your selected drive mode.

---

## 8.4.2. Using the launch feature

Launch can be used when you need maximum acceleration from a standstill, such as when starting your car on a steep incline.

The launch feature can be helpful when you're starting the car on a steep uphill incline as it allows maximum acceleration from a standstill.



### Note

The launch feature should be used sparingly as it causes wear on the engine.

The launch feature is only available from a standstill and after selecting gear D.

1. Press the brake pedal all the way down.

2. Press the accelerator pedal all the way down.

3. Release the brake pedal within two seconds.

> The car launches with maximum acceleration.

---

## 8.4.3. Activating start and stop

The start and stop feature reduces fuel consumption and emissions by letting you temporarily turn the engine off during brief stops while keeping the car's systems active.

The start and stop feature lets you temporarily turn the engine off during brief stops, such as when you stop at a traffic light. It then turns the engine back on once you're ready to drive again. This helps you reduce your fuel consumption and the car's emissions.

You can see the status of the start and stop feature in the driver display.



The start and stop feature is active and the engine is temporarily turned off.



The start and stop feature is available but not active.



The start and stop feature is unavailable.

All of the car's systems continue to work while the engine is turned off by the start and stop feature. However, some functions, such as speaker volume, might operate at a reduced capacity until the engine is turned back on.

The start and stop feature is not available if:

- The driver is not wearing a seatbelt.
- The bonnet is open.
- A trailer is connected to the car's electrical system.

#### Activating the start and stop feature

- Press and hold the brake pedal when you're at a standstill or driving at very low speeds.
- > The engine temporarily turns off.

#### Note

If you're driving with Pilot Assist active, the engine turns off after a few seconds.

#### Deactivating the start and stop feature

- Release the brake pedal or gently press the accelerator.
- > The engine turns back on.

---

## 8.4.4. Stability control

Your car has stability control systems in place that can help to prevent skidding.

### Electronic stability control

Electronic stability control<sup>[1]</sup> consists of several sub-features that can apply your car's brakes automatically to prevent skidding when the car detects a loss of traction or steering control. To do this, ESC applies the brakes to each wheel individually. When this intervention happens, the symbol for ESC flashes in the driver display.



The content of this manual represents the status of the user manual at the time of printing and may not be completely valid in future instances. For more information, refer to the first page for the complete disclaimer note.

Your car's stability control includes several other features, such as:

<b>Anti-lock braking system</b> <sup>[2]</sup>	The car's anti-lock braking system prevents the brakes from locking up during hard braking. This improves braking performance and manoeuvrability and helps with stabilising the car.
<b>Trailer stability assist</b> <sup>[3]</sup>	TSA can intervene if snaking is detected when you are towing a trailer.
<b>Spin control and traction control</b>	These features act to prevent the wheels from slipping against the road surface when you apply acceleration.
<b>Engine drag control</b> <sup>[4]</sup>	Helps with preventing wheel locking during engine braking on slippery surfaces.
<b>Off-road mode</b>	The off-road mode is suitable for when you're driving on roads with limited accessibility or rough terrain. You can also use off-road mode when you're driving on loose surfaces as deep snow or sand. It activates hill descent control, allowing your car to brake in a more controlled and active way when driving downhill.

## Stability control malfunction

If your car notices a stability control malfunction, it will notify you with a symbol and a message in the driver display. The message and symbol depend on the nature and severity of the detected fault. If the electronic stability control symbol is continuously shown instead of flashing, this could indicate a stability control malfunction.

Be sure to read and follow any instructions in the message. It is recommended to address any ESC malfunctions as soon as possible, although it is possible to drive the car with disabled ESC.



### Tip

Some ESC malfunctions may only be temporary. You can try turning your car off and then turning it back on to see if the message persists. If the message disappears, the malfunction was only temporary.



### Warning

Stability control features are supplements to safe driving practices. They do not reduce or replace the need for the driver to stay attentive and focused on driving safely. Drive the car with the same attention to safety as required by a car without the ability to intervene.

<sup>[1]</sup> ESC

<sup>[2]</sup> ABS

<sup>[3]</sup> TSA

<sup>[4]</sup> EDC

## 8.4.5. Suspension

Your car has suspension designed to create a pleasant driving experience.

 **Warning**

The shock absorbers are gas pressurised. Do not heat or open the shock absorbers.

## Suspension-related faults

If your car notices a suspension-related fault, it will notify you with a symbol and a message in one or more of the displays. The message and symbol depend on the nature and severity of the detected fault. Be sure to read and follow any instructions in the message.

## 8.5. Range

Your car's expected range is shown in the driver display and depends on several factors.

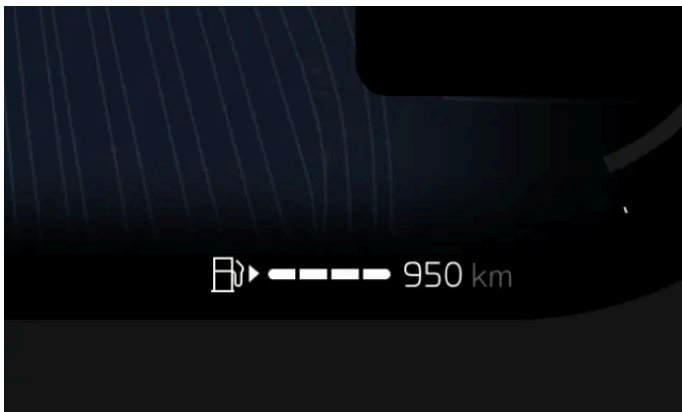

Your range is primarily related to the amount of fuel left in your car's tank and your driving practices but external conditions can also be a factor. The fuel meter and expected range are displayed in the driver display.

The displayed range tells you how far you can drive with your current fuel level. Your fuel consumption depends on your driving style and your selected drive mode. The displayed range is an estimation and may differ accordingly.

### Factors that affect your car's range

How you drive your car, which settings or features are active, driving conditions and traffic can all affect your car's range in different ways.

<b>Speed</b>	Driving at higher speeds increases your fuel consumption.
<b>Drive mode</b>	Depending on your selected drive mode, your fuel consumption may be affected.
<b>City driving and traffic situation</b>	Varying your speed by frequently accelerating and braking will increase your fuel consumption compared to keeping a constant speed.
<b>Climate settings</b>	Which climate features are active and to what extent they affect your fuel consumption.
<b>Tyres and tyre pressure</b>	Tyre condition and tyre pressure can affect your range.
<b>Road condition and topography</b>	The condition of the road, along with any potential slopes, can affect your range.
<b>Towing</b>	Towing a trailer demands more power from your car and will adversely affect fuel consumption. This is relative to the type of trailer being towed.

## 8.5.1. Trip meter

The trip meter shows information on your car's driving distance and average fuel consumption.

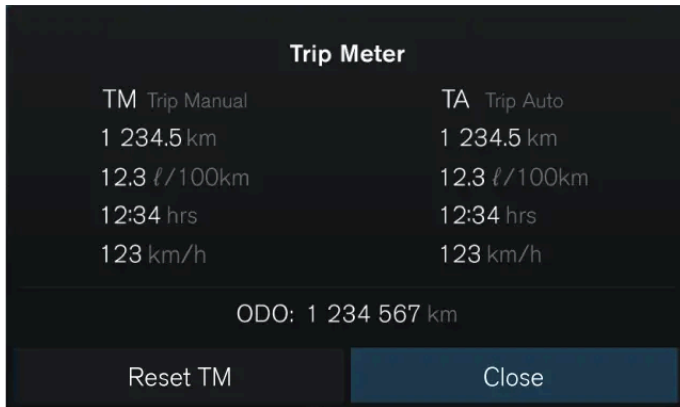

Your car has a trip meter and an odometer. The trip meter can show information on the car's driving distance and time, as well as your average fuel consumption and driving speed.

The trip meter is divided into two separate sections:

- Manual trip meter
- Automatic trip meter

The manual trip meter can be manually reset whereas the automatic trip meter resets after four hours if the car has not been driven.

The odometer shows the car's total driving distance and cannot be reset.

### Accessing the trip meter

You can open the trip meter by pressing the confirm button  on your steering wheel's right-hand-side control panel. The odometer is shown in the bottom of the trip meter view.

If you want to adjust the trip meter settings, you can do so via **Controls** in the centre display.

---

### 8.5.1.1. Resetting the trip meter

You can reset your car's trip meter.

You can reset the trip meter using either the steering wheel buttons or the RESET button on the left-hand-side steering wheel stalk.

 **Note**

You cannot reset the automatic trip meter.

#### Resetting the trip meter using the steering wheel buttons

1. Press the confirm button  on the steering wheel's right-hand-side control panel.
  - > The trip meter view appears in the driver display.
2. Select **Reset**.
  - > The manual trip meter resets.

#### Resetting the trip meter using the steering wheel stalk button

3. Press and hold the **RESET** button on the left-hand-side steering wheel stalk.
  - > The manual trip meter resets.

---

## 8.6. Steering

Get familiar with your car's steering-related functions.



Your car has been designed to provide a responsive and intuitive steering experience. Be sure to adjust your driving posture and select your preferred steering feel before driving.



Tip

### Steering and driver support interactions

Several of your car's driver support features can affect the steering. Read the manual sections about these features for a more complete understanding of how they can interact with and affect your steering experience.

## Speed-dependent steering response

The steering resistance and firmness change with the speed of the car. At low speeds, steering resistance is low for precision manoeuvring. At high speeds, the steering adapts to be firmer.

## Steering feel

You can adjust the steering feel via the settings in the centre display. Steering feel affects the firmness of the steering wheel's turning.

## Steering-related faults

If you notice that your steering wheel is abnormally firm, or if steering-related features<sup>[1]</sup> are not available or working properly, this can be due to a fault related to the steering system.

If your car detects a steering-related fault, it will notify you with a symbol and a message in one or more of the displays. The message depends on the nature and severity of the detected fault. Be sure to read and follow any instructions in the message.



The symbol for steering-related faults can be shown in the driver display if your car detects a fault with the steering system.

<sup>[1]</sup> Such as lane keeping aid or Pilot Assist

## 8.6.1. Steering wheel

Get to know the steering wheel and some of its controls and features.

You can use your steering wheel for more than just steering the car.



### Heated steering wheel

The steering wheel has built-in heating. The function can be turned on manually or set to automatic activation.

### Adjust the steering wheel position

The steering wheel can be adjusted to suit your driving posture.

### Steering wheel control buttons

There are buttons on the steering wheel that can control certain features, settings and adjustments.

### Horn

The button for the horn is located in the middle of the steering wheel and is indicated with the horn symbol .

---

### 8.6.1.1. Steering wheel controls

The steering wheel has several buttons and controls. They control specific functions such as the horn, as well as certain settings, adjustments and what's shown in the driver display.



- Horn
- Control buttons
- Left-hand stalk
- Right-hand stalk

## Control buttons



The buttons on your steering wheel's left-hand side control driver support features.



☞ Increase set speed or resume

The content of this manual represents the status of the user manual at the time of printing and may not be completely valid in future instances. For more information, refer to the first page for the complete disclaimer note.

- Decrease set speed
- ◀ Enable or disable Intelligent Speed Assist<sup>[1]</sup>
- ▶ Switch between Pilot Assist and adaptive cruise control
- ≡ Increase the time interval to vehicles ahead
- ⌵ Decrease the time interval to vehicles ahead

The buttons on your steering wheel's right-hand side control media and menu navigation in the driver display.

- Confirm or select
- ◀ Previous, rewind or left
- ▶ Next, fast forward or right
- ☰ Switch between driver display modes
- 🗣️ Voice control
- ▲ Increase volume or up
- ▼ Decrease volume or down

The buttons' functions change depending on the context and they typically control what's currently shown in the displays.

<sup>[1]</sup> ISA

## 8.6.1.2. Adjusting the steering wheel position

You can adjust the steering wheel position to suit your driving posture.

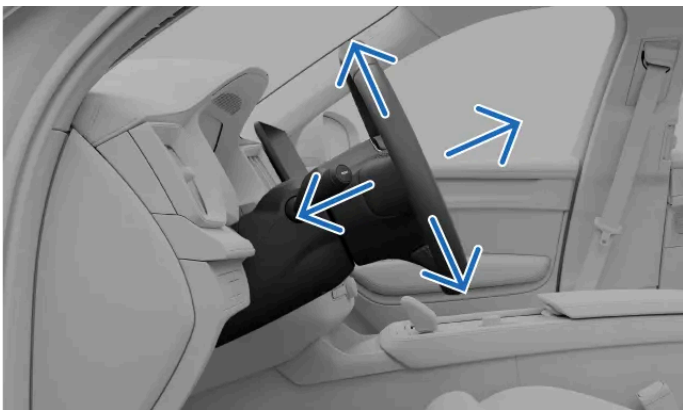

Adjusting the steering wheel position is fundamental to your driving posture, allowing you better comfort and control of the car.

 **Warning**

Make sure that you adjust your steering wheel position when you are parked as this should not be done whilst driving.

**!** Important

### Clear space around the driver display

Do not hang or place any objects on the steering column in front of or behind the driver display. You risk damaging the driver display if an object is placed there when the steering wheel position changes.

1. Push the steering wheel adjustment lever located on the steering wheel column.



2. Grasp the steering wheel and adjust its position.  
Move it up or down and backwards or forwards to fit your driving posture.
3. Pull the steering wheel adjustment lever up to secure the position of the steering wheel.

**!** Important

Once you've finished adjusting the steering wheel position to your liking, it's important to make sure other parts of the car are aligned correctly. Your driving posture is important and is affected by more than your steering wheel adjustments, such as the position of your seat and mirrors.

## 8.6.2. Adjusting steering feel

You can enable firmer steering feel in settings.

**i** Note

Your car has speed-dependent steering wheel resistance in addition to the manually adjusted steering feel. This means that your car automatically adjusts the steering wheel resistance in line with your driving speed, giving you enhanced control and stability.

You can only access the steering feel settings when you're parked or driving slowly without turning the steering wheel.

1. Press the car symbol  in the bottom bar and go to **Settings**.
2. Go to **Driving** → **Steering feel** → **Firm**.
3. Enable firmer steering feel.

---

## 8.7. Brakes

Your car has several types of braking functions, both manual and automatic.



Your car has several features and capabilities when it comes to braking.

<b>Foot brake</b>	Your main way of braking manually. Pressing the brake pedal may activate regenerative braking or engage the friction brakes, depending on the driving conditions.
<b>Regenerative braking</b>	Slows the car down by using the car's movement to charge the 48 V battery. <sup>[1]</sup>
<b>Friction brakes</b>	Slows the car down by engaging the disc brakes.
<b>Parking brake</b>	Keeps the car in place while parked.
<b>Auto hold</b>	Automatically applies the brake to hold the car when coming to a stop.
<b>Automatic braking</b>	This is a general term for the car's braking interventions. Several driver support and safety systems can intervene and perform braking manoeuvres for safety reasons or convenience.
<b>Post-impact braking</b>	Automatic braking after severe collisions to avoid further hazards.
<b>Electronic stability control<sup>[2]</sup></b>	Helps prevent skidding and other stability-related issues by automatically applying the brakes individually.
<b>Anti-lock braking system<sup>[3]</sup></b>	Prevents the brakes from locking up during hard braking. This improves the braking performance stability and manoeuvrability of the car.



Note

## Brake lights

Your car's brake lights automatically light up during braking manoeuvres. The lights respond to manual braking from brake pedal use, as well as automatic braking from any driver support system.

## Emergency brake lights

During hard braking manoeuvres, or if the ABS system is activated, your car's emergency brake lights can activate. This causes the brake lights to flash to alert vehicles behind you. Your car's hazard warning lights can also be activated in these situations, but only after the car has slowed down to a speed below 10 km/h (6 mph).

<sup>[1]</sup> Converts kinetic energy to electricity.

<sup>[2]</sup> ESC

<sup>[3]</sup> ABS

## 8.7.1. Foot brake

The foot brake engages different types of braking mechanisms, depending on the situation.

The foot brake engages either regenerative braking or the friction brakes, depending on how hard you press the pedal. Light braking activates regenerative braking, whereas harder braking engages the friction brakes.

### Electronically controlled braking<sup>[1]</sup>

The foot brake is electronically controlled. As the braking force is transmitted electronically rather than physically, there are no natural reaction forces travelling from the brakes to the pedal.

### Anti-lock braking system<sup>[2]</sup>

The car's anti-lock braking system prevents the brakes from locking up during hard braking. This improves braking performance and manoeuvrability and helps with stabilising the car.



Note

## Parking brake

At high speeds, pulling and holding the parking brake switch slows the car down at a steady rate. This provides a backup alternative to braking normally. Only use the parking brake in this way if you are unable to brake using the brake pedal.

## Start-up checks

Several brake systems are part of the car's start-up check. Make sure to resolve any indicated brake faults before driving.

 **Warning**

### Wet brakes

The car's stopping distance may be longer if the brake discs are wet. If they have been exposed to water, safely perform a braking manoeuvre to remove water from the brakes. By engaging the disc brakes while driving, they heat up and dry.

[1] Also called brake-by-wire.

[2] ABS

## 8.7.2. Parking brake

The parking brake keeps the car stationary when you're at a standstill, such as after parking.

The parking brake locks the car's rear wheels. When parked, the car monitors and automatically tightens the grip if necessary.

By pulling the parking brake switch (P) in the tunnel console when you're at a standstill, you engage the parking brake. Your car can automatically engage the parking brake in several situations.

 **Important**

### Parking gear

The parking gear and the parking brake are not the same thing. While the parking gear is capable of holding the car stationary to a certain degree, it is not sufficient in all situations. Be sure to engage the parking brake after parking, as its applied braking force is much larger. This is particularly important when parking on an incline.

The driver display indicates when the car is in park and the parking brake is engaged.

 **Warning**

Avoid parking on a slope in wintry conditions. The tyres might lose traction, even if the parking brake is engaged. You are always responsible for safe parking. Check the parking brake warning symbol for the parking brake status.



Continuous illumination indicates that the parking brake is engaged. Flashing indicates a parking brake fault.

 **Note**

At high speeds, pulling and holding the parking brake switch slows the car down at a steady rate. This provides a backup alternative to braking normally. Only use the parking brake in this way if you are unable to brake using the brake pedal.

---

## 8.7.2.1. Engaging the parking brake

Engage the parking brake by pulling the parking brake switch in the tunnel console.



Manually engage the parking brake by pulling the parking brake switch.

Your car can automatically engage the parking brake in several situations. These include when:

- you select the parking gear, P, when stationary on a steep incline.
- your car has been stationary in auto hold for a longer period of time.
- you leave your car or turn it off while auto hold is active.



### Automatic parking brake release

The parking brake is automatically released when you press the accelerator after selecting gear D or R. You must also have your seatbelt buckled or the driver door closed.

### Manually engaging the parking brake

1. After coming to a stop, pull the parking brake switch (P) in the tunnel console.
- > The parking brake is engaged. The P on the parking gear button lights up and the parking brake symbol is shown in the driver display.



### Manually releasing the parking brake

2. Press the brake pedal firmly.
  3. Push the parking brake switch (P).
- > The parking brake is released and the parking brake symbol in the driver display disappears.

---

## 8.7.3. Auto hold

Auto hold helps to keep the car stationary after coming to a full stop, allowing you to release the brake pedal.

The content of this manual represents the status of the user manual at the time of printing and may not be completely valid in future instances. For more information, refer to the first page for the complete disclaimer note.

When the car comes to a full stop, auto hold will automatically activate if the feature is enabled.

Activation of auto hold is indicated by the auto hold symbol in the driver display.



To exit auto hold and continue driving in the selected gear, press the accelerator.

**i Note**

**Automatically engaging the parking brake**

If auto hold has been active for a longer period of time, the parking brake is automatically activated. This can also happen if you unbuckle your seatbelt, open the driver door or turn the car off while auto hold is active.

You can enable or disable auto hold using the auto hold button (A) in the tunnel console.

## 8.7.3.1. Enabling auto hold

You can enable or disable auto hold with the auto hold button in the tunnel console.

Auto hold automatically applies braking after you've come to a stop. You can enable or disable auto hold by pressing the auto hold button in the tunnel console.



1. Press the auto hold button in the tunnel console.
- > Auto hold is enabled and the symbol (A) is illuminated on the auto hold button.

**i Note**

**Disabling auto hold**

You can disable auto hold in the same way as enabled it. Just press the auto hold button in the tunnel console. The auto hold symbol (A) on the button will no longer be illuminated after disabling the feature.

If auto hold is active and currently holding your car stationary, you must press the brake pedal and the auto hold button simultaneously to be able to disable the feature.

After disabling auto hold, some brake assistance is still available at a standstill, such as roll-back prevention when starting the car on an uphill incline.

---

## 8.7.4. Post-impact braking

The car automatically applies the brakes when a severe collision is detected. This can reduce the risks associated with additional impacts.

In the moments after a collision, the car may still be moving at high speed. There is also a major risk that the driver is not in full control of the car, which could lead to additional impacts.

In the event of a severe collision<sup>[1]</sup>, automatic braking reduces your speed in a controlled manner, bringing the car to a halt. Reducing your speed is especially important if there are pedestrians, vehicles or objects in the car's path.

The brake lights and hazard warning lights activate during the manoeuvre. When the car comes to a stop, the hazard warning lights stay on and the parking brake activates.

### Note

#### Manual override

Pressing down on the accelerator overrides the braking manoeuvre, allowing the driver to select a safe place to stop.

Post-impact braking requires that the brake system is intact after the collision.

<sup>[1]</sup> The severity of the collision must exceed a certain threshold for post-impact braking to activate. For example, if airbags have deployed.

---

## 8.8. Gearbox

Your car has an automatic gearbox, meaning that gears are selected automatically so that you can drive as efficiently as possible.



The available gears are:

- R Reverse
- N Neutral
- D Drive
- M Manual
- P Park

Having an automatic gearbox means that you don't have to change gears manually while driving. When driving in gear D, the car adjusts the gear depending on your driving speed and the power requirements.

## Manual shifting

Manual shifting is available in gear M. Once selected, you can shift up or down by moving the gear selector to the left or right. If you drive too fast or slow relative to your selected gear, the car will automatically shift to a higher or lower gear.

### Note

#### Kick-down acceleration

By pressing the accelerator pedal all the way down, beyond the position normally regarded as full acceleration, you activate the kick-down feature. Your car will shift down to a lower gear, enabling faster acceleration. This can be helpful if you are about to overtake another vehicle.

Once the accelerator pedal is released, the car will shift up to the appropriate gear again.

## Parking gear

The parking gear can be automatically selected in situations where your car interprets your actions as if you're about to park and leave. These situations can include:

**The content of this manual represents the status of the user manual at the time of printing and may not be completely valid in future instances. For more information, refer to the first page for the complete disclaimer note.**

- Turning your car off when stationary in gear D or R.
- Unbuckling your seatbelt and opening the driver's door while the car is moving slowly without you using the brake or accelerator pedals.

You can also select the parking gear by pressing the P button next to the gear selector.



When P is selected, the gearbox is mechanically blocked to avoid accidental gear shifts.

**!** Important

### Parking brake

The parking gear and the parking brake are not the same thing. While the parking gear is capable of holding the car stationary to a certain degree, it is not sufficient in all situations. Be sure to engage the parking brake after parking, as its applied braking force is much larger. This is particularly important when parking on an incline.

## Gearbox-related faults

If a fault is detected with the gearbox, such as overheating, this is communicated with a message in the driver display. Make sure to follow any instructions in the message.

### 8.8.1. Selecting gear

Select a gear by moving the gear selector backwards or forwards. The current gear is indicated in the driver display.



The available gears are:

- R Reverse
- N Neutral
- D Drive
- M Manual
- P Park

When moving the gear selector either backwards or forwards, you can feel that it has two positions in both directions. Select R by moving the gear selector all the way forwards. Move the selector all the way backwards to select D.

You can select the neutral gear, N, by moving the gear selector to the first position in either direction and holding it there for a couple of seconds. The gear selector always returns to its middle position between gear selections.

Select M by moving the selector all the way backwards while driving in gear D. This enables manual gear shifting. Move the selector backwards again to return to gear D.

**Note**

Selecting gears D, R, N or P is only possible when the car is stationary or when you are driving at walking pace.

1. Press the brake pedal <sup>[1]</sup>.
  2. • Move the gear selector forwards or backwards to select one of the driving gears or neutral.
    - Press the P button next to the gear selector to select the parking gear, P.
- > Your selection is indicated in the driver display.

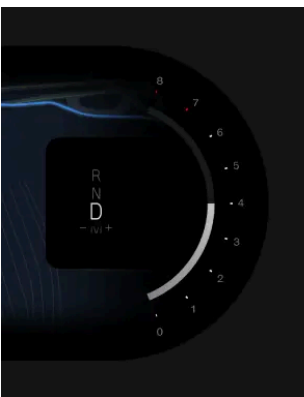

<sup>[1]</sup> only necessary if your car is stationary

## 8.8.2. Shifting gears manually

You can manually shift gears when driving in gear M.



After selecting gear M, you can manually shift gears by moving the gear selector to the left or right.

**(i) Note**

**Gear shift indicator**

The gear shift indicator in the driver display shows the current gear and tells you when to shift gears by flashing a plus or minus symbol.

To maintain a good fuel economy, it's important to drive in the correct gear and change gears in time.

**(!) Important**

Manually shifting gears is only available after selecting gear M.

**Shifting to a higher gear**

- Move the gear stalk to the right to shift up a gear.

**Shifting to a lower gear**

- Move the gear stalk to the left to shift down a gear.

**(i) Note**

Driving too fast or slow relative to your selected gear may cause the car to automatically shift to a higher or lower gear.



## 9. Visibility, mirrors and exterior lights

Learn how to control your car's lights, mirrors and wipers for better visibility when the conditions call for it.



Front view of the car showing exterior lights, mirrors and windscreen wipers

Your car is equipped with multiple features to assist you in your driving. Some are designed to improve safety, while others improve visibility. Some features are designed with both purposes in mind. Reading this section of the manual can assist in making your driving experience safer and more comfortable.

---

### 9.1. Exterior lights

Your car has a range of lighting capabilities. You can select and control the different lighting options.

 **Warning**

Car lights systems which are dependent on ambient light detection do not absolve the driver of responsibility for ensuring that proper lighting is used for all situations according to local laws and traffic regulations.

Exterior lights refers to all of the exterior illumination functions and features that affect visibility.



Exterior lights controls locations

- ① You control certain driving lights, such as the lighting modes, fog lights and the direction indicators with the left-hand steering wheel stalk.
- ② You select exterior convenience lights in the centre display.
- ③ The hazard warning lights button is located below the centre display.

Some lighting features rely on the car's ability to sense that there are poor light conditions outside. Make sure that the car cameras are kept clean and are well-maintained. If the cameras' views are affected by dirt, they can't do their job properly. They need to be able to obtain enough information so that they can properly direct the car's responses.

**i Note**

**Condensation in the lights**

Exterior lighting may temporarily contain water from condensation. This is normal and all exterior lights are designed to withstand this. Condensation is normally vented out of the light housing after a period of time.

## 9.1.1. Driving lights



Driving lights mix automatic behaviours and direct controls which allow you to adapt to any situation or visibility conditions.

**! Important**

The driver is always responsible for ensuring that the car is driven while using a lights mode that is suitable for the current driving conditions and local traffic regulations.

### Exterior lighting

You can choose between several different exterior lighting modes by rotating the ring on the left-hand steering wheel stalk.

<b>AUTO</b>	Auto	The automatic lights mode <sup>[1]</sup> allows your car to automatically detect and calculate which lighting mode is most suitable depending on the lighting conditions.
	Passing beam	You can manually select the passing beam to keep the front lights dipped.
	Position lights	The position lights are points of illumination around the car that make your car more visible to other road users.
<b>0</b>	Off	0 deactivates all lighting modes. <sup>[2]</sup>
	Automatic high beam	Automatic high beam allows the high beam to automatically react to traffic ahead. <sup>[3]</sup>

## Additional lights

You can control the high beam and the direction indicators with the left-hand steering wheel stalk.

The hazard warning lights help you to warn others of potential risks. You can turn them on or off by pressing the button below the centre display.

There are additional lights that can be enabled or adjusted, such as:

- Rear fog light** The rear fog light warns traffic behind you of your presence in poor light conditions. You activate it via the button on the left-hand steering wheel stalk.
- Front fog lights** The front fog lights warn traffic of your presence in poor light conditions. You activate them via the button on the left-hand steering wheel stalk.

<sup>[1]</sup> AUTO

<sup>[2]</sup> Some exterior lights may remain on when driving based on regulations in various market regions.

<sup>[3]</sup> The rotating ring springs back to AUTO when selecting the automatic high beam.

### 9.1.1.1. Operating the driving lights

Familiarise yourself with operating the lights controls that are available via the left-hand steering wheel stalk.

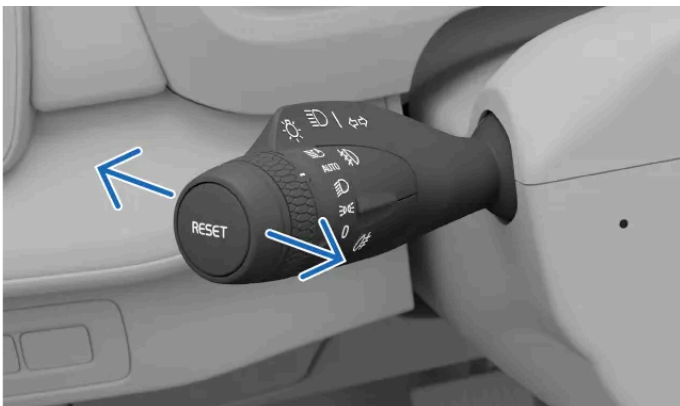

The horizontal stalk positions

You can move the left-hand stalk forwards or backwards to switch between different lighting selections.

The selections available are:

- High beam on
- High beam off
- High beam flash

#### Manual high beam

- When the automatic lights mode<sup>[1]</sup> or the manual passing beam is selected on the left-hand steering wheel stalks rotating ring, push or pull the stalk to turn the manual high beam on or off.

#### Automatic high beam

- When the automatic high beam is activated on the left-hand steering wheel stalks rotating ring, pull the stalk fully to deactivate the automatic high beam.<sup>[2]</sup>

#### High beam flash

- Pull the left-hand steering wheel stalk slightly to activate the high beam flash.

<sup>[1]</sup> AUTO

<sup>[2]</sup> The rotating ring always springs back to AUTO when selecting the automatic high beam.

---

## 9.1.1.2. High beam

The high beam is important for your driving visibility. There are different states you can use to suit your needs.

### Important

Remember that your ability to see the road properly in low lighting conditions is important not just for your own safety, but for other road users and pedestrians too.

The high beam is more powerful and has a longer reach of illumination than the passing beam. To use the high beam, you must first activate the automatic lights mode<sup>[1]</sup> or the passing beam.

You can choose between either the automatic high beam or the manual high beam.

You activate the automatic high beam by rotating the ring on the left-hand steering wheel stalk to the automatic high beam symbol . The ring always springs back to the automatic lights mode *AUTO*.

When the automatic high beam is enabled, your car automatically adapts the beam pattern to avoid dazzling other road users.

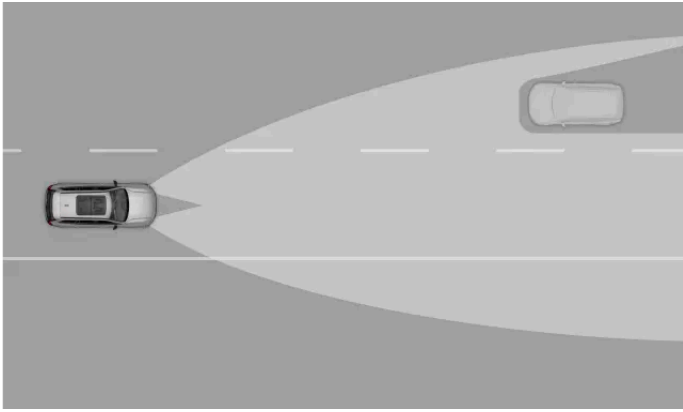

The automatic high beam's adaptive capabilities

**Note**

When enabled, the automatic high beam only activates at speeds over approximately 20 km/h (12 mph) in low light.

There are symbols in the driver display that show which high beam setting is currently active. These include:



The manual high beam is active.



The automatic high beam is enabled.



The automatic high beam is active.

**Important**

Make sure that the car cameras are well-maintained and kept clean. If the cameras' views are obscured by dirt, they will not be able to obtain enough information to properly direct the car's lighting responses.

<sup>[1]</sup> AUTO

## 9.1.1.3. Passing beam

The passing beam reduces the risk of dazzling other road users.

The passing beam is part of the automatic lights mode. However, you can manually select the passing beam to keep the front lights dipped.



Tip

### Poor lighting and dark conditions

If you have the automatic lights mode selected on the left-hand stalk's rotating ring and your car detects poor lighting or dark conditions, the car automatically switches the passing beam on. When the car detects better lighting conditions again, such as when you exit a tunnel, it automatically switches the passing beam off.

## 9.1.1.3.1. Activating the passing beam

The passing beam can be manually selected on the rotating ring on the left-hand steering wheel stalk.

Manually selecting the passing beam keeps the front lights dipped.



The passing beam symbol on the rotating ring on the left-hand stalk

1. Rotate the ring on the left-hand steering wheel stalk to the passing beam  position.

Deactivate the passing beam by selecting a different lighting mode.

## 9.1.1.3.2. Cornering lights

The cornering lights improve visibility in the immediate vicinity of the car.

When the passing beam or the automatic lights mode<sup>[1]</sup> is active, cornering lights trigger when driving at low speeds in poor

lighting or dark conditions.

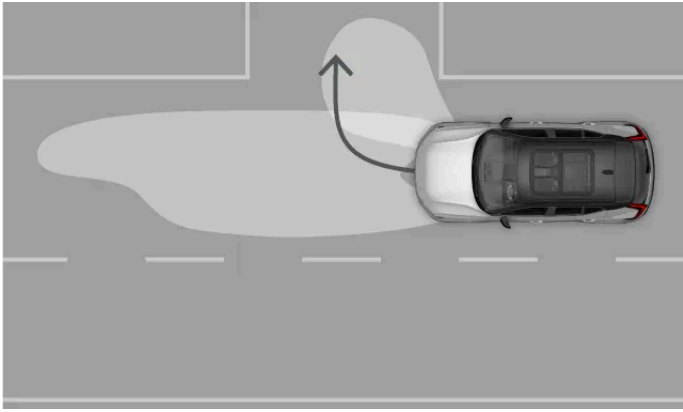

The cornering lights

The cornering lights illuminate the area close to the car to give you better visibility when turning.

**i Note**

When turning without using the indicators, only the light on the side you are turning towards will illuminate.

<sup>[1]</sup> AUTO

---

## 9.1.1.4. Activating the front fog lights

The front fog lights are designed to warn traffic of your presence in bad weather with poor light conditions.

You need to manually activate the front fog lights via the button on the left-hand steering wheel stalk.

**i Note**

The front fog lights can not be activated if the rotating ring on the left-hand stalk is in the 0 position.

1. Press the button marked with the front fog lights symbol  on the left-hand steering wheel stalk to turn it on or off.
- > The fog lights symbol appears in the driver display showing the light is active.

---

## 9.1.1.5. Activating the rear fog light

The content of this manual represents the status of the user manual at the time of printing and may not be completely valid in future instances. For more information, refer to the first page for the complete disclaimer note.

The rear fog light is designed to warn traffic behind you of your presence in bad weather with poor light conditions.

You need to manually activate the rear fog light via the button on the left-hand steering wheel stalk.

**Note**

- The rear fog light can not be activated if the rotating ring on the left-hand stalk is in the 0 position.
- When the position lights are selected, the rear fog light only activates if the front fog lights are on.

1. Press the button marked with the rear fog light symbol  on the left-hand steering wheel stalk to turn it on or off.
- > The rear fog light symbol appears in the driver display showing the light is active.

The rear fog light is switched off automatically if you move the rotating ring on the left-hand stalk to the 0 symbol.

**Note**

When you connect a trailer the rear fog light may not illuminate as the rear fog light functionality is instead transferred to the trailer. Check if the trailer is equipped with a rear fog light before activating the rear fog light to ensure safe operation.

## 9.1.1.6. Activating the position lights

The position lights help to alert other road users to the presence of your car.

The position lights are useful when you need to make other road users aware of your position, such as when you intend to leave the car stationary for a short period of time.



The position lights symbol on the rotating ring on the left-hand stalk

1. Rotate the ring on the left-hand steering wheel stalk to the position lights  position.

The position lights will remain on for a long time when your car is parked. Deactivate the position lights by selecting a different primary lighting mode.

 **Note**

Opening the boot

If you open the boot in low lighting conditions, the rear position lights automatically activate.

## 9.1.1.7. Re-orientating lights to local traffic

If you visit a region with a different driver's side to your own, you can change the orientation of the lights in settings.

When you re-orientate the lights to local traffic, the lights adjust to reduce glare and avoid dazzling other road users.

### Selecting the orientation of the lights

1. Press the car symbol  in the bottom bar and go to **Settings**.
  2. Go to **Controls** → **Lights and displays** → **Exterior lights** → **Adapt lights for right-hand traffic**.
  3. Re-orientate the lights by pressing on or off.
- > A notification appears in the driver display.

 **Important**

Until deselected, the lights remain re-orientated each time you start a new drive. Remember to deactivate it when you no longer need to change the orientation of the lights.

## 9.1.1.8. Hazard warning lights

If there is a potential risk to surrounding traffic, you should turn the hazard lights on. This helps to alert other road users of the need for greater awareness.

 **Important**

It is the driver's responsibility to use hazard lights according to local laws and traffic regulations.

The hazard warning lights button is located below the centre display.

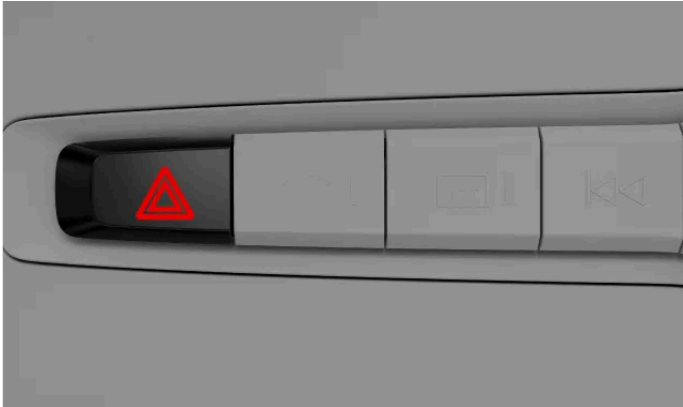

The location of the hazard warning lights button below the centre display

The status and interaction point to control the hazard lights is signified by the associated symbol.



## Automatic activation

The hazard warning lights turn on automatically when the emergency brake lights are triggered due to sudden braking. You can either turn them off again with the button, or let them turn off automatically when you begin driving again.

## In the event of a collision

Your hazard lights will automatically turn on in the event of a collision.<sup>[1]</sup>

<sup>[1]</sup> This is dependent on local regulations and regional standards.

---

## 9.1.1.8.1. Activating the hazard warning lights

The hazard warning lights are essential for driving safety. Be sure that you know how to work them.



Hazard warning lights symbol

When you get into the car, the hazard warning lights button lights up, showing that you can use it.

1. Press the hazard warning lights button below the centre display.
- > Both of the direction indicator symbols in the driver display and the hazard warning lights button flash simultaneously in the same rhythm as the lights. You will also hear a ticking sound.

---

## 9.1.2. Operating the direction indicators

Use the direction indicators to communicate how you intend to manoeuvre your car. The controls are located on the left-hand steering wheel stalk.

The indicators have two types of activation – quick and standard. While the indicators are blinking, you will hear a ticking sound and see a direction indicator symbol in the driver display.



The indicators on the left-hand stalk

### Quick indication

1. Move the left-hand steering wheel stalk slightly up or down and allow it to spring back to the middle.
- > The indicators blink three times before turning off.

### Standard indication

2. Move the left-hand steering wheel stalk up to turn the right indicator on and down to turn the left indicator on.
- > The indicators blink continuously until you straighten the steering wheel out after turning.

#### Note

You can cancel the direction indicators by moving the left-hand steering wheel stalk back to its original position.

 **Note**

### Indicator malfunction

In the event of any malfunction or damage to the direction indicators, the sound and the flashing indicator symbol will be twice as fast as normal and the malfunction symbol appears in the driver display.

---

## 9.1.3. Exterior convenience lights

There are lighting functions available that make it easier to see when you are outside and approaching your car.

### Greeting lights

Certain lights automatically activate for a short period of time when you approach and unlock your car.

### Guidance light

When you lock and leave your car, it can provide extra lighting around the exterior for a short period of time.

---

## 9.1.3.1. Greeting lights

Your car can indicate that it recognises you coming with greeting lights.

You activate the feature in the centre display.

### Greeting lights

A brief light sequence triggers when you approach and unlock your car.

---

## 9.1.3.1.1. Enabling the greeting lights

You can turn on the greeting lights sequence for when you unlock your car.

The greeting lights display a short lights sequence and give better visibility as you approach and unlock your car.

1. Press the car symbol  in the bottom bar and go to **Settings**.
2. Go to **Controls** → **Locking** → **Greeting lights**.

3. Turn the greeting lights on or off.

The greeting lights setting stays active until you disable it.

---

## 9.1.3.2. Guidance light

The guidance light helps you to see when you're outside of the car and to be seen by others. This is useful when you are parked in a dark location.

The guidance light provides extra lighting around the exterior of your car for a short period of time when you lock and leave it. You can activate the guidance light by using the left-hand steering wheel stalk.

---

### 9.1.3.2.1. Activating the guidance light

Find the activation controls for the guidance light.

 **Note**

Make sure that your car is stationary and turned off before you activate the guidance light.

1. Move the left-hand steering wheel stalk forward and release.
  - > A notification appears in the driver display to indicate that the guidance light is active. The outer lighting, such as the position lights, headlight beams and number plate lighting, turns on.
2. Get out of the car and lock the door.

The guidance light is active for about one minute.

---

## 9.2. Mirrors

The rear-view mirror and the two wing mirrors are important for your driving awareness. Make sure that you adjust the mirrors to your needs before driving.

### Rear-view mirror

You can adjust the interior rear-view mirror by moving it manually.

**i Tip**

**Use the automatic dimming feature**

Automatic dimming can reduce the glare from strong lights in the mirror. Auto dimming is triggered only when poor light conditions are detected outside the car. Be sure to have the automatic dimming feature on to avoid being dazzled.

## Wing mirrors

You can adjust and reset the wing mirrors' positions as well as fold the mirrors by using the controls in the driver door button panel.



Controls for adjusting the wing mirrors

If you want the wing mirrors to automatically fold when you lock the car, you can enable a setting for this in the locking settings via the centre display.

The wing mirrors are heated to prevent ice and frost from impeding visibility. The wing mirror heaters start automatically when you activate the rear defroster.

**! Warning**

The wing mirrors are curved to improve visibility. Objects may appear to be further away than they actually are.

### 9.2.1. Enabling automatic dimming

Bright lights can reflect in the rear-view mirror, such as from other cars' headlights. This can cause a glare effect but your car's automatic dimming counteracts this.

Enable automatic dimming to avoid being distracted by light from behind. For your comfort, make sure that you activate it before you start driving. You turn it off in the same way that you turn it on.

 **Note**

If the light sensors for the rear-view mirror are obstructed in a way that prevents light from reaching them, the automatic dimming effect will be reduced. For example, parking permits or sunshades could stop light from reaching the sensors.

1. Press the car symbol  in the bottom bar and go to **Settings**.
2. Go to **Controls** → **Mirrors and wipers** → **Auto dim rearview mirror**.
3. Turn it on or off.

---

## 9.2.2. Adjusting wing mirrors

Before you start driving, make sure that the wing mirrors are in positions that give you good visibility.

You need to turn the ignition on to be able to adjust the wing mirrors. To do this, just turn the start knob clockwise and release it.

1. Select the wing mirror you want to adjust by pressing its corresponding button on the driver door button panel.
  - Press the L button to adjust the left-hand mirror.
  - Press the R button to adjust the right-hand mirror.
- > The button lights up to indicate that you can adjust the selected wing mirror.
2. Use the control stick in the button panel to adjust the mirror's position.
3. Press the L or R button again to finish adjusting the mirror.
  - > The button's light turns off to indicate that the mirror has been adjusted.



Tip

### Manually tilting wing mirrors when in reverse gear

You can also tilt the wing mirrors when your car is in reverse gear. This can be helpful when parking so that you can see the kerb more clearly. Just press the button twice for the wing mirror you want to tilt and it will tilt downwards. The mirrors return to their original positions when you change gear.

### Automatically tilting wing mirrors when in reverse gear

Enable **Exterior mirrors tilt when reversing** in the controls settings so that the wing mirrors automatically tilt downwards when you put the car into the reverse gear. The mirrors return to their original positions when you change gear.

---

## 9.2.3. Folding wing mirrors

You can fold and unfold the wing mirrors using the buttons on the driver door button panel.

Folding the wing mirrors can be useful when you are parking or driving in narrow spaces.

1. Press and hold the L and R buttons on the driver door button panel simultaneously for a short period of time.
  - > The wing mirrors start to fold when you release the buttons.



Tip

### Unfolding the wing mirrors

Unfold the wing mirrors in the same way that you folded them. The mirrors unfold to the positions that they were in before they folded.

### Automatic folding when you lock or unlock the car

You can enable or disable automatic wing mirror folding when you lock or unlock the car. Just go to locking in the controls settings via the centre display and turn **Auto fold mirrors** on or off.

If you enable automatic folding but then fold the wing mirrors yourself and lock the car, the mirrors won't unfold automatically when you unlock the car. You need to use the driver door button panel again to unfold the mirrors.

---

## 9.2.4. Resetting wing mirrors' positions

If you fold or unfold the wing mirrors by hand, you need to reset the mirrors' positions so that the car can fold them again.

You might need to fold or unfold the wing mirrors by hand due to external factors, such as when folded mirrors are frozen in place. Moving the mirrors by hand stops the car from being able to automatically fold or unfold them. You need to reset the wing mirrors' positions by using the driver door button panel so that the car can move the mirrors again.

1. Fold the wing mirrors by pressing and holding the L and R buttons on the driver door button panel simultaneously for a short period of time.
  2. Unfold the wing mirrors by pressing and holding the L and R buttons on the driver door button panel simultaneously for a short period of time again.
- > The mirrors' positions are reset and the automatic folding works again.

If the car still can't fold the wing mirrors, try resetting their positions again.

---

## 9.3. Wipers and washers

The wipers and washers work together to keep the windscreens clean and clear.

### Important

Before activating the wipers, ensure that the wiper blades are not frozen in place and that any snow or ice on the windscreen is removed.

### Wiper and washer controls



You control the wipers and washers using the right-hand steering wheel stalk.

### Rain sensor

If your car detects water on the front windscreen when the rain sensor is active, the wipers will start automatically.

You can press the rain sensor button on the stalk to activate the sensor and turn the scroll wheel to adjust its sensitivity. The rain sensor will stay active until you press the button again or select another wiper mode. When the rain sensor is active, you can see a symbol in the driver display.



Active rain sensor symbol

## Washers

The washer nozzles are integrated into the wiper arms for efficient washer fluid distribution. The nozzles are automatically heated in cold conditions to prevent the washer fluid from freezing.

Your car tells you when it's time to refill the washer fluid. When washer fluid is running low, a message appears in the centre display.

### ! Important

#### Maintenance, refilling and replacing

- Clean the wiper blades regularly.
- Replace the wiper blades if they show signs of wear.
- Refill washer fluid when your car tells you to.
- Avoid using the wipers without lubrication from either rain or washer fluid. It can cause wear or damage.

#### Car wash safety

Turn the rain sensor off when you enter a car wash. Otherwise, the rain sensor will cause the wipers to activate, which could lead to damage.

## 9.3.1. Controlling front wipers

You can manually activate the windscreen wipers or change the way they work.



Front wiper controls are on the right-hand steering wheel stalk.

There are different front wiper modes that you can activate by using the right-hand stalk. The modes are:

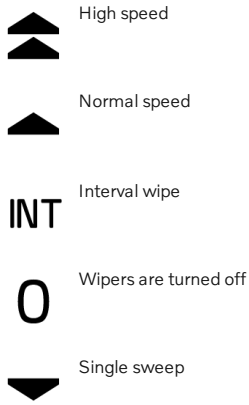

#### Single sweep

- Press the stalk downwards and release.

#### Selecting wiper mode

- Press the stalk upwards or downwards.

#### Activating rain sensor

- Select mode 0 and press the rain sensor button .

#### Adjusting rain sensor sensitivity or interval wipe frequency

- Rotate the scroll wheel at the end of the stalk.

---

## 9.3.2. Controlling rear wiper

The rear wiper can be manually turned on and off.

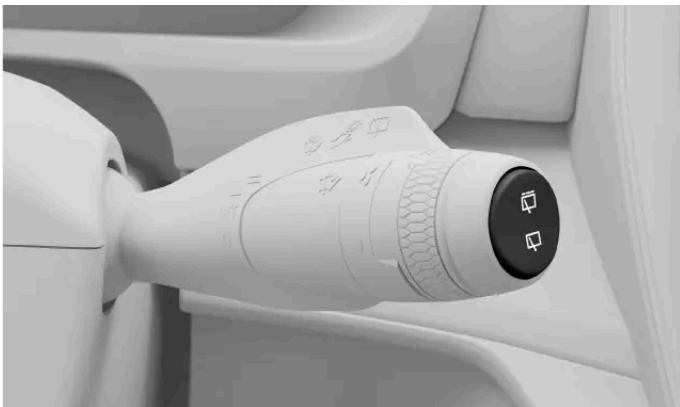

Rear wiper controls are on the right-hand steering wheel stalk.

The rear wiper modes are:

**The content of this manual represents the status of the user manual at the time of printing and may not be completely valid in future instances. For more information, refer to the first page for the complete disclaimer note.**

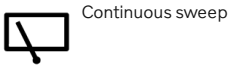
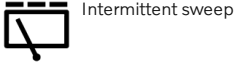

#### Activating the rear wiper and washer

- Push the stalk forwards.
- > The rear wiper and washer activate.

#### Selecting the rear wiper mode

- Press either the intermittent sweep or continuous sweep button on the end of the stalk to select the rear wiper mode.

#### Note

##### Automatic rear wiper while reversing

The rear wiper automatically activates if the front windscreen wipers are active while you are reversing. If you change gear, the rear wiper will stop wiping the rear windscreen.

In low temperatures, the rear wiper won't automatically activate while you are reversing to prevent damage to the wiper arm.

## 9.3.3. Activating washers

Activate the windscreen washers with the right-hand steering wheel stalk.



Right-hand steering wheel stalk

#### Front washers

- Pull the stalk towards you and hold it there for a few seconds.

The content of this manual represents the status of the user manual at the time of printing and may not be completely valid in future instances. For more information, refer to the first page for the complete disclaimer note.

- > The front windscreen washers activate. If the headlights' high beam or passing beam is active, the headlights are also washed.

#### Rear washer

- Push the stalk away from you and hold it there for a few seconds.
- > The rear windscreen washer activates.

When you let go of the right-hand stalk, the wipers make a few passes to wipe away excess fluid.

#### Note

##### Low washer fluid and washing headlights

If the washer fluid level is low, the headlights won't be washed. This is to prioritise the windscreen washers to keep the windscreen clean and clear.

## 10. Driver support and navigation

Driver support features are designed to improve safety, comfort and convenience when you are using your car. They assist you with your driving, route-planning and decision-making on the road.



The collection of driver support features in this car can assist you in driving, navigating and parking. Some are exclusively designed to improve safety, others convenience. Some features are designed with both purposes in mind.

When used correctly, driver support features can reduce the effort of driving, help reduce distractions and improve safety for you and others. They often take advantage of the car's ability to monitor and keep track of its surroundings. Some features deliver that information to you for increased driver awareness, while other features provide fast reactions to hazards identified by the car.

---

### 10.1. Navigation

Use the Google Maps navigation app to get directions and traffic information as well as find the nearest service station.

When the car is connected to the internet, it can continuously download map and traffic information to help you navigate to a destination. Navigation guidance can appear in the car's displays.

The car knows its location through GPS and shows it in the map views in the car's displays.

# Navigation app



Google Maps symbol

## Note

### Latest app version

Be sure to update the app whenever there's a new version available. Functionality and support for old versions may vary.

## Tip

### Changing map size

You can make the navigation map in the centre display's home view bigger by pressing the home button — underneath the bottom bar. To make the map go back to its original size, just press the home button again.

## Connected navigation features

Whenever your car is connected to the internet, it can get the latest navigation information.

<b>Real-time traffic information</b>	You can get real-time traffic information if the car is connected to the internet. For example, you can see if traffic is moving slowly. Different coloured lines that correspond to traffic situations will appear on your chosen map route. If the internet connection is lost, the lines disappear after a while. You also get information about traffic conditions along the chosen route, such as roadworks or accidents.
<b>Alternative routes and redirected traffic</b>	When you set a destination in the navigation app, the fastest route is suggested while also taking your navigation settings into account. For example, you can choose to avoid tolls or ferries. The chosen route can be redirected while you are driving, such as when there is an accident or a traffic condition that affects your travelling time.
<b>Sharing information with other devices</b>	Link your Google account to an active user profile to get the same Google Maps information in your car as on your other devices. Destinations saved to your Google account using other devices, such as home, work, favourites and last searches, are then also available in your car.

## Offline maps

When you are connected to the internet, Google Maps automatically downloads map data based on your current position so that it is available even if your car has poor reception or no internet connection. You can also choose to select and download a map area yourself. This feature is available in Google Maps' settings.

## Displayed information

When a route is added, the following travel information about the trip is shown in the centre display:

- Travel time
- Distance to the next destination on your route, such as an extra stop
- Estimated time of arrival
- The name of the next destination on your route

Depending on the selected display mode, the driver display shows different amounts of map and guidance information.

## Navigation settings

You can change the navigation settings in the navigation app.

### **Warning**

#### Avoid driver distraction

Avoid any interaction with the car's system or other devices that may distract you from driving safely. Any task that does not allow you to keep your attention on the road and surrounding traffic should be performed when the car is parked.

### **Note**

#### Navigation limitations

- The navigation feature is from a third-party supplier. Availability, procedure and functionality may vary over time and depend on region.
- Navigation instructions can sometimes be less reliable than usual due to factors such as weather or road conditions.

#### Poor or no internet connection

The navigation app can have trouble finding a route or signal when you are in a location which can interfere with your internet connection, such as a tunnel or multi-storey car park.

---

## 10.1.1. Finding and selecting a navigation destination

Find your destination using the search field or a voice command. The car then suggests routes for you to choose from.

1. Press the app library symbol  in the bottom bar and open Google Maps.
2. Enter an address or destination in the search field.
  - > A route is suggested along with alternative routes.
3. Select your preferred route.
4. Select start.
  - > Navigation instructions start.

## 10.2. Detection of surroundings and traffic

This section covers the essentials of how cameras, radars and other sensors work, including their limitations. Understanding how your car perceives its surroundings can help you use features that rely on this capability.

Your car's ability to understand its surroundings is achieved through many systems and types of sensors. The car's interpretation of the data it collects helps inform its behaviour, especially for driver support features.

<b>Cameras</b>	Cameras work similarly to the human eye. What they capture is used for different purposes, which depends on the camera. For example, the upper front-facing camera helps the car identify things such as traffic signs and road markings, whereas what the rear parking camera captures appears in the centre display.
<b>Radars</b>	Radars use radio waves to collect information about the car's surroundings. They can identify the distance to objects and certain aspects of their movement. This information is essential for many features in the car.
<b>Parking sensors</b>	These sensors use sound waves to detect relatively close objects. They work by sending out ultrasound pulses that can bounce back to the sensors when they encounter an object.

### How systems work together

The different detection types complement each other. They are sometimes used on their own and sometimes together.

#### Important

Even when used together, these detection systems cannot handle all conditions and traffic situations. This is why it's important for the driver to never rely fully on driver support features. Always be attentive to conditions and situations where driver support feature performance is affected by the features' limitations.

### General detection and identification limitations

Each type of detection has its own set of limitations, but there are a few general things to consider as well.

- The car can't always handle unpredictable or strange situations. When the car finds it difficult to correctly identify the environment or traffic situation, the accuracy of its response is affected.
- Damage to the car can affect detection and features that use it. Many faults can be identified by the car, but some may not be possible to self-identify. This is why it's important to make sure that the car is in good condition and working order. Contact an authorised Volvo workshop if you suspect there is any fault or if you notice damage to the car.
- Limiting factors and conditions can, and frequently do, coincide. They can compound and interact in ways that amount to an incorrect response from the car.

### Obstacle detection limitations

Obstacle detection helps the car identify certain stationary and moving objects. They can be other road users, such as pedestrians or other vehicles, animals, barriers or other objects. If they are in or close to the car's driving path, they could pose a collision risk. Depending on the circumstances, the car might be able to warn or intervene if the object is accurately identified. For all types of objects the car can identify, there are many factors that can prevent accurate identification. Examples of limiting factors, situations and events include:

- Closely spaced, overlapping or partially blocked objects and road users.
- Objects and road users that blend in with the background.
- Objects and road users that move or accelerate particularly fast.

- Uncommon vehicles, such as recumbent bicycles, combine harvesters or trailers with oddly shaped loads.
- Bicycles of a different type or size compared to a regular adult bicycle.
- New modes of transportation.
- Clothing or carried objects that alter the silhouette of a pedestrian.
- Pedestrians shorter than 80 cm (32 inches).
- Obstacles angled in ways that create an unknown silhouette.
- Size and speed of animals. Cats and dogs are often too small to reliably identify.

**Note**

**Traffic detection examples**

Examples of different traffic scenarios can help you understand some of the limitations of your car's detection systems. Real-world scenarios are often more complex than the illustrative<sup>[1]</sup> examples in this manual.

## Out of view and late detection

The various detection zones around your car are static, each with a limited range and field of view. If something enters a detection zone at an unusual angle, at high speed or very close to your car, it can cause a rapid response. This reduces safety margins compared to a situation in which earlier detection was possible.

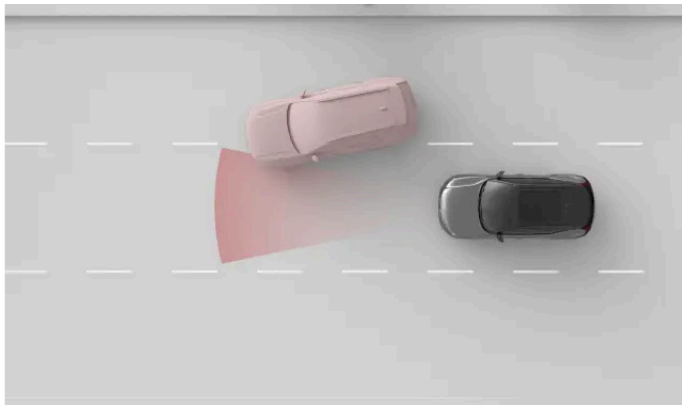

The front radar's detection zone has a limited width. If you get cut off by another vehicle, detection can occur relatively late causing a sudden response by your car.

**Important**

**Lane placement and small vehicles**

For forward detection, the middle of the lane is more favourable compared to its outer parts. Vehicles can go undetected if they don't occupy the middle of the lane. While this can happen for any vehicle, the risk is higher for small ones, such as motorcycles. They take up less of the lane's width and can move about more within the lane. Always pay extra attention to any vehicle not driving in the middle of the lane.

## Shape, size and number of objects

Detection can be less reliable depending on the shape, size and number of objects in a detection zone. Identifying the distance to the closest vehicle ahead can become less accurate depending on these factors, especially if they are compounded.

**The content of this manual represents the status of the user manual at the time of printing and may not be completely valid in future instances. For more information, refer to the first page for the complete disclaimer note.**

- Small objects are harder to identify.
- The more objects, the harder it is to identify individual ones.
- Objects close together that overlap are harder to identify.
- Objects with non-uniform shapes, such as having overhangs or parts that stick out, are harder to identify.

The presence of a large vehicle in front can make it difficult to identify a smaller one, such as a motorcycle.

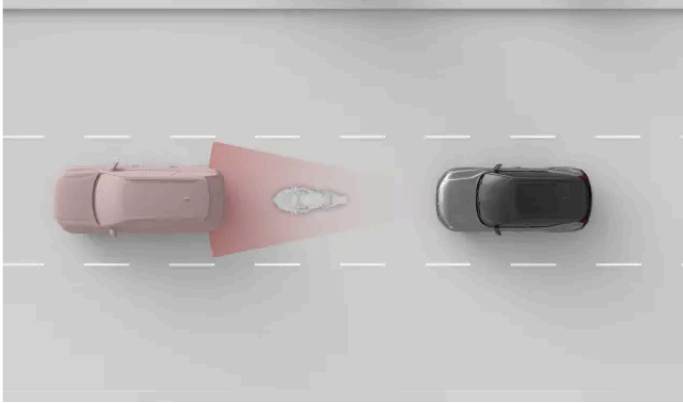

The smaller motorcycle and the car are close to each other and overlap, making detection of the motorcycle less accurate.

**!** Important

**Trailer in front**

Compared to many other vehicles on the road, the detection of trailers is often less reliable due to their shape and height. This applies, in particular, to slim trailers, low trailers and trailers with very high loading beds. These types of trailers often don't have enough surface area at the height where forward detection systems focus.

**Road and infrastructure**

Bends in the road can cause the car to misinterpret the traffic situation. For example, it can lose track of a vehicle or misidentify which lane a vehicle ahead is in.

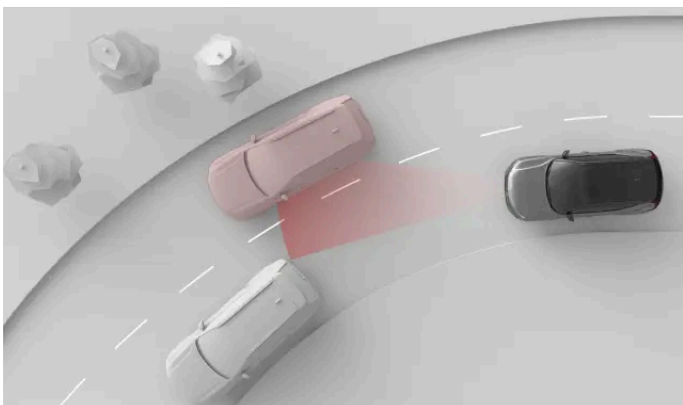

In a bend, the car ahead may slip out of the detection zone. Cars in the adjacent lane may also enter the zone, affecting your car's perception of the distance to traffic ahead.

 **Important**

### Road condition and irregularities

Both common and uncommon road features can impact the effectiveness of the car's detection systems.

- Sharp bends and bumps in the road can temporarily obscure important parts of the car's surroundings, such as other vehicles or road markings.
- Non-standard or unusual road infrastructure might not be correctly identified by the car. For example, road work or traffic diversions can result in conflicting or multiple sets of road markings.
- Worn road markings or signs might not be correctly identified.

<sup>[1]</sup> The representations of detection systems and the car's surroundings are not to scale.

---

## 10.2.1. Locations of cameras, sensors and radars

Knowing the placement of different components the car uses to map its surroundings helps you keep them free of dirt, obstructions and accidental damage.

Many of your car's driver support features rely on data from components that scan and map your car's surroundings, such as cameras, sensors and radars. This section doesn't show all components and their precise locations, but it gives you a general idea of where they are. Areas pointed out in this section are particularly important to keep clean. Damage to these areas can also affect functions that rely on components located there.

 **Warning**

### Clean regularly

Camera, sensor and radar locations on the car must be cleaned on a regular basis and kept free from labels, objects, dirt and other potential obstructions. Otherwise, car functions may respond incorrectly or become less responsive or deactivated.

### Scraping the windscreen

The windscreen area in front of the front-facing camera has its own heating to defrost and remove any build-up of snow or ice. Do not use an ice scraper on this area as it can scratch the glass surface. Scratches or damage to the glass can interfere with or limit the camera's detection capabilities.

### Mounted accessories

Be mindful of the effects of mounted car accessories such as load carriers or exterior light accessories. The items themselves or the load you add may obstruct cameras, sensors or radars.



- ① The top-centre of the windscreen houses a front-facing camera.
- ② The side-view parking assist cameras are located on the wing mirrors.
- ③ There is a front-facing radar and a parking assist camera in the emblem area in the front of the car.



- ① There is a parking assist camera in the rear centre of the car.
- ② The rear of the car also has a radar in each corner.



Tip

### Finding the parking sensors

There are multiple parking sensors along the lower edge of your car. You can see their exact locations by looking for their button-like cover plates along the bumper panel.



Important

### Cleaning in front of radars

If you find dirt, snow or ice, or if the car indicates that a radar is blocked, you should address it as soon as possible. Always clean and clear a large area around the radars to make their full field of view available.

---

## 10.2.2. Camera detection and limitations

The car's cameras capture the surroundings in a similar way to the human eye. This comparison is useful for understanding their capabilities and limitations.

Cameras help the car identify certain objects and surfaces that visually stand out against their backgrounds. This includes things such as road markings, traffic signs, pedestrians and other vehicles.

Camera information in the parking view can provide you with an additional way to monitor the car's surroundings.

### Light conditions

Cameras need light to work and are affected by light conditions.

- Strong light sources, such as the sun, can cause glare and reflections that negatively affect camera detection.
- Low light can negatively affect certain types of camera detection.
- Some detection types require low-light conditions. When it's dark, the lights from other vehicles can be identified as they stand out against the background.



Important

### Camera detection in darkness

For the car to be able to identify other vehicles when it is dark, the other vehicles must have their headlights and rear lights turned on and be clearly visible. While the car uses other types of detection as well, such as radar, it may not have enough information to reliably identify vehicles that are not seen by the cameras. Several driver support features can be affected by this, such as safety interventions, collision warnings and features that provide distance-keeping.

### Visibility

Poor visibility for the driver typically means poor visibility for the cameras. Objects that are hard to detect for the human eye can sometimes be hard to detect for the cameras as well. This can include well-camouflaged objects or objects where the outlines

**The content of this manual represents the status of the user manual at the time of printing and may not be completely valid in future instances. For more information, refer to the first page for the complete disclaimer note.**

don't stand out against the background.

- Fog, heavy rain, snow or dust storms can severely limit visibility for the cameras.
- Beware of dust, water or snow on the ground that may be disturbed and kicked up into the air by your car, other traffic or the wind.

## Field of view and obstructions

Cameras see in the direction they're facing and only within their field of view. The field of view differs for each camera and depends on their intended purpose.

Obstructions limit what the camera sees. Each camera views the surroundings from where it's mounted, and anything that enters its field of view blocks what's behind the obstruction. Objects close to a camera will block more of the camera's field of view than objects that are further away. If the car detects that a camera is blocked, it can disable certain features that rely on that camera.

- Make sure that any mounted accessories, extra equipment or externally-stowed cargo don't block part of the cameras' fields of view. For example, far-extending roof loads may block part of the top view for front- and rear-facing cameras.
- Trailers, bike racks or other towbar-mounted equipment can block the rear camera view.
- Dirt, ice, snow, water droplets and condensation on camera lenses obstruct the cameras' view to some extent. In some cases, the car may be able to identify that something is in the way and notify you. However, it is still recommended to regularly inspect the cameras and make sure that they are clean and unobstructed.

### Warning

#### Clean regularly

Camera, sensor and radar locations on the car must be cleaned on a regular basis and kept free from labels, objects, dirt and other potential obstructions. Otherwise, car functions may respond incorrectly or become less responsive or deactivated.

## Other limitations

If the cameras become too hot, they can be temporarily switched off to protect them from damage. This can happen when starting the car after being parked in high temperatures in combination with direct sunlight hitting a camera. The camera can become available again once it has sufficiently cooled down.

### Important

#### Windscreen damage

Windscreen damage in the camera area, including small chips, scratches or cracks, can negatively affect performance of the camera and features that use it. This can cause reduced functionality, unreliable responses from the car and disabling of features. If damage occurs, follow this manual's separate recommendations for handling windscreen damage.

## 10.2.3. Radar detection and limitations

Radars use radio waves to collect information about the car's surroundings. They can identify the distance to objects and certain aspects of their movement. It's important not to block the radars.

There are several radars aimed in different directions to collect information about the car's surroundings. This information is primarily used by driver support features in the car. Radio waves are continuously sent out and bounce back if they encounter an object in their path. As the waves return, the car can calculate the position and motion of the object, for example.

Radars are unaffected by the light conditions, working equally well on a sunny day as in complete darkness.

 **Important**

### Use responsibly

Radars and features that rely on them are supplements to safe driving practices. They do not reduce or replace the need for the driver to stay attentive and focused on driving safely.

## Detection zone and field of view

Each radar in the car has its own detection zone. The zone is limited by the radar's field of view and range.

Objects in the field of view block what's behind them. The closer something is to the radar, the more it blocks the radar's field of view.

- If a radar is blocked, certain features may become less effective or respond incorrectly.
- If the car detects that a radar is blocked, it may disable certain features.
- Do not place or mount anything in front of or close to the car's radars. This includes stickers, car body foil and adhesive tape.
- Paintwork damage in front of a radar can affect its performance. Contact a service point for repairs if there is any damage close to the radars.<sup>[1]</sup>
- Make sure that any mounted accessories, extra equipment or externally-stowed cargo don't block the car's radars.
- Trailers, bike racks or other towbar-mounted equipment can block the radar, making it and certain features unavailable.
- Radars are sensitive to buildups of dirt, ice or snow in front of them. This affects the radio waves and can reduce the radar's ability to detect objects. Radar obstruction cannot always be identified by the car. In situations where it is detected, the car communicates this via notifications in the displays. However, it is still recommended to regularly inspect the radars and make sure the areas around them are clean and free of obstructions.

 **Warning**

### Clean regularly

Camera, sensor and radar locations on the car must be cleaned on a regular basis and kept free from labels, objects, dirt and other kinds of potential obstructions. Otherwise, car functions may respond incorrectly or become less responsive or deactivated.

## Other conditions and limitations

Other radar sources can cause interference and reduce the effectiveness of your car's radars.

[1] Volvo recommends an authorised Volvo workshop for all servicing and repairs.

## 10.2.4. Parking sensor detection and limitations

The parking sensors allow the car to detect objects and their distance from the car. They operate at relatively close range during slow and tight manoeuvring, such as when parking.

The parking sensors use sound waves to detect obstacles close to the car. They work by sending out ultrasound pulses that can bounce back to the sensor when they encounter an object or barrier. This allows the car to identify the distance to obstacles in the direction of detection.

Information from these sensors is only available at low speeds. They provide distance information when the parking view is shown in the display.

### Important

#### Use responsibly

Parking sensors and features that rely on them are supplements to safe driving practices. They do not reduce or replace the need for the driver to stay aware of the car's surroundings and focused on driving safely.

## Detection range

The parking sensors are typically located relatively low down on the bumper.

- Obstacles whose supports are outside of the detection zone can go undetected. Such obstacles include objects that are suspended from above or objects that extend far away from their ground support, such as certain barriers and gates.

## Blocked sensors

The parking sensors can get blocked, either reducing distance and obstacle detection or making it unavailable. To avoid blocked sensors or better understand when they may be unavailable, consider the following:

- If a sensor is blocked, certain features may become less effective or respond incorrectly.
- Heavy rain or snowfall can lead to unreliable detection and features relying on the parking sensors becoming unavailable.
- If the car detects that a sensor is blocked, it may disable certain features.
- Do not place or mount anything in front of or close to the car's sensors. This includes stickers, car body foil and adhesive tape.
- Bodywork damage where the sensors are located can affect their performance. Contact a service point for repairs if there is any damage in the sensor areas. [1]
- Make sure that any mounted accessories, extra equipment or externally-stowed cargo don't block the sensors.
- Trailers, bike racks or other towbar-mounted equipment can block sensors, making detection and certain features unavailable.
- Parking sensors are sensitive to buildup of dirt, ice or snow in front of them. This can reduce their ability to detect objects. Parking sensor obstruction cannot always be identified by the car. In situations where it is detected, the car communicates

**The content of this manual represents the status of the user manual at the time of printing and may not be completely valid in future instances. For more information, refer to the first page for the complete disclaimer note.**

this via notifications in the display. However, it is still recommended to regularly inspect the sensor locations and make sure the areas around them are clean and free of obstructions.

 **Warning**

### Clean regularly

Camera, sensor and radar locations on the car must be cleaned on a regular basis and kept free from labels, objects, dirt and other kinds of potential obstructions. Otherwise, car functions may respond incorrectly or become less responsive or deactivated.

<sup>[1]</sup> Volvo recommends an authorised Volvo workshop for all servicing and repairs.

---

## 10.3. Driver behaviour detection

Certain aspects of the driver's behaviour are continuously monitored by the car. This is important for several driver support features.

Driver behaviour detection is used to verify that specific conditions are met when driving and using certain features. A camera located in the rear-view mirror continuously tracks the driver's behaviour without recording it. The information from this system is used by several driver support features.

Several aspects of the driver's behaviour are monitored, including:

- Head and body posture
- Eye movement and focus
- Signs of tiredness or fatigue

An important part of the monitoring system is checking that the driver's hands are on the steering wheel when driving.

 **Note**

### System for understanding the driver

In addition to tracking the driver's attention, the car monitors some other parts of driving. This includes keeping the doors closed and seatbelts buckled while driving. The individual detection points are combined to form a better understanding of the driver's focus, attention and behaviour.

Information from the behaviour detection system is combined to identify whether the driver's attention is focused on driving. This includes keeping track of traffic and surroundings, as well as being attentive and alert. The detection system can give you notifications in the driver display.

## Reliant features and functions

The driver behaviour detection system keeps track of the driver's behaviour to decide if the car is being handled safely. If the system is blocked, or detects driver misuse, it can trigger a response from several other features or functions of the car.

Features that are affected by the driver behaviour detection system include:

<b>Driver and distraction alert notifications</b>	You car can notify you if you seem tired, distracted or unfocused.
<b>Emergency stop assist</b>	In situations where the driver is unable to continue driving, the car can perform a controlled stop to reduce the risk of a collision.
<b>Pilot Assist</b>	Pilot Assist's steering assistance can be deactivated if you seem unfocused or don't respond to requests to keep your hands on the steering wheel.

## Conditions and limitations

The driver behaviour detection system relies on camera detection and tracking. While the system is advanced, cameras have limitations connected to visibility that can affect the system's detection capabilities. Read the separate section about the conditions and limitations of your car's cameras to understand how features relying on camera detection are affected.

- Attention tracking requires an unobscured view of the driver's face.
  - Improperly stowed items can obscure the view of the driver, as can dust and dirt on the camera lens. Keep the driver's space clean and clutter-free.
  - Wearing certain clothing and accessories can obstruct parts of the driver's face that need to be visible for attention tracking, such as the eyes.
- Dirt in front of the camera can negatively affect its detection capabilities.
- Certain conditions can affect how well your car can assess your driving and manoeuvring. This in turn affects how well it can distinguish signs of an unfocused or tired driver.
  - Features that help with lane placement can sometimes compensate for manoeuvring that would otherwise indicate a lack of driver focus. This makes it harder to identify signs of lacking focus compared to unassisted driving.
  - Conditions such as strong winds or uneven road surfaces can affect your driving in ways similar to that of an unfocused driver. This can potentially cause warnings despite having a fully focused driver behind the wheel.

### Important

#### Affecting the system

Do not cover the camera. The camera can be fully or partially obscured by objects hung or placed on the rear-view mirror. If the camera is obscured or covered, your car can notify you with a message in the driver display.

Do not intentionally try to trick the driver behaviour detection system. The system is there to keep driving as safe as possible. By limiting the system's ability to detect a dangerous situation, you also limit its ability to perform a safety intervention.

## 10.4. Safety interventions and warnings

Your car has features that directly or indirectly help prevent collisions. If your car detects a dangerous traffic situation, it can intervene by warning the driver or performing an evasive driving manoeuvre.

Safe driving begins with good user practices. As an additional level of protection against incidents, your car can warn you if it detects a situation that requires your immediate attention or action. In addition to making the driver aware through warnings,

**The content of this manual represents the status of the user manual at the time of printing and may not be completely valid in future instances. For more information, refer to the first page for the complete disclaimer note.**

the car can intervene by steering or braking to avoid or mitigate a collision.

Features that are designed to provide warnings or perform interventions in different ways include:

- Collision warnings and mitigation
- Lane keeping aid
- Blind spot information
- Driver focus and alertness notifications<sup>[1]</sup>
- Alerts about traffic crossing behind the car when reversing<sup>[2]</sup>
- Automatic braking when reversing<sup>[3]</sup>
- Connected safety



Tip

### What are safety interventions?

Safety interventions are responses from the car in situations in which it identifies a high or imminent risk of collision. Warnings can be provided to alert the driver to hazards so that they can take action, but the car is also capable of performing emergency steering or braking manoeuvres depending on the situation. Some types of warnings and interventions are always enabled while others are part of features that you may be able to customise or choose to turn on or off.

## Safety interventions to avoid collisions

When the car identifies a risk of collision, it reacts according to the level of urgency. It can identify objects such as pedestrians, cyclists and vehicles that are approaching or are in your driving path. Many factors can affect how early and effectively the car can detect the risk of an incident. There are situations that are beyond the car's capabilities, which is why safe driving practices are essential.

If the car identifies an increasing risk of collision, alerts can quickly escalate to evasive manoeuvres by the car. If a threat appears suddenly, the car can immediately perform evasive manoeuvres.

<b>Collision warnings</b>	When the car identifies that there's a risk of collision, the first step is to get the driver's attention. The car can warn you visually, with sound or with brake pulses.
<b>Braking manoeuvres</b>	If the car determines that immediate action is required, it can brake independently of the driver's actions. This can occur at the same time as a steering manoeuvre. The amount the car brakes when intervening depends on the situation. An obstacle that suddenly appears just in front of the car may cause the brakes to be fully applied, whereas another situation might require less braking to avoid a potential collision.
<b>Steering manoeuvres</b>	If the car determines that immediate action is required, it can steer independently of the driver's actions. This can occur at the same time as a braking manoeuvre.

Messages about performed safety interventions are shown in the driver display.

 **Note**

### Overriding steering and braking interventions

- Steering interventions by the car can always be overridden with intentional steering by the driver.
- To override a braking intervention, you must firmly press down on the accelerator pedal. Past a certain threshold, you override the braking action.

### Knowing your car's capabilities

Safety interventions by the car can occur suddenly and catch you by surprise. They can cause discomfort despite the benefit they provide. Knowledge about your car is a good way to make safety interventions feel less unsettling when they occur. Be sure to read any notifications following an intervention to better understand why the car intervened.

### Reducing the amount of interventions and warnings

The amount of safety interventions and warnings you experience depends on the driving conditions and your driving style. Certain combinations of factors might result in responses you perceive to be unnecessary or too sensitive. In general, the most effective way of reducing the amount of warnings and interventions is to drive responsibly. Adapt your speed to the driving conditions and keep a safe distance to other vehicles. You can also adjust or turn off certain features in settings.

## Balancing the response need

When the car suggests, guides or performs a driving action, it is considered a response. Most driver support features have some set of possible responses. For instance, automatic braking to prevent a collision with a car that suddenly brakes in front of you is a response. Features that can provide you with warnings and safety interventions are designed to limit unnecessary responses.

Your car's responses each have their own set of conditions. These conditions can be related to the traffic situation, the state of the car and driver, and information collected using the car's detection systems. For a response to occur, all of the required conditions need to be met and the car must have a high certainty that the response is needed. As a situation develops, the car continuously evaluates the conditions and response need. If the response need or conditions are uncertain, then the car won't respond.

If a potentially hazardous situation can be easily addressed by the driver, that is preferred over a response by the car. The car can delay or avoid providing a response in situations where you have the opportunity to address it using non-emergency manoeuvring. This helps reduce unnecessary warnings and safety interventions. Most potential hazards identified by the car are addressed by the driver through minor adjustments well ahead of the need for emergency evasive manoeuvring. In most instances, you perceive them as routine actions that are part of normal driving.

 **Important**

### Always address driving hazards

The car can and will compensate for some, but not all, instances where you are unable to or fail to respond to a driving hazard. There are situations in which an effective response is beyond the capabilities of the car, and situations in which a response is not provided because the driver is expected to address the potential hazard. When driving, you are required to stay alert and attentive so that you can respond to hazards the same way you would driving a car without driver support features.

## Conditions and limitations

### Warning

Never rely on safety interventions by the car to be a replacement for safe driving practices. Drive the car with the same attention to safety as required by a car without these features.

Warnings and interventions cannot be guaranteed in any situation. The car cannot handle all driving, traffic, weather and road conditions. Failure of the car to detect or respond to a hazard can happen for reasons that you may not be able to identify or predict.

The car's ability to respond to hazards varies depending on many factors. They often fall into any of the following categories:

- Your car's speed and movement.
- Size, shape, speed and movement of objects or road users around the car.
- Environmental conditions.
- The condition of the driving infrastructure.
- The complexity of the traffic situation.

Notable examples include:

- Sharp turns can cause detection to become less consistent. The car might be unable to identify hazards that appear suddenly as a result of turning sharply.
- Low traction, such as when the road is wet or icy, can reduce the effectiveness of interventions.
- Conditions and limitations affecting obstacle detection can prevent the car from accurately identifying potential hazards. Obstacle detection limitations are described in detail in the separate manual section about how surroundings and traffic is detected by the car.
- The car won't perform automatic braking interventions if you are driving forwards at or below walking pace. This is to avoid unwanted braking interventions when you are manoeuvring in tight spaces.



## Important

### General limitations

You have good reason to feel safe in a car capable of intervening in dangerous situations, but it's important to still do your best to drive safely and responsibly. The capabilities of the car are always limited by technological factors and constraints, the car's condition and the driving environment.

### Detection capabilities

The car's ability to monitor its surroundings is used by features that can provide warnings and interventions. To better understand the limitations of such features, read the separate section about detection of traffic and surroundings. It provides an overview of how important components work, such as cameras and radars, detailing both capabilities and limitations.

### Reaction times

In favourable conditions, the car can perceive and react to certain hazards, in some cases faster than a human driver can. However, this capability is not a guarantee of intervention as the car cannot detect all potential hazards that may require a response.

### Availability of responses

All of the car's response types have their own set of conditions that define when they are available. This means that available responses constantly change as you drive. Certain conditions are strictly defined, such as an exact speed range, a setting being enabled or the driver wearing their seatbelt. Other conditions have more imprecise thresholds that can depend on a combination of factors. This has the effect that you cannot with certainty know if or how the car will respond in a given situation, but you can develop a sense of what responses are likely or not.

### Read everything about the features you use

You are recommended to read all information about driver support features before using them. It's essential to understand both their capabilities and limitations.

### Wear your seatbelt

Emergency braking interventions can occur even if the driver is not wearing their seatbelt. The risk of injury from hard braking rises significantly for unrestrained occupants. Always wear your seatbelt and make sure that any passengers also wear theirs.

### Driver responsibility

Features that provide interventions and warnings are supplements to safe driving practices. They do not reduce or replace the need for the driver to stay attentive and focused on driving safely. The section covering driver responsibility is essential reading to understand the limitations of safety interventions and warnings. If you find anything unclear or have further questions, do not hesitate to contact your Volvo dealer.

[1] Driver Alert

[2] Cross Traffic Alert

[3] Rear Auto Brake

## 10.4.1. Collision warnings and mitigation

Your car has warning features designed to reduce the risk of a collision. If a collision cannot be avoided, early warning and response can help reduce its effects.

Collision warning features include:

- Forward collision warnings
- Warnings about vehicles cutting across your lane
- Rear collision warnings

### Note

#### Safety interventions

If an urgent enough collision risk is identified, the car can intervene to avoid or mitigate the collision without any preceding collision warnings. The warnings will then instead be shown simultaneously to the intervention.

### Warning

Never rely on collision warnings or safety interventions by the car to be a replacement for safe driving practices. Drive the car with the same attention to safety as required by a car without these features.

### Forward collision warnings

Forward collision warnings can occur if you are getting too close to a vehicle in front of you. The car warns you if it identifies a collision risk that requires your immediate attention.

The situation and level of urgency affect how forward collision warnings are communicated. Warnings can be communicated visually in the driver display, with sound and brake pulses.

### Warnings about vehicles cutting across your lane

Your car can warn you if you are about to be cut off, such as when a vehicle changes lanes just in front of you. Vehicles that swerve or move unpredictably in adjacent lanes can trigger these warnings as well. Your car uses messages in the driver display to warn you in these situations.

### Rear collision warnings

If your car identifies a situation with a high risk of a rear collision, it can flash its rear lights to warn drivers behind you. Rear collision warnings appear automatically if you slow down suddenly<sup>[1]</sup>, such as during very hard braking. Warnings can also be provided if your car detects a vehicle rapidly approaching from behind. In this case, you do not need to be slowing down for a warning to appear. They can appear both when you're driving and when stopped, but only if your car detects a high enough risk of collision.

When you are in situations that cause rear collision warnings, your car can pretension your belt as a safety measure. If your car is at a standstill, it also applies hard braking as a precaution in case there is an unavoidable rear collision.

**Note**

### Collision response

If a collision cannot be avoided, the car can respond in other ways to protect occupants and reduce the danger to surrounding traffic. Read more about these features in the safety section of this manual.

[1] The rate of deceleration must exceed a certain threshold.

## 10.4.2. Interventions and warnings when reversing

Your car has specialised features that can intervene and help prevent collisions when you are reversing at low speeds, such as when parking.

### Forms of detection

The car has several ways to identify objects that are in or approaching your reversing path. If it detects an object, the car can provide warnings or intervene by braking.

**Parking sensors** These sensors can identify certain obstacles immediately behind the car when reversing at low speeds.

**Rear-facing radar** The car's rear radars can detect traffic approaching your reversing path from the sides.

**Camera detection** Certain features may use camera detection to help identify obstacles when reversing.

**Important**

These types of detection have limitations and cannot detect all obstacles in every situation. Be sure to read the separate manual sections about their conditions and limitations.

When you are reversing, some information from the detection systems can be communicated in the parking view.

### Warning and intervention features



The following features are designed to react when the car identifies a risk of collision when reversing.

The content of this manual represents the status of the user manual at the time of printing and may not be completely valid in future instances. For more information, refer to the first page for the complete disclaimer note.

**Alerts about traffic crossing behind the car<sup>[1]</sup>**

Your car can provide visual and sound alerts if it detects traffic about to cross your reversing path.

**Automatic braking when reversing<sup>[2]</sup>**

The car can automatically brake to prevent a collision when reversing. This can happen if it detects an obstacle or crossing traffic behind the car.

**Assisted parking sound alerts**

Your car can provide visual and sound alerts if it detects objects in, or close by, your reversing path.

 **Tip**

**Temporary deactivation**

The assisted parking sound alerts and the rear auto brake can be temporarily turned off if the interventions are too frequent or distracting. For example, reversing in tall grass or manoeuvring in very tight spaces can cause unwanted warnings or braking interventions.

 **Important**

**Use responsibly**

Warnings and interventions when reversing are supplements to safe driving practices. They do not reduce or replace the need for the driver to stay attentive and focused on driving safely.

**Pay attention to surroundings**

The driver is always responsible for paying attention to the car's surroundings and ensuring that it is safe to manoeuvre the car.

**Speed conditions**

The rear auto brake is available when you are reversing at speeds below 10 km/h (6 mph), whereas cross traffic alerts are available when you are reversing at speeds below 15 km/h (9 mph).

**Detection conditions**

Detection of traffic or obstacles behind the car relies on detection by the rear radars and the parking sensors. Be sure to read the separate section about limitations of radar detection.

If the car deactivates the rear radars or the parking sensors, the cross traffic alert and rear auto brake features are automatically disabled. This happens if a trailer is connected. Towbar-mounted accessories that are not connected electrically to the car does not disable the rear radars, but can obstruct them.

<sup>[1]</sup> Cross Traffic Alert (CTA)

<sup>[2]</sup> Rear Auto Brake (RAB)

---

## 10.4.2.1. Alerts about traffic crossing behind the car

When you're reversing at low speed, the car can warn you if it detects traffic about to pass behind you. This feature is called Cross Traffic Alert.

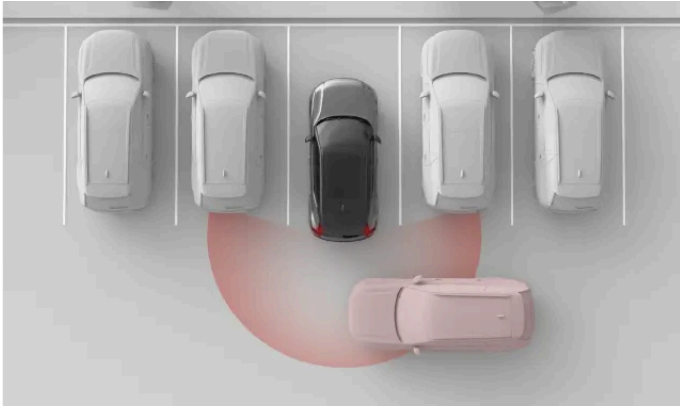

Your car can detect a car crossing behind you, for example when reversing out of a parking spot. This allows it to warn you so that you can slow down or brake.

Alerts about traffic crossing behind the car are only available when the car is in reverse (R) or rolling backwards in neutral (N). This feature uses the rear radars to detect traffic. When it detects a moving vehicle, an alert appears in the centre display along with a warning sound.

This feature is primarily designed for detecting larger vehicles in motion, such as cars. In favourable conditions it may also be able to warn you of smaller moving objects, such as cyclists and pedestrians.

**!** Important

**Driver responsibility**

Alerts about traffic crossing behind are a supplement to safe driving practices. They do not reduce or replace the need for the driver to stay attentive and focused on driving safely.

**i** Note

**Automatic braking for crossing traffic**

If automatic braking<sup>[1]</sup> is enabled, the car may also intervene by braking to prevent or mitigate an imminent collision with traffic detected behind you. Automatic braking can be enabled or disabled in the centre display.

## Detection zones

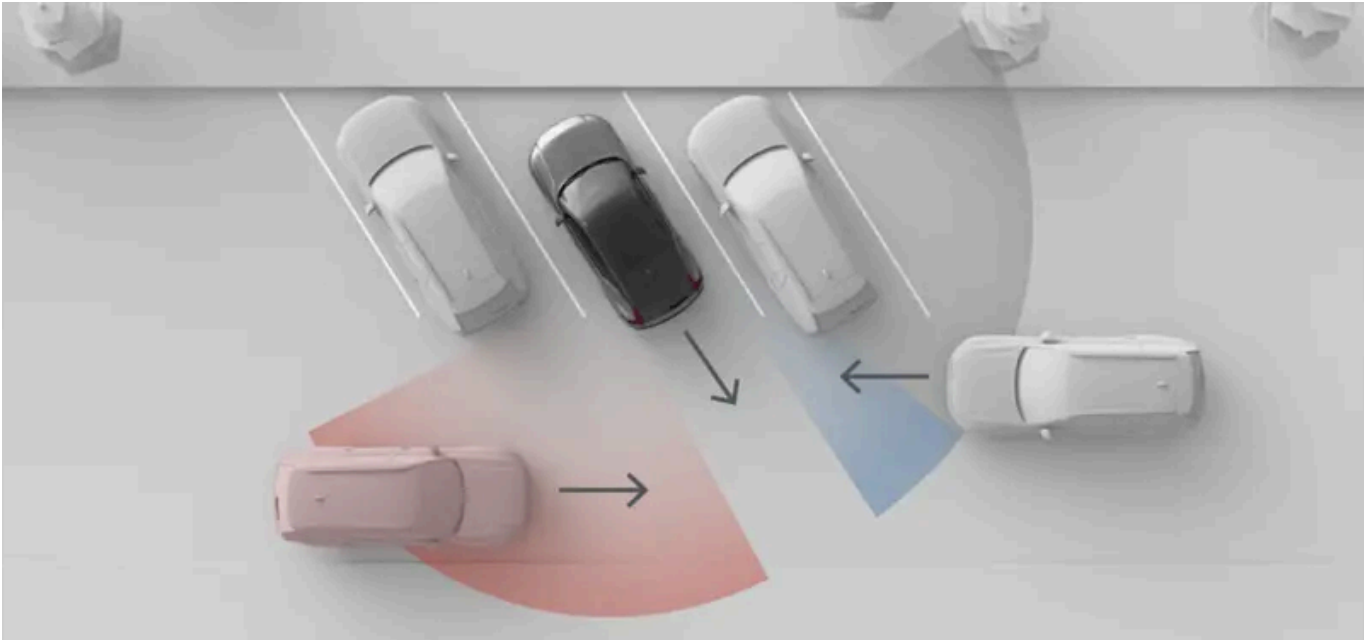

The situation shown in this image illustrates how surrounding objects, such as parked cars can limit the car's ability to detect other vehicles and traffic situations. In a situation without obstacles, the effective detection zones are the same on both sides.

### Note

#### Reversing out of a parking space

When parked, your rear corner radars' side views might be obstructed, which affects detection of crossing traffic. This happens when you are parked with the rear corners of your car further in than adjacent cars or other objects. This effect is particularly noticeable in angled parking spaces. However, as you reverse out of a parking space, the radars' views gradually increase, making detection possible. To minimise the risk of late or no detection when reversing out of a parking space, go slowly.

## Conditions and limitations

- The alerts are only available when reversing at speeds below 15 km/h (9 mph).
- If the car deactivates the rear radars, this feature is automatically disabled. This happens if a trailer is connected. Towbar-mounted accessories that are not connected electrically to the car does not disable the rear radars, but can obstruct them.
- Detection of traffic behind the car relies on detection by the rear radars. Be sure to read the separate section about limitations of radar detection.

<sup>[1]</sup> Rear Auto Brake (RAB)

## 10.4.2.2. Disabling automatic braking when reversing

The rear auto brake can be temporarily disabled in the parking view.

By disabling the rear auto brake you cancel your car's ability to perform braking interventions when you are reversing. Disabling the rear auto brake is only temporary. By default, the feature will reset to enabled between drives.

**!** Important

### Changing driver support settings

Make sure that you understand how changing the car's settings affects its behaviour. It is particularly important when it comes to features that affect the level of assistance the car can provide.

1. In the parking view, press the rear auto brake button.



- > Automatic braking when reversing is temporarily disabled.

---

## 10.4.3. Lane keeping aid

Lane keeping aid helps prevent accidental high-speed lane departures by providing warnings and steering interventions.

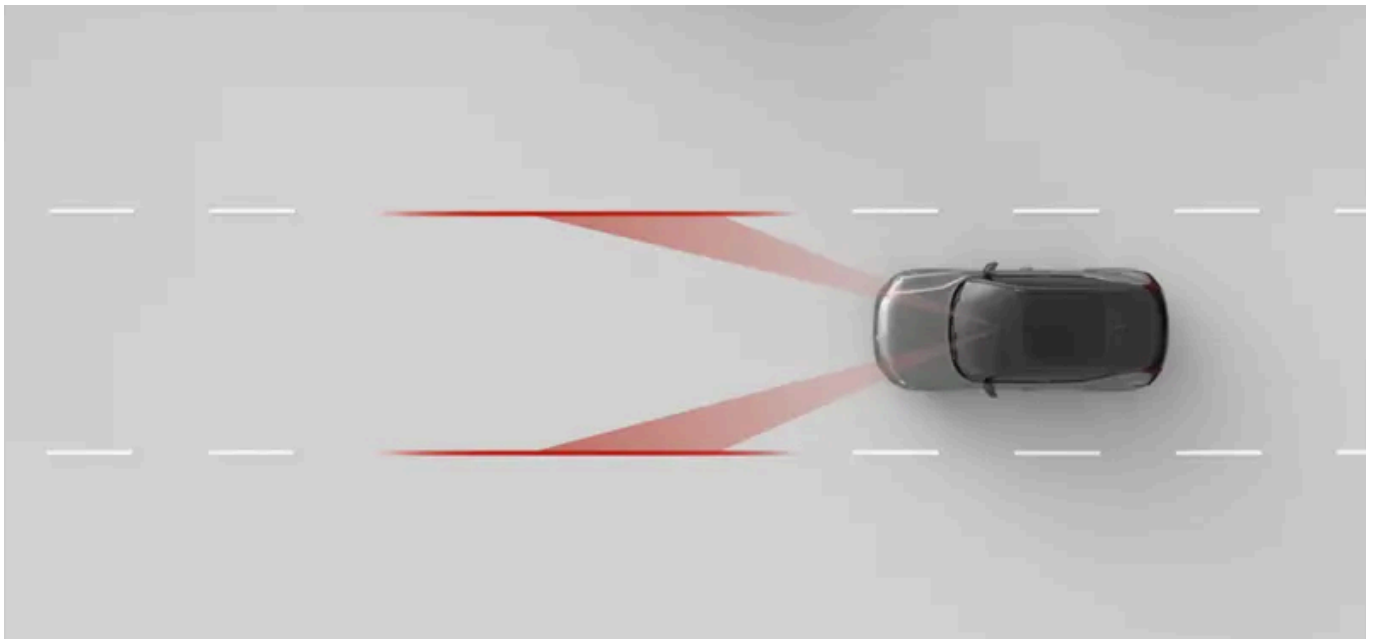

When lane keeping aid is enabled, the car can alert you if you are about to drift out of your lane and it can ask you to steer the car with attention. It can also perform steering interventions. Lane keeping aid relies on the car's forward-facing camera to identify road markings and your position in the lane.

 **Warning**

Lane keeping aid warnings and interventions are supplements to safe driving practices. They do not reduce or replace the need for the driver to stay attentive and focused on driving safely. Drive the car with the same attention to safety as required by a car without the ability to intervene.

## Main conditions for lane keeping aid

For lane keeping aid to work, several conditions need to be met. The following are the most essential:

- Your speed must be in the range 65-200 km/h (40-125 mph).
- The lane markings must be clearly visible for the car's camera to see.
- The lane must be wide enough. A very narrow lane does not provide enough margin between the car and the road markings.
- You must keep your hands on the steering wheel and actively steer the car.

 **Important**

### Steering actively

Never let go of the steering wheel when driving. Do not dismiss the car's requests for you to steer actively and keep your attention on the road.

## Lane keeping aid intervention types

If you are about to cross your lane's road markings, your car can warn you or intervene in either or both of the following ways:

**Steering intervention** The car tries to steer back into the lane.

**Lane departure warning** The car alerts you using steering wheel vibrations.

 **Note**

### Indicating a turn or lane change

As long as you use the direction indicators when changing lanes, the car assumes it's an intentional manoeuvre.

### Cutting a corner

Lane keeping aid may allow you to briefly cut across the line at sharp corners.

### Hands on the wheel

Lane keeping aid requires you to keep your hands on the steering wheel. This is continuously monitored by the car. If the car detects that your hands are not on the steering wheel for a prolonged duration of time, it may notify you with a sound along with a message in the driver display.

### Safety interventions are always enabled

Some situations can cause a steering intervention to prevent a dangerous lane departure even if lane keeping aid is turned off in settings.

## Display symbols and communication

Lane keeping aid warnings and interventions are communicated in the driver display.



Lane keeping aid is active. The white lane markings in the symbol indicate which lane markings are visible to the car.



This symbol appears if you are coming too close to the lane markings. The symbol is mirrored during right-hand side warnings.



This symbol indicates that lane keeping aid is disabled in settings or temporarily unavailable.



This symbol appears when there is a lane keeping aid malfunction. This means that lane keeping aid and safety interventions to prevent lane departures are disabled.

## Road markings conditions and limitations

For lane keeping aid to work, road markings must be present and visible. The car identifies them using a forward-facing camera. This form of detection requires that the camera view is unobstructed and that the conditions for visual detection are present. Read the separate section about the conditions and limitations of your car's cameras to understand how features relying on camera detection are affected.

The appearance, condition and layout of road markings can affect their detection in the following ways:

- Lane divisions and mergers can cause temporary misidentification of the lane.
- Non-standard or unusual road marking layouts might not be identified correctly by the car. For example, road work or traffic diversions can result in conflicting or multiple sets of road markings.
- The car may be unable to detect deteriorated road markings, for example if they are worn, misshapen or discoloured.
- Other edges or lines can be misidentified as road markings, such as kerbs, road surface repair edges, barriers or well-defined shadows.
- Road markings must be sufficiently illuminated to be detected. In low-light conditions, they need to be illuminated by the car or street lights.

## 10.4.3.1. Adjusting lane keeping aid

You can enable, adjust or disable lane keeping aid in settings.

When lane keeping aid is enabled, the car can alert you or intervene by steering if you are about to drift out of your lane. You can also adjust the car's response to lane departures.

The available settings are:

**Vibration** The steering wheel vibrates if you drive too close to or over the lane markings.

**Steering and vibration** In combination with steering wheel vibrations, your car will try to steer you back into your lane if you drive too close to or over the lane markings.

You can temporarily disable lane keeping aid if it interferes too much with your driving. This can be useful if the road markings are partially obscured or faded, which can cause unwanted warnings.

Disabling lane keeping aid is only temporary as this setting automatically resets to enabled between drives.

### Important

#### Changing driver support settings

Make sure that you understand how changing the car's settings affects its behaviour. It is particularly important when it comes to features that affect the level of assistance the car can provide.

1. Press the car symbol  in the bottom bar and go to **Settings**.
2. Go to **Driving** → **Safety assistance** → **Lane keeping aid**.
3. Enable or disable lane keeping aid.
4. After enabling lane keeping aid you can adjust the car's response to lane departures.

## 10.4.4. Blind spot information

The blind spot information feature helps increase your awareness of vehicles in or approaching your blind spots. A light appears in the wing mirror when a vehicle is detected.

Blind spot alerts can increase your awareness of vehicles to the side of your car, which can help you avoid performing dangerous lane changes. The alerts primarily appear as a light in the wing mirror on the side of detection. They rely on your car's rear radars for detection of vehicles in adjacent lanes.

Traffic situations in which blind spot alerts appear include:

- When you are being overtaken by another vehicle.
  - In some cases, they can appear before the passing vehicle reaches your blind spot. This happens if it's quickly approaching from behind in an adjacent lane.

The content of this manual represents the status of the user manual at the time of printing and may not be completely valid in future instances. For more information, refer to the first page for the complete disclaimer note.

- When you are overtaking another vehicle.

Regardless of the situation, the alert remains as long as the other vehicle is detected to your side.

If you start indicating a lane change while an alert is shown, the alert intensifies.

## Alerts in the wing mirrors



When a vehicle is detected in or approaching your blind spot, a light appears in the wing mirror.

## Detection areas

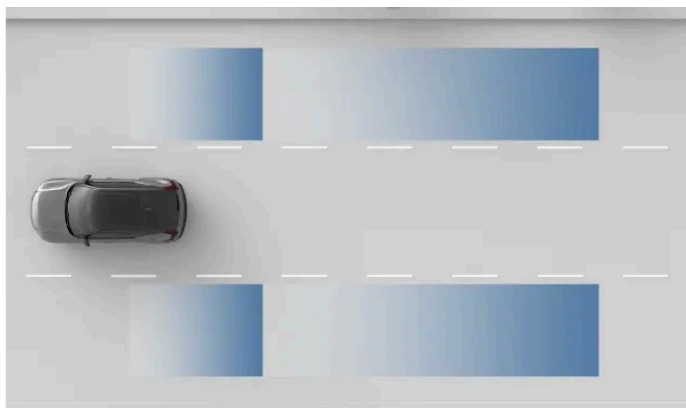

Radar detection areas.

### Important

The detection areas may not perfectly cover your own blind spots. Be sure to adjust your driving posture to allow for a good overview of surrounding traffic.

## Conditions and limitations

- Blind spot information is active at speeds above 12 km/h (7 mph). It's not available when reversing.
- When passing other vehicles, the speed difference between your car and the other vehicles must be below 15 km/h (9 mph) for the alerts to appear.
- Blind spot information relies on detection by the rear radars. Be sure to read the separate section of this manual about limitations of radar detection.

The content of this manual represents the status of the user manual at the time of printing and may not be completely valid in future instances. For more information, refer to the first page for the complete disclaimer note.

- If the rear radars are obstructed, such as by an attached trailer or mounted bike rack, alerts about vehicles in the blind spots are automatically disabled.

 **Important**

### Driver responsibility

Alerts about vehicles in the blind spots are a supplement to safe driving practices. They do not reduce or replace the need for the driver to stay attentive and focused on driving safely.

The lack of a blind spot indication is not a confirmation that it is safe to change lanes. It is one of several pieces of information that inform the driver's assessment of whether it is safe to proceed.

## 10.4.5. Driver alert

The car continuously assesses your behaviour while driving and can notify you if you seem unfocused. A lack of focus can be caused by distractions or being tired.

If the car identifies signs of reduced driver focus, it will notify you with a sound and a message.

The car uses different methods to assess your focus when driving.

**Attention tracking** Camera tracking of your face and eye movements allows the car to determine where you are directing your attention.

**Manoeuvring** Analysing the way you manoeuvre the car can provide an indication of lacking focus. One example of this is excessive lane drifting.

### Distraction alert

Your level of attentiveness while driving is continuously monitored by your car's internal camera. If you seem inattentive or distracted, the car can alert you of this via sound and messages in the driver display.



Distraction alert notifications are on by default for each new driving cycle and can be temporarily disabled in settings or quick controls.

### Alerts about a tired or drowsy driver

Your car monitors certain aspects of your driving as well. Certain driving patterns, such as excessive lane drifting, may provide indications that the driver is tired or drowsy.

If the car identifies signs of tiredness or drowsiness, it will notify you with a sound and a message in the driver display. If you ignore the message and continue to behave similarly, the warnings will escalate. These alerts cannot be disabled.



 **Warning**

### The importance of a well-rested driver

Any notifications about you showing signs of being tired should be taken seriously, as a tired driver is often unaware of their condition. If you feel tired or receive an alert about it from the car, stop as soon as possible in a suitable location for a rest. Always plan for regular breaks and start all trips with a well-rested driver.

Driving while tired is comparable to driving under the influence of alcohol.

## Conditions and limitations

Distraction alert is activated when your driving speed exceeds 20 km/h (12 mph).

Alerts about a tired or drowsy driver are first activated when your driving speed exceeds 65 km/h (40 mph), but will remain active as long as your driving at speeds higher than 60 km/h (37 mph).

- Attention tracking requires an unobscured view of the driver's face.
  - Improperly stowed items can obscure the view of the driver, as can dust and dirt on the camera lens. Keep the driver's space clean and clutter-free.
  - Wearing certain clothing and accessories can obstruct parts of the driver's face that need to be visible for attention tracking, such as the eyes.
- Certain conditions can affect how well your car can assess your driving and manoeuvring. This in turn affects how well it can distinguish signs of an unfocused or tired driver.
  - Features that help with lane placement can sometimes compensate for manoeuvring that would otherwise indicate a lack of driver focus. This makes it harder to identify signs of lacking focus compared to unassisted driving.
  - Conditions such as strong winds or uneven road surfaces can affect your driving in ways similar to that of an unfocused driver. This can potentially cause warnings despite having a fully focused driver behind the wheel.

Read the separate section about conditions and limitations of your car's driver behaviour detection system and cameras to understand how features relying on these systems are affected.

 **Important**

### Driver responsibility

Alerts about a lacking focus when driving are a supplement to safe driving practices. The driver is fully responsible for making sure they are able to stay alert and maintain focus when driving.

## 10.4.5.1. Disabling distraction alert notifications

You can enable or temporarily disable distraction alert notifications in settings and quick controls.

Disabling distraction alert notifications is only temporary as this setting automatically resets to enabled between drives.

You cannot disable alerts concerning driver tiredness or drowsiness.

 **Warning**

### The importance of a well-rested driver

Any notifications about you showing signs of being tired should be taken seriously, as a tired driver is often unaware of their condition. If you feel tired or receive an alert about it from the car, stop as soon as possible in a suitable location for a rest. Always plan for regular breaks and start all trips with a well-rested driver.

Driving while tired is comparable to driving under the influence of alcohol.

 **Note**

### Driver responsibility

Alerts about a lacking focus when driving are a supplement to safe driving practices. They do not reduce the driver's responsibility to continuously assess whether they are too tired or unfocused to drive safely.

 **Tip**

### Quick access

A button for turning distraction alert notifications on or off is also available in quick controls in the centre display. This allows you to quickly manage distraction alert notifications without going into settings.

1. Press the car symbol  in the bottom bar and go to **Settings**.
2. Go to **Driving** → **Safety assistance** → **Distraction alert**.
3. Turn distraction alert notifications on or off.

---

## 10.4.6. Connected safety

Your car can communicate information with other cars on the road, which can help you to be aware of or avoid accidents or traffic jams further up the road. This feature is called connected safety.

Through an internet connection, your car and other cars on the same road can share information about accidents, slippery road conditions and other situations that may cause activation of the hazard warning lights.

Connected safety can be enabled or disabled in privacy settings.

### **Warning**

Never rely on connected safety warnings by the car to be a replacement for safe driving practices. Drive the car with the same attention to safety as required by a car without this feature.

## Connected safety warnings

Depending on the nature of the information your car receives from other road users, one of these two symbols can be shown in the driver display:



A vehicle's hazard warning lights have been activated further up the road.



Slippery road conditions are detected further up the road.

## Conditions and limitations

Connected safety relies on communication between your car and other vehicles on the road. This communication relies on a number of conditions, such as:

- The connected safety feature must be enabled in settings.
- Connected safety must be available to the other road users.
- The involved cars must be connected to the internet. A weak or no internet connection can disable the feature until the connection is improved.
- The road you're on is in the Volvo Cars database.

### **Note**

A slippery road may not always result in a warning from connected safety, as your car or other connected road users may not experience the road conditions as such. Low-friction situations between the tyres and road surface are often used as markers to identify a slippery road. Low-traction manoeuvres, such as slight steering, braking or acceleration, rarely cause low-friction situations. Therefore, it might prove difficult to identify the road as slippery during such manoeuvres.

## 10.4.6.1. Enabling connected safety

You can enable or disable connected safety in settings.

Connected safety can warn you of upcoming situations on the road you're on, such as another vehicle with their hazard warning lights activated or slippery road conditions. The feature relies on communication with other road users via internet connection.

 **Important**

## Changing driver support settings

Make sure that you understand how changing the car's settings affects its behaviour. It is particularly important when it comes to features that affect the level of assistance the car can provide.

If you are logged in to a guest profile, you first need to switch to an owner or co-driver profile. Press the car symbol  in the bottom bar and go to **Settings**. Go to **Profiles** and select your profile.

1. Press the car symbol  in the bottom bar and go to **Settings**.
2. Go to **Privacy** → **Volvo privacy settings** → **Connected safety**.
3. Enable or disable connected safety.

---

## 10.4.7. Ready to drive notification

When traffic is at a standstill, your car can notify you if the vehicle in front has started moving. This feature can be enabled or disabled in settings.

When the car notices that traffic in front of you has started moving, it notifies you with a sound and a message in the driver display.

If the car detects pedestrians or cyclists close to the car, the ready to drive notification might not be given.

 **Warning**

The notification does not indicate that it is safe to drive, only that traffic has started moving. The driver is always responsible for determining if it is safe to start driving.

## Conditions and limitations

The ready to drive notifications system relies on camera and radar detection. The cameras and radars used by the notification system have limitations that can affect the system's detection capabilities. Read the separate sections about the conditions and limitations of camera and radar detection to understand how features relying on these kinds of detection are affected.

---

### 10.4.7.1. Enabling ready to drive notification

You can enable or disable ready to drive notifications in settings.

When traffic is at a standstill, your car can notify you if the vehicle in front has started moving. You can enable or disable this feature in settings.

 **Warning**

The notification does not indicate that it is safe to drive, only that traffic has started moving. The driver is always responsible for determining if it is safe to start driving.

1. Press the car symbol  in the bottom bar and go to **Settings**.
2. Go to **Driving** → **Safety assistance** → **Ready to drive notification**.
3. Enable or disable the notifications.

## 10.5. Assisted driving

Assisted driving features use the car's ability to monitor its surroundings to make driving safer and less demanding.

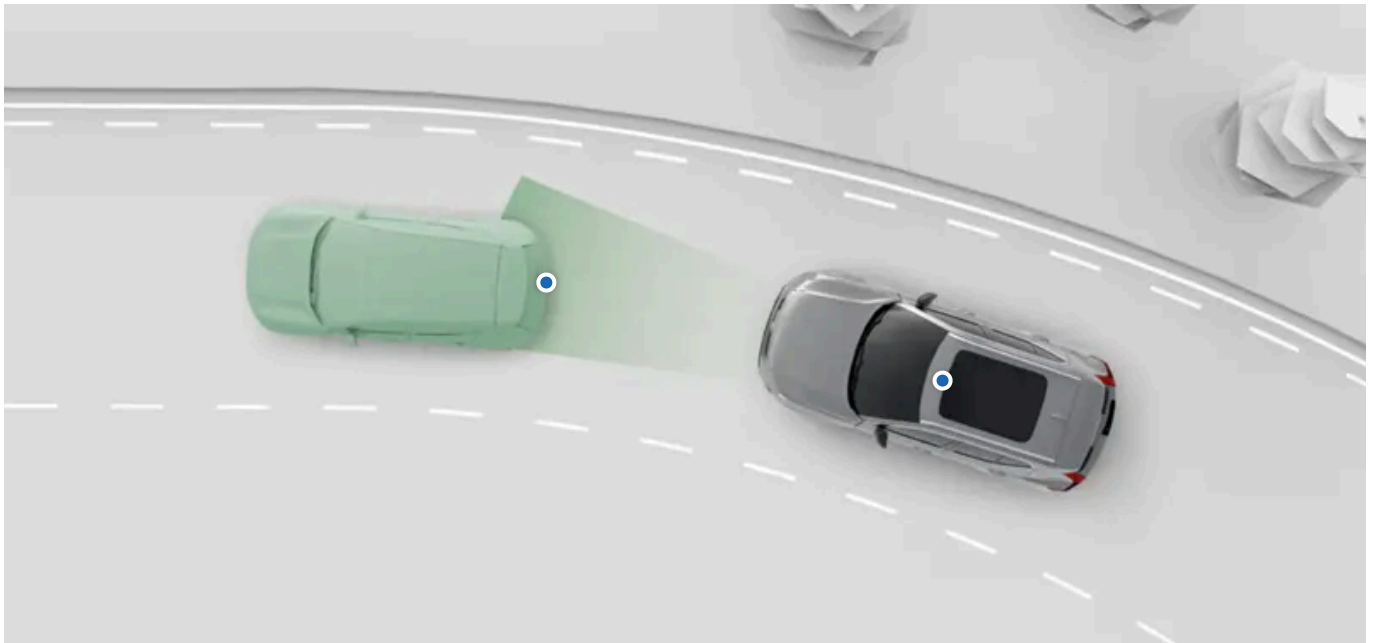

There are several forms and levels of assistance. They can actively assist you with a number of driving tasks and provide information support for better driver decision-making.

You can enable, disable or customise many of your car's assisted driving features in settings.

**Pilot Assist** This feature can assist you in several driving tasks such as steering and managing speed. Pilot Assist can be customised in settings.

**Road signs and speeding response** Several features can assist you with keeping track of the speed limit and preventing unintentional speeding. They include road sign information, which makes you aware of the speed limit, and different responses from the car designed to prevent you from exceeding the speed limit. These features can be customised in settings.

 **Tip**

### Safety interventions and warnings

Many of the driver support features are designed to improve both convenience and safety. Features that primarily provide safety interventions and warnings have their own, separate section in this manual.

### Assisted parking

There is a separate section of this manual covering assisted parking features.

 **Important**

### Required knowledge and driver responsibility

Assisted driving features are designed to make driving safer and less demanding, but they do not reduce the driver's responsibility to operate the car as safely as possible. Be sure to read all related information about a feature before using it. The section covering driver responsibility is essential reading to understand the capabilities and limitations of your car's assisted driving features.

If you find anything unclear or have further questions, do not hesitate to contact an authorised Volvo workshop.

### Detection capabilities

The car's ability to monitor its surroundings is used by assisted driving features. To better understand the limitations of such features, read the separate section about detection of traffic and surroundings. It provides an overview of how important components work, such as cameras and radars, by detailing both capabilities and limitations.

## 10.5.1. Road signs and speeding response

Several features can assist you with keeping track of the speed limit and preventing unintentional speeding.

To help you maintain a legal speed, your car is designed to make you aware of the current speed limit by showing it in the driver display. It can also respond with warnings if you exceed the speed limit.

<b>Road sign information</b>	The car can detect and display information from road signs, such as the speed limit.
<b>Speed limit warnings</b>	Intelligent Speed Assist <sup>[1]</sup> can warn you with sound or alter the accelerator's response if you exceed the speed limit.
<b>Sound for new speed limit</b>	A sound alert indicates when the car detects that the speed limit changes.
<b>Sound alerts for upcoming speed cameras.</b>	A sound alert indicates when the car detects that the speed limit changes.

 **Important**

Speed-related information and warning features are supplements to safe driving practices. They do not reduce or replace the need for the driver to stay attentive and focused on driving safely. It is the driver's responsibility to observe and maintain a legal and safe speed.

<sup>[1]</sup> ISA

## 10.5.1.1. Speed limit warnings

Speed limit warnings can be provided to help prevent unintentional speeding.

Intelligent Speed Assist<sup>[1]</sup> can give you speed limit warnings when you exceed the speed limit.



The ISA symbol is shown in the driver display when you exceed the speed limit and when you enable or disable the feature.

You can adjust the speeding response from ISA in settings. The following options are available:

**Pedal** Limits the response from the accelerator when you exceed the speed limit. If a new, lower speed limit is discovered, ISA can also slow your car down to the correct driving speed.

**Sound** A sound alert is played when you exceed the speed limit.

Along with your set speeding response, ISA can provide visual warnings in the driver display. When exceeding the speed limit, the road sign symbol with the current speed limit will flash in the display.

 **Tip**

### Overriding the ISA pedal response

When the speeding response is set to **Pedal**, you can always override the feature by pressing the accelerator down further.

### Quick access when driving

Intelligent Speed Assist can be temporarily disabled for the rest of your drive via the disable ISA button  on the steering wheel. This allows you to quickly turn it on or off.

 **Note**

### Intelligent Speed Assistance in your car

Your car is designed to meet the requirements of the European Union's Intelligent Speed Assistance regulation. The purpose of the regulation is to make driving safer by requiring features that encourage staying below the legal speed limit. In your car, the behaviour of speed limit warnings and displayed road signs is in part affected by these requirements.

## Conditions and limitations

Speed limit warnings use road sign information to keep track of the speed limit. If information about the speed limit is unavailable for some reason, no warning can be provided.

 **Important**

### Driver responsibility

Speed limit warnings are supplements to safe driving practices. They do not reduce or replace the need for the driver to stay attentive and focused on driving safely. It is the driver's responsibility to observe and maintain a legal and safe speed.

<sup>[1]</sup> ISA

## 10.5.1.1.1. Disabling Intelligent Speed Assist

Speed limit warnings from Intelligent Speed Assist<sup>[1]</sup> can be temporarily disabled for the rest of the drive.

You can disable the alerts for exceeding the speed limit. However, they are enabled by default for each new drive. Speed limit warnings are disabled by turning road sign information off.



Press the disable ISA button ◀ on the steering wheel.

> Speeding responses from Intelligent Speed Assist will not occur for the rest of your drive.

The speeding responses can be enabled again by pressing the same button as when you disabled them.

<sup>[1]</sup> ISA

---

## 10.5.1.1.2. Adjusting speed limit warnings

Speed limit warnings from Intelligent Speed Assist<sup>[1]</sup> can be adjusted in settings.

You can adjust the speeding response from ISA in settings. The following options are available:

**Pedal** Limits the response from the accelerator when you exceed the speed limit. If a new, lower speed limit is discovered, ISA can also slow your car down to the correct driving speed.

**Sound** A sound alert is played when you exceed the speed limit.

### Note

When using Pilot Assist the speeding response is automatically set to be provided as sound alerts.

1. Press the car symbol  in the bottom bar and go to **Settings**.

The content of this manual represents the status of the user manual at the time of printing and may not be completely valid in future instances. For more information, refer to the first page for the complete disclaimer note.

2. Go to **Driving** → **Intelligent speed assist** → **Speeding response**.
3. Select a speeding response.

<sup>[1]</sup> ISA

---

## 10.5.1.2. Enabling sound alerts for speed limit changes

Your car can alert you with a sound when it detects a new speed limit. This feature can be enabled or disabled in settings.

1. Press the car symbol  in the bottom bar and go to **Settings**.
  2. Go to **Driving** → **Safety assistance** → **Sound for new speed limit**.
  3. Enable or disable sound alerts for speed limit changes.
- 

## 10.5.1.3. Enabling sound alerts for speed cameras

Your car can alert you of upcoming speed cameras.

Alerts for upcoming speed cameras can be shown in the driver display along with a sound.

1. Press the car symbol  in the bottom bar and go to **Settings**.
2. Go to **Driving** → **Safety assistance** → **Speed camera audio warning**.
3. Enable or disable the sound alerts for upcoming speed cameras.

 **Note**

The availability of this feature may differ between regions.

---

## 10.5.1.4. Road sign information

The car can identify and display road signs as you pass them, allowing you to keep track of the speed limit. This feature combines direct detection of signs with sign information from map data.

The signs shown in the driver display come from two different sources - either from real-world signs identified by camera or from map data. The car automatically prioritises which source to use depending on the situation.

The car can only show signs that are part of the car's sign library.

### How signs are shown

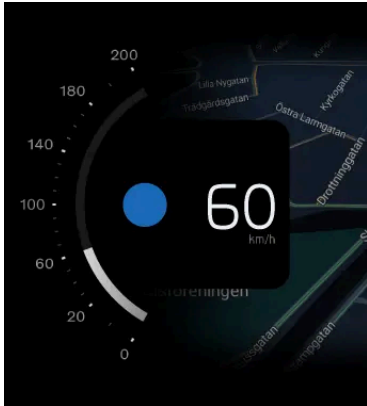

How the road sign symbols appear can sometimes depend on the current driver display mode.

The car can simultaneously display several sign types. This can include the current speed limit and an upcoming speed limit, as well as a warning sign or an additional traffic information sign.

Detected road signs appear next to the speedometer in the driver display.

### Displayed road signs

This list contains examples of road sign types that can be shown in the car.



Speed limit



No entry



Upcoming speed camera

 **Note**

### Symbol availability

Road signs available to display in your car can change over time and vary between regions. The selection presented in this manual may not include every sign that can appear in your car's display.

### Symbol design

Road sign styles vary between regions. The symbol style displayed by the car will not exactly match the symbol style of signs you encounter. If you have any issues interpreting a displayed sign despite the information provided in this manual, contact Volvo support.

## Road sign display times

The display time for signs typically depends on the type of sign and whether you pass additional signs. Road signs can be shown in the following ways:

- Briefly as one-time alerts after passing a sign.
- Until the sign no longer applies.
- Until you pass another sign with higher display priority.

 **Note**

### Lingering signs

The car might fail to identify a sign indicating the end of a traffic limitation. If this happens, a symbol for the previous limitation can linger in the driver display. It will eventually be replaced or cancelled. In the meantime, drive according to the applicable rules of the road.

## Conditions and limitations

 **Important**

### Driver responsibility and road signs

Road sign information is designed to help manage information while driving. It is a supplement to safe driving practices. The driver is fully responsible for remaining attentive, keeping track of road signs and following local regulations. Do not prioritise the car's road sign detection over your own observations if they conflict.

### Why all signs are not shown

The car cannot detect and show every sign that is relevant to the driver.

- Not all signs are supported by the system.
- Signs may go undetected in certain conditions and traffic situations.

Conditions affecting road sign detection or identification:

- The car's forward-facing camera must be clean and free of obstructions.

**The content of this manual represents the status of the user manual at the time of printing and may not be completely valid in future instances. For more information, refer to the first page for the complete disclaimer note.**

- The road sign must be clearly visible and properly illuminated.
- The road sign must be within a certain distance and within the camera's field of view.
- The car may not be able to identify misaligned road signs, such as signs placed too high or at an angle.
- The car may not be able to identify damaged or worn road signs.

Conditions affecting sign information from map data:

- An internet connection is required to download map data that contains information about road signs.
- The coverage of road sign information from map data varies between regions.

 **Note**

For consistent and up-to-date road sign information in your car, be sure to accept Google's Terms of service. Contact an authorised Volvo workshop if you experience any issues with the road sign information feature.

---

## 10.5.1.4.1. Enabling road sign information

Your car can show available road signs and traffic information in the driver display. You can enable road sign information in settings.

1. Press the car symbol  in the bottom bar and go to **Settings**.
2. Go to **Driving** → **Safety assistance** → **Road sign information**.
3. Enable road sign information.

---

## 10.5.2. Pilot Assist

Pilot Assist combines several support capabilities to make driving more convenient and less demanding. It can assist you with speed management and steering guidance in a wide variety of situations.

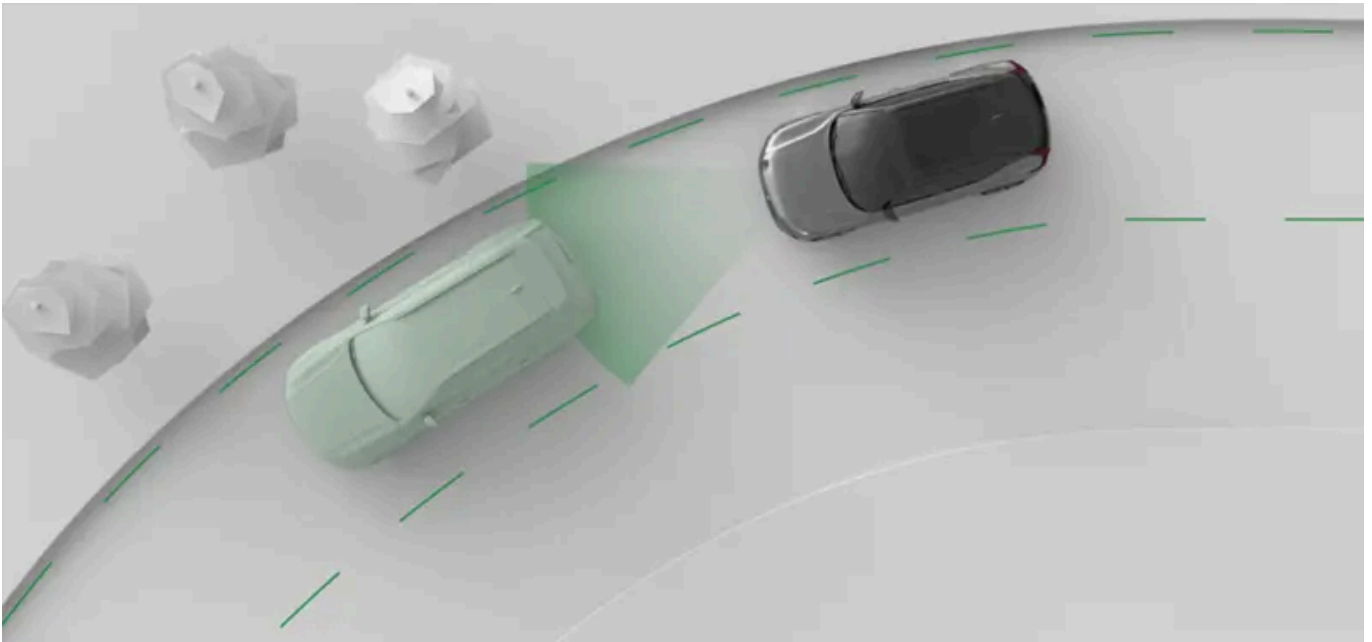

Pilot Assist actively guides your driving in a number of ways. When driving with Pilot Assist, you select the target speed. The car then manages acceleration and braking to meet that target while also adapting to surrounding traffic.

It's also capable of steering assistance. When available, steering assistance helps with road positioning by guiding your steering wheel movement.

#### Important

##### Before using Pilot Assist

Take the time to read everything the manual has to say about Pilot Assist before using it. Understanding its capabilities and limitations is necessary for safe use.

##### The driver is in control

When using Pilot Assist, you are still in control of the car. It's your responsibility to continuously assess Pilot Assist's performance. As long as you judge its input to be correct, you can let it guide your driving.

#### Tip

##### Customise Pilot Assist

Some of Pilot Assist's capabilities can be customised, either in Pilot Assist's settings or by using the steering wheel buttons. This allows you to set it up for the level of support you want.

## Pilot Assist and adaptive cruise control

While your car is equipped with Pilot Assist, you also have access to adaptive cruise control. The adaptive cruise control can be considered a sub-feature of Pilot Assist, providing speed- and distance-keeping but no steering assistance. You can activate and

switch between the features using your steering wheel control buttons. The driver display typically shows your level of support using symbols <sup>[1]</sup>.

 **Important**

Pilot Assist shares most of its conditions and limitations with adaptive cruise control, except the ones connected to steering assistance. When reading the manual and understanding your car's capabilities, you should consider Pilot Assist and adaptive cruise control to be similar.

## Managing speed and time interval to vehicles ahead

When you activate Pilot Assist, a set speed value appears by the speedometer. This represents the target speed that Pilot Assist tries to maintain. You can adjust the target speed with the steering wheel buttons.

If your car detects a vehicle ahead that's either slower than you or a bit too close, Pilot Assist will slow down to maintain a certain distance to the vehicle in front. Once the road ahead becomes clear again, your car returns to the target speed. You can adjust the target time interval to vehicles ahead using the steering wheel buttons.

## Steering assistance

The availability of active steering assistance depends on the conditions you are experiencing. For example, if you encounter a stretch of road with worn-out markings, the car may temporarily turn steering assistance off and you must steer the car unassisted by Pilot Assist. As soon as the necessary conditions are met again, steering assistance reactivates.

Steering assistance is unavailable during lane changes and will temporarily deactivate when you use the direction indicators.

 **Note**

### Adaptive cruise control

When using adaptive cruise control, your car will not provide any steering assistance <sup>[2]</sup>.

## Pilot Assist features and settings

There are a number of Pilot Assist capabilities and settings to read about in this manual.

<b>Steering assistance</b>	When driving with steering assistance, your steering is actively guided. This can help you maintain correct lane positioning.
<b>Adaptive cruise control</b>	When adaptive cruise control is active, your car manages acceleration and braking to meet your set target speed while also adapting to surrounding traffic. In essence, adaptive cruise control can be considered as Pilot Assist without steering assistance.
<b>Target speed</b>	You can adjust the target speed for Pilot Assist using the steering wheel buttons.
<b>Distance keeping</b>	You can adjust your car's general distance-keeping by adjusting the time interval to vehicles ahead using the steering wheel buttons.
<b>Pilot Assist as default</b>	Allows you to activate Pilot Assist as your default assisted driving feature. You can enable or disable this in settings. While driving, you can switch between Pilot Assist and adaptive cruise control using the steering wheel controls.

## Status and availability

Pilot Assist's availability is indicated in the driver display and depends on the current driving conditions. You can always see the current level of support you're getting from Pilot Assist in the driver display.

 **Note**

### Paused

In some situations, Pilot Assist can be temporarily paused. This can happen when a driver decision is needed to resume driving with Pilot Assist, such as after coming to a stop. When Pilot Assist is paused this is communicated in the driver display.

<sup>[1]</sup> Warnings and messages in the displays may differ depending on the active feature.

<sup>[2]</sup> Steering capabilities from safety interventions and lane keeping aid are unaffected by this.

---

## 10.5.2.1. Pilot Assist communication and status

Learn how Pilot Assist's status and actions are communicated in the car.

The driver display shows the status of Pilot Assist using graphics and symbols. Important information can also appear as notifications.

### Communication with symbols

Pilot Assist's status is communicated using symbols. The symbols can show what level of support Pilot Assist is currently providing, depending on your active Pilot Assist settings.



Pilot Assist is active and providing steering assistance.



Pilot Assist is active but steering assistance is temporarily unavailable.



Pilot Assist is active and adapting the driving speed to a vehicle ahead.



Pilot Assist is paused.

When adaptive cruise control <sup>[1]</sup> is active, the symbol communication differs slightly:



Adaptive cruise control is active.



Adaptive cruise control is active and adapting the driving speed to a vehicle ahead.

The target speed appears in yellow above the speedometer.



## Notifications and messages

When using Pilot Assist, notifications can appear in the driver display. They can contain important information about the status of Pilot Assist features as well as instructions for you to follow, such as not letting go of the steering wheel.

[1] a sub-feature of Pilot Assist

---

## 10.5.2.2. Activating Pilot Assist

You activate Pilot Assist by pressing the Pilot Assist steering wheel button while driving. It's important to assess whether the current driving conditions allow you to use Pilot Assist safely.

Pilot Assist can be activated either with or without steering assistance. The activation symbol in the driver display reflects whether your car is assisting your steering or not.

By selecting **Pilot Assist as default** in settings, you ensure that Pilot Assist with steering assistance, instead of adaptive cruise control, is your default assisted driving feature. You can then switch between Pilot Assist and adaptive cruise control using the steering wheel buttons while driving.

### ! Important

#### Before using Pilot Assist

Take the time to read everything about Pilot Assist in this manual before using it for the first time. Understanding its capabilities and limitations is important for safe use.

#### Assess the situation

Make sure the traffic situation and conditions are suitable for activation. Wait until ongoing manoeuvres, such as a lane change, are completed before activating Pilot Assist.

## Activating Pilot Assist when driving

1.



When it's safe to do so, press the Pilot Assist button  on the steering wheel.

> Activation is confirmed in the driver display.

The first time you activate Pilot Assist during a drive, your speed at the time of activation becomes the target speed.



If you recently used Pilot Assist and you want to use your previous target speed, press the resume button  on the steering wheel.

When Pilot Assist is active, you can adjust the target speed and the time interval to vehicles ahead with the steering wheel buttons.

---

## 10.5.2.3. Deactivating Pilot Assist

When you want to stop driving with Pilot Assist, you can deactivate it manually. There are also situations in which Pilot Assist deactivates automatically.

Deactivating and activating Pilot Assist is done in the same way. You simply press the Pilot Assist button on the steering wheel. You can also deactivate Pilot Assist by braking.

When you deactivate Pilot Assist, all of its assistance is turned off. This includes speed- and distance-keeping as well as steering assistance.

### Deactivating Pilot Assist using the steering wheel button

- Press the Pilot Assist button  on the steering wheel.

> Deactivation is confirmed in the driver display.

### Deactivating by braking

- Press down on the brake pedal.

> Deactivation is confirmed in the driver display.

**Note**

### Automatic deactivation

Pilot Assist has several limitations and only works if all the necessary conditions are met. If the driving conditions change during your drive, Pilot Assist can deactivate automatically.

Scenarios where Pilot Assist may automatically deactivate include, but are not limited to, instances where:

- You are not driving actively. You must stay attentive and keep both of your hands on the steering wheel, even when driving with steering assistance.
- You open a door or unbuckle your seatbelt.
- You change gears. Pilot Assist cannot support you in gears N or R.
- You leave the direction indicator on for a long time when driving with steering assistance. This can indicate that you are not fully focused.
- You manually speed up and maintain a higher driving speed than the target speed. This indicates that you want to return to full manual control of your car.
- Camera or radar conditions for Pilot Assist are not met.

## 10.5.2.4. Adaptive cruise control

Adaptive cruise control is a sub-feature of Pilot Assist, sharing the same distance- and speed-keeping capabilities. It cannot, however, provide steering assistance.

When using adaptive cruise control, your car will try to maintain your set target speed as well as your set distance to other cars. You can adjust both your target speed and general distance to cars ahead using the steering wheel controls.

You can set adaptive cruise control as your default assisted driving feature in settings. This allows you to activate it with the Pilot Assist button  on the steering wheel.

While driving you can switch between Pilot Assist and adaptive cruise control using the switch button  on the steering wheel's control panel on the left-hand side.

The status of adaptive cruise control can be communicated with one of these two symbols in the driver display:



Adaptive cruise control is active.



Adaptive cruise control is active and adapting the driving speed to a vehicle ahead.

## Conditions and limitations

While Pilot Assist can also provide steering assistance, adaptive cruise control cannot. However, you can still get steering interventions from features such as lane keeping aid or in situations causing steering interventions. Conditions and limitations relat-

**The content of this manual represents the status of the user manual at the time of printing and may not be completely valid in future instances. For more information, refer to the first page for the complete disclaimer note.**

ing to detection capabilities, distance- and speed-keeping are shared between Pilot Assist and adaptive cruise control. The Pilot Assist conditions and limitations related to steering assistance do not apply to adaptive cruise control because the sub-feature does not provide any steering assistance.

---

## 10.5.2.5. Switching between Pilot Assist and adaptive cruise control while driving

You can switch between Pilot Assist and adaptive cruise control while driving.

When switching between Pilot Assist and adaptive cruise control, you enable or disable steering assistance. While adaptive cruise control is considered a sub-feature of Pilot Assist, the main difference is that Pilot Assist can provide steering assistance whereas adaptive cruise control cannot. Therefore, switching between the features can be viewed as enabling or disabling Pilot Assist's steering assistance.

### Important

While the conditions and limitations are similar between Pilot Assist and adaptive cruise control, it is important to know the differences. Make sure that you understand how switching between assisted driving features affects your driving and the car's behaviour.

1.



Press the switch button  on the steering wheel.

> Your selected level of support is shown in the driver display.

---

## 10.5.2.6. Adjusting the target speed for Pilot Assist

Pilot Assist can support you in maintaining a set target speed. You can adjust the target speed with the steering wheel control buttons.

When you are driving with Pilot Assist active, you can select a target speed. The car then manages acceleration and braking to meet that target while also adapting to surrounding traffic.

You can adjust your target speed by pressing the speed adjustment buttons on your steering wheel's control panel on the left-hand side.

**Press once** Adjust the target speed by 5 units by pressing the button once.



**Press and hold** Adjust the target speed by 1 unit continuously by pressing and holding the button.

When you adjust by 5 units at a time, the target speed will default to speed increments that are divisible by five, such as 25, 30 and 35.

1.



Adjust the target speed using the buttons on the steering wheel.

- Press the increase speed button  to increase the target speed.
- Press the decrease speed button  to decrease the target speed.

> Your new target speed is shown in yellow above the speedometer.





---

## 10.5.2.7. Adjusting the time interval to vehicles ahead

Pilot Assist can support you in keeping a set time interval to vehicles ahead. You can adjust the time interval, and through this the general distance, to vehicles ahead with the steering wheel control buttons.

When you are driving with Pilot Assist active, your car will try to adapt its driving speed to that of other vehicles. You can adjust your car's general distance-keeping by adjusting the time interval to vehicles ahead using the steering wheel buttons. The car then manages acceleration and braking to maintain that time interval.

Adjust the time interval by pressing the time interval adjustments buttons on your steering wheel's control panel on the left-hand side.

-  Decrease the target time interval to vehicles ahead.
-  Increase the target time interval to vehicles ahead.

The selected time interval is shown in the time interval indicator in the driver display. The time interval indicator is incorporated in the assisted driving symbol and differs depending on your current level of support.



The yellow horizontal lines are what make up the time interval indicator.

When adjusting the time interval to vehicles ahead, the number of lines will either increase or decrease depending on your adjustment. More lines indicate a longer time interval and greater general distance kept to vehicles ahead, whereas fewer lines indicate the opposite.

#### Important



#### Changing driver support settings

Make sure that you understand how changing the car's settings affects its behaviour. It is particularly important when it comes to features that affect the level of assistance the car can provide.

1.



Adjust the time interval to vehicles ahead using the buttons on the steering wheel.

- Press the decrease time interval button  to decrease the general distance to vehicles ahead.
  - Press the increase time interval button  to increase the general distance to vehicles ahead.
- > Your new target time interval is shown in the time interval indicator in the driver display.

 **Note**

Higher driving speeds may cause the general distance to a vehicle ahead to be longer than during lower speeds, even if the target time interval is the same. This is because the calculated distance becomes larger for the given time interval.

---

## 10.5.2.8. Selecting Pilot Assist as default driver support

You can select Pilot Assist as your default assisted driving feature in settings.

1. Press the car symbol  in the bottom bar and go to **Settings**.
2. Go to **Driving** → **Pilot Assist** → **Pilot Assist as default**.
3. Select Pilot Assist as your default.

 **Tip**

After selecting Pilot Assist as your default assisted driving feature, you can activate it with the Pilot Assist button  on the steering wheel while driving.

---

## 10.5.2.9. Pilot Assist conditions and limitations

To use Pilot Assist safely, it's important to be aware of its limitations. While it's an advanced function, there are conditions and situations that it cannot handle.

### Driver responsibility when using Pilot Assist

A main limitation of Pilot Assist that you need to be aware of relates to driver responsibility. When using the function, you are still required to actively and attentively drive the car. You are responsible for all decision-making, actions and responses that are part of driving.

Pilot Assist does not know your intentions or the intentions of other drivers. It cannot predict or identify every potentially hazardous situation that an attentive driver can. It's your responsibility to continuously assess Pilot Assist's performance and act if necessary. As long as you judge its input to be correct, you can let it guide your driving.

 **Note**

### Adaptive cruise control conditions and limitations

Conditions and limitations relating to detection capabilities, distance- and speed-keeping are shared between Pilot Assist and adaptive cruise control. The Pilot Assist conditions and limitations related to steering assistance do not apply to adaptive cruise control, as the sub-feature does not provide any steering assistance.

 **Important**

### Driving conditions

Assessing Pilot Assist's performance requires that you take all driving, traffic, weather or road conditions into consideration. For example, if there is poor visibility you may need to increase the distance to vehicles ahead compared to the distance kept by Pilot Assist. The same applies to maintaining a speed that is safe for the current road and traffic conditions.

### Improved convenience

When used correctly, Pilot Assist can reduce the effort of driving. In some cases, it can compensate for driver errors, such as mistakes caused by lapses of attention or distractions. This potential benefit is a supplement to safe driving practices. It does not reduce or replace the need for the driver to stay attentive and focused on driving safely.

### Driver readiness

Using speed- and distance-keeping features can result in long periods of you not using the pedals. However, you must remain prepared and ready to brake or accelerate manually if necessary. Avoid changing your driving posture in ways that can delay your response time.

### Eyes on the road

When using Pilot Assist you must still remain attentive as a driver. This includes keeping track of your surroundings and the traffic around you, just like when driving unassisted.

### Hands on the wheel

Pilot Assist can guide your steering but you are still required to keep your hands on the steering wheel, just like when driving unassisted. As long as you judge the steering input to be correct, you can let Pilot Assist guide your steering.

### Emergency stop with Pilot Assist

The car can initiate a controlled stop if the driver doesn't respond to requests to actively drive the car and keep their hands on the steering wheel. During the stopping manoeuvre, the car utilises all of the information it continuously collects about its surroundings to come to a controlled stop in the lane of the road you're on. It also activates the hazard warning lights to warn other drivers.

You can always override the stop manoeuvre by actively steering, braking or accelerating. This indicates that you are attentive again and available to continue the drive.

## Speed range for Pilot Assist

Pilot Assist is available at different speeds depending on the context of activation and use.

- When using Pilot Assist you can set target speeds between 30-180 km/h (20-110 mph).

- Steering assistance is unavailable at speeds above 140 km/h (87 mph).
- Pilot Assist can be activated above 15 km/h (9 mph), but will then try to accelerate up to the minimum set speed.
- When following another vehicle, Pilot Assist can stay active below 15 km/h (9 mph).
  - In situations where you are driving slowly behind other vehicles, such as in a traffic queue, you may be able to use Pilot Assist despite driving slower than 15 km/h (9 mph). This requires a vehicle ahead whose speed your car can match.<sup>[1]</sup>

## Activation and availability

Several conditions must be met to activate Pilot Assist. They can be related to the current traffic and road conditions or the car's system status. Some are related to the car being driving-ready, such as the driver wearing their seatbelt, keeping their hands on the steering wheel<sup>[2]</sup> and all doors being closed. Others relate to your current driving situation, such as driving at a speed within the speed range for Pilot Assist. If activation is prevented, the specific reason is typically communicated in the driver display.

## Keeping track of vehicles ahead

One of Pilot Assist's capabilities is to adapt the car's speed to a vehicle ahead and maintain a certain distance to it. Pilot Assist's behaviour and ability to track traffic ahead depends on several factors, such as your speed and the speed of the vehicle in front.

Very slow or stationary vehicles in front of you can make Pilot Assist behave differently, depending on the situation and your speed:

- If Pilot Assist follows a vehicle that comes to a stop, Pilot Assist slows your car down to a stop behind the other vehicle.
- If you are driving **below** 70 km/h (44 mph), a stopped vehicle detected ahead of you causes Pilot Assist to slow your car down to a stop behind the other vehicle.
- However, when driving **above** 70 km/h (44 mph), a stopped vehicle detected ahead of you is not treated as a vehicle to follow. Pilot Assist will not slow your car down and will instead try to maintain your set target speed.



### Warning

#### Stopped or slow vehicles ahead

A stopped vehicle in your lane is a collision risk that requires you to act by braking or steering.<sup>[3]</sup>

- At speeds below 5 km/h (3 mph) Pilot Assist may pause when following another vehicle:
  - if there is uncertainty whether what's detected in front is a stopped vehicle or another object<sup>[4]</sup>.
  - if the vehicle ahead makes a turn and leaves your driving path.

## Car status and systems

Pilot Assist relies on the accurate detection and identification of surrounding traffic and road conditions. This includes using information from the cameras, radars and other sensors. The detection system cannot handle all driving, traffic, weather or road conditions. Read the separate manual sections about detection types, how they work and their limitations to better understand how Pilot Assist's performance can be affected.

Several of Pilot Assist's features depend on other systems in the car.

- To adapt the speed to vehicles ahead, the car uses a combination of radar and camera detection. Consequently, conditions and limitations of these systems can affect the availability and performance of this feature.

- Steering assistance is only available when the car can identify its position on the road through camera detection of lane markings.
  - This requires that the road conforms to certain standards.
  - Conditions and limitations of the car's camera detection can affect the availability and performance of steering assistance.

 **Important**

### Car faults

Certain car faults can affect the availability of driver support features. Check the car status view for indicated issues if Pilot Assist is unavailable.

### Car alterations

Modifications, repairs and accessory installations can negatively affect or limit driver support features. There is a separate manual section with detailed information on this topic.

## Other conditions and limitations

- Pilot Assist is primarily intended for use when driving on level road surfaces. It may have difficulty keeping the correct distance to vehicles ahead on steep downhill slopes.
- Pilot Assist with steering assistance is unavailable when driving with a trailer. Heavy or uneven loads may also affect the capabilities and performance of Pilot Assist's steering assistance.
- The performance and capabilities of adaptive cruise control can also be affected when driving with a trailer or heavy loads.

[1] Pilot Assist's lowest target speed is 30 km/h (20 mph), even if your speed at activation is lower than that.

[2] Wearing gloves can sometimes interfere with the hand-detection sensors on the steering wheel

[3] Your car can still warn you of the collision risk and perform a safety intervention if you fail to react in time. This can happen separately from Pilot Assist's capabilities.

[4] Such as obstacles designed to encourage slow driving.

---

## 10.6. Assisted parking

Your car has several features that can help you during parking, such as guidance through camera and sensor views. Learn how to use the different types of assistance.

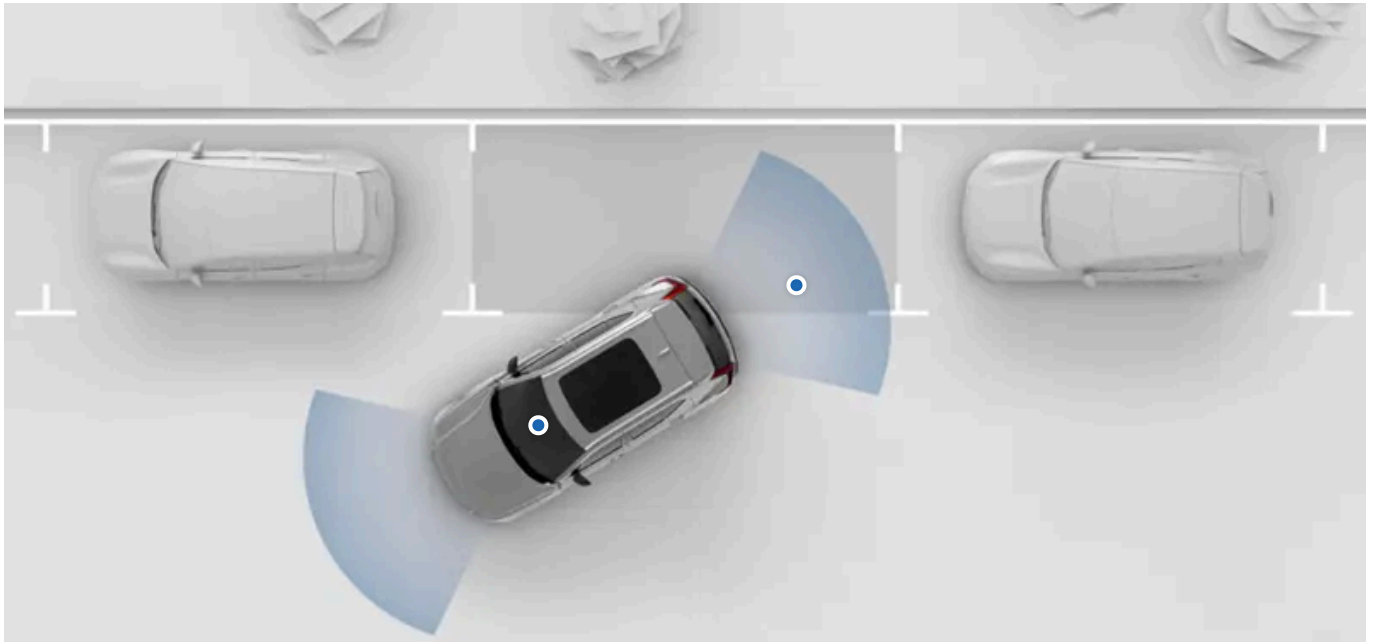

Your car's parking assistance features are available in the centre display's parking view. In most cases, the parking view opens automatically when you need it, but you can also open it manually.

The following parking assistance features are available in the parking view:

<b>Distance and obstacle detection</b>	The car senses the surroundings using many different sensors. It uses this information to guide you with sound, graphics and warnings when driving at low speeds.
<b>Parking camera views</b>	The car shows your surroundings using cameras located around the car.
<b>Automatic braking when reversing<sup>[1]</sup></b>	The car can automatically brake to prevent a collision when reversing. This can happen if it detects an obstacle or crossing traffic behind the car.

 **Important**

### Required knowledge and driver responsibility

Assisted parking features are designed to make driving more comfortable and safer, but they do not reduce the need or responsibility of the driver to operate the car as safely as possible. Be sure to read all related information about a feature before using it. The section covering driver responsibility is essential reading for understanding the capabilities and limitations of your car's assisted driving features.

If you find anything unclear or have further questions, do not hesitate to contact Volvo support.

<sup>[1]</sup> Rear Auto Brake (RAB)

## 10.6.1. Parking view

The parking view contains both camera and parking sensor information to help improve your awareness of the car's surroundings. This can be useful when manoeuvring at low speeds, such as when parking.



The parking view can display two views at the same time. The image shows an example of what it can look like after selecting the rear camera view, which is shown in the bottom half of the centre display. The top half of the display shows an overview of your car's surroundings.

The parking view contains the following features:

<b>Multiple camera views</b>	Selecting a camera view allows you to look at the surroundings in a specific direction. This can provide you with a detailed view in your selected direction.
<b>360 camera view</b>	You can get an overview of your car in its surroundings using the 360 camera view, which also provides visual guidance and obstacle detection.
<b>Parking sensor information</b>	Your car's parking sensors can give you information about your close surroundings. You can get both visual and sound alerts if you are getting too close to an obstacle.
<b>Assisted parking lines</b>	Different camera views can display lines showing you your estimated path. They are adjusted according to how you turn the steering wheel.

You can also enable or disable both the rear auto brake and the sound alerts from the parking sensors in the parking view.

## Accessing the parking view

In most cases, the parking view opens automatically when you need it. You can also access it by opening the camera app in the contextual bar.







When the parking view is open, you can adjust some of the assisted parking settings by pressing the settings symbol  in the top-right corner of the parking view.

The parking view closes automatically when you are driving above a certain speed. After parking, the parking view closes when you turn your car off.

## Camera views

There are several camera views to choose from in the parking view:

-  Front A camera at the very front of the car provides the front view.
-  Sides Cameras on the wing mirrors can provide side camera views to your left or right.
-  360 Opens the 360-view in full screen. The car combines front, rear and side camera views to show the car in its surroundings.
-  Rear A camera at the back of the car provides the rear view.

When using either of the front, sides or rear camera views the parking view can simultaneously show an overview of your car in its surroundings. How this looks in the display changes depending on which camera view is selected.

## Obstacle and distance detection

The parking view can provide visual alerts as well as sound alerts if your car detects any obstacles in your close surroundings.

These alerts change if you go beyond a recommended stopping point. The colour of the visual indication shifts towards red and the sound changes when you get closer to the obstacle.

### Important

#### Driver responsibility

Obstacle and distance detection is a supplement to safe driving practices. It does not reduce the need or responsibility of the driver to operate the car as safely as possible.

The driver is always responsible for paying attention to the car's surroundings and ensuring that it's safe to manoeuvre the car.

#### Detection limitations

The car's obstacle and distance detection capabilities have limitations. Read the separate section covering detection of car surroundings and traffic before using features that rely on these capabilities.

#### Assisted parking faults

If your car detects a fault with the assisted parking system, it will show a message in the driver display, the centre display or both of them. Camera malfunctions may also be communicated with messages or symbols in the parking view.

Contact an authorised Volvo workshop if you cannot address the issue yourself.

### Note

#### Camera calibration

After your car's parking cameras have been serviced, they can sometimes take a while to re-calibrate themselves. This can lead to certain features, such as the parking view, being unavailable for a short time after servicing.

## 10.6.1.1. Disabling assisted parking sound alerts

The sound alerts from the parking sensors can be temporarily disabled in the parking view.

By disabling the assisted parking sound alerts, you stop your car from providing sound alerts if you are getting too close to an obstacle while driving slowly or reversing. Disabling these sound alerts is only temporary. By default, the feature will reset to

**The content of this manual represents the status of the user manual at the time of printing and may not be completely valid in future instances. For more information, refer to the first page for the complete disclaimer note.**

enabled between drives.

 **Important**

### Changing driver support settings

Make sure that you understand how changing the car's settings affects its behaviour. It is particularly important when it comes to features that affect the level of assistance the car can provide.

1. In the parking view, press the parking sensors button.



- > Assisted parking sound alerts are temporarily disabled.

# 11. Scenarios and driving recommendations

The conditions you're experiencing sometimes affect how you can and should use your car. Knowing its capabilities and how you can adapt to the situation can have a significant impact on the outcome. The benefits range from avoiding outright hazards to getting the most out of your car's performance.



This section of the manual will cover specific driving scenarios. These include wading through water and driving on icy roads. Exploring this section gives you a good idea of what features and practices can support you in demanding conditions.

---

## 11.1. Cold conditions

Driving in cold conditions can be tricky. It requires different preparations and a different way of driving than a warmer climate does.

When driving in cold conditions, there are many things to take into consideration. From energy consumption and battery health to a comfortable climate and different safety aspects. Be sure to familiarise yourself with what this way of driving entails, as well as which laws and regulations may apply.

### Visibility

In cold conditions, ice and condensation can obstruct visibility. Your car is equipped with defrosters, a heated rear windscreen and heated wing mirrors to prevent that from happening.

 **Warning**

### Scraping the windscreen

The windscreen area in front of the front-facing camera has its own heating to defrost and remove any build-up of snow or ice. Do not use an ice scraper on this area as it can scratch the glass surface. Scratches or damage to the glass can interfere with or limit the camera's detection capabilities.

## Maintenance

 **Note**

### Tyre pressure

As the temperature drops, the tyre pressure drops. Remember to check the tyre pressure regularly and adjust it as needed.

 **Important**

### Cleaning in front of radars

If you find dirt, snow or ice, or if the car indicates that a radar is blocked, you should address it as soon as possible. Always clean and clear a large area around the radars to make their full field of view available.

## 11.1.1. Winter driving recommendations

There are some things to keep in mind when driving in snow and on ice. Here are some tips and recommendations for safer driving and improved car system effectiveness.

### Preparations for driving in winter conditions

- Use washer fluid with antifreeze to avoid ice forming in the washer fluid reservoir.
- Ensure that the wiper blades are not frozen in place.
- Use engine coolant that contains 50% glycol. This protects the engine against frost down to approximately -35°C (-31°F). To avoid health risks, do not mix different types of glycol.
- Keep the fuel tank filled to prevent condensation.
- Only use engine oil of the prescribed quality. Thinner oils make it easier to start the car in cold weather and reduce fuel consumption while the engine is cold.
- Volvo recommends that winter tyres are used when there's a risk of snow or ice.

 **Note**

In some regions, winter tyres are required by law. However, keep in mind that not all countries allow studded tyres.

## Recommendations for driving in winter conditions

Snowy and icy roads require careful driving different to that of driving on dry roads. There are a number of precautions to take that will help you drive more safely. For example:

- Remove all snow from your car before you start driving, both for your own sake and for your fellow road users. Pay special attention to the sensor areas, lights, roof and bonnet.
- Avoid any sudden steering wheel movements, strong acceleration or hard braking as it can cause the car to lose grip.
- Keep a safe distance from the car in front of you, as you are likely to require a longer braking distance.
- Keep in mind that even if the sun melts the snow and ice, it can still be slippery.
- Even when other roads aren't icy, bridges can still be dangerous.
- Snow and ice can accumulate inside the mudguards, which can affect the steering. Check regularly and remove any snow, ice or debris.
- Braking capabilities can be negatively affected if snow and ice gather in the brake system. Check that the brakes work properly on a regular basis. However, only do so in a safe and careful manner.
- Sometimes, using snow chains can be a good idea. However, be sure to read the instructions on how to use them safely and effectively.

### **Warning**

Avoid parking on inclines during winter conditions. The tyres might lose traction, even if the parking brake is engaged. You are always responsible for safe parking.

### **Tip**

It's a good idea to practise driving on slippery surfaces under controlled conditions to learn how the car reacts. Visit a skidpan if you have access to one.

---

## 11.2. Wading recommendations

When driving through water, there are important limitations to consider regarding the water's depth and the driving speed.

 **Important**

### Avoid wading when possible

Volvo recommends that wading is done with great caution and avoided when possible. It can be difficult to accurately assess the water's depth and the strength of the current. The driver is always responsible for driving in a safe manner and in compliance with all applicable rules of the road.

### Warranty not applicable

Any damage caused by flooding is not covered by the warranty.

### If the engine stalls

Do not attempt to restart the engine if it stalls while wading. Have the car towed to a workshop<sup>[1]</sup>.

- If possible, determine how deep the water is before you start driving. Only attempt to drive through if you are confident it's shallow enough to safely wade through.
- Activate **Off-road** in settings to increase your car's ground clearance.
- The recommended deepest water level when wading is up to 45 cm (17 inches).
- Limit your speed to walking pace.
- Avoid wading in strong currents, especially if the water is deep enough to risk flowing over the car.
- Oncoming traffic can cause waves that increase how high the water reaches.
- If possible, avoid stopping when you're in the water. Carefully keep driving forward or reverse out of it.
- Avoid driving through saltwater as it can cause corrosion.

 **Warning**

### Wet brakes

The car's stopping distance is longer if the brake discs are wet. Driving through water exposes the brake discs to water, and possibly mud or other sediment. After wading, safely perform a hard braking manoeuvre to remove dirt and water from the brakes. By engaging the brake discs while driving, they heat up and dry.

<sup>[1]</sup> Volvo recommends an authorised Volvo workshop.

---

## 11.3. Preparations for a long trip

Before you head out for a long road trip, there are a few things that are good to check.

- Make sure that the brakes work as intended.
- Check the tyres' tread depth and pressure. If there is a risk of snowy or icy roads, change to winter tyres.
- Ensure that the wipers are in good shape and change them if needed.

- Top up the washer fluid.
  - Check that no fluids are leaking from the car.
  - Ensure that the engine is running properly and fuel consumption is normal.
  - Check that the 12 V battery is sufficiently charged.
  - Make sure that useful equipment is in place, such as a puncture repair kit, first aid kit, a warning triangle and a reflective vest.
  - If you plan to visit a region that uses different units of measurement, such as miles or kilometres per hour, you can change the car's unit settings.
  - If you plan to visit a region with a different driver's side to your own, the exterior lights need to be altered. Make sure you familiarise yourself with how the car can reorient the exterior lights to match the driving situation.
  - If driving to a region with other traffic laws, make sure the car is equipped as required and read up on what rules of the road differ from what you're used to.
  - Remote areas may have bad or no internet connection. If you plan to drive in these areas, download the maps you need in the navigation app to be able to use them when your car is offline.
-

## 12. Storage, stowing and towing

Your car is designed to transport people as well as luggage and other cargo. Learn about the car's stowing and towing capabilities.



Your car's passenger compartment and boot have several areas for stowing items of different shapes and sizes safely.

The boot can be expanded to create more space for larger cargo.

You can also use the roof for transporting heavy cargo and, with a towbar, you can attach a trailer.

### **Warning**

It is important to properly store objects, even small items. Objects that are not stowed securely can be dangerous in the event of sudden braking or a collision.

Adding cargo to the car changes the car's weight and driving control properties. Always refer to the car's permitted weight regulations and guidelines.

Before towing a trailer, ensure that all connectors and safety attachments are secured. Also, be sure to follow local regulations regarding towing.

### **Important**

Large and heavy loads on the roof may interfere with car sensors.

### 12.1. Passenger compartment storage

The content of this manual represents the status of the user manual at the time of printing and may not be completely valid in future instances. For more information, refer to the first page for the complete disclaimer note.

Find where the storage locations are in the passenger compartment.



- ① Door panel storage compartments
- ② Pockets on the front seat backs
- ③ Tunnel console
- ④ Glove box

## 12.1.1. Glove box

You can store items that you don't immediately need in the glove box.

In the event of sudden braking or a collision, loose items can be hazardous. The glove box is useful for storing small items safely and securely.



The glove box is located in the dashboard in front of the passenger seat.

The hook on the glove box can be folded out when the glove box is open. You can then close the glove box and hang items on the hook.

## 12.2. Boot space and storage

The boot can be configured to accommodate cargo of different shapes and sizes.

You can adapt the boot in different ways and expand it to create a larger cargo space. This can be useful for storing larger items.



- ① Ski hatch
- ② Foldable rear seats
- ③ Cargo hold

Folding down the rear seats is ideal for loading large objects. Install a safety net when doing so to prevent objects moving into the front passenger compartment.

You can use the ski hatch when loading long, thin objects, such as planks of wood or skis, inside the car. This way, you don't need to fold the seats down.

The cargo hold is accessed via the underfloor hatch. It's useful for protecting items and storing the parcel shelf.

The parcel shelf can be removed to give you more space in the boot. It can be conveniently stored under the cargo hatch.



Tip

### Adjust boot opening height

You can adjust how much the boot hatch opens. This can be useful when you're parked in places with a low ceiling, such as a garage, and you want to reduce the boot opening height. You can also raise the boot opening height to create more room for accessing the boot.

## Stowing cargo securely

You can also find options for stowing cargo securely to ensure that it doesn't move around the boot while you are driving.

---

## 12.2.1. Parcel shelf

The parcel shelf can be used to hide items in the boot from view.

There are two attachment points on the parcel shelf itself and two on the boot hatch. Cords run between attachment points.

You can remove the parcel shelf to create more space for larger items in the boot and expand the boot area.

### Warning

#### Child restraints

Take care to keep the parcel shelf and objects in the boot clear from the top tether straps of a child restraint. Contact with the straps can cause damage. Never use the child restraint if the top tethers are damaged in any way. When using a child restraint on the rear seats, remove the parcel shelf or detach it and keep it secure in the cargo area. Furthermore, secure all objects in the boot.

### Important

- Do not place anything on the parcel shelf. In the case of sudden braking or a collision, loose objects can move abruptly and cause injury.
- Do not leave the parcel shelf in the car when it is not properly secured.
- When folding the rear seats down, first remove the parcel shelf.
- When placing tall objects in the boot, it's best to remove the parcel shelf. This is because the shelf is attached to the boot hatch and lies flat when the hatch is closed. If a tall object gets in the way of the parcel shelf, it can damage the shelf.

---

### 12.2.1.1. Removing and storing the parcel shelf

The parcel shelf can be removed to give you more space in the boot. It can also be stored conveniently under the cargo hatch to save space for other items in the main boot area.

You can use the parcel shelf to hide items in the boot from view.



There are two attachment points on the parcel shelf itself and two on the boot hatch. When the parcel shelf is attached, cords run between attachment points on the parcel shelf and the boot hatch.

The cords have loops at each end that you hook onto the boot hatch attachment points.

#### Removing the parcel shelf

1. Detach each cord from the boot hatch attachment points.
  - > The shelf is loose but lies flat in the same position.
2. Lift the shelf from the hinges at the back, near the rear seats.
3. Carefully move the parcel shelf towards you until it is completely removed from the boot.

#### Storing the parcel shelf

4. Grasp the cargo hatch handle and lift the hatch upwards.



Place the parcel shelf with its top facing down and the rear part facing forwards.

6. Close the cargo hatch.

 Tip

To install the parcel shelf again, follow the removal and storage steps in reverse order.

## 12.2.2. Removing the cargo hatch

You can make the boot space bigger and access the cargo hold more easily by removing the cargo hatch.

Removing the cargo hatch allows you to enlarge the boot space.

Clear all items from the boot to ensure that nothing will get in the way when you fold down and remove the cargo hatch.

1. Grasp the cargo hatch handle and push the hatch towards the rear seats so that it folds.



Folded cargo hatch.

2. Push the left-hand-side locking clip forwards and, at the same time, lift the folded cargo hatch slightly.

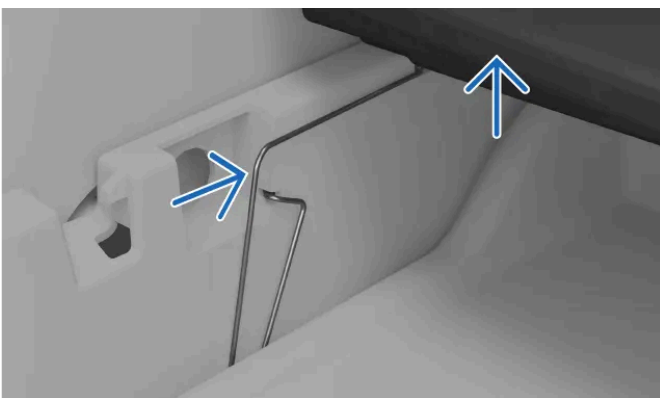

Left-hand-side locking clip.

3. While continuing to hold the cargo hatch up, push the right-hand-side locking clip forwards.

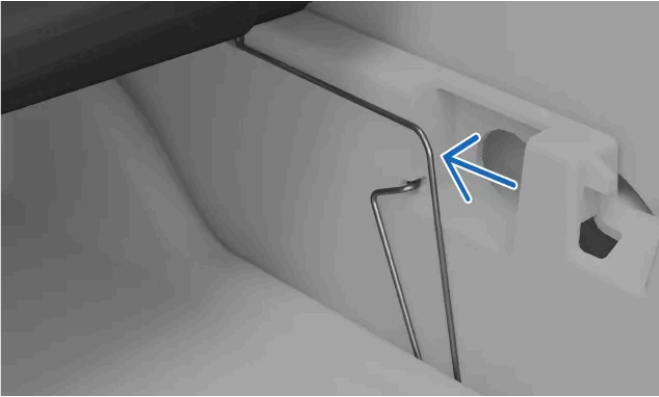

Right-hand-side locking clip.

4. When the cargo hatch is free from the hinges and fully loose, you can pull it out from the boot.



Cargo hatch released.

Place the cargo hatch where it can't get damaged or fall.

---

## 12.2.3. Installing the safety net

The safety net can be installed behind the front seats or the rear seats.

### **Warning**

There should be no occupants in the car to the rear of a safety net. A safety net can interfere with safety features such as airbags.

### **Important**

Do not use the safety net to secure large or heavy objects. Secure any large or heavy cargo with straps using the load retaining eyelets located around the rear interior of the car.

When a safety net is in place behind a retractable seat, be careful not to recline or reposition the seat too far back.

When installing the safety net, make sure it is the right way round. The tightening straps should always be on the side facing you.

#### Installing behind front row seats

1. Remove the coat hooks from their sockets by twisting the hooks. Store them in a safe place for when you need the hooks again.
2. Insert each pin of the safety net into a coat hook socket. Push the pins forwards until they lock into place.



3. Fasten the lower corners of the net to the outer tether points behind the seats.

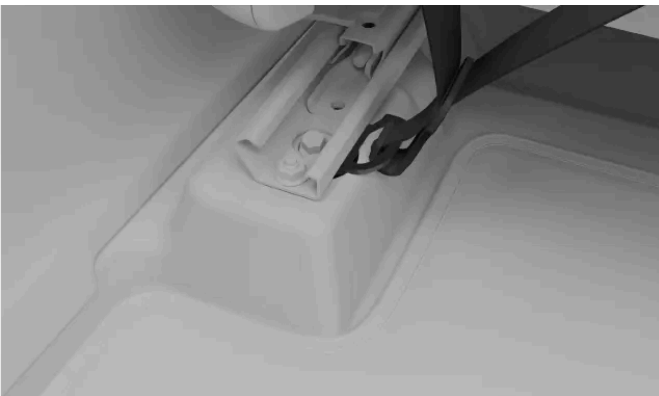

4. Tighten the straps to make the safety net tight and more secure.
- > The safety net is attached at all four points.

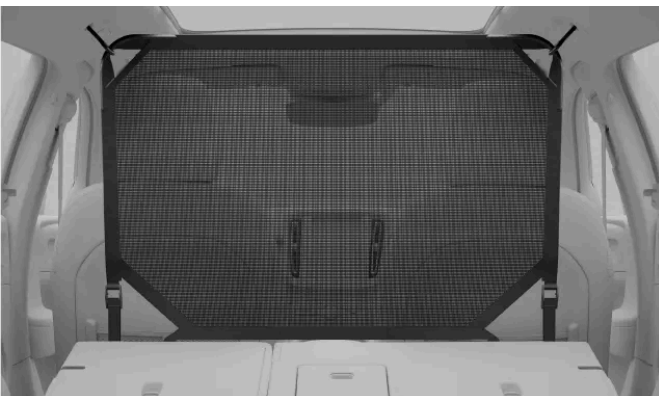

#### Installing behind second row seats

5. Insert each pin of the safety net into a coat hook socket. Push the pins forwards until they lock into place.



6. Fasten the lower corners of the net to the load-retaining eyelets behind the seats.



7. Fasten the lower corners of the net to the load-retaining eyelets behind the seats.



8. Tighten the straps to make the safety net tight and more secure.

> The safety net is attached at all four points.





Tip

### Removing the safety net

To remove the safety net, follow the installation steps in reverse order.

---

## 12.2.4. Opening the ski hatch

You can use the ski hatch when loading long, thin objects, such as planks of wood or skis, inside the car. This way, you don't need to fold the seats down.

The ski hatch is located in the middle of the rear seats. You can access it via the boot or the passenger compartment.



Warning

Any objects placed in the rear of the car must not be in contact with the front seats. This can impede the safety of other occupants.

1. Open the boot and grasp the handle located in the middle of the rear seats.
2. Pull the handle and fold the hatch down.
3. Go to the back of the passenger compartment and fold the rear seat armrest forward.

Make sure nothing is obstructing the hatch opening.

---

## 12.2.5. Stowing cargo in the boot

The boot has a number of options for storage.

The boot has several useful features to help you stow things away and secure items.

The boot has several features to help stow items. These include:

- Bag hooks for preventing shopping bags from falling over. They are located on the side panels and under the cargo hatch.
- Storage pocket in the side panel.

There's also a cargo hold under the boot floor where you can store tools and equipment. To access it, open the hatch in the boot floor.



Tip

In your boot, you can find a 12 V socket. It can be useful for powering various electrical devices, such as a cooler box.

## 12.2.5.1. Accessing the cargo hold

You can access the cargo hold under the floor in the boot.

The cargo hatch has two sets of hinges – one set at the back edge and a second set in the centre fold. This allows you to fold the hatch in the middle for two different configurations.

You can increase the space in the boot by fully pushing the hatch away from you and flattening it.

If the hatch is opened and folded by using the hinges in the middle, the hatch can be propped up vertically and used as a partition wall.

Move any items in the boot towards the back. Make sure they do not cover the cargo hatch.

### Opening the cargo hold hatch

1. Grasp the hatch handle. It is located in the middle, near the outer edge.
2. Pull the hatch up and push it away from you.

### Boot partition

3. Fold the hatch at the middle hinges.
4. Position the hatch in a standing vertical position.

>

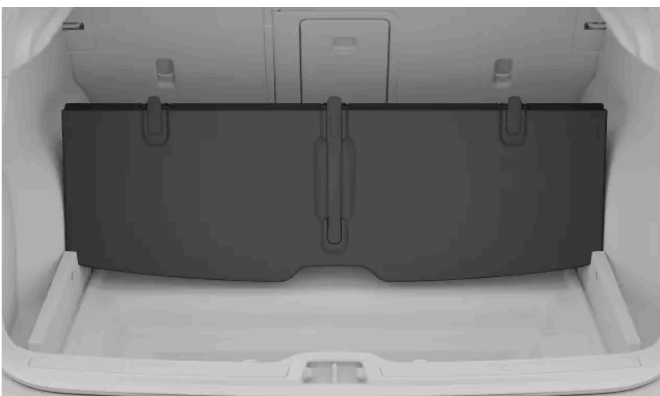

The boot partition.

The folded hatch forms a partition wall, separating items at the back from the front of the boot.

 **Tip**

The cargo hatch is sturdy and is useful for protecting objects.

You can hang bags and other items from the hinges at the centre fold.

When the hatch is fully retracted and folded flat, you can store the parcel shelf in the cargo hold and then fold the hatch back down to cover it.

## 12.3. Towing a trailer

The towbar allows you to tow a trailer with your car. Be sure to familiarise yourself with towing features and any relevant safety issues.

Before towing a trailer, consider how this will affect your journey. Make a thorough assessment based on your car's capabilities.

- Keep in mind that the car performs differently with added weight at the rear. This affects both handling and power usage. Expect a notable reduction in range when towing a trailer.
- Only use trailers in good working condition that comply with local regulations.
- Make sure you have read the separate section covering loading recommendations.

 **Note**

### Maximum permitted trailer weights

The stated maximum permitted trailer weights are those permitted by Volvo. National vehicle regulations can further limit permissible trailer weights and speeds. Your towbar may be certified for a higher towing weight than the car can actually tow.

#### Towing preparations

1. Increase the tyre pressure to the recommended pressure for a full load. This applies regardless of the trailer weight.
2. Deploy the towbar and attach the trailer.
3. It's advisable to check that the trailer lights are in good working order.

#### Driving with a trailer

4. Read the recommendations for driving with a trailer thoroughly before you start driving.

## Important

### While driving

- Maintain a low speed when driving with a trailer up long, steep ascents.
- Avoid driving with a trailer on inclines of more than 12%.
- The additional load increases the risk of overheating, which will be indicated in the driver display. Follow any instructions shown.
- Avoid parking on an incline if possible. The extra weight of the trailer can affect the parking brake's ability to securely hold the car. If you cannot avoid parking on an incline, be sure to block the wheels<sup>[1]</sup> as a precaution.

### Snaking

Snaking is a phenomenon that can occur when towing a trailer. It causes the car and trailer to resonate in a side-to-side motion, which can escalate quickly and cause loss of control. Snaking primarily occurs at high speeds, especially if the trailer load is too heavy or improperly distributed. The car continually monitors its movement and can intervene to help the driver regain control if it detects snaking.

Factors that introduce sideways motion can trigger snaking. For example:

- Sudden gusts and powerful side winds.
- Uneven road surfaces.
- Sweeping steering wheel movements from side to side.

### Trailer stability assistance

The stability control system<sup>[2]</sup> intervenes if it detects snaking when towing a trailer. The system precisely times individual braking actions for the front wheels to mitigate the snaking phenomenon. This is often enough to help the driver stabilise the car and trailer.

When the stability control system intervenes to suppress snaking, the electronic stability control symbol is shown in the driver display.



Electronic stability control symbol

### Interventions and warnings when reversing

The car can automatically brake to prevent a collision when reversing if it detects an obstacle or crossing traffic behind the car. Interventions and warnings when reversing are disabled when towing a trailer.

## Note

If you've had the towbar installed after purchasing your car, a system update may be needed for the towing features to work. Contact a Volvo dealer to update the software.

<sup>[1]</sup> If you do not have wheel chocks, you can use large stones or wooden blocks instead.

## 12.4. Recommendations for loading

Proper loading is important for safety and your car's performance on the road.

### Loading in general

Load weight and placement affects the car's centre of gravity, handling and performance.



#### Warning

##### Unsecured loads

A loose object weighing 20 kg (44 pounds) can, in a frontal collision at a speed of 50 km/h (30 mph), carry the impact of an object weighing 1,000 kg (2,200 pounds). Always follow the loading recommendations to reduce the risk of material damage or personal injury.

- Place heavy cargo as low as possible.
- Do not stow cargo where it may obstruct airbag deployment. If stacked cargo reaches above the upper edge of the windows, be sure to have at least 10 cm (4 inches) of clear space between the window and the cargo. Otherwise, the intended protection of the inflatable curtain, which is concealed behind the panels above the windows, may be compromised.
- Always comply with the car's specifications regarding weight and maximum permitted load.
- When loading the boot, position the cargo firmly against the rear seats' backrests.
- Large objects placed in the boot can obscure the driver's view through the rear windscreen.
- Avoid placing cargo against the back of the front seats. It may compromise the effectiveness of the front seat whiplash protection.
- Cover any sharp edges, corners and protrusions.
- Make sure that all cargo is secure for the duration of travel. You need to regularly check and re-tighten the straps as cargo can move during transit.
- Remove cargo you no longer need to have in the car. Reducing the car's overall weight improves both performance and range.

### Roof loading



#### Important

Any loads on the roof should not extend above the windscreen. This can interfere with car sensors.

Use a load carrier recommended by Volvo when carrying loads on the car's roof. This reduces the risk of damage to the car and helps ensure safety while travelling. Carefully follow the mounting instructions supplied with the load carriers.

Exterior loads affect the car's aerodynamics, handling and sensitivity to crosswinds. Increased drag affects energy consumption and range.

- Place heavy cargo as low as possible.
  - Distribute the load evenly across the load carriers.
  - For long loads that extend over the bonnet, fit the towing eye at the front of the car and use it to secure the load.
  - Drive gently. Avoid heavy acceleration or braking, and sharp cornering.
  - Remove the load carriers when you are not using them. It improves both performance and range.
-

## 13. Care and maintenance

Keep the interior and exterior of your car in good condition with regular care and maintenance.



This section of the manual covers regular care and cleaning you can do yourself, information about some of your car's components that have specific maintenance needs and service maintenance information.

### Note

#### Volvo's service programme

Adhering to your car's service programme is highly recommended. A car in good condition contributes to traffic safety and operational reliability.

### 13.1. Car status

The car status view in the centre display is a useful aid for keeping track of your car's health. This is where the car shows you information about any detected issues.

The car status view shows a visual overview of your car and lists any detected issues. The issues are classified depending on severity. A minor issue may be something you can sort out on your own, such as refilling washer fluid. A critical issue may require a workshop visit before you can safely drive the car again. It's recommended to address issues as soon as they appear, especially if they're not minor.

**!** Important

The car is unable to detect and identify all types of issues that can occur. It is therefore important to regularly inspect the car's condition and address any service or maintenance needs you identify. Contact an authorised Volvo workshop for guidance if you are unsure of an issue's severity, regardless of whether it is indicated by the car or not.

To open the car status view, press the car symbol  in the bottom bar and go to **Status**.

## 13.2. Exterior cleaning and care

Keep your car's exterior in good condition by getting rid of dirt and taking care of any paintwork scratches as soon as you notice them. Ensure good visibility by keeping wiper blades in good condition.



Wash your car regularly, top up the washer fluid when needed and replace the wiper blades when they get worn. Taking care of your car's exterior doesn't just make it look nice, it also keeps your car in good condition.

### 13.2.1. Washing the exterior by hand

To avoid problems with cleaning ingrained dirt, wash the car regularly and as soon as it starts getting dirty. It reduces the risk of scratches and, of course, keeps your car looking good.

 **Important**

### When and where to clean the exterior

- Clean your car as soon as it has attracted dust or dirt. This prevents the build-up of ingrained dirt, which often contains larger particles and debris that cause wear and damage, especially during cleaning.
- Remove bird droppings and tree sap or resin as soon as possible. These contain substances that can quickly damage and discolour the paintwork.
- Avoid washing your car in direct sunlight. This can cause cleaning agents or wax to dry out and act as abrasives.
- If the car has been exposed to corrosive substances, such as acid rain, salt, chemicals, iron powder, soot or ash, it needs to be cleaned as soon as possible to prevent damage. In areas with a lot of industrial emissions, more frequent washing is recommended.
- Clean the car in a dedicated cleaning area that collects the wastewater and make sure the water is treated according to environmental regulations. Make sure that there is an oil separator in the cleaning area.

### High-pressure washing

- Make sure that doors, windows, hatches and the panoramic roof are closed.
- Use a circular motion and keep the nozzle at least 30 cm (1 foot) from the car's surface.
- Do not spray directly onto openings or sensitive areas such as locks, cameras, trim, air intakes or the fuel filler flap.

 **Note**

- Be gentle and use the right cleaning equipment for the type of surface you are washing.
- Only use cleaning agents and car care products recommended by Volvo, and follow each product's accompanying instructions.

### Full exterior washing

1. Start by rinsing the underbody, including the wheel housings and bumpers.
2. Rinse the entire car to dissolve and wash away dirt. For particularly dirty surfaces, you can use a cold degreasing agent.
3. Then use a sponge, car shampoo and plenty of lukewarm water to wash the entire car.
4. Dry the car with a clean, soft chamois cloth or a gentle squeegee. This reduces the risk of stains from dried water droplets, which require additional polishing.
5. Remove dirt from the drainage holes in the doors and clean out the door sills after washing the car.
6. If any bitumen stains from the road surface tarmac remain, use a tar remover to get rid of them.

If there are particularly stubborn dirt patches or if you don't get the desired result when cleaning your car, contact Volvo support for advice.

## 13.2.2. Washing the car in an automatic car wash

Volvo recommends that you wash the car by hand so that you can properly reach all parts of the car. However, an automatic car wash is a simple way to quickly clean your car as soon as it gets dirty.

### Note

Volvo recommends that you do not use an automatic car wash during the first few months, when the car is still new. This allows the paintwork to harden properly.

### Important

#### Before using an automatic car wash

- Make sure that doors, windows, hatches and the panoramic roof are closed.
- Reduce the alarm sensitivity if you won't be inside the car while it's being washed.
- Change wiper mode to off.
- Secure any auxiliary lights.
- Activate air recirculation.
- Disable auto hold so that the car does not automatically brake or give unnecessary warnings.
- Open the parking view.

1. Follow the instructions to drive into the automatic car wash and stop at the designated location.
2. If you are using a tunnel car wash:
  - Put the gear in N and take your foot off the brake. Turn the car off but do not apply the parking brake.If you are using a rollover car wash:
  - Put the gear in P to engage the parking brake.
3. When the wash is complete, follow the instructions and drive out.
4. Be sure to reset any functions you changed before you drove in.

### Warning

Always test the brakes after washing, including the parking brake. This helps prevent moisture from causing corrosion, which could reduce the brakes' performance.

If there are particularly stubborn dirt patches or if you don't get the desired result when cleaning your car, contact Volvo support for advice.

---

## 13.2.3. Polishing and waxing

If your car loses its lustre, it's time for a new coat of polish and wax. This gives the paintwork extra protection.

Feel free to wax your car whenever necessary, but you shouldn't need to polish it during its first year.

### Important

#### Be careful

- Do not polish or use products intended for high-gloss paintwork on surfaces that have matte paintwork. This may create a permanent gloss on the surface.
- Polishing glossy trim mouldings could wear away or damage the glossy surface layer.
- Avoid using polish or wax on rubber and unpainted plastic components.

Contact Volvo support for information on recommended cleaning agents and car care products.

1. Make sure the car is protected from direct sunlight. The surface should be no more than 45 °C (113 °F) when applying polish or wax.
2. Wash and dry the car thoroughly.
3. First polish the car, then wax it. Follow the instructions on the packaging carefully. Many products contain both polish and wax.

---

## 13.2.4. Touching up paintwork damage

Taking care of your car's paintwork helps to maintain the exterior. Inspect it regularly and repair damage straightaway to avoid further problems.

Common damage that may occur includes stone chips, scratches and marks along the edges of doors or bumpers.

### Important

Paintwork damage in front of a radar can affect the radar's detection capabilities. Contact a service point for repairs if you find any damage close to the radars.<sup>[1]</sup> If you're unsure about where your car's radars are, you can find an overview of their locations in a separate section of this manual.

 **Note**

Paint batches and brands may differ slightly in colour even if the colour code is the same. Therefore, even though you can touch up paintwork damage on your own, Volvo recommends that you always contact an authorised Volvo workshop to get help with any paintwork damage.

- Contact a Volvo dealer for recommendations on touch-up pens and spray paints.
  - The surface must be clean and dry before doing any touch-ups.
  - The temperature of the surface should be at least 15 °C (59 °F).
  - Follow the instructions for the touch-up pen or paint you're using.
1. Apply masking tape over the damaged area. Then peel it off to remove all loose paint.
  2. If there are uneven edges, you may need to gently polish around the damaged area using a very fine abrasive cloth. Clean the area thoroughly afterwards and let it dry.
  3. If the damage:
    - has not reached the metal and an undamaged layer of paint remains, you can apply touch-up paint directly to the cleaned surface.
    - has reached the metal, first use a primer.
    - is on a plastic surface, first use an adhesive primer for better results. Spray into the lid of the spray can and brush on a thin layer.
    - is a long scratch, use masking tape around the damaged area to protect the undamaged paintwork.
  4. Stir the primer thoroughly and apply with a fine brush, matchstick or something similar. Let it dry.
  5. Finish with a basecoat and clearcoat.

<sup>[1]</sup> Volvo recommends an authorised Volvo workshop for all servicing and repairs.

---

## 13.2.4.1. Finding the paint colour code

You can find the car body paint colour code on the product label located on a pillar between the front and rear doors.

If there is damage to your car's paintwork, or it needs repairing or repainting, you need to know the exact colour of the paint.

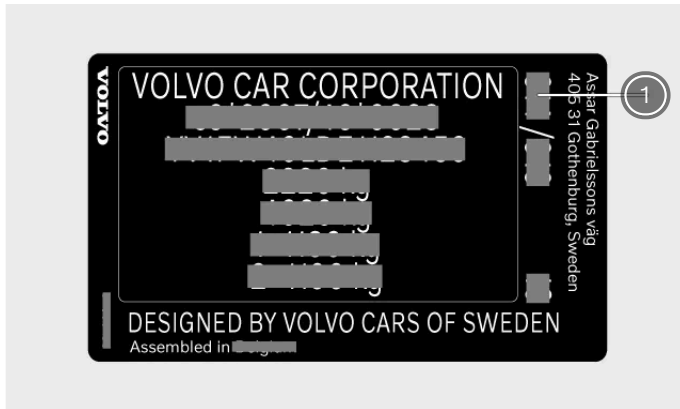

① Paint colour code

1. Go to the right-hand side of the car.
  2. Open the front and rear doors.
  3. Find the door pillar located between the front and rear doors.
- > The product label containing the colour code is located on the outer side of the door pillar, near the bottom of it.

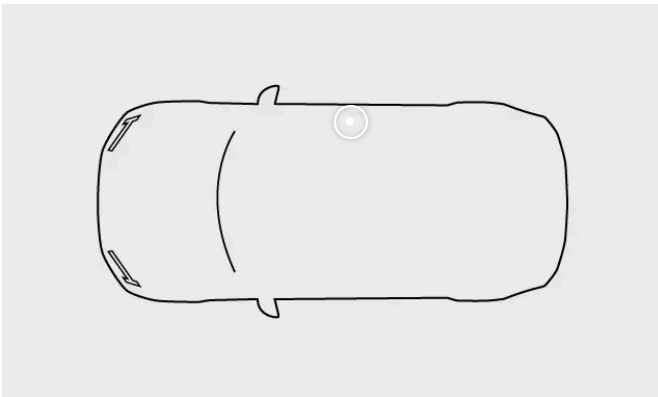

---

## 13.2.5. Windscreen damage

It's important to repair a damaged windscreen as soon as possible. If you take immediate action, minor chips and cracks can often be repaired without replacing the entire windscreen.

### Small cracks or chips

Small windscreen cracks or chips can quickly spread, turning it from minor to severe damage. Contact an authorised Volvo workshop if you notice glass damage. Repair the windscreen as soon as possible.

 **Important**

### Camera and sensor area

Any windscreen damage in the camera and sensor area, including small chips, scratches or cracks, can negatively affect forward detection and features that use it.

- Any windscreen damage in this area requires inspection by a service technician.
- Volvo recommends not repairing small damage in the camera and sensor area. Instead, the entire windscreen should be replaced.

## Severe glass damage

If the windscreen suffers severe damage, the entire glass panel needs to be replaced.

 **Warning**

### Compromised safety

Do not drive the car if there is structural damage to the windscreen. Weakened glass can degrade very quickly, impair visibility and seriously compromise safety.

 **Note**

### Compatibility of new windscreen

It's important that the new windscreen and its installation meet Volvo's specifications for safety and compatibility with the car's features.

### Calibration

When a windscreen is installed, the forward-facing camera behind the glass requires function checks and calibration by a service technician to ensure that it works correctly.

## 13.2.6. Refilling washer fluid

The washer fluid reservoir cap is located under the bonnet. Be sure to use good quality washer fluid.

The car notifies you when the washer fluid level is getting low.<sup>[1]</sup>

 **Note**

### Reservoir capacity

Your car can hold 10.2 litres (approximately 10.8 US quarts) of washer fluid.

 **Important**

### Washer fluid quality

- Use washer fluid with a pH between 6 and 8.
- If you use concentrated washer fluid, dilute it as instructed on the packaging and use clean pH-neutral water.
- Volvo recommends washer fluid with frost protection in cold conditions, especially in temperatures below freezing. This is to prevent damage caused by the fluid freezing inside the pump, reservoir and hoses.

1. Open your car's bonnet.



Locate the blue cap with the washer fluid symbol and open it.

3. Pour the washer fluid into the reservoir. Avoid spillage if possible.

4. Close the cap and bonnet.

<sup>[1]</sup> When there is about 1 litre (1 quart) left.

---

## 13.2.7. Cleaning wipers

Dirt, dust, sand, insects and different weather conditions are just a few of the things your wipers take care of. It's important to clean your wipers regularly to maintain good visibility and prolong the blades' service life.

1. Activate the wiper service position via settings in the centre display. This gives you better access to the front wiper blades.
2. Rinse the area with water to get rid of any loose dust and dirt.
3. Use a soft sponge with a lukewarm soap solution or car shampoo to clean the area. Lift the wiper arms from the windscreen for better access.

4. Use a clean, soft cloth to dry the wipers.
5. Make sure the wiper arms are folded back down against the windscreen, and then deactivate the wiper service position.

**!** Important

Test the wipers before driving. Use plenty of washer fluid when the wipers are in motion. The windscreen must be wet for the wipers to work properly.

## 13.2.8. Replacing front wiper blades

Your front wiper blades' service life is affected by the water, dirt and debris that they sweep off your windscreen. The wiper blades need to be replaced when they show signs of wear.

1. Activate the wiper service position via settings in the centre display.

2.



Fold the wipers up and away from the windscreen.

3.



The content of this manual represents the status of the user manual at the time of printing and may not be completely valid in future instances. For more information, refer to the first page for the complete disclaimer note.

Press the button on the wiper arm and remove the wiper blade by pulling it upwards.

4.

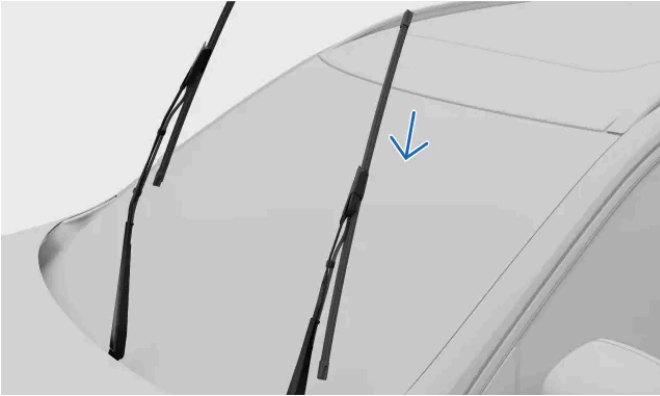

Make sure that the blade for the driver side is longer than the blade for the passenger side. Slide the wiper blade onto the wiper arm. Ensure that the pin on the wiper arm goes into the hole on the wiper blade. Push the blade into the wiper arm until you hear a click sound.

5. Check that the blade is firmly attached.
6. Fold the wiper arms back down against the windscreen.
7. Deactivate the wiper service position.

---

## 13.2.9. Replacing the rear wiper blade

Your rear wiper blade's service life is affected by the water, dirt and debris that it sweeps off your rear windscreen. The wiper blade needs to be replaced when it shows signs of wear.

1.

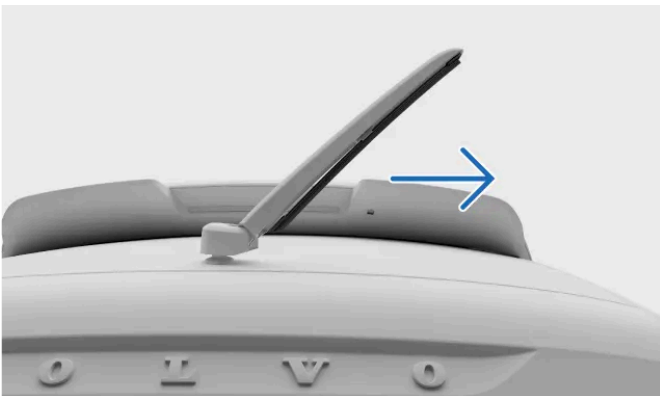

Grasp the centre of the wiper arm and lift it up and away from the rear windscreen. You may feel some resistance halfway – this is the lock position. You need to pull the wiper arm past the lock position so that it doesn't fall back onto the windscreen.

2. Pull the lower part of the blade away from the wiper arm until it loosens.
3. Press the new blade into place until you hear a click.

4. Check that the blade is firmly attached to the wiper arm.
5. Fold the arm back down against the windscreen.
6. Connect the wiper blade's hose to the hose connector. Lower the plastic cover back down.

 **Note**

Make sure that the hose is positioned in such a way that it won't become trapped or pinched when the plastic cover is lowered back down.

---

## 13.2.10. Activating the wiper service position

The wiper service position allows you to clean or replace the front wiper blades. When activated, the wipers move to a more accessible position on the windscreen.

1. Press the car symbol  in the bottom bar and go to **Settings**.
  2. Go to **Controls** → **Mirrors and wipers** → **Wipers** → **Wiper service position**.
  3. Activate the service position.
- > The wipers move to a more accessible position and can be lifted up from the windscreen for servicing.

 **Important**

### Fold the wipers down

Be sure to fold the wipers back down against the windscreen after servicing them. Activation of the wipers when they are in an elevated position can damage the car.

Once you have folded the wipers back down, deactivate the service position. This can be done by either of these options:

- The setting in the centre display.
- Start driving.
- Start using the wipers or washers.

---

## 13.2.11. Corrosion protection

A good way to reduce the risk of corrosion is to keep your car clean. Your car also has durable corrosion protection.

Normally, the corrosion protection doesn't require maintenance apart from regular cleaning and washing, which removes corrosive substances. Avoid using strong alkaline or acidic cleaning solutions on glossy trim components as they can cause corrosion. Road surfaces with gravel or small stones can lead to paint chips that can act as entry points for corrosion. Deal with such damage as soon as you notice it.

The car body's corrosion and abrasion protection consists of:

- protective coatings, both on the sheet metal and applied in a high-quality painting process
- shielding with plastic components
- corrosion-resistant cast aluminium used for exposed components of the wheel suspension.

---

## 13.3. Interior cleaning and care

Keep the interior of your car in good condition by taking care of its materials and keeping them clean.



Use the passenger compartment's storage areas and the cup holders to keep your car tidy. Always take care of stains and dirt as soon as you notice them to avoid permanent staining.

If there are particularly stubborn dirt patches, or if you don't get the desired result when cleaning your car, contact Volvo support for advice.

---

### 13.3.1. Cleaning fabrics and textiles

If you get a stain on the car's interior, such as on the headlining or seat upholstery, clean it as soon as possible.

These recommendations apply to various interior fabrics, including Tailored knit.

 **Important**

### When cleaning textiles

- Never scrape or rub dirty surfaces. Instead, use gentle circular motions. Remember that sharp objects or abrasive materials can damage the car.
- Always clean the entire upholstery. Cleaning only spots on the upholstery can leave water rings or other marks.
- Do not remove surface upholstery during cleaning.
- Certain clothes, such as jeans or suede, can discolour the textile upholstery.
- Be careful when cleaning the headliner as harsh treatment may damage it.
- Only use cleaning agents and car care products recommended for cleaning textiles, and follow each product's accompanying instructions.

 **Warning**

### Seats with side airbags

Never spray a cleaning agent directly on the sides of seats with side airbags. Instead, wipe them clean with a cloth lightly dampened with a suitable cleaning agent.

1. Vacuum clean or dust off the area to remove loose dust and dirt.
2. Clean the area with a neutral-coloured, clean and lint-free microfibre cloth that is lightly dampened with water or a colourless, mild cleaning agent. Use gentle circular motions.

 **Tip**

To wash the textile upholstery, an upholstery cleaning machine is recommended for extracting the cleaning solution and performing a water rinse.

3. Let the material dry fully before use.

 **Important**

### Cleaning seatbelts

When cleaning a seatbelt, keep it extended until fully dry.

---

## 13.3.2. Cleaning leather or vinyl

The leather and vinyl in your car can be impacted by dirt and coloured garments over time. You need to clean and treat the surface to make it more resistant to damage.

These leather cleaning recommendations only apply to real leather details.

 **Important**

### When cleaning upholstery

- Never scrape or rub dirty surfaces. Instead, use gentle circular motions. Remember that sharp objects or abrasive materials can damage the car.
- Do not use a steam cleaner on leather.
- Do not remove surface upholstery during cleaning.
- Do not use leather and vinyl cleaner on textile surfaces.
- Only use cleaning agents and car care products recommended by Volvo, and follow each product's accompanying instructions. Contact Volvo support for more information.

 **Warning**

### Seats with side airbags

Never spray a cleaning agent directly on the sides of seats with side airbags. Instead, wipe them clean with a cloth lightly dampened with a suitable cleaning agent.

1. Vacuum clean or dust off the area to remove loose dust and dirt.
2. Use a neutral-coloured, clean micro fibre cloth lightly dampened with cleaning agent and clean the area with gentle circular motions.
3. Let the upholstery dry fully before further use or applying any treatments.

---

## 13.3.3. Cleaning glass and glossy surfaces

Clean surfaces such as displays, mirrors and touch buttons regularly and gently.

 **Important**

### When cleaning glass and glossy surfaces

- Do not scrape or use any abrasive cleaning agent on displays, mirrors and touch buttons. This can damage the reflective surface.

1. Vacuum clean or dust off the area to remove loose dust and dirt.
2. Use a clean microfibre cloth lightly dampened with water and clean the area with gentle circular motions.
3. Let the surface dry fully before use.

---

## 13.3.4. Cleaning interior plastic, metal and wood components

Clean panels and controls regularly, and deal with stains straightaway.

 **Important**

### Be gentle

Never scrape or rub dirty surfaces. Instead, use gentle circular motions. Remember that sharp objects or abrasive materials can damage the car.

1. Vacuum or dust the area to remove loose dust and dirt.
2. Use a clean microfibre cloth lightly dampened with water and clean the area with gentle circular motions.

 **Important**

Never spray fluids directly on electrical components, such as buttons or controls.

3. Let the material dry fully before use.

---

## 13.3.5. Cleaning mats

Clean the mats regularly and always make sure they are properly in place.

 **Important**

**Be gentle**

Never scrape or rub dirty surfaces. Instead, use gentle circular motions. Remember that sharp objects or abrasive materials can damage the car.

1. Remove the mats for separate cleaning and access to the floor. Grasp the mat by the fastening pins and lift it straight up.
2. Vacuum the mats and floor to remove loose dust and dirt. Do not shake or beat the mats to remove dust and dirt as they can crack.
3. Clean the area with a neutral-coloured, clean microfibre cloth that is lightly dampened with water or a colourless, mild cleaning agent. Use gentle circular motions.
4. Let the mat dry fully before putting it back. Fix it into place by pressing down near each pin.

 **Warning**

Only use one mat for each seat and make sure the mats are properly fastened using all pins. If the driver's mat is not properly attached, it can move around and endanger your driving by getting caught near or under the driver pedals.

---

## 13.4. Wheels and tyres

The tyres' purpose is to carry your car's load, grip the underlying surface well, reduce vibration and protect the wheel rim from wear. Get familiar with the recommendations to get the most out of your wheels and tyres.



Familiarise yourself with tasks such as how to maintain a correct tyre pressure and how to change wheels so you are comfortable in these situations.

---

## 13.4.1. Wheel and tyre recommendations

Volvo recommends that you only use wheel rims and tyres that have been tested and approved by Volvo and are genuine Volvo accessories. A complete wheel refers to when tyres are fitted onto wheel rims.

### Recommended tyres

On delivery, the car is equipped with Volvo original tyres that have the VOL marking on their sides <sup>[1]</sup>. These tyres are carefully adapted to the car. It is therefore important that if you change tyres, the new tyres also have this marking in order to maintain the car's driving characteristics, comfort and electricity consumption.

### Original tyres

Your car is originally equipped with tyres according to the label found on the pillar by the driver door.

The tyres have good roadholding properties and provide good driving characteristics on dry and wet road surfaces. Remember, however, that the tyres have been developed to provide these properties on roads that are free from ice and snow. Even if the car is equipped with stability systems or all-wheel drive, these tyres are not designed for winter driving. Change to winter tyres when the weather requires you to.

Some cars are equipped with a combination of tyres and wheel rims with extra-high performance. They are designed to be capable on dry road surfaces and with resistance against aquaplaning. These may be more sensitive to damage on the road surface and, depending on conditions, may have a shorter service life.

"All-season" tyres provide slightly better roadholding on slippery road surfaces than tyres without the "all-season" classification. However, for good roadholding on icy or snow-covered roads, Volvo recommends winter tyres on all four wheels.

## Tyre age

Volvo recommends that tyres should be changed after 6 years from the date when they are first used. If you are unable to determine the date, use the DOT<sup>[2]</sup> marking on the tyre sidewall. Tyres age and deteriorate over time, even if they are rarely used. The function can therefore be affected. Heat caused by hot climates, frequently carrying heavy loads or exposure to ultraviolet (UV) radiation may accelerate the ageing process. Cracks or discolouration are examples of external signs which indicate that the tyre is unsuitable for use. A tyre that has visible signs of deterioration should be changed immediately.

## Replacing tyres

Note that the front and rear pairs of wheels have different dimensions. Never switch originally fitted wheels between the front and rear axles.

When you replace your tyres, you must make sure that all four tyres have the right size designation for their corresponding axle, are of the same type (radial), and are preferably from the same manufacturer as the original tyres. Volvo recommends that you use VOL marked tyres. Otherwise there is a risk of changing the car's roadholding properties and driving characteristics.

If the wheels are fitted incorrectly, the car's braking characteristics and capacity to deflect rain and slush are adversely affected.

## Wheel rims and tyre sizes

### Warning

- Your Volvo's wheel rim and tyre sizes are specified to meet stringent requirements for stability and driving characteristics. Unapproved combinations of wheel rim size and tyre size may have a negative effect on the car's stability and driving characteristics.
- Any damage caused by the fitting of unapproved combinations of wheel rim size and tyre size are not covered by the new car warranty. Volvo accepts no liability for death, personal injury or any costs caused by such installations.
- Do not use steel or aluminium wheel rims which are damaged, cracked or deformed, which have extensive corrosion damage, or which have been welded or repaired.

<sup>[1]</sup> There may be deviations for certain tyre dimensions.

<sup>[2]</sup> Department of Transportation

---

### 13.4.1.1. Tyres and wheel storage

To keep them in good condition, you should always store wheels that are not in use in a cool, dry and dark place. How you place them, as well as avoiding exposure to chemicals, is also important.

When you store wheels that are not in use, it's important to keep them from direct sunlight, rain, water, heat sources or sparks. They should never be stored near solvents, petrol, oils or similar substances, especially not flammable ones.

Store wheels<sup>[1]</sup> hung up or lying on their sides on the floor.

If you store tyres not fitted on rims, you should never hang them up. Store them standing upright or lying on their sides instead. If you hang up rimless tyres, they may become deformed.

<sup>[1]</sup> Tyres fitted on rims

---

## 13.4.1.2. Tyre economy

To preserve your tyres as much as possible, there are some things you should keep in mind.

- Correct tyre pressure reduces uneven wear. It's important to check the pressure regularly.
  - Hard acceleration, heavy braking and driving in a way which causes screeching tyres lead to increased tyre wear.
  - Tyre wear increases with speed.
  - Unbalanced wheels cause uneven and excessive tyre wear as well as reduced ride comfort.
  - Wheels must have the same direction of rotation during their entire service life.
  - The rear tyre grip should always be equal to, or better than, the front tyre grip to reduce the risk of oversteering in case of heavy braking.
  - Tyres or wheel rims may be damaged permanently if you hit kerb stones or drive into deep holes.
  - Driving style, road conditions and climate affect the tyre wear.
-

## 13.4.2. Designations on tyre sidewall

There are many digits, numbers and symbols that may be found on a tyre's sidewall. Here are some examples and explanations of what they indicate.

### Note

Be aware that the following tyre designations are only examples. Not all of these designations may be available for your tyres and there may be designations on your tyres which are not included here.

### Tyre dimensions

All tyres have a designation of dimensions, such as: 235/60 R18 103H.

- 235** Tyre width (mm).
- 60** Ratio between tyre wall height and tyre width (%).
- R** Radial ply. The designation RF and symbol specify that the car is equipped with puncture-resistant tyres.
- 18** Rim diameter (inches).
- 103** Codes for the maximum permitted tyre load, Load Index.
- H** Speed rating for maximum permitted speed, Speed Symbol.

### Wheel rim dimensions

All wheel rims have a designation of dimensions, such as: 8J x 19 x 50.

- 8** Rim width (inches).
- J** Rim flange profile.
- 19** Rim diameter (inches).
- 50** Off-set in mm (distance from wheel centre to wheel contact surface against the hub).

### Weather condition classification

Here are some classification examples. Weather capabilities can also be defined with certain symbols.

- M+S or M/S** Mud and Snow.
- AT** All Terrain.
- AS** All Season.

### Tyre age

**DOT YLX2 0819** Tyre Identification Number or TIN. This information helps the tyre manufacturer identify tyres in the event of safety recalls.

1. DOT<sup>[1]</sup>
2. The first two or three characters are the code for the plant where the tyre was manufactured.
3. The next two characters are the tyre's size code.
4. The last four digits specify the week and year the tyre was manufactured. For example, 0819 means that the tyre was manufactured during week 08, year 2019.

The content of this manual represents the status of the user manual at the time of printing and may not be completely valid in future instances. For more information, refer to the first page for the complete disclaimer note.

Any numbers or letters shown in between are market codes chosen by the manufacturer.

## Max load and pressure

**Max load 685 kg (1610 lbs).** Specifies the maximum load that the tyre can carry.

**Max pressure 240 kPa (35 psi).** The maximum tyre pressure that the tyre should ever be subjected to. This limit is specified by the tyre manufacturer.

## Minimum permitted load index and speed rating



### Warning

The minimum permitted load index (LI) and speed rating (SS) for the tyres for each respective motor variant are shown in the specifications sections. If a tyre with too low a load index or speed rating is used, it may overheat and become damaged.

## Type, materials and tyre rotation

**P** Indicates that the tyre is for passenger vehicles.

**VOL** Volvo original tyres.

**Plies: Tread 2 polyester, 2 steel, 1 polyamide. Sidewall 2 polyester.** States the number of cord layers or number of layers with rubber-coated fabric in the tyre's tread and sidewall. The tyre manufacturers must also state the layer materials used in the tyre and sidewall, which may be steel, nylon, polyester and certain other materials.

**Arrow symbol** Tyres with a tread pattern designed to only turn in one direction have the direction of rotation marked with an arrow.

## Classification of uniform tyre quality

**Treadwear grade 200** The treadwear grade is a comparative rating based on the wear-rate of the tyre in a standardised test. A higher value is better.

**Traction grade AA** The traction grade is based on standardised straight-ahead braking traction tests. The traction grades, from highest to lowest, are AA, A, B and C.

**Temperature grade A** The temperature grade reflects the thermal performance of a tyre that is properly inflated and not overloaded. The temperature grades, from highest to lowest, are A, B and C.

[1] Department of Transportation

---

### 13.4.2.1. Tyre tread wear indicators

There are tread wear indicators to show the status of the tyre's tread depth.



The narrow grooves that run lengthways across the tyre's tread pattern are tread wear indicators. On the side of the tyre are the letters TWI<sup>[1]</sup>.

**!** Important

- Tyres should be changed before wearing them down to the tread wear indicators to avoid poor traction in rain and snow.
- Volvo recommends that winter tyres have a greater tread depth than 4 millimetres (1/8 inch) and summer tyres 1.6 millimetres (1/16 inch).

<sup>[1]</sup> Tread Wear Indicator

## 13.4.3. Changing wheels

If you need to change a wheel, it's important to follow the recommended procedure.

**!** Warning

### Raising the car to change a wheel

Changing a wheel requires that you raise the wheel off the ground. Carefully follow the separate instructions for raising the car safely.

- If you are changing a wheel in or close to traffic, make sure you and the car are clearly visible to others. Activate the hazard warning lights, put out a warning triangle in a visible but safe place and wear a reflective vest.
- Designate a safe space for passengers to wait, away from both the car and traffic.
- You are responsible for safety around the car while it is raised. Do not allow people inside or close to the car.
- Never get under the car, or let anyone reach under it with any part of their body, while it is raised with a jack.

**Note**

You must activate jack mode before raising the car off the ground.

## Before removing the wheel

The wheels on your car are fastened with wheel bolts. For extra security, you can use lockable bolts.

Put the gear in P and engage the parking brake before starting.

**Important**

- Make sure that the dimensions of the replacement wheel are approved for your car.<sup>[1]</sup>
- Make sure you read through all the instructions before you start. Get all the tools you need before the car is raised.<sup>[2]</sup>
- Use the towing eye as an extended handle for the wheel wrench. The towing eye must be screwed into the wrench as far as it will go.

### Removing the wheel

1. Remove the plastic caps from the wheel fasteners using a suitable tool or pull the wheel cap off.



Tool for removing the wheel fastener caps

2. While your car is still on the ground, use the wheel wrench to loosen the wheel fasteners approximately 0.5-1 turn. Press the wrench downwards while the wrench is extended to the left to avoid personal injury. The anticlockwise rotation loosens the fastener. If you are using lockable bolts, start with them.
3. Follow the instructions on how to safely raise the car.
4. Raise the car high enough so that the wheel you want to remove is off the ground. Remove the wheel fasteners and lift off the wheel.

**Tip**

When switching wheels between winter and summer, mark which side they were mounted on, for example L for left and R for right.

### Mounting the wheel

The content of this manual represents the status of the user manual at the time of printing and may not be completely valid in future instances. For more information, refer to the first page for the complete disclaimer note.

- Clean the surfaces between the wheel and hub.
- Mount the wheel. Make sure you tighten the fasteners. However, the final tightening to the specified torque is done when the wheel is back on the ground and unable to rotate while you do it.

 **Warning**

- Make sure that you put the wheels on the correct axle. Incorrectly mounted wheels can affect the car's handling.
- Never use lubricant on the threads of wheel fasteners. It could cause the wheel fasteners to loosen after tightening.

- Lower the car back to the ground.
- Fasten the fasteners crosswise. If you are using lockable bolts, finish with those.

It's very important that the fasteners are properly secured. Tighten to 140 Nm (103 lb-ft). Check the tightening torque with a torque wrench. Overtightened or loosely tightened fasteners may damage the fastening threads or the wheel itself.

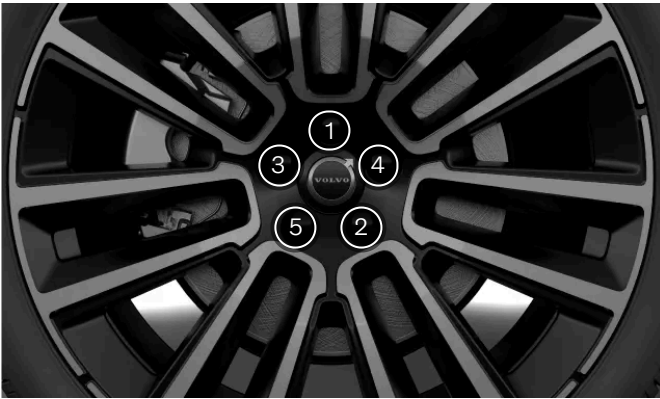

Tighten the wheel fasteners crosswise.

- Place the wheel fastener cover back over the fasteners, using the guide markers to position it correctly, then press it into place. Ensure that it's securely fastened.
- Check the tyre pressure and store a new reference value in the tyre pressure monitoring system.

 **Warning**

### Check the wheel fasteners

The wheel fasteners may need to be re-tightened a few days after the wheel has been changed. Temperature differences and vibrations may cause them to loosen.

### Wheel properties after a wheel change

Be attentive to signs of incorrectly fitted wheels. This could affect the car's braking characteristics and the ability to deflect rain and slush.

When you have changed the type or size of the wheels, you should drive carefully at first. The dynamics and driving characteristics of the wheels may have changed.

[1] Some spare wheels have different dimensions. If your car is approved for the spare wheel you intend to use, the difference in dimensions is okay.

[2] Use tools that are designed for your car model.

---

## 13.4.3.1. Spare wheel

If you get a punctured tyre, a spare wheel<sup>[1]</sup> can be temporarily used until the original wheel can be replaced or repaired.

The spare wheel is only designed for temporary use. You should replace the spare wheel with an ordinary wheel as soon as possible.

### **Warning**

#### Removing the spare wheel

The spare wheel is secured in the spare wheel well using a retaining screw. When you take the spare wheel out, remove the screw to help prevent injury when the flat tyre is replaced.

#### Before driving with a spare wheel

- Only use a spare wheel that your car is approved for.
- Never drive your car with more than one spare wheel fitted.
- Snow chains cannot be used if the spare wheel is fitted on the front axle.
- The spare wheel should never be repaired.
- On all-wheel drive cars, the drive on the rear axle can be disengaged.
- Make sure to follow the spare wheel manufacturer's recommendations regarding tyre pressure.

#### Driving with a spare wheel

- Never drive faster than 80 km/h (50 mph) when a spare wheel is fitted to your car.
- Your car's driving characteristics may be affected by using a spare wheel. It is important to replace the spare wheel with an original wheel as soon as possible.

### **Note**

While a spare wheel is used, the tyre pressure monitoring system might not work correctly.

[1] The spare wheel must be of the type Temporary Spare.

## 13.4.3.2. Winter tyres

Winter tyres are designed for driving in road conditions with ice and snow. Your winter tyres' tread depth should be deeper than that of regular tyres.

### Dimensions

When driving with winter tyres, it's important that all four tyres are of the correct type. Contact a Volvo dealer for advice.

### Studded tyres

Studded winter tyres should be run-in gently for 500-1,000 km (300-600 miles) so that the studs settle properly into the tyres. This gives the tyre, and especially the studs, a longer service life.

#### Note

Legal regulations for the use of studded tyres may vary. Make sure your fitted tyres are in full compliance with local regulations and laws.

### Tread depth

Road conditions with ice, slush, snow and low temperatures put higher demands on your tyres than summer conditions. Volvo recommends that winter tyres have a tread depth of at least 4 millimetres (0.15 inch).

#### Note

##### Speed rating

Winter tyres<sup>[1]</sup> are allowed to have a lower speed rating than your car's top speed. However, if your winter tyres do have a lower speed rating than your car's top speed, you are not allowed to drive faster than the tyres' speed rating.

<sup>[1]</sup> Both studded and stud-free tyres

---

## 13.4.3.3. Using snow chains

Using snow chains can help to improve traction in winter conditions. However, there are some restrictions you have to keep in mind.

 **Warning**

Snow chains can be used on your car with the following restrictions:

- Use genuine Volvo snow chains or equivalent chains designed for the car model, tyre and wheel rim dimensions.
- Only single-sided snow chains are permitted.
- The wrong snow chains may cause serious damage to the car and lead to an incident.

 **Note**

Using snow chains may result in malfunction of the tyre pressure monitoring system.

### Fitting snow chains

- Make sure you are in a safe place when fitting or removing the snow chains.
- Always comply with local regulations and laws regarding the use of snow chains.
- Always carefully follow the mounting instructions from the manufacturer.
- Always use the same type of chains on left and right-hand side tyres.
- Volvo recommends that snow chains are not used on wheels with dimensions greater than 18 inches.
- Make sure you use the correct size in relation to the wheels.
- Snow chains must only be used on the front wheels.<sup>[1]</sup>
- If wheels of a different size than the original wheels are fitted, certain snow chains must not be used.
- There needs to be sufficient distance between the chains and the car's brakes, suspension and body components. Chains that risk interfering with brake components must not be used.
- If you need to move your car while fitting or removing chains, do not let the wheels run over the chains' attachments.
- Fit the chains as tensioned as possible and tension them at regular intervals.

 **Tip**

Practise fitting the snow chains before winter comes.

### Driving with snow chains

- Once the snow chains are fitted, drive about 200 metres (650 feet). Then stop the car and check again that the chains are firmly attached.
- Never exceed the chain manufacturer's specified speed limit. You must never exceed 50 km/h (30 mph) under any circumstances.
- While improving grip in certain conditions, snow chains negatively affect other driving characteristics. If possible, avoid driving over uneven ground, such as bumps or holes. Also avoid fast or sharp turns as well as hard braking.

**The content of this manual represents the status of the user manual at the time of printing and may not be completely valid in future instances. For more information, refer to the first page for the complete disclaimer note.**

- Avoid driving on ground not covered in snow or ice as this wears out both the snow chains and wheels.

Contact a Volvo dealer for more information.

<sup>[1]</sup> This also applies to all-wheel drive cars.

---

## 13.4.4. Punctures

If you suffer a punctured tyre, there are several actions to take to recover safely, especially if it happens while you are driving.

If the puncture occurs while you are driving, it's important to think about safety first. Activate the hazard warning lights and, if possible, move the car away from immediate danger. If necessary, call roadside assistance.

### Warning

- Do not drive the car if it has a punctured tyre. It is not safe and will damage the car.
- If possible, exit your car from the side with the least traffic to avoid causing an accident.
- Place a warning triangle so that others are warned well in advance of passing your car. Remember to first put on a reflective vest if you have one.

### Tip

If you need to use a temporary puncture repair kit, be sure to read its instructions before you start to use it.

---

### 13.4.4.1. Temporary puncture repair

Your car is equipped with a temporary puncture repair kit<sup>[1]</sup> which can be used to repair a minor puncture in a tyre. The kit includes a bottle of sealant fluid and a compressor.

### Warning

Read through all of the instructions before using the repair kit.

You should not drive faster than 80 km/h (50 mph) after the repair kit has been used on your tyres.



## Compressor

The compressor is intended to be used for temporary tyre repair and is approved by Volvo. You can also use the compressor to check and adjust the tyre pressure on your original tyres when needed.

The compressor is an electrical device. When it's time to dispose of it, be sure to follow local regulations related to waste management.

## Sealant fluid

The sealant fluid works as a temporary repair. It is effective at sealing a tread puncture but should not be used to seal a puncture in the sidewall of the tyre. If the tyre has larger slits, cracks or similar damage, you should not use the sealant to repair it.

The bottle of sealant fluid needs to be replaced if the expiration date has passed<sup>[2]</sup>. The old bottle is considered hazardous waste.

<sup>[1]</sup> Also called temporary mobility kit or TMK

<sup>[2]</sup> See expiration date on bottle.

---

### 13.4.4.1.1. Using the temporary puncture repair kit

When using the temporary puncture repair kit, there are a number of important steps you need to follow. Make sure you read and understand each step before proceeding.

**i Note**

These instructions apply to the temporary puncture repair kit supplied by Volvo.



Overview of the temporary puncture repair kit's compressor

- ① Power switch
- ② Electrical cable
- ③ Air hose with pressure-reducing valve
- ④ Bottle holder
- ⑤ Pressure gauge



Sealing fluid bottle

 **Warning**

### Sealing fluid can be harmful

The sealing fluid contains substances that are harmful if swallowed. The contents can also cause allergic reactions or be otherwise harmful to the respiratory tract, the skin, the central nervous system and the eyes.

#### Precautions

- Store the kit out of reach of children.
- Avoid prolonged or repeated contact with the skin. If you get sealing fluid on your clothes, remove them.
- Wash hands thoroughly after handling.

#### First aid

- Ingestion: Do not induce vomiting unless directed to do so by medical personnel. Get medical attention.
- Skin: Wash affected areas of skin with soap and water. Get medical attention if symptoms occur.
- Eyes: Flush with plenty of water for least 15 minutes, occasionally lifting the upper and lower eyelids. Get medical attention if symptoms occur.
- Inhalation: Move the exposed person to fresh air. If irritation persists, get medical attention.

- Make sure the compressor's power button is in the off position before starting.
- Don't remove the air hose during repair.
- If the puncture was caused by a nail or similar and it's still in the tyre, leave it in. This helps to seal the puncture.
- If the repair is carried out in an area where there might be other vehicles, activate the hazard warning lights and use a warning triangle, if you have one.

#### Preparations

1. Place the label showing maximum permitted speed so that it is clearly visible as a reminder for the driver, for example in the windscreen. You find it on the compressor.

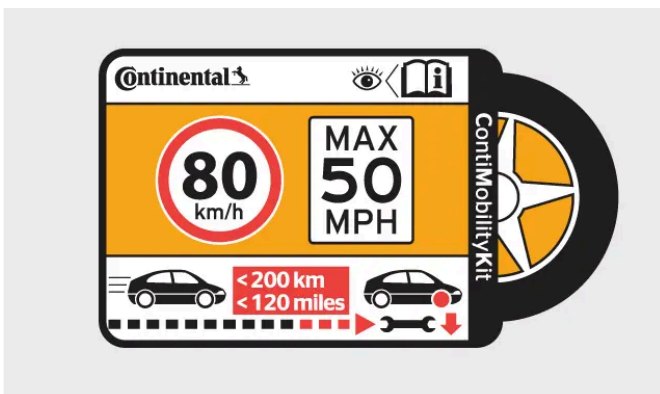

Label, maximum permitted speed

2. Attach the sealing fluid bottle to the compressor and then turn it 90 degrees clockwise.
3. Attach the air hose to the bottle opening and turn it 90 degrees clockwise.
4. Unscrew the dust cap from the tyre and attach the air hose to the tyre's air valve. Screw the connector as far down the thread as possible.

The content of this manual represents the status of the user manual at the time of printing and may not be completely valid in future instances. For more information, refer to the first page for the complete disclaimer note.

## Begin puncture repairs

5. Connect the compressor to the car's 12 V socket and ensure that the socket works and is supplying current.

 **Warning**

Inhaling car exhaust fumes could result in danger to life. Never leave the engine running in sealed areas or areas that lack sufficient ventilation.

 **Important**

While using one of the car's 12 V socket to power the compressor, do not use the other 12 V socket.

6. Start the compressor by pressing the power button.
- > The compressor pressure increases. The pressure may temporarily reach as high as 7 bar (102 psi) before settling after about 30 seconds.

 **Warning**

Never stand next to the tyre while the compressor is on. If cracks or bumps appear in the tyre, the compressor must be turned off immediately. Stop and contact Volvo Assistance for safe recovery.

7. Inflate the tyre for 7 minutes.

 **Important**

To avoid overheating, do not run the compressor for more than 10 minutes.

8. Shut the compressor off to check the pressure on the pressure gauge. The minimum tyre pressure is 1.8 bar (26 psi) and the maximum tyre pressure is 2.5 bar (36 psi). Use the pressure-reducing valve if the pressure is too high.

You need to remove the bottle to access the air release valve. The bottle is equipped with a check valve that prevents fluid leakage when the bottle isn't connected to the compressor, so you don't have to worry about fluid leaking out. Follow these steps to remove the bottle:

1. Unscrew the hose from the tyre's valve.
2. Detach the hose from the bottle.
3. Remove the bottle from the compressor.
4. Attach the hose directly to the compressor.
5. Screw the hose back onto the tyre's valve.
6. Release air by pressing the air release valve.

 **Warning**

If the pressure is below 1.8 bar (26 psi), the hole in the tyre is too big. Do not continue and contact Volvo Assistance for safe recovery.

9. Unplug the compressor from the 12 V socket.
10. Clean the hose before stowing it and make sure that no sealing compound is spilt.
11. Refit the tyre valve's dust cap.
12. As soon as possible, drive for 10 minutes<sup>[1]</sup> and let the fluid seal the tyre. After that, perform a follow-up check.

 **Warning**

Sealant will squirt out of the puncture during the first few rotations of the tyre. Make sure that nobody is standing near the car and gets the sealing fluid on them when the car is driven away.

**Follow-up check**

13. With the compressor shut off, connect the air hose to the tyre's air valve.
14. Check the tyre pressure on the pressure gauge.
  - > • If it is below 1.3 bar (19 psi) then the tyre is insufficiently sealed. Stop and contact Volvo Assistance for safe recovery.
  - If the tyre pressure is higher than 1.3 bar (19 psi), the tyre must be inflated to the pressure specified on the tyre pressure label on the driver's side door pillar. If the pressure is too high, release air using the pressure-reducing valve.
15. Refit the tyre valve's dust cap.
  - Replace the sealing fluid bottle and hose after use. Contact a Volvo dealer to do so.
  - Volvo recommends replacing or repairing the damaged tyre as soon as possible. Inform the workshop that the tyre contains sealing fluid.

 **Warning**

Maximum mileage with tyres containing sealing fluid is 200 km (120 miles).

<sup>[1]</sup> Or 3 kilometres (2 miles)

---

## 13.4.4.1.2. Inflating tyre with the puncture repair compressor

Your car's tyres can be inflated with the compressor that is included in the temporary puncture repair kit.

Make sure the compressor's power button is in the off position before starting.

1. Unscrew the dust cap from the tyre and attach the air hose to the tyre's air valve. Screw the connector as far down the thread as possible.
2. Attach the hose directly onto the compressor's bottle holder and turn clockwise 90 degrees.
3. Connect the compressor to the car's 12 V socket and start the car.

 **Warning**

Inhaling car exhaust fumes could result in danger to life. Never leave the engine running in sealed areas or areas that lack sufficient ventilation.

 **Important**

While using one of the car's 12 V socket to power the compressor, make sure that's the only socket in use. Do not use the other 12 V socket.

4. Start the compressor by pressing the power button.

 **Important**

To avoid overheating, do not run the compressor for any longer than 10 minutes at a time.

5. Check the tyre pressure on the compressor's pressure gauge<sup>[1]</sup>. Use the pressure-reducing valve if the pressure is too high.
6. Turn off the compressor and unplug it from the 12 V socket.
7. Unscrew the air hose from the tyre.
8. Refit the tyre valve's dust cap.
9. Store a new reference value in the tyre pressure monitoring system if needed.

Return the kit to its storage location.

<sup>[1]</sup> The recommended tyre pressure for the car's original tyres can be found on a label on the driver's side door pillar.

---

## 13.4.5. Tyre pressure

A correct tyre pressure helps to improve driving stability, lower energy consumption and extend the lifespan of the tyre.

With time, the tyre pressure decreases. The pressure also varies depending on environmental conditions. All of this is normal. However, if you drive with an incorrect tyre pressure, the tyres may overheat and become damaged. The tyre pressure affects

ride comfort, noise levels and handling characteristics.

Make it a habit to check the tyre pressure monthly and before longer trips. Always make sure you use a reliable pressure gauge. To keep the tyres in good shape, use the recommended tyre pressure for cold tyres.

 **Warning**

If the tyre pressure is too high or too low, the tyres can sustain severe damage. The tyres can explode while you are driving and cause you to lose control of the car.

 **Tip**

A correct tyre pressure will help you take advantage of your car's full loading capacity.

## 13.4.5.1. Tyre pressure monitoring

Your car can detect and indicate if the tyre pressure is low. Tyre pressure monitoring cannot be disabled. If the system is unable to detect any tyre pressure, it will indicate that there's a malfunction.

For the tyre pressure monitoring system to provide updated information, you need to drive the car above 35 km/h (22 mph) for several minutes.



An indicator symbol lights up if a low tyre pressure is detected in any of the tyres. It will stay illuminated until the problem is resolved and a new reference value for the tyre pressure has been stored.

In addition to messages in the driver display, you can also find information about the tyre pressure monitoring in the car status view.

 **Warning**

**No advance warning possible**

The system cannot give you any advance warning of potential tyre damage.

**Ensure correct tyre pressure immediately**

When the low tyre pressure symbol is lit, stop and check the tyre pressures as soon as possible. Driving with underinflated tyres can cause tyre failure.

If the tyre pressure monitoring system is not working correctly, the driver display's indicator symbol will first flash for approximately one minute and then remain lit. A message also appears on the driver display. If the fault is permanent, a service is required.<sup>[1]</sup>

Remember:

- The system does not replace the need for regular tyre inspection and maintenance.
- The indication symbol for low tyre pressure won't disappear until the low tyre pressure has been corrected and a new reference value has been saved.
- Whenever the tyre pressure is adjusted, such as when changing tyres or loads, you need to save a new tyre pressure reference value.

## Status

You will find information about any issues detected by the tyre pressure monitoring system in the centre display's car status view.

## System description

### Note

Your car uses an indirect tyre pressure monitoring system. This means you don't need to use wheels mounted with TPMS<sup>[2]</sup> sensors.

The following information is phrased according to external legal requirements.

Each tyre, including the spare (if provided), should be checked monthly when cold and inflated to the inflation pressure recommended by the vehicle manufacturer on the vehicle placard or tyre inflation pressure label. (If your vehicle has tyres of a different size than the size indicated on the vehicle placard or tyre inflation pressure label, you should determine the proper tyre inflation pressure for those tyres.)

As an added safety feature, your vehicle has been equipped with a tyre pressure monitoring system (TPMS) that illuminates a low tyre pressure telltale when one or more of your tyres is significantly under-inflated. Accordingly, when the low tyre pressure telltale illuminates, you should stop and check your tyres as soon as possible, and inflate them to the proper pressure. Driving on a significantly under-inflated tyre causes the tyre to overheat and can lead to tyre failure. Under-inflation also reduces fuel efficiency and tyre tread life, and may affect the vehicle's handling and stopping ability.

Please note that the TPMS is not a substitute for proper tyre maintenance, and it is the driver's responsibility to maintain correct tyre pressure, even if under-inflation has not reached the level to trigger illumination of the TPMS low tyre pressure telltale.

Your vehicle has also been equipped with a TPMS malfunction indicator to indicate when the system is not operating properly. The TPMS malfunction indicator is combined with the low tyre pressure telltale. When the system detects a malfunction, the telltale will flash for approximately one minute and then remain continuously illuminated. This sequence will continue upon subsequent vehicle start-ups as long as the malfunction exists. When the malfunction indicator is illuminated, the system may not be able to detect or signal low tyre pressure as intended. TPMS malfunctions may occur for a variety of reasons, including the installation of replacement or alternate tyres or wheels on the vehicle that prevent the TPMS from functioning properly. Always check the TPMS malfunction telltale after replacing one or more tyres or wheels on your vehicle to ensure that the replacement or alternate tyres and wheels allow the TPMS to continue to function properly.

### Note

Certain TPMS malfunctions may require the driver to switch off and lock the vehicle for 6 minutes for the control module to reset.

If the system still does not work correctly, contact a workshop.<sup>[3]</sup>

[1] Volvo recommends an authorised Volvo workshop for any repair or service needs.

[2] Tyre Pressure Monitoring System

[3] Volvo recommends an authorised Volvo workshop.

---

## 13.4.5.1.1. Saving a new reference value for tyre pressure monitoring

The tyre pressure monitoring system needs a reference value to work from. This means that the value needs to be reset in certain circumstances for the system to work properly.

A new reference value needs to be stored when certain changes have been made, such as every time you adjust the tyre pressure or change the tyres. The reference value may also need to be updated when there is a significant change in the car's weight due to loading or unloading.

### **Warning**

The exhaust gases contain carbon monoxide, which is invisible and odourless, but highly toxic. The procedure to store a new tyre pressure must therefore always be performed outdoors or in a workshop with exhaust extraction.

1. Turn the car off.
2. Inflate the tyres to the correct tyre pressure.<sup>[1]</sup>
3. Start the car.
4. Press the car symbol  in the bottom bar and go to **Status** → **Tyre pressure**.
5. Select **Update reference pressure**.

### **Note**

The **Update reference pressure** button is used to store a new reference value for the tyre pressure monitoring system. For safety reasons, it's only available when the car is turned on and stationary.

6. Confirm that you want to store a new value. The confirmation step is needed to avoid saving a new reference value by mistake.
  - > This overwrites the previous tyre pressure and enters a new reference value.
7. Start driving the car. The new value will be stored after driving for several minutes at a speed above 35 km/h (22 mph).
  - > • Once a new reference value is stored, the animation showing the saving progress disappears from the centre display.
  - If storing fails, an error message is shown.

<sup>[1]</sup> See the tyre pressure label on the driver's side door pillar or the relevant section in the manual for information on recommended tyre pressure for your car.

## 13.4.5.2. Adjusting tyre pressure

The tyre pressure needs to be adjusted if you're changing wheels or planning to drive with a different load. It's normal for tyre pressure to decrease over time. Adjusting it so that you have the correct pressure for the current situation helps ensure an even tyre wear and high performance.

The tyres need to be at ambient temperature when the pressure is checked and adjusted. This is referred to as having cold tyres. Never release air from a warm tyre. When it cools down, the internal air pressure drops, which can lead to underinflated or even entirely deflated tyres.

The tyres can warm up very quickly and should be considered warm if driven for longer than approximately 1.5 km (1 mile). They often need about 3 hours of cooling down before reaching ambient temperature again.

1. Remove the tyre valve's dust cap and then press the tyre pressure gauge firmly onto the valve.
2. Check the gauge to see what the current tyre pressure is.
3. If the pressure is low, inflate the tyre to the correct pressure. The recommended pressure for factory-fitted tyres is shown on the door pillar on the driver's side.
4. Refit the dust cap<sup>[1]</sup> to avoid damage to the valve.
5. Inspect the tyre for stuck debris, such as nails or other objects, that could puncture the tyre.
6. Check the sidewalls for any cavities, cuts, bumps or other irregularities.
7. Save the tyre pressure reference value in the centre display once you've adjusted the pressure.

If you accidentally over-inflate the tyre, press the metal pin in the middle of the valve to let out the excess air. Then check the pressure again.

After adjusting the tyre pressure, remember to store a new reference value in the tyre pressure monitoring system.

### Note

Spare wheels may have recommended pressures that are different from those of the original tyres. Always use the pressure recommended by the spare wheel manufacturer.

### Tip

You can use the compressor from the temporary puncture repair kit to check and adjust the tyre pressure on your original tyres when needed.

<sup>[1]</sup> Only use original Volvo dust caps or plastic ones as metal dust caps may corrode and stick to the valve.

## 13.5. Engine compartment

Get familiar with some parts in the engine compartment.

### Warning

Always let a workshop perform an engine wash. If the engine is hot, there is a risk of fire.

In this section of the manual, you will find information regarding:

- Coolant fluid
- Engine oil

### 13.5.1. Engine cooling system

Your car has an advanced temperature regulation system.

The cooling system's purpose is to maintain the correct operating temperature for the engine. The surplus heat can be used to heat the passenger compartment.

It is normal for the engine's cooling fan to keep running a while after turning the car off.

### Important

#### Check coolant level

The car must only be used when the coolant level is at the correct level. If the level is too low, the engine might overheat and become damaged.

#### Signs of leakage

Avoid starting the car if there are signs of leakage. This could damage the engine.

Signs of leakage could be coolant under your car, steaming coolant or that you needed to refill more than 2 litres (approx. 2 US quarts).

### Engine overheating

In some conditions, such as driving in rocky terrain, hot climate or with a heavy load, your car can overheat. This can limit the engine's power and impact other car features temporarily. For example, the air conditioning can be disabled for a while.

If you see a message in the driver display regarding high temperature in the engine or gearbox, or a low coolant level, follow the instructions in the message. You may need to refill the coolant or stop the car to let it cool down.

After driving in demanding conditions for a longer period of time, do not turn the engine off immediately after stopping. Leave the engine idling for a few minutes to let it cool.

**Tip**

When driving in hot climates, remove any auxiliary lights that are mounted in front of the grille can reduce the risk of overheating.

## 13.5.1.1. Refilling engine coolant

Check your car's coolant level and refill when necessary to prevent engine damage.

**Warning**

### Do not swallow coolant fluid

Never ingest coolant fluid, it can damage your organs. The fluid contains ethylene glycol, inhibitor, water and other substances.

### Heat and pressure

The coolant can be hot after running the engine. Let it cool down before unscrewing the lid on the coolant container. Unscrew the lid slowly to release any pressure.

**Important**

### Signs of leakage

Avoid starting the car if there are signs of coolant leakage. This could damage the engine.

Signs of leakage could be coolant under your car, steaming coolant or that you needed to refill more than 2 litres (approx. 2 US quarts).

## Prescribed quality

- To prevent deterioration of the cooling system, only use coolant approved by Volvo.
- Volvo recommends using ready-mixed coolant.
- If you use concentrated coolant, mix it half and half ratio of coolant and pure water. The purity must meet Volvo's requirements or it could damage the cooling system. Contact Volvo support if you are uncertain.
- Follow the instructions on the coolant's packaging.
- Do not mix different coolants.
- Never refill with water only. Risk of freezing increases with both low and high levels of coolant concentration.

1. Open the bonnet.

2.

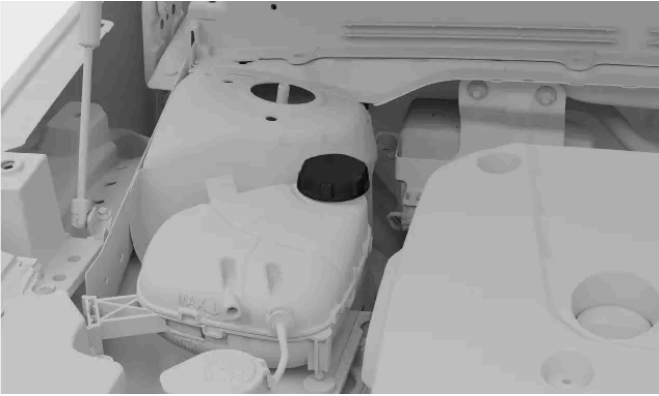

Unscrew the coolant container lid.

3. Check the coolant level and refill if needed. The coolant level must be between the MIN and MAX markings.

When you've finished refilling the coolant, put the parts back in the reverse order. Make sure that everything is properly secured.

---

## 13.5.2. Engine oil

Engine oil is used to lubricate, cool and protect different parts of the engine. It can also reduce vibrations and engine noise.

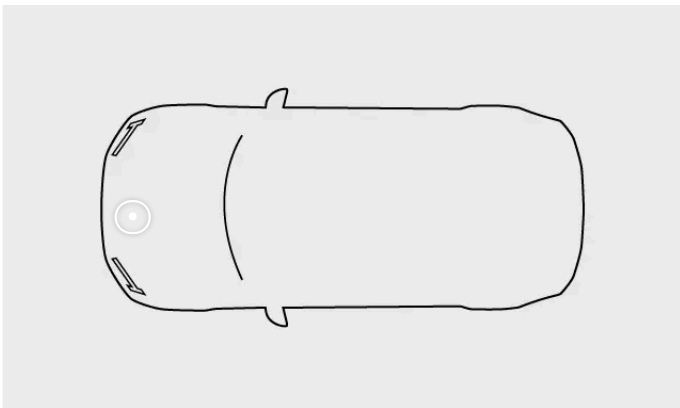

The engine oil label is located in the engine compartment.



Example of the engine oil label.

 **Important**

### Warranty not applicable

If engine oil of the prescribed grade and viscosity is not used, engine-related components may become damaged. Volvo does not accept any liability for such damage.

### Check engine oil level

The car must only be used when the engine oil level is at the correct level. If the level is too low, the engine might become damaged.

You must only use engine oil of the prescribed quality, otherwise the recommended service intervals and warranty will not be applicable. Using engine oil with a different quality can also have a negative effect on your car's service life, starting characteristics, fuel consumption and environmental impact.

Volvo recommends:

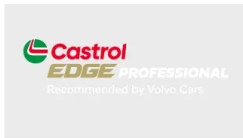

All engines are filled at the factory with a specially-adapted synthetic engine oil that has been carefully selected. This is done to fulfil the requirements for the engine's service intervals.

Volvo recommends that oil changes are done by an authorised Volvo workshop.

## Low oil pressure



If you see this symbol in the driver display, the engine oil pressure might be low. Stop driving and recover the car to a workshop <sup>[1]</sup>.

## Adverse conditions

Your car can have a higher engine temperature and consumption of engine oil if the external conditions are unfavourable.

Check the engine oil level more frequently if driving:

- with a caravan or trailer
- in a mountainous region
- at high speeds
- in temperatures hotter than +40 °C (+104 °F)
- in temperatures colder than –30 °C (–22 °F).

Choose a fully synthetic engine oil in these driving conditions for extra protection of the engine.

[1] Volvo recommends an authorised Volvo workshop.

---

## 13.5.2.1. Refilling engine oil

You may need to top up the engine oil between service intervals. You only need to do this if a message appears in the driver display.



Low oil pressure symbol

Your car has electronic oil level sensors and will warn you if the engine oil level is low. There is no oil dipstick on your car.

You can check the engine oil level in the centre display when the car is started. Check the oil level regularly.

You must only use engine oil of the prescribed quality, otherwise the recommended service intervals and warranty will not be applicable.

1. Turn off the engine.
2. Open the bonnet.
3. Locate the engine oil lid, placed almost in the centre of the engine.

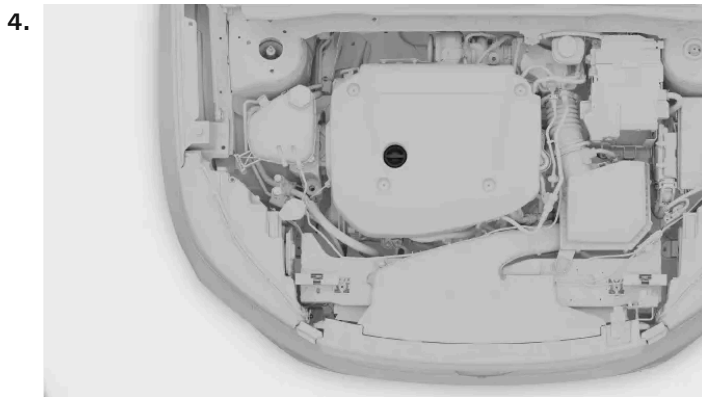

Unscrew the lid slowly to release any pressure.

5. Carefully refill the amount specified in the message. If the level is too high, it can cause the engine to not working properly.

 **Warning**

Be careful not to spill any engine oil in the engine compartment. If the oil gets in contact with hot parts, it may cause a fire.

6. Fasten the lid properly again.

### No value available

The new oil level will not be detected instantly. To get the correct oil level reading, first drive your car for approximately 30 km (20 miles) and then park the car on a level surface for 5 minutes with the engine turned off.

---

## 13.6. Car electrics and batteries

Your car has a specialised electrical system that delivers electricity to and from the batteries.

There is information about several of your car's electrical components in this section of the manual. This includes:

- 12 V battery
- 48 V battery
- Fuses



Tip

### Convenience features

Power-related features, such as USB ports and wireless charging of devices, are covered in other sections of the manual.



Warning

### If not described in the user manual

- Contact an authorised Volvo workshop for any required repairs or servicing that is not clearly described in the user manual.
- Do not modify the car's electrical components.

---

### 13.6.1. 12 V battery

The 12 V battery powers the main electric functions in your car.

#### Keeping the 12 V battery charged

The 12 V battery is charged whenever the engine is running. However, it charges better when driving the car. Using a lot of energy without allowing the 12 V battery to charge can lead to low battery level and electrical features can be reduced or disabled.

When you aren't driving the car, avoid using electrical functions such as:

- air conditioning
- headlights
- wipers
- radio

- centre display
- or the 12 V socket and USB ports.

If you still need to use certain features while the car is stationary, turn the engine off to use less power.

If the battery level is below a certain point, you will need to charge it with an external charger or jump start the car with an external battery.

## Servicing and replacement

The service life of the 12 V battery depends on several factors, such as driving conditions and climate conditions. The capacity will decrease over time.

Maintain the battery by driving for at least 15 minutes every week or connect a battery charger with automatic maintenance charging. Keep the battery fully charged to ensure the longest possible service life.

It is recommended that you contact an authorised Volvo workshop if the 12 V battery needs to be replaced. A replacement battery must have the correct specifications, such as type and capacity.

### **Warning**

- If the 12 V battery has been disconnected, the windows' pinch protection needs to be reset.
- The battery can generate oxyhydrogen gas which is highly explosive.
- The battery contains sulphuric acid which can cause serious burns and corrosion. If the sulphuric acid comes into contact with skin or clothes, rinse them with plenty of water. If the acid gets into eyes, seek medical attention immediately.
- Never smoke near the battery.

### **Important**

- Do not disconnect the battery while the engine is running.
- Ensure that all cables are correctly connected to the battery.
- If there is a strap holding the battery in place, make sure it is pulled tight.

## 13.6.1.1. Battery labels

Low-voltage car batteries have labels containing information for safe handling.

### Symbols



Avoid sparks and naked flames.



Use protective goggles.



Store the battery out of reach of children.



The battery contains corrosive acid.



More information in the car's user manual.



Risk of explosion.



The battery must be disposed of properly to be recycled.



Recycle properly.

**i Note**

**Depicted labels**

Labels depicted in this manual are generic representations of those found around your car. The manual only contains their location and what kind of information they hold. Find the actual label for specific information about your car.

---

## 13.6.2. 48 V battery

The 48 V battery supports the engine start and can regenerate energy during braking.

### Servicing and replacement

The 48 V battery and the box around it must only be handled by authorised technicians. It is recommended that you contact an authorised Volvo workshop if there are any questions or issues. A replacement battery must have the correct specifications, such as type and capacity.

#### Warning

- Do not touch components which are not clearly described in the user manual. Components with 48 V can be dangerous if handled incorrectly.
- Never use the 48 V battery to jump start another vehicle.
- Never connect any external equipment to the 48 V battery.

### Regenerating power

Your car can recover kinetic energy when braking to reduce fuel consumption and emissions. When you brake while the gear is in D or M, the car will regenerate energy.



A symbol in the driver display indicates when your car is regenerating power, such as by braking.

### 48 V battery specifications

Battery type	Voltage	Capacity	Cold start capacity <sup>[1]</sup>	Length	Width	Height
AGM	12 V	10 Ah	170 A	150 mm (5.9 in)	90 mm (3.5 in)	130 mm (5.1 in)

<sup>[1]</sup> CCA

---

## 13.6.3. Battery recycling

Used batteries must be recycled in an environmentally sound manner.

Consult Volvo support if you're unsure of how to dispose of batteries.

The 48 V battery must only be handled by authorised technicians.

---

## 13.6.4. Fuses

Electrical fuses protect different parts of the car's electrical system by cutting the power if the current exceeds the fuses' threshold. You need to replace a blown fuse to restore full functionality to the car's electrical system.

You can find the fuse boxes:

- on the right-hand side of the engine compartment, if you are standing in front of the car
- underneath the floor mat under the glove box
- On the right-hand side of the boot, if you are standing behind the car.

### Important

#### Fuse replacement

- If a fuse is incorrectly replaced it can cause severe damage to the electrical system.
- A replacement fuse must have the correct specifications, such as type and ampere value.
- A blown fuse may be an indicator of an underlying electrical fault. Volvo recommends an authorised Volvo workshop for all fuse replacements which are not clearly described in the user manual.

---

### 13.6.4.1. Replacing a fuse

You need to replace a blown fuse to restore full functionality to the car's electrical system. Contact Volvo support if you are uncertain on how it should be done.

### Warning

#### Risk of damaging electrical components

- Never insert a foreign object instead of a fuse.
- Always use the same type and amperage when replacing a fuse.
- Volvo recommends an authorised Volvo workshop for all fuse replacements which are not clearly described in the user manual.

### Tip

In some fuse boxes, there are spare fuses and special pliers to help. There might also be a diagram of the fuse placement available in the fuse box lid.

1. Find the placement of the fuse you need to change. Check the fuse box information in this user manual to see which fuse is connected to the feature that is not working.
2. Locate the fuse in your car with the help of the diagram and number of the relevant fuse.
3. Replace the blown fuse with a new one of the same type and amperage.

## 13.6.4.2. Fuse box under the bonnet

Here you can find fuse positions if you need to change a fuse. The fuses in this box helps protect the electronics for example for the engine and brake features. There are several fuse boxes in your car.



Fuse box location

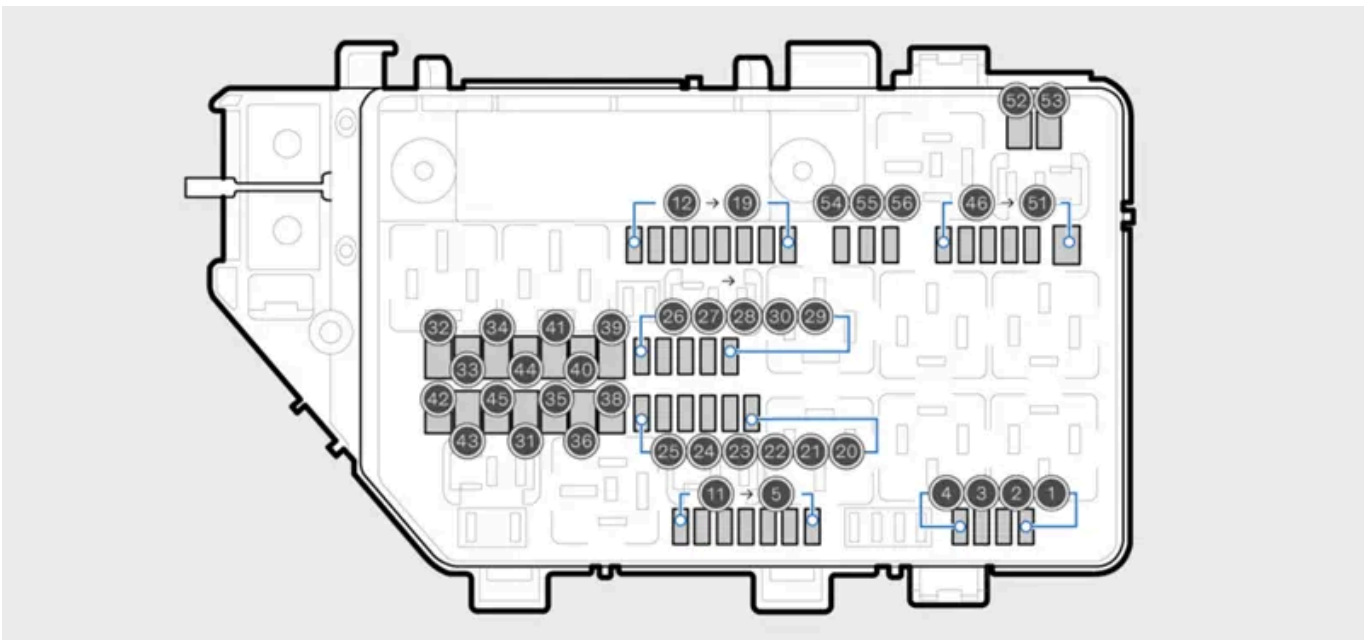

Diagram showing the fuse positions

To access the fuses you need to unclip the box lid.

Number	Feature	Ampere	Type
1	USB port in the rear of tunnel console	5	Micro
2	Front 12 V socket in tunnel console	15	Micro
3	–	–	Micro
4	12 V socket in boot	15	Micro
5	Engine Control Module (ECM)	20	Micro
6	Spark plugs	15	Micro
7	Engine Control Module (ECM), Fuel evaporation pump (EVAP)	15	Micro
8	Spoiler damper, Radiator damper, Switching valve for coolant, Solenoid engine oil pump, Solenoid air conditioning compressor	15	Micro
9	Lambda sensor	15	Micro
10	–	–	Micro
11	Cooling water pump	20	Micro
12	Right headlight	20	Micro
13	Left headlight	20	Micro
14	Collision module (SRS), Occupant weight sensor (OWS)	5	Micro
15	Accelerator pedal	5	Micro
16	Supplied when the ignition is switched on: Engine, Transmission, Electric steering servo, Central electronics, Brake system	5	Micro
17	–	–	Micro
18	Alcohol lock	5	Micro
19	–	–	Micro
20	Relay coils	5	Micro
21	–	–	Micro
22	Brake pedal sensor	5	Micro
23	Calculation unit	5	Micro
24	Gear selector	25	Micro
25	Gear selector	25	Micro
26	Engine Control Module (ECM)	5	Micro
27	–	–	Micro
28	–	–	Micro
29	Horn	20	Micro
30	Alarm siren	5	Micro
31	Wipers	30	MCCase <sup>[1]</sup>
32	–	–	MCCase (slotted) <sup>[1]</sup>
33	–	–	MCCase (slotted) <sup>[1]</sup>
34	–	–	MCCase (slotted) <sup>[1]</sup>
35	Transmission control	30	MCCase <sup>[1]</sup>
36	Transmission control	30	MCCase <sup>[1]</sup>
37	–	–	MCCase <sup>[1]</sup>
38	Headlights	30	MCCase <sup>[1]</sup>
39	Brakes	30	MCCase <sup>[1]</sup>
40	–	–	MCCase <sup>[1]</sup>
41	Towbar	25	MCCase <sup>[1]</sup>
42	Towbar	40	MCCase <sup>[1]</sup>
43	–	–	MCCase (slotted) <sup>[1]</sup>
44	Driver's seat	20	MCCase (slotted) <sup>[1]</sup>
45	–	–	MCCase (slotted) <sup>[1]</sup>

The content of this manual represents the status of the user manual at the time of printing and may not be completely valid in future instances. For more information, refer to the first page for the complete disclaimer note.

Number	Feature	Ampere	Type
46	-	-	Micro
47	-	-	Micro
48	-	-	Micro
49	-	-	Micro
50	-	-	Micro
51	-	-	MCase (slotted) <a href="#">[1]</a>
52	Heated windscreen, right side	40	MCase (slotted) <a href="#">[1]</a>
53	Heated windscreen, left side	40	MCase (slotted) <a href="#">[1]</a>
54	-	-	Micro
55	Left headlight	20	Micro
56	Right headlight	20	Micro

[\[1\]](#) Volvo recommends an authorised Volvo workshop for all fuse replacements of this type.

### 13.6.4.3. Fuse box underneath the left front seat

Here you can find fuse positions if you need to change a fuse. The fuses in this box helps protect the electronics for example in the power sockets, displays and doors. There are several fuse boxes in your car.

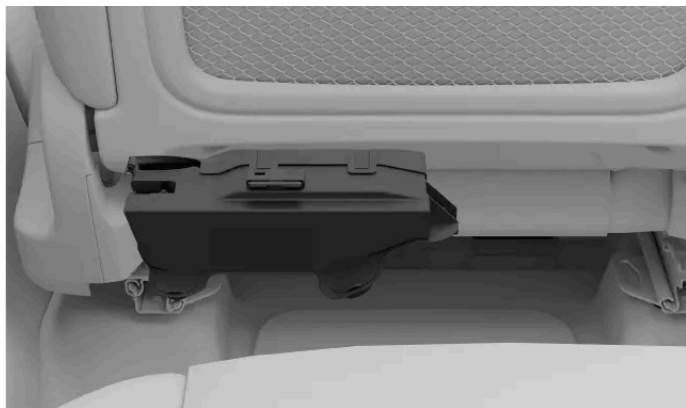

Fuse box location

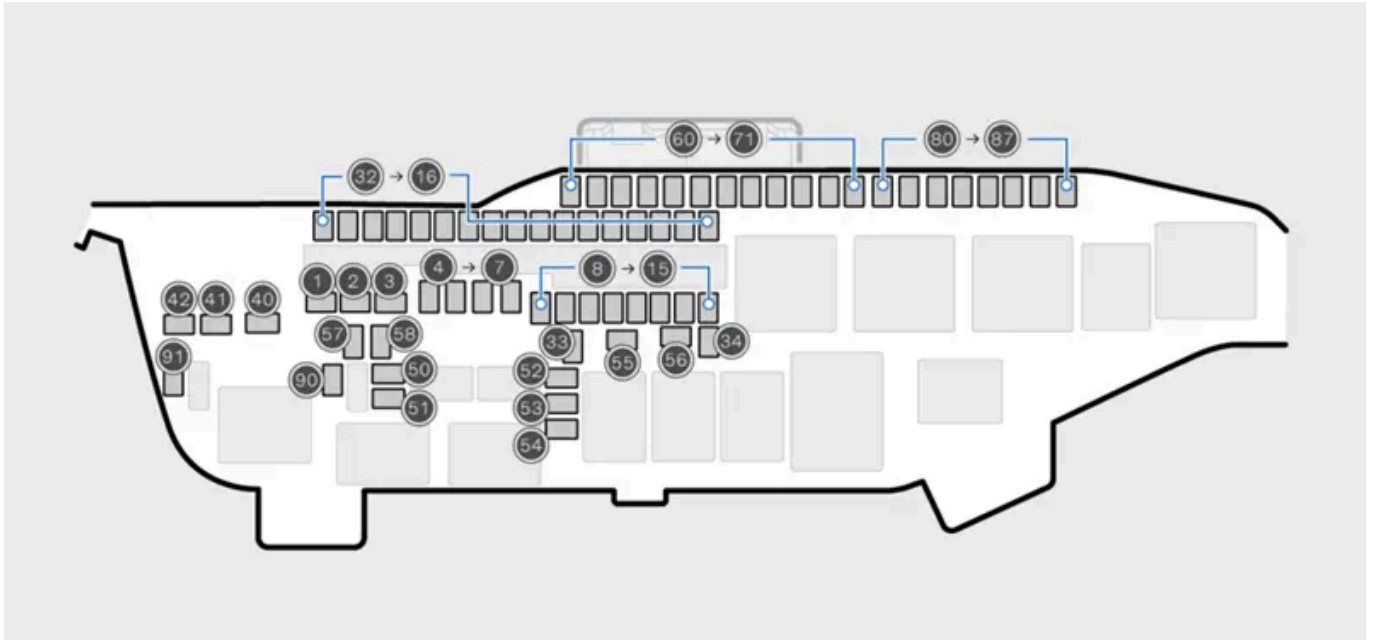

Diagram showing the fuse positions

To access the fuses you need to unclip the box lid.

Number	Feature	Ampere	Type
1	Sound control unit	40	MCase+HT <sup>[1]</sup>
2	Central Electronic Module (CEM) A	30	MCase+HT <sup>[1]</sup>
3	Central Electronic Module (CEM) B	30	MCase+HT <sup>[1]</sup>
4	Fan for front climate	40	MCase+HT <sup>[1]</sup>
5	Power operated tailgate	25	MCase+ <sup>[1]</sup>
6	Right front seat	20	MCase+ <sup>[1]</sup>
7	-	-	MCase+ <sup>[1]</sup>
8	-	-	MCase+ <sup>[1]</sup>
9	Right rear door module	20	Micro
10	Left rear door module	20	Micro
11	Front left door module	20	Micro
12	Safety module (ASDM)	5	Micro
13	Front right door module	20	Micro
14	Rear seat heating	15	Micro
15	48 V battery control unit	5	Micro
16	Calculation module	5	Micro
17	Sun sensor	5	Micro
19	Climate	7.5	Micro
20	Interior motion sensors	5	Micro
21	Driver display	5	Micro
22	Buttons in the centre stack	5	Micro
23	Steering wheel	5	Micro
24	Start knob, Electric gear selector, Parking brake	5	Micro
25	Centre display	5	Micro
26	Connected services	5	Micro
27	TCAM antenna	5	Micro
28	Relay coils	5	Micro

The content of this manual represents the status of the user manual at the time of printing and may not be completely valid in future instances. For more information, refer to the first page for the complete disclaimer note.

Number	Feature	Ampere	Type
29	Foot movement opening of the boot	5	Micro
30	Infotainment	15	Micro
31	On-board diagnostic port OBDII	10	Micro
32	Alcohol lock	5	Micro
33	Rear left headrest	15	Micro
34	Rear right headrest	15	Micro
40	Heated rear windscreen	30	MCase+ <sup>[1]</sup>
41	Left seatbelt pretensioner	40	MCase+ HT <sup>[1]</sup>
42	Right seatbelt pretensioner	40	MCase+ HT <sup>[1]</sup>
50	Humidity sensor, 48 battery generator and converter	5	Micro
51	Fuel pump	20	Micro
52	Cooling fluid pump	7.5	Micro
53	Heated steering wheel	15	Micro
54	Air humidity sensor, Air particle sensor	5	Micro
55	Headlamp washers	25	MCase+ <sup>[1]</sup>
56	Windscreen washers	25	MCase+ <sup>[1]</sup>
57	–	–	MCase <sup>[1]</sup>
58	–	–	MCase <sup>[1]</sup>
60	–	–	Micro
61	–	–	Micro
62	–	–	Micro
63	–	–	Micro
64	Blind spot information (BLIS)	5	Micro
65	–	–	Micro
66	Front radar	5	Micro
67	All Wheel Drive (AWD)	15	Micro
68	Exhaust system	5	Micro
69	–	–	Micro
70	–	–	Micro
71	Air bags and seatbelt pretensioners	5	Micro
80	Rear windscreen wiper	15	Micro
81	Roof console	20	Micro
82	360 parking camera	5	Micro
83	Interior lights, Rear view mirror, Rain and light sensors, Panels in rear doors and boot	7.5	Micro
84	Wireless charging	5	Micro
85	Driver support features	5	Micro
86	Alcohol lock	5	Micro
87	USB ports	5	Micro
90	–	–	Micro
91	–	–	Micro

<sup>[1]</sup> Volvo recommends an authorised Volvo workshop for all fuse replacements of this type.

## 13.7. Replacing light bulbs

You can change some of the bulbs for your car's exterior lights yourself. However, most of the car's exterior lights are LEDs which should be replaced by an authorised Volvo workshop.

Your car will notify you if it detects a broken light.

 **Warning**

**Risk of damaging electrical components**

- Never insert a foreign object instead of a light bulb.
- Always use the same type when replacing a light bulb.
- Volvo recommends an authorised Volvo workshop for all light bulb replacements which are not clearly described in the user manual.

 **Note**

Exterior lighting may temporarily contain water from condensation. This is normal and all exterior lights are designed to withstand this. Condensation is normally vented out of the light housing after a period of time.

---

## 13.7.1. Replacing rear fog light bulb

The rear fog light is located in the rear bumper on the driver's side of the car.

 **Important**

Never touch the bulb glass with your bare fingers. Grease and oils from your fingers vaporise from the heat and will leave a deposit on the reflector, which may damage it.

You need to make sure that the new bulb is of the correct type:

**Rear brake light** H21W LL

1. Turn the car off.

2.

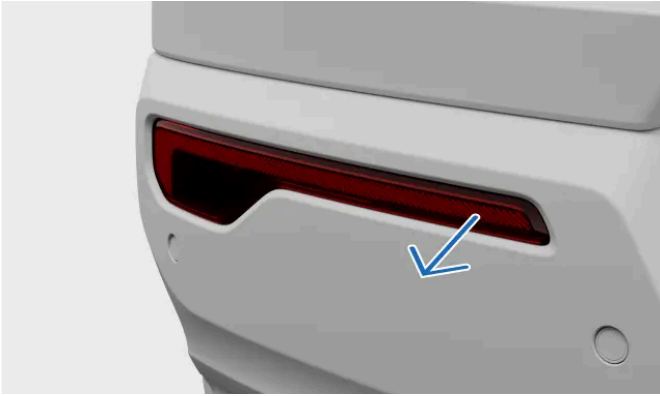

Insert a screwdriver behind the fog light's narrower short side and pry it out.

3. Unplug the connector.

4. Turn the bulb holder anticlockwise and pull it out.

5. Press the light bulb and turn it anticlockwise to remove it from the holder.

6. Insert the new bulb into the bulb holder and turn it clockwise.

7. Put the bulb holder back in place and turn it clockwise.

8. Plug in the connector.

9. Insert the hook on the wide part of the fog light unit into the rear bumper and push the unit in until the clips fasten into place.

---

## 13.7.2. Replacing rear indicator light bulb

The rear indicator bulbs are located behind the panel in the side of the boot.

### Important

Never touch the bulb glass with your bare fingers. Grease and oils from your fingers vaporise from the heat and will leave a deposit on the reflector, which may damage it.

You need to make sure that the new bulb is of the correct type:

**Rear indicator light** PY21W

1. Turn the car off.

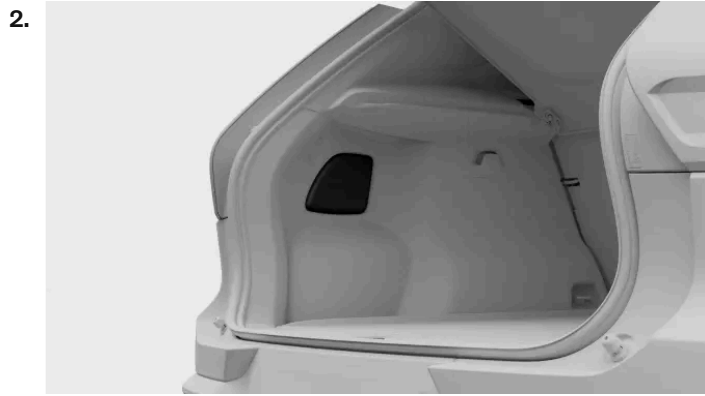

Press the top edge of the panel cover to make it pivot and remove it.

3. Move the insulation aside to access the support bridge.

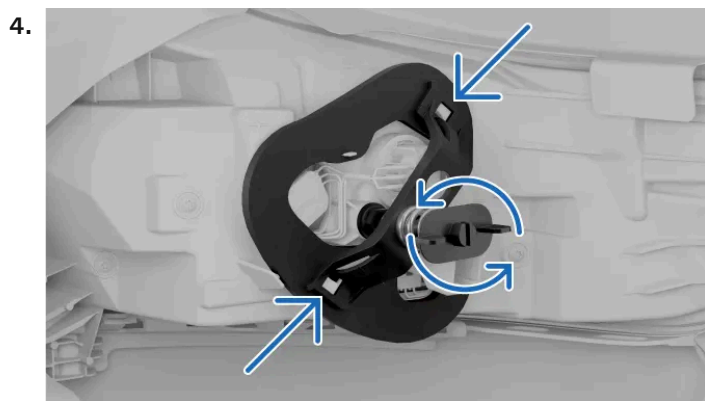

Unscrew the spring screw by turning anticlockwise. Leave the screw in the support bridge so that you can find it when you need it again.

5. Press the clips into the sides and remove the support bridge.

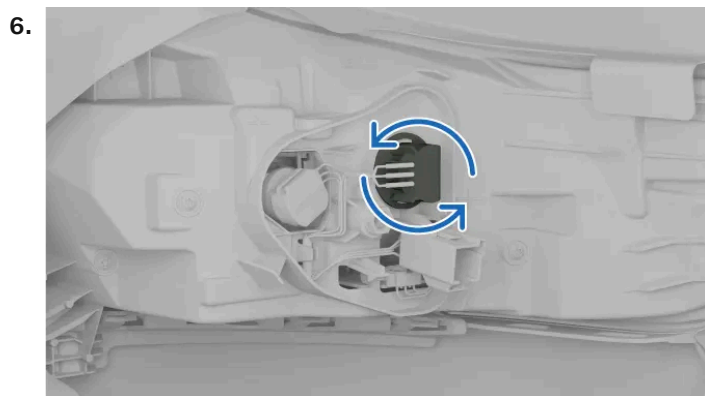

Turn the grey bulb holder anticlockwise and pull it out.

7. Press the light bulb and turn it anticlockwise to remove it from the holder.

8. Insert the new bulb into the bulb holder and turn it clockwise.

9. Put the grey bulb holder back in place and turn it clockwise.

10. Make sure that the clips on the support bridge are positioned correctly and fasten it with the spring screw. Tighten the spring screw until it stops, max. 2 Nm (1.5 ft lbs).

11. Reposition the insulation.

12. Reattach the cover panel. Push it in to make sure it's secured.

---

## 13.7.3. Replacing brake light bulb

The brake light bulbs are located behind the panel in the side of the boot.

 **Important**

Never touch the bulb glass with your bare fingers. Grease and oils from your fingers vaporise from the heat and will leave a deposit on the reflector, which may damage it.

You need to make sure that the new bulb is of the correct type:

**Brake light** H21WLL

1. Turn the car off.

2.



Press the top edge of the panel cover to make it pivot and remove it.

3. Move the insulation aside to access the brake light.

4.

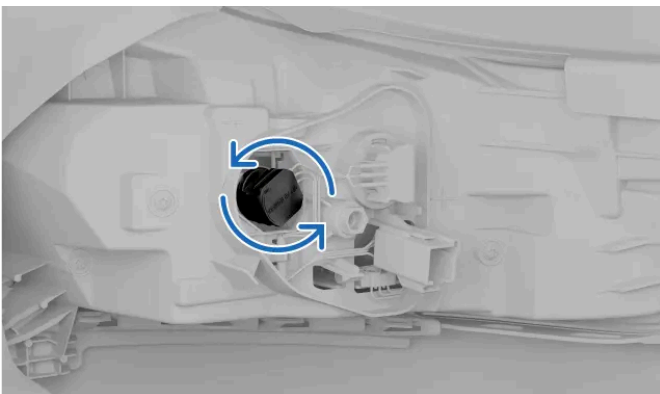

Turn the black bulb holder anticlockwise and pull it out.

5. Press the light bulb and turn it anticlockwise to remove it from the holder.
6. Insert the new bulb into the bulb holder and turn it clockwise.
7. Put the black bulb holder back in place and turn it clockwise.
8. Reposition the insulation.
9. Reattach the cover panel. Push it in to make sure it's secured.

---

## 13.8. Tools and equipment

Your car is equipped with some tools that may be useful in certain situations. For example, if you need to change a wheel.

The tools and equipment in your car are stored in different places, such as in the glove box and in the boot. Be sure to familiarise yourself with where everything is stored so you don't have to search for something when you need it.

### **Warning**

#### Store tools appropriately

Always store loose tools and equipment in designated storage areas when not in use. Otherwise, they can cause damage or injury in the event of a collision.

#### Read all instructions before using tools

Before use, make sure you read and understand all the relevant instructions for tools and equipment, where available.

Contact Volvo support for recommendations concerning tools and equipment for your car.

## Warning triangle



If your car should be immobilised in an area where there might be other vehicles, you can place the warning triangle on the ground to alert others before they reach your car.

## First aid kit



Your car is equipped with a first aid kit. Some regions require that it's always available in your car.

## Towing eye



The towing eye can be attached to the car's bumper to enable towing. It can also be used to secure roof-loaded objects that are longer than the roof.

## Wheel wrench



When changing a wheel, you need the wrench to loosen or secure the wheel fasteners. The towing eye can be screwed onto the wheel wrench to make an extended handle.

## Lockable wheel bolt tool



This tool is for unlocking the wheel bolt and makes it possible to change the wheel.

## Tool for wheel fastener caps



This tool is for removing the wheel fastener caps when changing the wheels.

## Jack



If you need to lift your car, for example to change a tyre, you can use the jack.

## Temporary puncture repair kit



Your car is equipped with a temporary puncture repair kit which can be used to repair a minor puncture in a tyre.

## Funnel for refilling fluids



Use the funnel when refilling fluids, such as engine oil or coolant, to avoid spilling them. Make sure you clean it properly between uses.

---

### 13.8.1. Using a warning triangle

Assemble and set out a warning triangle if your car is immobilised in an area where there might be other vehicles. The warning triangle's purpose is to give other drivers advance notice of your car or other stationary hazards.



The folded warning triangle in its case.

**i Note**

**Local rules and regulations**

Rules and regulations about how and when to put out a warning triangle vary between regions. You are responsible for knowing and following what applies in your location.

**i Tip**

- If it's dark when you set out the warning triangle, wear a reflective vest if you have one. If you don't have one, you can hold the warning triangle so that its reflective parts are visible as you carry it.
- You can place the case on the driver's seat as a reminder to retrieve the warning triangle when you leave.

1. Activate the hazard warning lights.



The warning triangle is located on the inside of the boot hatch. Open the compartment by turning the handle so that it's vertical and then pulling it.

3. Take out the warning triangle from its case, unfold it and connect its ends.

4. Fold out the triangle's support legs.
5. Position the warning triangle in a suitable place in regard to traffic and at a distance which ensures that other drivers are alerted in good time before they reach your car.

Remember to retrieve the warning triangle before you drive off again.

---

## 13.8.2. Attaching the towing eye

Use the towing eye to attach a winch wire when towing.

On the right-hand side of the car, the towing eye is screwed into a threaded socket behind a cover located on the front and rear bumpers.

### Important

Be sure to read about towing and its limitations before you start.

Fetch the towing eye so you have it at hand.

### Attach in the front



Front towing eye fastening cover

Push on the side of the cover to make it pivot. The cover can then be removed.

2. Screw the towing eye all the way into the socket.

### Important

It is important that the towing eye is firmly screwed into place. Putting something through the towing eye, such as a wheel wrench, can give extra leverage.

After you're done, remember to remove the towing eye again and return it to its storage location. Make sure to put the cover back in place to protect the socket.

## 13.9. Raising the car

You can raise one wheel off the ground at a time using a jack. Be sure to read all instructions before raising the car.

The content of this manual represents the status of the user manual at the time of printing and may not be completely valid in future instances. For more information, refer to the first page for the complete disclaimer note.

 **Important**

### Recommended or supplied equipment

- The instructions for raising the car presume use of a jack recommended or supplied <sup>[1]</sup> by Volvo.
- Only use tools and equipment designed for your car model. Contact a Volvo dealer for tool recommendations.
- Volvo recommends an authorised Volvo workshop for tasks not described in this manual.
- A portable jack designed for occasional and limited use is only suitable for short and urgent tasks, such as handling a puncture. A workshop jack is recommended for frequent or extended use.

### Other lifting equipment

- If using lifting equipment not supplied by Volvo <sup>[2]</sup>, carefully read their instructions before raising the car. Ensure that the equipment is compatible with the car.
- Use additional safety equipment such as axle stands and wheel blocks when applicable.
- When using workshop jacks or other lifting equipment designed for frequent and extended use, you should use separate lifting areas instead of the ones described in this instruction.

 **Warning**

### Safety around the car

- If you are changing a wheel in or close to traffic, make sure you and the car are clearly visible to others. Activate the hazard warning lights, put out a warning triangle in a visible but safe place and wear a reflective vest.
- Designate a safe area for passengers to wait, away from both the car and traffic.
- You are responsible for safety around the car while it is raised. Do not allow people to stay inside of or close to the car.

### Raising the car

- Never get under the car, or let anyone reach under it with any part of their body, while it is raised.
- Do not place any object between the ground and the jack, nor between the jack and the car's jacking point.
- Do not use lifting equipment that shows any sign of damage.

#### Before raising the car:

- Gather the tools and parts needed for your planned work.
- Make sure that the jack is in good condition, and that its threads are properly lubricated and free from dirt.
- To avoid accidentally triggering the alarm, reduce your car's alarm sensitivity.

1. Activate the parking brake.
2. Put the car into P using the gear selector.

3. Place wheel blocks to reduce the risk of car movement while raised. Large stones or wooden blocks work well. Place them both in front of and behind each wheel that will remain on the ground.
4. Locate the intended jacking point on the car's underbody.

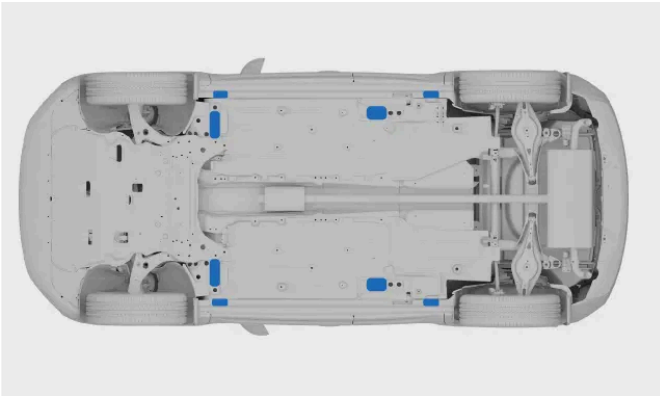

There are two jacking points on each side of the car.

5. Place the jack under the car's jacking point. The surface it stands on must be firm, non-slippery and level. Position the jack with the crank handle pointing away from the car.
6. Crank the jack up until its head slots into the car's jacking point. Ensure that the jack head's protruding piece fits into the jacking point slot.

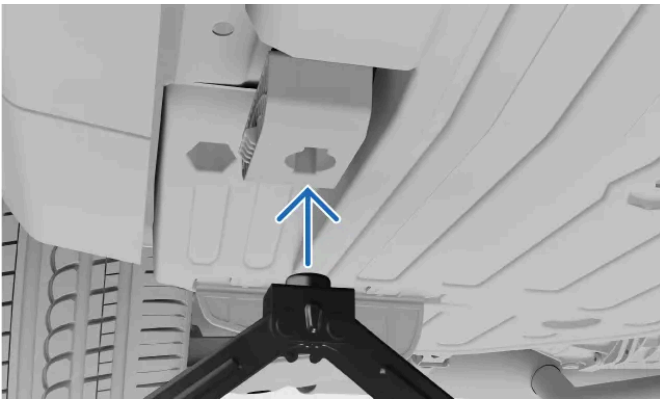

7. Make a final alignment. Make sure that:
  - the jack is not leaning in any direction
  - the base of the jack is centred under the jacking point
  - the jack head meets the jacking point correctly.

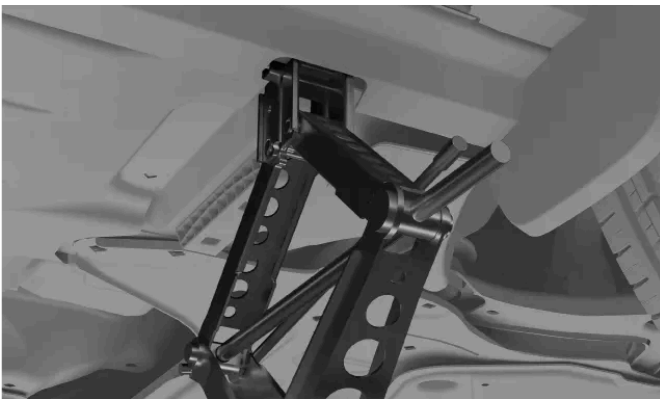

8. Raise the car to an appropriate height. Do not raise it higher than what's necessary for the work you're doing.

 **Warning**

Do not leave the car unsupervised when raised.

Carefully lower the car when you have finished your work. Remember to test important car features that may have been affected by the work you performed.

Put the jack back in its storage place.

Jack mode will deactivate as soon as you start to drive.

[1] Depending on market, a jack for occasional and limited use may be included with the car.

[2] Such as workshop jacks or other lifting equipment designed for frequent and extended use

---

## 13.9.1. Workshop lifting areas

You can use a workshop jack or lifting equipment designed for frequent and extended use when you raise the car off the ground. However, when you do, you need to ensure that it's placed on the car's lifting areas.

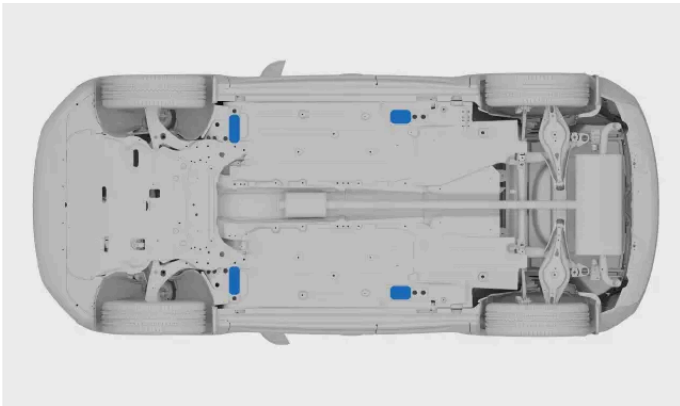

Lifting areas used for workshop equipment.

The lifting areas to use with workshop equipment are placed by the outer corners of the battery tray. They are just behind the common jacking points, close to the ribbed area.

 **Important**

It is very important to place the workshop jack on the car's lifting areas or the battery may get damaged.

If you're using a workshop jack, make sure that the jack plate is fitted with a rubber guard to protect the car as well as ensure that the car remains stable.

If using lifting equipment not supplied by Volvo, carefully read their instructions before raising the car. Ensure that the equipment is compatible with the car.

To avoid accidentally triggering the alarm, reduce your car's alarm sensitivity before lifting it.

 **Note**

You must activate jack mode before raising the car off the ground.

## 13.10. Servicing and repairs

Properly performed maintenance, servicing and repairs are essential for keeping your car in good working condition.

Your car keeps track of when it was last serviced and tells you when it's time to make a new appointment. It can self-diagnose many types of faults and notify you if you need to take action.

If you notice any service or repair needs that have not been detected by the car, contact Volvo support.

Volvo recommends an authorised Volvo workshop for all servicing and repair needs.

 **Important**

### Faults and notifications

If a notification in the car calls for a service, make a service appointment as soon as you can. The car status view in the centre display also contains information about detected issues.

 **Warning**

- Do not handle or modify the car's electrical components. Only perform actions that are clearly described in the user manual.
- High-voltage components can produce or conduct lethal currents and must only be handled by authorised technicians.
- Do not perform repairs on the car's electrical system or components. Contact an authorised Volvo workshop for any required repairs or servicing.

## Volvo's recommended service programme

Volvo recommends engaging an authorised Volvo workshop to perform any service and maintenance work. Volvo workshops have the personnel, special tools and service literature required to provide high-quality servicing. Volvo's recommended service programme has been developed to give your car a long service life. Servicing your car according to its customised service programme may be a prerequisite for coverage under Volvo's warranties. Your car's service and warranty information <sup>[1]</sup> contains more details about maintenance service and warranty terms and conditions.

<sup>[1]</sup> This is a separate publication included with your car.

---

## 13.10.1. Booking service or repairs

Volvo support handles bookings when you need a service or repair appointment. Authorised Volvo workshops have specialised training and equipment to take care of your car.

Your car notifies you when it's time for servicing.

1. Contact Volvo support to book an appointment. They can locate your closest service point.

If you're unable to reach Volvo support and urgently need servicing or repairs, contact a roadside assistance service available in your location.

Make sure to bring your car's standard key to the service appointment.

---

## 13.10.2. On-board diagnostic port

Your car has a diagnostic port that allows a workshop to connect to the car and communicate with its systems. Do not connect equipment that has not been authorised by Volvo.

The diagnostic port is of the type OBDII.

The diagnostic port is located on the underside of the dashboard, close to the bonnet release lever.

Improper use of the diagnostic port can negatively affect the car's systems and software. This includes connecting unauthorised equipment <sup>[1]</sup> and installation of software or diagnostic tools.



### Warning

#### Unauthorised equipment

Volvo accepts no liability if unauthorised equipment is connected to the on-board diagnostic port. Contact an authorised Volvo workshop for more information.

[1] Equipment not approved by Volvo.

---

## 14. Immobilised car and recovery

If you can't drive your car, it's considered to be immobilised. You can always contact an authorised Volvo workshop if you're unable to find a solution in the manual or if you are uncertain about how to proceed.

Depending on the nature of the problem, you may be able to solve it on your own or with assistance from an authorised Volvo workshop or other services. In this part of the manual, you will find a number of scenarios and how to handle them safely.

In a situation where there are injuries or risk of injury, prioritise safety and medical needs over car recovery. Don't hesitate to contact emergency services if necessary.

The following scenarios have their own manual sections that can help you identify the underlying issue and what the necessary steps for recovery are.

- The car malfunctions and the car can't be used as intended.
- The battery is flat and the car is unresponsive.
- There is physical damage to the car. The damage can make the car unsuitable to drive or cause immobilisation. Even superficial damage needs to be evaluated to ensure that you can safely use the car.

---

### 14.1. Damaged car

If your car is damaged, it is important to identify the extent and severity of the damage to determine how to handle the car safely.

Damage can immobilise your car or make it unsafe to drive.

Contact an authorised Volvo workshop if your car has been damaged or if it shows signs of damage sustained while parked. If the damage immobilises or severely impairs the car's performance, recovery through a roadside assistance and recovery service is necessary.

#### Important

##### Minor damage

Your car can self-diagnose many defects, but it can't detect all types of damage or predict their consequences. A small impact resulting in superficial damage can disturb components behind the affected area, such as misaligning a parking sensor behind a bumper. It is therefore important to have seemingly minor or superficial damage examined by a trained technician to determine the full extent of the damage.

### Immobilising damage

There are several types of damage that can immobilise the car. They include, but are not limited to:

- Collision damage
- Puncture
- Windscreen damage

**The content of this manual represents the status of the user manual at the time of printing and may not be completely valid in future instances. For more information, refer to the first page for the complete disclaimer note.**

- Water damage
- Mechanical failure

## Collision damage

After a severe enough collision, your car enters safety mode and needs to be recovered.

### Important

If possible, do not try to drive or move the car after a severe collision. If the car poses an acute traffic hazard, an exception can be made to move it a short distance out of immediate danger if the state of the car allows it.

## Water damage

Water damage can cause permanent damage to your car and severely affect how well it works.

### Important

Simply drying the car out or allowing it to dry will often be insufficient to resolve significant water damage. A trained technician should examine any water damage to determine its full extent and severity.

## Mechanical damage

The best way to avoid mechanical failures is to follow the intended use and to regularly maintain your car. It is important to continuously perform check-ups of your car.

---

## 14.2. Malfunction

When part of your car or one of its features is not working as designed, that counts as a malfunction.<sup>[1]</sup> It may not be safe to use your car at all, depending on what type of malfunction the car is experiencing.

### Note

#### Immobilised car

You should consider the car to be immobilised if a malfunction prevents you from driving safely.

#### Unresponsive car

There is a separate section in this manual for power-related issues.

## General advice for malfunctions

If a function doesn't work properly, try the following actions:

- Read what the manual has to say about the function. Make sure that you are aware of what's required for it to work properly. The cause of the problem might be that you are unaware of a limitation of a specific function.
- Restart all related devices and systems. This applies to the car itself but can also include your phone or an app.
- If there is more than one way to use a function or perform a task, try the alternatives.

**i Note**

### Changes after software updates

Software updates can introduce changes to functions that affect how they work. Be sure to read the information provided with each update so that you understand why the car may behave differently.

## Possible causes

When a function isn't working the way you expect it to, there are several possible causes:

- The car's settings have been changed.
- Environmental conditions are affecting the car and its systems.
- Signal interference is affecting connectivity and wireless systems.
- A fuse has blown and needs to be replaced.
- Software error.
- Mechanical failure.

## Contact an authorised Volvo workshop if needed

If you can't solve the problem using the information in the manual, contact an authorised Volvo workshop.

Take note of what happened around the time the problem appeared. It may help identify the cause. A key event could be:

- Damage to the car.
- Exposure to extreme conditions.
- Recently performed servicing, maintenance or replacement of a component.
- Recently updated software.
- Any other faults or malfunctions.

<sup>[1]</sup> In some cases, a suspected fault or failure may instead be an intentional limitation under the conditions experienced by the car.

---

## 14.3. Powerless or unresponsive car

If your car is unresponsive or appears to have no power, the cause could be a flat battery or something affecting its electrical systems.

If the car's battery is flat, the car will not respond to some of your actions. This can include trying to unlock or start it.

## Recovery from a flat 12 V battery

If the 12 V battery goes flat, the car will be completely unresponsive. This can happen if something prevents the 12 V battery from being charged while driving.

Suggested recovery actions are:

- Try charging the 12 V battery using an external charger or jump start the car with an external battery.
- Contact an authorised Volvo workshop or a recovery and roadside assistance service.

## Other no-power scenarios

There may be cases where you are fairly sure that the battery level is not low. In these cases, a lack of power indicates that the 12 V battery can't deliver power to the car.

Possible scenarios that affect the 12 V battery's power delivery are:

- A fuse has blown and needs to be replaced.
- The 12 V battery is defective.
- There is an electrical, hardware or software fault preventing the car from turning on.

If you can't identify the cause of the problem or solve it by referring to the manual, contact an authorised Volvo workshop.

---

## 14.3.1. Jump starting your car

If the 12 V battery level is below a certain point, you need to jump start your car with an external source. Read through the information before you start and perform each step carefully.

### **Warning**

- If the 12 V battery has been disconnected, the windows' pinch protection needs to be reset.
- The battery can generate oxyhydrogen gas which is highly explosive.
- The battery contains sulphuric acid which can cause serious burns and corrosion. If the sulphuric acid comes into contact with skin or clothes, rinse them with plenty of water. If the acid gets into eyes, seek medical attention immediately.
- Never smoke near the battery.

### **Do not use 48 V components**

- Do not touch components which are not clearly described in the user manual. Components with 48 V can be dangerous if handled incorrectly.
- Never use the 48 V battery to jump start another vehicle.
- Never connect any external equipment to the 48 V battery.

**!** Important

### Do not charge another car

The charging points on your car's 12 V battery are only meant for charging your own car. Do not attempt to charge another car.

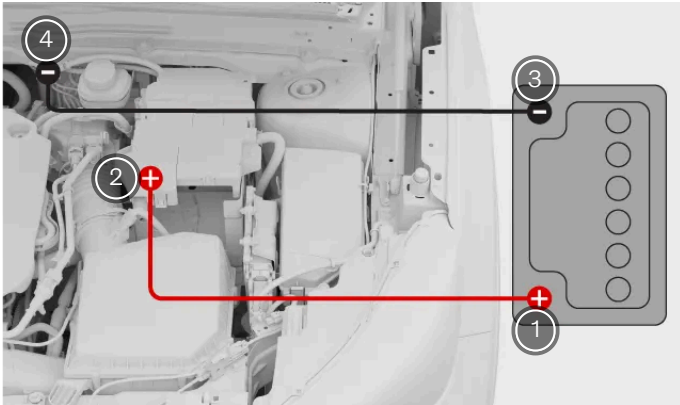

Jumper lead connection

- ① External battery's positive terminal.
- ② Positive terminal on your car's 12 V battery.
- ③ External battery's negative terminal.
- ④ Negative terminal on your car.

There are some tasks you need to do before jump starting your car.

- You need access to an external charger or 12 V battery, such as in another car, and a pair of jumper leads.
- Make sure your car is turned off.
- If using another car's 12 V battery, make sure its engine is off and that the cars are not in contact with each other.

#### Connecting the cables

1. Attach the red jump lead to the external battery's positive terminal.

**!** Warning

Make sure that the jump leads only come into contact with the charging terminals in the engine compartment. Carefully avoid the jump leads contacting other components.

2. Remove the cover for the positive terminal on your car's 12 V battery and attach the other end of the red lead to the terminal.
3. Attach the black jump lead to the external battery's negative terminal.
4. Attach the other end of the black lead to the negative terminal on your car.
5. Check that the clamps are properly attached. Poor contact can cause sparks or the clamps to loosen during the start attempt.

The content of this manual represents the status of the user manual at the time of printing and may not be completely valid in future instances. For more information, refer to the first page for the complete disclaimer note.

### Start attempt

6. Activate the external battery and charge your car's battery for a few minutes. If you are using the battery on another car, let its engine run at a slightly higher idling speed than normal, approx. 1500 rpm.

 **Warning**

Do not touch the leads or clamps while either battery is active. There is a risk of creating sparks.

7. Start your car.
  - > If the start attempt fails, keep charging for 10 minutes and then try again.
8. While your car is still running, remove the leads in the opposite order to how you installed them. First remove the black lead from your car and then the black lead from the external battery. Next, remove the red lead from your 12 V battery and then the red lead from the external battery. Make sure that the black jump lead does not touch any of the positive terminals or the red jump lead.

Keep your car running for a while to charge the 12 V battery. It charges better while you drive.

 **Note**

Make sure the start and stop feature is disabled until the battery has had enough time to recharge. Otherwise, there is a risk that the auto-start will fail.

## 14.4. Recovery

Recovery of your car typically requires transporting it with a recovery vehicle. This is necessary if the car is immobilised and its functions cannot be restored where it is.

Contact an authorised Volvo workshop if you need to recover your car.<sup>[1]</sup>

The recommended recovery procedure depends on the conditions and state of the car. If your car is damaged and is in safety mode, it must not be towed and should be lifted onto the recovery vehicle's platform.

 **Important**

### Wheels off the ground

Regardless of your car's condition, it must be transported with all wheels off the ground when recovered. Forced wheel rotation during transportation can severely damage the car.

### Keep a safe distance

Do not allow anyone to stand directly behind your car if it is pulled onto the recovery vehicle.

<sup>[1]</sup> For urgent recovery needs, you can also directly contact a recovery and roadside assistance service.

---

## 14.5. Safety mode

If your car detects damage that compromises safety, it can enter safety mode.

Safety mode limits the available functions when your car has sustained damage. The car must undergo damage assessment and repairs<sup>[1]</sup> if safety mode has been activated. Contact an authorised Volvo workshop if safety mode has been activated for any reason.

The displays clearly indicate when the car is in safety mode, if they are still functioning.

When safety mode is active, you cannot drive the car. However, if you need to move your car out of immediate danger, you can try to exit safety mode by restarting your car. Driving the car after safety mode has been deactivated should be done with caution and only for very short distances, such as to the side of the road.

### Important

When you exit safety mode, the car performs a safety check-up. This is communicated in the driver display. If the check-up fails, you cannot exit safety mode to move the car.

### Warning

Only attempt to exit safety mode if the damage to the car is minor and there is no fuel leakage. Never, under any circumstances, attempt to restart your car if it smells of fuel when the safety mode message is shown. Leave the car at once.

Resetting your car's status without performing damage assessment and repairs can result in further damage to the car as well as personal injury.

<sup>[1]</sup> Volvo recommends an authorised Volvo workshop

---

## 14.6. Having your car towed

Your car can be towed short distances, such as onto a recovery vehicle, if necessary.

### Important

- To avoid accidentally triggering the alarm, reduce your car's alarm sensitivity before towing it.

The towing eye can be used to pull your car up onto a recovery vehicle with a flatbed platform.

**The content of this manual represents the status of the user manual at the time of printing and may not be completely valid in future instances. For more information, refer to the first page for the complete disclaimer note.**

 **Important**

Your car should not be towed if it's in safety mode.

Location and ground clearance should also be considered when determining if it can be towed onto a tow truck.

1. Tow your car onto a recovery vehicle or to a safe place, such as the side of the road.
2. When the car is in the necessary place, engage the parking brake.
3. If necessary, remove the towing eye and winch wire.

 **Important**

Always use a recovery vehicle to transport the car whenever it cannot be driven. Forced wheel rotation during transportation can severely damage your car. Make sure the car is only transported by a recovery vehicle such as a flatbed, so that the car's wheels do not touch the ground while being transported.

# 15. Specifications

These specifications describe your car in technical terms and figures. You might need to find some of these details, such as when buying new tyres.

This information is divided up in the following manner, with some examples of their content to help guide you.

- General car characteristics – dimensions, weights and type designations.
  - Powertrain specifications – performance, engine, fuel tank volume and fuel consumption.
  - Wheel and tyre specifications – approved tyre pressures and tyre sizes.
  - Fluid specifications – engine oil, brake fluid and air conditioning coolant.
  - Certificates and type approvals
- 

## 15.1. General car characteristics

These are the basic facts about your car. This data helps you determine your car's specific set-up.

You may need to know these things about your car for a number of reasons. For example, to be able to order the correct spare parts or accessories.

---

### 15.1.1. Car dimensions

Here you can find your car's measurements, such as length and height.

Locate the measurement you're looking for in the images first, then check the corresponding letter in the table below.

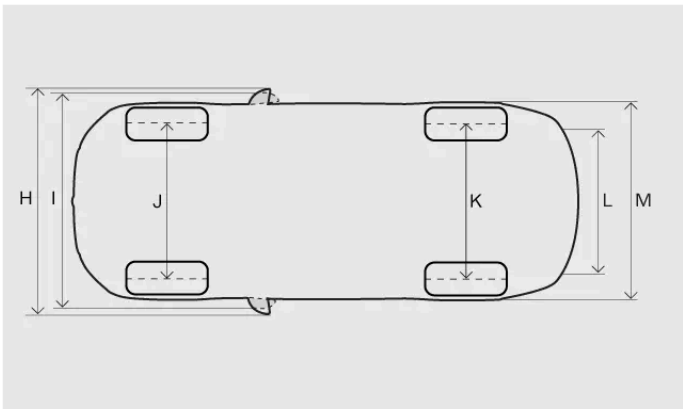
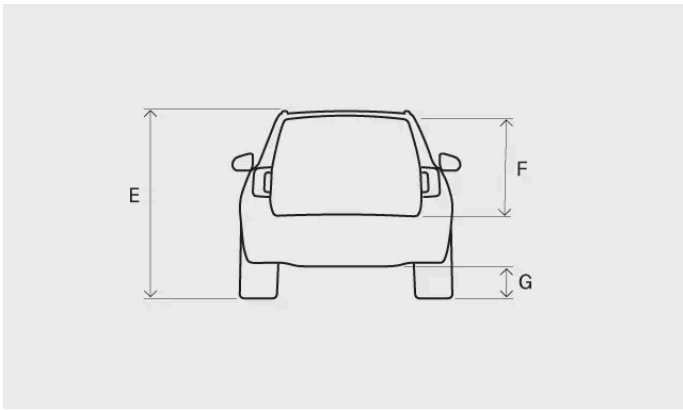
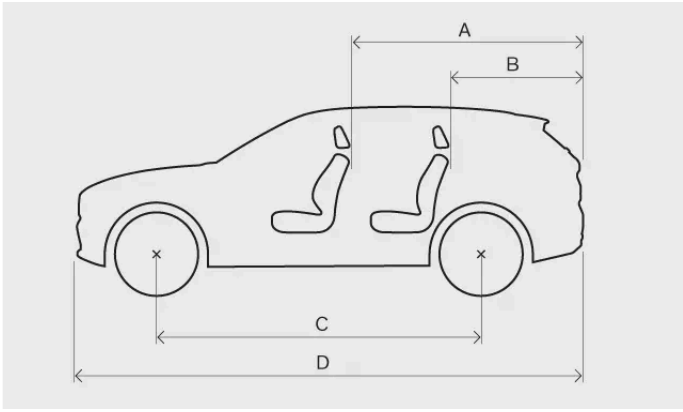

Measurement		Millimetres	Inches
A	Load length, floor, folded seat	1670	65.7
B	Load length, floor	887	34.9
C	Wheelbase	2702	106.4
D	Length	4440	174.8
E	Height <sup>[1]</sup>	1652	65.0
F	Load height	733	28.9
G	Ground clearance <sup>[1]</sup>	205	8.1
H	Width including folded-out wing mirrors	2034	80.1
I	Width including folded-in wing mirrors	1938	76.3
J	Front track	1601	63.0

Measurement		Millimetres	Inches
K	Rear track	1626	64.0
L	Load width, floor	1059	41.7
M	Width	1873 (1863 <sup>[2]</sup> )	73.7 (73.3 <sup>[2]</sup> )

[1] At kerb weight plus one person.

[2] Body width.

## 15.1.2. Weights

Your car's maximum gross vehicle weight can be read on a label in the car.

### Weight terminology

**Kerb weight** Weight of the car, including the driver, all oils, fluids and standard equipment. This does not include passengers, cargo, optional equipment or towball load when there is a trailer connected.

**Permitted maximum load** Gross vehicle weight - Kerb weight

**Maximum gross vehicle weight** Kerb weight + cargo + passengers

The documented kerb weight applies to cars in the standard version, such as a car without extra equipment or accessories. This means that for every accessory added, the loading capacity of the car is reduced correspondingly by the weight of the accessory.

Weighing the car is a sure way to determine the kerb weight of your own particular car.



#### Warning

The car's driving characteristics change depending on how heavily it is loaded and how the load is distributed.

### Label weights

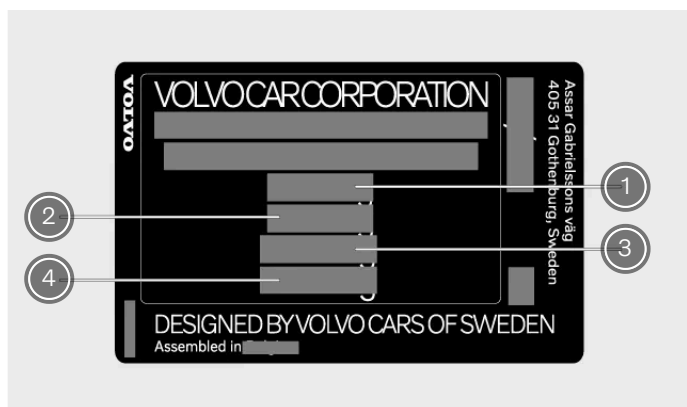

The label is located on the right-hand door pillar and will be visible when the door is opened.

- ① Maximum gross vehicle weight
- ② Maximum train weight (car+trailer)
- ③ Maximum front axle load
- ④ Maximum rear axle load

## Maximum load

**Maximum load** See your car's registration document.

**Maximum roof load** 75 kg

---

### 15.1.3. Towing specifications and capabilities

Towing weights and towball loads for driving with a trailer can be viewed below.

 **Important**

Always follow local rules and regulations when driving with a trailer, such as speed for the vehicle combination.

 **Note**

Use of stabiliser coupling on the towbar is recommended for trailers heavier than 1800 kg.

#### Braked trailer

**Max. trailer weight** 1600 kg

**Max. towball load** 100 kg

#### Unbraked trailer

**Max. trailer weight** 750 kg

---

### 15.1.4. Towbar specifications

Here you can find measurements related to your towbar.

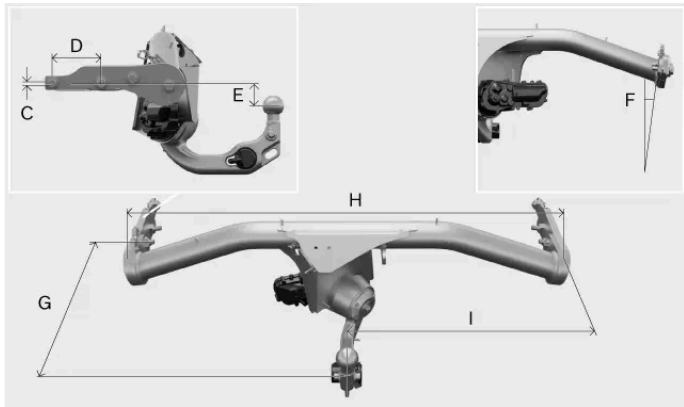
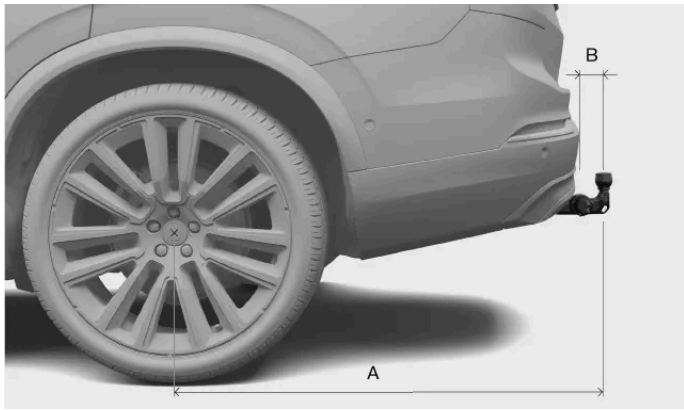

Dimensions, mounting points in mm (inches)

- A 939 (37)
- B 72 (2.8)
- C 6 (0.24)
- D 145 (5.7)
- E 88 (3.5)
- F Side beam has 8-degree angle.
- G 353 (13.9)
- H 1048 (41.3)
- I 524 (20.6)

---

## 15.1.5. Type designations

Knowing the car's detailed information can help facilitate contact with a Volvo dealer and when ordering spare parts and accessories.

## Labels

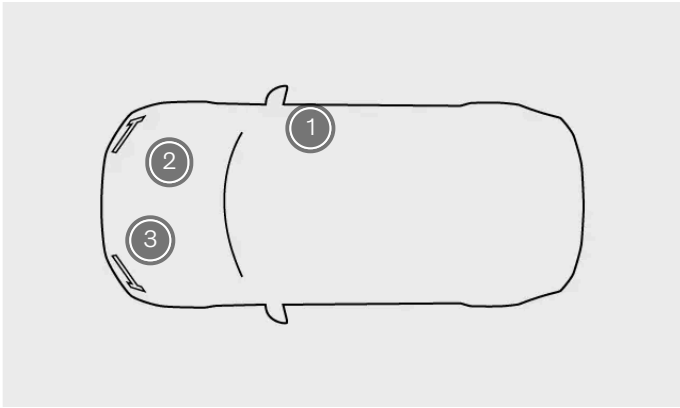

Label locations

- ① Product label
- ② Engine number label
- ③ Gearbox label

The product label is located on the right-hand door pillar and will be visible when the door is opened.

The engine number label is located on the engine. For certain engine alternatives, there is no label. In these cases you can read the engraved engine code on the engine instead.

The gearbox label is located on the gearbox.

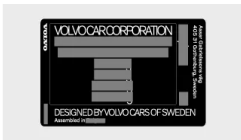

Product label

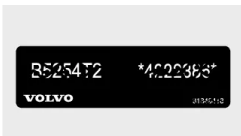

Engine number label

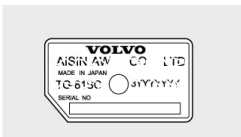

Gearbox label

Examples of information you can find on the product label:

- Type approval number
- Vehicle identification number
- Weight information
- Code designation for exterior colour

**Note**

Labels depicted in this manual are generic representations of those found around your car. The manual only contains their location and what kind of information they hold. Find the actual label for specific information about your car.

**Tip**

For many markets, more information can also be found in the car's registration document.

## 15.2. Powertrain specifications

Find the specifications regarding your car's propulsion.

These specifications provide details about what your car is capable of and certified for.

### 15.2.1. Engine specifications

The car is driven by a combustion engine and you can find the specifications here.

B420T4		
Max. power output	kW/rpm	120/4750–5250
	kW/rps	120/79–87
	hp/rpm	163/4750–5250
Max. rated power	kW/rpm	N/A
	hp/rpm	N/A
Max. torque	Nm/rpm	265/1500-4000
	Nm/rps	265/25-67
	lb-ft/rpm	195/1500-4000
No. of cylinders		4

**Note**

If data is missing it will be updated at a later stage.

### 15.2.2. Fuel consumption and CO2 emissions

The content of this manual represents the status of the user manual at the time of printing and may not be completely valid in future instances. For more information, refer to the first page for the complete disclaimer note.

These are the certified values for your car's fuel consumption and emissions. However, fuel consumption varies according to the circumstances and driving conditions. These values should not be interpreted as an expected fuel consumption but should primarily be used to compare different cars.

## Procedure used to establish the values

The values in the table below are established in accordance with WLTP<sup>[1]</sup>, which is an international test method performed in a laboratory environment. The method uses drive cycles to simulate an average driving run of the car. Every drive cycle is determined by different conditions such as speed, time and mileage.

The standard is based on four drive cycle profiles with different average speeds:

- Urban driving**      Low speed
- Suburban driving**    Medium speed
- Extra-urban driving**   High speed
- Motorway driving**    Extra high speed

## Symbol explanation

This is an explanation of the symbols used in the specification table below.



Urban driving.



Suburban driving.



Extra-urban driving.



Motorway driving.



Combined value (mixed driving).

CO<sub>2</sub>

Gram CO<sub>2</sub>/km.



Litre/100 km.













Low value.



High value.

## Specifications for fuel consumption and emissions

B420T4										
										
	CO <sub>2</sub>		CO <sub>2</sub>		CO <sub>2</sub>		CO <sub>2</sub>		CO <sub>2</sub>	

The content of this manual represents the status of the user manual at the time of printing and may not be completely valid in future instances. For more information, refer to the first page for the complete disclaimer note.

	199	8.7	141	6.2	124	5.5	151	6.7	147	6.5
	209	9.2	155	6.8	139	6.1	174	7.7	164	7.2

 **Note**

If data is missing in the table, it will be updated at a later date.

## Certified values and actual values

When driving, the car's fuel consumption can differ from the certified values. Some reasons for this may be:

- Driving style.
- Extra equipment and cargo affect the car's weight or air resistance.
- Non-standard wheels can increase rolling resistance and air resistance.
- High speed causes increased air resistance.
- Road, traffic and weather conditions.
- The general condition of the car.
- Fuel grade.

<sup>[1]</sup> Worldwide Harmonised Light-Duty Vehicles Test Procedure

## 15.2.3. Fuel tank volume

The fuel tank's filling capacity can be read below.

**Volume** Approx. 54 litres (14.2 US gallons) (11.8 UK gallons)

## 15.3. Wheel and tyre specifications

Here you can find specific data for wheels and tyres applicable to your car.

 **Note**

There are more recommendations regarding wheels and tyres that are important to be aware of.

## 15.3.1. Approved tyre pressure

You can find the approved tyre pressures for your car in the table below.

The recommended pressure for approved tyres can be found on the tyre pressure label. It's located on the door pillar on the driver's side and is visible when the door is opened.

Tyre size	Speed	Load 1-3 persons		Max load		ECO pressure
		Front kPa (psi)	Rear kPa (psi)	Front kPa (psi)	Rear kPa (psi)	Front/rear kPa (psi)
235/60 R17 235/55 R18 235/50 R19 245/45 R20 245/40 R21	0-180 km/h (0-112 mph)	230 (33)	230 (33)	260 (38)	260 (38)	260 (38)
Temporary Spare Tyre	max 80 km/h (max 50 mph)	420 (60)	420 (60)	420 (60)	420 (60)	–

## 15.3.2. Approved wheel and tyre sizes

In some countries, approved sizes are not indicated by the car's registration documents. However, you can find all approved combinations of wheel rims and tyres below.

Tyre	Wheel rim
<b>235/60 R17</b>	7.5x17x50.5
<b>235/55 R18</b> <sup>[1]</sup>	7.5x18x50.5
<b>235/50 R19</b>	7.5x19x50.5
<b>245/45 R20</b>	8x20x50.5
<b>245/40 R21</b>	8x21x50.5

<sup>[1]</sup> 235/55 R18 on cars equipped with 18-inch brakes is only possible with approved wheels. Ask your Volvo dealer which brakes your car is equipped with.

## 15.3.3. Minimum permitted load index and speed rating for tyres

All tyres have specific speed and load limitations. Tyres must have a speed rating and load index that are equal to or higher than your car's maximum speed.

Your tyre's specification must be at least equal to or greater than:

Minimum permitted load index (LI) 98

Minimum permitted speed rating (SS) H

 **Warning**

If a tyre with a speed rating that is too low is used, it may overheat and become damaged.

 **Note**

### Winter tyres

Winter tyres<sup>[1]</sup> are allowed to have a lower speed rating than your car's top speed. However, if your winter tyres do have a lower speed rating than your car's top speed, you are not allowed to drive faster than the tyres' speed rating.

<sup>[1]</sup> Both studded and stud-free tyres.

---

## 15.4. Fluid specifications

Your car has fluids to help different systems function properly. When it is time to refill or perform maintenance, you may need to know the specific data for them.

For some fluids, it is recommended that they are changed or filled by an authorised Volvo workshop. Check this section for the fluid you need information on and, if necessary, contact an authorised Volvo workshop to schedule an appointment.

---

### 15.4.1. Engine oil specifications

The prescribed engine oil grade and volume can be read below.

Volvo recommends Castrol Edge Professional engine oil.

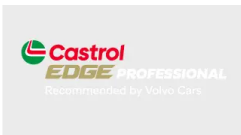

**Prescribed grade** Castrol Edge Professional V 0W-20 or VCC C6SP SAE 0W-20

**Volume (incl. oil filter)** approx. 6.1 litre (5.37 UK qt)

---

### 15.4.2. Transmission fluid specifications

The transmission fluid needs to be changed every 60,000 km.

## 15.4.3. Brake fluid specifications

The medium in your car's brake system is called brake fluid.

**Prescribed grade** Volvo Original or equivalent brake fluid that fulfils a combination of the Dot 4, 5.1 and ISO 4925 class 6 classifications.

### ! Important

It is recommended that brake fluid is changed or filled by an authorised Volvo workshop.

## 15.4.4. Climate system specifications

Here you find the information about the refrigerant quantity and the prescribed quality and volume for compressor oil.

### Climate system label



The label with information on climate system fluids is located on the underside of the bonnet.

On this label you can find:

- Refrigerant type
- Refrigerant quantity

### Label symbols



Caution



A trained and certified technician is required to service the mobile air conditioning system<sup>[1]</sup>



Flammable refrigerants



Mobile air conditioning system<sup>[1]</sup>



Lubricant type

## Compressor oil

**Volume** 130 ml (4.40 US fl oz) (4.58 UK fl oz)

**Prescribed grade** PAG SP-A2

## Servicing and repair of the climate system

### **Warning**

#### Servicing and repair

The climate system contains pressurised refrigerant. The climate system must only be serviced and repaired by trained and certified technicians in order to ensure the safety of the system<sup>[2]</sup>. Volvo recommends an authorised Volvo workshop for any repair or service needs.

### **Important**

#### Repairing the evaporator

The climate system's evaporator must never be repaired or replaced with a previously used evaporator. A new evaporator must be certified and labelled in accordance with SAE J2842.

<sup>[1]</sup> MAC

<sup>[2]</sup> In accordance with SAE J2845 (Technician Training for Safe Service and Containment of Refrigerants Used in Mobile A/C System).

---

## 15.5. Certificates and type approvals

This documentation shows that your car meets certain standards and specifications.

User manuals are required by law to provide documentation of certain certificates and type approvals.

For more information, contact Volvo support.







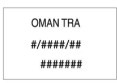

---

### 15.5.1. Type approvals for radar

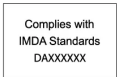
Find the radar type approval you're looking for among the ones listed here.

The content of this manual represents the status of the user manual at the time of printing and may not be completely valid in future instances. For more information, refer to the first page for the complete disclaimer note.



Regions	Labels and symbols	Specification
Mexico		IFT: RLVVE7719-1064 La operación de este equipo está sujeta a las siguientes dos condiciones: (1) es posible que este equipo o dispositivo no cause interferencia perjudicial y (2) este equipo o dispositivo debe aceptar cualquier interferencia, incluyendo la que pueda causar su operación no deseada.
Moldova		
Morocco		AGREE PAR L'ANRT MAROC Numéro d'agrément: MR_20098_ANRT_2019 Date d'agrément: 2019_06_14
Nigeria		Connection and use of this communications equipment is permitted by the Nigerian Communications Commission.
Oman		Registered No: R/7713/19 Dealer No: D172338
Paraguay		NR: 2019-07-I-0397
Serbia		I011 19
Singapore		DA 106706
South Africa		TA-2019/1378APPROVED
South Korea		R-C-1VN-77V12FLR
Taiwan		CCA19LP2310T1 [Placeholder text for Taiwan specification]
Thailand		1) [Placeholder text for Thailand specification 1] 2) [Placeholder text for Thailand specification 2]
Ukraine		UA RF: 1VEON2FLR справжнім VEONEER US, INC. заявляє, що тип радіобладнання 77V12FLR відповідає Технічному регламенту радіобладнання; повний текст декларації про відповідність доступний на веб-сайті за такою адресою: <a href="https://www.veoneer.com/en/regulatory">https://www.veoneer.com/en/regulatory</a>
United Arab Emirates		REGISTERED No: ER72325/19 DEALER No: 0020858/10
United Kingdom		Hereby, Veoneer US, Inc. declares that the radio equipment type 77V12FLR is in compliance with radio regulation 2017. Operational frequency band: 76 – 77 GHz/ Maximum output power: <55 dBm e.i.r.p <a href="https://www.veoneer.com/en/regulatory">www.veoneer.com/en/regulatory</a> [ <a href="https://www.veoneer.com/en/regulatory">https://www.veoneer.com/en/regulatory</a> ]







Regions	Labels and symbols	Specification
Nigeria		Connection and use of this communications equipment is permitted by the Nigerian Communications Commission.
Oman		Registered No: R/3957/17 Dealer No: D080134
Serbia		ИО11 17
Singapore		DA 103238
South Africa		TA-2016/3407APPROVED
South Korea		R-CMM-HLA-RS4 [Placeholder text]
Taiwan		CCAB17LP 0470T5 [Placeholder text]
Thailand		1) [Placeholder text] 2) [Placeholder text]
Ukraine		Цим HELLA GmbH & Co. KGaA заявляє, що радіотехнічне обладнання типу RS4 відповідає Технічному регламенту радіотехнічного обладнання та Директиві 2014/53/ЄС. Повний текст декларації про відповідність доступний за адресою: <a href="http://www.hella.com/vcc">www.hella.com/vcc</a> Частотний діапазон: 24,05 – 24,25 ГГц Потужність передачі: 20 дБм (макс.) EIRP
United Arab Emirates		Registered No: ER53878/17 Dealer No: DA44932/15
United Kingdom		Hereby, Hella GmbH & Co. KGaA declares that the radio equipment type RS4 is in compliance with Radio Equipment Regulations of the United Kingdom. The full text of the United Kingdom declaration of conformity is available at the following internet address: <a href="http://www.hella.com/vcc">www.hella.com/vcc</a> [ <a href="https://www.hella.com/vcc">https://www.hella.com/vcc</a> ] Technical information: Frequency band: 24.05 ... 24.25 GHz Transmission power: 20 dBm (max.) EIRP Manufacturer and Address: Hella GmbH & Co. KGaA Rixbecker Straße 75, 59552 Lippstadt, Germany
United States	FCC ID: NBG01RS4	This device complies with Part 15 of the FCC Rules. Operation is subject to the following two conditions: (1) this device may not cause harmful interference, and (2) this device must accept any interference received, including interference that may cause undesired operation. CAUTION TO USERS Changes or modifications not expressly approved by the party responsible for compliance could void the user's authority to operate the equipment.
Vietnam		C0173191017AF04A2

Regions	Labels and symbols	Specification
Zambia		ZMB/ZICTA/TA/2017/6/7

## 15.5.2. Type approvals for radio equipment



Find the radio equipment type approvals you're looking for amongst the ones listed here.

Region	Labels and symbols	Specification
European Union & EFTA		Hereby, Volvo Cars declares that all radio equipment is in compliance with Directive 2014/53/EU.
Japan		R 204-750001 This device is granted pursuant to the Japanese Radio Law and the Japanese Telecommunications Business Law. This device should not be modified (otherwise the granted designation number will become invalid).



## 15.5.3. Type approvals for wireless charger and NFC

What follows are the technical specifications and certificates for the wireless charger.

### Declaration of conformity

Argentina	 RAMATEL H-28936
Brazil	 ANATEL 05588-23-12116



United States	<p>FCC Statement: This device complies with Part 15 of the FCC rules. Operation is subject to the following two conditions:</p> <ol style="list-style-type: none"> <li>1. This device may not cause harmful interference, and</li> <li>2. This device must accept any interference received, including interference that may cause undesired operation.</li> </ol> <p>Please note that changes or modifications not expressly approved by the party responsible for compliance could void the user's authority to operate the equipment.</p> <p>This equipment has been tested and found to comply with the limits for a Class B digital device, pursuant to part 15 of the FCC Rules. These limits are designed to provide reasonable protection against harmful interference in a residential installation. This equipment generates, uses and can radiate radio frequency energy and, if not installed and used in accordance with the instructions, may cause harmful interference to radio communications. However, there is no guarantee that interference will not occur in a particular installation. If this equipment does cause harmful interference to radio or television reception, which can be determined by turning the equipment off and on, the user is encouraged to try to correct the interference by one or more of the following measures:</p> <ul style="list-style-type: none"> <li>• Reorient or relocate the receiving antenna.</li> <li>• Increase the separation between the equipment and receiver.</li> <li>• Connect the equipment into an outlet on a circuit different from that to which the receiver is connected.</li> <li>• Consult the dealer or an experienced radio/TV technician for help.</li> </ul> <p>This equipment complies with radio frequency exposure limits set forth by the FCC for an uncontrolled environment. This equipment should be installed and operated with a minimum distance of 20 cm between the device and the user or bystanders. This device must not be co-located or operating in conjunction with any other antenna or transmitter.</p>
Vietnam	
Zambia	

## 15.5.4. Type approval for on-board diagnostics port

Here you can find the type approval for the on-board diagnostics port.

Region	Specification
Canada	IC: 20839-ACU1106 This unit corresponds with Industry Canada licensed RSS-standards. Use is permitted under the following two conditions: (1) This unit must not cause Interference and (2) this unit must be able to withstand any received Interference, including interference that can cause unwanted functions.
United States of America	FCC ID: 2AGKKACU11-06 This unit corresponds with section 15 of the FCC regulations. Use is permitted under the following two conditions: (1) This unit must not cause dangerous Interference and (2) this unit must be able to withstand any received Interference, including interference that can cause unwanted functions.

## 15.5.5. Type approval for anti-theft systems

The following information contains type approvals for the anti-theft systems.

### Alarm system

Country	Specification
Canada	<p>Canada IC: 4405A-DA 5823(3)</p> <p>This device is subject to the following conditions:</p> <ol style="list-style-type: none"> <li>1. This device may not cause harmful interference, and</li> <li>2. this device must accept any interference received, including interference that may cause undesired operation.</li> </ol>
United States	<p>USA FCC ID: MAYDA 5823(3)</p> <p>This device complies with part 15 of the FCC rules.</p> <p>Operation is subject to the following conditions:</p> <ol style="list-style-type: none"> <li>1. This device may not cause harmful interference, and</li> <li>2. this device must accept any interference received, including interference that may cause undesired operation.</li> </ol>

## Immobiliser and Passive Entry/Passive Start systems

Country	Specification
Canada	<p>Canada-IC: 3659A-VO3134</p> <p>This device complies with Industry Canada license-exempt RSS standards. Operation is subject to the following two conditions:</p> <p>Operation is subject to the following two conditions:</p> <ol style="list-style-type: none"> <li>1. This device may not cause harmful interference, and</li> <li>2. this device must accept any interference received, including interference that may cause undesired operation.</li> </ol> <p>Le présent appareil est conforme aux CNR d'Industrie Canada applicables aux appareils radio exempts de licence.</p> <p>L'exploitation est autorisée aux deux conditions suivantes:</p> <ol style="list-style-type: none"> <li>1. l'appareil ne doit pas produire de brouillage, et</li> <li>2. l'utilisateur de l'appareil doit accepter tout brouillage radioélectrique subi, même si le brouillage est susceptible d'en compromettre le fonctionnement.</li> </ol>
United States	<p>USA-FCC ID: LTQVO3134</p> <p>This device complies with part 15 of the FCC rules.</p> <p>Operation is subject to the following two conditions:</p> <ol style="list-style-type: none"> <li>1. This device may not cause harmful interference, and</li> <li>2. this device must accept any interference received, including interference that may cause undesired operation.</li> </ol> <p>Any changes or modification not expressly approved by the party responsible for compliance could void the user's authority to operate this equipment.</p>





## 15.5.6. Key systems certification

Here you can find standards compliance certifications for the keys.



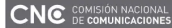







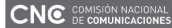





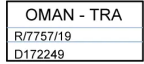

CEM marking for the remote control key system. For supplementary type approval numbers, see the following tables.

Lock system keyless start (Passive Start) and keyless locking/unlocking









Country/Region	Compliance	Label
Argentina		 H-25867
Brazil	MT-3245/2015	 MT-3245/2015
Canada	Volvo Standard Key IC: 4008C-HUF8423MS Volvo Tag ID IC: 4008C-HUF8432MS This device complies with part 15 of the FCC Rules and Industry Canada license-exempt RSS standard(s). Operation is subject to the following two conditions: 1. This device may not cause harmful interference, and 2. this device must accept any interference received, including interference that may cause undesired operation. Le présent appareil est conforme aux CNR d'Industrie Canada applicables aux appareils radio exempts de licence. L'exploitation est autorisée aux deux conditions suivantes : 1. l'appareil ne doit pas produire de brouillage, et 2. l'utilisateur de l'appareil doit accepter tout brouillage radioélectrique subi, même si le brouillage est susceptible d'en compromettre le fonctionnement.	
Europe	Hereby, Delphi Deutschland GmbH, 42367 Wuppertal declares that this VO3-134TRX is in compliance with the essential requirements and other relevant provisions of Directive 2014/53/EU (RED). The original declaration of conformity can be accessed at the following link <a href="http://www.delphi.com/automotive-homologation">www.delphi.com/automotive-homologation</a> [ <a href="https://www.delphi.com/automotive-homologation">https://www.delphi.com/automotive-homologation</a> ]	
Indonesia	Nomor: 38301/SDPPI/2015	
Jordan	TRC/LPD/2014/250	
Malaysia	RAAT/37A/1215/S(15-5198)	
Mexico	IFETEL: RLVDEVO15-0396	
Namibia	TA-2016-02	
Russia		
Serbia	P1614120100	
South Africa	TA-2014-1868	
United Arab Emirates	ER37847/15 DA0062437/11	
United States	Volvo Standard Key FCC ID: YGOHUF8423MS Volvo Tag ID FCC ID: YGOHUF8432MS This device complies with part 15 of the FCC Rules. Operation is subject to the following conditions: 1. This device may not cause harmful interference, and 2. this device must accept any interference received, including interference that may cause undesired operation. CAUTION: Changes or modifications not expressly approved by the party responsible for compliance could void the user's authority to operate the equipment.	







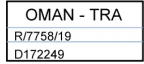

Remote control key

Country/Region	Compliance	Label
Argentina		 H-23694
Belarus		
Brazil	Anatel: 06768-19-06643 Modelo: HUF8423MS Este equipamento opera em caráter secundário isto é não tem direito a proteção contra interferência prejudicial, mesmo de estações do mesmo tipo, e não pode causar interferência a sistemas operando em caráter primário.	 06768-19-06643
Chile		 HUF8423MS
Europe	Hereby, Huf Hülsbeck & Fürst GmbH & Co. KG declares that the radio equipment type HUF8432 is in compliance with Directive 2014/53/EU. The full text of the EU declaration of conformity is available at the following internet address: <a href="http://www.huf-group.com/eudoc">http:// www.huf-group.com/eudoc</a> . Frequency band: 433,92 MHz Maximum Transmission Power: 10 mW Manufacturer: Huf Hülsbeck & Fürst GmbH & Co. KG Steeger Str. 17 42551 Velbert Germany	
Ghana	NCA Approved: ZRO-M8-7E3-138	
Indonesia	Sertifikat Nomor: 118151/DJID/2026 PLG ID: 13809	 <small>Harap perhatikan perubahan spesifikasi yang dapat menimbulkan gangguan jika dimatikan, elektroniknya harus diuji dengan selanjutnya.</small> 
Customs Union Kazakhstan, Russia		
Moldova		
Morocco	AGREE PAR L'ANRT MAROC Numéro d'agrément: MR 20402 ANRT 2019 Date d'agrément: 10/07/2019	

Country/Region	Compliance	Label
Nigeria	Connection and use of this communication equipment is permitted by the Nigerian Communications Commission	
Oman		
Philippines	ESD-1919938C	
Paraguay	HUF8423MS	
Serbia		
Singapore	Complies with IMDA Standards DA103787	
South Africa	TA-2019/772	
Taiwan	<p>????????????????????</p> <p>????????????????</p> <p>1.</p> <p>????????????????????</p> <ul style="list-style-type: none"> <li>????????????????</li> </ul> <p>2.</p> <p>????????????????</p> <ul style="list-style-type: none"> <li>????????????????</li> <li>????????????????</li> </ul> <p>????????????????</p> <p>?????</p>	
United Arab Emirates		
Ukraine	Справжнім Huf Hülsbeck & Fürst GmbH & Co KG заявляє, що тип радіобладнання відповідає Технічному [HUF8423MS] регламенту радіобладнання; повний текст -декларації про відповідність доступний на веб сайті за такою адресою: <a href="http://www.huf-group.com/eudoc">http:// www.huf-group.com/eudoc</a> Робоча частота: 433,92 ГГц	
Vietnam		
Zambia		

Key tag

Country/Region	Compliance	Label
Argentina		 H-23695
Belarus		
Brazil	Anatel: 04362-16-06643 Modelo: HUF8432MS Este equipo opera em caráter secundário isto é não tem direito a proteção contra interferência prejudicial, mesmo de estações do mesmo tipo, e não pode causar interferência a sistemas operando em caráter primário.	 04362-16-06643
Chile		 HUF8432MS
Europe	Hereby, Huf Hülsbeck & Fürst GmbH & Co. KG declares that the radio equipment type HUF8432MS is in compliance with Directive 2014/53/EU. The full text of the EU declaration of conformity is available at the following internet address: <a href="http://www.huf-group.com/eduldoc">http:// www.huf-group.com/eduldoc</a> . Frequency band: 433,92 MHz Maximum Transmission Power: 10 mW Manufacturer: Huf Hülsbeck & Fürst GmbH & Co. KG Steeger Str. 17 42551 Velbert Germany	
Ghana	NCA Approved: ZRO-M8-7E3-139	
Indonesia	Sertifikat Nomor: 119085/DJID/2026 PLG ID: 13809	 <small>Harap perhatikan perubahan spesifikasi yang dapat menimbulkan gangguan jika dimatikan, elektroniknya harus selalu terdapat saat dinyalakan.</small> 
Philippines	ESD-1919939C	 Type Approved No.: ESD-1919939C
Moldova		
Morocco	AGREE PAR L'ANRT MAROC Numéro d'agrément: MR 20403 ANRT 2019 Date d'agrément: 10/07/2019	

Country/Region	Compliance	Label
Nigeria	Connection and use of this communications equipment is permitted by the Nigerian Communications Commission	
Oman		
Paraguay	HUF8432MS	
South Africa	TA-2019-773	
Serbia		
Singapore	Complies with IMDA Standards DA103787	
Taiwan	<p>????????????????????</p> <p>????????????????</p> <p>1.</p> <p>????????????????????</p> <ul style="list-style-type: none"> <li>????????????????</li> </ul> <p>2.</p> <p>????????????????</p> <ul style="list-style-type: none"> <li>????????????????</li> <li>????????????????</li> </ul> <p>????????????????</p> <p>??????</p>	
United Arab Emirates		
Ukraine	Справжнім Huf Hülsbeck & Fürst GmbH & Co KG заявляє, що тип радіобладнання відповідає Технічному [HUF8423MS] регламенту радіобладнання; повний текст -декларації про відповідність доступний на веб сайті за такою адресою: <a href="http://www.huf-group.com/eudoc">http:// www.huf-group.com/eudoc</a> Робоча частота: 433,92 ГГц	
Vietnam		
Zambia		

Central Electronic Module

Country/Region	Compliance	Label
Indonesia	Sertifikat Nomor: 85998/SDPPI/2022 PLG ID: 13809	

## 15.5.7. Candidate List Substance Information (CL) in accordance with the REACH Regulation, Article 33.1

Volvo Cars supports the underlying goals of the REACH regulation in general, and Article 33 in particular, which are consistent with our own commitment to promote the responsible manufacturing, handling and use of our products.

In accordance with Article 33.1 of the REACH Regulation (Reg. EC 1907/2006),<sup>[1]</sup> professional customers must be informed of Substances of Very High Concern (SVHC<sup>[2]</sup>) in products supplied by Volvo Cars. The intention is to facilitate the safe handling of the constituent components affected in order to protect people and the environment.

### Presence of candidate list substances

The articles in the "Candidate List Substances Table" below contain substances at greater than 0.1% w/w in the candidate list (CL) for the specific car. The information on substances in the candidate list (CL) is based on the data obtained from our suppliers and our own product data.

### General Safe Use Information for Articles

Every car from Volvo Cars is provided with a user manual, which includes safe use information for owners, drivers and users of the car. Volvo Cars information on the repair and servicing of cars and genuine parts also includes safe use information for service personnel.

Where present in parts of this car, the Candidate List substances shown in the relevant "Candidate List Substances Table" for the specific car are incorporated in such a way that potential exposure to customers as well as risks for people or the environment can be minimised as long as the car and its parts are used as intended, and any repairs, servicing and maintenance are carried out following technical instructions for those activities, and industry standard good practices.

An end-of-life vehicle may only be disposed of legally in the European Union at an Authorised Treatment Facility (ATF). Vehicle parts should be disposed in accordance with locally applicable laws and local authority guidance.

### Candidate List Substances Table

More details are available in a PDF file, see Support / Car information / Regulatory information.

<sup>[1]</sup> REACH - The European Union's chemicals legislation, which entered into force on 1 June 2007, Regulation (EC) No. 1907/2006 concerning the Registration, Evaluation, Authorisation and Restriction of Chemicals (REACH).

<sup>[2]</sup> SVHC - Substances of Very High Concern, which are included in the current candidate list (CL).

---

## 15.5.8. Driver display licence agreements

You can find the driver display licence agreements between Volvo and the manufacturer or developer listed here.

The table contains the open source software (OSS) components used within the product under the terms of the respective licences. The source code corresponding to the open source components is also provided along with the product wherever man-

dated by the respective OSS licence.

Table of open source components used					
SI number	Name of OSS component	Version of OSS component	Name and version of licence text	Website	More information
1	BidiReferenceCpp	26	Unicode Terms of Use	<a href="http://www.unicode.org/Public/PROGRAMS/BidiReferenceCpp/">http://www.unicode.org/Public/PROGRAMS/BidiReferenceCpp/</a>	(C) Socionext Embedded Software Austria GmbH (SESA) Copyright (C) 1999-2009, ASMUS, Inc
2	FASTCRC32	1.2.8	License of Stephan brumme/ Zlib style License	<a href="http://stephan-brumme.com/">http://stephan-brumme.com/</a>	Copyright © 2011-2013 Stephan Brumme. All rights reserved, Copyright (C) 1995-2006, 2010, 2011, 2012 Mark Adler
3	Freescale IMX6 HDMI	5.0.11	BSD 3-clause "New" or "Revised" License	<a href="https://www.nxp.com/">https://www.nxp.com/</a> [ <a href="https://www.nxp.com/">https://www.nxp.com/</a> ]	Copyright © 2009-2012, Freescale Semiconductor, Inc, Copyright © 2010-2012, Freescale Semiconductor, Inc.
4	FreeType Hashing	2.6.3	MIT License	<a href="https://sourceforge.net/p/canvasdraw/cd/642/tree/trunk/freetype/include/freetype/internal/fthash.h">https://sourceforge.net/p/canvasdraw/cd/642/tree/trunk/freetype/include/freetype/internal/fthash.h</a> [ <a href="https://sourceforge.net/p/canvasdraw/cd/642/tree/trunk/freetype/include/freetype/internal/fthash.h">https://sourceforge.net/p/canvasdraw/cd/642/tree/trunk/freetype/include/freetype/internal/fthash.h</a> ]	Copyright 2000 Computing Research Labs, New Mexico State University Copyright 2001-2015 Francesco Zappa Nardelli
5	Freetype Project - BDF	2.6.3	MIT License	<a href="https://sourceforge.net/projects/freetype/files/freetype2/2.6.3/">https://sourceforge.net/projects/freetype/files/freetype2/2.6.3/</a> [ <a href="https://sourceforge.net/projects/freetype/files/freetype2/2.6.3/">https://sourceforge.net/projects/freetype/files/freetype2/2.6.3/</a> ]	Copyright (C) 2001-2014 by Francesco Zappa Nardelli. Copyright 2000 Computing Research Labs, New Mexico State University
6	Freetype Project -PCF	2.6.3	MIT License	<a href="https://sourceforge.net/projects/freetype/files/freetype2/2.6.3/">https://sourceforge.net/projects/freetype/files/freetype2/2.6.3/</a> [ <a href="https://sourceforge.net/projects/freetype/files/freetype2/2.6.3/">https://sourceforge.net/projects/freetype/files/freetype2/2.6.3/</a> ]	Copyright 2000-2001, 2003 by Francesco Zappa Nardelli Copyright (C) 2000, 2001, 2002, 2003, 2006, 2010 by Francesco Zappa Nardelli Copyright (C) 2000-2004, 2006-2011, 2013, 2014 by Francesco Zappa Nardelli Copyright 2000-2010, 2012-2014 by Francesco Zappa Nardelli Copyright 2003 by Francesco Zappa Nardelli
7	Freetype Project - Pcfutil	2.6.3	Open Group License	<a href="https://sourceforge.net/projects/freetype/files/freetype2/2.6.3/">https://sourceforge.net/projects/freetype/files/freetype2/2.6.3/</a> [ <a href="https://sourceforge.net/projects/freetype/files/freetype2/2.6.3/">https://sourceforge.net/projects/freetype/files/freetype2/2.6.3/</a> ]	Copyright 1990, 1994, 1998 The Open Group
8	HarfBuzz	1.3.1	MIT License	<a href="http://freedesktop.org/wiki/Software/HarfBuzz">http://freedesktop.org/wiki/Software/HarfBuzz</a>	Copyright © 2007 Chris Wilson Copyright © 2009,2010 Red Hat, Inc. Copyright © 2011,2012 Google, Inc.
9	Integrity Libnet	1.16	Internet Software Consortium-IBM License ISC License	<a href="https://github.com/lattera/glibc/blob/master/resolv/inet_pton.c">https://github.com/lattera/glibc/blob/master/resolv/inet_pton.c</a> [ <a href="https://github.com/lattera/glibc/blob/master/resolv/inet_pton.c">https://github.com/lattera/glibc/blob/master/resolv/inet_pton.c</a> ]	Copyright © 1996 by Internet Software Consortium. Consortium, Copyright © 1995 by International Business Machines, Inc.
10	Khronos EGL Headers	1.3	MIT License	<a href="http://www.khronos.org/registry/egl/">http://www.khronos.org/registry/egl/</a>	Copyright © 2007-2013 The Khronos Group Inc. Copyright 2008 VMware, Inc. Copyright © 2013-2014 The Khronos Group Inc.

The content of this manual represents the status of the user manual at the time of printing and may not be completely valid in future instances. For more information, refer to the first page for the complete disclaimer note.

SI number	Name of OSS component	Version of OSS component	Name and version of licence text	Website	More information
11	Khronos Group - OpenGL ES	1.4	SGI Free Software License B v2.0	<a href="http://www.khronos.org/opengles/">http://www.khronos.org/opengles/</a>	
12	libjpeg	6b	Independent JPEG Group License	<a href="http://www.ijg.org/">http://www.ijg.org/</a>	Copyright (C) 1991-1998, Thomas G. Lane.
13	libpng	1.4.22	libpng License	<a href="http://github.com/corppackages/libpng/">http://github.com/corppackages/libpng/</a>	Copyright © 1998-2010 Glenn Randers-Pehrson Copyright © 2007, 2009 Glenn Randers-Pehrson Version 0.96 Copyright © 1996, 1997 Andreas Dilger Version 0.88 Copyright © 1995, 1996 Guy Eric Schalnat, Group 42, Inc.
14	Libunibreak	1.2.8	zlib License	<a href="https://github.com/adah1972/libunibreak">https://github.com/adah1972/libunibreak</a> [ <a href="https://github.com/adah1972/libunibreak">https://github.com/adah1972/libunibreak</a> ]	Copyright (C) 2008-2011 Wu Yongwei Copyright (C) 2012 Tom Hacohe <a href="mailto:tom@stosb.com">tom@stosb.com</a>
15	lz4 Compression algorithm	1.4.0	BSD 2-clause "Simplified" License	<a href="http://github.com/Cyan4973/lz4/">http://github.com/Cyan4973/lz4/</a>	Copyright (C) 2011-2014, Yann Collet
16	md5	1.6	Public Domain	<a href="https://doxygen.reactos.org/d7/d04/sdk_2lib_23rdparty_2freetype_2src_2base_2md5_8c_source.html">https://doxygen.reactos.org/d7/d04/sdk_2lib_23rdparty_2freetype_2src_2base_2md5_8c_source.html</a> [ <a href="https://doxygen.reactos.org/d7/d04/sdk_2lib_23rdparty_2freetype_2src_2base_2md5_8c_source.html">https://doxygen.reactos.org/d7/d04/sdk_2lib_23rdparty_2freetype_2src_2base_2md5_8c_source.html</a> ]	
17	NetBSD	1.9	BSD-4-Clause (University of California-Specific), BSD3, IBM License, HPND like license, BSD 2-clause "Simplified" License, BSD One Clause License	<a href="http://www.netbsd.org/">http://www.netbsd.org/</a>	Copyright © 1998 Manuel Bouyer Copyright © 1996 Matt Thomas., Copyright 1997 Marshall Kirk McKusick. All Rights Reserved, Copyright © 1985, 1988, 1989, 1991, 1993, 1995 The Regents of the University of California Copyright © 1989, 1993 The Regents of the University of California Copyright © 1983, 1993 The Regents of the University of California Copyright 2000-2011 Green Hills Software Copyright (c) 1996 by Internet Software Consortium. Copyright (C) 1998 WIDE Project, Portions Copyright © 1995 by International Business Machines, Inc, Copyright (C) 1994, 1995, 1997 TooLs GmbH Copyright (C) 1994, 1995, 1997 Wolfgang Solfrank Copyright © 1995, 1999 Berkeley Software Design, Inc Portions Copyright © 1993 by Digital Equipment Corporation Copyright © 1992 Henry Spencer Copyright © 1997, 1998, 1999 The NetBSD Foundation, Inc Copyright © 1996 by Internet Software Consortium. Copyright (c) 1994 James A. Jegers(c) © UNIX System Laboratories, Inc.
18	NetBSD_BSD4	1.9	BSD 4-clause "Original" or "Old" License	<a href="http://www.netbsd.org/">http://www.netbsd.org/</a>	Copyright 2000-2011 Green Hills Software Copyright © 1994, 1998 Christopher G. Demetriou, Copyright © 1982, 1986, 1990, 1993, 1994 The Regents of the University of California. All rights reserved. © UNIX System Laboratories, Inc.
19	The FreeType Project - freetype2	2.6.3	Freetype Project License	<a href="http://sourceforge.net/projects/freetype/">http://sourceforge.net/projects/freetype/</a>	Copyright 1996-2016 by David Turner, Robert Wilhelm, and Werner Lemberg, Copyright 2007-2016 by Rahul Bhalerao, Copyright 2009-2016 by Oran Agra and Mickey Gabel, Copyright 2008-2016 by David Turner, Robert Wilhelm, Werner Lemberg, and Suzuki Toshiya, Copyright 2000 Computing Research Labs, New Mexico State University, Copyright 2001-2015 Francesco Zappa Nardelli, Copyright 2004-2016 by Masatake YAMATO and Redhat K.K, Copyright 2007-2016 by Derek Clegg and Michael Toftdal, Copyright 2010-2016 by Joel Klinghed, Copyright 2007-2013 Adobe Systems Incorporated, Copyright 2007-2014 Adobe Systems Incorporated, Copyright 2004-2016 by Albert Chin-A-Young, Copyright 2013-2016 by Google, Inc, Copyright 2002-2016 by Roberto Alameda, Copyright 2003 Huw D M Davies for Codeweavers, Copyright 2007 Dmitry Timoshkov for Codeweavers

SI number	Name of OSS component	Version of OSS component	Name and version of licence text	Website	More information
20	Vivante Driver software	viv5.0.11 p7.4.j3	MIT License	<a href="http://www.vivantecorp.com/">http://www.vivantecorp.com/</a>	Copyright 2012 - 2016 Vivante Corporation, Santa Clara, California Copyright © 2007 The Khronos Group Inc Copyright © 2014 - 2016 Vivante Corporation Copyright 2012 Vivante Corporation, Sunnyvale, California Copyright © 2011 Intel Corporation Copyright (C) 1999-2001 Brian Paul
21	zlib	1.2.8	zlib License	<a href="http://www.zlib.net/">http://www.zlib.net/</a>	Copyright (C) 1995-2007 Mark Adler Copyright (C) 1995-2005 Jean-loup Gailly Copyright (C) 1995-2012 Mark Adler Copyright (C) 2003 Chris Anderson Copyright (C) 1998 Brian Raiter
22	RBTree.cpp	3.4.2	Public Domain	<a href="https://www.eu.socionext.com/">https://www.eu.socionext.com/</a> [ <a href="https://www.eu.socionext.com/">https://www.eu.socionext.com/</a> ]	(C) Socionext Embedded Software Austria GmbH (SESA)

Licence text	
Licence name	Licence text
HPND Like license	<p>Portions Copyright (c) 1993 by Digital Equipment Corporation.</p> <p>Permission to use, copy, modify, and distribute this software for any purpose with or without fee is hereby granted, provided that the above copyright notice and this permission notice appear in all copies, and that the name of Digital Equipment Corporation not be used in advertising or publicity pertaining to distribution of the document or software without specific, written prior permission.</p> <p>THE SOFTWARE IS PROVIDED "AS IS" AND DIGITAL EQUIPMENT CORP. DISCLAIMS ALL WARRANTIES WITH REGARD TO THIS SOFTWARE, INCLUDING ALL IMPLIED WARRANTIES OF MERCHANTABILITY AND FITNESS. IN NO EVENT SHALL DIGITAL EQUIPMENT CORPORATION BE LIABLE FOR ANY SPECIAL, DIRECT, INDIRECT, OR CONSEQUENTIAL DAMAGES OR ANY DAMAGES WHATSOEVER RESULTING FROM LOSS OF USE, DATA OR PROFITS, WHETHER IN AN ACTION OF CONTRACT, NEGLIGENCE OR OTHER TORTIOUS ACTION, ARISING OUT OF OR IN CONNECTION WITH THE USE OR PERFORMANCE OF THIS SOFTWARE.</p>
BSD 2-clause "Simplified" License	<p>BSD Two Clause License</p> <p>Redistribution and use in source and binary forms, with or without modification, are permitted provided that the following conditions are met: Redistributions of source code must retain the above copyright notice, this list of conditions and the following disclaimer. Redistributions in binary form must reproduce the above copyright notice, this list of conditions and the following disclaimer in the documentation and/or other materials provided with the distribution.</p> <p>THIS SOFTWARE IS PROVIDED BY THE AUTHOR "AS IS" AND ANY EXPRESS OR IMPLIED WARRANTIES, INCLUDING, BUT NOT LIMITED TO, THE IMPLIED WARRANTIES OF MERCHANTABILITY AND FITNESS FOR A PARTICULAR PURPOSE ARE DISCLAIMED. IN NO EVENT SHALL THE AUTHOR BE LIABLE FOR ANY DIRECT, INDIRECT, INCIDENTAL, SPECIAL, EXEMPLARY, OR CONSEQUENTIAL DAMAGES (INCLUDING, BUT NOT LIMITED TO, PROCUREMENT OF SUBSTITUTE GOODS OR SERVICES; LOSS OF USE, DATA, OR PROFITS; OR BUSINESS INTERRUPTION) HOWEVER CAUSED AND ON ANY THEORY OF LIABILITY, WHETHER IN CONTRACT, STRICT LIABILITY, OR TORT (INCLUDING NEGLIGENCE OR OTHERWISE) ARISING IN ANY WAY OUT OF THE USE OF THIS SOFTWARE, EVEN IF ADVISED OF THE POSSIBILITY OF SUCH DAMAGE.</p>
IBM license	<p>Portions Copyright (c) 1995 by International Business Machines, Inc.</p> <p>International Business Machines, Inc. (hereinafter called IBM) grants permission under its copyrights to use, copy, modify, and distribute this Software with or without fee, provided that the above copyright notice and all paragraphs of this notice appear in all copies, and that the name of IBM not be used in connection with the marketing of any product incorporating the Software or modifications thereof, without specific, written prior permission. To the extent it has a right to do so, IBM grants an immunity from suit under its patents, if any, for the use, sale or manufacture of products to the extent that such products are used for performing Domain Name System dynamic updates in TCP/IP networks by means of the Software. No immunity is granted for any product per se or for any other function of any product.</p> <p>THE SOFTWARE IS PROVIDED "AS IS", AND IBM DISCLAIMS ALL WARRANTIES, INCLUDING ALL IMPLIED WARRANTIES OF MERCHANTABILITY AND FITNESS FOR A PARTICULAR PURPOSE. IN NO EVENT SHALL IBM BE LIABLE FOR ANY SPECIAL, DIRECT, INDIRECT, OR CONSEQUENTIAL DAMAGES OR ANY DAMAGES WHATSOEVER ARISING OUT OF OR IN CONNECTION WITH THE USE OR PERFORMANCE OF THIS SOFTWARE, EVEN IF IBM IS APPRISED OF THE POSSIBILITY OF SUCH DAMAGES.</p>

Licence name	Licence text
BSD 3-clause "New" or "Revised" License	<p>Copyright (c) [YEAR], [OWNER] All rights reserved.</p> <p>Redistribution and use in source and binary forms, with or without modification, are permitted provided that the following conditions are met: Redistributions of source code must retain the above copyright notice, this list of conditions and the following disclaimer. Redistributions in binary form must reproduce the above copyright notice, this list of conditions and the following disclaimer in the documentation and/or other materials provided with the distribution. Neither the name of the [ORGANIZATION] nor the names of its contributors may be used to endorse or promote products derived from this software without specific prior written permission.</p> <p>THIS SOFTWARE IS PROVIDED BY THE COPYRIGHT HOLDERS AND CONTRIBUTORS "AS IS" AND ANY EXPRESS OR IMPLIED WARRANTIES, INCLUDING, BUT NOT LIMITED TO, THE IMPLIED WARRANTIES OF MERCHANTABILITY AND FITNESS FOR A PARTICULAR PURPOSE ARE DISCLAIMED. IN NO EVENT SHALL THE COPYRIGHT OWNER OR CONTRIBUTORS BE LIABLE FOR ANY DIRECT, INDIRECT, INCIDENTAL, SPECIAL, EXEMPLARY, OR CONSEQUENTIAL DAMAGES (INCLUDING, BUT NOT LIMITED TO, PROCUREMENT OF SUBSTITUTE GOODS OR SERVICES; LOSS OF USE, DATA, OR PROFITS; OR BUSINESS INTERRUPTION) HOWEVER CAUSED AND ON ANY THEORY OF LIABILITY, WHETHER IN CONTRACT, STRICT LIABILITY, OR TORT (INCLUDING NEGLIGENCE OR OTHERWISE) ARISING IN ANY WAY OUT OF THE USE OF THIS SOFTWARE, EVEN IF ADVISED OF THE POSSIBILITY OF SUCH DAMAGE.</p>
BSD 4-clause "Original" or "Old" License	<p>Copyright (c) [year], [copyright holder] All rights reserved.</p> <p>Redistribution and use in source and binary forms, with or without modification, are permitted provided that the following conditions are met:</p> <ol style="list-style-type: none"> <li>1. Redistributions of source code must retain the above copyright notice, this list of conditions and the following disclaimer.</li> <li>2. Redistributions in binary form must reproduce the above copyright notice, this list of conditions and the following disclaimer in the documentation and/or other materials provided with the distribution.</li> <li>3. All advertising materials mentioning features or use of this software must display the following acknowledgement: This product includes software developed by the organization.</li> <li>4. Neither the name of the organization nor the names of its contributors may be used to endorse or promote products derived from this software without specific prior written permission.</li> </ol> <p>THIS SOFTWARE IS PROVIDED BY COPYRIGHT HOLDER "AS IS" AND ANY EXPRESS OR IMPLIED WARRANTIES, INCLUDING, BUT NOT LIMITED TO, THE IMPLIED WARRANTIES OF MERCHANTABILITY AND FITNESS FOR A PARTICULAR PURPOSE ARE DISCLAIMED. IN NO EVENT SHALL {{COPYRIGHT HOLDER}} BE LIABLE FOR ANY DIRECT, INDIRECT, INCIDENTAL, SPECIAL, EXEMPLARY, OR CONSEQUENTIAL DAMAGES (INCLUDING, BUT NOT LIMITED TO, PROCUREMENT OF SUBSTITUTE GOODS OR SERVICES; LOSS OF USE, DATA, OR PROFITS; OR BUSINESS INTERRUPTION) HOWEVER CAUSED AND ON ANY THEORY OF LIABILITY, WHETHER IN CONTRACT, STRICT LIABILITY, OR TORT (INCLUDING NEGLIGENCE OR OTHERWISE) ARISING IN ANY WAY OUT OF THE USE OF THIS SOFTWARE, EVEN IF ADVISED OF THE POSSIBILITY OF SUCH DAMAGE.</p>
BSD-4-Clause (University of California- Specific)	<p>BSD-4-Clause (University of California-Specific) Copyright [various years] The Regents of the University of California. All rights reserved.</p> <p>Redistribution and use in source and binary forms, with or without modification, are permitted provided that the following conditions are met:</p> <ol style="list-style-type: none"> <li>1. Redistributions of source code must retain the above copyright notice, this list of conditions and the following disclaimer.</li> <li>2. Redistributions in binary form must reproduce the above copyright notice, this list of conditions and the following disclaimer in the documentation and/or other materials provided with the distribution.</li> <li>3. All advertising materials mentioning features or use of this software must display the following acknowledgement: This product includes software developed by the University of California, Berkeley and its contributors.</li> <li>4. Neither the name of the University nor the names of its contributors may be used to endorse or promote products derived from this software without specific prior written permission.</li> </ol> <p>THIS SOFTWARE IS PROVIDED BY THE REGENTS AND CONTRIBUTORS "AS IS" AND ANY EXPRESS OR IMPLIED WARRANTIES, INCLUDING, BUT NOT LIMITED TO, THE IMPLIED WARRANTIES OF MERCHANTABILITY AND FITNESS FOR A PARTICULAR PURPOSE ARE DISCLAIMED. IN NO EVENT SHALL THE REGENTS OR CONTRIBUTORS BE LIABLE FOR ANY DIRECT, INDIRECT, INCIDENTAL, SPECIAL, EXEMPLARY, OR CONSEQUENTIAL DAMAGES (INCLUDING, BUT NOT LIMITED TO, PROCUREMENT OF SUBSTITUTE GOODS OR SERVICES; LOSS OF USE, DATA, OR PROFITS; OR BUSINESS INTERRUPTION) HOWEVER CAUSED AND ON ANY THEORY OF LIABILITY, WHETHER IN CONTRACT, STRICT LIABILITY, OR TORT (INCLUDING NEGLIGENCE OR OTHERWISE) ARISING IN ANY WAY OUT OF THE USE OF THIS SOFTWARE, EVEN IF ADVISED OF THE POSSIBILITY OF SUCH DAMAGE.</p>

Licence name	Licence text
Freetype Project License	<p>The FreeType Project LICENSE 2006-Jan-27</p> <p>Copyright 1996-2002, 2006 by David Turner, Robert Wilhelm, and Werner Lemberg</p> <p>Introduction</p> <p>The FreeType Project is distributed in several archive packages; some of them may contain, in addition to the FreeType font engine, various tools and contributions which rely on, or relate to, the FreeType Project. This license applies to all files found in such packages, and which do not fall under their own explicit license. The license affects thus the FreeType font engine, the test programs, documentation and makefiles, at the very least. This license was inspired by the BSD, Artistic, and IJG (Independent JPEG Group) licenses, which all encourage inclusion and use of free software in commercial and freeware products alike. As a consequence, its main points are that:</p> <p>We don't promise that this software works. However, we will be interested in any kind of bug reports. ('as is' distribution)</p> <p>You can use this software for whatever you want, in parts or full form, without having to pay us. ('royalty-free' usage)</p> <p>You may not pretend that you wrote this software. If you use it, or only parts of it, in a program, you must acknowledge somewhere in your documentation that you have used the FreeType code. ('credits')</p> <p>We specifically permit and encourage the inclusion of this software, with or without modifications, in commercial products. We disclaim all warranties covering The FreeType Project and assume no liability related to The FreeType Project. Finally, many people asked us for a preferred form for a credit/disclaimer to use in compliance with this license. We thus encourage you to use the following text:</p> <p>"Portions of this software are copyright © 1996-2002, 2006 The FreeType Project (<a href="http://www.freetype.org">www.freetype.org</a>). All rights reserved."</p> <p>Legal Terms</p> <p>Definitions</p> <p>Throughout this license, the terms 'package', 'FreeType Project', and 'FreeType archive' refer to the set of files originally distributed by the authors (David Turner, Robert Wilhelm, and Werner Lemberg) as the 'FreeType Project', be they named as alpha, beta or final release. 'You' refers to the licensee, or person using the project, where 'using' is a generic term including compiling the project's source code as well as linking it to form a 'program' or 'executable'. This program is referred to as 'a program using the FreeType engine'. This license applies to all files distributed in the original FreeType Project, including all source code, binaries and documentation, unless otherwise stated in the file in its original, unmodified form as distributed in the original archive. If you are unsure whether or not a particular file is covered by this license, you must contact us to verify this.</p> <p>The FreeType Project is copyright (C) 1996-2000, 2006 by David Turner, Robert Wilhelm, and Werner Lemberg. All rights reserved except as specified below.</p> <p>No Warranty</p> <p>THE FREETYPE PROJECT IS PROVIDED 'AS IS' WITHOUT WARRANTY OF ANY KIND, EITHER EXPRESS OR IMPLIED, INCLUDING, BUT NOT LIMITED TO, WARRANTIES OF MERCHANTABILITY AND FITNESS FOR A PARTICULAR PURPOSE. IN NO EVENT WILL ANY OF THE AUTHORS OR COPYRIGHT HOLDERS BE LIABLE FOR ANY DAMAGES CAUSED BY THE USE OR THE INABILITY TO USE, OF THE FREETYPE PROJECT.</p> <p>Redistribution</p> <p>This license grants a worldwide, royalty-free, perpetual and irrevocable right and license to use, execute, perform, compile, display, copy, create derivative works of, distribute and sublicense the FreeType Project (in both source and object code forms) and derivative works thereof for any purpose; and to authorize others to exercise some or all of the rights granted herein, subject to the following conditions:</p> <p>Redistribution of source code must retain this license file ('FTL.TXT') unaltered; any additions, deletions or changes to the original files must be clearly indicated in accompanying documentation. The copyright notices of the unaltered, original files must be preserved in all copies of source files.</p> <p>Redistribution in binary form must provide a disclaimer that states that the software is based in part of the work of the FreeType Team, in the distribution documentation. We also encourage you to put an URL to the FreeType web page in your documentation, though this isn't mandatory. These conditions apply to any software derived from or based on the FreeType Project, not just the unmodified files. If you use our work, you must acknowledge us. However, no fee need be paid to us.</p> <p>Advertising</p> <p>Neither the FreeType authors and contributors nor you shall use the name of the other for commercial, advertising, or promotional purposes without specific prior written permission. We suggest, but do not require, that you use one or more of the following phrases to refer to this software in your documentation or advertising materials: 'FreeType Project', 'FreeType Engine', 'FreeType library', or 'FreeType Distribution'. As you have not signed this license, you are not required to accept it. However, as the FreeType Project is copyrighted material, only this license, or another one contracted with the authors, grants you the right to use, distribute, and modify it. Therefore, by using, distributing, or modifying the FreeType Project, you indicate that you understand and accept all the terms of this license.</p> <p>Contacts</p> <p>There are two mailing lists related to FreeType:</p> <p><a href="mailto:freetype@nongnu.org">freetype@nongnu.org</a></p> <p>Discusses general use and applications of FreeType, as well as future and wanted additions to the library and distribution. If you are looking for support, start in this list if you haven't found anything to help you in the documentation.</p> <p><a href="mailto:devel@nongnu.org">devel@nongnu.org</a></p> <p>Discusses bugs, as well as engine internals, design issues, specific licenses, porting, etc.</p> <p>Our home page can be found at: <a href="http://www.freetype.org">http://www.freetype.org</a></p>

Licence name	Licence text
Independent JPEG Group License	<p>The Independent JPEG Group's JPEG software README for release 6b of 27-Mar-1998</p> <p>This distribution contains the sixth public release of the Independent JPEG Group's free JPEG software. You are welcome to redistribute this software and to use it for any purpose, subject to the conditions under LEGAL ISSUES, below. Serious users of this software (particularly those incorporating it into larger programs) should contact IJG at jpeg-info@uunet.uu.net to be added to our electronic mailing list. Mailing list members are notified of updates and have a chance to participate in technical discussions, etc. This software is the work of Tom Lane, Philip Gladstone, Jim Boucher, Lee Crocker, Julian Minguillon, Luis Ortiz, George Phillips, Davide Rossi, Guido Vollbeding, Ge' Weijers, and other members of the Independent JPEG Group. IJG is not affiliated with the official ISO JPEG standards committee.</p> <p>LEGAL ISSUES</p> <p>In plain English:</p> <p>We don't promise that this software works. (But if you find any bugs, please let us know!) You can use this software for whatever you want. You don't have to pay us. You may not pretend that you wrote this software. If you use it in a program, you must acknowledge somewhere in your documentation that you've used the IJG code.</p> <p>In legalese:</p> <p>The authors make NO WARRANTY or representation, either express or implied, with respect to this software, its quality, accuracy, merchantability, or fitness for a particular purpose. This software is provided "AS IS", and you, its user, assume the entire risk as to its quality and accuracy. This software is copyright (C) 1991-1998, Thomas G. Lane. All Rights Reserved except as specified below.</p> <p>Permission is hereby granted to use, copy, modify, and distribute this software (or portions thereof) for any purpose, without fee, subject to these conditions:</p> <ol style="list-style-type: none"> <li>1. If any part of the source code for this software is distributed, then this README file must be included, with this copyright and no-warranty notice unaltered; and any additions, deletions, or changes to the original files must be clearly indicated in accompanying documentation.</li> <li>2. If only executable code is distributed, then the accompanying documentation must state that "this software is based in part on the work of the Independent JPEG Group".</li> <li>3. Permission for use of this software is granted only if the user accepts full responsibility for any undesirable consequences; the authors accept NO LIABILITY for damages of any kind.</li> </ol> <p>These conditions apply to any software derived from or based on the IJG code, not just to the unmodified library. If you use our work, you ought to acknowledge us.</p> <p>Permission is NOT granted for the use of any IJG author's name or company name in advertising or publicity relating to this software or products derived from it. This software may be referred to only as "the Independent JPEG Group's software".</p> <p>We specifically permit and encourage the use of this software as the basis of commercial products, provided that all warranty or liability claims are assumed by the product vendor. ansi2knrc is included in this distribution by permission of L. Peter Deutsch, sole proprietor of its copyright holder, Aladdin Enterprises of Menlo Park, CA. ansi2knrc is NOT covered by the above copyright and conditions, but instead by the usual distribution terms of the Free Software Foundation; principally, that you must include source code if you redistribute it. (See the file ansi2knrc for full details.)</p> <p>However, since ansi2knrc is not needed as part of any program generated from the IJG code, this does not limit you more than the foregoing paragraphs do. The Unix configuration script "configure" was produced with GNU Autoconf. It is copyright by the Free Software Foundation but is freely distributable. The same holds for its supporting scripts (config.guess, config.sub, ltconfig, ltmain.sh). Another support script, install-sh, is copyright by M.I.T. but is also freely distributable.</p> <p>It appears that the arithmetic coding option of the JPEG spec is covered by patents owned by IBM, AT &amp; T, and Mitsubishi. Hence arithmetic coding cannot legally be used without obtaining one or more licenses. For this reason, support for arithmetic coding has been removed from the free JPEG software. (Since arithmetic coding provides only a marginal gain over the unpatented Huffman mode, it is unlikely that very many implementations will support it.) So far as we are aware, there are no patent restrictions on the remaining code.</p> <p>The IJG distribution formerly included code to read and write GIF files. To avoid entanglement with the Unisys LZW patent, GIF reading support has been removed altogether, and the GIF writer has been simplified to produce "uncompressed GIFs". This technique does not use the LZW algorithm; the resulting GIF files are larger than usual, but are readable by all standard GIF decoders. We are required to state that</p> <p>"The Graphics Interchange Format(c) is the Copyright property of CompuServe Incorporated. GIF(sm) is a Service Mark property of CompuServe Incorporated."</p>
Internet Software Consortium-IBM License	<p>Copyright (c) 1996 by Internet Software Consortium.</p> <p>Permission to use, copy, modify, and distribute this software for any purpose with or without fee is hereby granted, provided that the above copyright notice and this permission notice appear in all copies.</p> <p>THE SOFTWARE IS PROVIDED "AS IS" AND INTERNET SOFTWARE CONSORTIUM DISCLAIMS ALL WARRANTIES WITH REGARD TO THIS SOFTWARE INCLUDING ALL IMPLIED WARRANTIES OF MERCHANTABILITY AND FITNESS. IN NO EVENT SHALL INTERNET SOFTWARE CONSORTIUM BE LIABLE FOR ANY SPECIAL, DIRECT, INDIRECT, OR CONSEQUENTIAL DAMAGES OR ANY DAMAGES WHATSOEVER RESULTING FROM LOSS OF USE, DATA OR PROFITS, WHETHER IN AN ACTION OF CONTRACT, NEGLIGENCE OR OTHER TORTIOUS ACTION, ARISING OUT OF OR IN CONNECTION WITH THE USE OR PERFORMANCE OF THIS SOFTWARE.</p> <p>Portions Copyright (c) 1995 by International Business Machines, Inc.</p> <p>International Business Machines, Inc. (hereinafter called IBM) grants permission under its copyrights to use, copy, modify, and distribute this Software with or without fee, provided that the above copyright notice and all paragraphs of this notice appear in all copies, and that the name of IBM not be used in connection with the marketing of any product incorporating the Software or modifications thereof, without specific, written prior permission.</p> <p>To the extent it has a right to do so, IBM grants an immunity from suit under its patents, if any, for the use, sale or manufacture of products to the extent that such products are used for performing Domain Name System dynamic updates in TCP/IP networks by means of the Software. No immunity is granted for any product per se or for any other function of any product.</p> <p>THE SOFTWARE IS PROVIDED "AS IS", AND IBM DISCLAIMS ALL WARRANTIES, INCLUDING ALL IMPLIED WARRANTIES OF MERCHANTABILITY AND FITNESS FOR A PARTICULAR PURPOSE. IN NO EVENT SHALL IBM BE LIABLE FOR ANY SPECIAL, DIRECT, INDIRECT, OR CONSEQUENTIAL DAMAGES OR ANY DAMAGES WHATSOEVER ARISING OUT OF OR IN CONNECTION WITH THE USE OR PERFORMANCE OF THIS SOFTWARE, EVEN IF IBM IS APPRISED OF THE POSSIBILITY OF SUCH DAMAGES.</p>

Licence name	Licence text
Khronos License	<p>Copyright (c) 2013 The Khronos Group Inc.</p> <p>** ** Permission is hereby granted, free of charge, to any person obtaining a ** copy of this software and/or associated documentation files (the ** "Materials"), to deal in the Materials without restriction, including ** without limitation the rights to use, copy, modify, merge, publish, ** distribute, sublicense, and/or sell copies of the Materials, and to ** permit persons to whom the Materials are furnished to do so, subject to ** the following conditions: ** ** The above copyright notice and this permission notice shall be included ** in all copies or substantial portions of the Materials. ** ** THE MATERIALS ARE PROVIDED "AS IS", WITHOUT WARRANTY OF ANY KIND, ** EXPRESS OR IMPLIED, INCLUDING BUT NOT LIMITED TO THE WARRANTIES OF ** MERCHANTABILITY, FITNESS FOR A PARTICULAR PURPOSE AND NONINFRINGEMENT. ** IN NO EVENT SHALL THE AUTHORS OR COPYRIGHT HOLDERS BE LIABLE FOR ANY ** CLAIM, DAMAGES OR OTHER LIABILITY, WHETHER IN AN ACTION OF CONTRACT, ** TORT OR OTHERWISE, ARISING FROM, OUT OF OR IN CONNECTION WITH THE ** MATERIALS OR THE USE OR OTHER DEALINGS IN THE MATERIALS.</p>
License of Stephan Brumme/ Zlib style License	<p>This software is provided 'as-is', without any express or implied warranty. In no event will the author be held liable for any damages arising from the use of this software. Permission is granted to anyone to use this software for any purpose, including commercial applications, and to alter it and redistribute it freely, subject to the following restrictions: The origin of this software must not be misrepresented; you must not claim that you wrote the original software. If you use this software in a product, an acknowledgment in the product documentation would be appreciated but is not required. Altered source versions must be plainly marked as such, and must not be misrepresented as being the original software.</p>
MIT License	<p>The MIT License</p> <p>Copyright (c) [year] [copyright holders]</p> <p>Permission is hereby granted, free of charge, to any person obtaining a copy of this software and associated documentation files (the "Software"), to deal in the Software without restriction, including without limitation the rights to use, copy, modify, merge, publish, distribute, sublicense, and/or sell copies of the Software, and to permit persons to whom the Software is furnished to do so, subject to the following conditions:</p> <p>The above copyright notice and this permission notice shall be included in all copies or substantial portions of the Software.</p> <p>THE SOFTWARE IS PROVIDED "AS IS", WITHOUT WARRANTY OF ANY KIND, EXPRESS OR IMPLIED, INCLUDING BUT NOT LIMITED TO THE WARRANTIES OF MERCHANTABILITY, FITNESS FOR A PARTICULAR PURPOSE AND NONINFRINGEMENT. IN NO EVENT SHALL THE AUTHORS OR COPYRIGHT HOLDERS BE LIABLE FOR ANY CLAIM, DAMAGES OR OTHER LIABILITY, WHETHER IN AN ACTION OF CONTRACT, TORT OR OTHERWISE, ARISING FROM, OUT OF OR IN CONNECTION WITH THE SOFTWARE OR THE USE OR OTHER DEALINGS IN THE SOFTWARE.</p>
Open Group License	<p>Open Group License</p> <p>Copyright 1996, 1998 The Open Group</p> <p>Permission to use, copy, modify, distribute, and sell this software and its documentation for any purpose is hereby granted without fee, provided that the above copyright notice appear in all copies and that both that copyright notice and this permission notice appear in supporting documentation. The above copyright notice and this permission notice shall be included in all copies or substantial portions of the Software.</p> <p>THE SOFTWARE IS PROVIDED "AS IS", WITHOUT WARRANTY OF ANY KIND, EXPRESS OR IMPLIED, INCLUDING BUT NOT LIMITED TO THE WARRANTIES OF MERCHANTABILITY, FITNESS FOR A PARTICULAR PURPOSE AND NONINFRINGEMENT. IN NO EVENT SHALL THE OPEN GROUP BE LIABLE FOR ANY CLAIM, DAMAGES OR OTHER LIABILITY, WHETHER IN AN ACTION OF CONTRACT, TORT OR OTHERWISE, ARISING FROM, OUT OF OR IN CONNECTION WITH THE SOFTWARE OR THE USE OR OTHER DEALINGS IN THE SOFTWARE.</p> <p>Except as contained in this notice, the name of The Open Group shall not be used in advertising or otherwise to promote the sale, use or other dealings in this Software without prior written authorization from The Open Group.</p>
Public Domain	<p>Public domain code is not subject to any license.</p>
BSD One Clause License	<p>BSD One Clause License</p> <p>Copyright (c) [YEAR], [OWNER]</p> <p>All rights reserved.</p> <p>Redistribution and use in source and binary forms, with or without modification, are permitted provided that the following conditions are met:</p> <p>* Redistributions of source code must retain the above copyright notice, this list of conditions and the following disclaimer.</p> <p>THIS SOFTWARE IS PROVIDED BY THE COPYRIGHT HOLDERS AND CONTRIBUTORS "AS IS" AND ANY EXPRESS OR IMPLIED WARRANTIES, INCLUDING, BUT NOT LIMITED TO, THE IMPLIED WARRANTIES OF MERCHANTABILITY AND FITNESS FOR A PARTICULAR PURPOSE ARE DISCLAIMED. IN NO EVENT SHALL THE COPYRIGHT OWNER OR CONTRIBUTORS BE LIABLE FOR ANY DIRECT, INDIRECT, INCIDENTAL, SPECIAL, EXEMPLARY, OR CONSEQUENTIAL DAMAGES (INCLUDING, BUT NOT LIMITED TO, PROCUREMENT OF SUBSTITUTE GOODS OR SERVICES; LOSS OF USE, DATA, OR PROFITS; OR BUSINESS INTERRUPTION) HOWEVER CAUSED AND ON ANY THEORY OF LIABILITY, WHETHER IN CONTRACT, STRICT LIABILITY, OR TORT (INCLUDING NEGLIGENCE OR OTHERWISE) ARISING IN ANY WAY OUT OF THE USE OF THIS SOFTWARE, EVEN IF ADVISED OF THE POSSIBILITY OF SUCH DAMAGE.</p>
ISC License	<p>ISC License (ISCL)</p> <p>Copyright (c) 4-digit year, Company or Person's Name</p> <p>Permission to use, copy, modify, and/or distribute this software for any purpose with or without fee is hereby granted, provided that the above copyright notice and this permission notice appear in all copies.</p> <p>THE SOFTWARE IS PROVIDED "AS IS" AND THE AUTHOR DISCLAIMS ALL WARRANTIES WITH REGARD TO THIS SOFTWARE INCLUDING ALL IMPLIED WARRANTIES OF MERCHANTABILITY AND FITNESS. IN NO EVENT SHALL THE AUTHOR BE LIABLE FOR ANY SPECIAL, DIRECT, INDIRECT, OR CONSEQUENTIAL DAMAGES OR ANY DAMAGES WHATSOEVER RESULTING FROM LOSS OF USE, DATA OR PROFITS, WHETHER IN AN ACTION OF CONTRACT, NEGLIGENCE OR OTHER TORTIOUS ACTION, ARISING OUT OF OR IN CONNECTION WITH THE USE OR PERFORMANCE OF THIS SOFTWARE.</p>

Licence name	Licence text
SGI Free Software License B v2.0	<p>SGI FREE SOFTWARE LICENSE B (Version 2.0, Sept. 18, 2008)            Copyright (C) [dates of first publication] Silicon Graphics, Inc. All Rights Reserved.</p> <p>Permission is hereby granted, free of charge, to any person obtaining a copy of this software and associated documentation files (the "Software"), to deal in the Software without restriction, including without limitation the rights to use, copy, modify, merge, publish, distribute, sublicense, and/or sell copies of the Software, and to permit persons to whom the Software is furnished to do so, subject to the following conditions:</p> <p>The above copyright notice including the dates of first publication and either this permission notice or a reference to <a href="http://oss.sgi.com/projects/FreeB/">http://oss.sgi.com/projects/FreeB/</a> shall be included in all copies or substantial portions of the Software.</p> <p>THE SOFTWARE IS PROVIDED "AS IS", WITHOUT WARRANTY OF ANY KIND, EXPRESS OR IMPLIED, INCLUDING BUT NOT LIMITED TO THE WARRANTIES OF MERCHANTABILITY, FITNESS FOR A PARTICULAR PURPOSE AND NONINFRINGEMENT. IN NO EVENT SHALL SILICON GRAPHICS, INC. BE LIABLE FOR ANY CLAIM, DAMAGES OR OTHER LIABILITY, WHETHER IN AN ACTION OF CONTRACT, TORT OR OTHERWISE, ARISING FROM, OUT OF OR IN CONNECTION WITH THE SOFTWARE OR THE USE OR OTHER DEALINGS IN THE SOFTWARE.</p> <p>Except as contained in this notice, the name of Silicon Graphics, Inc. shall not be used in advertising or otherwise to promote the sale, use or other dealings in this Software without prior written authorization from Silicon Graphics, Inc.</p>

Licence name	Licence text
Unicode Terms of Use	<p>Unicode Terms of Use</p> <p>For the general privacy policy governing access to this site, see the Unicode Privacy Policy. For trademark usage, see the Unicode® Consortium Name and Trademark Usage Policy.</p> <p>A. Unicode Copyright.</p> <ol style="list-style-type: none"> <li>1. Copyright © 1991-2014 Unicode, Inc. All rights reserved.</li> <li>2. Certain documents and files on this website contain a legend indicating that "Modification is permitted." Any person is hereby authorized, without fee, to modify such documents and files to create derivative works conforming to the Unicode® Standard, subject to Terms and Conditions herein.</li> <li>3. Any person is hereby authorized, without fee, to view, use, reproduce, and distribute all documents and files solely for informational purposes in the creation of products supporting the Unicode Standard, subject to the Terms and Conditions herein.</li> <li>4. Further specifications of rights and restrictions pertaining to the use of the particular set of data files known as the "Unicode Character Database" can be found in Exhibit 1.</li> <li>5. Each version of the Unicode Standard has further specifications of rights and restrictions of use. For the book editions (Unicode 5.0 and earlier), these are found on the back of the title page. The online code charts carry specific restrictions. All other files, including online documentation of the core specification for Unicode 6.0 and later, are covered under these general Terms of Use.</li> <li>6. No license is granted to "mirror" the Unicode website where a fee is charged for access to the "mirror" site.</li> <li>7. Modification is not permitted with respect to this document. All copies of this document must be verbatim.</li> </ol> <p>B. Restricted Rights Legend.</p> <p>Any technical data or software which is licensed to the United States of America, its agencies and/or instrumentalities under this Agreement is commercial technical data or commercial computer software developed exclusively at private expense as defined in FAR 2.101, or DFARS 252.227-7014 (June 1995), as applicable. For technical data, use, duplication, or disclosure by the Government is subject to restrictions as set forth in DFARS 202.227-7015 Technical Data, Commercial and Items (Nov 1995) and this Agreement. For Software, in accordance with FAR 12-212 or DFARS 227-7202, as applicable, use, duplication or disclosure by the Government is subject to the restrictions set forth in this Agreement.</p> <p>C. Warranties and Disclaimers.</p> <ol style="list-style-type: none"> <li>1. This publication and/or website may include technical or typographical errors or other inaccuracies. Changes are periodically added to the information herein; these changes will be incorporated in new editions of the publication and/or website. Unicode may make improvements and/or changes in the product(s) and/or program(s) described in this publication and/or website at any time.</li> <li>2. If this file has been purchased on magnetic or optical media from Unicode, Inc. the sole and exclusive remedy for any claim will be exchange of the defective media within ninety (90) days of original purchase.</li> <li>3. EXCEPT AS PROVIDED IN SECTION C.2, THIS PUBLICATION AND/OR SOFTWARE IS PROVIDED "AS IS" WITHOUT WARRANTY OF ANY KIND EITHER EXPRESS, IMPLIED, OR STATUTORY, INCLUDING, BUT NOT LIMITED TO, ANY WARRANTIES OF MERCHANTABILITY, FITNESS FOR A PARTICULAR PURPOSE, OR NON-INFRINGEMENT. UNICODE AND ITS LICENSORS ASSUME NO RESPONSIBILITY FOR ERRORS OR OMISSIONS IN THIS PUBLICATION AND/OR SOFTWARE OR OTHER DOCUMENTS WHICH ARE REFERENCED BY OR LINKED TO THIS PUBLICATION OR THE UNICODE WEBSITE.</li> </ol> <p>D. Waiver of Damages.</p> <p>In no event shall Unicode or its licensors be liable for any special, incidental, indirect or consequential damages of any kind, or any damages whatsoever, whether or not Unicode was advised of the possibility of the damage, including, without limitation, those resulting from the following: loss of use, data or profits, in connection with the use, modification or distribution of this information or its derivatives.</p> <p>E. Trademarks &amp; Logos.</p> <ol style="list-style-type: none"> <li>1. The Unicode Word Mark and the Unicode Logo are trademarks of Unicode, Inc. "The Unicode Consortium" and "Unicode, Inc." are trade names of Unicode, Inc. Use of the information and materials found on this website indicates your acknowledgement of Unicode, Inc.'s exclusive worldwide rights in the Unicode Word Mark, the Unicode Logo, and the Unicode trade names.</li> <li>2. The Unicode Consortium Name and Trademark Usage Policy ("Trademark Policy") are incorporated herein by reference and you agree to abide by the provisions of the Trademark Policy, which may be changed from time to time in the sole discretion of Unicode, Inc.</li> <li>3. All third party trademarks referenced herein are the property of their respective owners.</li> </ol> <p>F. Miscellaneous.</p> <ol style="list-style-type: none"> <li>1. Jurisdiction and Venue. This server is operated from a location in the State of California, United States of America. Unicode makes no representation that the materials are appropriate for use in other locations. If you access this server from other locations, you are responsible for compliance with local laws. This Agreement, all use of this site and any claims and damages resulting from use of this site are governed solely by the laws of the State of California without regard to any principles which would apply the laws of a different jurisdiction. The user agrees that any disputes regarding this site shall be resolved solely in the courts located in Santa Clara County, California. The user agrees said courts have personal jurisdiction and agree to waive any right to transfer the dispute to any other forum.</li> <li>2. Modification by Unicode. Unicode shall have the right to modify this Agreement at any time by posting it to this site. The user may not assign any part of this Agreement without Unicode's prior written consent.</li> <li>3. Taxes. The user agrees to pay any taxes arising from access to this website or use of the information herein, except for those based on Unicode's net income.</li> <li>4. Severability. If any provision of this Agreement is declared invalid or unenforceable, the remaining provisions of this Agreement shall remain in effect.</li> <li>5. Entire Agreement. This Agreement constitutes the entire agreement between the parties.</li> </ol>

Licence name	Licence text
libpng License	<p>Libpng License</p> <p>This copy of the libpng notices is provided for your convenience. In case of any discrepancy between this copy and the notices in the file png.h that is included in the libpng distribution, the latter shall prevail.</p> <p>COPYRIGHT NOTICE, DISCLAIMER, and LICENSE:</p> <p>If you modify libpng you may insert additional notices immediately following this sentence. libpng versions 1.0.7, July 1, 2000, through 1.0.13, April 15, 2002, are Copyright (c) 2000-2002 Glenn Randers-Pehrson and are distributed according to the same disclaimer and license as libpng-1.0.6 with the following individuals added to the list of Contributing Authors:</p> <p>Simon-Pierre Cadieux, Eric S. Raymond, Gilles Vollant</p> <p>and with the following additions to the disclaimer:</p> <p>There is no warranty against interference with your enjoyment of the library or against infringement. There is no warranty that our efforts or the library will fulfill any of your particular purposes or needs. This library is provided with all faults, and the entire risk of satisfactory quality, performance, accuracy, and effort is with the user.</p> <p>libpng versions 0.97, January 1998, through 1.0.6, March 20, 2000, are Copyright (c) 1998, 1999 Glenn Randers-Pehrson, and are distributed according to the same disclaimer and license as libpng-0.96, with the following individuals added to the list of Contributing Authors:</p> <p>Tom Lane, Glenn Randers-Pehrson, Willem van Schaik.</p> <p>libpng versions 0.89, June 1996, through 0.96, May 1997, are Copyright (c) 1996, 1997 Andreas Dilger Distributed according to the same disclaimer and license as libpng-0.88, with the following individuals added to the list of Contributing Authors:</p> <p>John Bowler, Kevin Bracey, Sam Bushell, Magnus Holmgren, Greg Roelofs, Tom Tanner.</p> <p>libpng versions 0.5, May 1995, through 0.88, January 1996, are Copyright (c) 1995, 1996 Guy Eric Schalnat, Group 42, Inc. For the purposes of this copyright and license, "Contributing Authors" is defined as the following set of individuals:</p> <p>Andreas Dilger, Dave Martindale, Guy Eric Schalnat, Paul Schmidt, Tim Wegner.</p> <p>The PNG Reference Library is supplied "AS IS". The Contributing Authors and Group 42, Inc. disclaim all warranties, expressed or implied, including, without limitation, the warranties of merchantability and of fitness for any purpose. The Contributing Authors and Group 42, Inc. assume no liability for direct, indirect, incidental, special, exemplary, or consequential damages, which may result from the use of the PNG Reference Library, even if advised of the possibility of such damage. Permission is hereby granted to use, copy, modify, and distribute this source code, or portions hereof, for any purpose, without fee, subject to the following restrictions:</p> <ol style="list-style-type: none"> <li>1. The origin of this source code must not be misrepresented.</li> <li>2. Altered versions must be plainly marked as such and must not be misrepresented as being the original source.</li> <li>3. This Copyright notice may not be removed or altered from any source or altered source distribution.</li> </ol> <p>The Contributing Authors and Group 42, Inc. specifically permit, without fee, and encourage the use of this source code as a component to supporting the PNG file format in commercial products. If you use this source code in a product, acknowledgment is not required but would be appreciated. A "png_get_copyright" function is available, for convenient use in "about" boxes and the like:</p> <pre>printf("%s",png_get_copyright(NULL));</pre> <p>Also, the PNG logo (in PNG format, of course) is supplied in the files "pngbar.png" and "pngbar.jpg (88x31) and "pngnow.png" (98x31).</p> <p>Libpng is OSI Certified Open Source Software. OSI Certified Open Source is a certification mark of the Open Source Initiative.</p> <p>Glenn Randers-Pehrson  <a href="mailto:randeg@alum.rpi.edu">randeg@alum.rpi.edu</a>  April 15, 2002</p>
zlib License	<p>The zlib/libpng License</p> <p>Copyright (c) [year] [copyright holders]</p> <p>This software is provided 'as-is', without any express or implied warranty. In no event will the authors be held liable for any damages arising from the use of this software.</p> <p>Permission is granted to anyone to use this software for any purpose, including commercial applications, and to alter it and redistribute it freely, subject to the following restrictions:</p> <ol style="list-style-type: none"> <li>1. The origin of this software must not be misrepresented; you must not claim that you wrote the original software. If you use this software in a product, an acknowledgment in the product documentation would be appreciated but is not required.</li> <li>2. Altered source versions must be plainly marked as such, and must not be misrepresented as being the original software.</li> <li>3. This notice may not be removed or altered from any source distribution.</li> </ol>

## 15.5.9. Detailed information for child restraint manufacturers

The table provides detailed information for manufacturers of child restraint systems regarding which locations in the car are appropriate for different kinds of child restraints.

## 15.5.10. Table for location of child seats using the car's seatbelts

This table gives a recommendation for which child seats suit which locations, and for what size of child.

### Note

Always read the owner's manual section on installing a child seat before installing one in the car.

Weight	Front seat (with deactivated airbag, only rear-facing child seats) <sup>[1]</sup>	Front seat (with activated airbag, only front-facing child seats) <sup>[1]</sup>	Outer rear seat	Centre rear seat
Group 0 max 10 kg	U <sup>[2]</sup>	X	U	U
Group 0+ max 13 kg	U <sup>[2]</sup>	X	U	U
Group 1 9-18 kg	L	UF <sup>[2] [3]</sup>	U <sup>[3]</sup> , L	U <sup>[3]</sup>
Group 2 15 - 25 kg	L	UF <sup>[2]</sup>	U, L	U
Group 3 22 - 36 kg	X	UF <sup>[2]</sup>	U	U

U: Suitable for universal category restraints approved for use in this mass group.  
 UF: Suitable for front-facing universally approved child seats.  
 L: Suitable for particular child restraints. These restraints may be of the specific vehicle, restricted or semi-universal categories.  
 X: The seat is not suitable for children in this mass group.

### Warning

Never use a rear-facing child seat on the front passenger seat if the passenger airbag is activated.

<sup>[1]</sup> The seat cushion extension must always be retracted for the installation of child seats.

<sup>[2]</sup> Adjust the seat to a more elevated position.

<sup>[3]</sup> Volvo recommends rear-facing child seat for children in this mass group.

## 15.5.11. Table for location of i-Size child seats

The table gives a recommendation for which i-Size child seats suit which locations, and for what size of child.

The child seat must be approved in accordance with UN Reg R129.

**Note**

Always read the owner's manual section on installing a child seat before installing one in the car.

Type of child seat	Front seat (with deactivated airbag, only rear-facing child seats)	Front seat (with activated airbag, only front-facing child seats)	Rear seat, outer seat	Centre rear seat
i-Size child seats	X	X	i-U <sup>[1]</sup>	X

i-U: Suitable for i-Size "universal" child seat, front-facing and rear-facing.  
X: Not suitable for universally approved child seats.

<sup>[1]</sup> Volvo recommends that children travel in a rear-facing child seat until as late an age as possible, at least until 4 years of age.

## 15.5.12. Table for location of ISOFIX child seats

The table gives a recommendation for which ISOFIX child seats suit which locations, and for what size of child.

The child seat must be approved in accordance with UN Reg R44 and the vehicle model must be included in the manufacturer's list of vehicles.

**Note**

Always read the section in the Owner's Manual on child restraint installation before installing a child restraint in the vehicle.

Weight	Size class <sup>[1]</sup>	Type of child seat	Front seat (with deactivated airbag, only rear-facing child seats) <sup>[2][3]</sup>	Front seat (with activated airbag, only front-facing child seats) <sup>[2][3]</sup>	Outer rear seat	Centre rear seat
Group 0 max 10 kg	E	Rear-facing infant seat	IL <sup>[2]</sup> , X <sup>[4]</sup>	X	IL	X
Group 0+ max 13 kg	E	Rear-facing infant seat	IL <sup>[2][5]</sup> , X <sup>[4]</sup>	X	IL	X
	C	Rear-facing child seat				
	D	Rear-facing child seat				

Weight	Size class <sup>[1]</sup>	Type of child seat	Front seat (with deactivated airbag, only rear-facing child seats) <sup>[2] [3]</sup>	Front seat (with activated airbag, only front-facing child seats) <sup>[2] [3]</sup>	Outer rear seat	Centre rear seat
Group 1 9-18 kg	A	Front-facing child seat	X	IL <sup>[2] [5] [6]</sup> , X <sup>[4]</sup>	IL <sup>[6]</sup> , IUF <sup>[6]</sup>	X
	B	Front-facing child seat				
	B1	Front-facing child seat				
	C	Rear-facing child seat	IL <sup>[2] [5]</sup> , X <sup>[4]</sup>	X	IL	X
	D	Rear-facing child seat				
Group 2/3 15-36 kg	-	Front-facing child seat	X	IL	IL	X

IL: Suitable for particular ISOFIX child restraint systems. These child restraint systems are those of the specific vehicle, restricted or semi-universal categories.  
IUF: Suitable for ISOFIX forward child restraint systems of universal category approved for use in the mass group.  
X: Not suitable for ISOFIX child restraint systems.

 **Warning**

Never use a rear-facing child seat on the front passenger seat if the passenger airbag is activated.

 **Note**

If an i-Size/ISOFIX child seat has no size classification, the car model must be included on the vehicle list for the child seat.

 **Note**

Volvo recommends contacting an authorised Volvo dealer for information about which i-Size/ISOFIX child seats Volvo recommends.

- <sup>[1]</sup> For child seats with the ISOFIX fixture system there is a size classification to help users choose the right type of child seat. The size class can be read on the child seat's label.
- <sup>[2]</sup> Works for the installation of ISOFIX child seats that are semi-universally approved (IL) if the car is equipped with the ISOFIX console accessory (the accessory range varies depending on market). There are no upper mounting points for child seats here.
- <sup>[3]</sup> The seat cushion extension must always be retracted for the installation of child seats.
- <sup>[4]</sup> Applicable if the car is not fitted with an ISOFIX bracket.
- <sup>[5]</sup> Adjust the backrest so that the head restraint does not interfere with the child seat.
- <sup>[6]</sup> Volvo recommends rear-facing child seat for children in this mass group.

## 15.6. Labels

Your car has a number of labels that provide information about the car and its use, such as specifications and warnings.

### Warning label



Yellow signal panel with warning symbol.

Indicates a potentially hazardous situation which, if not avoided, could result in death or serious injury.

### Notice label



Notice symbol in signal panel.

Indicates a hazardous situation which, if not avoided, could result in minor or moderate damage to property.

## Information label



Label with no signal panel.

Indicates important information but no risk for personal injury or damage to property.

### Note

#### Depicted labels

Labels depicted in this manual are generic representations of those found around your car. The manual only contains their location and what kind of information they hold. Find the actual label for specific information about your car.