

XC90 Recharge Plug-in Hybrid 2021 (20w46) User Manual

Version 2025-11-18

Disclaimer

Due to the dynamic nature of our software-based product, the content of this PDF represents the most up-to-date version of the user manual as of the time of printing. As we continuously update and improve our product, certain content may not reflect the most up-to-date information in a future instance. Therefore, we strongly recommend utilising the digital user manual app in your car's centre display for the most accurate and up-to-date information. You can also access information in the Volvo Cars mobile app.

Please note that if you choose to print the manual, we cannot guarantee the validity of the information in future instances, as updates may have occurred since the time of printing. To ensure the highest level of safety and optimal product usage, we strongly advise relying on the digital user manual, which can be easily accessed through your car's centre display.

This printable version is generic and does not correspond to your car. If there are discrepancies between this printable manual and the manual you see in your car's centre display, the latter takes precedence.

Contents

1. [Owner information](#)
 - 1.1 [Owner information](#)
 - 1.2 [The owner's manual and the environment](#)
 - 1.3 [Reading the owner's manual](#)
 - 1.4 [Owner's manual in centre display](#)
 - 1.5 [Navigate in the owner's manual in the centre display](#)
 - 1.6 [Owner's Manual in mobile devices](#)
2. [Your Volvo](#)
 - 2.1 [Volvo's areas of innovation](#)
 - 2.1.1 [Drive-E - cleaner driving pleasure](#)
 - 2.1.2 [IntelliSafe – driver support and safety](#)
 - 2.1.3 [Sensus - online connectivity and entertainment](#)
 - 2.2 [Volvo ID](#)
 - 2.2.1 [Volvo ID](#)
 - 2.2.2 [Creating a Volvo ID](#)
 - 2.2.3 [Problems logging in with Volvo ID](#)
 - 2.3 [Type approvals and licences](#)
 - 2.3.1 [License agreement for driver display](#)
 - 2.3.2 [Type approval for HomeLink®](#)
 - 2.3.3 [License agreement for audio and media](#)
 - 2.3.4 [Type approval Radio Equipment Directive](#)
 - 2.3.5 [Certificate for wireless charger](#)
 - 2.3.6 [Type approval for the remote control key system](#)
 - 2.3.7 [Customer Privacy Policy](#)
 - 2.3.8 [Terms & Conditions for Services](#)
 - 2.3.9 [Navigation license agreements](#)
 - 2.3.10 [Candidate List Substance Information \(CL\) in accordance with the Reach Regulation, Article 33.1](#)
 - 2.3.11 [Spotify License agreement](#)
 - 2.4 [Displays and controls by the driver in a left-hand drive car](#)
 - 2.5 [Displays and controls by the driver in a right-hand drive car](#)
 - 2.6 [Connection of equipment to the car's diagnostic socket](#)

The content of this manual represents the status of the user manual at the time of printing and may not be completely valid in future instances. For more information, refer to the first page for the complete disclaimer note.

- 2.7 Driver distraction
- 2.8 Change of market when importing or relocating
- 2.9 Showing the car's identification number
- 2.10 Recording data
- 2.11 Installation of accessories
- 2.12 Software updates
- 2.13 Important information on accessories and auxiliary equipment
- 3. Safety
 - 3.1 Seatbelts
 - 3.1.1 Seatbelts
 - 3.1.2 Putting on and taking off seatbelts
 - 3.1.3 Seatbelt tensioner
 - 3.1.4 Resetting the electric seatbelt tensioner
 - 3.1.5 Door and seatbelt reminder
 - 3.2 Airbags
 - 3.2.1 Airbags
 - 3.2.2 Driver airbags
 - 3.2.3 Passenger airbag
 - 3.2.4 Activating and deactivating passenger airbag
 - 3.2.5 Inflatable curtains
 - 3.2.6 Side airbags
 - 3.3 Child safety
 - 3.3.1 Mounting points for child seats
 - 3.3.1.1 Lower mounting points for child seats
 - 3.3.1.2 i-Size/ISOFIX mounting points for child seats
 - 3.3.1.3 Upper mounting points for child seats
 - 3.3.2 Integrated child seat
 - 3.3.2.1 Integrated child seat
 - 3.3.2.2 Folding up the seat cushion in the integrated child seat
 - 3.3.2.3 Folding down the seat cushion in the integrated child seat
 - 3.3.3 Child seat location
 - 3.3.3.1 Table for location of child seats using the car's seatbelts
 - 3.3.3.2 Child seat positioning
 - 3.3.3.3 Child seat mounting
 - 3.3.3.4 Table for location of ISOFIX child seats
 - 3.3.3.5 Table for location of i-Size child seats
 - 3.3.4 Activating and deactivating child safety locks
 - 3.3.5 Child safety
 - 3.3.6 Child seats
 - 3.3.7 Type lists for Volvo's child restraint systems
 - 3.3.8 Activating and deactivating passenger airbag
 - 3.4 Safety mode
 - 3.4.1 Traffic accident
 - 3.4.2 Safety mode
 - 3.4.3 Starting and moving the car after safety mode
 - 3.5 Safety
 - 3.6 Safety during pregnancy
 - 3.7 Whiplash Protection System
- 4. Displays and voice control
 - 4.1 Driver display
 - 4.1.1 Gauges and indicators in driver display
 - 4.1.1.1 Fuel gauge

- 4.1.1.2 Hybrid battery gauge
- 4.1.1.3 Hybrid gauge
- 4.1.1.4 Outside temperature gauge
- 4.1.1.5 Gear shift indicator
- 4.1.2 Trip computer
 - 4.1.2.1 Trip computer
 - 4.1.2.2 Show trip data in driver display
 - 4.1.2.3 Resetting the trip meter
 - 4.1.2.4 Show trip statistics in centre display
 - 4.1.2.5 Settings for trip statistics
- 4.1.3 Driver display
- 4.1.4 Driver display settings
- 4.1.5 License agreement for driver display
- 4.1.6 App menu in the driver display
- 4.1.7 Managing the app menu in the driver display
- 4.1.8 Indicator and warning symbols
- 4.1.9 Messages in the driver display
- 4.1.10 Date and time
- 4.2 Centre display
 - 4.2.1 Settings
 - 4.2.1.1 Resetting user data for change of ownership
 - 4.2.1.2 Other settings in the centre display's top view
 - 4.2.1.3 Resetting settings in the centre display
 - 4.2.1.4 Open contextual setup in the centre display
 - 4.2.1.5 Changing system units
 - 4.2.1.6 Switching off and changing system sound volume in the centre display
 - 4.2.1.7 Changing system language
 - 4.2.1.8 Changing appearance in the centre display
 - 4.2.1.9 Show trip data in driver display
 - 4.2.1.10 Settings for trip statistics
 - 4.2.1.11 Driver display settings
 - 4.2.1.12 Date and time
 - 4.2.1.13 Settings for head-up display
 - 4.2.1.14 User terms and conditions and data sharing
 - 4.2.1.15 Activating and deactivating data sharing
 - 4.2.1.16 Settings for remotely controlled and inside unlocking
 - 4.2.1.17 Care Key settings
 - 4.2.1.18 Lock indication setting
 - 4.2.1.19 Settings for Keyless entry
 - 4.2.1.20 Automatic parking brake activation setting
 - 4.2.1.21 Settings for level control
 - 4.2.2 Driver profiles
 - 4.2.2.1 Driver profiles
 - 4.2.2.2 Renaming a driver profile
 - 4.2.2.3 Linking remote control key to driver profile
 - 4.2.2.4 Protect driver profile
 - 4.2.2.5 Selecting driver profile
 - 4.2.2.6 Resetting settings in the driver profiles
 - 4.2.3 Overview of centre display
 - 4.2.4 Activating and deactivating centre display
 - 4.2.5 Managing the centre display
 - 4.2.6 Navigating in the centre display's views

- 4.2.7 Managing subviews in centre display
- 4.2.8 Symbols in the centre display's status bar
- 4.2.9 Function view in centre display
- 4.2.10 Moving apps and buttons in centre display
- 4.2.11 Message in centre display
- 4.2.12 Keyboard in the centre display
- 4.2.13 Enter the characters, letters and words manually in the centre display
- 4.2.14 Changing keyboard language in centre display
- 4.2.15 Show trip statistics in centre display
- 4.2.16 Owner's manual in centre display
- 4.2.17 Navigate in the owner's manual in the centre display
- 4.3 Head-up display
 - 4.3.1 Head-up display
 - 4.3.2 Head up display when replacing the windscreen
 - 4.3.3 Activating and deactivating the head-up display
 - 4.3.4 Settings for head-up display
 - 4.3.5 Cleaning the Head-up display
 - 4.3.6 Using a stored position for seat, door mirrors and head-up display
 - 4.3.7 Storing position for seat, door mirrors and head-up display
 - 4.3.8 Navigation system in head-up display
- 4.4 Symbols and messages
 - 4.4.1 Message handling
 - 4.4.1.1 Message in centre display
 - 4.4.1.2 Managing messages in the centre display
 - 4.4.1.3 Handling a message saved from the centre display
 - 4.4.1.4 Messages in the driver display
 - 4.4.1.5 Managing messages in the driver display
 - 4.4.1.6 Handling a message saved from the driver display
 - 4.4.2 Messages for BLIS
 - 4.4.3 Messages for City Safety
 - 4.4.4 Messages for Cross Traffic Alert
 - 4.4.5 Symbols and messages for electronic stability control
 - 4.4.6 Symbols and messages for adaptive cruise control
 - 4.4.7 Symbols and messages for Pilot Assist
 - 4.4.8 Symbols and messages for lane assistance
 - 4.4.9 Display mode for lane assistance
 - 4.4.10 Messages for Park Assist Pilot
 - 4.4.11 Symbols and messages for Park Assist
 - 4.4.12 Symbols and messages for Park assist camera
 - 4.4.13 Symbols and messages for steering assistance upon risk of collision
 - 4.4.14 Symbols in the centre display's status bar
 - 4.4.15 Indicator and warning symbols
 - 4.4.16 Symbols and messages for parking climate control
 - 4.4.17 Symbols and messages relating to hybrid drive in the driver display
 - 4.4.18 Overheating in the engine and drive system
 - 4.4.19 Symbols and messages for automatic gearbox
- 4.5 Voice recognition
 - 4.5.1 Controlling climate control with voice recognition
 - 4.5.2 Voice control of radio and media
 - 4.5.3 Voice recognition
 - 4.5.4 Using voice recognition
 - 4.5.5 Updating voice control

- 4.5.6 Tips for improving voice control
- 4.5.7 Settings for voice recognition
- 4.5.8 Command list for voice control of the navigation system
- 4.5.9 Controlling a telephone with voice recognition
- 4.5.10 Voice control of text messages
- 4.5.11 Control the navigation system with voice recognition
- 4.6 Displays and controls by the driver in a left-hand drive car
- 4.7 Displays and controls by the driver in a right-hand drive car
- 5. Lighting
 - 5.1 Exterior lighting
 - 5.1.1 Active bending lights
 - 5.1.2 Active main beam
 - 5.1.3 Using direction indicators
 - 5.1.4 Brake lights
 - 5.1.5 Rear fog lamp
 - 5.1.6 Dipped beam
 - 5.1.7 Using main beam
 - 5.1.8 Using home safe lighting
 - 5.1.9 Adapting the headlamp pattern from the headlamps
 - 5.1.10 Emergency brake lights
 - 5.1.11 Position lamps
 - 5.1.12 Guidance light
 - 5.1.13 Hazard warning flashers
 - 5.1.14 Daytime running lights
 - 5.1.15 Checking trailer lamps
 - 5.2 Interior lighting
 - 5.2.1 Interior lighting
 - 5.2.2 Adjusting interior lighting
 - 5.3 Adjusting light functions via the centre display
 - 5.4 Lighting control
- 6. Windows, glass and mirrors
 - 6.1 Rearview mirrors
 - 6.1.1 HomeLink®
 - 6.1.2 Rearview and door mirrors
 - 6.1.3 Angling adjustment of the door mirrors
 - 6.1.4 Adjusting rearview mirror dimming
 - 6.1.5 Using a stored position for seat, door mirrors and head-up display
 - 6.1.6 Storing position for seat, door mirrors and head-up display
 - 6.1.7 Activating and deactivating the heated rear window and door mirrors
 - 6.1.8 Activating and deactivating automatic starting of the heated rear window and door mirrors
 - 6.2 Windscreen and rear window
 - 6.2.1 Head up display when replacing the windscreen
 - 6.2.2 Wiper blades and washer fluid
 - 6.2.3 Using automatic rear windscreen wiping when reversing
 - 6.2.4 Using the rear window wiper and rear window washer
 - 6.2.5 Using the rain sensor
 - 6.2.6 Activating and deactivating the rain sensor's memory function
 - 6.2.7 Using windscreen and headlamp washers
 - 6.2.8 Using windscreen wipers
 - 6.2.9 Activating and deactivating the heated rear window and door mirrors
 - 6.2.10 Activating and deactivating automatic starting of the heated rear window and door mirrors
 - 6.2.11 Activating and deactivating the heated windscreen

- 6.2.12 Activating and deactivating automatic start of heated windscreen
- 6.3 Side windows and panoramic roof
 - 6.3.1 Power windows
 - 6.3.2 Operating power windows
 - 6.3.3 Panoramic roof
 - 6.3.4 Operating the panoramic roof
 - 6.3.5 Automatic closing of the panoramic roof's sun blind
 - 6.3.6 Using the sun blind
- 6.4 Windows, glass and mirrors
- 6.5 Pinch protection for windows and sun blinds
- 6.6 Reset sequence for pinch protection
- 6.7 Activating and deactivating max defroster
- 7. Seats and steering wheel
 - 7.1 Front seat
 - 7.1.1 Climate controls for front seat
 - 7.1.1.1 Activating and deactivating heated front seat
 - 7.1.1.2 Activating and deactivating automatic start of heated front seat
 - 7.1.1.3 Regulating fan level for front seat
 - 7.1.1.4 Regulating temperature for front seat
 - 7.1.1.5 Synchronising temperature
 - 7.1.1.6 Activating and deactivating ventilated front seat
 - 7.1.2 Memory function for front seat
 - 7.1.2.1 Using a stored position for seat, door mirrors and head-up display
 - 7.1.2.2 Storing position for seat, door mirrors and head-up display
 - 7.1.3 Front seats
 - 7.1.4 Power front seat
 - 7.1.5 Adjusting the power front seat
 - 7.1.6 Adjusting the passenger seat from the driver's seat
 - 7.1.7 Manual front seat
 - 7.1.8 Multifunctional front seat function overview
 - 7.1.9 Massage settings in the front seat
 - 7.1.10 Adjusting massage settings in the front seat
 - 7.1.11 Adjusting the side support in the front seat
 - 7.1.12 Adjusting the length of the seat cushion in the front seat
 - 7.1.13 Adjusting the lumbar support in the front seat
 - 7.2 Rear seat
 - 7.2.1 Climate controls for rear seat
 - 7.2.1.1 Activating and deactivating heated rear seat
 - 7.2.1.2 Regulating fan level for rear seat
 - 7.2.1.3 Regulating temperature for rear seat
 - 7.2.1.4 Activating and deactivating climate for the third row of seats
 - 7.2.2 Rear seat
 - 7.2.3 Adjusting the seat longitudinally in the second seat row
 - 7.2.4 Getting in/out of the third seat row
 - 7.2.5 Adjusting the head restraints in the second seat row
 - 7.2.6 Lowering backrests in the second seat row
 - 7.2.7 Adjusting the backrest inclination in the second seat row
 - 7.2.8 Lowering backrests in the third seat row
 - 7.3 Steering wheel
 - 7.3.1 Speed-dependent steering force
 - 7.3.2 Steering wheel controls and horn
 - 7.3.3 Adjusting the steering wheel

- 7.3.4 Steering lock
- 7.3.5 Activating and deactivating the heated steering wheel
- 7.3.6 Activating and deactivating automatic start of heated steering wheel

8. Climate

8.1 Climate system controls

8.1.1 Climate controls for passenger compartment

- 8.1.1.1 Activating auto climate control
- 8.1.1.2 Regulating fan level for rear seat
- 8.1.1.3 Regulating fan level for front seat
- 8.1.1.4 Activating and deactivating air conditioning
- 8.1.1.5 Activating and deactivating air recirculation
- 8.1.1.6 Activating and deactivating time setting for air recirculation
- 8.1.1.7 Regulating temperature for rear seat
- 8.1.1.8 Regulating temperature for front seat
- 8.1.1.9 Synchronising temperature
- 8.1.1.10 Changing air distribution
- 8.1.1.11 Activating and deactivating climate for the third row of seats

8.1.2 Climate controls for seat and steering wheel

- 8.1.2.1 Activating and deactivating the heated steering wheel
- 8.1.2.2 Activating and deactivating automatic start of heated steering wheel
- 8.1.2.3 Activating and deactivating heated rear seat
- 8.1.2.4 Activating and deactivating heated front seat
- 8.1.2.5 Activating and deactivating automatic start of heated front seat
- 8.1.2.6 Activating and deactivating ventilated front seat

8.1.3 Climate controls for windows and mirrors

- 8.1.3.1 Activating and deactivating the heated rear window and door mirrors
- 8.1.3.2 Activating and deactivating automatic starting of the heated rear window and door mirrors
- 8.1.3.3 Activating and deactivating the heated windscreen
- 8.1.3.4 Activating and deactivating automatic start of heated windscreen
- 8.1.3.5 Activating and deactivating max defroster

8.1.4 Climate controls

8.2 Air distribution

- 8.2.1 Activating and deactivating air recirculation
- 8.2.2 Activating and deactivating time setting for air recirculation
- 8.2.3 Activating and deactivating max defroster
- 8.2.4 Air distribution
- 8.2.5 Changing air distribution
- 8.2.6 Table of air distribution options
- 8.2.7 Opening, closing and aiming the air vents

8.3 Air quality

- 8.3.1 Air quality
- 8.3.2 Advanced Air Cleaner
- 8.3.3 CleanZone
- 8.3.4 Clean Zone Interior Package
- 8.3.5 Interior Air Quality System
- 8.3.6 Activating and deactivating the air quality sensor
- 8.3.7 Passenger compartment filter
- 8.3.8 Pre-cleaning
- 8.3.9 Starting and switching off pre-cleaning
- 8.3.10 Air Quality app

8.4 Parking climate

- 8.4.1 Preconditioning

- 8.4.1.1 Preconditioning
- 8.4.1.2 Start and switch off preconditioning
- 8.4.1.3 Preconditioning time setting
- 8.4.1.4 Activating and deactivating time setting for preconditioning
- 8.4.1.5 Removing time setting for preconditioning
- 8.4.1.6 Adding and editing time setting for preconditioning
- 8.4.2 Pre-cleaning
 - 8.4.2.1 Pre-cleaning
 - 8.4.2.2 Starting and switching off pre-cleaning
- 8.4.3 Climate comfort for parking
 - 8.4.3.1 Climate comfort when parking
 - 8.4.3.2 Starting and switching off climate comfort when parking
- 8.4.4 Parking climate
- 8.4.5 Symbols and messages for parking climate control
- 8.4.6 Parking heater
- 8.5 Heater
 - 8.5.1 Heater
 - 8.5.2 Parking heater
 - 8.5.3 Additional heater
 - 8.5.4 Activating and deactivating automatic start of auxiliary heater
- 8.6 Climate
- 8.7 Controlling climate control with voice recognition
- 8.8 Servicing the climate control system
- 8.9 Climate control - sensors
- 8.10 Climate zones
- 8.11 Perceived temperature
- 9. Key, locks and alarm
 - 9.1 Remote control key
 - 9.1.1 Driver profiles
 - 9.1.1.1 Driver profiles
 - 9.1.1.2 Renaming a driver profile
 - 9.1.1.3 Linking remote control key to driver profile
 - 9.1.1.4 Protect driver profile
 - 9.1.1.5 Selecting driver profile
 - 9.1.1.6 Resetting settings in the driver profiles
 - 9.1.2 Linking remote control key to driver profile
 - 9.1.3 Immobiliser
 - 9.1.4 Remote control key
 - 9.1.5 Ordering more remote control keys
 - 9.1.6 Replacing the battery in the remote control key
 - 9.1.7 Locking and unlocking with the remote control key
 - 9.1.8 Care Key - restricted remote control key
 - 9.1.9 Care Key settings
 - 9.1.10 Unlocking the tailgate with the remote control key
 - 9.1.11 Detachable key blade
 - 9.1.12 Locking and unlocking with the detachable key blade
 - 9.1.13 Remote control key range
 - 9.1.14 Type approval for the remote control key system
 - 9.1.15 Antenna locations for the start and lock systems
 - 9.1.16 Ignition positions
 - 9.1.17 Selecting ignition mode
 - 9.2 Locking and unlocking

- 9.2.1 Keyless locking and unlocking
 - 9.2.1.1 Operating the tailgate with foot movement
 - 9.2.1.2 Antenna locations for the start and lock systems
 - 9.2.1.3 Keyless with touch-sensitive surfaces
 - 9.2.1.4 Keyless locking and unlocking
 - 9.2.1.5 Settings for Keyless entry
 - 9.2.1.6 Closing and locking tailgate with button
 - 9.2.1.7 Keyless unlocking of the tailgate
 - 9.2.2 Remote control key
 - 9.2.3 Locking and unlocking with the remote control key
 - 9.2.4 Settings for remotely controlled and inside unlocking
 - 9.2.5 Unlocking the tailgate with the remote control key
 - 9.2.6 Locking and unlocking with the detachable key blade
 - 9.2.7 Automatic locking when driving
 - 9.2.8 Double lock
 - 9.2.9 Setting the max. opening for electrically operated tailgate
 - 9.2.10 Locking and unlocking from inside the car
 - 9.2.11 Unlocking the tailgate from the inside of the car
 - 9.2.12 Private locking
 - 9.2.13 Activating and deactivating private locking
 - 9.2.14 Locking and unlocking
 - 9.2.15 Activating and deactivating child safety locks
 - 9.2.16 Lock confirmation
 - 9.2.17 Lock indication setting
- 9.3 Alarm
- 9.3.1 Alarm
 - 9.3.2 Activating and deactivating alarms
 - 9.3.3 Reduced alarm level
10. Driver support
- 10.1 Cruise control functions
 - 10.1.1 Cruise control
 - 10.1.1.1 Cruise control
 - 10.1.1.2 Standby mode for cruise control
 - 10.1.1.3 Setting the stored speed for cruise control functions
 - 10.1.2 Adaptive cruise control
 - 10.1.2.1 Adaptive cruise control
 - 10.1.2.2 Symbols and messages for adaptive cruise control
 - 10.1.2.3 Standby mode for adaptive cruise control
 - 10.1.2.4 Automatic braking with cruise control functions
 - 10.1.2.5 Setting the stored speed for cruise control functions
 - 10.1.2.6 Change of target with cruise control functions
 - 10.1.2.7 Setting time interval to vehicle ahead
 - 10.1.2.8 Warning from cruise control functions in the event of a collision risk
 - 10.1.3 Pilot Assist
 - 10.1.3.1 Automatic braking with cruise control functions
 - 10.1.3.2 Setting the stored speed for cruise control functions
 - 10.1.3.3 Change of target with cruise control functions
 - 10.1.3.4 Pilot Assist
 - 10.1.3.5 Display for adaptive cruise control and Pilot Assist
 - 10.1.3.6 Symbols and messages for Pilot Assist
 - 10.1.3.7 Standby mode for Pilot Assist
 - 10.1.3.8 Setting time interval to vehicle ahead

- 10.1.3.9 Difference between Pilot Assist and lane assistance
 - 10.1.3.10 Warning from cruise control functions in the event of a collision risk
 - 10.1.4 Cornering support
 - 10.1.4.1 Cornering support
 - 10.1.4.2 Activating and deactivating cornering support
 - 10.1.4.3 Limitations for cornering support
 - 10.1.5 Overtaking assistance
 - 10.1.5.1 Overtaking Assistance
 - 10.1.5.2 Use Overtaking Assistance
 - 10.1.6 Cruise control functions
 - 10.1.7 Steering wheel buttons for the cruise control functions
 - 10.1.8 Selecting and activating cruise control functions
 - 10.1.9 Deactivating cruise control functions
- 10.2 Speed limiter functions
 - 10.2.1 Speed limiter
 - 10.2.1.1 Speed limiter
 - 10.2.2 Automatic speed limiter
 - 10.2.2.1 Automatic speed limiter
- 10.3 Distance Warning
 - 10.3.1 Distance Warning
 - 10.3.2 Activating and deactivating Distance Warning
 - 10.3.3 Limitations of distance warning
 - 10.3.4 Setting time interval to vehicle ahead
 - 10.3.5 Warning from cruise control functions in the event of a collision risk
- 10.4 Blind Spot Information
 - 10.4.1 BLIS
 - 10.4.2 Activating and deactivating BLIS
 - 10.4.3 Messages for BLIS
 - 10.4.4 Limitations of BLIS
- 10.5 Cross Traffic Alert
 - 10.5.1 Cross Traffic Alert
 - 10.5.2 Activating and deactivating Cross Traffic Alert
 - 10.5.3 Messages for Cross Traffic Alert
 - 10.5.4 Limitations of Cross Traffic Alert
- 10.6 Rear Collision Warning
 - 10.6.1 Rear Collision Warning
 - 10.6.2 Limitations of Rear Collision Warning
- 10.7 Connected Safety
 - 10.7.1 Connected Safety
 - 10.7.2 Activating and deactivating Connected Safety
 - 10.7.3 Limitations of Connected Safety
- 10.8 City Safety
 - 10.8.1 City Safety™
 - 10.8.2 Subfunctions for City Safety
 - 10.8.3 Setting the warning distance for City Safety
 - 10.8.4 Messages for City Safety
 - 10.8.5 Limitations of City Safety
 - 10.8.6 City Safety brakes for oncoming vehicles
 - 10.8.7 City Safety in cross traffic
 - 10.8.8 Limitations for City Safety in cross traffic
 - 10.8.9 City Safety steering assistance for evasive manoeuvre
 - 10.8.10 Limitations of City Safety steering assistance when taking evasive action

- 10.8.11 Automatic braking in the event of an impeded evasive manoeuvre with City Safety
- 10.8.12 Detection of obstacles with City Safety
- 10.9 Steering assistance at risk of collision
 - 10.9.1 Steering assistance at risk of collision
 - 10.9.2 Activating or deactivating steering assistance in the event of a collision risk
 - 10.9.3 Symbols and messages for steering assistance upon risk of collision
 - 10.9.4 Limitations for steering assistance at risk of collision
 - 10.9.5 Steering assistance upon risk of run-off
 - 10.9.6 Steering assistance upon risk of head-on collision
 - 10.9.7 Steering assistance upon risk of rear-end collision
- 10.10 Driver Alert Control
 - 10.10.1 Driver Alert Control
 - 10.10.2 Activating and deactivating Driver Alert Control
 - 10.10.3 Selecting rest stop guidance in the event of a warning from Driver Alert Control
 - 10.10.4 Limitations of Driver Alert Control
- 10.11 Lane assistance
 - 10.11.1 Lane assistance
 - 10.11.2 Activating and deactivating lane assistance
 - 10.11.3 Difference between Pilot Assist and lane assistance
 - 10.11.4 Select assistance option for lane assistance
 - 10.11.5 Symbols and messages for lane assistance
 - 10.11.6 Display mode for lane assistance
 - 10.11.7 Limitations of Lane assistance
- 10.12 Electronic stability control
 - 10.12.1 Electronic stability control
 - 10.12.2 Symbols and messages for electronic stability control
 - 10.12.3 Electronic Stability Control in sport mode
 - 10.12.4 Activating and deactivating sport mode for electronic stability control
- 10.13 Road Sign Information
 - 10.13.1 Road Sign Information
 - 10.13.2 Road Sign Information and Sensus Navigation
 - 10.13.3 Activating and deactivating Road Sign Information
 - 10.13.4 Limitations of Road Sign Information
 - 10.13.5 Warning for speed limitation and speed camera from road sign information
 - 10.13.6 Activating and deactivating warnings from road sign information
 - 10.13.7 Display mode for road sign information
- 10.14 Parking functions
 - 10.14.1 Parking assistance
 - 10.14.1.1 Park Assist
 - 10.14.1.2 Park Assist System front, rear and along the sides
 - 10.14.1.3 Activating and deactivating Parking Assistance System
 - 10.14.1.4 Symbols and messages for Park Assist
 - 10.14.1.5 Limitations of Parking assistance
 - 10.14.2 Active park assist
 - 10.14.2.1 Park Assist Pilot
 - 10.14.2.2 Parking variants with Park Assist Pilot
 - 10.14.2.3 Using Park Assist Pilot
 - 10.14.2.4 Leaving parallel parking with Park Assist Pilot
 - 10.14.2.5 Messages for Park Assist Pilot
 - 10.14.2.6 Limitations of Park Assist Pilot
 - 10.14.3 Park assist camera
 - 10.14.3.1 Park assist camera

- 10.14.3.2 Activate park assist camera
 - 10.14.3.3 Symbols and messages for Park assist camera
 - 10.14.3.4 Park assist lines for park assist camera
 - 10.14.3.5 Park assist camera locations and surveillance areas
 - 10.14.3.6 Sensor fields for parking assistance system
 - 10.15 Camera and radar unit
 - 10.15.1 Recommended maintenance for camera and radar units
 - 10.15.2 Symbols and messages for camera and radar units
 - 10.15.3 Limitations for camera and radar units
 - 10.15.4 Camera unit
 - 10.15.5 Radar unit
 - 10.15.6 Type approval for radar device
 - 10.16 Driving support systems
 - 10.17 Safety check of driver support when starting
 - 10.18 Warnings from various driver support systems
 - 10.19 Speed-dependent steering force
 - 10.20 Drive modes when using time interval to vehicles
 - 10.21 IntelliSafe – driver support and safety
 - 10.22 Auto braking after a collision
- 11. Electric operation and charging
 - 11.1 Charging the hybrid battery
 - 11.1.1 Charging status in the car's driver display
 - 11.1.2 Regenerative braking
 - 11.1.3 Opening and closing the hatch to the charging input socket
 - 11.1.4 Charging status in the car's charging input socket
 - 11.1.5 Charging cable
 - 11.1.6 Ground fault breaker in charging cable
 - 11.1.7 Charging status in the charging cable's control unit
 - 11.1.8 Charging cable temperature monitoring
 - 11.1.9 Charging the hybrid battery
 - 11.1.10 Starting hybrid battery charging
 - 11.1.11 Ending hybrid battery charging
 - 11.1.12 Charging current
 - 11.2 Hybrid battery gauge
 - 11.3 Hybrid gauge
 - 11.4 Drive systems
 - 11.5 Hold and Charge
 - 11.6 Drive modes
 - 11.7 General information on electric drive
 - 11.8 Symbols and messages relating to hybrid drive in the driver display
 - 11.9 Long-term storage of cars with hybrid batteries
 - 11.10 Range in electric mode
 - 11.11 Economical driving
 - 11.12 Recycling the batteries
 - 11.13 Hybrid battery
- 12. Starting and driving
 - 12.1 Starting and switching off the car
 - 12.1.1 Immobiliser
 - 12.1.2 Starting the car
 - 12.1.3 Using jump starting with another battery
 - 12.1.4 Switching off the car
 - 12.1.5 Ignition positions

- 12.1.6 Selecting ignition mode
- 12.2 Alcohol lock
 - 12.2.1 Alcohol lock
 - 12.2.2 Bypass of the alcohol lock
 - 12.2.3 Before starting with the alcohol lock
- 12.3 Gearbox
 - 12.3.1 Kick-down function
 - 12.3.2 Launch function
 - 12.3.3 Gearbox
 - 12.3.4 Automatic gearbox
 - 12.3.5 Changing gear with automatic gearbox
 - 12.3.6 Symbols and messages for automatic gearbox
 - 12.3.7 All-wheel drive
 - 12.3.8 Gear selector inhibitor
 - 12.3.9 Gear shift indicator
- 12.4 Brakes
 - 12.4.1 Foot brake
 - 12.4.1.1 Brake assistance
 - 12.4.1.2 Braking on gritted roads
 - 12.4.1.3 Braking on wet roads
 - 12.4.1.4 Foot brake
 - 12.4.1.5 Brake system maintenance
 - 12.4.2 Parking brake
 - 12.4.2.1 Parking brake
 - 12.4.2.2 Activating and deactivating the parking brake
 - 12.4.2.3 Parking on a hill
 - 12.4.2.4 Automatic parking brake activation setting
 - 12.4.2.5 In the event of a fault in the parking brake
 - 12.4.3 Brake fluid – specifications
 - 12.4.4 Brake functions
 - 12.4.5 Automatic braking when stationary
 - 12.4.6 Activating and deactivating the automatic brake at a standstill
 - 12.4.7 Auto braking after a collision
 - 12.4.8 Help when starting on a hill
 - 12.4.9 Regenerative braking
 - 12.4.10 Low speed control
 - 12.4.11 Hill descent control
- 12.5 Drive system
 - 12.5.1 Drive systems
- 12.6 Drive modes
 - 12.6.1 Regenerative braking
 - 12.6.2 Hold and Charge
 - 12.6.3 Drive modes
 - 12.6.4 Changing drive mode
 - 12.6.5 Energy distribution using map data
 - 12.6.6 Launch function
 - 12.6.7 Low speed control
 - 12.6.8 Activating and deactivating low speed control
 - 12.6.9 Level control and shock absorption
 - 12.6.10 Settings for level control
 - 12.6.11 Hill descent control
 - 12.6.12 Activating and deactivating hill descent control

- 12.6.13 Range in electric mode
- 12.6.14 All-wheel drive
- 12.7 Recommendations for driving
 - 12.7.1 Towing
 - 12.7.2 Help when starting on a hill
 - 12.7.3 Braking on gritted roads
 - 12.7.4 Braking on wet roads
 - 12.7.5 Parking on a hill
 - 12.7.6 Petrol particle filter
 - 12.7.7 Petrol station
 - 12.7.8 Energy distribution using map data
 - 12.7.9 Range in electric mode
 - 12.7.10 Economical driving
 - 12.7.11 Preparations for a long trip
 - 12.7.12 Overloading the starter battery
 - 12.7.13 Driving in water
 - 12.7.14 Winter driving
 - 12.7.15 Overheating in the engine and drive system
 - 12.7.16 Driving with a trailer
- 12.8 Towbar and trailer
 - 12.8.1 Towing capacity and towball load
 - 12.8.2 Towbar
 - 12.8.3 Specifications for towbar
 - 12.8.4 Towbar-mounted bicycle rack
 - 12.8.5 Extendable and retractable towbar
 - 12.8.6 Low speed control
 - 12.8.7 Driving with a trailer
 - 12.8.8 Trailer stability assist
 - 12.8.9 Checking trailer lamps
- 12.9 Fuel
 - 12.9.1 Fuel gauge
 - 12.9.2 Handling of fuel
 - 12.9.3 Petrol
- 12.10 Refuelling
 - 12.10.1 Handling of fuel
 - 12.10.2 Fuel consumption and CO₂ emissions
 - 12.10.3 Petrol station
 - 12.10.4 Fuel tank - volume
 - 12.10.5 Filling fuel
 - 12.10.6 Opening and closing the fuel filler flap
- 12.11 Emission control
 - 12.11.1 Petrol particle filter
- 12.12 Electric operation and charging
 - 12.12.1 Charging the hybrid battery
 - 12.12.1.1 Charging status in the car's driver display
 - 12.12.1.2 Regenerative braking
 - 12.12.1.3 Opening and closing the hatch to the charging input socket
 - 12.12.1.4 Charging status in the car's charging input socket
 - 12.12.1.5 Charging cable
 - 12.12.1.6 Ground fault breaker in charging cable
 - 12.12.1.7 Charging status in the charging cable's control unit
 - 12.12.1.8 Charging cable temperature monitoring

- 12.12.1.9 Charging the hybrid battery
 - 12.12.1.10 Starting hybrid battery charging
 - 12.12.1.11 Ending hybrid battery charging
 - 12.12.1.12 Charging current
 - 12.12.2 Hybrid battery gauge
 - 12.12.3 Hybrid gauge
 - 12.12.4 Drive systems
 - 12.12.5 Hold and Charge
 - 12.12.6 Drive modes
 - 12.12.7 General information on electric drive
 - 12.12.8 Symbols and messages relating to hybrid drive in the driver display
 - 12.12.9 Long-term storage of cars with hybrid batteries
 - 12.12.10 Range in electric mode
 - 12.12.11 Economical driving
 - 12.12.12 Recycling the batteries
 - 12.12.13 Hybrid battery
 - 12.13 HomeLink
 - 12.13.1 HomeLink®
 - 12.13.2 Using HomeLink®
 - 12.13.3 Programming HomeLink®
 - 12.13.4 Type approval for HomeLink®
 - 12.14 Compass
 - 12.14.1 Compass
 - 12.14.2 Activating and deactivating the compass
 - 12.14.3 Calibrating the compass
 - 12.15 Towing and recovery
 - 12.15.1 Towing
 - 12.15.2 Fitting and removing the towing eye
 - 12.15.3 Recovery
 - 12.15.4 Safety mode
 - 12.15.5 Starting and moving the car after safety mode
 - 12.16 Operational disruption
 - 12.17 Traffic accident
13. Sound, media and Internet
- 13.1 Radio
 - 13.1.1 Digital radio
 - 13.1.1.1 Digital radio
 - 13.1.1.2 Link between FM and digital radio
 - 13.1.2 Voice control of radio and media
 - 13.1.3 Radio
 - 13.1.4 Start radio
 - 13.1.5 Changing radio band and radio station
 - 13.1.6 Searching for radio stations
 - 13.1.7 Settings for radio
 - 13.1.8 RDS radio
 - 13.1.9 Save radio channels in the Radio Favourites app
 - 13.2 Media player
 - 13.2.1 Video
 - 13.2.1.1 Video
 - 13.2.1.2 Playing a video
 - 13.2.1.3 Playing back DivX®
 - 13.2.1.4 Settings for video

- 13.2.2 Media via Bluetooth®
- 13.2.3 Connecting a device via Bluetooth®
- 13.2.4 Voice control of radio and media
- 13.2.5 Media player
- 13.2.6 Media playback
- 13.2.7 Controlling and changing media
- 13.2.8 Searching media
- 13.2.9 Compatible media formats
- 13.2.10 Gracenote®
- 13.2.11 Updating Gracenote®
- 13.2.12 Media via USB port
- 13.2.13 Connecting a device via USB port
- 13.2.14 Technical specifications for USB devices
- 13.3 Phone
 - 13.3.1 Phone connection
 - 13.3.1.1 Connecting a phone to the car via Bluetooth automatically
 - 13.3.1.2 Connecting a phone to the car via Bluetooth for the first time
 - 13.3.1.3 Disconnecting a Bluetooth-connected phone
 - 13.3.1.4 Switch between Bluetooth-connected phones
 - 13.3.1.5 Removing devices connected to Bluetooth
 - 13.3.1.6 Bluetooth profiles for Sensus Connect
 - 13.3.1.7 Connecting a phone to the car via Bluetooth manually
 - 13.3.2 Apple CarPlay
 - 13.3.2.1 Apple® CarPlay®
 - 13.3.2.2 Using Apple® CarPlay®
 - 13.3.2.3 Tips for using Apple® CarPlay®
 - 13.3.2.4 Settings for Apple® CarPlay®
 - 13.3.3 Android Auto
 - 13.3.3.1 Android Auto
 - 13.3.3.2 Using Android Auto
 - 13.3.3.3 Tips for using Android Auto
 - 13.3.3.4 Settings for Android Auto
 - 13.3.4 Settings for Bluetooth devices
 - 13.3.5 Bluetooth compatibility with phones
 - 13.3.6 Connect the car to the Internet via a Bluetooth-enabled phone
 - 13.3.7 Phone
 - 13.3.8 Controlling a telephone with voice recognition
 - 13.3.9 Settings for phone
 - 13.3.10 Managing the phone book
 - 13.3.11 Managing phone calls
 - 13.3.12 Managing text messages
 - 13.3.13 Settings for text messages
 - 13.3.14 Wireless phone charger
 - 13.3.15 Using the wireless phone charger
 - 13.3.16 Certificate for wireless charger
- 13.4 Apps
 - 13.4.1 Available in-car apps
 - 13.4.1.1 Android Auto
 - 13.4.1.2 Available apps
 - 13.4.1.3 Apple® CarPlay®
 - 13.4.1.4 Air Quality app
 - 13.4.1.5 Google Local Search

- 13.4.1.6 [Park and Pay](#)
 - 13.4.1.7 [Record & Send](#)
 - 13.4.1.8 [Spotify](#)
 - 13.4.1.9 [TuneIn](#)
 - 13.4.1.10 [Using TuneIn](#)
 - 13.4.1.11 [Weather](#)
 - 13.4.1.12 [WikiLocations](#)
 - 13.4.1.13 [Yelp](#)
 - 13.4.1.14 [Car status](#)
 - 13.4.1.15 [Download Center](#)
 - 13.4.2 [Apps](#)
 - 13.4.3 [Downloading apps](#)
 - 13.4.4 [Deleting apps](#)
 - 13.4.5 [Updating apps](#)
 - 13.4.6 [Volvo ID](#)
 - 13.4.7 [Creating a Volvo ID](#)
 - 13.5 [Internet connection](#)
 - 13.5.1 [Online services](#)
 - 13.5.1.1 [Connected Safety](#)
 - 13.5.1.2 [Apps](#)
 - 13.5.1.3 [User terms and conditions and data sharing](#)
 - 13.5.1.4 [Activating and deactivating data sharing](#)
 - 13.5.1.5 [Data sharing for Volvo On Call](#)
 - 13.5.1.6 [Data sharing for driver profile](#)
 - 13.5.1.7 [Data sharing for services](#)
 - 13.5.1.8 [Volvo ID](#)
 - 13.5.1.9 [Creating a Volvo ID](#)
 - 13.5.1.10 [Real Time Traffic Information](#)
 - 13.5.1.11 [Volvo On Call](#)
 - 13.5.2 [Tips for using the Bluetooth connection](#)
 - 13.5.3 [Connect the car to the Internet via a Bluetooth-enabled phone](#)
 - 13.5.4 [Internet-connected car](#)
 - 13.5.5 [Tips in the event of problems with Internet connection](#)
 - 13.5.6 [Sharing Internet access from the car via a Wi-Fi hotspot](#)
 - 13.5.7 [Connect the car to the Internet via a phone \(Wi-Fi\)](#)
 - 13.5.8 [Connect the car to the Internet via car modem \(SIM card\)](#)
 - 13.5.9 [Settings for car modem](#)
 - 13.5.10 [No or poor Internet connection](#)
 - 13.5.11 [Remove Wi-Fi network](#)
 - 13.5.12 [Wi-Fi technologies and security](#)
 - 13.6 [Sound, media and Internet](#)
 - 13.7 [License agreement for audio and media](#)
 - 13.8 [Storage space on hard disk](#)
 - 13.9 [Sound settings](#)
 - 13.10 [Sound experience](#)
 - 13.11 [Customer Privacy Policy](#)
 - 13.12 [Sensus - online connectivity and entertainment](#)
 - 13.13 [Terms & Conditions for Services](#)
14. [Volvo On Call](#)
 - 14.1 [Volvo On Call services](#)
 - 14.1.1 [Help with Volvo On Call](#)
 - 14.1.2 [Emergency assistance with Volvo On Call](#)

- 14.1.3 Automatic collision alarm with Volvo On Call
- 14.1.4 Send destinations to the car's navigation system via a Volvo On Call service centre
- 14.1.5 Remote Vehicle Immobiliser (RVI) with Volvo On Call
- 14.1.6 Remote Door Unlock (RDU) with Volvo On Call
- 14.1.7 Stolen Vehicle Tracking (SVT) with Volvo On Call
- 14.1.8 Theft Notification (TN) with Volvo On Call
- 14.1.9 Help during a trip with Volvo On Call
- 14.1.10 Customer service via Volvo On Call
- 14.2 Practical information on Volvo On Call
 - 14.2.1 Getting started with Volvo On Call
 - 14.2.2 Prioritising between Volvo On Call service centre and emergency call centre
 - 14.2.3 PIN code for Volvo On Call
 - 14.2.4 Standby battery for Volvo On Call
 - 14.2.5 Volvo On Call abroad
 - 14.2.6 Volvo On Call availability
 - 14.2.7 Change of ownership with Volvo On Call
- 14.3 Volvo On Call app
 - 14.3.1 The Volvo Cars-app
- 14.4 Data sharing for Volvo On Call
- 14.5 Volvo On Call
- 14.6 Volvo On Call subscription
- 14.7 Extend your Volvo On Call subscription
- 14.8 Right to cancel purchase of Volvo On Call subscription extension
- 14.9 Messages for Volvo On Call
- 15. Navigation
 - 15.1 Enter destination
 - 15.1.1 Enter destination directly on map
 - 15.1.2 Specifying a destination with an address
 - 15.1.3 Specify destination with free text searching
 - 15.1.4 Specify destination with point of interest
 - 15.1.5 Specifying a destination with latest/favourites/library
 - 15.1.6 Specify destination with Send to Car
 - 15.1.7 Select a detour in the navigation system
 - 15.1.8 Energy distribution using map data
 - 15.1.9 Send destinations to the car's navigation system via a Volvo On Call service centre
 - 15.2 Itinerary and route
 - 15.2.1 Information card in navigation system
 - 15.2.2 Showing POIs along a route
 - 15.2.3 Itinerary
 - 15.2.4 Show an alternative route
 - 15.2.5 Edit or delete the itinerary
 - 15.2.6 Show itinerary
 - 15.2.7 Showing guidance points in the itinerary
 - 15.2.8 Select a detour in the navigation system
 - 15.3 Traffic information
 - 15.3.1 Information card in navigation system
 - 15.3.2 Select a detour in the navigation system
 - 15.3.3 Traffic disruptions on the map
 - 15.3.4 Showing traffic congestion along route
 - 15.3.5 Real Time Traffic Information
 - 15.3.6 Activating and deactivating Real Time Traffic Information
 - 15.4 Settings for navigation

- 15.4.1 Map settings
 - 15.4.2 Navigation system settings
 - 15.4.3 Settings for route and road navigation
 - 15.4.4 Traffic settings
 - 15.5 Map update
 - 15.5.1 Updating maps from an online car
 - 15.5.2 Updating maps via computer and USB
 - 15.5.3 Map updates
 - 15.6 Command list for voice control of the navigation system
 - 15.7 Sensus Navigation
 - 15.8 Activating and deactivating the navigation system
 - 15.9 Control the navigation system with voice recognition
 - 15.10 Frequently asked questions about the navigation system
 - 15.11 Symbols and buttons in the navigation system
 - 15.12 Navigation license agreements
 - 15.13 Navigation system in centre display
 - 15.14 Navigation system in driver display
 - 15.15 Activating and deactivating the navigation system in the driver display
 - 15.16 Navigation system in head-up display
 - 15.17 Suggest new map information with Map Creator
 - 15.18 Traffic information providers
16. Wheels and tyres
- 16.1 Changing wheels
 - 16.1.1 Changing wheel
 - 16.1.2 Jack
 - 16.1.3 Wheel bolts
 - 16.1.4 Spare wheel
 - 16.1.5 Handling the spare wheel
 - 16.1.6 Snow chains
 - 16.1.7 Winter tyres
 - 16.1.8 Punctures
 - 16.1.9 Tool kit
 - 16.2 Tyres
 - 16.2.1 Dimension designation for tyre
 - 16.2.2 Approved tyre pressures
 - 16.2.3 Tyres' rotation direction
 - 16.2.4 Tread wear indicators on the tyres
 - 16.2.5 Dimension designation for wheel rim
 - 16.2.6 Minimum permitted tyre load index and speed rating for tyres
 - 16.3 Tyre pressure
 - 16.3.1 Tyre pressure monitoring
 - 16.3.1.1 Tyre pressure monitoring system
 - 16.3.1.2 See tyre pressure status in the centre display
 - 16.3.1.3 Action in the event of warning for low tyre pressure
 - 16.3.1.4 Saving a new reference value for tyre pressure monitoring
 - 16.3.1.5 Messages for tyre pressure monitoring
 - 16.3.2 Checking tyre pressure
 - 16.3.3 Adjusting tyre pressure
 - 16.3.4 Location of tyre pressure label
 - 16.4 Emergency puncture repair
 - 16.4.1 Emergency puncture repair kit
 - 16.4.2 Inflating tyres with the compressor from the puncture repair kit

- 16.4.3 Using a puncture repair kit
- 16.5 Winter driving
 - 16.5.1 Snow chains
 - 16.5.2 Winter tyres
 - 16.5.3 Preparations for a long trip
 - 16.5.4 Winter driving
- 16.6 Tyres
- 16.7 Approved wheel and tyre sizes
- 17. Loading, storage and passenger compartment
 - 17.1 Loading
 - 17.1.1 Recommendations for loading
 - 17.1.2 Bag hooks
 - 17.1.3 Operating cargo cover
 - 17.1.4 Fitting and removing cargo cover
 - 17.1.5 Load retaining eyelets
 - 17.1.6 Fitting and removing safety grilles
 - 17.1.7 Fitting and removing the safety net
 - 17.1.8 Roof load and loading on load carriers
 - 17.1.9 Towbar-mounted bicycle rack
 - 17.1.10 Driving with a trailer
 - 17.2 Cargo area
 - 17.2.1 Safety net, safety grille and cargo cover
 - 17.2.1.1 Operating cargo cover
 - 17.2.1.2 Fitting and removing cargo cover
 - 17.2.1.3 Fitting and removing safety grilles
 - 17.2.1.4 Fitting and removing the safety net
 - 17.2.2 Cargo area
 - 17.2.3 Bag hooks
 - 17.2.4 First aid kit
 - 17.2.5 Load retaining eyelets
 - 17.2.6 Warning triangle
 - 17.2.7 Unlocking the tailgate with the remote control key
 - 17.2.8 Setting the max. opening for electrically operated tailgate
 - 17.2.9 Operating the tailgate with foot movement
 - 17.2.10 Unlocking the tailgate from the inside of the car
 - 17.2.11 Keyless unlocking of the tailgate
 - 17.2.12 Fuses in cargo area
 - 17.3 Storage and passenger compartment
 - 17.3.1 Passenger compartment interior
 - 17.3.2 Electrical sockets
 - 17.3.3 Using electrical sockets
 - 17.3.4 Using the glovebox
 - 17.3.5 Sun visors
 - 17.3.6 Tunnel console
 - 17.3.7 Fuses under glovebox
- 18. Maintenance and service
 - 18.1 Car care
 - 18.1.1 Interior cleaning
 - 18.1.1.1 Cleaning the centre display
 - 18.1.1.2 Cleaning the driver display
 - 18.1.1.3 Cleaning the Head-up display
 - 18.1.1.4 Cleaning the leather steering wheel

- 18.1.1.5 Cleaning the seatbelts
- 18.1.1.6 Cleaning the interior
- 18.1.1.7 Cleaning textile floor and entrance mats
- 18.1.1.8 Cleaning interior plastic, metal and wood parts
- 18.1.1.9 Cleaning leather upholstery
- 18.1.1.10 Cleaning fabric upholstery and headlining
- 18.1.2 Exterior cleaning
 - 18.1.2.1 Cleaning the exterior lamps
 - 18.1.2.2 Cleaning the wiper blades
 - 18.1.2.3 Car paintwork
 - 18.1.2.4 Colour codes
 - 18.1.2.5 Touching up minor paintwork damage
 - 18.1.2.6 Cleaning the exterior
 - 18.1.2.7 Rustproofing
 - 18.1.2.8 Automatic car wash
 - 18.1.2.9 Cleaning exterior plastic, rubber and trim components
 - 18.1.2.10 Cleaning wheel rims
 - 18.1.2.11 Handwashing
 - 18.1.2.12 High-pressure washing
 - 18.1.2.13 Polishing and waxing
- 18.2 Wiper blades and washer fluid
 - 18.2.1 Wiper blades and washer fluid
 - 18.2.2 Setting the wiper blades in service position
 - 18.2.3 Topping up washer fluid
 - 18.2.4 Replacing the wiper blade, rear window
 - 18.2.5 Replacing windscreen wiper blades
- 18.3 Bulb replacement
 - 18.3.1 Bulb replacement
 - 18.3.2 Checking trailer lamps
- 18.4 Engine compartment
 - 18.4.1 Topping up washer fluid
 - 18.4.2 Brake fluid – specifications
 - 18.4.3 Opening and closing the bonnet
 - 18.4.4 Engine compartment overview
 - 18.4.5 Coolant
 - 18.4.6 Topping up coolant
 - 18.4.7 Engine oil
 - 18.4.8 Checking and filling with engine oil
 - 18.4.9 Engine oil — specifications
 - 18.4.10 Fuses in engine compartment
- 18.5 Tools and accessories
 - 18.5.1 Jack
 - 18.5.2 Emergency puncture repair kit
 - 18.5.3 First aid kit
 - 18.5.4 Warning triangle
 - 18.5.5 Tool kit
- 18.6 Fuses
 - 18.6.1 Fuses and central electrical units
 - 18.6.2 Replacing a fuse
 - 18.6.3 Fuses under glovebox
 - 18.6.4 Fuses in cargo area
 - 18.6.5 Fuses in engine compartment

- 18.7 Battery
 - 18.7.1 Replacing the battery in the remote control key
 - 18.7.2 Overloading the starter battery
 - 18.7.3 Using jump starting with another battery
 - 18.7.4 Power supply
 - 18.7.5 Recycling the batteries
 - 18.7.6 Symbols on the batteries
 - 18.7.7 Hybrid battery
 - 18.7.8 Starter battery
 - 18.8 Service
 - 18.8.1 Servicing the climate control system
 - 18.8.2 Volvo service programme
 - 18.9 Car status
 - 18.9.1 Car status
 - 18.9.2 Sending car information to a workshop
 - 18.10 Download Center
 - 18.10.1 Download Center
 - 18.10.2 Updating software via Download Centre
 - 18.10.3 Tips in the event of problems with updates via the Download Centre
 - 18.11 Recommended maintenance for camera and radar units
 - 18.12 Brake system maintenance
 - 18.13 Operational disruption
 - 18.14 Data transfer between car and workshop via Wi-Fi
 - 18.15 Raise the car
- 19. Specifications
 - 19.1 Dimensions and weights
 - 19.1.1 Towing capacity and towball load
 - 19.1.2 Dimensions
 - 19.1.3 Weights
 - 19.1.4 Specifications for towbar
 - 19.2 Specifications for engine
 - 19.2.1 Engine specifications
 - 19.2.2 Adverse driving conditions for engine oil
 - 19.2.3 Engine oil — specifications
 - 19.3 Specifications for fluids and lubricants
 - 19.3.1 Topping up washer fluid
 - 19.3.2 Air conditioning — specifications
 - 19.3.3 Brake fluid – specifications
 - 19.3.4 Transmission fluid – specifications
 - 19.3.5 Fuel tank - volume
 - 19.3.6 Adverse driving conditions for engine oil
 - 19.3.7 Engine oil — specifications
 - 19.4 Specifications for wheels and tyres
 - 19.4.1 Approved tyre pressures
 - 19.4.2 Approved wheel and tyre sizes
 - 19.4.3 Minimum permitted tyre load index and speed rating for tyres
 - 19.5 Type designations
 - 19.6 Fuel consumption and CO₂ emissions

1. Owner information

1.1. Owner information

Owner's information is available in several different product formats, both digital and printed. The owner's manual is available in the car's centre display and on the Volvo Cars support site. There is a supplement to the owner's manual available in the glovebox, with specifications and fuse information, among other things. A printed owner's manual can be ordered.

The car's centre display ^[1]

In the centre display, drag down the top view and tap on **Owner's manual**. Available here are options for visual navigation with exterior and interior images of the car. The information is searchable and is also divided into categories.

Volvo Cars support site

More information on your car is available on the Volvo Cars website and support site.

Go to [volvocars.com/intl/support](https://www.volvocars.com/intl/support) [<https://www.volvocars.com/intl/support>] and select your country. The page is available for most markets.

The support site contains contact details to customer support and your nearest Volvo retailer. If your car is equipped with Sensus Navigation, you also have the option to download maps.

Printed information

There is a supplement to the owner's manual ^[1] in the glovebox that contains information on fuses and specifications, as well as a summary of important and practical information.

Depending on equipment level selected, market, etc. additional owner's information may also be available in printed format in the car.

A printed owner's manual and associated supplement can be ordered. Contact a Volvo dealer to order.

Important

The driver is always responsible that the vehicle is driven safely in traffic and that applicable laws and regulations are followed. It is also important that the car is maintained and handled in accordance with Volvo's recommendations in the owner's information.

If there should be a difference between the information in the centre display and the printed information then it is always the printed information that applies.

 **Note**

Changing the language in the centre display may mean that some owner's information is not compliant with national or local laws and regulations. Do not switch to a language that is difficult to understand as this may make it difficult to find your way back through the screen structure.

[1] A complete printed manual is included with the car for markets without owner's manual in the centre display.

1.2. The owner's manual and the environment

The Owner's Manual is printed on paper originating from controlled forests.

The Forest Stewardship Council (FSC)[®] symbol shows that the paper pulp in a printed owner's manual comes from FSC[®]-certified forests or other controlled sources.



1.3. Reading the owner's manual

To help you get to know your new car, read the Owner's Manual before you drive it for the first time.

Reading the owner's manual is a way to become familiar with new functions, get advice on how to handle the car in different situations and learn how to make use of all the car's features. Please pay attention to the safety instructions contained in the owner's manual.

Development work is constantly underway in order to improve our product. Modifications may mean that information, descriptions and illustrations in the owner's manual differ from the equipment in the car. We reserve the right to make modifications without prior notice.

© Volvo Car Corporation

Options/accessories

In addition to standard equipment, the owner's manual also describes options (factory fitted equipment) and certain accessories (retrofitted extra equipment).

All, at the time of publication known, options and accessories are marked with an asterisk: *.

The equipment described in the owner's manual is not available in all cars - they have different equipment depending on adaptations for the needs of different markets and national or local laws and regulations.

The intention of this owner's information is to explain all possible functions, options and accessories included in a Volvo vehicle. It is not intended as an indication or guarantee that all of these features, functions and options are included in every vehicle. Some terminology used may not exactly match terminology used in sales, marketing and advertising materials.

In the event of uncertainty over what is standard or an option/accessory, contact a Volvo dealer.

Special texts

Warning

Warning texts appear if there is a risk of injury.

Important

Important texts appear if there is a risk of damage.

Note

Note texts give advice or tips that facilitate the use of e.g. features and functions.

Decals

The car contains different types of decal which are designed to convey important information in a clear manner. The decals in the car have the following descending degree of importance for the warning/information.

Warning of personal injury

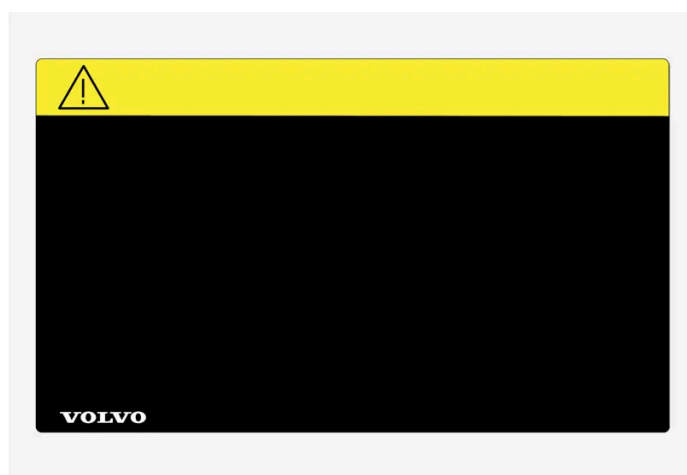

Black ISO symbols on yellow warning field, white text/image on black message field. Used to indicate the presence of danger which, if the warning is ignored, may result in serious personal injury or fatality.

Risk of property damage



White ISO symbols and white text/image on black or blue warning field and message field. Used to indicate the presence of danger which, if the warning is ignored, may result in damage to property.

Information



White ISO symbols and white text/image on black message field.

Note

It is not intended that the decals illustrated in the owner's manual should be exact replicas of those in the car. They are included to show their approximate appearance and location in the car. The information that applies to your particular car is available on the respective decals for your car.

Illustrations and video clips

Illustrations and video clips used in the owner's manual are sometimes schematic and are intended to provide an overall picture or example of a certain function. They may deviate from the car's appearance depending on equipment level and market.

* Option/accessory.

1.4. Owner's manual in centre display

A digital^[1] version of the owner's manual is available in the car's centre display.

The digital owner's manual can be accessed from the top view, and in some cases the contextual owner's manual can also be accessed from the top view.

Note

The digital owner's manual is not available while driving.

Owner's manual

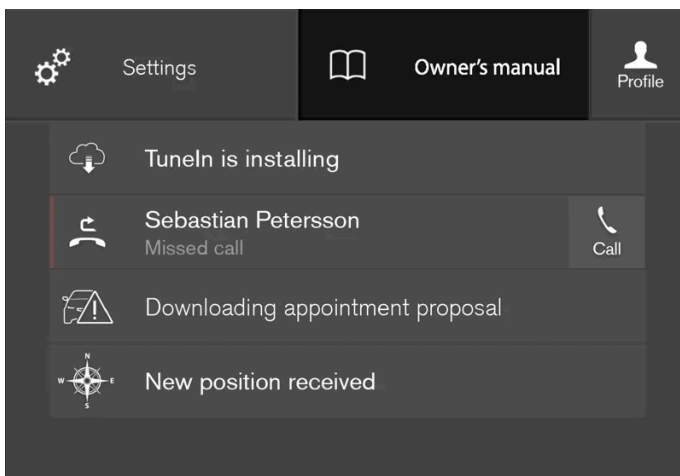

Top view with button for owner's manual.

To open the owner's manual - drag down the top view in the centre display and tap on **Owner's manual**.

The information in the owner's manual can be accessed directly via the owner's manual homepage or its top menu.

Contextual owner's manual

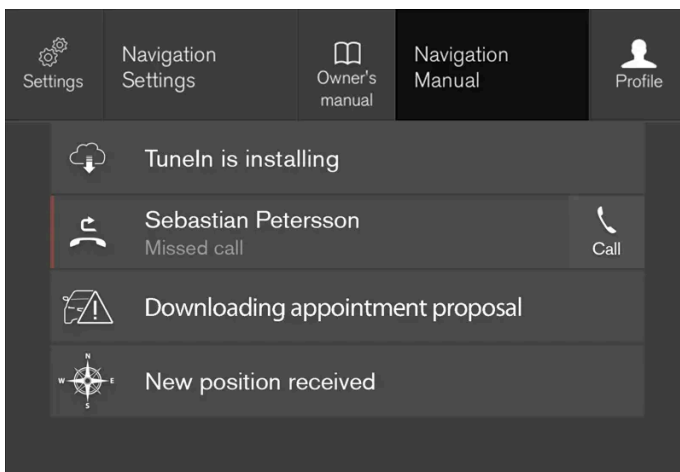

Top view with button for contextual owner's manual.

The contextual owner's manual is a shortcut to an article in the owner's manual that describes the active function shown on the screen. When the contextual owner's manual is available, it is shown to the right of **Owner's manual** in the top view.

Tapping on the contextual owner's manual therefore opens an article in the owner's manual that is related to the content that is shown on the screen. E.g. tap on **Navigation Manual** – an article that is related to navigation opens.

This only applies to some of the apps in the car. For downloaded third party apps, for example, it is not possible to access app-specific articles.

[1] Applies for most markets.

1.5. Navigate in the owner's manual in the centre display

The digital owner's manual can be accessed from the centre display top view in the car. The content is searchable, and the various sections are designed to facilitate navigation.

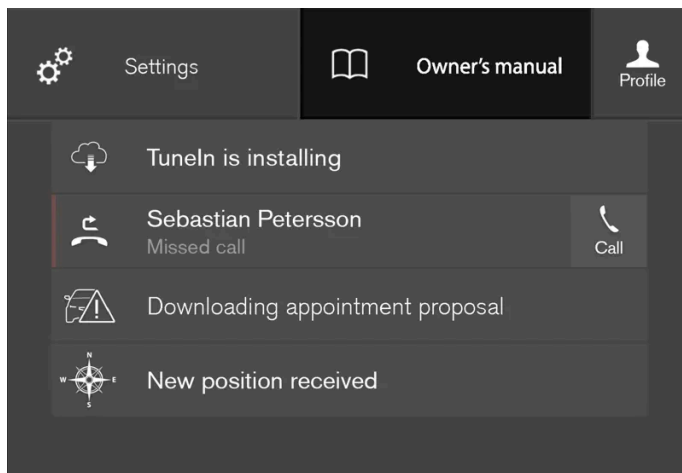

The owner's manual is accessed from the top view.

- 1 To open the owner's manual - drag down the top view in the centre display and tap on **Owner's manual**.

There is a range of different options for finding information in the owner's manual. The options can be accessed from the owner's manual homepage and from the top menu.

Opening the menu in the top menu

- 1 Press ☰ in the upper list in the owner's manual.
 - > A menu with different options for finding information is opened:

Homepage



Tap on the symbol to go back to the start page in the owner's manual.

Categories

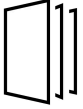

The articles in the owner's manual are structured into main categories and subcategories. The same article can be found in several appropriate categories so that it can be found more easily.

1 Press **Categories**.

➤ The main categories are shown in a list.

2 Tap on a main category ().

➤ A list of subcategories () and articles () is shown.

3 Tap on an article to open it.

To go back, press the back arrow.

Featured articles



Press the symbol to access a page with links to a selection of articles that can be useful to read in order to get to know the more common functions of the car. The articles can also be accessed via categories, but are collected here for faster access. Tap on an article in order to read it in its entirety.

Hotspots for exterior and interior



Exterior and interior overview images of the car. Different parts are designated with hotspots that lead to articles about those parts of the car.



1 Press **Exterior** or **Interior**.

➤ Exterior or interior images are shown with so-called hotspots in place. The hotspot leads to articles about the corresponding part of the car. Swipe horizontally over the screen to browse among the images.

2 Tap on a hotspot.

➤ The title of the article about the area is shown.

3 Tap on the title to open the article.

To go back, press the back arrow.

Favourites



Press the symbol to access the articles saved as favourites. Tap on an article in order to read it in its entirety.

Saving or deleting articles as favourites

Save an article as favourite by pressing ☆ at the top right when an article is open. When an article has been saved as a favourite the star is filled in: ★.

To remove an article as a favourite, press the star again in the current article.

Video



Press the symbol to view brief instruction videos for various functions in the car.

Information



Tap on the symbol to obtain information about which version of the owner's manual is available in the car as well as other useful information.

Using the search function in the top menu

- 1 Tap on **Q** in the top menu of the owner's manual. A keyboard appears in the lower part of the screen.
- 2 Type in a keyword, such as "seatbelt".
- > Suggestions for articles and categories are shown while letters are being entered.
- 3 Tap on the article or category to access it.

1.6. Owner's Manual in mobile devices

The owner's manual is available as a mobile app^[1] from both the App Store and Google Play. The app is adapted for smartphones and tablets. The owner's manual can be accessed from the Volvo On Call app.



The owner's manual can be downloaded as a mobile app from the App Store or Google Play.

The app contains a video along with exterior and interior images where different parts of the car are highlighted with so-called hotspots, which lead to articles about the area in question. The content is searchable, and the various sections are designed to facilitate navigation.

^[1] For certain mobile devices.

2. Your Volvo

2.1. Volvo's areas of innovation

2.1.1. Drive-E - cleaner driving pleasure

Volvo Car Corporation is constantly working on the development of safer and more efficient products and solutions in order to reduce the negative impact on the environment.



Environmental care is one of Volvo Cars' core values and influences all operations. The environmental work is based on the whole life cycle of the car and takes into account the environmental impact it has, from design to scrapping and recycling. Volvo Cars' basic principle is that every new product developed must have less impact on the environment than the product it replaces.

Volvo's environmental management work has resulted in the development of more effective and less polluting drivelines Drive-E. Personal environment is also important to Volvo - the air inside a Volvo is, for example, cleaner than the air outside thanks to the climate control system.

Your Volvo complies with stringent international environmental standards. All Volvo's manufacturing units must be ISO 14001 certified, and this supports a systematic approach to the operation's environmental issues, which leads to continuous improvement with reduced environmental impact. Holding the ISO certificate also means that environmental laws and regulations in force are complied with. Volvo also requires that its partners must also meet these requirements.

Fuel consumption

Since a large part of a car's total environmental impact stems from its use, the emphasis of Volvo Cars' environmental work is on reducing fuel consumption, carbon dioxide emissions and other air pollutants. Volvo cars have competitive fuel consumption in each of their respective classes. Lower fuel consumption generally results in lower emission of the greenhouse gas, carbon dioxide.

Contributing to a better environment

An energy-efficient and economical car can contribute to reduced environmental impact and also involve reduced costs for the owner of the car. As the driver, it is easy to reduce fuel consumption and thereby save money and contribute to a better environment - here is some advice:

- Plan for an effective average speed. Speeds above approx. 80 km/h (approx. 50 mph) and below 50 km/h (approx. 30 mph) lead to increased energy consumption.
- Follow the Service and Warranty Booklet's recommended intervals for service and maintenance of the car.
- Avoid letting the engine idle - switch off the engine when stationary for longer periods. Pay attention to local regulations.
- Plan the journey - a lot of unnecessary stops and uneven speed contribute to increased fuel consumption.
- Use preconditioning – it can improve the range of the hybrid battery and reduce the energy requirement while driving.
- Make it a habit to charge the car from the mains power circuit on a regular basis.

Also remember to always dispose of environmentally hazardous waste, such as batteries and oil, in an environmentally safe manner. Consult a workshop in the event of uncertainty about how this type of waste should be discarded - an authorised Volvo workshop is recommended.

Efficient emission control

Your Volvo is manufactured following the concept "Clean inside and out" – a concept that encompasses a clean interior environment as well as highly efficient emission control. In many cases the exhaust emissions are well below the applicable standards.

Clean air in the passenger compartment

An air filter helps prevent dust and pollen entering the passenger compartment via the air intake.

The Interior Air Quality System (IAQS)* ensures that the incoming air is cleaner than the air in the traffic outside.

The system cleans the air in the passenger compartment from contaminants such as particles, hydrocarbons, nitrous oxides and ground-level ozone. If the outside air is contaminated then the air intake is closed and the air is recirculated. Such a situation may arise in heavy traffic, queues and tunnels for example.

IAQS is a part of the Clean Zone Interior Package (CZIP)*, which also includes a function that allows the fan to start when the car is unlocked with the remote control key.

Interior

The material used in the interior of a Volvo is carefully selected and has been tested in order to be pleasant and comfortable. Some of the details are hand-made, such as the seams of the steering wheel that are sewn by hand. The interior is monitored in order not to emit strong odours or substances that cause discomfort in the event of e.g. high heat and bright light.

Volvo workshops and the environment

Regular maintenance creates the conditions for a long service life and low fuel consumption for your car. In this way you also contribute to a cleaner environment. When Volvo's workshops are entrusted with the service and maintenance of your car it becomes part of Volvo's system. Volvo makes clear demands regarding the way in which workshop premises shall be designed in order to prevent spills and discharges into the environment. The workshop staff have the knowledge and the tools required to guarantee good environmental care.

Recycling

Since Volvo works from a life cycle perspective, it is also important that the car is recycled in an environmentally sound manner. Almost all of the car can be recycled. The last owner of the car is therefore requested to contact a retailer for referral to a certified/approved recycling facility.

* Option/accessory.

2.1.2. IntelliSafe – driver support and safety

IntelliSafe is the Volvo Cars concept for car safety. IntelliSafe comprises a number of systems^[1], whose purpose is to make a car journey safer, to prevent injuries and to protect passengers and other road users.

Warning

The functions are supplementary aids - they cannot handle all situations in all conditions.

The driver always bears responsibility that the vehicle is driven safely and that applicable road traffic rules and regulations are followed.

Support

With the aim of assisting the driver to drive the car in a safer way, IntelliSafe has the following functions.

- Active main beam
- Tunnel detection
- Pilot Assist
- Cross Traffic Alert*
- Blind Spot Information *
- Park Assist*
- Park Assist Pilot*
- Park assist camera *
- Road Sign Information *
- Electronic stability control
- Roll Stability Control
- Speed limiter*
- Cruise control
- Adaptive cruise control *
- Rear Collision Warning
- Driver Alert Control
- All-wheel drive^[2]

Prevention

With the aim of assisting the driver to avoid an accident, IntelliSafe has the following functions.

- City Safety
- Distance Warning *
- Lane assistance
- **Collision Avoidance**

Protection

With the aim of protecting the driver and passengers in certain situations in the event of an accident, IntelliSafe has the following collaborative functions.

- Whiplash Protection System
- Seatbelts with seatbelt tensioners
- Airbags

Note

Read the individual sections on each system in order to fully understand the functions and learn about important warnings.

^[1] Some of the systems are fitted as standard, while others are options. This may vary depending on market, model year and car model.

* Option/accessory.

^[2] All Wheel Drive*

2.1.3. Sensus - online connectivity and entertainment

Sensus makes it possible to use different types of apps and turn the car into a Wi-Fi hotspot.

This is Sensus

SENSUS

Sensus offers an intelligent interface and online connectivity with the digital world. An intuitive navigation structure makes it possible to receive relevant support, information and entertainment when it is necessary, without distracting the driver.

Sensus covers all solutions in the car that are connected with entertainment, online connectivity, navigation* and the user interface between driver and car. It is Sensus that makes communication possible between you, the car and the outside world.

Information when it is needed, where it is needed

The different displays in the car provide information at the right time. The information is shown in different locations based on how it should be prioritised by the driver.



Different types of information are shown in different displays depending on how the information should be prioritised.

Head-up display*

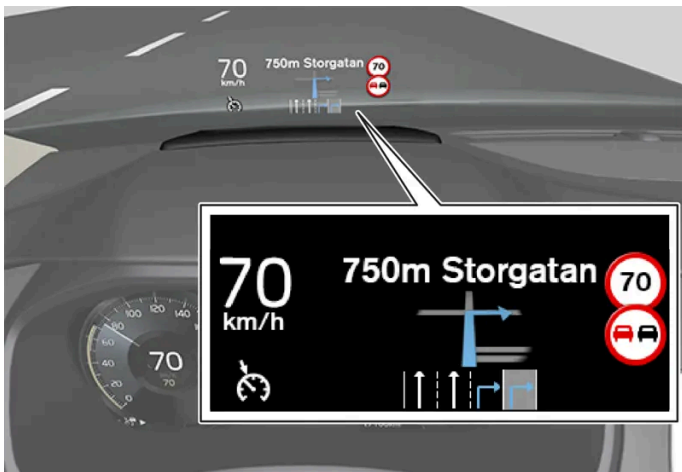

The head-up display shows selected information that the driver should deal with as soon as possible. Such information may, for example, include traffic warnings, speed information and navigation* information. Road Sign Information and incoming phone calls are also shown in the head-up display. The display is operated via the right-hand steering wheel keypad and via the centre display.

Driver display



The driver display shows information on speed and e.g. incoming calls or song tracks being played. The display is operated via the two steering wheel keypads.

Centre display



Many of the main functions of the car are controlled from the centre display, a touch screen which reacts to touch. The number of physical buttons and controls in the car is therefore minimal. The screen can even be operated while wearing gloves.

From here, for example, you can control the climate control system, the entertainment system and seat position*. The information that is shown in the centre display can be acted on by the driver or someone else in the car when the opportunity arises.

Voice recognition system



The voice recognition system can be used without the driver needing to take his/her hands off the steering wheel. The system can understand natural speech. Use voice recognition to, for example, play back a song, call someone, increase the temperature or read out a text message.

* Option/accessory.

2.2. Volvo ID

2.2.1. Volvo ID

Volvo ID is a personal ID that gives access to a wide range of services via a single username and password.

 **Note**

The services available may vary over time and depend on equipment level and market.

One example of a service when Volvo ID is needed is when checking the car on your phone using the Volvo Cars app^[1].

 **Note**

If the username/password for a service (e.g. Volvo On Call) is changed, then it is also changed automatically for other services.

Volvo ID is created from the car, volvoid.eu.volvocars.com/Account [https://volvoid.eu.volvocars.com/Account/] or the Volvo Cars app.

When a Volvo ID is registered in the car, several services will be made available. Several Volvo IDs can be used for the same car and several cars can even be connected to the same Volvo ID.

* Option/accessory.

^[1] If you have Volvo On Call*.

2.2.2. Creating a Volvo ID

It is possible to create a Volvo ID in different ways. If the Volvo ID is created at volvoid.eu.volvocars.com/Account [https://volvoid.eu.volvocars.com/Account/] or with the Volvo Cars app, the Volvo ID must also be registered to the car in order to enable use of the various Volvo ID services.

Create a Volvo ID with the Volvo ID app

- 1 Download the Volvo ID app from **Download Centre** in the centre display's app view.
- 2 Start the app and register a personal email address or mobile number.
- 3 Follow the instructions that are automatically sent to the specified email address/mobile number.
 - A Volvo ID has now been created and automatically registered to the car. Volvo ID services can now be used.

Create a Volvo ID with the Volvo Cars app

- 1 Download the latest version of the Volvo Cars app to the phone^[1].
- 2 Select to create Volvo ID.
- 3 The web page for creating a Volvo ID is shown.
- 4 Enter a personal email address or mobile number.
- 5 Follow the instructions that are automatically sent to the specified email address/mobile number.
 - A Volvo ID has now been created and is ready for use.

Create a Volvo ID via the Volvo Cars website

- 1 Go to volvoid.eu.volvocars.com/Account [https://volvoid.eu.volvocars.com/Account/]. Select to create a Volvo ID.
- 2 Enter a personal email address or mobile number.
- 3 Follow the instructions that are automatically sent to the specified email address/mobile number.
 - A Volvo ID has now been created and is ready for use.

Registering your Volvo ID to the car

If your Volvo ID was created online or using the Volvo Cars app, register it to your car:

- 1 If not done already, download the Volvo ID app from **Download Centre** in the centre display's app view.

 **Note**

To download apps, the car must be connected to the Internet.

- 2 Start the app and enter your Volvo ID.
 - 3 Follow the instructions that are automatically sent to the email address/mobile number linked to your Volvo ID.
- Your Volvo ID is now registered to the car. Volvo ID services can now be used.

^[1] Available to download via e.g. Apple App Store or Google Play.

2.2.3. Problems logging in with Volvo ID

This article describes problems that may arise when logging in with Volvo ID. For example, if you have forgotten your password or your Volvo ID username.

Forgotten your password

To reset your password, follow the instructions below:

In the Volvo Cars app^[1]

- 1 Open the Volvo Cars app.
- 2 Select **Log in**.
- 3 Press **Forgotten password?** and follow the instructions.

You can also change your password at volvoid.eu.volvocars.com/Account [<https://volvoid.eu.volvocars.com/Account/>].

Login failure after creation of a new account

Sometimes there may be a delay in the process which can result in an account not being available directly after it has been created. Try again after 24 hours and if the problem remains, contact your local Volvo dealer or Volvo Cars customer service for further assistance.

What is my Volvo ID (username)?

If the Volvo ID is connected to the car, you can also access the username in the Volvo ID app, which can be found in application view in the centre display. Your Volvo ID is identical to the registered email address/mobile number.

Unlock your Volvo ID

Your account will be locked after 5 failed attempts to log in to the Volvo Cars app^[1]. You can easily unlock the account by clicking on **Forgotten password?** in the login screen.

Change of email address

If you change your email address and still have access to the old address you can log in with the old details and change your username yourself. If you no longer have access to the old address then you should create a new Volvo ID using the new address.

Login failure after changing Volvo ID (username)

Check that you have received a confirmation message in which your new username is confirmed. Once this has been done, you should be able to login with the new user name. If you did not receive the confirmation e-mail, your old username is probably still in place. Log in and try to change the username again.

Login failure after changed password

Try to login with your previous password. If this is not successful, try to reset the password.

Account registered to a different market

An account is registered to a specific market and cannot be moved to a different market. To be able to re-use the same email address/mobile number, we advise you to first delete your account for the old market and then create a new account for the new market.

E-mail failure

If you entered an email address as username and did not receive a confirmation email after registering, make sure that you entered a valid email address and that the email was not stopped by a spam filter. Try to register your e-mail address again.

More help

If you have not found a solution to a problem relating to Volvo ID and need more help, contact your local Volvo dealer or Volvo Cars Customer Service.

Note

Services available on volvocars.com and for Volvo On Call* may vary depending on market.

^[1] Applies to certain markets.

* Option/accessory.

2.3. Type approvals and licences

2.3.1. License agreement for driver display

A license is an agreement for the right to operate a certain activity or the right to use someone else's entitlement according to the terms and conditions in the agreement. The following text is Volvo's agreement with the manufacturer or developer.

Boost Software License 1.0

Permission is hereby granted, free of charge, to any person or organization obtaining a copy of the software and accompanying documentation covered by this license (the "Software") to use, reproduce, display, distribute, execute, and transmit the Software, and to prepare derivative works of the Software, and to permit third-parties to whom the Software is furnished to do so, all subject to the following: The copyright notices in the Software and this entire statement, including the above license grant, this restriction and the following disclaimer, must be included in all copies of the Software, in whole or in part, and all derivative works of the Software, unless such copies or derivative works are solely in the form of machine-executable object code generated by a source language processor.

THE SOFTWARE IS PROVIDED "AS IS", WITHOUT WARRANTY OF ANY KIND, EXPRESS OR IMPLIED, INCLUDING BUT NOT LIMITED TO THE WARRANTIES OF MERCHANTABILITY, FITNESS FOR A PARTICULAR PURPOSE, TITLE AND NON-INFRINGEMENT. IN NO EVENT SHALL THE COPYRIGHT HOLDERS OR ANYONE DISTRIBUTING THE SOFTWARE BE LIABLE FOR ANY DAMAGES OR OTHER LIABILITY, WHETHER IN CONTRACT, TORT OR OTHERWISE, ARISING FROM, OUT OF OR IN CONNECTION WITH THE SOFTWARE OR THE USE OR OTHER DEALINGS IN THE SOFTWARE.

BSD 4-clause "Original" or "Old" License

Copyright (c) 1982, 1986, 1990, 1991, 1993 The Regents of the University of California. All rights reserved.

Redistribution and use in source and binary forms, with or without modification, are permitted provided that the following conditions are met:

1. Redistributions of source code must retain the above copyright notice, this list of conditions and the following disclaimer.
2. Redistributions in binary form must reproduce the above copyright notice, this list of conditions and the following disclaimer in the documentation and/or other materials provided with the distribution.
3. All advertising materials mentioning features or use of this software must display the following acknowledgement: This product includes software developed by the University of California, Berkeley and its contributors.
4. Neither the name of the University nor the names of its contributors may be used to endorse or promote products derived from this software without specific prior written permission.

THIS SOFTWARE IS PROVIDED BY THE REGENTS AND CONTRIBUTORS "AS IS" AND ANY EXPRESS OR IMPLIED WARRANTIES, INCLUDING, BUT NOT LIMITED TO, THE IMPLIED WARRANTIES OF MERCHANTABILITY AND FITNESS FOR A PARTICULAR PURPOSE ARE DISCLAIMED. IN NO EVENT SHALL THE REGENTS OR CONTRIBUTORS BE LIABLE FOR ANY DIRECT, INDIRECT, INCIDENTAL, SPECIAL, EXEMPLARY, OR CONSEQUENTIAL DAMAGES (INCLUDING, BUT NOT LIMITED TO, PROCUREMENT OF SUBSTITUTE GOODS OR SERVICES; LOSS OF USE, DATA, OR PROFITS; OR BUSINESS INTERRUPTION) HOWEVER CAUSED AND ON ANY THEORY OF LIABILITY, WHETHER IN CONTRACT, STRICT LIABILITY, OR TORT (INCLUDING NEGLIGENCE OR OTHERWISE) ARISING IN ANY WAY OUT OF THE USE OF THIS SOFTWARE, EVEN IF ADVISED OF THE POSSIBILITY OF SUCH DAMAGE.

BSD 3-clause "New" or "Revised" License

Copyright (c) 2011-2014, Yann Collet.

Redistribution and use in source and binary forms, with or without modification, are permitted provided that the following conditions are met:

The content of this manual represents the status of the user manual at the time of printing and may not be completely valid in future instances. For more information, refer to the first page for the complete disclaimer note.

1. Redistributions of source code must retain the above copyright notice, this list of conditions and the following disclaimer.
2. Redistributions in binary form must reproduce the above copyright notice, this list of conditions and the following disclaimer in the documentation and/or other materials provided with the distribution.
3. Neither the name of the organisation nor the names of its contributors may be used to endorse or promote products derive from this software without specific prior written permission.

THIS SOFTWARE IS PROVIDED BY THE COPYRIGHT HOLDERS AND CONTRIBUTORS "AS IS" AND ANY EXPRESS OR IMPLIED WARRANTIES, INCLUDING, BUT NOT LIMITED TO, THE IMPLIED WARRANTIES OF MERCHANTABILITY AND FITNESS FOR A PARTICULAR PURPOSE ARE DISCLAIMED. IN NO EVENT SHALL THE COPYRIGHT HOLDER OR CONTRIBUTORS BE LIABLE FOR ANY DIRECT, INDIRECT, INCIDENTAL, SPECIAL, EXEMPLARY, OR CONSEQUENTIAL DAMAGES (INCLUDING, BUT NOT LIMITED TO, PROCUREMENT OF SUBSTITUTE GOODS OR SERVICES; LOSS OF USE, DATA, OR PROFITS; OR BUSINESS INTERRUPTION) HOWEVER CAUSED AND ON ANY THEORY OF LIABILITY, WHETHER IN CONTRACT, STRICT LIABILITY, OR TORT (INCLUDING NEGLIGENCE OR OTHERWISE) ARISING IN ANY WAY OUT OF THE USE OF THIS SOFTWARE, EVEN IF ADVISED OF THE POSSIBILITY OF SUCH DAMAGE.

BSD 2-clause "Simplified" license

Copyright (c) <YEAR>, <OWNER> All rights reserved.

Redistribution and use in source and binary forms, with or without modification, are permitted provided that the following conditions are met:

1. Redistributions of source code must retain the above copyright notice, this list of conditions and the following disclaimer.
2. Redistributions in binary form must reproduce the above copyright notice, this list of conditions and the following disclaimer in the documentation and/or other materials provided with the distribution.

THIS SOFTWARE IS PROVIDED BY THE COPYRIGHT HOLDERS AND CONTRIBUTORS "AS IS" AND ANY EXPRESS OR IMPLIED WARRANTIES, INCLUDING, BUT NOT LIMITED TO, THE IMPLIED WARRANTIES OF MERCHANTABILITY AND FITNESS FOR A PARTICULAR PURPOSE ARE DISCLAIMED. IN NO EVENT SHALL THE COPYRIGHT OWNER OR CONTRIBUTORS BE LIABLE FOR ANY DIRECT, INDIRECT, INCIDENTAL, SPECIAL, EXEMPLARY, OR CONSEQUENTIAL DAMAGES (INCLUDING, BUT NOT LIMITED TO, PROCUREMENT OF SUBSTITUTE GOODS OR SERVICES; LOSS OF USE, DATA, OR PROFITS; OR BUSINESS INTERRUPTION) HOWEVER CAUSED AND ON ANY THEORY OF LIABILITY, WHETHER IN CONTRACT, STRICT LIABILITY, OR TORT (INCLUDING NEGLIGENCE OR OTHERWISE) ARISING IN ANY WAY OUT OF THE USE OF THIS SOFTWARE, EVEN IF ADVISED OF THE POSSIBILITY OF SUCH DAMAGE.

The views and conclusions contained in the software and documentation are those of the authors and should not be interpreted as representing official policies, either expressed or implied, of the FreeBSD Project.

FreeType Project License

1. 1 Copyright 1996-1999 by David Turner, Robert Wilhelm, and Werner Lemberg Introduction The FreeType Project is distributed in several archive packages; some of them may contain, in addition to the FreeType font engine, various tools and contributions which rely on, or relate to, the FreeType Project. This license applies to all files found in such packages, and which do not fall under their own explicit license. The license affects thus the FreeType font engine, the test programs, documentation and makefiles, at the very least. This license was inspired by the BSD, Artistic, and IJG (Independent JPEG Group) licenses, which all encourage inclusion and use of free software in commercial and freeware products alike. As a consequence, its main points are that:
 - o We don't promise that this software works. However, we are interested in any kind of bug reports. ('as is' distribution)
 - o You can use this software for whatever you want, in parts or full form, without having to pay us. ('royalty-free' usage)
 - o You may not pretend that you wrote this software. If you use it, or only parts of it, in a program, you must acknowledge somewhere in your documentation that you've used the FreeType code. ('credits')We specifically permit and encourage the inclusion of this software, with or without modifications, in commercial

The content of this manual represents the status of the user manual at the time of printing and may not be completely valid in future instances. For more information, refer to the first page for the complete disclaimer note.

products, provided that all warranty or liability claims are assumed by the product vendor. Legal Terms 0. Definitions Throughout this license, the terms 'package', 'FreeType Project', and 'FreeType archive' refer to the set of files originally distributed by the authors (David Turner, Robert Wilhelm, and Werner Lemberg) as the 'FreeType project', be they named as alpha, beta or final release. 'You' refers to the licensee, or person using the project, where 'using' is a generic term including compiling the project's source code as well as linking it to form a 'program' or 'executable'. This program is referred to as 'a program using the FreeType engine'. This license applies to all files distributed in the original FreeType archive, including all source code, binaries and documentation, unless otherwise stated in the file in its original, unmodified form as distributed in the original archive. If you are unsure whether or not a particular file is covered by this license, you must contact us to verify this. The FreeType project is copyright (C) 1996-1999 by David Turner, Robert Wilhelm, and Werner Lemberg. All rights reserved except as specified below. 1. No Warranty THE FREETYPE ARCHIVE IS PROVIDED 'AS IS' WITHOUT WARRANTY OF ANY KIND, EITHER EXPRESSED OR IMPLIED, INCLUDING, BUT NOT LIMITED TO, WARRANTIES OF MERCHANTABILITY AND FITNESS FOR A PARTICULAR PURPOSE. IN NO EVENT WILL ANY OF THE AUTHORS OR COPYRIGHT HOLDERS BE LIABLE FOR ANY DAMAGES CAUSED BY THE USE OR THE INABILITY TO USE, OF THE FREETYPE PROJECT. As you have not signed this license, you are not required to accept it. However, as the FreeType project is copyrighted material, only this license, or another one contracted with the authors, grants you the right to use, distribute, and modify it. Therefore, by using, distributing, or modifying the FreeType project, you indicate that you understand and accept all the terms of this license.

2. Redistribution Redistribution and use in source and binary forms, with or without modification, are permitted provided that the following conditions are met:
 - o Redistribution of source code must retain this license file ('licence.txt') unaltered; any additions, deletions or changes to the original files must be clearly indicated in accompanying documentation. The copyright notices of the unaltered, original files must be preserved in all copies of source files.
 - o Redistribution in binary form must provide a disclaimer that states that the software is based in part of the work of the FreeType Team, in the distribution documentation. We also encourage you to put an URL to the FreeType web page in your documentation, though this isn't mandatory. These conditions apply to any software derived from or based on the FreeType code, not just the unmodified files. If you use our work, you must acknowledge us. However, no fee need be paid to us.
3. Advertising The names of FreeType's authors and contributors may not be used to endorse or promote products derived from this software without specific prior written permission. We suggest, but do not require, that you use one or more of the following phrases to refer to this software in your documentation or advertising materials: 'FreeType Project', 'FreeType Engine', 'FreeType library', or 'FreeType Distribution'.
4. Contacts There are two mailing lists related to FreeType:
 - o freetype@freetype.org Discusses general use and applications of FreeType, as well as future and wanted additions to the library and distribution. If you are looking for support, start in this list if you haven't found anything to help you in the documentation.
 - o devel@freetype.org Discusses bugs, as well as engine internals, design issues, specific licenses, porting, etc.
 - o <http://www.freetype.org> Holds the current FreeType web page, which will allow you to download our latest development version and read online documentation. You can also contact us individually at: David Turner <david.turner@freetype.org> Robert Wilhelm <robert.wilhelm@freetype.org> Werner Lemberg <werner.lemberg@freetype.org>

Libpng License

This copy of the libpng notices is provided for your convenience. In case of any discrepancy between this copy and the notices in the file png.h that is included in the libpng distribution, the latter shall prevail.

COPYRIGHT NOTICE, DISCLAIMER, and LICENSE:

If you modify libpng you may insert additional notices immediately following this sentence.

libpng versions 1.0.7, July 1, 2000, through 1.0.13, April 15, 2002, are Copyright (c) 2000-2002 Glenn Randers-Pehrson and are distributed according to the same disclaimer and license as libpng-1.0.6 with the following individuals added to the list of Contributing Authors

Simon-Pierre Cadieux

Eric S. Raymond

The content of this manual represents the status of the user manual at the time of printing and may not be completely valid in future instances. For more information, refer to the first page for the complete disclaimer note.

Gilles Vollant

and with the following additions to the disclaimer:

There is no warranty against interference with your enjoyment of the library or against infringement. There is no warranty that our efforts or the library will fulfill any of your particular purposes or needs. This library is provided with all faults, and the entire risk of satisfactory quality, performance, accuracy, and effort is with the user.

libpng versions 0.97, January 1998, through 1.0.6, March 20, 2000, are Copyright (c) 1998, 1999 Glenn Randers-Pehrson, and are distributed according to the same disclaimer and license as libpng-0.96, with the following individuals added to the list of Contributing Authors:

Tom Lane

Glenn Randers-Pehrson

Willem van Schaik

libpng versions 0.89, June 1996, through 0.96, May 1997, are Copyright (c) 1996, 1997 Andreas Dilger Distributed according to the same disclaimer and license as libpng-0.88, with the following individuals added to the list of Contributing Authors:

John Bowler

Kevin Bracey

Sam Bushell

Magnus Holmgren

Greg Roelofs

Tom Tanner

libpng versions 0.5, May 1995, through 0.88, January 1996, are Copyright (c) 1995, 1996 Guy Eric Schalnat, Group 42, Inc.

For the purposes of this copyright and license, "Contributing Authors" is defined as the following set of individuals:

Andreas Dilger

Dave Martindale

Guy Eric Schalnat

Paul Schmidt

Tim Wegner

The PNG Reference Library is supplied "AS IS". The Contributing Authors and Group 42, Inc. disclaim all warranties, expressed or implied, including, without limitation, the warranties of merchantability and of fitness for any purpose. The Contributing Authors and Group 42, Inc. assume no liability for direct, indirect, incidental, special, exemplary, or consequential damages, which may result from the use of the PNG Reference Library, even if advised of the possibility of such damage.

Permission is hereby granted to use, copy, modify, and distribute this source code, or portions hereof, for any purpose, without fee, subject to the following restrictions:

1. The origin of this source code must not be misrepresented.
2. Altered versions must be plainly marked as such and must not be misrepresented as being the original source.

3. This Copyright notice may not be removed or altered from any source or altered source distribution.

The Contributing Authors and Group 42, Inc. specifically permit, without fee, and encourage the use of this source code as a component to supporting the PNG file format in commercial products. If you use this source code in a product, acknowledgment is not required but would be appreciated.

A "png_get_copyright" function is available, for convenient use in "about" boxes and the like:

```
printf("%s",png_get_copyright(NULL));
```

Also, the PNG logo (in PNG format, of course) is supplied in the files "pngbar.png" and "pngbar.jpg (88x31) and "pngnow.png" (98x31).

Libpng is OSI Certified Open Source Software. OSI Certified Open Source is a certification mark of the Open Source Initiative.

Glenn Randers-Pehrson randeg@alum.rpi.edu April 15, 2002

MIT License

Copyright (c) <year> <copyright holders>

Permission is hereby granted, free of charge, to any person obtaining a copy of this software and associated documentation files (the "Software"), to deal in the Software without restriction, including without limitation the rights to use, copy, modify, merge, publish, distribute, sublicense, and/or sell copies of the Software, and to permit persons to whom the Software is furnished to do so, subject to the following conditions:

The above copyright notice and this permission notice shall be included in all copies or substantial portions of the Software.

THE SOFTWARE IS PROVIDED "AS IS", WITHOUT WARRANTY OF ANY KIND, EXPRESS OR IMPLIED, INCLUDING BUT NOT LIMITED TO THE WARRANTIES OF MERCHANTABILITY, FITNESS FOR A PARTICULAR PURPOSE AND NONINFRINGEMENT. IN NO EVENT SHALL THE AUTHORS OR COPYRIGHT HOLDERS BE LIABLE FOR ANY CLAIM, DAMAGES OR OTHER LIABILITY, WHETHER IN AN ACTION OF CONTRACT, TORT OR OTHERWISE, ARISING FROM, OUT OF OR IN CONNECTION WITH THE SOFTWARE OR THE USE OR OTHER DEALINGS IN THE SOFTWARE.

zlib License

The zlib/libpng License Copyright (c) <year> <copyright holders>

This software is provided 'as-is', without any express or implied warranty. In no event will the authors be held liable for any damages arising from the use of this software.

Permission is granted to anyone to use this software for any purpose, including commercial applications, and to alter it and redistribute it freely, subject to the following restrictions:

1. The origin of this software must not be misrepresented; you must not claim that you wrote the original software. If you use this software in a product, an acknowledgment in the product documentation would be appreciated but is not required.
2. Altered source versions must be plainly marked as such, and must not be misrepresented as being the original software.
3. This notice may not be removed or altered from any source distribution.

SGI Free Software B License Version 2.0.

SGI FREE SOFTWARE LICENSE B (Version 2.0, Sept. 18, 2008)

Copyright (C) [dates of first publication] Silicon Graphics, Inc. All Rights Reserved. Permission is hereby granted, free of charge, to any person obtaining a copy of this software and associated documentation files (the "Software"), to deal in the Software without restriction, including without limitation the rights to use, copy, modify, merge, publish, distribute, sublicense, and/or sell copies of the Software, and to permit persons to whom the Software is furnished to do so, subject to the following conditions: The above copyright notice including the dates of first publication and either this permission notice or a reference to <http://oss.sgi.com/projects/FreeB/> shall be included in all copies or substantial portions of the Software.

THE SOFTWARE IS PROVIDED "AS IS", WITHOUT WARRANTY OF ANY KIND, EXPRESS OR IMPLIED, INCLUDING BUT NOT LIMITED TO THE WARRANTIES OF MERCHANTABILITY, FITNESS FOR A PARTICULAR PURPOSE AND NONINFRINGEMENT. IN NO EVENT SHALL SILICON GRAPHICS, INC. BE LIABLE FOR ANY CLAIM, DAMAGES OR OTHER LIABILITY, WHETHER IN AN ACTION OF CONTRACT, TORT OR OTHERWISE, ARISING FROM, OUT OF OR IN CONNECTION WITH THE SOFTWARE OR THE USE OR OTHER DEALINGS IN THE SOFTWARE.

Except as contained in this notice, the name of Silicon Graphics, Inc. shall not be used in advertising or otherwise to promote the sale, use or other dealings in this Software without prior written authorization from Silicon Graphics, Inc.

2.3.2. Type approval for HomeLink® * [1]

The type approval for HomeLink® can be read below.

Country/Area	Type approval
USA and Canada	This device complies with FCC rules part 15 and Industry Canada RSS-210. Operation is subject to the following two conditions: (1) This device may not cause harmful interference, and (2) This device must accept any interference that may be received including interference that may cause undesired operation.
Europe	Gentex Corporation hereby declares that HomeLink® Model UAHL5 complies with the Radio equipment directive 2014/53/EU. Wavelength within which the radio equipment functions: <ul style="list-style-type: none"> • 433.05MHz-434.79MHz <10mW E.R.P. • 868.00MHz-868.60MHz <25mW E.R.P. • 868.70MHz-868.20MHz <25mW E.R.P. • 869.40MHz-869.65MHz <25mW E.R.P. • 869.70MHz-870.00MHz <25mW E.R.P. Certificate holder address: Gentex Corporation, 600 North Centennial Street, Zeeland MI 49464, USA

* Option/accessory.

[1] Applies to certain markets.

2.3.3. License agreement for audio and media

A license is an agreement for the right to operate a certain activity or the right to use someone else's entitlement according to the terms and conditions in the agreement. The following texts are Volvo's agreements with manufacturers/developers.

Bowers & Wilkins



Bowers & Wilkins and B&W are trademarks of the B&W Group Ltd. Nautilus is a trademark of B&W Group Ltd. Continuum is a trademark of Bowers & Wilkins. Trademarks of Bowers & Wilkins applicable in selected markets.

Dirac Unison®



Dirac Unison co-optimises the loudspeakers in frequency, time and space for the best possible bass integration and clarity. It enables a faithful reproduction of the acoustic characteristics of specific performance venues. Using advanced algorithms, Dirac Unison controls all loudspeakers digitally based on acoustic high-precision measurements. Like a conductor of an orchestra, it guarantees that the loudspeakers perform in perfect unison.

DivX®



DivX®, DivX Certified® and associated logotypes are trademarks belonging to DivX, LLC and are used under licence.

This DivX Certified® device can play back DivX® Home Theater video files up to 576p (including .avi, .divx). Download free software on www.divx.com to create, play back and stream digital video.

ABOUT DIVX VIDEO-ON-DEMAND: This DivX Certified® device must be registered in order to play back purchased DivX Video-on-Demand (VOD) films. Get the registration code by locating the DivX VOD section in the device's settings menu. Go to vod.divx.com for more information on how to complete the registration.

Patent numbers

Protected by one or more of the following US patents. 7,295,673; 7,460,668; 7,515,710; 8,656,183; 8,731,369; RE45,052.

Gracenote®



Portions of the content are copyright © of Gracenote or its suppliers.

The content of this manual represents the status of the user manual at the time of printing and may not be completely valid in future instances. For more information, refer to the first page for the complete disclaimer note.

Gracenote, the Gracenote logo and logotype, "Powered by Gracenote" and Gracenote MusicID are either registered trademarks or trademarks of Gracenote, Inc. in the United States and/or other countries.

Gracenote® End User License Agreement

This program or device contains software from Gracenote, Inc. of Emeryville, California, USA ("Gracenote"). The software from Gracenote ("Gracenote software") activates this program to perform disc and/or file identification and obtain music-related information, including name, artist, track and title ("Gracenote data") from online servers or embedded databases (together called "Gracenote servers") and in order to perform other actions. You may only use Gracenote data in accordance with the intended end-user functions for this program or this device.

You agree to only use Gracenote data, Gracenote software and Gracenote servers for your own personal non-commercial use. You agree not to assign, copy, transfer or transmit this Gracenote software or any Gracenote data to any third party. YOU AGREE NOT TO USE OR EXPLOIT GRACENOTE DATA, GRACENOTE SOFTWARE OR GRACENOTE SERVERS, EXCEPT AS EXPRESSLY PERMITTED IN THIS AGREEMENT.

You agree that your non-exclusive right to use Gracenote data, Gracenote software and Gracenote servers will be terminated if you violate these restrictions. If your license is terminated you agree to cease all use of Gracenote data, Gracenote software and Gracenote servers. Gracenote holds exclusive rights to all Gracenote data, all Gracenote software and all Gracenote servers, including all ownership rights. Gracenote will under no circumstances have any obligation to pay you for any information you provide. You agree that Gracenote, Inc. may enforce the company's rights under this agreement against you directly in its own name.

The Gracenote service uses a unique identifier to track enquiries for statistical purposes. The purpose of a randomly assigned numeric identifier is to enable the Gracenote service to count enquiries without knowing anything about who you are. Additional information is available on the web page for Gracenote's privacy policy for the Gracenote service.

The Gracenote software and everything included in Gracenote data are licensed to you "as is". Gracenote provides no undertakings or warranties, express or implied, as to the accuracy of the Gracenote data contained in the Gracenote servers. Gracenote reserves the right to delete data from the Gracenote servers or to change data categories for any reason that Gracenote deems sufficient. No warranty is provided that the Gracenote software or Gracenote servers are fault-free or that the Gracenote software or Gracenote servers will operate without interruption. Gracenote has no obligation to provide you with new, improved or additional data types or categories that Gracenote may provide in the future, and the company reserves the right to discontinue its services at any time.

GRACENOTE DISCLAIMS ALL WARRANTIES, EITHER EXPRESS OR IMPLIED, INCLUDING, BUT NOT LIMITED TO, THE IMPLIED WARRANTIES OF MERCHANTABILITY, FITNESS FOR A PARTICULAR PURPOSE, TITLE AND NON-INFRINGEMENT OF INTELLECTUAL PROPERTY RIGHTS. GRACENOTE DOES NOT GUARANTEE THE RESULTS OBTAINED THROUGH YOUR USE OF THE GRACENOTE SOFTWARE OR A GRACENOTE SERVER. GRACENOTE WILL IN NO EVENT BE LIABLE FOR ANY CONSEQUENTIAL DAMAGE OR FOR ANY LOST PROFITS OR REVENUES.

© Gracenote, Inc. 2009

Sensus software

This software uses parts of sources from clib2 and Prex Embedded Real-time OS - Source (Copyright (c) 1982, 1986, 1991, 1993, 1994), and Quercus Robusta (Copyright (c) 1990, 1993), The Regents of the University of California. All or some portions are derived from material licensed to the University of California by American Telephone and Telegraph Co. or Unix System Laboratories, Inc. and are reproduced herein with the permission of UNIX System Laboratories, Inc. Redistribution and use in source and binary forms, with or without modification, are permitted provided that the following conditions are met: Redistributions of source code must retain the above copyright notice, this list of conditions and the following disclaimer. Redistributions in binary form must reproduce the above copyright notice, this list of conditions and the following disclaimer in the documentation and/or other materials provided with the distribution. Neither the name of the <ORGANIZATION> nor the names of its contributors may be used to endorse or promote products derived from this software without specific prior writ-

The content of this manual represents the status of the user manual at the time of printing and may not be completely valid in future instances. For more information, refer to the first page for the complete disclaimer note.

ten permission. THIS SOFTWARE IS PROVIDED BY THE COPYRIGHT HOLDERS AND CONTRIBUTORS "AS IS" AND ANY EXPRESS OR IMPLIED WARRANTIES, INCLUDING, BUT NOT LIMITED TO, THE IMPLIED WARRANTIES OF MERCHANTABILITY AND FITNESS FOR A PARTICULAR PURPOSE ARE DISCLAIMED. IN NO EVENT SHALL THE COPYRIGHT OWNER OR CONTRIBUTORS BE LIABLE FOR ANY DIRECT, INDIRECT, INCIDENTAL, SPECIAL, EXEMPLARY, OR CONSEQUENTIAL DAMAGES (INCLUDING, BUT NOT LIMITED TO, PROCUREMENT OF SUBSTITUTE GOODS OR SERVICES; LOSS OF USE, DATA, OR PROFITS; OR BUSINESS INTERRUPTION) HOWEVER CAUSED AND ON ANY THEORY OF LIABILITY, WHETHER IN CONTRACT, STRICT LIABILITY, OR TORT (INCLUDING NEGLIGENCE OR OTHERWISE) ARISING IN ANY WAY OUT OF THE USE OF THIS SOFTWARE, EVEN IF ADVISED OF THE POSSIBILITY OF SUCH DAMAGE.

This software is based in part on the work of the Independent JPEG Group.

This software uses parts of sources from "libtess". The Original Code is: OpenGL Sample Implementation, Version 1.2.1, released January 26, 2000, developed by Silicon Graphics, Inc. The Original Code is Copyright (c) 1991-2000 Silicon Graphics, Inc. Copyright in any portions created by third parties is as indicated elsewhere herein. All Rights Reserved. Copyright (C) [1991-2000] Silicon Graphics, Inc. All Rights Reserved. Permission is hereby granted, free of charge, to any person obtaining a copy of this software and associated documentation files (the "Software"), to deal in the Software without restriction, including without limitation the rights to use, copy, modify, merge, publish, distribute, sublicense, and/or sell copies of the Software, and to permit persons to whom the Software is furnished to do so, subject to the following conditions: The above copyright notice including the dates of first publication and either this permission notice or a reference to <http://oss.sgi.com/projects/FreeB/> shall be included in all copies or substantial portions of the Software. THE SOFTWARE IS PROVIDED "AS IS", WITHOUT WARRANTY OF ANY KIND, EXPRESS OR IMPLIED, INCLUDING BUT NOT LIMITED TO THE WARRANTIES OF MERCHANTABILITY, FITNESS FOR A PARTICULAR PURPOSE AND NONINFRINGEMENT. IN NO EVENT SHALL SILICON GRAPHICS, INC. BE LIABLE FOR ANY CLAIM, DAMAGES OR OTHER LIABILITY, WHETHER IN AN ACTION OF CONTRACT, TORT OR OTHERWISE, ARISING FROM, OUT OF OR IN CONNECTION WITH THE SOFTWARE OR THE USE OR OTHER DEALINGS IN THE SOFTWARE. Except as contained in this notice, the name of Silicon Graphics, Inc. shall not be used in advertising or otherwise to promote the sale, use or other dealings in this Software without prior written authorization from Silicon Graphics, Inc.

This software is based in parts on the work of the FreeType Team.

This software uses parts of SSLeay Library: Copyright (C) 1995-1998 Eric Young (eay@cryptsoft.com). All rights reserved

Linux software

This product contains software licensed under GNU General Public License (GPL) or GNU Lesser General Public License (LGPL), etc.

You have the right of acquisition, modification, and distribution of the source code of the GPL/LGPL software.

You may download Source Code from the following website at no charge: http://www.embedded-carmultimedia.jp/linux/oss/download/TVM_8351_013

The website provides the Source Code "As Is" and without warranty of any kind.

By downloading Source Code, you expressly assume all risk and liability associated with downloading and using the Source Code and complying with the user agreements that accompany each Source Code.

Please note that we cannot respond to any inquiries regarding the source code.

camellia:1.2.0

Copyright (c) 2006, 2007

NTT (Nippon Telegraph and Telephone Corporation). All rights reserved.

The content of this manual represents the status of the user manual at the time of printing and may not be completely valid in future instances. For more information, refer to the first page for the complete disclaimer note.

Redistribution and use in source and binary forms, with or without modification, are permitted provided that the following conditions are met:

1. Redistributions of source code must retain the above copyright notice, this list of conditions and the following disclaimer as the first lines of this file unmodified.
2. Redistributions in binary form must reproduce the above copyright notice, this list of conditions and the following disclaimer in the documentation and/or other materials provided with the distribution.

THIS SOFTWARE IS PROVIDED BY NTT "AS IS" AND ANY EXPRESS OR IMPLIED WARRANTIES, INCLUDING, BUT NOT LIMITED TO, THE IMPLIED WARRANTIES OF MERCHANTABILITY AND FITNESS FOR A PARTICULAR PURPOSE ARE DISCLAIMED. IN NO EVENT SHALL NTT BE LIABLE FOR ANY DIRECT, INDIRECT, INCIDENTAL, SPECIAL, EXEMPLARY, OR CONSEQUENTIAL DAMAGES (INCLUDING, BUT NOT LIMITED TO, PROCUREMENT OF SUBSTITUTE GOODS OR SERVICES; LOSS OF USE, DATA, OR PROFITS; OR BUSINESS INTERRUPTION) HOWEVER CAUSED AND ON ANY THEORY OF LIABILITY, WHETHER IN CONTRACT, STRICT LIABILITY, OR TORT (INCLUDING NEGLIGENCE OR OTHERWISE) ARISING IN ANY WAY OUT OF THE USE OF THIS SOFTWARE, EVEN IF ADVISED OF THE POSSIBILITY OF SUCH DAMAGE.

Unicode: 5.1.0

COPYRIGHT AND PERMISSION NOTICE



Copyright c 1991-2013 Unicode, Inc. All rights reserved. Distributed under the Terms of Use in <http://www.unicode.org/copyright.html>.



Permission is hereby granted, free of charge, to any person obtaining a copy of the Unicode data files and any associated documentation (the "Data Files") or Unicode software and any associated documentation (the "Software") to deal in the Data Files or Software without restriction, including without limitation the rights to use, copy, modify, merge, publish, distribute, and/or sell copies of the Data Files or Software, and to permit persons to whom the Data Files or Software are furnished to do so, provided that (a) the above copyright notice(s) and this permission notice appear with all copies of the Data Files or Software, (b) both the above copyright notice(s) and this permission notice appear in associated documentation, and (c) there is clear notice in each modified Data File or in the Software as well as in the documentation associated with the Data File(s) or Software that the data or software has been modified.

THE DATA FILES AND SOFTWARE ARE PROVIDED "AS IS", WITHOUT WARRANTY OF ANY KIND, EXPRESS OR IMPLIED, INCLUDING BUT NOT LIMITED TO THE WARRANTIES OF MERCHANTABILITY, FITNESS FOR A PARTICULAR PURPOSE AND NONINFRINGEMENT OF THIRD PARTY RIGHTS. IN NO EVENT SHALL THE COPYRIGHT HOLDER OR HOLDERS INCLUDED IN THIS NOTICE BE LIABLE FOR ANY CLAIM, OR ANY SPECIAL INDIRECT OR CONSEQUENTIAL DAMAGES, OR ANY DAMAGES WHATSOEVER RESULTING FROM LOSS OF USE, DATA OR PROFITS, WHETHER IN AN ACTION OF CONTRACT, NEGLIGENCE OR OTHER TORTIOUS ACTION, ARISING OUT OF OR IN CONNECTION WITH THE USE OR PERFORMANCE OF THE DATA FILES OR SOFTWARE.

Except as contained in this notice, the name of a copyright holder shall not be used in advertising or otherwise to promote the sale, use or other dealings in these Data Files or Software without prior written authorization of the copyright holder.

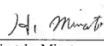
Declaration of Conformity

 MITSUBISHI ELECTRIC CORPORATION SANDA WORKS <small>2-3-33, Miwa, Sanda-City, Hyogo 669-1513, Japan Phone: +81-79-559-3652</small>	
DECLARATION of CONFORMITY For	
	
Product: Audio Navigation Unit Model: NR-0V	
Supplied by Mitsubishi Electric Corporation Sanda Works 2-3-33, Miwa, Sanda-city, Hyogo, 669-1513, Japan	Technical File held by Mitsubishi Electric Corporation Sanda Works 2-3-33, Miwa, Sanda-city, Hyogo, 669-1513, Japan
R&TTE Directive (Safety) RE Directive (EMC) RE Directive (Spectrum)	Standard used for comply EN 60950-1: 2006 + Amd.11: 2009 + Amd.1: 2010 + Amd.12: 2011 + Amd.2: 2013 EN 62479: 2011 EN 301 489-1 V2.1.1: 2017-02 EN 301 489-17 V3.3.1: 2017-02 EN 300 328 V2.2.1: 2016-11 EN 303 345 V1.1.7: 2017-03(Final Draft)
Means of Conformity We declare under our sole responsibility that the Product (s) is conformity with the essential requirements and other relevant requirements of the Radio Equipment (RE) Directive (2014/53/EU).	
Date of issue: May 30, 2017	
Signature of Responsible Person:	 Hirotaka Minato Senior Manager Design B Car Multimedia Manufacturing-A Dept. MITSUBISHI ELECTRIC CORPORATION SANDA WORKS Minato.Hirotaka@ap.MitsubishiElectric.co.jp

Country/Area	
Brazil:	 Este equipamento opera em caráter secundário isto e, não tem direito a proteção contra interferência prejudicial, mesmo tipo, e não pode causar interferência a sistemas operando em caráter primário. Para consultas, visite: www.anatel.gov.br
The United Arab Emirates:	 TRA REGISTERED No. EP013275/14 DEALER No. DA008122/12
Kazakhstan:	 Model name: NR 0V Manufacturer: Mitsubishi Electric Corporation Exporting country: Japan

VC-1:

THIS PRODUCT IS LICENSED UNDER THE VC-1 PATENT PORTFOLIO LICENSE FOR THE PERSONAL AND NON-COMMERCIAL USE OF A CONSUMER TO (i) ENCODE VIDEO IN COMPLIANCE WITH THE VC-1 STANDARD (“VC-1 VIDEO”) AND/OR (ii) DECODE VC-1 VIDEO THAT WAS ENCODED BY A CONSUMER ENGAGED IN A PERSONAL AND NON-COMMERCIAL ACTIVITY AND/OR WAS OBTAINED FROM A VIDEO PROVIDER LICENSED TO PROVIDE VC-1 VIDEO. NO LICENSE IS GRANTED OR SHALL BE IMPLIED FOR ANY OTHER USE. ADDITIONAL INFORMATION MAY BE OBTAINED FROM MPEG LA, L.L.C. SEE [HTTP://WWW.MPEGLA.COM](http://www.mpegla.com)

MPEG-4 VISUAL:

USE OF THE PRODUCT IN ANY MANNER THAT COMPLIES WITH THE MPEG-4 VISUAL STANDARD IS PROHIBITED, EXCEPT FOR USE BY A CONSUMER ENGAGING IN PERSONAL AND NON-COMMERCIAL ACTIVITIES.

2.3.4. Type approval Radio Equipment Directive

Radio Equipment Directive 2014/53/EU

[CE_DECL_Telestart_EN_DE](#)

[Declaration of Conformity \(ALCOGUARD\) 22 September 2017](#)

[Declaration of Conformity \(DY-1VW0F-T\)](#)

[Declaration of Conformity \(TU-6\)](#)

[Declaration of Conformity_UAHL5_English](#)

[DoC \(Declaration of Conformity\) for NR-0V](#)

[DoC_RED2014_RS4 - Hella radar](#)

[DoC-RED-L2C0054TR](#)

[DoC-RED-L2C0055TR](#)

[DoC-RED-V03-134TRX](#)

[DoC_Volvo_Ref_31438104_NB1948_ZS170654004021_signed](#)

[DoC_Volvo_Ref_31472201_NB1948_ZS170654004023_signed](#)

[DoC_Volvo_Ref_31483411_NB1948_ZS170654004010_signed](#)

[DoC_Volvo_Ref_31483412_NB1948_ZS170654004022_signed](#)

[DoC_Volvo_Ref_31483416_NB1948_ZS170654004011_signed](#)

[EU-Konformitätserklärung_L538_RHS_V3.0](#)

[HUF8423_EU](#)

[HUF8432_EU](#)

Applies from and including 2020

[NR-0V_002 IHU 3.2 EU Declaration of Conformity \[https://az685612.vo.msecnd.net/pdfs/2020/NR-0V_002_IHU_3.2_Melco_EU_Declaration_of_Conformity.pdf\]](https://az685612.vo.msecnd.net/pdfs/2020/NR-0V_002_IHU_3.2_Melco_EU_Declaration_of_Conformity.pdf)

[30761717 Master 3 Declaration of Conformity \[https://az685612.vo.msecnd.net/pdfs/certificates/RED-Master3-DoC.pdf\]](https://az685612.vo.msecnd.net/pdfs/certificates/RED-Master3-DoC.pdf)

[AMFM Declaration of Conformity \[https://az685612.vo.msecnd.net/pdfs/certificates/DoC_AMFM.pdf\]](https://az685612.vo.msecnd.net/pdfs/certificates/DoC_AMFM.pdf)

[APN IAM21 Declaration of Conformity \[https://az685612.vo.msecnd.net/pdfs/certificates/APN_IAM21_DoC_20171010.pdf\]](https://az685612.vo.msecnd.net/pdfs/certificates/APN_IAM21_DoC_20171010.pdf)

[AV9257382 F12 EU Declaration of Conformity \[https://az685612.vo.msecnd.net/pdfs/certificates/EU_Konformitaetserklaerung_F12_V20sign.pdf\]](https://az685612.vo.msecnd.net/pdfs/certificates/EU_Konformitaetserklaerung_F12_V20sign.pdf)

[DAB tuner CQ-0VE MITSUBISHI Declaration of Conformity \[https://az685612.vo.msecnd.net/pdfs/certificates/2017-06-12_Declaration_of_ConformityCQ-0VE_MITSUBISHI.pdf\]](https://az685612.vo.msecnd.net/pdfs/certificates/2017-06-12_Declaration_of_ConformityCQ-0VE_MITSUBISHI.pdf)

[ED9253993 MCV EU Declaration of Conformity \[https://az685612.vo.msecnd.net/pdfs/certificates/EU-Konformit--tserkl--rung_MCV_V4_0_En_De.pdf\]](https://az685612.vo.msecnd.net/pdfs/certificates/EU-Konformit--tserkl--rung_MCV_V4_0_En_De.pdf)

[FMDAB Declaration of Conformity \[https://az685612.vo.msecnd.net/pdfs/certificates/DoC_FMDAB.pdf\]](https://az685612.vo.msecnd.net/pdfs/certificates/DoC_FMDAB.pdf)

[GJ32-18C901-BB L538 RHS Declaration of Conformity \[https://az685612.vo.msecnd.net/pdfs/certificates/EU-Konformit--tserkl--rung_L538_RHS_V3-0.pdf\]](https://az685612.vo.msecnd.net/pdfs/certificates/EU-Konformit--tserkl--rung_L538_RHS_V3-0.pdf)

[GM5T-19G461-FA B479 EU Declaration of Conformity \[https://az685612.vo.msecnd.net/pdfs/certificates/EU-Konformitaetserklaerung_B479_2_sign.pdf\]](https://az685612.vo.msecnd.net/pdfs/certificates/EU-Konformitaetserklaerung_B479_2_sign.pdf)

[GNSS Declaration of Conformity \[https://az685612.vo.msecnd.net/pdfs/certificates/DoC_GNSS.pdf\]](https://az685612.vo.msecnd.net/pdfs/certificates/DoC_GNSS.pdf)

[HUF8423MS EU Declaration of Conformity \[https://az685612.vo.msecnd.net/pdfs/certificates/HUF8423MS_EU_DoC_2019-06-07.pdf\]](https://az685612.vo.msecnd.net/pdfs/certificates/HUF8423MS_EU_DoC_2019-06-07.pdf)

[HUF8432MS EU TEC Declaration of Conformity \[https://az685612.vo.msecnd.net/pdfs/certificates/HUF8432MS_EU_TEC_2019-06-07.pdf\]](https://az685612.vo.msecnd.net/pdfs/certificates/HUF8432MS_EU_TEC_2019-06-07.pdf)

[IHU-4-0 Declaration of Conformity \[https://az685612.vo.msecnd.net/pdfs/certificates/doc-red-ihu-4-0.pdf\]](https://az685612.vo.msecnd.net/pdfs/certificates/doc-red-ihu-4-0.pdf)

[MAM Declaration of Conformity \[https://az685612.vo.msecnd.net/pdfs/certificates/DoC_MAM.pdf\]](https://az685612.vo.msecnd.net/pdfs/certificates/DoC_MAM.pdf)

[TVamp Declaration of Conformity \[https://az685612.vo.msecnd.net/pdfs/certificates/DoC_TVamp.pdf\]](https://az685612.vo.msecnd.net/pdfs/certificates/DoC_TVamp.pdf)

[VCM Declaration of Conformity \[https://az685612.vo.msecnd.net/pdfs/certificates/VCM_Declaration_of_Conformity_RED.pdf\]](https://az685612.vo.msecnd.net/pdfs/certificates/VCM_Declaration_of_Conformity_RED.pdf)

[Aptiv wireless charger Declaration of Conformity \[https://az685612.vo.msecnd.net/pdfs/certificates/DoC_scanned.pdf\]](https://az685612.vo.msecnd.net/pdfs/certificates/DoC_scanned.pdf)

Applies from and including 2021

[NR-0V \(No RQZY4-0062\) Declaration of Conformity \[https://az685612.vo.msecnd.net/pdfs/2021/Declaration_of_Conformity_for_RED_NR-0V_RQZY4-0062.pdf\]](https://az685612.vo.msecnd.net/pdfs/2021/Declaration_of_Conformity_for_RED_NR-0V_RQZY4-0062.pdf)

2.3.5. Certificate for wireless charger





2.3.6. Type approval for the remote control key system

Type approval for the car's remote key system can be seen in the following tables.







Lock system keyless start (Passive Start) and keyless locking/unlocking (Passive Entry*)







CEM marking for the remote control key system. For supplementary type approval numbers, see following tables.

Country/Area	Type approval	
Argentina	CNC ID: C-14771	
Brazil	MT-3245/2015	 0589-15-6830  (01) 0 7897843840961
Europe	Delphi Deutschland GmbH, 42367 Wuppertal hereby declares that this VO3-134TRX conforms to the essential property requirements and other relevant provisions contained in directive 2014/53/EU (RED).	
The United Arab Emirates	ER37847/15 DA0062437/11	
Indonesia	Nomor: 38301/SDPPI/2015	
Jordan	TRC/LPD/2014/250	
Malaysia	RDBV/11A/0816/S(16-2430)	
Mexico	IFETEL: RLVDEVO15-0396	
Namibia	TA-2016-02	 Communications Regulatory Authority of Namibia
Russia		
Serbia	P1614120100	
South Africa	TA-2014-1868	

Remote control key

Country/Area	Type approval	
Europe	Huf Hülsbeck & Fürst GmbH & Co. KG hereby declares that this type of radio equipment HUF8423MS conforms to directive 2014/53/EU. Wavelength: 433.92 MHz Maximum radiated transmission power: 10 mW Manufacturer: Huf Hülsbeck & Fürst GmbH & Co. KG, Steeger Str. 17, 42551 Velbert, Germany	
Argentina		See the illustration below the table.
Brazil	Anatel: 06768-19-06643 Modelo: HUF8423MS Este equipamento opera em caráter secundário isto é não tem direito a proteção contra interferência prejudicial, mesmo de estações do mesmo tipo, e não pode causar interferência a sistemas operando em caráter primário.	
Philippines	ESD-1919938C	
The United Arab Emirates		TRA REGISTERED No: ER72485/19 DEALER No: DA36976/14
Ghana	NCA Approved: ZRO-M8-7E3-138	
Indonesia ^[1]	Sertifikat Nomor: 65073/SDPPI/2019 PLG ID: 8093	
CU (Customs Union) Kazakhstan, Russia		
Morocco	AGREE PAR L'ANRT MAROC Numéro d'agrément: MR 20402 ANRT 2019 Date d'agrément: 10/07/2019	
Moldova		
Nigeria	Connection and use of this communication equipment is permitted by the Nigerian Communications Commission	
Oman		OMAN - TRA R/7757/19 D172249
Paraguay	HUF8423MS	HUF8423MS  NR.2019-08-I-0447
Serbia		

Country/Area	Type approval	
Singapore	Complies with IMDA Standards DA103787	
South Africa	TA-2019/772	
Taiwan	<p>????????????????????</p> <p>????????????????</p> <p>.1</p> <p>??</p> <ul style="list-style-type: none"> ?? <p>.2</p> <p>??</p> <ul style="list-style-type: none"> ?? ?? <p>??</p> <ul style="list-style-type: none"> ?????? 	
Ukraine	.Справжнім Huf Hüsbeck & Fürst GmbH & Co KG заявляє, що тип радіобладнання відповідає Технічному[HUF8423MS] регламенту радіобладнання; повний текст -декларації про відповідність доступний на веб :сайті за такою адресою Робоча частота: 433,92 ГГц	
Vietnam		
Belarus		
Zambia		 ZMB/ZICTA/TA/2019/7/105











Argentina

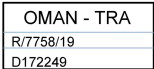

H-23694

Key Tag

Country/Area	Type approval	
Europe	Huf Hüsbeck & Fürst GmbH & Co. KG hereby declares that this type of radio equipment HUF8432MS conforms to directive 2014/53/EU. Wavelength: 433.92 MHz Maximum radiated transmission power: 10 mW Manufacturer: Huf Hüsbeck & Fürst GmbH & Co. KG, Steeger Str. 17, 42551 Velbert, Germany	

Country/Area	Type approval	
Argentina		See the illustration below the table.
Brazil	Anatel: 04362-16-06643 Modelo: HUF8432MS Este equipo opera em caráter secundário isto é não tem direito a proteção contra interferência prejudicial, mesmo de estações do mesmo tipo, e não pode causar interferência a sistemas operando em caráter primário.	
Ghana	NCA Approved: ZRO-M8-7E3-139	
Philippines	ESD-1919939C	
The United Arab Emirates		
CU (Customs Union) Kazakhstan, Russia		
Indonesia ^[1]	Sertifikat Nomor: 65072/SDPPI/2019 PLG ID: 8093	
Morocco	AGREE PAR L'ANRT MAROC Numéro d'agrément: MR 20403 ANRT 2019 Date d'agrément: 10/07/2019	
Moldova		
Nigeria	Connection and use of this communications equipment is permitted by the Nigerian Communications Commission	
Oman		
Paraguay	HUF8432MS	
Serbia		
Singapore	Complies with IMDA Standards DA103787	
South Africa	TA-2019-773	
Taiwan	<p>????????????????????</p> <p>????????????????????</p> <p>.1</p> <p>????????????????????</p> <ul style="list-style-type: none"> ???????????????????? <p>.2</p> <p>????????????????????</p> <ul style="list-style-type: none"> ???????????????????? ???????????????????? <p>????????????????????</p> <ul style="list-style-type: none"> ?????? 	

Country/Area	Type approval	
Ukraine	.Справжнім Huf Hüsbeck & Fürst GmbH & Co KG заявляє, що тип радіобладнання відповідає Технічному[HUF8432MS] регламенту радіобладнання; повний текст -декларації про відповідність доступний на веб :сайті за такою адресою Робоча частота: 433,92 ГГц	
Vietnam		 ICT
Belarus		
Zambia		 ZMB/ZICTA/TA/2019/7/121

Argentina



H-23695

* Option/accessory.

[1] Only applies to Indonesia.

2.3.7. Customer Privacy Policy

Volvo respects and safeguards the personal integrity of everyone visiting our website.

This policy regards to the handling of customer data and personal information. The purpose is to give current, past and potential customers a general understanding of:

- The circumstances in which we gather and process your personal data.
- The types of personal data we gather.
- The reason we gather your personal data.
- How we handle your personal data.

For more information on the policy, search support information at [volvocars.com](https://www.volvocars.com/) [<https://www.volvocars.com/>].

2.3.8. Terms & Conditions for Services

Volvo offers services that help to enhance car safety and comfort.

These services include everything from assistance in emergencies to navigation and various maintenance services.

Before using the services, it is important for you to read the support information relating to the Terms & Conditions for Services at [volvocars.com \[https://www.volvocars.com/\]](https://www.volvocars.com/).

2.3.9. Navigation license agreements *

A license^[1] is an agreement granting a right to conduct some activity or to make use of another person's right under the terms and conditions of the agreement.

END USER LICENSE AGREEMENT

PLEASE READ THIS END USER LICENSE AGREEMENT CAREFULLY BEFORE USING THE HERE DATABASE.

NOTICE TO THE USER

THIS IS A LICENSE AGREEMENT - AND NOT AN AGREEMENT FOR SALE – BETWEEN YOU AND HERE EUROPE B.V. ("HERE") FOR YOUR COPY OF THE HERE NAVIGABLE MAP DATABASE, INCLUDING ASSOCIATED COMPUTER SOFTWARE, MEDIA AND EXPLANATORY PRINTED DOCUMENTATION PUBLISHED BY HERE (JOINTLY "THE DATABASE"). BY USING THE DATABASE, YOU ACCEPT AND AGREE TO ALL TERMS AND CONDITIONS OF THIS END USER LICENSE AGREEMENT ("AGREEMENT"). IF YOU DO NOT AGREE TO THE TERMS OF THIS AGREEMENT, PROMPTLY RETURN THE DATABASE, ALONG WITH ALL OTHER ACCOMPANYING ITEMS, TO YOUR SUPPLIER FOR A REFUND.

OWNERSHIP

The Database and the copyrights and intellectual property or neighboring rights therein are owned by HERE and its licensors. Ownership of the media on which the Database is contained is retained by HERE and/or your supplier until you have paid in full any amounts due to HERE and/or your supplier pursuant to this Agreement or similar agreement(s) under which the Database is provided to you.

LICENSE GRANT

HERE grants you a non-exclusive license to use the Database for your personal use or, if applicable, for use in your business' internal operations. This license does not include the right to grant sub-licenses.

LIMITATIONS ON USE

The Database is restricted for use in the specific system for which it was created. Except to the extent explicitly permitted by mandatory laws (e.g. national laws based on the European Software Directive (91/250) and the Database Directive (96/9)), you may not extract or reutilize substantial parts of the contents of the Database nor reproduce, copy, modify, adapt, translate, disassemble, decompile, reverse engineer any portion of the Database. If you wish to obtain interoperability information as meant in (the national laws based on) the European Software Directive, you shall grant HERE reasonable opportunity to provide said information on reasonable terms, including costs, to be determined by HERE.

The Database includes information provided under license to HERE from third parties and is subject to the supplier terms and copyright notices set forth at the following URL:

Here.com/supplierterms

TRANSFER OF LICENSE

You may not transfer the Database to third parties, except when installed in the system for which it was created or when you do not retain any copy of the Database, and provided that the transferee agrees to all terms and conditions of this Agreement and confirms this in writing to HERE. Multi-disc sets may only be transferred or sold as a complete set as provided by HERE and not as subset thereof.

LIMITED WARRANTY

HERE warrants that, subject to the warnings set out below, for a period of 12 months after acquisition of your copy of the Database, it will perform substantially in accordance with HERE's Criteria for Accuracy and Completeness existing on the date you acquired the Database; these criteria are available from HERE at your request. If the Database does not perform in accordance with this limited warranty, HERE will use reasonable efforts to repair or replace your non-conforming copy of the Database. If these efforts do not lead to performance of the Database in accordance with the warranties set out herein, you will have the option to either receive a reasonable refund of the price you paid for the Database or to rescind this Agreement. This shall be HERE's entire liability and your sole remedy against HERE. Except as expressly provided in this section, HERE does not warrant nor make any representations regarding the use of results of the use of the Database in terms of its correctness, accuracy, reliability, or otherwise. HERE does not warrant that the Database is or will be error free. No oral or written information or advice provided by HERE, your supplier or any other person shall create a warranty or in any way increase the scope of the limited warranty described above. The limited warranty set forth in this Agreement does not affect or prejudice any statutory legal rights that you may have under the legal warranty against hidden defects.

If you did not acquire the Database from HERE directly, you may have statutory rights against the person from whom you have acquired the Database in addition to the rights granted by HERE hereunder according to the law of your jurisdiction. The above warranty of HERE shall not affect such statutory rights and you may assert such rights in addition to the warranty rights granted herein.

LIMITATION OF LIABILITY

The price of the Database does not include any consideration for assumption of risk of consequential, indirect or unlimited direct damages which may arise in connection with your use of the Database. Accordingly, in no event shall HERE be liable for any consequential or indirect damages, including without limitation, loss of revenue, data, or use, incurred by you or any third party arising out of your use of the Database, whether in an action in contract or tort or based on a warranty, even if HERE has been advised of the possibility of such damages. In any event HERE's liability for direct damages is limited to the price of your copy of the Database.

THE LIMITED WARRANTY AND LIMITATION OF LIABILITY, SET FORTH IN THIS AGREEMENT, DO NOT AFFECT OR PREJUDICE YOUR STATUTORY RIGHTS WHERE YOU HAVE ACQUIRED THE DATABASE OTHERWISE THAN IN THE COURSE OF A BUSINESS.

WARNINGS

The Database may contain inaccurate or incomplete information due to the passage of time, changing circumstances, sources used and the nature of collecting comprehensive geographic data, any of which may lead to incorrect results. The Database does not include or reflect information on - inter alia - travel time and may not include neighborhood safety; law enforcement; emergency assistance; construction work; road or lane closures; road slope or grade; bridge height, weight or other limits; road conditions; special events depending on the navigation system brand you possess.

GOVERNING LAW

This Agreement shall be governed by the laws of the jurisdiction, in which you reside at the date of acquisition of the Database. Should you at that moment reside outside the European Union or Switzerland, the law of the jurisdiction within the European Union or Switzerland where you acquired the Database shall apply. In all other cases, or if the jurisdiction where you acquired the Database cannot be defined, the laws of the Netherlands shall apply. The courts competent at your place of residence at the time you acquired the Database shall have jurisdiction over any dispute arising out of, or relating to this Agreement, without prejudice to HERE' right to bring claims at your then current place of residence.

* Option/accessory.

^[1] EULA = End User License Agreement

2.3.10. Candidate List Substance Information (CL) in accordance with the Reach Regulation, Article 33.1

In accordance with Article 33.1 of the REACH Regulation (Reg. EC 1907/2006),^[1] professional customers must be informed of Substances of Very High Concern (SVHC^[2]) in products supplied by Volvo Cars. The intention is to facilitate the safe handling of the constituent components affected in order to protect people and the environment.

Volvo Cars supports the underlying goals of the REACH regulation in general, and Article 33 in particular, which are consistent with our own commitment to promote the responsible manufacturing, handling and use of our products.

Presence of Candidate List Substances

The articles in the "Candidate List Substances Table" below contain substances at greater than 0.1% w/w in the candidate list (CL) for the specific car. The information on substances in the candidate list (CL) is based on the data obtained from our suppliers and our own product data.

General Safe Use Information for Articles

Every car from Volvo Cars is provided with an owner's manual, which includes safe use information for owners/drivers/users of the car. Volvo Cars information on repair and servicing of cars and genuine parts also includes safe use information for service personnel.

Where present in parts of this car, the Candidate List substances shown on the relevant "Candidate List Substances Table" for the specific car are incorporated in such a way that potential exposure to customers as well as risks for people or the environment can be minimised as long as the car and its parts are used as intended, and any repairs, servicing and maintenance are carried out following technical instructions for those activities, and industry standard good practices.

An end-of-life vehicle may only be disposed of legally in the European Union at an Authorised Treatment Facility (ATF). Vehicle parts should be disposed in accordance with locally applicable laws and local authority guidance.

Candidate List Substances Table

More details are available in a pdf file, see Support / Information about the car / Rules and regulations.

We hereby inform that almost all product areas contain lead (CAS No 7439-92-1), primarily as alloying elements in steel, aluminium and copper.

^[1] REACH - The European Union's chemicals legislation, which entered into force on 1 June 2007, Regulation (EC) No. 1907/2006 concerning the Registration, Evaluation, Authorisation and Restriction of Chemicals (REACH).

^[2] SVHC - Substances of Very High Concern, which are included in the current candidate list (CL).

2.3.11. Spotify License agreement

Volvo provides a wide range of services, apps and programmes with the aim of making it more convenient, more pleasant and safer for you to use your Volvo. Several of the apps and programs are produced by third-party companies and contain software licensed by the third-party producer.

Spotify License agreement

This product contains third-party software licensed by Spotify: www.spotify.com/connect/third-party-licenses [<https://www.spotify.com/connect/third-party-licenses>].

2.4. Displays and controls by the driver in a left-hand drive car

The overviews show where the displays and controls near the driver are located.

Steering wheel and instrument panel



- 1 Position lamps, daytime running lights, dipped beam, main beam, direction indicators, rear fog lamp, resetting the trip meter
- 2 Steering wheel paddles for manual gear changing in an automatic gearbox*
- 3 Head-up display*
- 4 Driver display

- 5 Wipers and washing, rain sensor*
- 6 Right-hand steering wheel keypad
- 7 Steering wheel adjustment
- 8 Horn
- 9 Left-hand steering wheel keypad
- 10 Bonnet opening
- 11 Display lighting, tailgate unlocking/opening*/closing*, halogen headlamp levelling

Roof console



- 1 Front reading lamps and interior lighting
- 2 Panoramic roof*
- 3 Display in roof console, ON CALL button*
- 4 Manual dimming of interior rearview mirror *^[1]

Centre and tunnel console

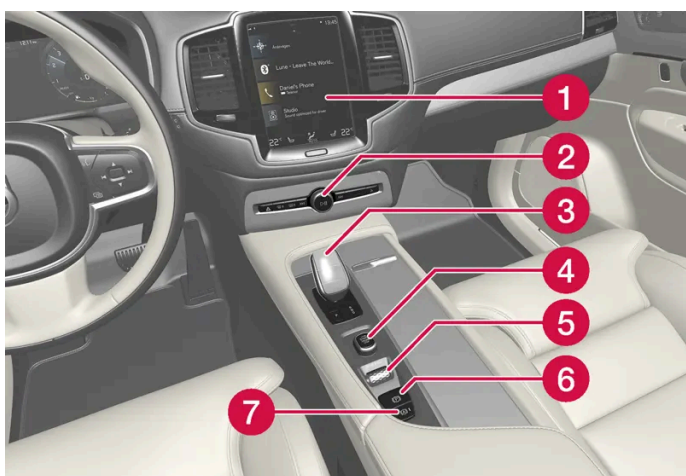

- 1 Centre display
- 2 Hazard warning flashers, defrosting, media, glovebox opening
- 3 Gear selector
- 4 Start knob

The content of this manual represents the status of the user manual at the time of printing and may not be completely valid in future instances. For more information, refer to the first page for the complete disclaimer note.

- 5 Drive mode control
- 6 Parking brake
- 7 Automatic braking when stationary

Driver's door

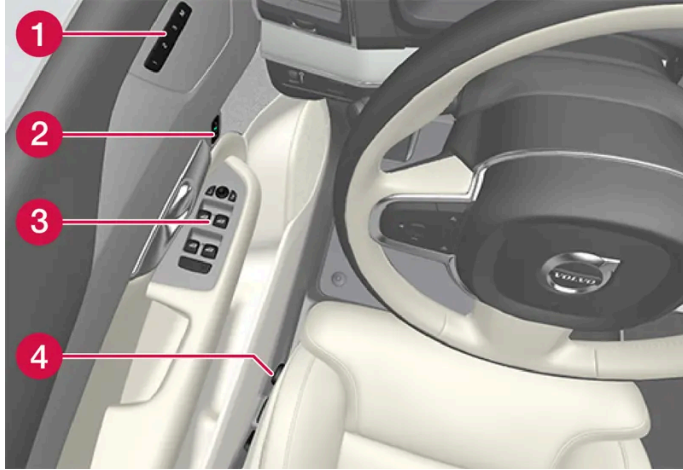

- 1 Memories for power front seat*, door mirror and head-up display* settings
- 2 Central locking
- 3 Power windows, door mirrors, electric child lock*
- 4 Adjusting front seat

* Option/accessory.

[1] There are no controls for manual dimming for cars with automatic dimming.

2.5. Displays and controls by the driver in a right-hand drive car

The overviews show where the displays and controls near the driver are located.

Steering wheel and instrument panel

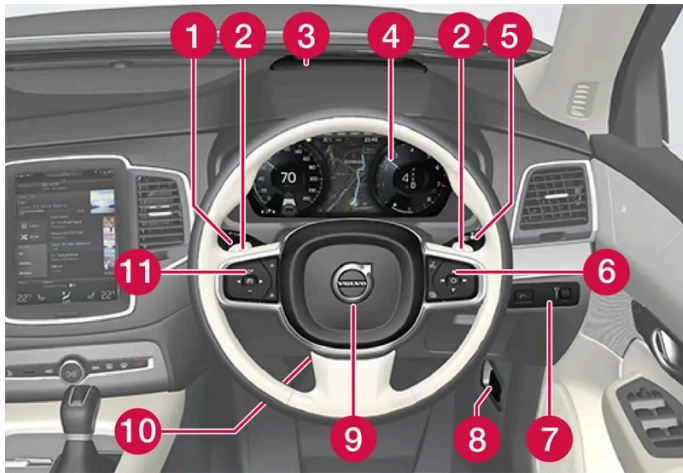

- 1 Position lamps, daytime running lights, dipped beam, main beam, direction indicators, rear fog lamp, resetting the trip meter
- 2 Steering wheel paddles for manual gear changing in an automatic gearbox*
- 3 Head-up display*
- 4 Driver display
- 5 Wipers and washing, rain sensor*
- 6 Right-hand steering wheel keypad
- 7 Display lighting, tailgate unlocking/opening*/closing*, halogen headlamp levelling
- 8 Bonnet opening
- 9 Horn
- 10 Steering wheel adjustment
- 11 Left-hand steering wheel keypad

Roof console



- 1 Front reading lamps and interior lighting
- 2 Panoramic roof*
- 3 Display in roof console, ON CALL button*
- 4 Manual dimming of interior rearview mirror

Centre and tunnel console

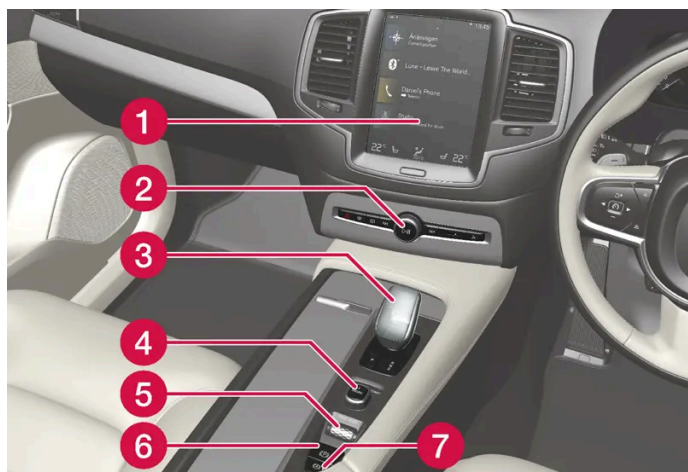

- 1 Centre display
- 2 Hazard warning flashers, defrosting, media, glovebox opening
- 3 Gear selector
- 4 Start knob
- 5 Drive mode control
- 6 Parking brake
- 7 Automatic braking when stationary

Driver's door

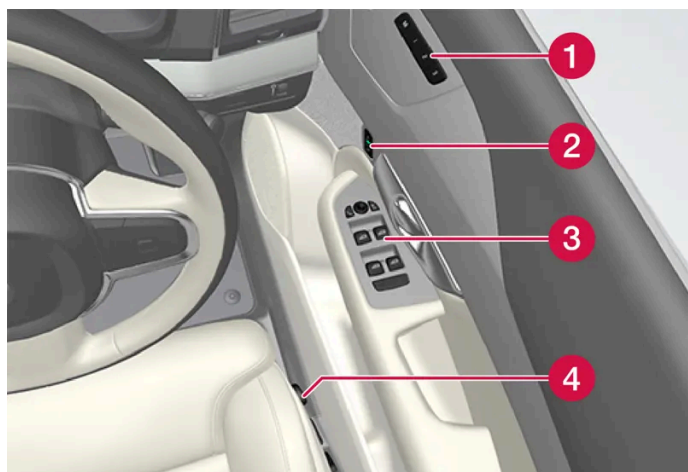

- 1 Memories for power front seat*, door mirror and head-up display* settings
- 2 Central locking
- 3 Power windows, door mirrors, electric child lock*
- 4 Adjusting front seat

* Option/accessory.

2.6. Connection of equipment to the car's diagnostic socket

Incorrect connection and installation of software or diagnostic tools may have a negative effect on the car's electronic system.

Volvo strongly recommends that Volvo owners only install Volvo approved original accessories, and that installation of accessories is only carried out by trained and qualified Volvo service technicians. Certain accessories only function when associated software is installed in the car's computer system.

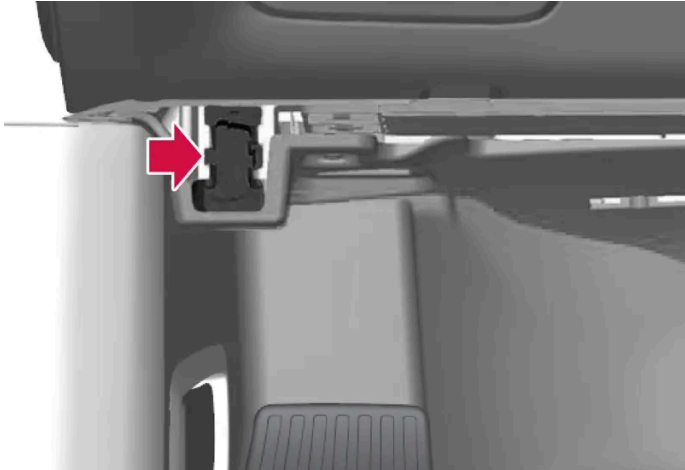

Data link connector (On-board Diagnostic, OBDII) is under the instrument panel on the driver's side.

i Note

Volvo Cars accepts no liability for the consequences if unauthorised equipment is connected to the On-board Diagnostic socket (OBDII). This socket should only be used by trained and qualified Volvo service technicians.

2.7. Driver distraction

The driver is responsible for doing everything possible to ensure the safety of themselves, their passengers and other road users. Part of this responsibility is avoiding distractions such as carrying out an activity that is not related to operating the car in a driving environment.

Your new Volvo is equipped with content-rich entertainment and communications systems. You may also have other portable electronic devices for your own convenience. Use these systems and devices in a safe manner in order to avoid distraction.

We wish to give the following warnings regarding such systems, to indicate Volvo's concern for your safety. Never use a device or function in the car in such a way that it will distract you from the task of driving safely. Distractions can lead to serious accidents. Apart from these general warnings, we offer the following advice regarding the new functions that may be in the car:

 **Warning**

- Never use a hand-held mobile phone while driving. In some areas it is forbidden for the driver to use a mobile phone while the car is moving.
- If the car is equipped with a navigation system you must only set and change the itinerary when the car is parked.
- Never program the audio system while the car is moving. Program the radio's presets when the car is parked and then use the programmed presets for faster and simpler use of the radio.
- Never use laptops or hand-held computers while the car is moving.

2.8. Change of market when importing or relocating

When you import a car or relocate a car to another country, it is important that you register the car in the new market in order, for example, for the online services to work correctly, as well as to ensure that the car complies with local requirements and laws.

Visit an authorised Volvo dealer

To get help to register the car, visit an authorised Volvo dealer.

If you do not do this then you may experience that apps, Volvo On Call^[1], software downloads and other online services are affected and do not work correctly.

Creating a new Volvo ID in your new home market

When you relocate to another country you should create a Volvo ID in the new country.

If you have already created a Volvo ID in another country and want to use the same email address, you must first delete your Volvo ID in the region you originally created it. Alternatively, you can create a new Volvo ID using another e-mail address.

For cars with Volvo On Call^[1]

Download the Volvo Cars app from the country where the car will be used and pair the app with your car.

 **Note**

Visit an authorised Volvo dealer if you have imported or relocated with your car to a new country.

Available services may vary depending on market and car model.

 **Note**

If the car is exported to another market, Volvo is not responsible for any adaptations to the car in order to comply with requirements or laws that apply in the importing market. Read more in Service and Warranty or contact your Volvo workshop for more information.

[1] Applicable only to markets that have access to Volvo On Call.

2.9. Showing the car's identification number

All cars have a unique identification number, VIN [1]. This is required, among other things, for contacting a Volvo dealer if you have questions on Volvo On Call, for example.

- 1 Tap on **Settings** in the centre display's top view.
 - 2 Continue to **System** → **System Information** → **Vehicle Identification Number**.
- The car's identification number is shown.

Another way of finding VIN is:

- on the first page of the service and warranty booklet
- in the car's registration document
- look on the dashboard through the car's windscreen.



VIN is positioned in a similar place on all models.

[1] Vehicle Identification Number

2.10. Recording data

The content of this manual represents the status of the user manual at the time of printing and may not be completely valid in future instances. For more information, refer to the first page for the complete disclaimer note.

As part of Volvo's safety and quality assurance, certain information about the vehicle's operation, functionality and incidents are recorded in the car.

Event Data Recorder (EDR)

This vehicle is equipped with an "Event Data Recorder" (EDR). Its primary purpose is to register and record data related to traffic accidents or collision-like situations, such as times when the airbag deploys or the vehicle strikes an obstacle in the road. The data is recorded in order to increase understanding of how vehicle systems work in these types of situations. The EDR is designed to record data related to vehicle dynamics and safety systems for a short time, usually 30 seconds or less.

The EDR in this vehicle is designed to record data related to the following in the event of traffic accidents or collision-like situations:

- how the various systems in the car worked
- whether the driver and passenger seatbelts were fastened/tensioned
- the driver's use of the accelerator or brake pedal
- the travel speed of the vehicle.

This information can help us understand the circumstances in which traffic accidents, injuries and damage occur. The EDR only records data when a non-trivial collision situation occurs. The EDR does not record any data during normal driving conditions. Similarly, the system never registers who is driving the vehicle or the geographic location of the accident or near-miss situation. However, other parties, such as the police, could use the recorded data in combination with the type of personally identifiable information routinely collected after a traffic accident. Special equipment and access to either the vehicle or the EDR is required to be able to interpret the registered data.

In addition to the EDR, the car is equipped with a number of computers designed to continually check and monitor the function of the car. They can record data during normal driving conditions, but in particular register faults affecting the vehicle's operation and functionality, or upon activation of the vehicle's driver support function (e.g. City Safety and the auto brake function).

Some of the recorded data is required to enable service and maintenance technicians to diagnose and remedy any faults that occurred in the vehicle. The registered information is also needed to enable Volvo to satisfy legal requirements laid out in laws and by government authorities. Information registered in the vehicle is stored in its computers until the vehicle is serviced or repaired.

In addition to the above, the registered information can be used in aggregate form for research and product development with the aim of continuously improving the safety and quality of Volvo cars.

Volvo will not contribute to the above-described information being disclosed to third parties without the vehicle owner's consent. To comply with national legislation and regulations, Volvo may be forced to disclose information of this nature to the police or other authorities who may assert a legal right to access such. Special technical equipment which Volvo and workshops that have entered into agreements with Volvo have access to is required to be able to read and interpret the recorded data. Volvo is responsible that the information, which is transferred to Volvo during servicing and maintenance, is securely stored and managed and that its management complies with relevant legal requirements. For further information - contact a Volvo retailer.

Vehicle Connectivity Module (VCM High)

Vehicles equipped with VCM High can collect data on the vehicle's safety functions as well as other functions in the vehicle. Data are collected for product development, quality follow-up and safety work, as well as to improve and monitor the vehicle's quality and its safety functions. The purpose of data collection is also to manage Volvo Car Corporation's warranty undertakings, as well as to meet legal requirements related to engine emissions data.

 **Note**

In conjunction with data collection, Volvo may use a small part of the vehicle's data plan of up to 10 MB/month.

2.11. Installation of accessories

We strongly recommend that Volvo owners only install Volvo approved original accessories, and that installation of accessories is only carried out by trained and qualified Volvo service technicians. Certain accessories only function when associated software is installed in the car's computer system.

- Volvo original accessories are tested to ensure that they function with the car systems for performance, safety and emissions control. In addition, a trained and qualified Volvo service technician knows where accessories may or may not be safely installed in your Volvo. Always seek the advice of a trained and qualified Volvo service technician before installing any accessories in or on your car.
- Accessories that are not approved by Volvo may not have been specifically tested for use with your car.
- Some of the car's performance or safety systems can be negatively affected if you install accessories that have not been tested by Volvo, or if you permit someone without experience of the car to install accessories.
- Damage that is caused by accessories installed in a non-approved or incorrect way is not covered by any new car warranty. More warranty information can be found in the Service and Warranty Booklet. Volvo does not accept any liability for deaths, personal injury or costs arising as a result of the installation of non-original accessories.

2.12. Software updates

So that you as a Volvo customer get the best experience of your car, Volvo continuously develops the systems in the cars and the services that you are offered.

In connection with service at an authorised Volvo dealer, the software in your Volvo will be updated to the latest version. The latest software update allows you to benefit from available improvements, including improvements from earlier software updates.

 **Note**

Functionality after updating may vary depending on market, model, model year and options.

2.13. Important information on accessories and auxiliary equipment

The incorrect connection and installation of accessories and extra equipment can negatively affect the car's electronic system.

The content of this manual represents the status of the user manual at the time of printing and may not be completely valid in future instances. For more information, refer to the first page for the complete disclaimer note.

Volvo strongly recommends that Volvo owners only install Volvo approved original accessories, and that installation of accessories is only carried out by trained and qualified Volvo service technicians. Certain accessories only function when associated software is installed in the car's computer system.

The equipment described in the owner's manual is not available in all cars - they have different equipment depending on adaptations for the needs of different markets and national or local laws and regulations.

Options or accessories described in this manual are marked with an asterisk. In the event of uncertainty over what is standard or an option/accessory, contact a Volvo dealer.

 **Warning**

The driver always bears the ultimate responsibility that the car is used safely and that laws and regulations in force are followed.

It is also important that the car has maintenance and service according to Volvo's recommendations, the owner's information and the Service and Warranty Booklet.

If the on-board information differs from the printed owner's manual then the printed information always has precedence.

3. Safety

3.1. Seatbelts

3.1.1. Seatbelts

Heavy braking can have serious consequences if the seatbelts are not used.

It is important that the seatbelt lies against the body so it can provide good protection. Do not lean the backrest too far back. The seatbelt is designed to protect in a normal seating position.

 **Warning**

Remember not to clip or hook the seatbelt to hooks or other interior fittings, as this prevents the belt from tightening properly.

 **Warning**

The seatbelts and airbags interact. If a seatbelt is not used or is used incorrectly, this may diminish the protection provided by the airbag in the event of a collision.

 **Warning**

Never modify or repair the seatbelts yourself. Volvo recommends that an authorised Volvo workshop should be contacted.

If the seatbelt has been subjected to a major load, such as in conjunction with a collision, the entire seatbelt must be replaced. Some of the seatbelt's protective properties may have been lost even if the seatbelt does not appear damaged. The seatbelt must also be replaced if it shows signs of wear or damage. The new seatbelt must be type-approved and designed for installation at the same location as the replaced seatbelt.

3.1.2. Putting on and taking off seatbelts

Make sure that all passengers have fastened their seatbelts before starting to drive.

Putting on seatbelts

- 1 Pull out the seatbelt slowly and make sure it is not twisted or damaged.

Make sure that the seatbelt is correctly fitted in the belt guide available for the second seat row's centre seat^[1].

Note

The seatbelt is equipped with an inertia reel that is locked in the following situations:

- if the belt is extended too quickly.
- during braking and acceleration.
- if the car leans heavily.
- when driving in sharper bends.

- 2 Lock the belt by inserting the locking tab in the intended buckle.

➤ A loud "click" indicates that the belt has locked.

Warning

Always insert the tongue of the seatbelt into the buckle on the correct side. The seatbelts and buckles would otherwise possibly not function as intended in the event of a collision. There is a risk of serious injury.

- 3 In the front seats and in the outer seats in the second seat row the seatbelt can be adjusted for height.



Press together the seat mounting and move the seatbelt up or down.

Position the belt as high as possible without it chafing against your throat.

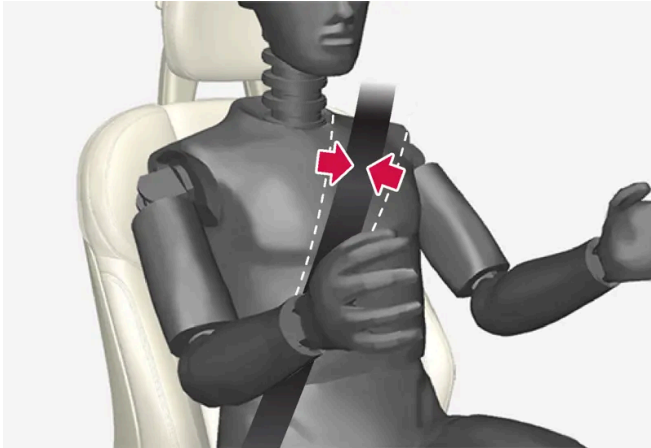

The seatbelt must pass over the shoulder (not down over the arm).

- 4 Tension the hip strap over the lap by pulling the diagonal shoulder belt up towards the shoulder.

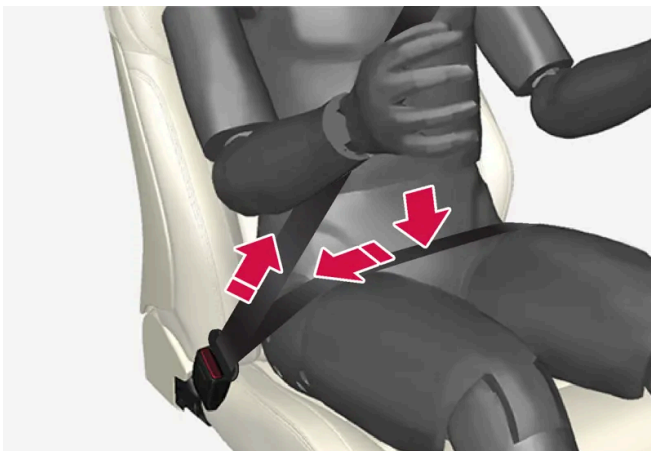

The hip strap must be positioned low down (not over the abdomen).

 **Warning**

Each seatbelt is designed for only one person.

 **Warning**

Remember not to clip or hook the seatbelt to hooks or other interior fittings, as this prevents the belt from tightening properly.

 **Warning**

Do not make any damages on seatbelts nor insert any foreign objects into a buckle. The seatbelts and buckles would then possibly not function as intended in the event of a collision. There is a risk of serious injury.

Taking off seatbelts

The content of this manual represents the status of the user manual at the time of printing and may not be completely valid in future instances. For more information, refer to the first page for the complete disclaimer note.

- 1 Press the red button on the seatbelt buckle and then let the belt retract.
- 2 If the seatbelt does not retract fully, feed it in by hand so that it does not hang loose.
Make sure that the seatbelt is correctly fitted in the belt guide available for the second seat row's centre seat^[1].

^[1] Available for five and seven-seat variants.

3.1.3. Seatbelt tensioner

The car is fitted with standard seatbelt tensioners and electric seatbelt tensioners that can tension the seatbelts in critical situations and collisions.

Standard seatbelt tensioner

All the seatbelts are equipped with a standard seatbelt tensioner.

The seatbelt tensioner tensions the seatbelt in the event of a collision with sufficient force in order to more effectively restrain the occupant.

Electric seatbelt tensioner

The driver and front passenger seatbelts are equipped with an electric seatbelt tensioner.

The seatbelt pretensioner works together and can be activated together with the driver support systems for assistance at risk of collision and Rear Collision Warning. In critical situations, such as panic braking, driving off the road (e.g. the car rolls into a ditch, lifts off the ground or hits something in the terrain), skidding, or risk of collision, the seatbelt can be tensioned by the seatbelt tensioner's electric motor.

The electric seatbelt tensioner helps to adjust the occupant to a better position, reducing the risk of striking the car's interior and improving the effect of safety systems, such as the car's airbags.

When the critical situation has come to an end, the seatbelt and the electric seatbelt pretensioner are restored automatically, but they can also be restored manually.

Important

If the passenger airbag is deactivated, the electric seatbelt tensioner on the passenger side will also be deactivated.

 **Warning**

Never modify or repair the seatbelts yourself. Volvo recommends that an authorised Volvo workshop should be contacted.

If the seatbelt has been subjected to a major load, such as in conjunction with a collision, the entire seatbelt must be replaced. Some of the seatbelt's protective properties may have been lost even if the seatbelt does not appear damaged. The seatbelt must also be replaced if it shows signs of wear or damage. The new seatbelt must be type-approved and designed for installation at the same location as the replaced seatbelt.

3.1.4. Resetting the electric seatbelt tensioner

The electric seatbelt tensioner is designed to be reset automatically, but the seatbelt tensioner can be reset manually if the belt remains extended.

- 1 Stop the car at a safe place.
 - 2 Unfasten the seatbelt and then refasten it.
- The seatbelt and electric seatbelt tensioner are reset.

 **Warning**

Never modify or repair the seatbelts yourself. Volvo recommends that an authorised Volvo workshop should be contacted.

If the seatbelt has been subjected to a major load, such as in conjunction with a collision, the entire seatbelt must be replaced. Some of the seatbelt's protective properties may have been lost even if the seatbelt does not appear damaged. The seatbelt must also be replaced if it shows signs of wear or damage. The new seatbelt must be type-approved and designed for installation at the same location as the replaced seatbelt.

3.1.5. Door and seatbelt reminder

The system reminds unbelted occupants to wear a seatbelt, and also warns about an open door, bonnet or lid.

Driver display graphics



Graphics in the driver display with different types of warnings. The warning colour on the door and tailgate is dependent on the vehicle's speed.

The driver display's graphics show which seats in the car are occupied by belted and unbelted passengers.

The same graphic is also shown if the bonnet, tailgate, fuel filler flap or any door is open.

The graphic can be acknowledged by pressing the  button on the right-hand steering wheel keypad.

Seatbelt reminder



Visual reminder in the roof console.

A visual reminder is given in the roof console and by means of the warning symbol in the driver display.

The acoustic reminder is dependent on speed, driving time and distance.

The belt status of the driver and passengers is shown in the driver display's graphic when a belt is buckled or unbuckled.

Child seats are not covered by the seatbelt reminder system.

Front seat

A visual and acoustic reminder remind the driver and front seat passenger to use a seatbelt if either of them is not wearing one.

Rear seat

The seatbelt reminder in the rear seat has two subfunctions:

- Provides information on which seatbelts are being used in the rear seat. The driver display's graphics are shown when the seatbelts are in use.
- Reminding that a seatbelt in the rear seat is unfastened during a journey by means of a visual and acoustic reminder. The reminder will cease once the seatbelt has been put on again.

Reminder for doors, bonnet, tailgate and fuel filler flap

If the bonnet, tailgate, fuel filler flap or a door is not closed properly, the driver display's graphic shows what is open. Stop the car in a safe place as soon as possible and close the source of the warning.



If the car is driven at a speed lower than approx. 10 km/h (6 mph) then the driver display's information symbol illuminates.



If the car is driven at a speed higher than approx. 10 km/h (6 mph) then the driver display's warning symbol illuminates.

3.2. Airbags

3.2.1. Airbags

The car is equipped with a number of different airbags in order to assist in protecting driver and passengers.

Note

The detectors react differently depending on the nature of the collision and whether or not the seatbelts are fastened. Applies to all belt positions.

It is therefore possible that only one (or none) of the airbags may inflate in a collision. The detectors sense the force of the collision on the vehicle and the action is adapted accordingly so that none, one or more airbags are deployed.

Warning

The airbag system's control module is located in the centre console. If the centre console is drenched with water or other liquid, disconnect the cables to the starter battery. Do not attempt to start the car since the airbags may deploy. Recovering the car. Volvo recommends that it is transported to an authorised Volvo workshop.

Deployed airbags

If any of the airbags have deployed, the following is recommended:

The content of this manual represents the status of the user manual at the time of printing and may not be completely valid in future instances. For more information, refer to the first page for the complete disclaimer note.

- Recovering the car. Volvo recommends that it is transported to an authorised Volvo workshop. Do not drive with deployed airbags.
- Volvo recommends engaging an authorised Volvo workshop to handle the replacement of components in the car's safety systems.
- Always contact a doctor.

 **Warning**

Never drive with deployed airbags. They can make steering difficult. Other safety systems may also be damaged. The smoke and dust created when the airbags are deployed can cause skin and eye irritation/injury after intensive exposure. In case of irritation, wash with cold water. The rapid deployment sequence and airbag fabric may cause friction and skin burns.

3.2.2. Driver airbags

As a supplement to the seatbelts, the car is equipped with steering wheel airbag and knee airbag on the driver's side.



Steering wheel airbag and knee airbag on the driver's side in the front seat.

In the event of a frontal collision, the airbags help to protect the head, neck, face and chest of the driver as well as the knees and legs.

A sufficiently violent collision trips the sensors and the airbag/airbags is inflated. The airbag cushions the initial collision impact for the occupant. The airbag deflates when compressed by the collision. When this occurs, smoke escapes into the car. This is completely normal. The entire process, including inflation and deflation of the airbag, occurs within tenths of a second.

 **Warning**

The seatbelts and airbags interact. If the belt is not used or is used incorrectly, this may diminish the protection provided by the airbag in the event of a collision.

To minimise the risk of injury if the airbag deploys, passengers must sit as upright as possible with their feet on the floor and backs against the backrest.

 **Warning**

Volvo recommends that an authorised Volvo workshop should be contacted for repair. Defective work in the airbag system could cause malfunction and result in serious personal injury.

Steering wheel airbag location

This airbag is fitted into the centre of the steering wheel. The steering wheel is marked AIRBAG.

Knee airbag location

The airbag is folded up in the lower part of the instrument panel on the driver's side. Its cover panel is marked AIRBAG.

 **Warning**

Do not place or attach any object on the top or front of the panel where the knee airbag is stowed.

3.2.3. Passenger airbag

As a supplement to the seatbelts, the vehicle is equipped with an airbag on the passenger side in the front seat.



Passenger side front airbag.

In the event of a frontal collision, the airbag helps to protect the head, neck, face and chest of the passenger as well as the knees and legs.

A sufficiently violent collision trips the sensors and the airbag is inflated. The airbag cushions the initial collision impact for the occupant. The airbag deflates when compressed by the collision. When this occurs, smoke escapes into the car. This is completely normal. The entire process, including inflation and deflation of the airbag, occurs within tenths of a second.

 **Warning**

The seatbelts and airbags interact. If the belt is not used or is used incorrectly, this may diminish the protection provided by the airbag in the event of a collision.

To minimise the risk of injury if the airbag deploys, passengers must sit as upright as possible with their feet on the floor and backs against the backrest.

 **Warning**

Volvo recommends that an authorised Volvo workshop should be contacted for repair. Defective work in the airbag system could cause malfunction and result in serious personal injury.

Passenger airbag location

The airbag is folded up into a compartment above the glovebox. Its cover panel is marked AIRBAG.

 **Warning**

Do not put objects in front of or above the dashboard where the passenger airbag is located.

Label for passenger airbag



Label on the passenger side's sun visor.

The warning label for the passenger airbag is positioned as shown above.

Warning

If the car is not equipped with a switch to activate/deactivate the passenger airbag, the airbag will always be activated.

Warning

Never allow anybody to stand or sit in front of the front passenger seat.

Never use a rear-facing child seat on the front passenger seat if the airbag is activated.

Front-facing passengers (children and adults) must never sit on the front passenger seat if the passenger airbag is deactivated.

Failure to follow the advice given above can endanger life or lead to serious personal injury.

Warning

NEVER use a rearward facing child restraint on a seat protected by an ACTIVE AIRBAG in front of it, DEATH or SERIOUS INJURY to the CHILD can occur.

3.2.4. Activating and deactivating passenger airbag*

The passenger airbag can be deactivated if the car is equipped with a switch, Passenger Airbag Cut Off Switch (PACOS).

The switch for the passenger airbag is located on the passenger end of the instrument panel and is accessible when the passenger door is open.

Check that the switch is in the required position.

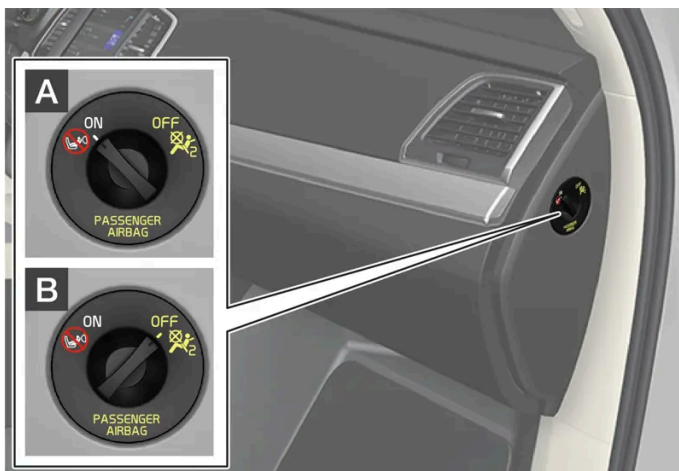

A ON - the airbag is activated and all front-facing passengers (children and adults) can sit safely on the passenger seat.

B OFF - The airbag is deactivated and children in rear-facing child seats can sit safely on the passenger seat.

 **Warning**

If the car is not equipped with a switch to activate/deactivate the passenger airbag, the airbag will always be activated.

Activating passenger airbag



1
Pull the switch outward and turn from OFF to ON.

➤ The driver display shows the message **Passenger airbag on Please acknowledge**.

 **Note**

If the passenger airbag has been activated/deactivated with the car in ignition position I or lower, a message is shown in the driver display and the following indicator in the roof console approx. 6 seconds after the car's electrical system has been set in ignition position II.

2 Confirm the message by pressing the right-hand steering wheel keypad's O button.



➤ A text message and a warning symbol in the roof console indicate that the airbag for the front passenger seat is activated.

 **Warning**

Never use a rear-facing child seat on the front passenger seat when the airbag is activated.

The passenger airbag must always be activated when front-facing passengers (children and adults) are sitting in the front passenger seat.

Failure to follow the advice given above can endanger life or lead to serious personal injury.

Deactivating passenger airbag



1
Pull the switch outward and turn from ON to OFF.

➤ The driver display shows the message **Passenger airbag off Please acknowledge**.

 **Note**

If the passenger airbag has been activated/deactivated with the car in ignition position I or lower, a message is shown in the driver display and the following indicator in the roof console approx. 6 seconds after the car's electrical system has been set in ignition position II.

2 Confirm the message by pressing the right-hand steering wheel keypad's **O** button.

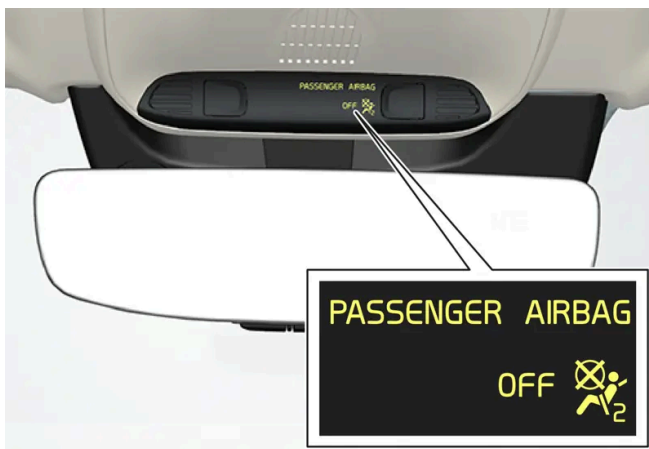

➤ A text message and a symbol in the roof console indicate that the airbag for the front passenger seat is deactivated.

 **Warning**

Front-facing passengers (children and adults) must never sit on the passenger seat when the airbag is deactivated. Failure to follow the advice given above can endanger life or lead to serious personal injury.

 **Important**

If the passenger airbag is deactivated, the electric seatbelt tensioner on the passenger side will also be deactivated.

* Option/accessory.

3.2.5. Inflatable curtains

The inflatable curtain, Inflatable Curtain (IC), helps to prevent the driver and passengers from striking their heads on the inside of the car during a collision.

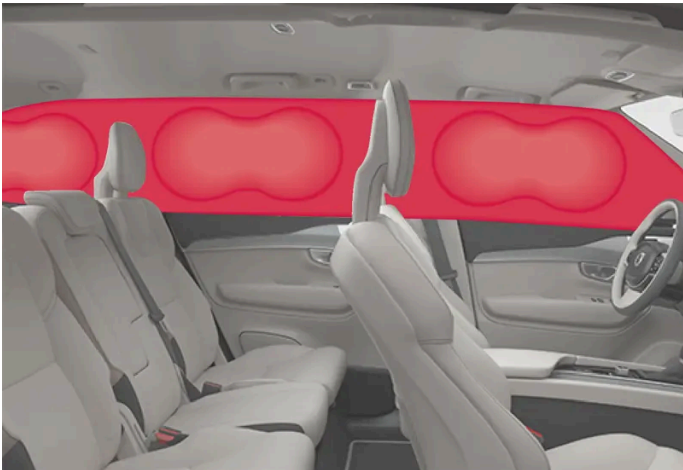

The inflatable curtain is mounted along both sides of the headlining and helps protect the driver and outer seat passengers of the car. The panels are labelled with IC AIRBAG.

A sufficiently violent collision trips the sensors and the inflatable curtain is inflated.

 **Warning**

Volvo recommends that an authorised Volvo workshop should be contacted for repair. Defective work in the inflatable curtain system can cause malfunction and result in serious personal injury.

 **Warning**

Never hang or attach heavy items onto the handles in the roof. The hooks are only designed for light coats and jackets (not for solid objects such as umbrellas).

Do not screw or install anything onto the car's headlining, door pillars or side panels. This could compromise the intended protection. Volvo recommends only using Volvo genuine parts that are approved for fitting within these areas.

 **Warning**

Leave 10 cm (4 inches) space between the load and the side windows if the car is loaded to above the top edge of the door windows. Otherwise, the intended protection of the inflatable curtain, which is concealed in the headlining, may be compromised.

 **Warning**

The inflatable curtain is a supplement to the seatbelts. Always use a seatbelt.

3.2.6. Side airbags

The side airbags on the driver's and passenger seats act to protect the chest and hips in the event of a collision.



The side airbags are fitted in the outer backrest frames of the front seats and help to protect the driver and passengers in the front seat.

A sufficiently violent collision trips the sensors and the side airbags are inflated. The airbag inflates between the occupant and the door panel and thereby cushions the initial impact. The airbag deflates when compressed by the collision. The side airbag is normally only deployed on the side of the collision.

 **Warning**

Volvo recommends that an authorised Volvo workshop should be contacted for repair. Defective work in the side airbag system could cause malfunction and result in serious personal injury.

 **Warning**

Do not put objects in the area between the outside of the seat and the door panel, since this area is required by the side airbag.

Volvo recommends the use only of car seat covers approved by Volvo. Other seat covers may impede the operation of the side airbags.

 **Warning**

Side airbags are a supplement the seatbelts. Always use a seatbelt.

Side airbags and child seats

The protection provided by the car to children seated in a child seat or on a booster cushion is not diminished by the side airbag.

3.3. Child safety

3.3.1. Mounting points for child seats

3.3.1.1. Lower mounting points for child seats

The vehicle is equipped with lower mounting points for child seats in the front seat* and the second row of seats.

The lower mounting points are designed to be used in conjunction with certain rear-facing child seats.

Always follow the manufacturer's installation instructions when connecting a child seat to the lower mounting points.

The location of the mounting points



Mounting point locations in the front seat.

The mounting points in the front seat are located on the sides of the passenger seat's legroom.

The mounting points in the front seat are only mounted if the vehicle is equipped with a switch to activate/deactivate the passenger airbag*.

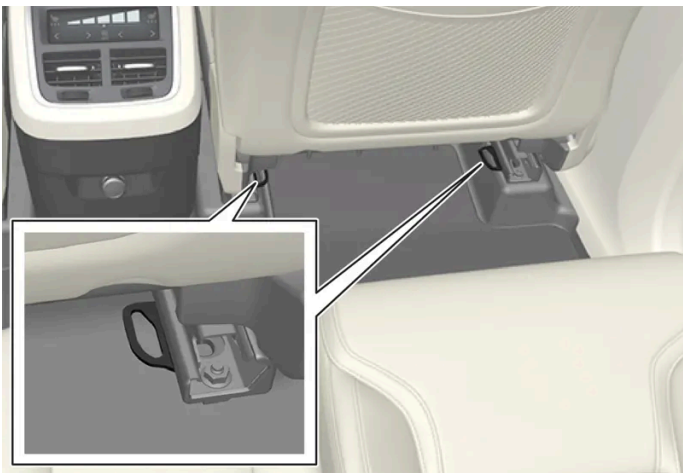

Mounting point locations in the second row of seats.

The mounting points in the second row of seats are located on the rear section of the front seat's floor rails.

* Option/accessory.

3.3.1.2. i-Size/ISOFIX mounting points for child seats

The vehicle is equipped with i-Size/ISOFIX mounting points for child seats in the second row of seats.

i-Size/ISOFIX^[1] is a fixture system for car child seats that is based on an international standard.

Always follow the manufacturer's installation instructions when connecting a child seat to the i-Size/ISOFIX mounting points.

The location of the mounting points



Mounting point locations for the second row of seats are indicated by symbols^[1] on the upholstery of the backrest.

The mounting points for i-Size/ISOFIX for the second row of seats are concealed behind the lower section of the second seat row's backrest, in the outer seats.

Press the seat cushion down to access the mounting points.

^[1] Names and symbols change depending on market.

3.3.1.3. Upper mounting points for child seats

The car is equipped with upper mounting points for child seats on the outer second row seats.

The upper mounting points are primarily intended for use with front-facing child seats.

Always follow the manufacturer's installation instructions when connecting a child seat to the upper mounting points.

The location of the mounting points

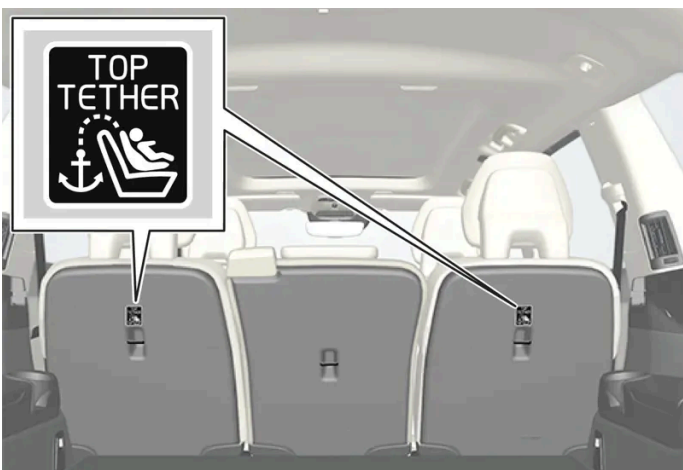

Five and seven seat variant: Mounting point locations for the second row of seats are indicated by symbols on the rear of the backrest.



Six seat variant: Mounting point locations for the second row of seats are indicated by symbols on the rear of the backrest.

The mounting points for the second row of seats are located on the rear of the outer seats in the second row seats.

 **Warning**

The child seat's upper straps must be routed through the hole in the head restraint leg before they are tensioned at the mounting point. If this is not possible, follow the recommendations from the child seat manufacturer.

 **Note**

Fold the head restraints in order to facilitate fitting this type of child seat in cars with folding head restraints on the outer seats.

 **Note**

In cars with a cargo cover over the luggage compartment, this must be removed before child seats can be attached to the securing points.

3.3.2. Integrated child seat

3.3.2.1. Integrated child seat *

The integrated child seat on the centre seat in the second seat row^[1] allows children to sit comfortably and safely.

The child seat is specially designed to provide children with good safety, together with the car's seatbelt.

The content of this manual represents the status of the user manual at the time of printing and may not be completely valid in future instances. For more information, refer to the first page for the complete disclaimer note.

The child seat is approved for children who weigh 15-36 kg (33-80 lbs) and are at least 97 cm (38 inches) tall.



Correct position, the seatbelt should be positioned in on the shoulder.

Check before driving that:

- the seat cushion is locked in position
- the head restraint is adjusted at the same height as the child's head, if possible, so that it covers the entire back of the head
- the seatbelt is in contact with the child's body and is not slack or twisted
- the seatbelt does not lie across the child's throat or below the shoulder
- the lap section of the seatbelt is positioned low over the pelvis to provide optimal protection.

 **Warning**

Volvo recommends that repair or replacement of the integrated child seat is only performed by an authorised Volvo workshop. Do not make any modifications or additions to the child seat. If an integrated child seat has been subjected to a heavy load, e.g. in connection with a collision, then the seat cushion, seatbelt and backrest, or possibly the whole seat, must be replaced. Even if the child seat appears to be undamaged, it may not afford the same level of protection. This also applies if the seat cushion was in lowered position during a collision or similar. The seat cushion must also be replaced if it is heavily worn.

 **Warning**

If the instructions for the integrated child seat are not followed then the child could sustain serious injury in the event of an accident.

* Option/accessory.

[1] Available for five and seven-seat variants.

3.3.2.2. Folding up the seat cushion in the integrated child seat*

The seat cushion should always be folded up when the integrated child seat is in use.

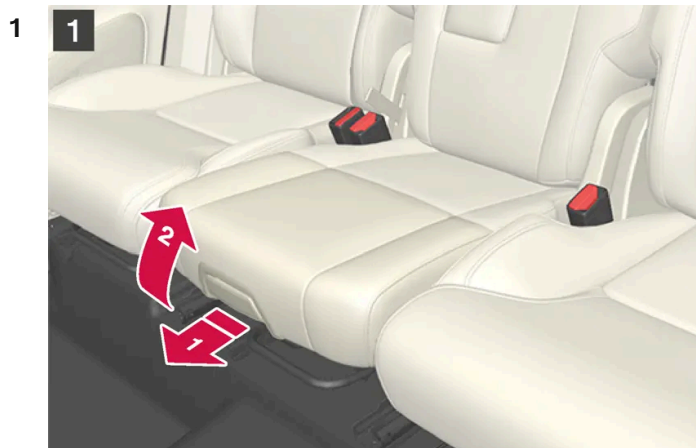

1
Pull the handle forwards and upwards to release the seat cushion.

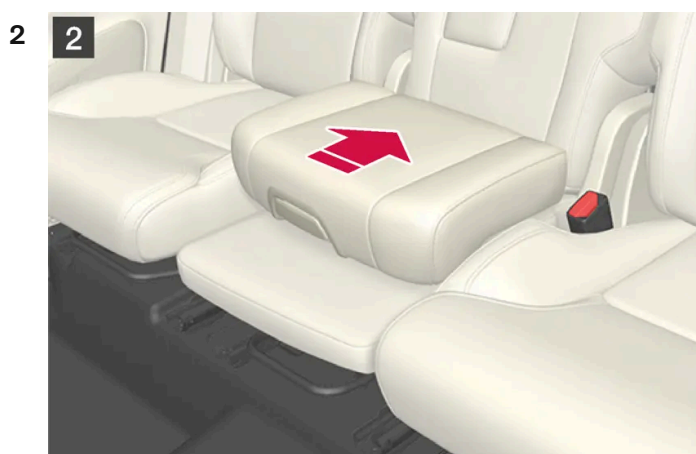

2
Press the seat cushion backwards to lock.

 **Warning**

If the instructions for the integrated child seat are not followed then the child could sustain serious injury in the event of an accident.

* Option/accessory.

3.3.2.3. Folding down the seat cushion in the integrated child seat*

The seat cushion should be folded down into the rear seat when the integrated child seat is not being used.



1
Pull the handle forwards to release the seat cushion.



2
Press down with your hand in the centre of the seat cushion in order to lock it.

! Important

Check that there are no loose objects (e.g. toys) left behind in the space under the child seat's seat cushion before lowering.

i Note

Before the rear backrest is lowered, the child seat's seat cushion must be lowered first.

* Option/accessory.

3.3.3. Child seat location

3.3.3.1. Table for location of child seats using the car's seatbelts

The table gives a recommendation for which child seats suit which locations, and for what size of child.

Note

Always read the owner's manual section on installing a child seat before installing one in the car.

Table for XC90 Recharge with five or seven seats

Weight	Front seat (with deactivated airbag, only rear-facing child seats) ^[1]	Front seat (with activated airbag, only front-facing child seats) ^[1]	Second row of seats, outer seat	Second row of seats, centre seat	Third seat row*
Group 0 max 10 kg	U ^{[2], [3]}	X	U ^[3]	L ^[3]	U
Group 0+ max 13 kg	U ^{[2], [3]}	X	U ^[3]	L ^[3]	U
Group 1 9-18 kg	L ^[4]	UF ^{[2], [5]}	U, L ^[4]	L	U
Group 2 15-25 kg	L ^[4]	UF ^{[2], [6]}	U ^[6] , L ^[4]	B*, ^[7] L ^[6]	U ^[6]
Group 3 22-36 kg	X	UF ^{[2], [6]}	U ^[6]	B*, ^[7] L ^[6]	U ^[6]

U: Suitable for universal category restraints approved for use in this mass group.

UF: Suitable for front-facing universally approved child seats.

L: Suitable for particular child restraints. These restraints may be of the specific vehicle, restricted or semi-universal categories.

B: Built-in restraint approved for this mass group.

X: The seat is not suitable for children in this mass group.

Table for XC90 Recharge with six seats

Weight	Front seat (with deactivated airbag, only rear-facing child seats) ^[1]	Front seat (with activated airbag, only front-facing child seats) ^[1]	Second seat row	Third seat row
Group 0 max 10 kg	U ^{[2], [3]}	X	U ^[3]	U

The content of this manual represents the status of the user manual at the time of printing and may not be completely valid in future instances. For more information, refer to the first page for the complete disclaimer note.

Weight	Front seat (with deactivated airbag, only rear-facing child seats) ^[1]	Front seat (with activated airbag, only front-facing child seats) ^[1]	Second seat row	Third seat row
Group 0+ max 13 kg	U ^{[2], [3]}	X	U ^[3]	U
Group 1 9-18 kg	L ^[4]	UF ^{[2], [5]}	U, L ^[4]	U
Group 2 15-25 kg	L ^[4]	UF ^{[2], [6]}	U ^{[6], L^[4]}	U ^[6]
Group 3 22-36 kg	X	UF ^{[2], [6]}	U ^[6]	U ^[6]

U: Suitable for universal category restraints approved for use in this mass group.
UF: Suitable for front-facing universally approved child seats.
L: Suitable for particular child restraints. These restraints may be of the specific vehicle, restricted or semi-universal categories.
B: Built-in restraint approved for this mass group.
X: The seat is not suitable for children in this mass group.

 **Warning**

Never use a rear-facing child seat on the front passenger seat if the passenger airbag is activated.

^[1] The seat cushion extension must always be retracted for the installation of child seats.

* Option/accessory.

^[2] Adjust the backrest to a more upright position.

^[3] Volvo recommends: Volvo infant seat (type approval E1 000008).

^[4] Volvo recommends: Volvo rear-facing seat (type approval E5 04212).

^[5] Volvo recommends rear-facing child seat for children in this mass group.

^[6] Volvo recommends: Booster cushion with and without back (type approval E5 04216); Volvo booster seat (type approval E1 04301312).

^[7] Volvo recommends: Integrated child seat (type approval E5 04218).

3.3.3.2. Child seat positioning

It is important to position the child seat in the right place in the car. The choice of location depends, amongst other things, on the type of child seat and whether the passenger airbag is activated.

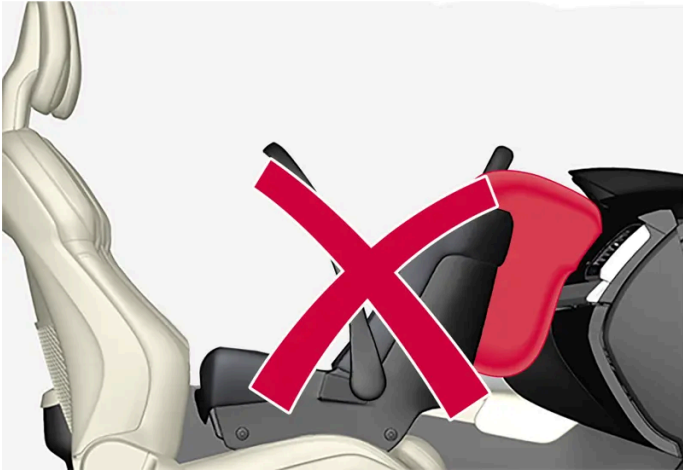

Rear-facing child seat and airbag are not compatible.

Always fit rear-facing child seats in the second or third* seat row if the passenger airbag is activated. If a child is sitting on the front passenger seat then he/she could suffer serious injury if the airbag deploys.

If the passenger airbag is deactivated then rear-facing child seats can be fitted on the front passenger seat.

i Note

Regulations regarding the placement of children in cars vary from country to country. Check what does apply.

! Warning

Never allow anybody to stand or sit in front of the front passenger seat.

Never use a rear-facing child seat on the front passenger seat if the airbag is activated.

Front-facing passengers (children and adults) must never sit on the front passenger seat if the passenger airbag is deactivated.

Failure to follow the advice given above can endanger life or lead to serious personal injury.

! Warning

NEVER use a rearward facing child restraint on a seat protected by an ACTIVE AIRBAG in front of it, DEATH or SERIOUS INJURY to the CHILD can occur.

Label for passenger airbag



Label on the passenger side's sun visor.

The warning label for the passenger airbag is positioned as shown above.

* Option/accessory.

3.3.3.3. Child seat mounting

It is important to remember a number of things when a child restraint system is mounted and used, which depend on where the child restraint system is positioned.

Warning

Booster cushions/child seats with steel braces or some other design that could rest on the seatbelt buckle's opening button must not be used, as they could cause the seatbelt buckle to open accidentally.

Do not secure the straps for the child seat into the seat's horizontal adjustment bar or in springs, rails or beams under the seat. Sharp edges may damage the straps.

Do not allow the upper section of the child seat to rest against the windscreen.

Note

When using child safety equipment, it is important to read the installation instructions included.

In the event of questions when fitting child safety equipment, contact the manufacturer for clearer instructions.

Note

Never leave a child seat loose in the car. Always secure it according to the instructions for the child seat, even when it is not in use.

i Note

Long-term installation and use of child seats may cause wear and tear on the car's fittings. Volvo recommends using the kick guard accessory to protect the car's fittings.

Installation in the front seat

- When fitting rear-facing child seats, check that the passenger airbag is deactivated.
- When fitting front-facing child seats, check that the passenger airbag is activated.
- Only use child seats that are recommended by Volvo, are universally approved or are semi-universal, and where the car is included on the manufacturer's vehicle list.
- ISOFIX child seats can only be fitted when the car is equipped with the ISOFIX console^[1] accessory.
- If the child seat is equipped with lower straps, Volvo recommends that the lower mounting points are used with these^[1].
- If the child seat is equipped with support legs, always fit the support leg/support legs directly to the floor. Never fit a support leg to a footrest or other object.
- The ISOFIX guide can be used in order to facilitate child seat installation.

Installation in the second seat row

- Only use child seats that are recommended by Volvo, are universally approved^[2] or are semi-universal, and where the car is included on the manufacturer's vehicle list.
- A child seat with support legs must not be fitted in the centre seat^[3].
- The outer seats are equipped with the ISOFIX fixture system and are approved for i-Size^[1].
- The outer seats are equipped with upper mounting points. Volvo recommends that child seat's upper straps should be pulled through the hole in the head restraint before being tensioned at the mounting point. If this is not possible, follow the recommendations from the child seat manufacturer.
- In cars with a third seat row*, the second seat row must be adjusted to its rearmost position. If a child seat is also used in the third row then an exception can be made. In which case, always check that the child seat is still fitted in accordance with the manufacturer's instructions.
- If the child seat is equipped with lower straps, never adjust the position of the seat in front after the straps have been fitted in the lower mounting points. Always remember to remove the lower straps when the child seat is not installed.
- If the child seat is equipped with support legs, always fit the support leg/support legs directly to the floor. Never fit a support leg to a footrest or other object.

- The ISOFIX guide must not be used when fitting child seats.



With the installation of an infant seat in the rear seat, Volvo recommends a distance of at least 50 mm (2 tum) from the front part of the infant seat to the rearmost part of the seat in front.

Installation in the third seat row*

- Only use child seats that are recommended by Volvo, are universally approved or are semi-universal, and where the car is included on the manufacturer's vehicle list.
- Child seats with support legs must not be fitted in the third row of seats.
- If necessary, adjust the second seat row forward in order to make enough space. If a child seat is also fitted on the second seat row, check that the child seat is still fitted in accordance with the manufacturer's instructions.

[1] Varies depending on market.

[2] Does not apply to centre seat (available in five and seven-seat variants).

[3] Available for five and seven-seat variants.

* Option/accessory.

3.3.3.4. Table for location of ISOFIX child seats

The table gives a recommendation for which ISOFIX child seats suit which locations, and for what size of child.

The child seat must be approved in accordance with UN Reg R44 and the car model must be included in the manufacturer's vehicle list.

Note

Always read the owner's manual section on installing a child seat before installing one in the car.

Table for XC90 Recharge with five or seven seats

The content of this manual represents the status of the user manual at the time of printing and may not be completely valid in future instances. For more information, refer to the first page for the complete disclaimer note.

Weight	Size class ^[1]	Type of child seat	Front seat (with deactivated airbag, only rear-facing child seats) ^{[2], [3]}	Front seat (with activated airbag, only front-facing child seats) ^{[2], [3]}	Second row of seats, outer seat	Second row of seats, centre seat	Third seat row*
Group 0 max 10 kg	E	Rear-facing infant seat	IL ^{[2], [4]} , X ^[5]	X	IL ^[4]	X	X
Group 0+ max 13 kg	E	Rear-facing infant seat	IL ^{[2], [4]} , X ^[5]	X	IL ^[4]	X	X
	C	Rear-facing child seat					
	D	Rear-facing child seat					
Group 1 9-18 kg	A	Front-facing child seat	X	IL ^{[2], [6]} , X ^[5]	IL ^[6] , IUF ^[6]	X	X
	B	Front-facing child seat					
	B1	Front-facing child seat					
	C	Rear-facing child seat	IL ^[2] , X ^[5]	X	IL ^[7]	X	X
	D	Rear-facing child seat					

IL: Suitable for particular ISOFIX child restraint systems. These child restraint systems are those of the specific vehicle, restricted or semi-universal categories.
IUF: Suitable for ISOFIX forward child restraint systems of universal category approved for use in the mass group.
X: Not suitable for ISOFIX child restraint systems.

Table for XC90 Recharge with six seats

Weight	Size class ^[1]	Type of child seat	Front seat (with deactivated airbag, only rear-facing child seats) ^{[2], [3]}	Front seat (with activated airbag, only front-facing child seats) ^{[2], [3]}	Second seat row	Third seat row
Group 0 max 10 kg	E	Rear-facing infant seat	IL ^{[2], [4]} , X ^[5]	X	IL ^[4]	X
Group 0+ max 13 kg	E	Rear-facing infant seat	IL ^{[2], [4]} , X ^[5]	X	IL ^[4]	X
	C	Rear-facing child seat				
	D	Rear-facing child seat				
Group 1 9-18 kg	A	Front-facing child seat	X	IL ^{[2], [6]} , X ^[5]	IL ^[6] , IUF ^[6]	X
	B	Front-facing child seat				
	B1	Front-facing child seat				
	C	Rear-facing child seat	IL ^[2] , X ^[5]	X	IL ^[7]	X
	D	Rear-facing child seat				

IL: Suitable for particular ISOFIX child restraint systems. These child restraint systems are those of the specific vehicle, restricted or semi-universal categories.
IUF: Suitable for ISOFIX forward child restraint systems of universal category approved for use in the mass group.
X: Not suitable for ISOFIX child restraint systems.

 **Warning**

Never use a rear-facing child seat on the front passenger seat if the passenger airbag is activated.

 **Note**

If an i-Size/ISOFIX child seat has no size classification, the car model must be included on the vehicle list for the child seat.

 **Note**

Volvo recommends contacting an authorised Volvo dealer for information about which i-Size/ISOFIX child seats Volvo recommends.

[1] For child seats with the ISOFIX fixture system there is a size classification to help users choose the right type of child seat. The size class can be read on the child seat's label.

[2] Works for the installation of ISOFIX child seats that are semi-universally approved (IL) if the car is equipped with the ISOFIX console accessory (the accessory range varies depending on market). There are no upper mounting points for child seats here.

[3] The seat cushion extension must always be retracted for the installation of child seats.

* Option/accessory.

[4] Volvo recommends: Volvo infant seat secured using the ISOFIX fixture system (type approval E1 000008).

[5] Applicable if the car is not fitted with an ISOFIX bracket.

[6] Volvo recommends rear-facing child seat for children in this mass group.

[7] Volvo recommends: BeSafe iZi Kid X3 ISOfix (type approval E5 04200).

3.3.3.5. Table for location of i-Size child seats

The table gives a recommendation for which i-Size child seats suit which locations, and for what size of child.

The child seat must be approved in accordance with UN Reg R129.

 **Note**

Always read the owner's manual section on installing a child seat before installing one in the car.

Table for XC90 Recharge with five or seven seats

Type of child seat	Front seat (with deactivated airbag, only rear-facing child seats)	Front seat (with activated airbag, only front-facing child seats)	Second row of seats, outer seat	Second row of seats, centre seat	Third seat row*
--------------------	--	---	---------------------------------	----------------------------------	-----------------

Type of child seat	Front seat (with deactivated airbag, only rear-facing child seats)	Front seat (with activated airbag, only front-facing child seats)	Second row of seats, outer seat	Second row of seats, centre seat	Third seat row*
i-Size child seats	X	X	i-U ^[1]	X	X

i-U: Suitable for i-Size "universal" child seat, front-facing and rear-facing.
X: Not suitable for universally approved child seats.

Table for XC90 Recharge with six seats					
Type of child seat	Front seat (with deactivated airbag, only rear-facing child seats)	Front seat (with activated airbag, only front-facing child seats)	Second seat row	Third seat row	
i-Size child seats	X	X	i-U ^[1]	X	

i-U: Suitable for i-Size "universal" child seat, front-facing and rear-facing.
X: Not suitable for universally approved child seats.

* Option/accessory.

^[1] Volvo recommends that children travel in a rear-facing child seat until as late an age as possible, at least until 4 years of age.

3.3.4. Activating and deactivating child safety locks

The child safety lock prevents the rear doors from being opened from inside. With electric child safety locks, power window operation from the rear seat is also prevented.

The child lock can be either manual or electrical*.

Manual child lock

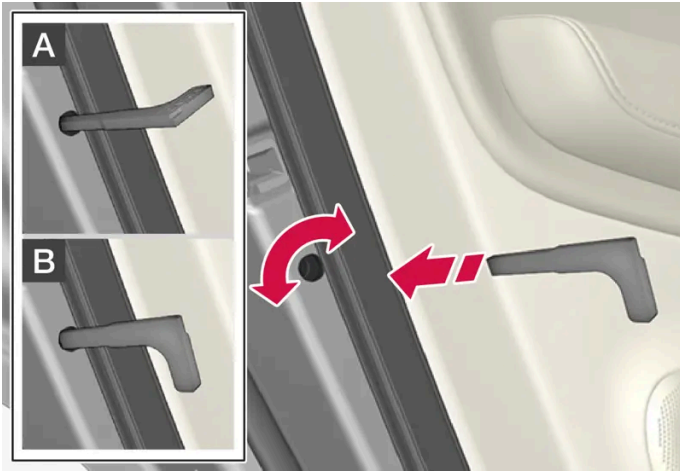

Manual child lock. Not to be confused with manual door locks.

- 1 Use the remote control key's detachable key blade to turn the knob.

A The door is blocked against opening from the inside.

B The door can be opened from both the outside and the inside.

i Note

- A door's knob control only blocks that particular door - not both rear doors simultaneously.
- Cars with an electric child safety lock do not have a manual child lock.

Electric child lock*

The electric child lock can be activated and deactivated in all ignition positions above **0**. Activation and deactivation can be performed up to 2 minutes after switching off the car, provided that no door is opened.



Activation and deactivation button.

Rear child safety lock enabled

When the lamp in the button is illuminated, the child safety lock is enabled.

If the child lock is activated when the car is switched off, it will remain activated the next time the car is started.

- Rear doors cannot be opened from the inside.
- Rear power windows can only be operated from the driver's door.

Rear child safety lock disabled

When the lamp in the button is extinguished, the child safety lock is inactivated.

- Rear doors can be opened from the inside and power windows operated from the rear seat.

Symbols and messages

Symbol	Message	Specification
	Rear child lock Activated	The child lock is activated.
	Rear child lock Deactivated	The child lock is deactivated.

* Option/accessory.

3.3.5. Child safety

Children must always sit secure while travelling in the car.

Volvo has child safety equipment (child seats and attachment devices) which is designed for fitting in this particular car. Using Volvo's child safety equipment, you obtain good conditions for a child to travel safely in the car. In addition, the child safety equipment fits in well and is simple to use.

The equipment that should be used is selected taking account of the weight and size of the child.

Volvo recommends that children travel in a rear-facing child seat until as late an age as possible, at least until 4 years of age, and then in a front-facing child seat until the child is 140 cm (4 feet 7 inches) tall.

Note

Legal provisions about the type of child seat that must be used for children of different ages and heights vary from country to country. Check what does apply.

i Note

When using child safety equipment, it is important to read the installation instructions included.

In the event of questions when fitting child safety equipment, contact the manufacturer for clearer instructions.

Children of all ages and sizes must always sit correctly secured in the car. Never allow a child to sit on the knee of a passenger.

3.3.6. Child seats

Suitable child seats should always be used when children are travelling in the car.

Children should sit comfortably and safely. Make sure that the child seat is positioned, mounted and used correctly.

Look in the installation instructions for the child seat for the correct fitting.

i Note

When using child safety equipment, it is important to read the installation instructions included.

In the event of questions when fitting child safety equipment, contact the manufacturer for clearer instructions.

i Note

Never leave a child seat loose in the car. Always secure it according to the instructions for the child seat, even when it is not in use.

i Note

Long-term installation and use of child seats may cause wear and tear on the car's fittings. Volvo recommends using the kick guard accessory to protect the car's fittings.

3.3.7. Type lists for Volvo's child restraint systems

The type lists contain information about which car models and seating positions in the car that the child restraint systems are approved for.

Type lists for Volvo's semi-universal child restraint systems approved in accordance with UN R44

A number of child restraint systems are what is known as semi-universally approved in accordance with UN regulation 44-04. This means that they are approved for use in certain car models and on certain seats as prescribed. Information about the car

models and which of the seats in the car are suitable is available in a type list that is included with the child restraint system. The type list is updated continuously as new car models come out on the market. You can find the latest version of the list in the links below.

- [Volvo Infant seat ISOFIX base/BABY-SAFE ISOFIX BASE \[https://az685612.vo.msecnd.net/pdfs/19w11-childseats/19-01-09_infant_seat_ISOFIX_base_International.pdf\]](https://az685612.vo.msecnd.net/pdfs/19w11-childseats/19-01-09_infant_seat_ISOFIX_base_International.pdf)
- [Volvo Rearward facing child seat/MAX-WAY \[https://az685612.vo.msecnd.net/pdfs/19w11-childseats/19-01-11_rearward_facing_international.pdf\]](https://az685612.vo.msecnd.net/pdfs/19w11-childseats/19-01-11_rearward_facing_international.pdf)
- [Volvo Booster seat/KIDFIX SL \[https://az685612.vo.msecnd.net/pdfs/19w11-childseats/19-01-11_booster_seat_International.pdf\]](https://az685612.vo.msecnd.net/pdfs/19w11-childseats/19-01-11_booster_seat_International.pdf)

Type list for Volvo's child restraint system approved according to UN R129 (i-Size)

i-Size has been part of the new regulation since 2013 (UN R129) which includes child restraint systems installed with ISOFIX. i-Size means fewer installation options for child restraint systems and reduced risk of incorrect installation. An i-Size approved child restraint system ensures that the restraint system can be used universally in cars with i-Size approved seat positions. Information about the car models and which of the seats in the car are suitable is available in a type list that is included with the child restraint system. The type list is updated continuously as new car models come out on the market. You can find the latest version of the list in the link below.

- [Volvo Easy access rearward facing i-Size/SWINGFIX I-SIZE \[https://az685612.vo.msecnd.net/pdfs/certificates/NOTE-PROD-32204750-02-1.pdf\]](https://az685612.vo.msecnd.net/pdfs/certificates/NOTE-PROD-32204750-02-1.pdf)



3.3.8. Activating and deactivating passenger airbag*

The passenger airbag can be deactivated if the car is equipped with a switch, Passenger Airbag Cut Off Switch (PACOS).

The content of this manual represents the status of the user manual at the time of printing and may not be completely valid in future instances. For more information, refer to the first page for the complete disclaimer note.

The switch for the passenger airbag is located on the passenger end of the instrument panel and is accessible when the passenger door is open.

Check that the switch is in the required position.

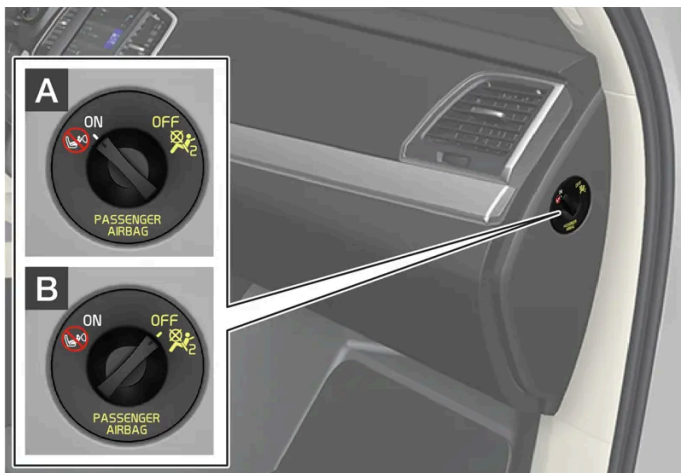

A ON - the airbag is activated and all front-facing passengers (children and adults) can sit safely on the passenger seat.

B OFF - The airbag is deactivated and children in rear-facing child seats can sit safely on the passenger seat.

 **Warning**

If the car is not equipped with a switch to activate/deactivate the passenger airbag, the airbag will always be activated.

Activating passenger airbag



1

Pull the switch outward and turn from OFF to ON.

➤ The driver display shows the message **Passenger airbag on Please acknowledge.**

Note

If the passenger airbag has been activated/deactivated with the car in ignition position I or lower, a message is shown in the driver display and the following indicator in the roof console approx. 6 seconds after the car's electrical system has been set in ignition position II.

- 2 Confirm the message by pressing the right-hand steering wheel keypad's **O** button.



- A text message and a warning symbol in the roof console indicate that the airbag for the front passenger seat is activated.

Warning

Never use a rear-facing child seat on the front passenger seat when the airbag is activated.

The passenger airbag must always be activated when front-facing passengers (children and adults) are sitting in the front passenger seat.

Failure to follow the advice given above can endanger life or lead to serious personal injury.

Deactivating passenger airbag



1

Pull the switch outward and turn from ON to OFF.

- The driver display shows the message **Passenger airbag off Please acknowledge**.

Note

If the passenger airbag has been activated/deactivated with the car in ignition position I or lower, a message is shown in the driver display and the following indicator in the roof console approx. 6 seconds after the car's electrical system has been set in ignition position II.

- 2 Confirm the message by pressing the right-hand steering wheel keypad's **O** button.



- A text message and a symbol in the roof console indicate that the airbag for the front passenger seat is deactivated.

Warning

Front-facing passengers (children and adults) must never sit on the passenger seat when the airbag is deactivated. Failure to follow the advice given above can endanger life or lead to serious personal injury.

Important

If the passenger airbag is deactivated, the electric seatbelt tensioner on the passenger side will also be deactivated.

* Option/accessory.

3.4. Safety mode

3.4.1. Traffic accident

If your car is involved in a traffic accident, activate the hazard warning flashers and move the car into a safer position if possible.

The content of this manual represents the status of the user manual at the time of printing and may not be completely valid in future instances. For more information, refer to the first page for the complete disclaimer note.

Do not attempt to restart the car if there is a smell of fuel when the driver display shows the message **Safety mode See Owner's manual**. If so, leave the car at once!

Call the emergency services or roadside assistance as necessary.

Depending on the car's equipment, the car itself can detect an accident and contact the nearest emergency call centre. If the car does not have Volvo On Call*, there is a European legal requirement, Pan-European eCall, that provides access to an automatic collision alarm and urgent assistance in emergency situations^[1].

- Think about safety when exiting the car!
- Use a reflective vest and position the warning triangle so that other road users are warned.

If you collide with a wild animal

Be careful, injured animals can feel trapped and then defend themselves.

Call the police to get help with humane killing if the animal is seriously injured, or move a dead animal away from the road so that it is not a danger to other road users.

* Option/accessory.

^[1] Applies to certain markets.

3.4.2. Safety mode

Safety mode is a protective state that is triggered when a collision may have damaged any of the car's vital functions, such as the fuel lines, sensors for any of the safety systems, or the brake system.

If the car has been in a collision, the message **Safety mode See Owner's manual** may be shown on the driver display with a warning symbol as long as the display is not damaged and the car's electrical system is still in working order. This message means that the car has reduced functionality.

Warning

Never, under any circumstances, attempt to restart the car if it smells of fuel when the **Safety mode See Owner's manual** message is shown in the driver display. Leave the car at once.

If the car is in safety mode, it is possible to attempt to reset the system in order to start and move the car for a short distance, if in a dangerous traffic situation for example.

Warning

Never attempt to repair your car or reset the electronics yourself if the car has been in safety mode. This could result in personal injury or the car not functioning as normal. Volvo recommends engaging an authorised Volvo workshop to check and restore the car to normal status after **Safety mode See Owner's manual** has been shown.

 **Warning**

If the car is in safety mode it must not be towed. It must be transported from its location. Volvo recommends that it is transported to an authorised Volvo workshop.

3.4.3. Starting and moving the car after safety mode

If the car is in safety mode, it is possible to attempt to reset the system in order to start and move the car for a short distance, if in a dangerous traffic situation for example.

Reset and start the car after safety mode

- 1 Check the general damage situation of the car and whether any fuel has been leaking. There must be no smell of fuel either.

If there is only minor damage and a check has revealed no fuel leaks, starting can be attempted.

 **Warning**

Never, under any circumstances, attempt to restart the car if it smells of fuel when the **Safety mode See Owner's manual** message is shown in the driver display. Leave the car at once.

- 2 Switch off the car.
- 3 Then try to start the car.
 - The car's electronics carry out a systems check and then try to resume normal status. The driver display shows the message **Car start System check, wait** during this time. This can take up to one minute.
- 4 Then try to start the car again when the message **Car start System check, wait** is no longer shown in the driver's display.

 **Important**

If the message **Safety mode See Owner's manual** is still shown on the display the car must not be driven or towed but a vehicle recovery service must then be used instead. Even if the car appears to be driveable, hidden damage may make the car impossible to control once moving.

Moving the car after safety mode

- 1 If the driver display shows the message **Normal mode The car is now in normal mode** after a start attempt, the car can be carefully moved if standing in a dangerous position.

- 2 Do not move the car further than necessary.

 **Warning**

If the car is in safety mode it must not be towed. It must be transported from its location. Volvo recommends that it is transported to an authorised Volvo workshop.

3.5. Safety

The vehicle is equipped with several safety systems that work together to protect the vehicle's driver and passengers in the event of an accident.

The car is equipped with a number of sensors that react in the event of an accident and activate different safety systems, such as different types of airbags and seatbelt tensioners. Depending on the specific accident situation, such as collisions at different angles, roll-over or driving off the road, the systems react in different ways to provide good protection.

There are also mechanical safety systems such as Whiplash Protection System. The car is also constructed so that a large part of the force of a collision is distributed to beams, pillars, floor, roof and other parts of the body.

The car's safety mode may be activated after a collision if an important function in the car has been damaged.

Warning symbol in driver display



The warning symbol is illuminated in the driver display when the car's electrical system is set in ignition position **II**. The symbol is extinguished after approx. 6 seconds if the car's safety system is fault-free.

 **Warning**

If the warning symbol remains illuminated or is switched on during driving and the message **SRS airbag Service urgent Drive to workshop** is shown in the driver display, it means that part of one of the safety systems does not have full functionality. Volvo recommends that an authorised Volvo workshop should be contacted as soon as possible.

 **Warning**

Never modify or repair the car's various safety systems yourself. Defective work in one of the systems can cause malfunction and result in serious personal injury. Volvo recommends that an authorised Volvo workshop should be contacted.



If the specific warning symbol is broken then the general warning symbol is illuminated instead and the driver display shows the same message.

3.6. Safety during pregnancy

It is important that the seatbelt is used correctly during pregnancy, and that pregnant drivers adjust their seating position.

Seatbelt

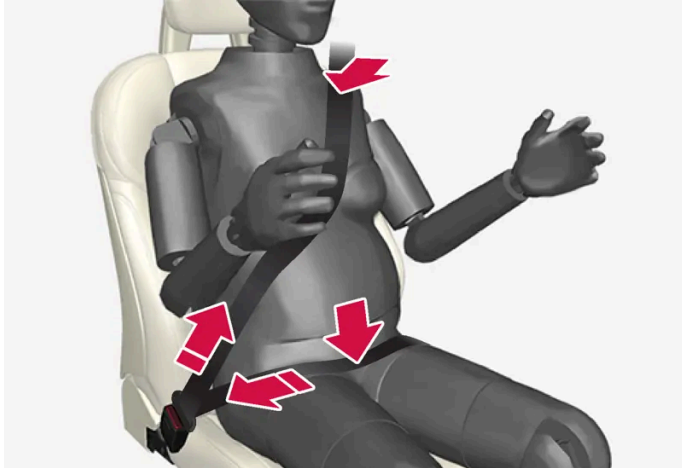

The diagonal section should wrap over the shoulder then be routed between the breasts and to the side of the abdomen.

The lap section should lay flat over the thighs and as low as possible under the abdomen. – It must never be allowed to ride upward. Remove the slack from the seatbelt and ensure that it fits as close to the body as possible. In addition, check that there are no twists in the seatbelt.

Seating position

As the pregnancy progresses, pregnant drivers must adjust the seat and steering wheel such that they can easily maintain control of the vehicle as they drive (which means that they must be able to easily operate the foot pedals and steering wheel). The aim should be to position the seat with as large a distance as possible between abdomen and steering wheel.

3.7. Whiplash Protection System

Whiplash Protection System (WHIPS) reduces the risk of whiplash injuries. The system consists of energy absorbing backrests and seat cushion, as well as a specially designed head restraint in the front seats.

WHIPS is deployed in the event of a rear-end collision, where the angle and speed of the collision and the nature of the colliding vehicle all have an influence.

When WHIPS is deployed, the front seat backrests are lowered backward and the seat cushions move downward to change the seating position of the driver and front seat passenger. Its movement helps to absorb some of the forces that can arise and cause whiplash.

 **Warning**

WHIPS is a supplement to the seatbelts. Always use a seatbelt.

 **Warning**

Never modify or repair the seat or WHIPS yourself. Volvo recommends that an authorised Volvo workshop should be contacted.

If the front seats have been subjected to a major load, such as in conjunction with a collision, the seats must be replaced. Some of the seats' protective properties may have been lost even if they do not appear damaged.

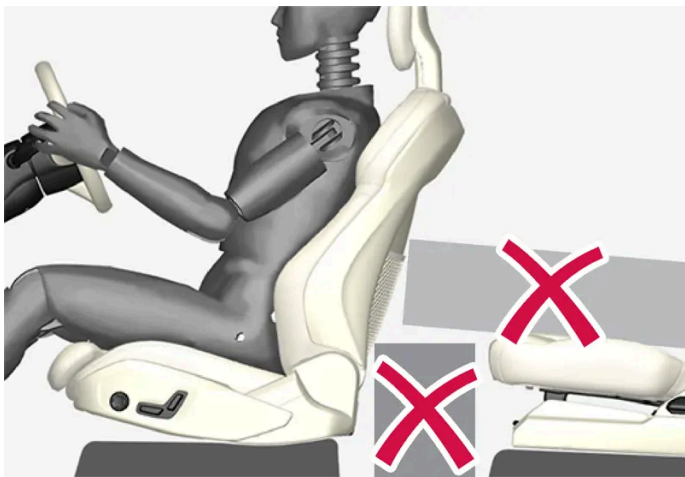

Do not leave any objects on the floor behind or under the front seats or in the rear seat that may prevent WHIPS from functioning.

 **Warning**

Do not squeeze rigid objects between the rear seat cushion and the front seat's backrest.

If a backrest in the rear seat is lowered then any load must be secured to prevent it from sliding up to the front seat backrest in the event of a collision.

 **Warning**

If a backrest in the rear seat is lowered or a rear-facing child seat is used in the rear seat, the corresponding front seat must be moved forward so that it does not make contact with the lowered backrest or child seat.

Seating position

For good protection from WHIPS the driver and passenger must have the correct seating position and make sure that the system's function is not obstructed.

Set the correct seating position in the front seat before driving starts.

Driver and front seat passenger should sit in the centre of the seat with as little space as possible between the head and the head restraint.

WHIPS and child seats

The protection provided by the car to children seated in a child seat or on a booster cushion is not diminished by WHIPS.

4. Displays and voice control

4.1. Driver display

4.1.1. Gauges and indicators in driver display

4.1.1.1. Fuel gauge

The fuel gauge in the driver display shows the fuel level in the tank.

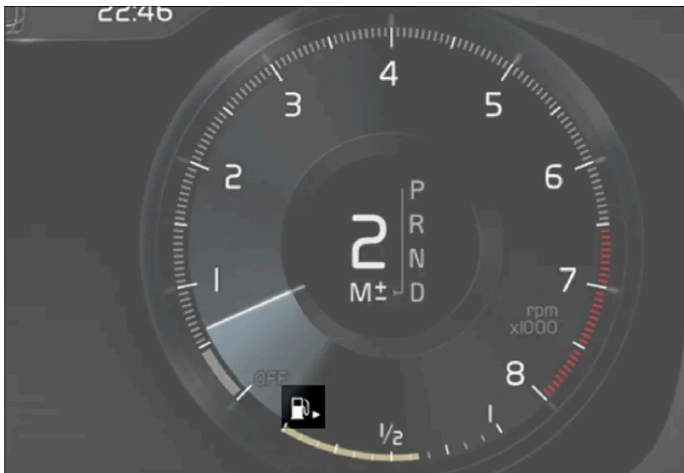

The figure is schematic - parts may vary depending on car model.

The beige zone in the fuel gauge indicates the quantity of fuel in the tank.

When the fuel level is low, the fuel pump symbol illuminates and turns amber colour. The trip computer also shows the distance to empty tank.

4.1.1.2. Hybrid battery gauge



The hybrid battery gauge shows how much energy there is in the hybrid battery.



The energy in the hybrid battery is used for the electric motor, but also to cool or heat the car. The trip computer calculates an approximate distance for the energy left in the hybrid battery.

Symbols in the hybrid battery gauge



The  symbol in the hybrid battery gauge indicates that the Hold function is activated, and the  symbol indicates that the Charge function is activated.

4.1.1.3. Hybrid gauge

In drive modes Hybrid and Pure, the driver display shows a hybrid gauge that can help the driver to drive the car in a more energy-efficient way.



The hybrid gauge shows in different ways the relationship between how much power is being taken from the electric motor and how much power is available.

Symbols in the hybrid gauge



Indicates current level for available electric motor power. If the symbol is filled in, it means that the electric motor is in use.



If the symbol is not filled in, it means that the electric motor is not in use.



Indicates the power level when the combustion engine starts. If the symbol is filled in, it means that the combustion engine is in use.



Indicates the power level when the internal combustion engine is due to start. If the symbol is not filled in, it means that the combustion engine is not in use.



Indicator that shows that the hybrid battery is being charged e.g. if the brake pedal is gently depressed.

Driver-requested power

The pointer in the hybrid gauge indicates the amount of engine power requested by the driver by regulating the accelerator pedal. The higher the reading on the scale, the more power is requested by the driver in the current gear. The marker between the lightning flash and the drop shows the point at which the internal combustion engine starts.

Example:



The car is started but stationary, no power is requested.

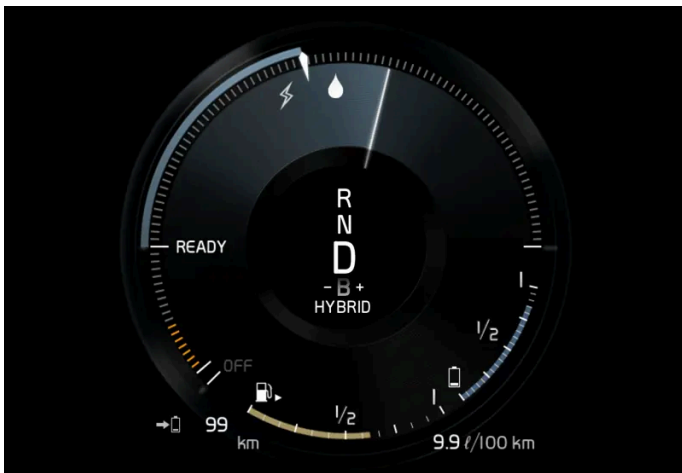

The electric motor cannot supply the amount of engine power requested and the internal combustion engine starts.

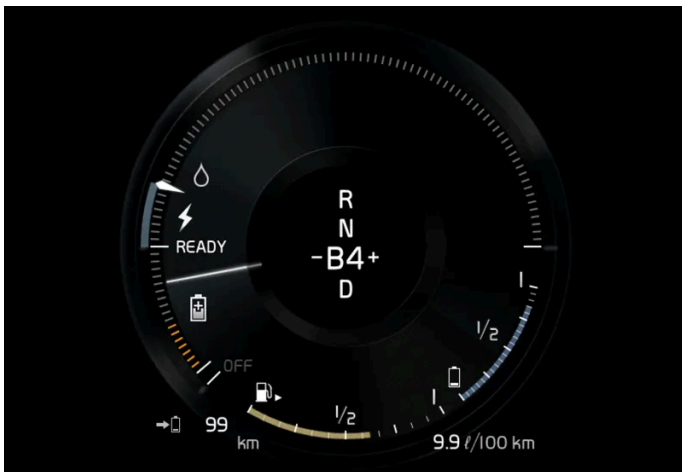

The car generates current to the battery, the battery is charged, e.g. when the brake pedal is pressed lightly or during engine braking down a hill.

4.1.1.4. Outside temperature gauge

The outside temperature is shown in the driver display.

The content of this manual represents the status of the user manual at the time of printing and may not be completely valid in future instances. For more information, refer to the first page for the complete disclaimer note.

A sensor detects the temperature outside of the car.



If the car has been stationary, the gauge may display a temperature reading that is too high.



When the outside temperature is in the range -5°C to $+2^{\circ}\text{C}$ (23°F to 36°F), a snowflake symbol lights up that warns of potentially slippery conditions.

The symbol is also illuminated briefly in the head-up display*, if the car is equipped with one.

Change the unit for the temperature gauge, etc. via system settings in the centre display's top view.

* Option/accessory.

4.1.1.5. Gear shift indicator

The gear shift indicator in the driver display shows the current gear during manual gearshifting and when it is appropriate to engage the next gear for optimum fuel economy.

For eco-driving during manual gear changing, it is important to drive in the right gear and to change gear in good time.



Gear shift indicator in the driver display^[1].

The gear shift indicator is shown in gear position B. The gear shift indicator shows the current gear in the driver display and indicates recommended shifting to a higher gear by a flashing plus sign.

[1] The figure is schematic – parts may vary depending on car model.

4.1.2. Trip computer

4.1.2.1. Trip computer

The car's trip computer records vales such as e.g. distance, fuel consumption and average speed whilst driving.

In order to facilitate fuel-efficient driving, information is recorded about both instantaneous and average fuel consumption. The information from the trip computer can be shown in the driver display.

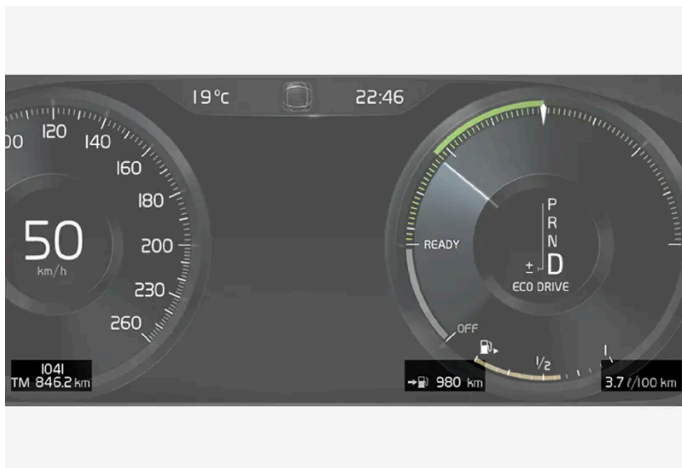

Examples of trip computer information in the driver display. The figure is schematic - parts may vary depending on car model.

The following meters are included in the trip computer:

- Trip meter
- Odometer
- Instantaneous fuel consumption
- Distance to empty tank
- Distance to empty battery
- Tourist - alternative speedometer

Units for distance, speed, etc. can be changed via system settings in the centre display.

Trip meter

The content of this manual represents the status of the user manual at the time of printing and may not be completely valid in future instances. For more information, refer to the first page for the complete disclaimer note.

There are two trip meters, TM and TA.

TM can be reset manually and TA is reset automatically if the car is not used for at least four hours.

The following information is registered while driving:

- Mileage
- Driving time
- Average speed
- Average fuel consumption

The values apply from the trip meter's latest reset.

Odometer

The odometer records the car's total mileage. This value cannot be reset to zero.

Instantaneous fuel consumption

This gauge shows the fuel consumption that the car has at the moment. The value is updated approximately every second.

Distance to empty tank

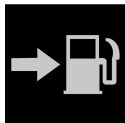

The trip computer calculates the remaining mileage with the fuel available in the tank.

The calculation is based on the average fuel consumption over the last 30 km (20 miles) and the remaining drivable fuel quantity.

When the gauge shows "----", there is not enough fuel left to be able to calculate the remaining mileage. Refuel as soon as possible.

Note

There may be a slight deviation if the driving style has been changed.

An economic driving style generally results in a longer driving distance.

Distance to empty battery

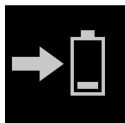

The approximate distance that can be driven with the remaining amount of energy in the hybrid battery is indicated adjacent to this symbol.

The calculation is based on the average consumption of normally loaded vehicle, during normal driving and taking into account whether the air conditioning (AC) is switched on or off. When changing between the **Hybrid** and **Pure** drive modes, the calculated distance increases since the **Pure** mode has reduced climate settings (ECO climate).

No guaranteed range on electric power remains when the gauge shows "----".

The content of this manual represents the status of the user manual at the time of printing and may not be completely valid in future instances. For more information, refer to the first page for the complete disclaimer note.

 **Note**

There may be a slight deviation if the driving style has been changed.

An economic driving style generally results in a longer driving distance.

Start value for fully charged hybrid battery

Since it is difficult to anticipate driving style and other factors that affect the range for electric operation, Volvo has decided to use a start value when the car is fully charged. The start value indicates an up-to figure instead of a forecast for the range for electric operation. The difference in start value between **Hybrid** and **Pure** is due to the car being allowed to use more energy from the hybrid battery in **Pure** mode, as well as that the car changes over to ECO climate.

Mileage for electric operation

In order to achieve the longest possible mileage for electric operation, the driver of an electrically powered car also has to think about energy conservation. The more consumers there are (stereo, electric heating in windows/mirrors/seats, very cold air from the climate control system, etc.) that are active - the shorter the potential mileage.

 **Note**

In addition to high current take-off in the passenger compartment, sudden acceleration and braking, high speed, heavy loads, low outside temperature and uphill gradients also reduce the possible driving distance.

Tourist - alternative speedometer

The alternative digital speedometer makes it easier to drive in countries where speed limit signs are in a different unit than that shown in the car's instruments.

The digital speed is then shown in the opposite unit to that shown in the analogue speedometer. If the analogue speedometer is graduated in mph, the digital speedometer shows the corresponding speed in km/h and vice versa.

4.1.2.2. Show trip data in driver display

The trip computer's recorded and calculated values can be shown in the driver display.

The values are saved in a trip computer app. Via the app menu, you can choose which information is shown on the driver

display.



Open and navigate in the app menu^[1] using the right-hand steering wheel keypad.

- 1 App menu
- 2 Left/right
- 3 Up/down
- 4 Confirm

1 Open the app menu in the driver display by pressing (1).

(It is not possible to open the app menu while there is an unacknowledged message in the driver display. The message first has to be confirmed by pressing the  button (4) before the app menu can be opened.)

2 Navigate to the trip computer app to left or right with (2).

➤ The top four menu rows show measured values for trip meter TM. The next four menu rows show measured values for trip meter TA. Scroll up or down in the list with (3).

3 Scroll down to the option buttons to select which information to show in the driver display:

- Odometer
- Distance to empty tank
- Distance to empty battery
- Tourist (alternative speedometer)
- Mileage for trip meter TM, TA, or no display of mileage
- Instantaneous fuel consumption, average consumption for TM or TA, alternatively, no display of fuel consumption

Select or deselect an option with the  button (4). The change is made immediately.

^[1] The figure is schematic - parts may vary depending on car model.

4.1.2.3. Resetting the trip meter

Reset the trip meter using the left-hand stalk switch.



- 1 Reset all information in trip meter TM (i.e. mileage, average consumption, average speed and driving time) with a long press on the RESET button on the left-hand stalk switch.

Pressing the RESET button resets only the mileage.

The trip meter TA can only be reset automatically when the car has not been used for four or more hours.

4.1.2.4. Show trip statistics in centre display

Trip statistics from the trip computer are displayed graphically in the centre display and provide an overview that facilitates more fuel-efficient driving.



Open the **Driver performance** app in app view in order to show the trip statistics.

Each bar in the diagram symbolises a distance of 1, 10 or 100 km, alternatively miles. The bars are filled in from the right as driving progresses. The bar on the far right shows the value for the current distance.

The average fuel consumption and total driving time are calculated since the last time the trip statistics were reset.

Fuel and electricity consumption are shown in separate graphs. Electricity consumption is "net" consumption, i.e. energy consumed minus regenerated energy created during braking.

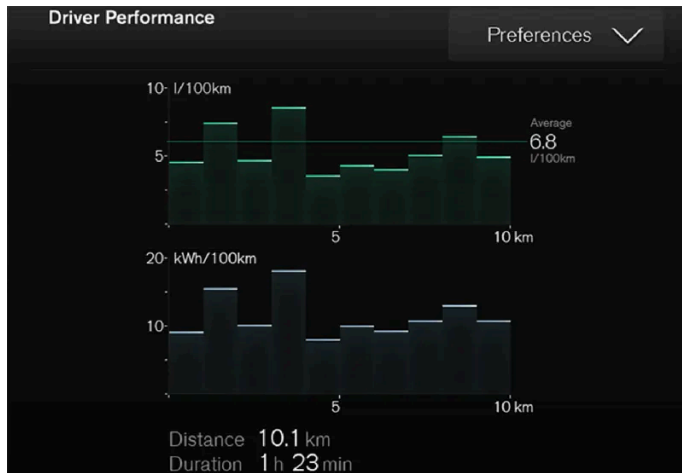

Trip statistics from the trip computer^[1].

Note

When driving with electric operation, fuel consumption can be indicated in the trip statistics if the additional heater^[2] is running.

^[1] The figure is schematic - parts may vary depending on car model.

^[2] Applicable to fuel-driven auxiliary heater.

4.1.2.5. Settings for trip statistics

Reset or adjust settings for trip statistics.

- 1 Open the **Driver performance** app in app view in order to show the trip statistics.



- 2 Press **Preferences** to

- change graph scale. Select resolution 1, 10 or 100 km/miles for the bar.
- reset data after every trip. Performed when the car has been stationary for more than 4 hours.
- reset data for the current trip.

Trip statistics, calculated average consumption and total driving time are always reset simultaneously.

Units for distance, speed, etc. can be changed via system settings in the centre display.

4.1.3. Driver display

The driver display shows information about the car and driving.

The driver display contains gauges, indicators and indicator and warning symbols. The content of the driver display depends on the car's equipment, settings and which functions are active at that time.

The driver display is activated as soon as a door is opened, i.e. in ignition position 0. The driver display extinguishes after a while if it is not used. To reactivate it, proceed with one of the following:

- Activate ignition position I.
- Open one of the doors.

Warning

If the driver display should extinguish, not illuminate on activation/start or be fully or partially illegible, the car must not be used. You should visit a workshop immediately. Volvo recommends an authorised Volvo workshop.

Warning

In the event of a fault in the driver display the information on e.g. brakes, airbags or other safety systems may not be shown. In which case, the driver cannot check the status of the car's systems or receive current warnings and information.



The figure is schematic - parts may vary depending on car model.

Location in the driver display:		
On the left	In the middle	On the right
Speedometer	Indicator and warning symbols	Tachometer/Hybrid gauge ^[1]
Trip meter	Outside temperature gauge	Gear shift indicator
Odometer ^[2]	Clock	Drive mode
Cruise control and speed limiter information	Messages, in some cases with graphics	Fuel gauge
Road Sign Information*	Door and seatbelt information	Hybrid battery gauge
-	Charging status	Distance to empty tank
-	Media player	Distance to empty battery
-	Navigation map*	Instantaneous fuel consumption
-	Phone	App menu (activated via steering wheel keypad)
-	Voice control	-
-	Compass ^[1]	-

Dynamic symbol



The dynamic symbol in its basic form.

The centre of the driver display contains a dynamic symbol that changes appearance for different types of message. An amber or red marker around the symbol indicates the degree of severity of a control or warning message.



Examples of indicator symbol.

With an animation, the basic shape can be turned into a graphic showing where a problem is situated, or in order to clarify information.



The symbol in the driver display changes shape.

^[1] Depends on drive mode selected.

^[2] Accumulated mileage.

* Option/accessory.

4.1.4. Driver display settings

Settings for the driver display's display options can be made via the driver display's app menu and via the centre display's settings menu.

Settings via the driver display's app menu



The figure is schematic - parts may vary depending on car model.

The app menu is opened and controlled using the right-hand keypad on the steering wheel.

In the app menu, you can choose which information is shown on the driver display from:

- trip computer
- media player
- phone
- navigation system*.

Settings via the centre display

Selecting information type

- 1 Tap on **Settings** in the centre display's top view.
- 2 Press **My Car** → **Displays** → **Driver Display Information**.
- 3 Select what should be shown in the background:
 - **Show no information in background**
 - **Show information for current playing media**
 - **Show navigation even if no route is set**

Selecting theme

- 1 Tap on **Settings** in the centre display's top view.
- 2 Tap on **My Car** → **Displays** → **Display Themes**

3 Select a theme (appearance) for the driver display:

- Glass
- Minimalistic
- Performance
- Chrome Rings

Selecting language

1 Tap on **Settings** in the centre display's top view.

2 Tap on **System** → **System Languages and Units** → **System Language** to select language.

➤ A change will affect the language in all displays.

These settings are personal and are saved automatically to the active driver profile.

* Option/accessory.

4.1.5. License agreement for driver display

A license is an agreement for the right to operate a certain activity or the right to use someone else's entitlement according to the terms and conditions in the agreement. The following text is Volvo's agreement with the manufacturer or developer.

Boost Software License 1.0

Permission is hereby granted, free of charge, to any person or organization obtaining a copy of the software and accompanying documentation covered by this license (the "Software") to use, reproduce, display, distribute, execute, and transmit the Software, and to prepare derivative works of the Software, and to permit third-parties to whom the Software is furnished to do so, all subject to the following: The copyright notices in the Software and this entire statement, including the above license grant, this restriction and the following disclaimer, must be included in all copies of the Software, in whole or in part, and all derivative works of the Software, unless such copies or derivative works are solely in the form of machine-executable object code generated by a source language processor.

THE SOFTWARE IS PROVIDED "AS IS", WITHOUT WARRANTY OF ANY KIND, EXPRESS OR IMPLIED, INCLUDING BUT NOT LIMITED TO THE WARRANTIES OF MERCHANTABILITY, FITNESS FOR A PARTICULAR PURPOSE, TITLE AND NON-INFRINGEMENT. IN NO EVENT SHALL THE COPYRIGHT HOLDERS OR ANYONE DISTRIBUTING THE SOFTWARE BE LIABLE FOR ANY DAMAGES OR OTHER LIABILITY, WHETHER IN CONTRACT, TORT OR OTHERWISE, ARISING FROM, OUT OF OR IN CONNECTION WITH THE SOFTWARE OR THE USE OR OTHER DEALINGS IN THE SOFTWARE.

BSD 4-clause "Original" or "Old" License

The content of this manual represents the status of the user manual at the time of printing and may not be completely valid in future instances. For more information, refer to the first page for the complete disclaimer note.

Copyright (c) 1982, 1986, 1990, 1991, 1993 The Regents of the University of California. All rights reserved.

Redistribution and use in source and binary forms, with or without modification, are permitted provided that the following conditions are met:

1. Redistributions of source code must retain the above copyright notice, this list of conditions and the following disclaimer.
2. Redistributions in binary form must reproduce the above copyright notice, this list of conditions and the following disclaimer in the documentation and/or other materials provided with the distribution.
3. All advertising materials mentioning features or use of this software must display the following acknowledgement: This product includes software developed by the University of California, Berkeley and its contributors.
4. Neither the name of the University nor the names of its contributors may be used to endorse or promote products derived from this software without specific prior written permission.

THIS SOFTWARE IS PROVIDED BY THE REGENTS AND CONTRIBUTORS "AS IS" AND ANY EXPRESS OR IMPLIED WARRANTIES, INCLUDING, BUT NOT LIMITED TO, THE IMPLIED WARRANTIES OF MERCHANTABILITY AND FITNESS FOR A PARTICULAR PURPOSE ARE DISCLAIMED. IN NO EVENT SHALL THE REGENTS OR CONTRIBUTORS BE LIABLE FOR ANY DIRECT, INDIRECT, INCIDENTAL, SPECIAL, EXEMPLARY, OR CONSEQUENTIAL DAMAGES (INCLUDING, BUT NOT LIMITED TO, PROCUREMENT OF SUBSTITUTE GOODS OR SERVICES; LOSS OF USE, DATA, OR PROFITS; OR BUSINESS INTERRUPTION) HOWEVER CAUSED AND ON ANY THEORY OF LIABILITY, WHETHER IN CONTRACT, STRICT LIABILITY, OR TORT (INCLUDING NEGLIGENCE OR OTHERWISE) ARISING IN ANY WAY OUT OF THE USE OF THIS SOFTWARE, EVEN IF ADVISED OF THE POSSIBILITY OF SUCH DAMAGE.

BSD 3-clause "New" or "Revised" License

Copyright (c) 2011-2014, Yann Collet.

Redistribution and use in source and binary forms, with or without modification, are permitted provided that the following conditions are met:

1. Redistributions of source code must retain the above copyright notice, this list of conditions and the following disclaimer.
2. Redistributions in binary form must reproduce the above copyright notice, this list of conditions and the following disclaimer in the documentation and/or other materials provided with the distribution.
3. Neither the name of the organisation nor the names of its contributors may be used to endorse or promote products derive from this software without specific prior written permission.

THIS SOFTWARE IS PROVIDED BY THE COPYRIGHT HOLDERS AND CONTRIBUTORS "AS IS" AND ANY EXPRESS OR IMPLIED WARRANTIES, INCLUDING, BUT NOT LIMITED TO, THE IMPLIED WARRANTIES OF MERCHANTABILITY AND FITNESS FOR A PARTICULAR PURPOSE ARE DISCLAIMED. IN NO EVENT SHALL THE COPYRIGHT HOLDER OR CONTRIBUTORS BE LIABLE FOR ANY DIRECT, INDIRECT, INCIDENTAL, SPECIAL, EXEMPLARY, OR CONSEQUENTIAL DAMAGES (INCLUDING, BUT NOT LIMITED TO, PROCUREMENT OF SUBSTITUTE GOODS OR SERVICES; LOSS OF USE, DATA, OR PROFITS; OR BUSINESS INTERRUPTION) HOWEVER CAUSED AND ON ANY THEORY OF LIABILITY, WHETHER IN CONTRACT, STRICT LIABILITY, OR TORT (INCLUDING NEGLIGENCE OR OTHERWISE) ARISING IN ANY WAY OUT OF THE USE OF THIS SOFTWARE, EVEN IF ADVISED OF THE POSSIBILITY OF SUCH DAMAGE.

BSD 2-clause "Simplified" license

Copyright (c) <YEAR>, <OWNER> All rights reserved.

Redistribution and use in source and binary forms, with or without modification, are permitted provided that the following conditions are met:

1. Redistributions of source code must retain the above copyright notice, this list of conditions and the following disclaimer.
2. Redistributions in binary form must reproduce the above copyright notice, this list of conditions and the following disclaimer in the documentation and/or other materials provided with the distribution.

THIS SOFTWARE IS PROVIDED BY THE COPYRIGHT HOLDERS AND CONTRIBUTORS "AS IS" AND ANY EXPRESS OR IMPLIED WARRANTIES, INCLUDING, BUT NOT LIMITED TO, THE IMPLIED WARRANTIES OF MERCHANTABILITY AND FITNESS FOR A PARTICULAR PURPOSE ARE DISCLAIMED. IN NO EVENT SHALL THE COPYRIGHT OWNER OR CONTRIBUTORS BE LIABLE FOR ANY DIRECT, INDIRECT, INCIDENTAL, SPECIAL, EXEMPLARY, OR CONSEQUENTIAL DAMAGES (INCLUDING, BUT NOT LIMITED TO, PROCUREMENT OF SUBSTITUTE GOODS OR SERVICES; LOSS OF USE, DATA, OR PROFITS; OR BUSINESS INTERRUPTION) HOWEVER CAUSED AND ON ANY THEORY OF LIABILITY, WHETHER IN CONTRACT, STRICT LIABILITY, OR TORT (INCLUDING NEGLIGENCE OR OTHERWISE) ARISING IN ANY WAY OUT OF THE USE OF THIS SOFTWARE, EVEN IF ADVISED OF THE POSSIBILITY OF SUCH DAMAGE.

The views and conclusions contained in the software and documentation are those of the authors and should not be interpreted as representing official policies, either expressed or implied, of the FreeBSD Project.

FreeType Project License

1. 1 Copyright 1996-1999 by David Turner, Robert Wilhelm, and Werner Lemberg Introduction The FreeType Project is distributed in several archive packages; some of them may contain, in addition to the FreeType font engine, various tools and contributions which rely on, or relate to, the FreeType Project. This license applies to all files found in such packages, and which do not fall under their own explicit license. The license affects thus the FreeType font engine, the test programs, documentation and makefiles, at the very least. This license was inspired by the BSD, Artistic, and IJG (Independent JPEG Group) licenses, which all encourage inclusion and use of free software in commercial and freeware products alike. As a consequence, its main points are that:
 - o We don't promise that this software works. However, we are interested in any kind of bug reports. ('as is' distribution)
 - o You can use this software for whatever you want, in parts or full form, without having to pay us. ('royalty-free' usage)
 - o You may not pretend that you wrote this software. If you use it, or only parts of it, in a program, you must acknowledge somewhere in your documentation that you've used the FreeType code. ('credits')We specifically permit and encourage the inclusion of this software, with or without modifications, in commercial products, provided that all warranty or liability claims are assumed by the product vendor. Legal Terms 0. Definitions Throughout this license, the terms 'package', 'FreeType Project', and 'FreeType archive' refer to the set of files originally distributed by the authors (David Turner, Robert Wilhelm, and Werner Lemberg) as the 'FreeType project', be they named as alpha, beta or final release. 'You' refers to the licensee, or person using the project, where 'using' is a generic term including compiling the project's source code as well as linking it to form a 'program' or 'executable'. This program is referred to as 'a program using the FreeType engine'. This license applies to all files distributed in the original FreeType archive, including all source code, binaries and documentation, unless otherwise stated in the file in its original, unmodified form as distributed in the original archive. If you are unsure whether or not a particular file is covered by this license, you must contact us to verify this. The FreeType project is copyright (C) 1996-1999 by David Turner, Robert Wilhelm, and Werner Lemberg. All rights reserved except as specified below. 1. No Warranty THE FREETYPE ARCHIVE IS PROVIDED 'AS IS' WITHOUT WARRANTY OF ANY KIND, EITHER EXPRESSED OR IMPLIED, INCLUDING, BUT NOT LIMITED TO, WARRANTIES OF MERCHANTABILITY AND FITNESS FOR A PARTICULAR PURPOSE. IN NO EVENT WILL ANY OF THE AUTHORS OR COPYRIGHT HOLDERS BE LIABLE FOR ANY DAMAGES CAUSED BY THE USE OR THE INABILITY TO USE, OF THE FREETYPE PROJECT. As you have not signed this license, you are not required to accept it. However, as the FreeType project is copyrighted material, only this license, or another one contracted with the authors, grants you the right to use, distribute, and modify it. Therefore, by using, distributing, or modifying the FreeType project, you indicate that you understand and accept all the terms of this license.
2. Redistribution Redistribution and use in source and binary forms, with or without modification, are permitted provided that the following conditions are met:
 - o Redistribution of source code must retain this license file ('licence.txt') unaltered; any additions, deletions or changes to the original files must be clearly indicated in accompanying documentation. The copyright notices of the unaltered, original files must be preserved in all copies of source files.
 - o Redistribution in binary form must provide a disclaimer that states that the software is based in part of the work of the FreeType Team, in the distribution documentation. We also encourage you to put an URL to the FreeType web page in your documentation,

The content of this manual represents the status of the user manual at the time of printing and may not be completely valid in future instances. For more information, refer to the first page for the complete disclaimer note.

though this isn't mandatory. These conditions apply to any software derived from or based on the FreeType code, not just the unmodified files. If you use our work, you must acknowledge us. However, no fee need be paid to us.

3. Advertising The names of FreeType's authors and contributors may not be used to endorse or promote products derived from this software without specific prior written permission. We suggest, but do not require, that you use one or more of the following phrases to refer to this software in your documentation or advertising materials: 'FreeType Project', 'FreeType Engine', 'FreeType library', or 'FreeType Distribution'.
4. Contacts There are two mailing lists related to FreeType: o freetype@freetype.org Discusses general use and applications of FreeType, as well as future and wanted additions to the library and distribution. If you are looking for support, start in this list if you haven't found anything to help you in the documentation. o devel@freetype.org Discusses bugs, as well as engine internals, design issues, specific licenses, porting, etc. o <http://www.freetype.org> Holds the current FreeType web page, which will allow you to download our latest development version and read online documentation. You can also contact us individually at: David Turner <david.turner@freetype.org> Robert Wilhelm <robert.wilhelm@freetype.org> Werner Lemberg <werner.lemberg@freetype.org>

Libpng License

This copy of the libpng notices is provided for your convenience. In case of any discrepancy between this copy and the notices in the file png.h that is included in the libpng distribution, the latter shall prevail.

COPYRIGHT NOTICE, DISCLAIMER, and LICENSE:

If you modify libpng you may insert additional notices immediately following this sentence.

libpng versions 1.0.7, July 1, 2000, through 1.0.13, April 15, 2002, are Copyright (c) 2000-2002 Glenn Randers-Pehrson and are distributed according to the same disclaimer and license as libpng-1.0.6 with the following individuals added to the list of Contributing Authors

Simon-Pierre Cadieux

Eric S. Raymond

Gilles Vollant

and with the following additions to the disclaimer:

There is no warranty against interference with your enjoyment of the library or against infringement. There is no warranty that our efforts or the library will fulfill any of your particular purposes or needs. This library is provided with all faults, and the entire risk of satisfactory quality, performance, accuracy, and effort is with the user.

libpng versions 0.97, January 1998, through 1.0.6, March 20, 2000, are Copyright (c) 1998, 1999 Glenn Randers-Pehrson, and are distributed according to the same disclaimer and license as libpng-0.96, with the following individuals added to the list of Contributing Authors:

Tom Lane

Glenn Randers-Pehrson

Willem van Schaik

libpng versions 0.89, June 1996, through 0.96, May 1997, are Copyright (c) 1996, 1997 Andreas Dilger Distributed according to the same disclaimer and license as libpng-0.88, with the following individuals added to the list of Contributing Authors:

John Bowler

Kevin Bracey

Sam Bushell

Magnus Holmgren

Greg Roelofs

Tom Tanner

libpng versions 0.5, May 1995, through 0.88, January 1996, are Copyright (c) 1995, 1996 Guy Eric Schalnat, Group 42, Inc.

For the purposes of this copyright and license, "Contributing Authors" is defined as the following set of individuals:

Andreas Dilger

Dave Martindale

Guy Eric Schalnat

Paul Schmidt

Tim Wegner

The PNG Reference Library is supplied "AS IS". The Contributing Authors and Group 42, Inc. disclaim all warranties, expressed or implied, including, without limitation, the warranties of merchantability and of fitness for any purpose. The Contributing Authors and Group 42, Inc. assume no liability for direct, indirect, incidental, special, exemplary, or consequential damages, which may result from the use of the PNG Reference Library, even if advised of the possibility of such damage.

Permission is hereby granted to use, copy, modify, and distribute this source code, or portions hereof, for any purpose, without fee, subject to the following restrictions:

1. The origin of this source code must not be misrepresented.
2. Altered versions must be plainly marked as such and must not be misrepresented as being the original source.
3. This Copyright notice may not be removed or altered from any source or altered source distribution.

The Contributing Authors and Group 42, Inc. specifically permit, without fee, and encourage the use of this source code as a component to supporting the PNG file format in commercial products. If you use this source code in a product, acknowledgment is not required but would be appreciated.

A "png_get_copyright" function is available, for convenient use in "about" boxes and the like:

```
printf("%s",png_get_copyright(NULL));
```

Also, the PNG logo (in PNG format, of course) is supplied in the files "pngbar.png" and "pngbar.jpg (88x31) and "pngnow.png" (98x31).

Libpng is OSI Certified Open Source Software. OSI Certified Open Source is a certification mark of the Open Source Initiative.

Glenn Randers-Pehrson randeg@alum.rpi.edu April 15, 2002

MIT License

Copyright (c) <year> <copyright holders>

Permission is hereby granted, free of charge, to any person obtaining a copy of this software and associated documentation files (the "Software"), to deal in the Software without restriction, including without limitation the rights to use, copy, modify, merge, publish, distribute, sublicense, and/or sell copies of the Software, and to permit persons to whom the Software is furnished to do so, subject to the following conditions:

The content of this manual represents the status of the user manual at the time of printing and may not be completely valid in future instances. For more information, refer to the first page for the complete disclaimer note.

The above copyright notice and this permission notice shall be included in all copies or substantial portions of the Software.

THE SOFTWARE IS PROVIDED "AS IS", WITHOUT WARRANTY OF ANY KIND, EXPRESS OR IMPLIED, INCLUDING BUT NOT LIMITED TO THE WARRANTIES OF MERCHANTABILITY, FITNESS FOR A PARTICULAR PURPOSE AND NONINFRINGEMENT. IN NO EVENT SHALL THE AUTHORS OR COPYRIGHT HOLDERS BE LIABLE FOR ANY CLAIM, DAMAGES OR OTHER LIABILITY, WHETHER IN AN ACTION OF CONTRACT, TORT OR OTHERWISE, ARISING FROM, OUT OF OR IN CONNECTION WITH THE SOFTWARE OR THE USE OR OTHER DEALINGS IN THE SOFTWARE.

zlib License

The zlib/libpng License Copyright (c) <year> <copyright holders>

This software is provided 'as-is', without any express or implied warranty. In no event will the authors be held liable for any damages arising from the use of this software.

Permission is granted to anyone to use this software for any purpose, including commercial applications, and to alter it and redistribute it freely, subject to the following restrictions:

1. The origin of this software must not be misrepresented; you must not claim that you wrote the original software. If you use this software in a product, an acknowledgment in the product documentation would be appreciated but is not required.
2. Altered source versions must be plainly marked as such, and must not be misrepresented as being the original software.
3. This notice may not be removed or altered from any source distribution.

SGI Free Software B License Version 2.0.

SGI FREE SOFTWARE LICENSE B (Version 2.0, Sept. 18, 2008)

Copyright (C) [dates of first publication] Silicon Graphics, Inc. All Rights Reserved. Permission is hereby granted, free of charge, to any person obtaining a copy of this software and associated documentation files (the "Software"), to deal in the Software without restriction, including without limitation the rights to use, copy, modify, merge, publish, distribute, sublicense, and/or sell copies of the Software, and to permit persons to whom the Software is furnished to do so, subject to the following conditions: The above copyright notice including the dates of first publication and either this permission notice or a reference to <http://oss.sgi.com/projects/FreeB/> shall be included in all copies or substantial portions of the Software.

THE SOFTWARE IS PROVIDED "AS IS", WITHOUT WARRANTY OF ANY KIND, EXPRESS OR IMPLIED, INCLUDING BUT NOT LIMITED TO THE WARRANTIES OF MERCHANTABILITY, FITNESS FOR A PARTICULAR PURPOSE AND NONINFRINGEMENT. IN NO EVENT SHALL SILICON GRAPHICS, INC. BE LIABLE FOR ANY CLAIM, DAMAGES OR OTHER LIABILITY, WHETHER IN AN ACTION OF CONTRACT, TORT OR OTHERWISE, ARISING FROM, OUT OF OR IN CONNECTION WITH THE SOFTWARE OR THE USE OR OTHER DEALINGS IN THE SOFTWARE.

Except as contained in this notice, the name of Silicon Graphics, Inc. shall not be used in advertising or otherwise to promote the sale, use or other dealings in this Software without prior written authorization from Silicon Graphics, Inc.

4.1.6. App menu in the driver display

The app menu in the driver display provides quick access to commonly used functions for certain apps.



The figure is schematic.

The app menu in the driver display can be used instead of the centre display and is controlled using the right-hand keypad on the steering wheel. The app menu makes it easier to switch between different apps or functions within the apps without having to let go of the steering wheel.

App menu functions

Different apps give access to different types of functions. The following apps and their associated functions can be controlled from the app menu:

App	Functions
Trip computer	Selection of trip meter, selection of what to show in the driver display, etc.
Media player	Selection of active source for the media player.
Phone	Calling a contact from the call list.
Navigation	Guide to destination, etc.

4.1.7. Managing the app menu in the driver display

The app menu in the driver display is operated with the steering wheel's right-hand keypad.



The app menu and the steering wheel's right-hand keypad. The figure is schematic.

- 1 Open/close
- 2 Left/right
- 3 Up/down
- 4 Confirm

Opening/closing the app menu

- 1 Press on open/close (1).
- The app menu opens/closes.

i Note

It is not possible to open the app menu while there is an unacknowledged message in the driver display. The message has to be confirmed first before the app menu can be opened.

The app menu closes automatically after a period of inactivity or after certain options have been selected.

Navigating and selecting in the app menu

- 1 Navigate between the apps by pressing on the left or right (2).
- Functions for previous/next app are shown in the app menu.
- 2 Browse through the functions for the selected app by tapping on up or down (3).
 - 3 Confirm or highlight an option for the function by pressing on confirm (4).

- The function is activated and for some options the app menu then closes.

If the app menu is opened again, the functions of the most recently selected app are shown first.











4.1.8. Indicator and warning symbols

The indicator and warning systems alert the driver to the fact that a function is activated, a system is working, or a defect or serious error has occurred.



Red symbols

	<p>Warning</p> <p>The red warning symbol illuminates when a fault has been detected which could affect the safety or drivability of the car. An explanatory text is shown on the driver display at the same time.</p> <p>The warning symbol can also illuminate in conjunction with other symbols.</p>
	<p>Seatbelt reminder</p> <p>Illuminates or flashes when someone in the car is not wearing a seatbelt.</p>
	<p>Airbags</p> <p>An error has been detected in any of the car's safety systems.</p> <p>Read the message on the driver display and contact a workshop. Volvo recommends that an authorised Volvo workshop is contacted.</p>
	<p>Fault in brake system</p> <p>An error has occurred on the braking system.</p> <p>Read the message on the driver display and contact a workshop. Volvo recommends that an authorised Volvo workshop is contacted.</p>
	<p>Parking brake</p> <p>Light illuminated permanently: The parking brake is activated.</p> <p>Flashing: an error has occurred with the parking brake. Read the message in the driver display.</p>
	<p>Faults in the electrical system</p> <p>An error has occurred on the electrical system.</p> <p>Read the message on the driver display and contact a workshop. Volvo recommends that an authorised Volvo workshop is contacted.</p>
	<p>High engine temperature</p> <p>The engine temperature is too high. Read the message in the driver display.</p>
	<p>Collision risk</p> <p>City Safety warns of a risk of collision with other vehicles, pedestrians, cyclists or large animals.</p>
	<p>Low oil pressure</p> <p>The engine oil pressure is too low. Stop the engine immediately and check the engine oil level, top up if necessary.</p> <p>If the symbol lights up and the oil level is normal, read the message on the display and contact a workshop. Volvo recommends that an authorised Volvo workshop is contacted.</p>





Amber symbols

	<p>Information</p> <p>A fault has occurred in one of the car's systems. Read the message in the driver display. The information symbol can also illuminate in conjunction with other symbols.</p>
	<p>Fault in brake system</p> <p>An error has occurred on the braking system. Read the message in the driver display.</p>
	<p>ABS fault</p> <p>The system is disengaged. The car's regular brake system continues to work, but without the ABS function.</p>
	<p>Emissions system</p> <p>Emissions systems fault. Drive to a workshop for checking. Volvo recommends that an authorised Volvo workshop is contacted.</p>
	<p>Rear fog lamp</p> <p>The rear fog lamp is illuminated.</p>
	<p>Tyre pressure system</p> <p>Low tyre pressure. If there is a fault in the tyre pressure system, the symbol will flash for approx. 1 minute and then illuminate with a constant glow. This may be because the system cannot detect or warn of low tyre pressure as intended.</p>
	<p>Fault in the headlamp system</p> <p>A fault has occurred on the headlamp system. Read the message in the driver display.</p>
	<p>Lane assistance</p> <p>Lane assistance warns/intervenes.</p>
	<p>Reduced performance</p> <p>Temporary fault on drivetrain. Read the message in the driver display.</p>
	<p>Stability system</p> <p>Light on permanently: a fault has occurred in the system. Flashing: the system is working.</p>
	<p>Stability system, sport mode</p> <p>Sport mode is selected.</p>





Blue symbols

	<p>Active main beam</p> <p>Active main beam is activated and switched on.</p>
	<p>Main beam</p> <p>Main beam is switched on.</p>

Green symbols

	Automatic brake The function is activated and the service brake or parking brake is operating.
	Front fog lamps The front fog lamp is switched on.
	Position lamps The position lamps are switched on.
	Left and right-hand direction indicator The direction indicator is being used.

White/grey symbols

	Active main beam Active main beam is activated, but does not come on.
	Preconditioning Engine and compartment heater/air conditioning pre-condition the car.
	Lane assistance White symbol: Lane assistance is on and road lines are detected. Grey symbol: Lane assistance is on but road lines are not detected.
	Rain sensor The rain sensor is activated.

4.1.9. Messages in the driver display

The driver display can show messages to inform or assist the driver in the event of different events.



Examples of messages in the driver display. The figure is schematic - parts may vary depending on car model.

The driver display shows messages that are of high priority for the driver.

Messages can be shown in different parts of the driver display depending on what other information is currently being displayed. After a while, or when the message has been acknowledged/action taken if required, the message disappears from the driver display. If a message needs to be saved, it is placed in the **Car Status** app, which is opened from the app view in the centre display.

Message composition may vary and they can be shown together with graphics, symbols or buttons for acknowledging the message or accepting a request, for example.

Service messages

Shown below is a selection of important service messages and their meanings.

Message	Specification
Stop safely ^[1]	Stop and switch off the engine. Serious risk of damage - consult a workshop ^[2] .
Turn off engine ^[1]	Stop and switch off the engine. Serious risk of damage - consult a workshop ^[2] .
Service urgent Drive to workshop ^[1]	Contact a workshop ^[2] to check the car immediately.
Service required ^[1]	Contact a workshop ^[2] to check the car as soon as possible.
Regular maintenance Book time for maintenance	Time for regular service - contact a workshop ^[2] . Shown before the next service date.
Regular maintenance Time for maintenance	Time for regular service - contact a workshop ^[2] . Shown at the next service date.
Regular maintenance Maintenance overdue	Time for regular service - contact a workshop ^[2] . Shown when the service date has passed.
Temporarily off ^[1]	A function has been temporarily switched off and is reset automatically while driving or after starting again.

^[1] Part of message, shown together with information on where the problem has arisen.

^[2] An authorised Volvo workshop is recommended.

4.1.10. Date and time

The clock is shown in both the driver display and the centre display.

Clock location



In certain situations, messages and information may cover the clock in the driver display.

In the centre display, the clock is located at the top right of the status bar.

Date and time settings

- 1 Select **Settings** → **System** → **Date and Time** in the centre display's top view to change settings for time and date format. Adjust the date and time by pressing the up or down arrow on the touch screen.

Automatic time for cars with GPS

When the car is equipped with a navigation system, **Auto Time** can be selected. The time zone is then adjusted automatically based on the location of the car. For certain types of navigation systems, the current location (country) must also be set to obtain the right time zone. If **Auto Time** is not selected, time and data are adjusted with arrow up or arrow down on the touch screen.

Summer time

In certain countries, it is possible to select the **Auto Daylight Saving Time** setting for automatic setting of summer time. For other countries, the **Daylight Saving Time** setting can be selected manually.

If the battery has been disconnected

If the clock has been reset following disconnection of the car's battery after a visit to a service workshop, for example, you may need to reset the time on the clock. If the clock is not set, this may affect the car's Internet connection.

4.2. Centre display

4.2.1. Settings

4.2.1.1. Resetting user data for change of ownership

In the event of a change of ownership, user data and system settings should be restored to factory settings.

The settings in the car can be reset at different levels. Restore all user data and system settings to the original factory settings in the event of a change of ownership. In the event of a change of ownership it is also important to change the owner of the Volvo On Call* service.

* Option/accessory.

4.2.1.2. Other settings in the centre display's top view

You can change settings and information for many of the car's functions via the centre display.

- 1 Open the top view by pressing on the tab at the top or by dragging/swiping from the top downwards across the screen.
- 2 Press **Settings** to open the settings menu.

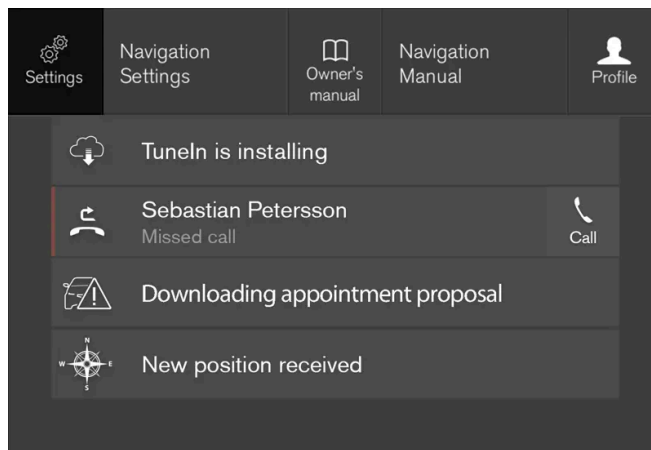

Top view with button for Settings.

- 3 Press on one of the categories and the subcategories to navigate to the required setting.
- 4 Change one or more settings. Different types of setting are changed in different ways.

➤ The changes are saved immediately.

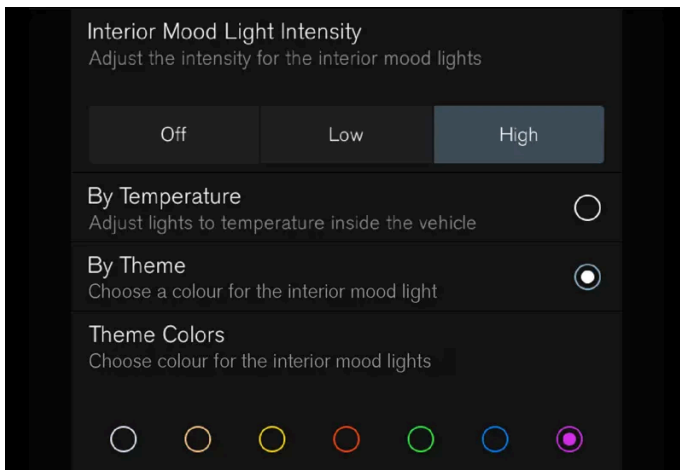

A subcategory in the settings menu with different types of settings (here, a multi-selector button and radio buttons).

4.2.1.3. Resetting settings in the centre display

It is possible to reset the defaults for all settings defined in the centre display settings menu.

Two types of reset

There are two different types of restore operation in the settings menu:

- **Factory reset** - clears all data and files and resets all settings to their default values.
- **Reset Personal Settings** - clears personal data and resets personal settings to their default values.

Resetting settings

Follow these instructions to reset your settings.

Note

Factory reset is only possible when the car is stationary.

- 1 Tap on **Settings** in the centre display's top view.
- 2 Continue to **System** → **Factory reset**.
- 3 Select the required reset type.
 - A pop-up window is shown.
- 4 Press **OK** to confirm the reset.

For **Reset Personal Settings**, the reset must be confirmed by pressing **Reset for the active profile** or **Reset for all profiles**.

- Selected settings are reset.

4.2.1.4. Open contextual setup in the centre display

It is possible to use contextual setup for most of the car's basic apps so that you can change settings directly in the top view in the centre display.

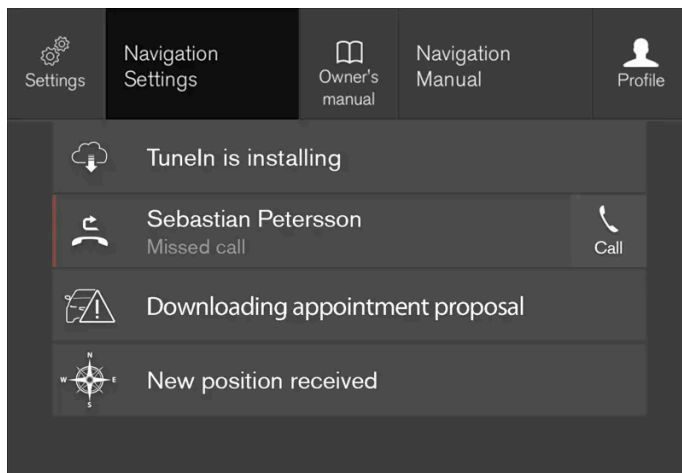

Top view with button for contextual setting.

Contextual setting is a shortcut for accessing a specific setting relating to the active function shown on screen. The apps installed in the car from the beginning, e.g. **FM radio** and **USB**, are a part of Sensus and are part of the car's embedded functions. The settings for these apps can be changed directly via contextual setting in the top view.

When contextual setup is available:

- 1 Drag down top view when an app is in expanded mode, e.g. **Navigation**.
- 2 Press **Navigation Settings**.
 - A navigation settings page opens.
- 3 Change settings as desired and confirm the selections.

Press **Close** or the physical home button beneath the centre display to close setup view.

Most of the car's basic apps have this contextual setting option, but not all.

Third party apps

The content of this manual represents the status of the user manual at the time of printing and may not be completely valid in future instances. For more information, refer to the first page for the complete disclaimer note.

Third party apps are not included in the car's system from the beginning, but are the type that can be downloaded e.g. **Volvo ID**. Here the settings are always made inside the app and not from the top view.

4.2.1.5. Changing system units

Units settings are defined in the centre display's **Settings** menu.

- 1 Press **Settings** in the top view in the centre display.
 - 2 Continue to **System** → **System Languages and Units** → **Units of Measurement**.
 - 3 Select a unit standard:
 - **Metric** - kilometres, litres and degrees Celsius.
 - **Imperial** - miles, gallons and degrees Celsius.
 - **US** - miles, gallons and degrees Fahrenheit.
- The units in the driver display, centre display and head-up display are changed.
-

4.2.1.6. Switching off and changing system sound volume in the centre display

The centre display can be used to change the volume of the system sound or switch off the system sound altogether.

- 1 Press **Settings** in the top view in the centre display.
 - 2 Press **Sound** → **System Volumes**.
 - 3 Under **Touch Sounds**, drag the control to change the volume/switch off screen touch sounds. Drag the control to the desired volume.
-

4.2.1.7. Changing system language

Language settings are defined in the centre display menu **Settings**.

 **Note**

Changing the language in the centre display may mean that some owner's information is not compliant with national or local laws and regulations. Do not switch to a language that is difficult to understand as this may make it difficult to find your way back through the screen structure.

- 1 Press **Settings** in the top view in the centre display.
- 2 Continue to **System** → **System Languages and Units**.
- 3 Select **System Language**.
Languages that support voice recognition have a voice recognition symbol.

> The language in the driver display, centre display and head-up display is changed.

4.2.1.8. Changing appearance in the centre display

The appearance of the screen in the centre display can be changed by selecting a theme.

- 1 Press **Settings** in the top view.
- 2 Press **My Car** → **Displays** → **Display Themes**.
- 3 Then select a theme, e.g. **Minimalistic** or **Chrome Rings**.

As a supplement to these appearances, it is possible to choose between **Normal** and **Bright**. With **Normal**, the screen background is dark and the text is light. This alternative is the default for all themes. A light variant can also be selected, in which the background is light and the text is dark. This alternative can be useful in e.g. strong daylight.

This alternative is always available for the user and is not affected by the surrounding lighting.

4.2.1.9. Show trip data in driver display

The trip computer's recorded and calculated values can be shown in the driver display.

The values are saved in a trip computer app. Via the app menu, you can choose which information is shown on the driver

display.



Open and navigate in the app menu^[1] using the right-hand steering wheel keypad.

- 1 App menu
- 2 Left/right
- 3 Up/down
- 4 Confirm

1 Open the app menu in the driver display by pressing (1).

(It is not possible to open the app menu while there is an unacknowledged message in the driver display. The message first has to be confirmed by pressing the  button (4) before the app menu can be opened.)

2 Navigate to the trip computer app to left or right with (2).

➤ The top four menu rows show measured values for trip meter TM. The next four menu rows show measured values for trip meter TA. Scroll up or down in the list with (3).

3 Scroll down to the option buttons to select which information to show in the driver display:

- Odometer
- Distance to empty tank
- Distance to empty battery
- Tourist (alternative speedometer)
- Mileage for trip meter TM, TA, or no display of mileage
- Instantaneous fuel consumption, average consumption for TM or TA, alternatively, no display of fuel consumption

Select or deselect an option with the  button (4). The change is made immediately.

^[1] The figure is schematic - parts may vary depending on car model.

4.2.1.10. Settings for trip statistics

Reset or adjust settings for trip statistics.

- 1 Open the **Driver performance** app in app view in order to show the trip statistics.



- 2 Press **Preferences** to

- change graph scale. Select resolution 1, 10 or 100 km/miles for the bar.
- reset data after every trip. Performed when the car has been stationary for more than 4 hours.
- reset data for the current trip.

Trip statistics, calculated average consumption and total driving time are always reset simultaneously.

Units for distance, speed, etc. can be changed via system settings in the centre display.

4.2.1.11. Driver display settings

Settings for the driver display's display options can be made via the driver display's app menu and via the centre display's settings menu.

Settings via the driver display's app menu



The figure is schematic - parts may vary depending on car model.

The app menu is opened and controlled using the right-hand keypad on the steering wheel.

In the app menu, you can choose which information is shown on the driver display from:

- trip computer
- media player
- phone
- navigation system*.

Settings via the centre display

Selecting information type

- 1 Tap on **Settings** in the centre display's top view.
- 2 Press **My Car** → **Displays** → **Driver Display Information**.
- 3 Select what should be shown in the background:
 - **Show no information in background**
 - **Show information for current playing media**
 - **Show navigation even if no route is set**

Selecting theme

- 1 Tap on **Settings** in the centre display's top view.
- 2 Tap on **My Car** → **Displays** → **Display Themes**
- 3 Select a theme (appearance) for the driver display:
 - **Glass**
 - **Minimalistic**
 - **Performance**
 - **Chrome Rings**

Selecting language

- 1 Tap on **Settings** in the centre display's top view.
 - 2 Tap on **System** → **System Languages and Units** → **System Language** to select language.
- A change will affect the language in all displays.

These settings are personal and are saved automatically to the active driver profile.

The content of this manual represents the status of the user manual at the time of printing and may not be completely valid in future instances. For more information, refer to the first page for the complete disclaimer note.

* Option/accessory.

4.2.1.12. Date and time

The clock is shown in both the driver display and the centre display.

Clock location



In certain situations, messages and information may cover the clock in the driver display.

In the centre display, the clock is located at the top right of the status bar.

Date and time settings

- 1 Select **Settings** → **System** → **Date and Time** in the centre display's top view to change settings for time and date format.
Adjust the date and time by pressing the up or down arrow on the touch screen.

Automatic time for cars with GPS

When the car is equipped with a navigation system, **Auto Time** can be selected. The time zone is then adjusted automatically based on the location of the car. For certain types of navigation systems, the current location (country) must also be set to obtain the right time zone. If **Auto Time** is not selected, time and data are adjusted with arrow up or arrow down on the touch screen.

Summer time

In certain countries, it is possible to select the **Auto Daylight Saving Time** setting for automatic setting of summer time. For other countries, the **Daylight Saving Time** setting can be selected manually.

If the battery has been disconnected

If the clock has been reset following disconnection of the car's battery after a visit to a service workshop, for example, you may need to reset the time on the clock. If the clock is not set, this may affect the car's Internet connection.

4.2.1.13. Settings for head-up display*

Adjust the settings for the head-up display's projection onto the windscreen.

Settings can be defined when the car has been started and a projected image is shown on the windscreen.

Selecting display options

Select which functions are to be shown in the head-up display.

- 1 Tap on **Settings** in the centre display's top view.
- 2 Press **My Car** → **Displays** → **Head-Up Display Options**.
- 3 Select one or more functions:
 - **Show Navigation**
 - **Show Road Sign Information**
 - **Show Driver Support**
 - **Show Phone**

The setting is saved as a personal setting in the driver profile.

Adjusting brightness and vertical position



Press the **Head-up Display Adjustments** button in the centre display function view.

- 2 Adjust the brightness and vertical position of the projected image in the driver's field of vision using the steering wheel's right-hand keypad.

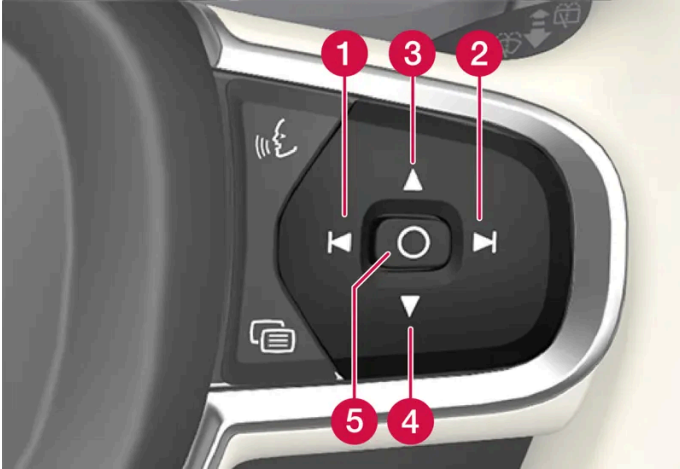

- 1 Reducing the brightness
- 2 Increasing the brightness
- 3 Raising the position
- 4 Lowering the position
- 5 Confirm

The brightness of the graphics is automatically adapted to their background light conditions. The brightness is also affected by the adjustment of the brightness in the car's other displays.

The height position can be stored in the memory function for the power* front seat using the keypad in the driver's door.

Calibrate the horizontal position

The head-up display's horizontal position may need to be calibrated if the windscreen or display unit is replaced. Calibration means that the projected image is rotated clockwise or anticlockwise.

- 1 Tap on **Settings** in the centre display's top view.
- 2 Select **My Car** → **Displays** → **Head-Up Display Options** → **Head-Up Display Calibration**.

- 3 Calibrate the image's horizontal position with the steering wheel's right keypad.

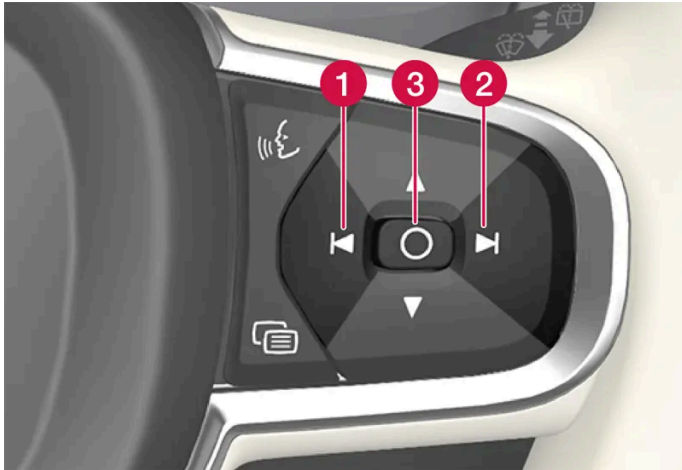

- 1 Rotate anticlockwise
- 2 Rotate clockwise
- 3 Confirm

* Option/accessory.

4.2.1.14. User terms and conditions and data sharing

The first time certain services and apps are started, a pop-up window with the headings **Terms and conditions** and **Data sharing** may be shown.

The purpose is to inform about Volvo's user terms and conditions and policy for data sharing. By accepting data sharing, the user accepts that certain information is sent from the car. This is required so that certain services and apps can have full functionality.

The data sharing function for online services and apps is deactivated as default^[1]. Data sharing needs to be activated so that certain online services and apps in the car can be used. Data sharing can be set from the centre display's settings menu or in connection with the services or apps being started in the centre display.

Privacy and data sharing

With the software update made available November 2017, privacy and data sharing settings were introduced for online services and downloaded apps. The settings can be found under **Privacy and data** in the settings menu in the car's centre display.

There you can select the online services which are allowed to share data. Data sharing for downloaded apps can also be deactivated there. Note that services and apps cannot be used as intended if data sharing is deactivated.

After a factory reset or e.g. a workshop visit or software update, the data sharing settings may have been reset to their default settings. In which case, reactivate data sharing for online services and for downloaded apps.

 **Note**

Privacy and data sharing settings are unique for every driver profile.

* Option/accessory.

^[1] Does not apply to Volvo On Call*.

4.2.1.15. Activating and deactivating data sharing

Data sharing for services and apps required can be set in the centre display's settings menu.

- 1 Tap on **Settings** in the centre display's top view.
- 2 Press **System** → **Privacy and data**.
- 3 Select activation or deactivation of data sharing for individual services and all apps.

If data sharing has not been activated for an online service or downloaded apps, this can be done when they are started in the centre display. If this is the first time a service is started, or e.g. after a factory reset or certain software updates, Volvo's terms and conditions for online services need to be approved. Note that data sharing will then also be activated for other services or apps for which sharing has already been approved.

 **Note**

After a visit to a Volvo workshop, you may need to reactivate data sharing so that the online services and apps shall work again.

4.2.1.16. Settings for remotely controlled and inside unlocking

It is possible to select different sequences for remotely controlled unlocking.

To change setting:

- 1 Tap on **Settings** in the centre display's top view.
- 2 Press **My Car** → **Locking** → **Remote and Interior Unlock**.

3 Select option:

- **All Doors** - unlocks all doors simultaneously.
- **Single Door** - unlocks the driver's door. Unlocking all of the doors requires two presses on the remote control key's unlock button.

The settings made here also affect central unlocking via opening handles from the inside.

4.2.1.17. Care Key settings

Change the maximum speed of a Care Key via the centre display.

Setting options

The following limitations are available to be set:

- Speed interval: 50-180 km/h (30-112 mph)
- Increments: 1 km/h (1 mph)

Setting

- 1** Unlock the car with the normal remote control key (not Care Key).
- 2** Tap on **Settings** in the centre display's top view.
- 3** Press **System** → **Driver Profiles** → **Care Key**.
- 4** Tick the box for activating limitation and set the required limitation.

4.2.1.18. Lock indication setting

It is possible to select various options for how the car confirms locking and unlocking in the settings menu in the centre display.

To change the locking response setting:

- 1** Tap on **Settings** in the centre display's top view.
- 2** Press **My Car** → **Locking**.

Press **Visible Locking Feedback** to select when the car is to give a visible response:

The content of this manual represents the status of the user manual at the time of printing and may not be completely valid in future instances. For more information, refer to the first page for the complete disclaimer note.

- 3 • Lock
- Unlock
- Both

Or switch off the function by selecting **Off** .

To change the setting for retractable rearview mirrors* when locking:

- 1 Tap on **Settings** in the centre display's top view.
- 2 Press **My Car** → **Mirrors and Convenience**.
- 3 Select **Fold Mirror When Locked** to activate or deactivate the function.

* Option/accessory.

4.2.1.19. Settings for Keyless entry*

It is possible to select different sequences for Keyless entry.

To change setting:

- 1 Tap on **Settings** in the centre display's top view.
- 2 Tap on **My Car** → **Locking** → **Keyless Unlock**.
- 3 Select option:
 - **All Doors** - unlocks all doors simultaneously.
 - **Single Door** - unlocks selected door.

* Option/accessory.

4.2.1.20. Automatic parking brake activation setting

The content of this manual represents the status of the user manual at the time of printing and may not be completely valid in future instances. For more information, refer to the first page for the complete disclaimer note.

Choose whether the parking brake is to be activated automatically when the car is switched off.

To change setting:

- 1 Tap on **Settings** in the centre display's top view.
- 2 Press **My Car** → **Parking Brake and Suspension** to select or deselect the function **Auto Activate Parking Brake**.

4.2.1.21. Settings for level control*

Switch off the level control when the car is to be jacked up in order to prevent problems with automatic level control.

Regulate the level to facilitate loading, or on entry and exit.

Adjusting loading mode



Use the buttons in the cargo area to regulate the height of the car's rear section and facilitate loading and unloading or when connecting or disconnecting a trailer.

Settings in the centre display

Entry assistance

The car can be lowered to facilitate entry and exit.

Activating entry assistance via the centre display:

- 1 Press **Settings** in the top view.
- 2 Press **My Car** → **Mirrors and Convenience**.

The content of this manual represents the status of the user manual at the time of printing and may not be completely valid in future instances. For more information, refer to the first page for the complete disclaimer note.

3 Select Easy Entry and Exit Suspension Control.

- When the car is parked and switched off, the car is lowered (level control stops if a door is opened and there may be a certain delay before level control resumes after the door has been closed). When the car is started and begins to move, the car will rise to the height setting for the drive mode selected.

Disable Leveling Control

In certain cases the function must be deactivated e.g. before the car is raised with a jack*. The difference in level created when lifting with a jack would otherwise mean the automatic control starting to adjust the height, creating an undesired effect.

Deactivating the function via the centre display:

- 1 Press **Settings** in the top view.
- 2 Press **My Car** → **Parking Brake and Suspension**.
- 3 Select **Disable Leveling Control**.

* Option/accessory.

4.2.2. Driver profiles

4.2.2.1. Driver profiles

Many of the settings made in the car can be adapted according to the driver's personal preferences and can be saved in one or more driver profiles.



The personal settings are automatically saved in the active driver profile. Every remote control key, apart from Care Key, can be linked to a personal driver profile. When the linked key is used, the car is adapted to the settings of that specific driver profile. Care Key is always linked to the latest profile as well as the speed limitation set. This profile cannot be protected as personal.

What settings are saved in the driver profiles?

Many of the settings defined in the car will be saved automatically in the active driver profile unless the profile is protected. In the car, the settings defined are either personal or global. Only personal settings are saved in driver profiles.

Settings that can be saved in a driver profile include, amongst other things, screens, mirrors, front seats, navigation*, audio and media system and language.

Some settings, referred to as global settings, can be changed but are not saved to a specific driver profile. Changes to global settings affect all profiles.

Global settings

The global settings are not changed when changing between driver profiles. They remain the same regardless of which driver profile is active.

Keyboard layout settings are an example of global settings. If driver profile X is used to add additional languages to the keyboard, these remain available for use even if driver profile Y is used. The keyboard layout settings are not saved to a specific driver profile - the settings are global.

Personal preferences

If driver profile X was used to e.g. set centre display brightness, driver profile Y is not affected by this setting. It has been saved to driver profile X - the brightness setting is a personal setting.

* Option/accessory.

4.2.2.2. Renaming a driver profile

It is possible to change the name of the different driver profiles used in the car.

- 1 Press **Settings** in the top view in the centre display.
- 2 Press **System** → **Driver Profiles**.
- 3 Select **Edit Profile**.
 - A menu opens, where the profile can be edited.
- 4 Tap in the box **Profile Name**.
 - A keyboard appears, and it is possible to change the name. Tap on  to close the keyboard.
- 5 Save the name change by pressing **Back** or **Close**.
 - The name has now been changed.

Note

A profile name cannot start with a space, as the profile name will not then be saved.

4.2.2.3. Linking remote control key to driver profile

It is possible to link your key to a driver profile. The driver profile along with all of its settings will then be automatically selected every time the car is used with that specific remote control key.

The first time the remote control key is used, it is not linked to any specific driver profile. When the car is started, the **Guest** profile will automatically be activated.

A driver profile can be selected manually without linking it to the key. When the car is unlocked, the last active driver profile is activated. Once the key has been linked to a driver profile, a driver profile does not need to be selected when that specific key is used.

Linking a remote control key to a driver profile

Note

Connecting a remote control key to a driver profile is only possible when the car is stationary.

First select the profile to be linked to the key, if the profile to be linked is not already active. The active profile can then be linked to the key.

- 1 Press **Settings** in the top view in the centre display.
- 2 Press **System** → **Driver Profiles**.
- 3 Select the desired profile. The display returns to the home view. The **Guest** profile cannot be linked to a key.
- 4 Drag down the top view again and tap on **Settings** → **System** → **Driver Profiles** → **Edit Profile**.
- 5 Select **Connect key** to link the profile with the key. It is not possible to link a driver profile to a different key than the one currently being used in the car. If there are multiple keys in the car, the message **More than one key is found, put the key you want to connect on backup reader** will be displayed.

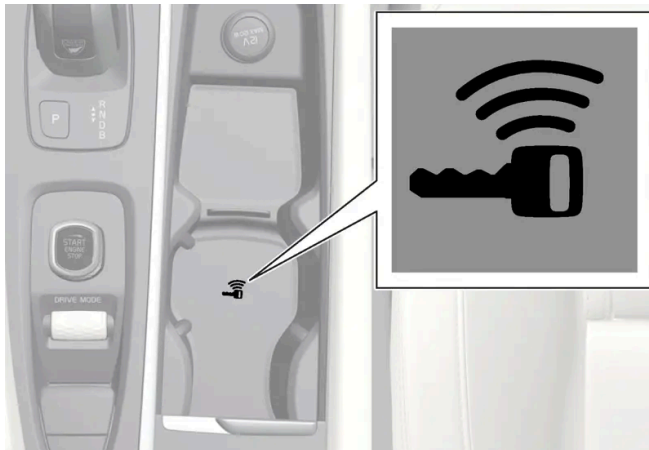

Backup reader's location in the tunnel console.

- When the message **Profile connected to key** is shown, the key and the driver profile are linked.
- 6 Press **OK**.
- This key is now linked to the driver profile and will remain linked as long as the **Connect key** box is not unticked.

4.2.2.4. Protect driver profile

In some cases it is preferable not to save various settings defined in the car to the active driver profile. In this case, it is possible to protect the driver profile.

 **Note**

Protecting a driver profile is only possible when the car is stationary.

To protect a driver profile:

- 1 Press **Settings** in the top view in the centre display.
- 2 Press **System** → **Driver Profiles**.
- 3 Select **Edit Profile**.
 - A menu opens, where the profile can be edited.
- 4 Select **Protect Profile** to protect the profile.
- 5 Save your profile protection option by pressing **Back/Close**.
 - When the profile is protected, settings defined in the car will not be saved automatically to the profile. Instead, your changes must be saved manually under **Settings** → **System** → **Driver Profiles** → **Edit Profile** by pressing **Save current settings to the profile**. When the profile is unprotected, on the other hand, your settings will be saved automatically to the profile.

4.2.2.5. Selecting driver profile

When the centre display has been started, the selected driver profile is shown at the top of the screen. The driver profile last used is the one that will be active next time the car is unlocked. It is possible to change to another driver profile after the car has been unlocked. However, if the remote control key has been linked to a driver profile then this is what is selected when the car is started.

There are three options for changing to another driver profile.

Option 1:

- 1 Tap on the name of the driver profile shown in the top of the centre display when the display has been started.
 - A list of selectable driver profiles is shown.
- 2 Select the driver profile required.
- 3 Press **Confirm**.
 - The driver profile is selected and the system loads the settings for the new driver profile.

Option 2:

- 1 Drag down the top view in the centre display.
- 2 Press **Profile**.
 - The same list as for Option 1 is shown.
- 3 Select the driver profile required.
- 4 Press **Confirm**.
 - The driver profile is selected and the system loads the settings for the new driver profile.

Option 3:

- 1 Drag down the top view in the centre display.
- 2 Press **Settings** in the top view in the centre display.
- 3 Press **System** → **Driver Profiles**.
 - A list of selectable driver profiles is shown.
- 4 Select the driver profile required.
 - The driver profile is selected and the system loads the settings for the new driver profile.

4.2.2.6. Resetting settings in the driver profiles

Settings that have been saved to one or more driver profiles can be reset if the car is stationary.

 **Note**

Factory reset is only possible when the car is stationary.

- 1 Press **Settings** in the top view.
- 2 Press **System** → **Factory reset** → **Reset Personal Settings**.
- 3 Select one of the options **Reset for the active profile**, **Reset for all profiles** or **Cancel**.

4.2.3. Overview of centre display

Many of the car's functions are controlled from the centre display. Presented here is the centre display and its options.

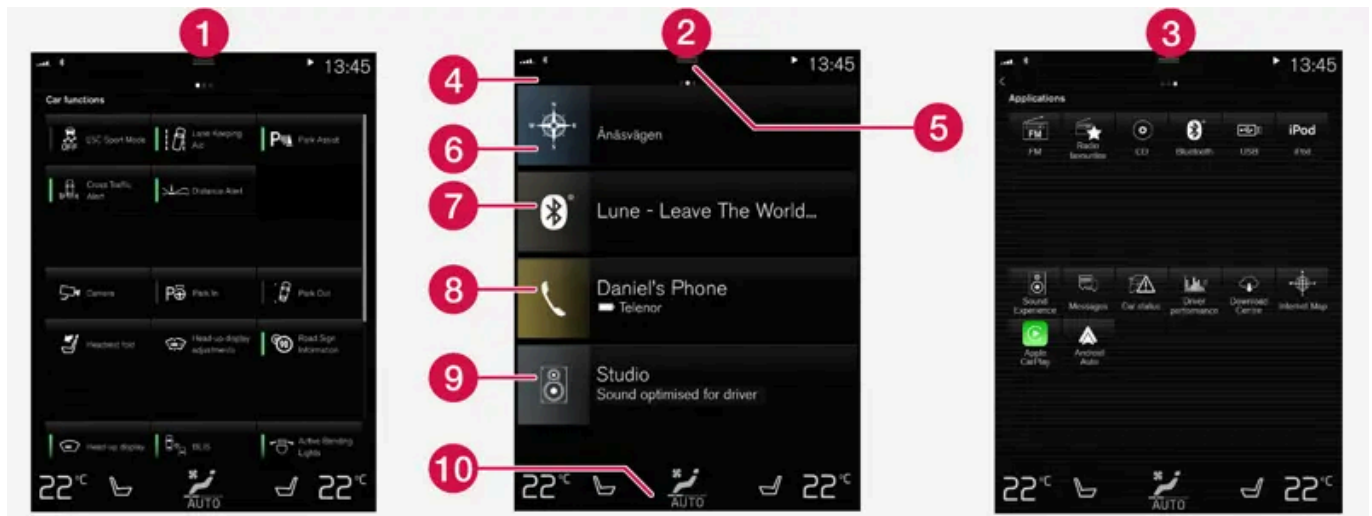

Three of the centre display's basic views. Swipe right or left to access the function or app view respectively^[1].

- 1 Function view - car functions that are activated or deactivated with a press. Certain functions are also so-called trigger functions, which means they open a window with setting options. Examples of these include **Camera**. Settings for the head-up display* are also made from the function view, but adjustments are made using the steering wheel's right-hand keypad.
- 2 Home view - the first view that is shown when the screen is started.
- 3 App view – apps that have been downloaded (third-party apps) and apps for embedded functions, such as **FM radio**. Tap on an app icon to open the app.
- 4 Status bar - the activities in the car are shown right at the top of the screen. Network and connection information is shown on the left-hand side of the status bar, while media-related information, the clock and indication about on-going background activity are shown on the right.
- 5 Top view - drag the tab down in order to access the top view. **Settings, Owner's manual, Profile** and the car's saved messages are accessed from here. In some cases contextual settings (e.g. **Navigation Settings**) and the contextual owner's manual (e.g. **Navigation Manual**) can also be accessed in the top view.
- 6 Navigation - leads to map navigation, with e.g. Sensus Navigation*. Tap on the subview to expand it.
- 7 Media - recently used apps associated with media. Tap on the subview to expand it.
- 8 Phone - the phone function can be reached from here. Tap on the subview to expand it.
- 9 Extra subview - recently used apps or car functions that do not belong in any of the other subviews. Tap on the subview to expand it.
- 10 Climate row - information and direct interaction to set temperature and seat heating for example*. Tap on the symbol in the centre of the climate row in order to open the climate view with more setting options.

Note

If necessary, the climate control can be used to cool the media system in the centre display. In these cases, the message **Climate system Cooling the infotainment system** is shown in the driver display.

[1] The views are reversed for right-hand drive cars.

* Option/accessory.

4.2.4. Activating and deactivating centre display

The centre display can be dimmed and reactivated using the home button beneath the screen.



Home button for the centre display.

The effect of using the home button is that the screen dims and the touchscreen no longer reacts to touch. The climate row will still be shown. All functions connected to the screen are still running, such as climate, audio, navigation* and apps. When the centre display is dimmed, it is a good opportunity to clean the screen.

The dimming function can also be used to fade the screen so that it does not disturb while driving.

- 1 Give a long press on the physical home button below the screen.
 - The screen goes dark except for the climate row, which continues to be shown. All functions connected to the screen are still running.
- 2 Reactivate the screen - briefly tap on the home button.
 - The view that was displayed before the screen was switched off will be shown again.

Note

The screen cannot be deactivated when a prompt to perform an action is shown on the screen.

 **Note**

The centre display deactivates automatically when the engine is off and the driver's door is opened.

* Option/accessory.

4.2.5. Managing the centre display

Many of the car's functions are controlled and regulated from the centre display. The centre display is a touch screen that reacts to touch.

Using the touch screen functionality in the centre display

The screen reacts differently depending on whether it is touched by dragging, swiping, or tapping. Actions such as browsing between different views, marking objects and scrolling in a list can be performed by touching the screen in different ways.

An infrared light curtain just above the surface of the screen enables the screen to detect a finger that is just in front of the screen. This technology makes it possible to use the screen even with gloves on.





Two people can interact with the screen at the same time, e.g. to adjust the climate for the driver and passenger side respectively.

 **Important**

Do not use sharp objects on the screen as they may scratch it.

The table below presents the different procedures for operating the screen:

Procedure	Execution	Result
	Press once.	Highlights an object, confirms a selection or activates a function.
	Press twice in quick succession.	Zooms in on a digital object, such as the map.

Procedure	Execution	Result
	Press and hold.	Grabs an object. Can be used to move apps or map points on the map. Press and hold your finger against the screen and at the same time drag the object to the desired location.
	Tap once with two fingers.	Zooms out from a digital object, such as the map.
	Drag	Changes between different views, scrolls a list, text or view. Hold depressed and drag in order to move apps or map points on the map. Drag horizontally or vertically across the screen.
	Swipe/drag quickly	Changes between different views, scrolls a list, text or view. Drag horizontally or vertically across the screen. Note that touching the upper section of the screen may cause the top view to open.
	Drag apart	Zooms in.
	Drag together	Zooms out.

Returning to home view from another view

- 1 Briefly press the home button below the centre display.
 - The last position of the home view is shown.
- 2 Briefly press again.
 - All subviews of the home view are set to their default mode.

Note

In home view standard mode - briefly press the home button. An animation that describes access to the different views is shown on the screen.

Scrolling in a list, article or view

When a scroll indicator is visible in the screen, it is possible to scroll downward or upward in the view. Swipe downwards/upwards anywhere in the view.

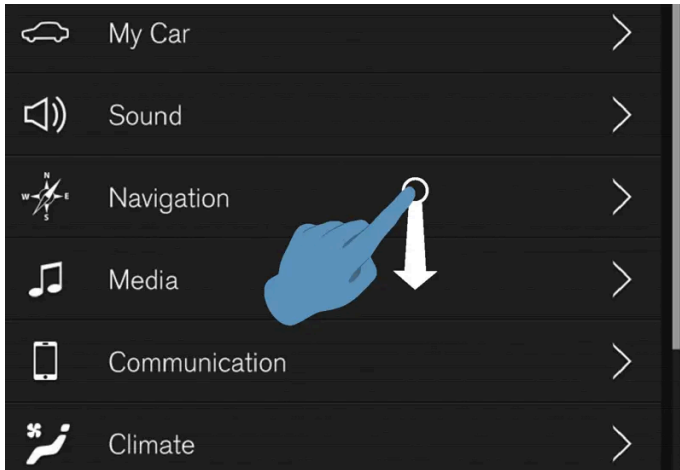

The scroll indicator appears in the centre display when it is possible to scroll in the view.

Using the controls in the centre display



Temperature control.

The control is used for many of the car's functions. Regulate e.g. temperature by means of one of the following:

- drag the control to the desired temperature,
- tap on + or – in order to raise or lower the temperature gradually, or
- tap on the desired temperature on the control.

4.2.6. Navigating in the centre display's views

There are five different basic views in the centre display: home view, top view, climate view, app view and function view. The screen is started automatically when the driver's door is opened.



Home view

Home view is the view that is shown when the screen is started. It consists of four subviews: **Navigation**, **Media**, **Phone** and an extra subview.

An app or car function selected from the app or function view starts in the respective subview of the home view. E.g. **FM radio** starts in the **Media** tile.

The extra tile shows the last used app or car function that is not associated with any of the other three areas.

The subviews show brief information about each different app.

Note

When the car is started, the home view's various sub-views show information on the current status of apps.

Note

In home view standard mode - briefly press the home button. An animation that describes access to the different views is shown on the screen.

Status bar

The activities in the car are shown at the top of the screen. Network and connection information is shown on the left-hand side of the status bar, while media-related information, the clock and indication that background activity is in progress are shown on

the right.

Top view

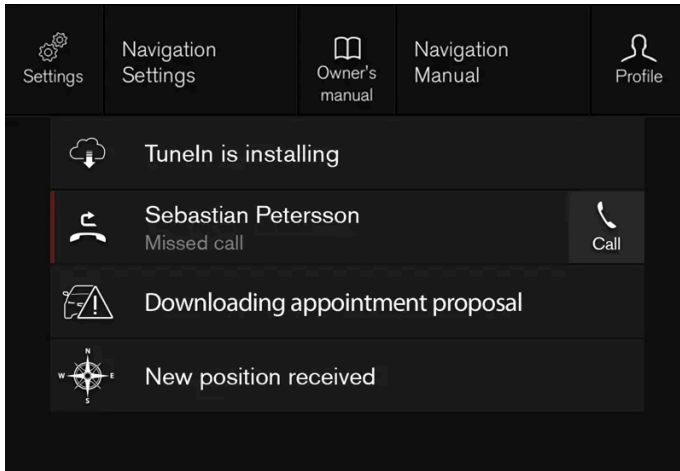

Top view dragged down.

A tab is located in the centre of the status bar at the top of the screen. Open the top view by pressing on the tab or by dragging/swiping from the top downwards across the screen.

In the top view, access is always available to:

- **Settings**
- **Owner's manual**
- **Profile**
- The car's saved messages.

In the top view, access is given to the following in some cases:

- Contextual setting (e.g. **Navigation Settings**). Change settings directly in the top view when an app (e.g. navigation) is running.
- Contextual Owner's Manual (e.g. **Navigation Manual**). Gain access directly in the top view to articles in the digital owner's manual that are related to the content displayed on screen.

Exit the top view - press outside the top view, on the home button or at the bottom of the top view and drag upward. The underlying view is then visible and available for use again.

Note

The top view is not available during starting/shutdown or when a message is shown on the screen. It is also not available when climate view is shown.

Climate view

The climate row is always visible at the bottom of the screen. The most common climate settings can be made directly there, such as setting temperature and seat heating*.



Press the symbol in the centre of the climate row to open the climate view and gain access to more climate settings.



Press the symbol to close the climate view and return to the previous view.

App view



App view with the car's apps.

Swipe from right to left across the screen in order to access the app view from the home view. Apps that have been downloaded (third-party apps) and apps for embedded functions, such as **FM radio**, are found here. Certain apps show brief information directly in the app view, such as the number of unread text messages for **Messages**.

Tap on an app to open it. The app then opens in the tile to which it belongs, e.g. **Media**.

You can scroll down in the app view, depending on the number of apps. Do this by swiping/dragging from the bottom and up.

Go back to the home view again by swiping from left to right across the screen, or by pressing the home button.

Function view



The function view with buttons for different car functions.

Swipe from left to right across the screen in order to access the function view from the home view. From here you can activate or deactivate different car functions, e.g. **BLIS***, **Lane Keeping Aid*** and **Park Assist***.

Depending on the amount of functions, it is also possible here to scroll down in the view. Do this by swiping/dragging from the bottom and up.

Unlike in app view, where an app is opened with a press, a function is activated or deactivated by pressing the relevant function button. Some functions (trigger functions) open in a new window when pressed.

Go back to the home view again by swiping from right to left across the screen, or by pressing the home button.

* Option/accessory.

4.2.7. Managing subviews in centre display

Home view consists of four subviews: **Navigation**, **Media**, **Phone** and an extra subview. These views can be expanded.

Expanding a subview from default mode

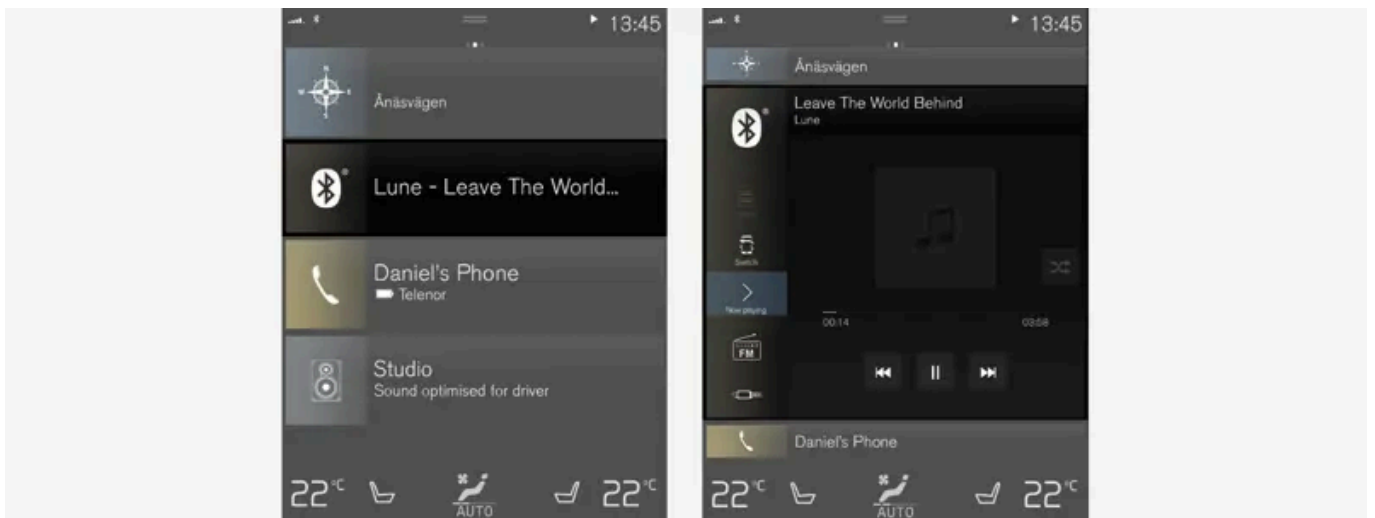

Standard mode and expanded mode of a subview in the centre display.

Expanding a subview:

- 1 For tiles **Navigation**, **Media** and **Phone**: Press anywhere on the subview. When a tile is expanded, the extra tile in the home view is temporarily forced away. The other two tiles are minimised and only certain information is shown. When the extra tile is tapped, the other three tiles are minimised and only certain information is displayed.

The expanded view provides access to the basic functions of the app.

Closing an expanded subview:

- 1 The subview can be closed in three different ways.
 - Tap on the upper part of the expanded subview.
 - Tap on another tile (this tile will then open in expanded mode instead).
 - Briefly press the physical home button below the centre display.

Opening or closing a subview in full screen mode

The extra tile^[1] and the tile for **Navigation** can be opened out in full screen mode, with even more information and more setting options.

When a new subview is opened in full-screen mode, no information from the other subviews is shown.



In expanded mode, open the app in full screen - press on the symbol.



Press on the symbol to go back to the expanded mode, or press the home button at the bottom of the screen.



Home button for the centre display.









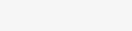
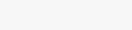
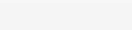

There is always the option to go back to home view by pressing the home button. To go back to the home view's standard view from full screen mode – press twice on the home button.

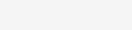
^[1] Does not apply to all apps or car functions opened via the extra tile.

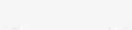
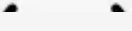
4.2.8. Symbols in the centre display's status bar

Overview of the symbols that can be shown in the centre display's status bar.

The status bar shows activities in progress and, in some cases, their status. Not all symbols are shown all the time due to the limited space in the status bar.

Symbol	Specification
	Connected to the Internet.
	Roaming activated.
	Signal strength in mobile phone network.
	Bluetooth device connected.
	Bluetooth activated but no device connected.
	Information sent to and from GPS.
	Connected to Wi-Fi network.
	Tethering activated (Wi-Fi hotspot). The car then shares the available connection.
	Car modem activated.
	USB sharing active.
	Phone charging wirelessly.
	Process in progress.
	Timer for preconditioning active.
	Audio source being played back.
	Audio source stopped.
	Phone call in progress.
	Audio source muted.
	News is received from the radio channel.
	Traffic information is received.
	Clock.

4.2.9. Function view in centre display

All the buttons for car functions are located in the function view, one of the centre display's basic views. Navigate to the function view from home view by swiping from left to right across the screen ^[1].

Different types of buttons

There are three different types of buttons for car functions; see below:

Type of button	Property	Affects car function
Function buttons	Have on/off positions. When a function is running, an LED indicator illuminates to the left of the icon for the button. Press the button to activate/deactivate a function.	Most buttons in function view are function buttons.
Trigger buttons	Do not have on/off positions. When a trigger button is depressed, a window for the function is opened. For example, it may be a window to change seat position.	<ul style="list-style-type: none"> • Camera • Headrest Fold • Head-up Display Adjustments

Type of button	Property	Affects car function
Parking buttons	Have on, off and scan modes. Similar to the function buttons but with an extra position for parking scanning.	<ul style="list-style-type: none"> • Park In • Park Out

The buttons' different modes



When the LED indicator illuminates in green on a function or parking button, the function is activated. When a function is activated, extra text with an explanation for certain functions is shown. The text is shown for a few seconds and then the button is shown with the LED indicator illuminated.

For **Lane Keeping Aid**, the text **Works only at certain speeds** is shown, for example, when the button is depressed.

Press the button once briefly to activate or deactivate the function.

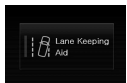

The function is deactivated when the LED indicator is extinguished.

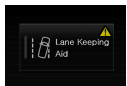

When a warning triangle is shown in the right-hand section of the button there is something not working as intended.

^[1] Applies to left-hand drive cars. For right-hand drive cars - swipe in the opposite direction.

4.2.10. Moving apps and buttons in centre display

The apps and buttons for car functions in the app view and function view respectively can be moved and organised as desired.

- 1 Swipe from right to left^[1] to access the app view, or swipe from left to right^[1] to access the function view.
- 2 Tap on an app or button and hold it down.
 - The app or button changes size and becomes slightly transparent. It is then possible to move it.
- 3 Drag the app or button to a vacant space in the view.

The maximum number of rows available for use in order to position apps or buttons is 48. To move an app or button outside the visible view, drag it to the bottom of the view. New rows are then added, where the app or button can be located.

An app or button can thus be located further down and is then not visible in the normal mode for the view.

Swipe across the screen to scroll up or down in the view.

Note

Hide the apps that you rarely or never use by moving them to the bottom, off the visible screen. This way it will be easier to find the apps you use more often.

Note

Apps and car function buttons cannot be added to locations that are already occupied.

^[1] Applies to left-hand drive cars. For right-hand drive cars - swipe in the opposite direction.

4.2.11. Message in centre display

The centre display can show messages to inform or assist the driver in the event of different events.

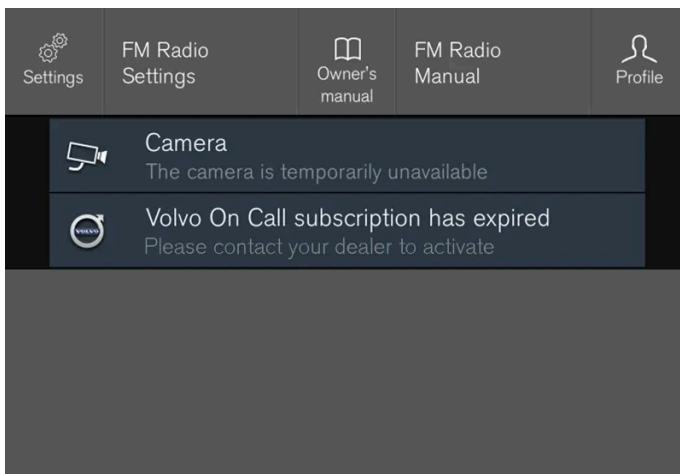

Example of a message in the centre display's top view.

The centre display shows messages that are of lower priority for the driver.

Most messages are shown above the centre display's status bar. After a while, or when any required action related to the message has been taken, the message disappears from the status bar. If a message needs to be saved, it is positioned in the top view in the centre display.

Message composition may vary and they can be shown together with graphics, symbols or a button for activating/deactivating a function linked to the message.

Pop-up messages

In some cases, a message is shown in the form of a pop-up window. Pop-up messages have higher priority than messages shown in the status bar and require acknowledgement/action before they disappear.

4.2.12. Keyboard in the centre display

The centre display keyboard makes it possible to make entries using keys. It is also possible to "draw in" letters and characters on the screen by hand.

The keyboard can be used to enter characters, letters and numbers, e.g. to write text messages from the car, enter passwords or search for articles in the digital owner's manual.

The keyboard is only shown when entries can be made on the screen.



The image shows an overview of some of the buttons which may be shown in the keyboard. The appearance varies depending on language settings and the context in which the keyboard is being used.

- 1 Row of suggested words or characters^[1]. The suggested words are adjusted as new letters are being entered. Browse among the suggestions by pressing on the right and left arrows. Tap on a suggestion to select it. Note that this function is not supported by all language selections. If not available, the row will not be shown on the keyboard.
- 2 The characters available on the keyboard depend on which language was selected (see point 7). Tap on a character to enter it.
- 3 The button works in different ways, depending on the context in which the keyboard is used - either to enter @ (when an email address is entered) or to **create a new row** (for normal text input).
- 4 Hides the keyboard. If this is not possible, the button is not shown.
- 5 Used to enter capital letters. Press again to enter one capital letter and then continue with lower-case letters. Another press makes all letters capital letters. The next press restores the keyboard to lower-case letters. In this mode, the first letter after a full stop, exclamation mark or question mark is a capital letter. The first letter in the text field is also a capital letter. In text fields intended for names or addresses, each word automatically starts with a capital letter. In text fields for password, web address or email address entry, all letters are automatically lower case unless otherwise set with the button.
- 6 Number entry. The keyboard (2) is then shown with numbers. Press **ABC**, which in number mode is shown instead of **123**, to return to the letter keyboard, or **#\~** to open the keyboard with special characters.
- 7 Changes text input language, e.g. **EN**. The available characters and word suggestions (1) vary depending on the selected language. To make it possible to change languages for the keyboard, the languages must first be added under Settings.
- 8 Space.
- 9 Undoes entered text. Pressing briefly deletes one character at a time. Hold the button depressed to delete characters more quickly.
- 10 Changes keyboard mode to write letters and characters by hand instead.

Pressing the confirmation button above the keypad confirms the entered text. The appearance of the button differs depending on context.

The content of this manual represents the status of the user manual at the time of printing and may not be completely valid in future instances. For more information, refer to the first page for the complete disclaimer note.

Variants of a letter or character

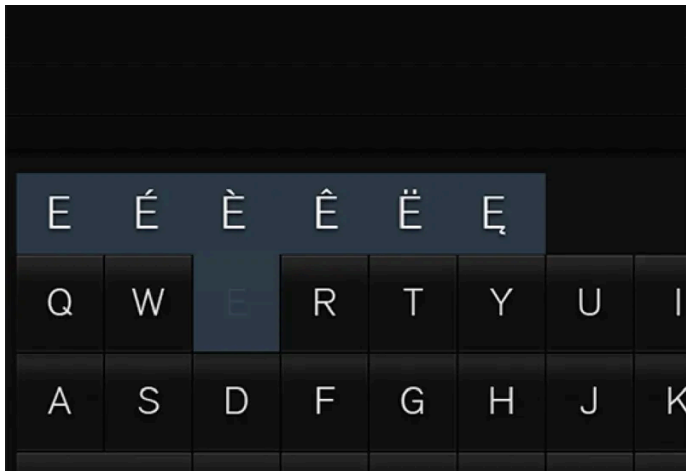

Variants of a letter or character, e.g. **é** or **è**, can be entered by holding down the letter or character. A box is displayed showing possible variants of letters or characters. Press the required variant. If no variant is selected, the original letter/character is entered.

^[1] Applies to Asiatic languages.

4.2.13. Enter the characters, letters and words manually in the centre display

The centre display keyboard allows you to enter characters, letters and words on the screen by "drawing" by hand.



Press the button on the keyboard to change from typing with the keys to entering letters and characters by hand.

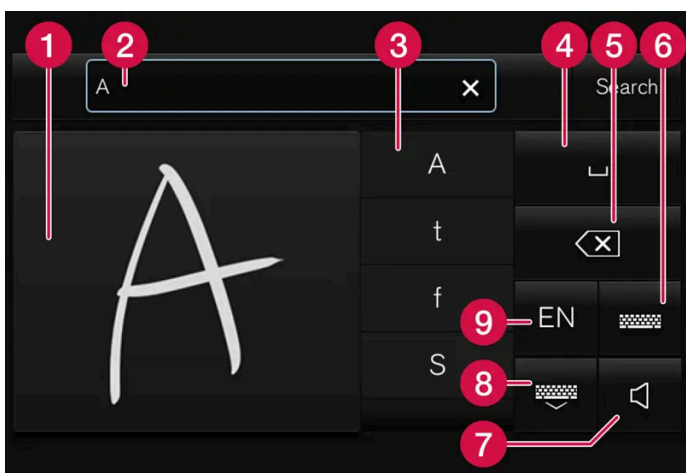

1 Area for writing characters/letters/words/parts of word.

- 2 The text field where the characters or word suggestions ^[1] appear as they are written on screen (1).
- 3 Suggestions for characters/letters/word/part of word. It is possible to scroll through the list.
- 4 Space. A space can also be created by entering a dash (-) in the area for hand-written letters (1). See the heading "Entering a space in the free text field with handwriting recognition" below.
- 5 Undo entered text. Press briefly to delete one character/one letter at a time. Wait a moment before pressing again to delete the next character/letter, etc.
- 6 Return to the keyboard with regular character input.
- 7 Switch off/on sound when entering.
- 8 Hide the keyboard. If this is not possible, the button is not shown.
- 9 Change text input language.

Writing characters/letters/words by hand

- 1 Write a character, a letter, a word or parts of a word in the area for hand-written letters. Write a word or parts of a word above each other or on a line.
 - > A number of suggested characters, letters or words is shown. The most likely choice is found at the top of the list.

! Important

Do not use sharp objects on the screen as they may scratch it.

- 2 Enter the character/letters/word by waiting a moment.
 - > The character/letter/word at the top of the list is entered. It is also possible to select a different character by pressing the required character, letter or word in the list.

Deleting/changing characters/letters written by hand

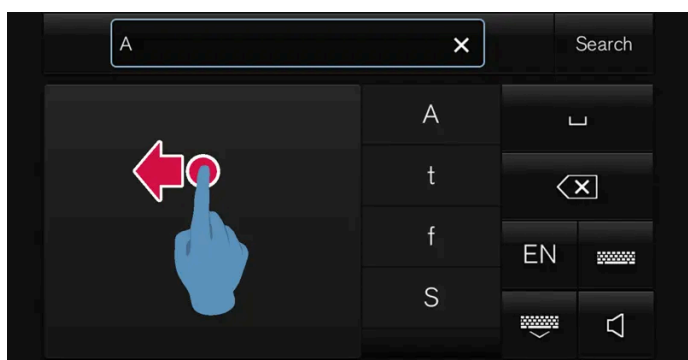

Delete all characters in the text field (2) by swiping across the handwriting field (1).

- 1 There are several options for deleting/changing characters/letters:
 - Press the intended letter or word in the list.

- Press the text undo button to delete the letter and begin again.
- Swipe horizontally from right to left^[2] over the area for handwritten letters. Delete multiple letters by swiping over the area several times.
- Pressing the X in the text field deletes all of the entered text.

Changing row in the free text field with handwriting

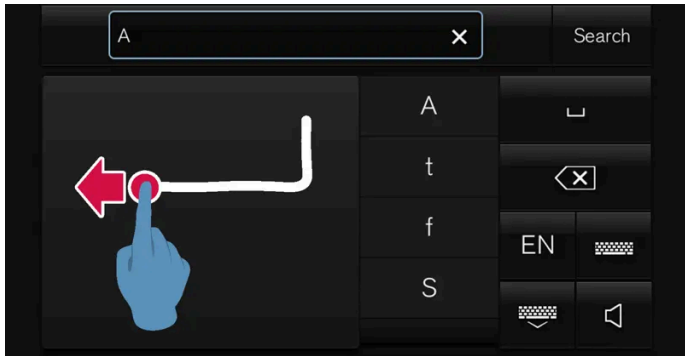

Change row by hand by drawing the above character in the handwriting field^[3].

Entering a space in the free text field with handwriting recognition

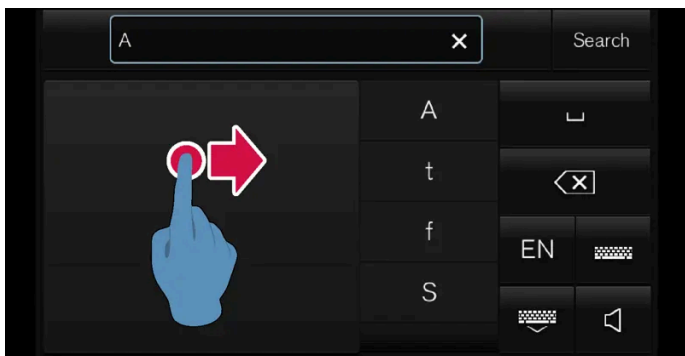

Enter a space by drawing a dash from left to right^[4].

OMRON SOFTWARE

compactWnn © OMORON SOFTWARE Co.,Ltd. 2021 All Rights Reserved.

^[1] Applies to certain system languages.

^[2] For Arabic keyboard - swipe in the opposite direction. Swiping from right to left creates a space.

^[3] For Arabic keyboards - draw the same character, but reversed.

^[4] For Arabic keyboard - draw the dash from right to left.

4.2.14. Changing keyboard language in centre display

To make it possible to switch between different languages for the keyboard, the languages must first be added under **Settings**.

Adding or deleting languages in settings

The keyboard is automatically set to the same languages as the system language. The keyboard language can be manually adapted without affecting the system language.

- 1 Press **Settings** in the top view.
 - 2 Press **System** → **System Languages and Units** → **Keyboard Layouts**.
 - 3 Select one or more languages from the list.
- It is now possible to switch between the selected languages directly from the keyboard for text input.

If no languages have been actively selected under **Settings**, the keyboard retains the same language as the car's system language.

Switching between different languages in the keyboard



When a number of languages have been selected in **Settings**, the button in the keyboard is used to switch between the different languages.

To change keyboard language with list:

- 1 Give a long press on the button.
- A list opens.
- 2 Select the required language. If more than four languages have been selected under **Settings**, it is possible to scroll in the list from the keyboard.
- The keyboard is adapted to the selected language and other word suggestions are given.

To change the keyboard language without displaying the list:

- 1 One short press of the button.
- The keyboard is adapted to the next language in the list without displaying the list.

4.2.15. Show trip statistics in centre display

Trip statistics from the trip computer are displayed graphically in the centre display and provide an overview that facilitates more fuel-efficient driving.



Open the **Driver performance** app in app view in order to show the trip statistics.

Each bar in the diagram symbolises a distance of 1, 10 or 100 km, alternatively miles. The bars are filled in from the right as driving progresses. The bar on the far right shows the value for the current distance.

The average fuel consumption and total driving time are calculated since the last time the trip statistics were reset.

Fuel and electricity consumption are shown in separate graphs. Electricity consumption is "net" consumption, i.e. energy consumed minus regenerated energy created during braking.



Trip statistics from the trip computer^[1].

Note

When driving with electric operation, fuel consumption can be indicated in the trip statistics if the additional heater^[2] is running.

^[1] The figure is schematic - parts may vary depending on car model.

^[2] Applicable to fuel-driven auxiliary heater.

4.2.16. Owner's manual in centre display

A digital^[1] version of the owner's manual is available in the car's centre display.

The digital owner's manual can be accessed from the top view, and in some cases the contextual owner's manual can also be accessed from the top view.

Note

The digital owner's manual is not available while driving.

Owner's manual

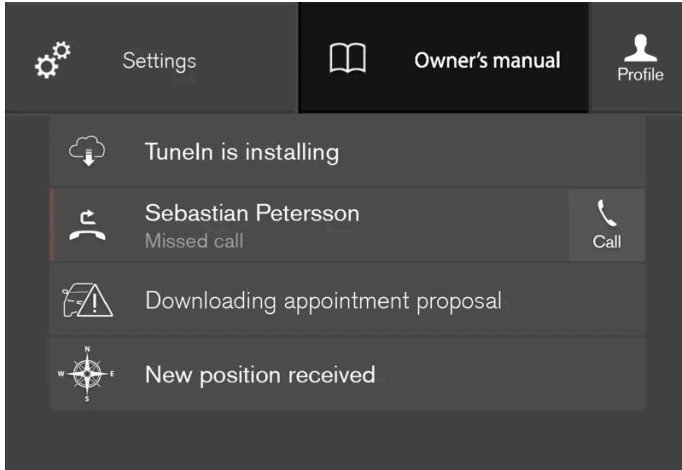

Top view with button for owner's manual.

To open the owner's manual - drag down the top view in the centre display and tap on **Owner's manual**.

The information in the owner's manual can be accessed directly via the owner's manual homepage or its top menu.

Contextual owner's manual

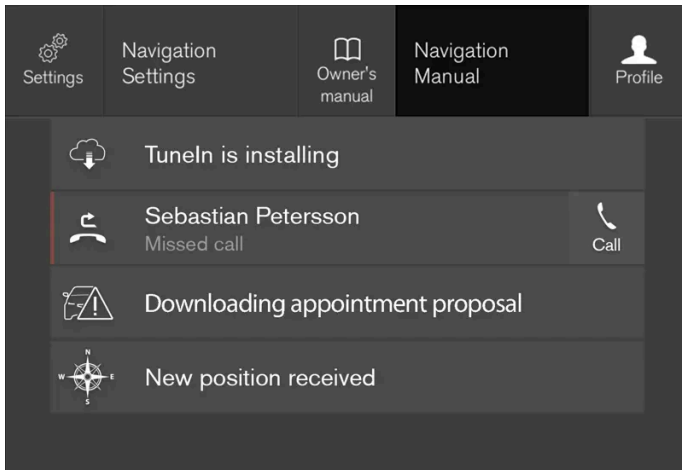

Top view with button for contextual owner's manual.

The contextual owner's manual is a shortcut to an article in the owner's manual that describes the active function shown on the screen. When the contextual owner's manual is available, it is shown to the right of **Owner's manual** in the top view.

Tapping on the contextual owner's manual therefore opens an article in the owner's manual that is related to the content that is shown on the screen. E.g. tap on **Navigation Manual** – an article that is related to navigation opens.

This only applies to some of the apps in the car. For downloaded third party apps, for example, it is not possible to access app-specific articles.

[1] Applies for most markets.

4.2.17. Navigate in the owner's manual in the centre display

The digital owner's manual can be accessed from the centre display top view in the car. The content is searchable, and the various sections are designed to facilitate navigation.

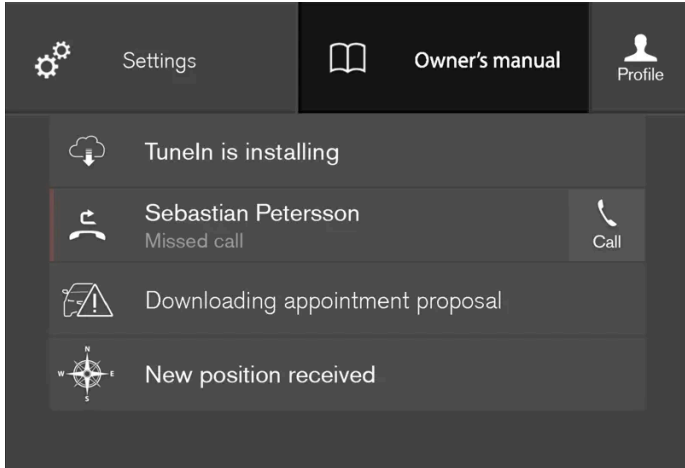

The owner's manual is accessed from the top view.

- 1 To open the owner's manual - drag down the top view in the centre display and tap on **Owner's manual**.

There is a range of different options for finding information in the owner's manual. The options can be accessed from the owner's manual homepage and from the top menu.

Opening the menu in the top menu

- 1 Press ☰ in the upper list in the owner's manual.
 - > A menu with different options for finding information is opened:

Homepage



Tap on the symbol to go back to the start page in the owner's manual.

Categories

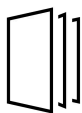

The articles in the owner's manual are structured into main categories and subcategories. The same article can be found in several appropriate categories so that it can be found more easily.

1 Press **Categories**.

➤ The main categories are shown in a list.

2 Tap on a main category ().

➤ A list of subcategories () and articles () is shown.

3 Tap on an article to open it.

To go back, press the back arrow.

Featured articles



Press the symbol to access a page with links to a selection of articles that can be useful to read in order to get to know the more common functions of the car. The articles can also be accessed via categories, but are collected here for faster access. Tap on an article in order to read it in its entirety.

Hotspots for exterior and interior



Exterior and interior overview images of the car. Different parts are designated with hotspots that lead to articles about those parts of the car.



1 Press **Exterior** or **Interior**.

➤ Exterior or interior images are shown with so-called hotspots in place. The hotspot leads to articles about the corresponding part of the car. Swipe horizontally over the screen to browse among the images.

2 Tap on a hotspot.

➤ The title of the article about the area is shown.

3 Tap on the title to open the article.

To go back, press the back arrow.

Favourites



Press the symbol to access the articles saved as favourites. Tap on an article in order to read it in its entirety.

Saving or deleting articles as favourites

Save an article as favourite by pressing ☆ at the top right when an article is open. When an article has been saved as a favourite the star is filled in: ★.

To remove an article as a favourite, press the star again in the current article.

Video



Press the symbol to view brief instruction videos for various functions in the car.

Information



Tap on the symbol to obtain information about which version of the owner's manual is available in the car as well as other useful information.

Using the search function in the top menu

- 1 Tap on Q in the top menu of the owner's manual. A keyboard appears in the lower part of the screen.
- 2 Type in a keyword, such as "seatbelt".
 - Suggestions for articles and categories are shown while letters are being entered.
- 3 Tap on the article or category to access it.

4.3. Head-up display

4.3.1. Head-up display*

The head-up display supplements the car's driver display and projects information from the driver display onto the windscreen. The projected image can only be seen from the driver position.



The head-up display shows warnings and information relating to speed, cruise control functions, navigation, etc. in the driver's field of vision. Road Sign Information and incoming phone calls can also be shown in the head up display.

Note

The driver's ability to see the information in the head-up display is impaired by the following

- use of polarising sunglasses
- a driving position which means that the driver is not sitting centred in the seat
- objects on the display unit's cover glass
- unfavourable light conditions.

Important

The display unit from which the information is projected is located in the instrument panel. To avoid damage to the display unit's cover glass - do not store any objects on the cover glass and make sure that no objects fall down onto it.

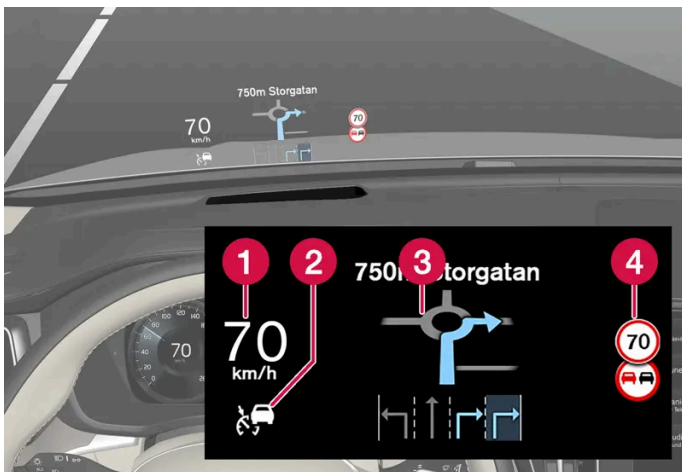

Examples of what can be shown in the display.

- 1 Speed
- 2 Cruise control
- 3 Navigation
- 4 Road signs

Note

Certain visual defects may cause headaches and a feeling of stress during the use of the head-up display.

City Safety in the head-up display



In the event of a collision warning, the information in the head-up display is replaced by the warning symbol for City Safety. This graphic is illuminated even if the head-up display is switched off.



The warning symbol for City Safety flashes in order to attract the driver's attention if there is a risk of collision.

Symbols in the head-up display

A number of symbols can be shown temporarily in the head-up display.

Symbol	Specification
	Warning symbol – read the warning message in the driver display.
	Information symbol – read the message in the driver display.
	The snowflake symbol illuminates in the event of a risk of icy conditions.

* Option/accessory.

4.3.2. Head up display when replacing the windscreen*

Cars with head-up display are equipped with a special type of windscreen that meets the requirements for displaying the projected image.

Volvo recommends that you contact an authorised Volvo workshop when replacing the windscreen. The correct version of the windscreen must be fitted in order that the head-up display's graphics shall be displayed correctly.

* Option/accessory.

4.3.3. Activating and deactivating the head-up display*

The head-up display can be activated and deactivated when the car has been started.

Activate/deactivate the function in the centre display's function view.



Press the **Head-up Display** button.

➤ The head-up display is activated/deactivated.

* Option/accessory.

4.3.4. Settings for head-up display*

Adjust the settings for the head-up display's projection onto the windscreen.

Settings can be defined when the car has been started and a projected image is shown on the windscreen.

Selecting display options

Select which functions are to be shown in the head-up display.

1 Tap on **Settings** in the centre display's top view.

2 Press My Car → Displays → Head-Up Display Options.

3 Select one or more functions:

- Show Navigation
- Show Road Sign Information
- Show Driver Support
- Show Phone

The setting is saved as a personal setting in the driver profile.

Adjusting brightness and vertical position

1



Press the **Head-up Display Adjustments** button in the centre display function view.

2 Adjust the brightness and vertical position of the projected image in the driver's field of vision using the steering wheel's right-hand keypad.

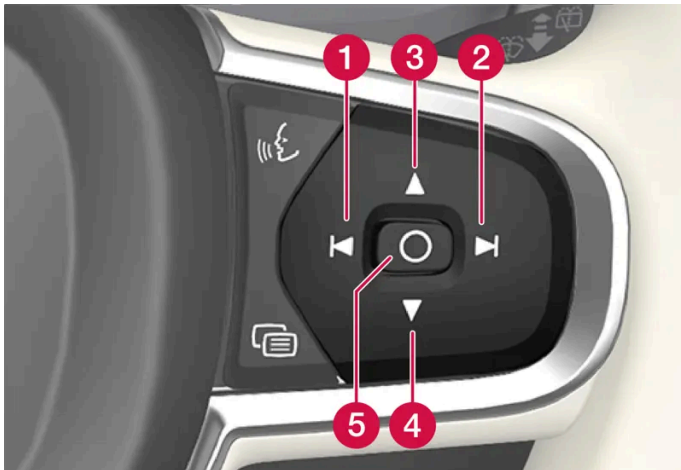

- 1 Reducing the brightness
- 2 Increasing the brightness
- 3 Raising the position
- 4 Lowering the position
- 5 Confirm

The brightness of the graphics is automatically adapted to their background light conditions. The brightness is also affected by the adjustment of the brightness in the car's other displays.

The height position can be stored in the memory function for the power* front seat using the keypad in the driver's door.

Calibrate the horizontal position

The head-up display's horizontal position may need to be calibrated if the windscreen or display unit is replaced. Calibration means that the projected image is rotated clockwise or anticlockwise.

- 1 Tap on **Settings** in the centre display's top view.
- 2 Select **My Car** → **Displays** → **Head-Up Display Options** → **Head-Up Display Calibration**.
- 3 Calibrate the image's horizontal position with the steering wheel's right keypad.

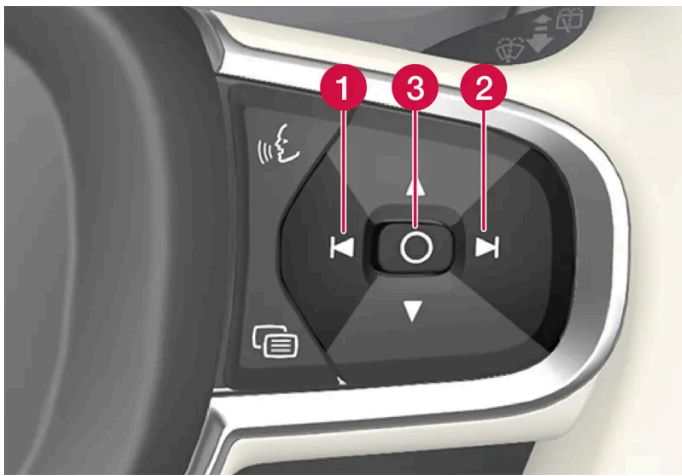

- 1 Rotate anticlockwise
- 2 Rotate clockwise
- 3 Confirm

* Option/accessory.

4.3.5. Cleaning the Head-up display*

Gently wipe the display's cover glass with a clean and dry microfibre cloth. If necessary, lightly moisten the microfibre cloth.

Never use strong stain removers. A special cleaning agent available from Volvo dealers can be used for more difficult cleaning.

* Option/accessory.

4.3.6. Using a stored position for seat, door mirrors and head-up display*

If the positions for the power* seat, the door mirrors and the head-up display* have been stored, they can be activated by using the memory buttons.

Using a stored setting

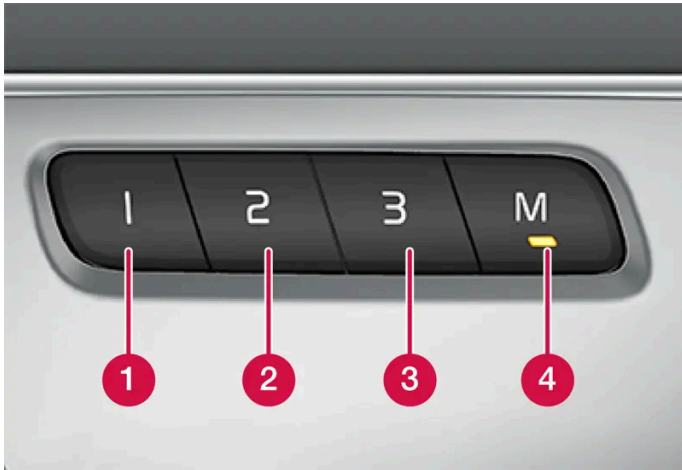

A stored setting can be used with the front door either open or closed:

Open front door

- 1 Press one of the memory buttons 1 - 3 with a brief touch. Power seat, door mirrors and head-up display move and then stop at the positions stored in the selected memory button.

Closed front door

- 1 Hold one of the memory buttons 1 - 3 depressed until seat, door mirrors and head-up display stop in the positions that are stored in the selected memory button.

If the memory button is released, the movement of the seat, door mirrors and head-up display will be stopped.

Warning

- Because the driver's seat can be adjusted with the ignition off, children should never be left unattended in the vehicle.
- Movement of the seat can be STOPPED at any time by pressing any button on the power seat control panel.
- Do not adjust the seat while driving.
- Make sure there is nothing under the seats when they are being adjusted.

Note

All driver profiles need to be set in **Protect Profile** mode in order for the stored positions to work.

* Option/accessory.

4.3.7. Storing position for seat, door mirrors and head-up display*

You can store the position for power* seat, door mirrors and head-up display* in the memory buttons.

Store three different positions for the power* seat, the door mirrors and the head-up display* using the memory buttons. The buttons are located on the inside of one of the front doors or both*.

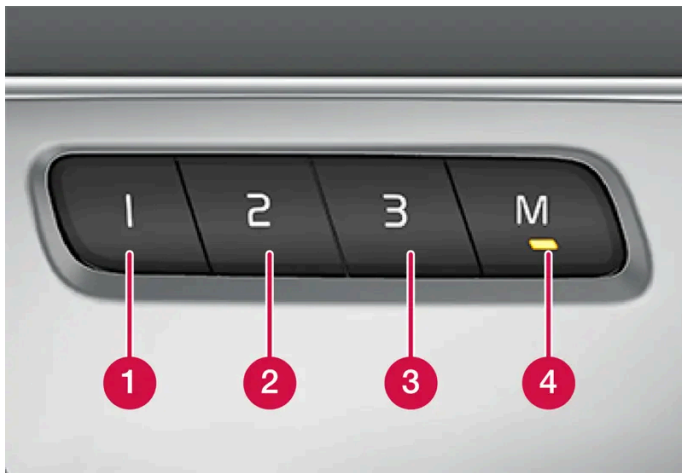

- 1 Memory button.
- 2 Memory button.
- 3 Memory button.
- 4 Button **M** for storing settings.

Storing a position

- 1 Adjust seat, door mirrors and head-up display to the desired position.
 - 2 Press and hold the **M** button depressed. The light indicator in the button illuminates.
 - 3 Press and hold the 1, 2 or 3 button within three seconds.
- When the position has been stored in the selected memory button, an acoustic signal can be heard and the light indicator in the **M** button extinguishes.

If none of the memory buttons is depressed within three seconds then the M button extinguishes and no storing takes place.

The seat, the door mirrors or the head-up-display must be readjusted before a new memory can be set.

Note

All driver profiles need to be set in **Protect Profile** mode in order for the stored positions to work.

* Option/accessory.

4.3.8. Navigation system* in head-up display*

The navigation system is presented and operated in several different ways, e.g. via the head-up display.

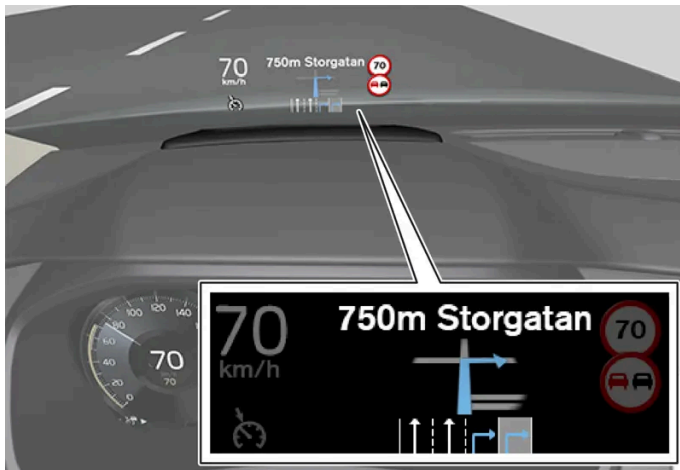

Navigation system on windscreen.

The driver can receive guidance and information from the navigation system in the head-up display at the bottom of the windscreen.

Whether or not the navigation system should be shown in the head-up display can be set, as well as the position of the information field.

* Option/accessory.

4.4. Symbols and messages

4.4.1. Message handling

4.4.1.1. Message in centre display

The centre display can show messages to inform or assist the driver in the event of different events.

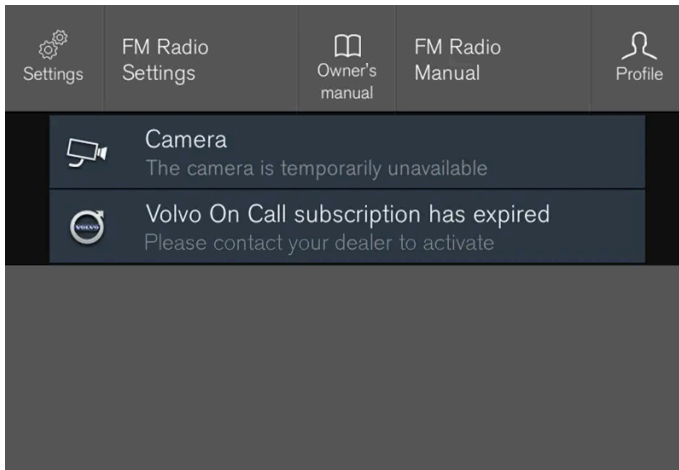

Example of a message in the centre display's top view.

The centre display shows messages that are of lower priority for the driver.

Most messages are shown above the centre display's status bar. After a while, or when any required action related to the message has been taken, the message disappears from the status bar. If a message needs to be saved, it is positioned in the top view in the centre display.

Message composition may vary and they can be shown together with graphics, symbols or a button for activating/deactivating a function linked to the message.

Pop-up messages

In some cases, a message is shown in the form of a pop-up window. Pop-up messages have higher priority than messages shown in the status bar and require acknowledgement/action before they disappear.

4.4.1.2. Managing messages in the centre display

Messages in the centre display are handled in centre display views.

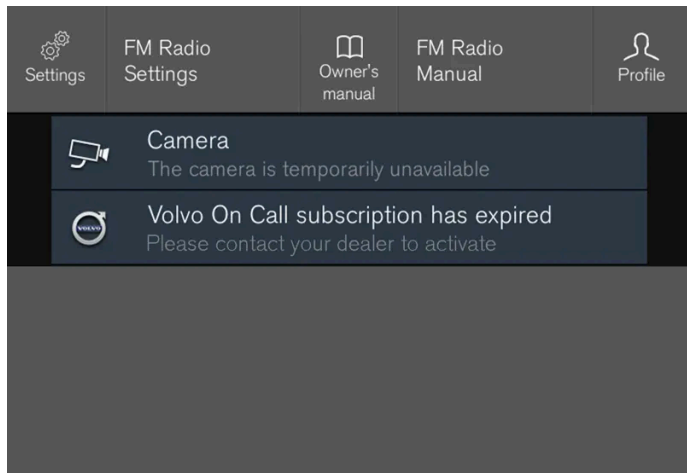

Example of a message in the centre display's top view.

Some messages in the centre display have a button (or several buttons in pop-up messages) for e.g. activating/deactivating a function linked to the message.

Managing a new message

For messages with buttons:

- 1 Press the button to perform the action or allow the message to close automatically after a while.
 - > The message disappears from the status bar.

For messages without buttons:

- 1 Close the message by tapping on it, or allow the message to close automatically after a while.
 - > The message disappears from the status bar.

If a message needs to be saved, it is positioned in the top view in the centre display.

4.4.1.3. Handling a message saved from the centre display

Whether saved from the driver display or the centre display, messages are managed in the centre display.

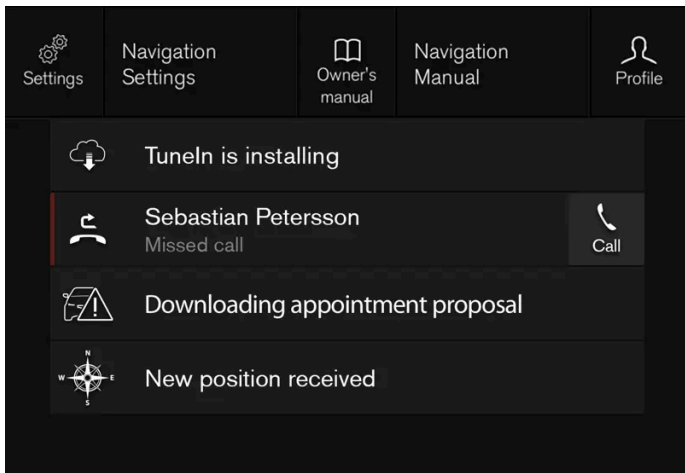

Examples of saved messages and possible options in the top view.

Messages that are shown in the centre display that need to be saved are added in the top view of the centre display.

Reading a saved message

- 1 Open the top view in the centre display.
 - A list of saved messages is shown. Messages with an arrow to the right can be maximised.
- 2 Tap on a message to expand/minimise.
 - More information on the message is shown in the list and the image to the left in the app shows information about the message graphically.

Managing a saved message

Some messages have a button for e.g. activating/deactivating a function linked to the message.

- 1 Press the button to perform the action.

Saved messages in the top view are deleted automatically when the car is switched off.

4.4.1.4. Messages in the driver display

The driver display can show messages to inform or assist the driver in the event of different events.



Examples of messages in the driver display. The figure is schematic - parts may vary depending on car model.

The driver display shows messages that are of high priority for the driver.

Messages can be shown in different parts of the driver display depending on what other information is currently being displayed. After a while, or when the message has been acknowledged/action taken if required, the message disappears from the driver display. If a message needs to be saved, it is placed in the **Car Status** app, which is opened from the app view in the centre display.

Message composition may vary and they can be shown together with graphics, symbols or buttons for acknowledging the message or accepting a request, for example.

Service messages

Shown below is a selection of important service messages and their meanings.

Message	Specification
Stop safely ^[1]	Stop and switch off the engine. Serious risk of damage - consult a workshop ^[2] .
Turn off engine ^[1]	Stop and switch off the engine. Serious risk of damage - consult a workshop ^[2] .
Service urgent Drive to workshop ^[1]	Contact a workshop ^[2] to check the car immediately.
Service required ^[1]	Contact a workshop ^[2] to check the car as soon as possible.
Regular maintenance Book time for maintenance	Time for regular service - contact a workshop ^[2] . Shown before the next service date.
Regular maintenance Time for maintenance	Time for regular service - contact a workshop ^[2] . Shown at the next service date.
Regular maintenance Maintenance overdue	Time for regular service - contact a workshop ^[2] . Shown when the service date has passed.
Temporarily off ^[1]	A function has been temporarily switched off and is reset automatically while driving or after starting again.

^[1] Part of message, shown together with information on where the problem has arisen.

^[2] An authorised Volvo workshop is recommended.

4.4.1.5. Managing messages in the driver display

Messages in the driver display are handled using the steering wheel's right-hand keypad.



Examples of messages in the driver display and the steering wheel's right-hand keypad. The figure is schematic - parts may vary depending on car model.

- 1 Left/right
- 2 Confirm

Some messages in the driver display contain one or more buttons for acknowledging the message or accepting a request, for example.

Managing a new message

For messages with buttons:

- 1 Navigate between the buttons by pressing on the left or right (1).
 - 2 Confirm the selection by pressing on confirm (2).
- The message disappears from the driver display.

For messages without buttons:

- 1 Close the message by pressing on confirm (2), or allow the message to close automatically after a while.
- The message disappears from the driver display.

If a message needs to be saved, it is placed in the **Car Status** app, which is opened from the app view in the centre display. The message **Car message stored in Car Status application** is shown in the centre display in conjunction with this.

4.4.1.6. Handling a message saved from the driver display

Whether saved from the driver display or the centre display, messages are managed in the centre display.

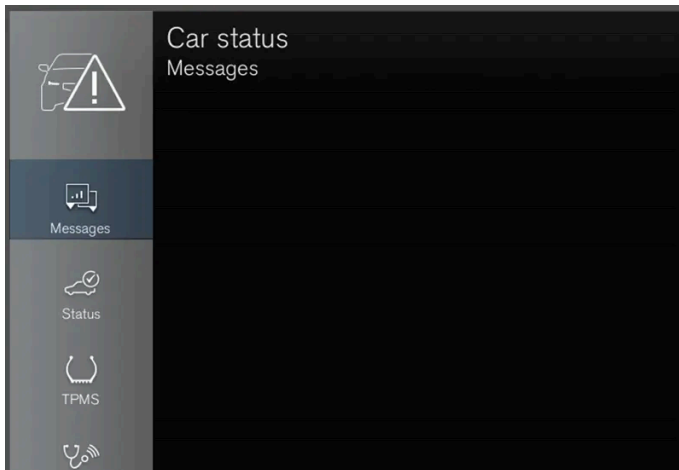

Saved messages can be seen in the **Car Status** app.

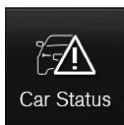

Messages that are shown in the driver display and that need to be saved are added in the **Car Status** app in the centre display. The message **Car message stored in Car Status application** is shown in the centre display in conjunction with this.

Reading a saved message

To read a saved message immediately:

- 1 Press the button to the right of the **Car message stored in Car Status application** message in the centre display.
 - > The saved message is shown in the **Car Status** app.

To read a saved message later:

- 1 Open the **Car Status** app from the app view in the centre display.
 - > The app is opened in the bottom subview of the home view.
- 2 Select the **Messages** tab in the app.
 - > A list of saved messages is shown.
- 3 Tap on a message to expand/minimise.
 - > More information on the message is shown in the list and the image to the left in the app shows information about the message graphically.

Managing a saved message

The content of this manual represents the status of the user manual at the time of printing and may not be completely valid in future instances. For more information, refer to the first page for the complete disclaimer note.

In maximised mode, some messages have two buttons available to book service or read the owner's manual.

To book service for a saved message:

- 1 In maximised mode for the message, press **Request appoint. Call to make Appointment**^[1] for help in booking service.
 - With **Request appoint.:** The **Appointments** tab opens in the app and creates a request to book service and repair work.
 - With **Call to make Appointment:** The phone app is initiated and calls a service centre to book service and repair work.

To read the owner's manual for a saved message:

- 1 In maximised mode for the message, press **Owner's manual** to read about the message in the owner's manual.
 - The owner's manual opens in the centre display and shows information linked to the message.

Saved messages in the app are deleted automatically each time the engine is started.

^[1] Market dependent. Volvo ID and selected workshop also need to be registered.

4.4.2. Messages for BLIS

A number of messages regarding BLIS^[1] can be shown in the driver display. Here are some examples.

Message	Specification
Blind spot sensor Service required	The system does not function as it should. A workshop should be contacted ^[2] .
Blind spot system off Trailer attached	BLIS and CTA ^[3] have been deactivated as a trailer has been connected to the car's electrical system.

A text message can be cleared by briefly pressing the  button, located in the centre of the steering wheel's right-hand keypad.

If a message remains, contact a workshop - an authorised Volvo workshop is recommended.

^[1] Blind Spot Information

^[2] An authorised Volvo workshop is recommended.

* Option/accessory.

^[3] Cross Traffic Alert*

4.4.3. Messages for City Safety

A number of messages regarding City Safety can be shown in the driver display. Here are some examples.

Message	Specification
City Safety Automatic intervention	When City Safety brakes or has done an automatic braking, several of the driver display symbols may be illuminated in connection with a text message being shown.
City Safety Reduced functionality Service required	The system does not function as it should. A workshop should be contacted ^[1] .

A text message can be cleared by briefly pressing the  button, located in the centre of the steering wheel's right-hand keypad.

If a message persists, contact a workshop^[1].

^[1] An authorised Volvo workshop is recommended.

4.4.4. Messages for Cross Traffic Alert *

A number of messages regarding Cross Traffic Alert (CTA) can be shown in the driver display. Here are some examples.

Message	Specification
Blind spot sensor Service required	The system does not function as it should. A workshop should be contacted ^[1] .
Blind spot system off Trailer attached	BLIS ^[2] and CTA have been deactivated as a trailer has been connected to the car's electrical system.

A text message can be cleared by briefly pressing the  button, located in the centre of the steering wheel's right-hand keypad.

If a message remains, contact a workshop - an authorised Volvo workshop is recommended.





* Option/accessory.

^[1] An authorised Volvo workshop is recommended.

^[2] Blind Spot Information System

4.4.5. Symbols and messages for electronic stability control

A number of symbols and messages regarding electronic stability control (ESC^[1]) can be shown on the driver display. Here are some examples.

Symbol	Message	Specification
	Constant glow for approx. 2 seconds	System check when the engine is started.
	Flashing light	The system is being activated.
	Constant glow	Sport mode is activated. NOTE: The system is not deactivated in this mode – it is partly reduced.
	ESC Temporarily off	The system has been temporarily reduced due to excessive brake temperature - the function is reactivated automatically when the brakes have cooled.
	ESC Service required	The system is disengaged. Stop the car in a safe place, switch off the engine and start it again.





A text message can be cleared by briefly pressing the  button, located in the centre of the steering wheel's right-hand keypad.

If a message remains, contact a workshop - an authorised Volvo workshop is recommended.

^[1] Electronic Stability Control

4.4.6. Symbols and messages for adaptive cruise control*

A number of symbols and messages regarding the adaptive cruise control^[1] (ACC^[2]) can be shown. Here are some examples.

Symbol	Message	Specification
	The symbol is lit	The car is maintaining the stored speed.
	Adaptive Cruise Contr. Unavailable The symbol is extinguished	Adaptive cruise control is set to standby mode.
	Adaptive Cruise Contr. Service required The symbol is extinguished	The system does not function as it should. A workshop should be contacted - an authorised Volvo workshop is recommended.
	Windscreen sensor Sensor blocked, see Owner's manual	Clean the windscreen in front of the camera and radar unit's detectors.

A text message can be cleared by briefly pressing the  button, located in the centre of the steering wheel's right-hand keypad.

If a message remains, contact a workshop - an authorised Volvo workshop is recommended.



* Option/accessory.

^[1] This function can be either standard or optional, depending on market.

^[2] Adaptive Cruise Control

4.4.7. Symbols and messages for Pilot Assist*

A number of symbols and messages regarding Pilot Assist^[1] can be shown. Here are some examples.

Symbol	Message	Specification
	Steering wheel symbol extinguished	Indicates deactivated steering assistance. When Pilot Assist provides steering assistance, the steering wheel is lit up.
	Symbol for hands on the steering wheel	The system cannot detect whether the driver has his/her hands on the steering wheel. Place your hands on the steering wheel and actively steer the car.
	Windscreen sensor Sensor blocked, see Owner's manual	Clean the windscreen in front of the camera and radar unit's detectors.

A text message can be cleared by briefly pressing the  button, located in the centre of the steering wheel's right-hand keypad.





If a message remains, contact a workshop - an authorised Volvo workshop is recommended.

* Option/accessory.

^[1] This function can be either standard or optional, depending on market.

4.4.8. Symbols and messages for lane assistance

A number of symbols and messages regarding lane assistance (LKA^[1]) can be shown on the driver display. Here are some examples.

Symbol	Message	Specification
	Driver support system Reduced functionality Service required	The system does not function as it should. A workshop should be contacted ^[2] .
	Windscreen sensor Sensor blocked, see Owner's manual	The ability of the camera to scan the roadway in front of the car is reduced.
	Lane Keeping Aid Apply steering	The LKA steering assistance does not function if the driver does not have his/her hands on the steering wheel. Follow the instruction and steer the car.
	Lane Keeping Aid Standby until steering applied	LKA is set in standby mode until the driver starts to steer the car again.

A text message can be cleared by briefly pressing the  button, located in the centre of the steering wheel's right-hand keypad.

If a message remains, contact a workshop - an authorised Volvo workshop is recommended.

^[1] Lane Keeping Aid

[2] An authorised Volvo workshop is recommended.

4.4.9. Display mode for lane assistance

Lane assistance (LKA^[1]) is visualised by symbols in the driver display depending on the situation.



Here are some examples of symbols and the situations in which they are shown:

Available



Available – the lane lines in the symbol are white.

Lane assistance is scanning one or both lane lines.

Unavailable

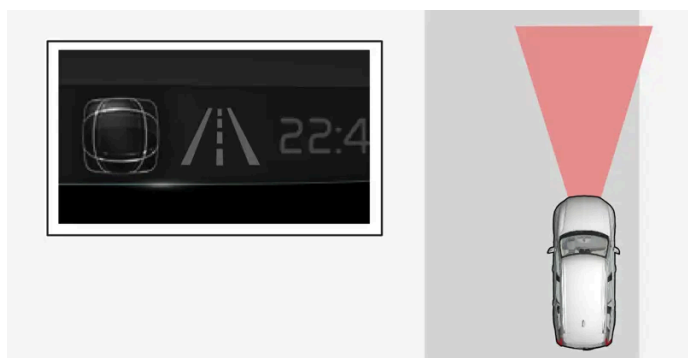

Unavailable – the lane lines in the symbol are extinguished.

The Lane assistance cannot detect the lane lines, the speed is too low or the road is too narrow.

Indication of steering assistance/warning



Steering assistance/warning – the lane lines in the symbol are coloured.

Lane assistance indicates that the system is giving a warning and/or attempting to steer the car back into the lane.

^[1] Lane Keeping Aid

4.4.10. Messages for Park Assist Pilot*

Messages for Park Assist Pilot (PAP^[1]) can be shown in the driver display and/or the centre display. Here are some examples.

Message	Specification
Park Assist System Sensors blocked, cleaning needed	One or more of the function's sensors are blocked - check and correct as soon as possible.
Park Assist System Unavailable Service required	The system does not function as it should. A workshop should be contacted ^[2] .

A text message can be cleared by briefly pressing the  button, located in the centre of the steering wheel's right-hand keypad.

If a message remains, contact a workshop - an authorised Volvo workshop is recommended.

* Option/accessory.

^[1] Park Assist Pilot

^[2] An authorised Volvo workshop is recommended.

4.4.11. Symbols and messages for Park Assist

Symbols and messages for Park Assist System (PAS^[1]) can be shown in the driver display and/or the centre display. Here are some examples.

Symbol	Message	Specification
		The rearward parking assistance sensors are deactivated , so there are no acoustic warnings for obstacles/objects.
	Park Assist System Sensors blocked, cleaning needed	One or more of the function's sensors are blocked - check and correct as soon as possible.
	Park Assist System Unavailable Service required	The system does not function as it should. A workshop should be contacted ^[2] .

A text message can be cleared by briefly pressing the  button, located in the centre of the steering wheel's right-hand keypad.



If a message remains, contact a workshop - an authorised Volvo workshop is recommended.

^[1] Park Assist System

^[2] An authorised Volvo workshop is recommended.

4.4.12. Symbols and messages for Park assist camera

Symbols and messages for Park assist camera (PAC^[1]) can be shown in the driver display and/or the centre display. Here are some examples.

Symbol	Message	Specification
		The rearward parking assistance sensors are deactivated , so there are no acoustic warnings and field marks for obstacles/objects.
		The camera is disengaged.
	Park Assist System Sensors blocked, cleaning needed	One or more of the function's sensors are blocked - check and correct as soon as possible.
	Park Assist System Unavailable Service required	The system does not function as it should. A workshop should be contacted ^[2] .

A text message can be cleared by briefly pressing the  button, located in the centre of the steering wheel's right-hand keypad.

If a message remains, contact a workshop - an authorised Volvo workshop is recommended.



^[1] Park Assist Camera

^[2] An authorised Volvo workshop is recommended.

4.4.13. Symbols and messages for steering assistance upon risk of collision

The content of this manual represents the status of the user manual at the time of printing and may not be completely valid in future instances. For more information, refer to the first page for the complete disclaimer note.

A number of symbols and messages regarding steering assistance may be shown in the driver display. Here are some examples.

Symbol	Message	Specification
	Collision avoidance Automatic intervention	When the function is activated, a message is shown to the driver indicating that the system has been activated.
	Windscreen sensor Sensor blocked, see Owner's manual	The ability of the camera to scan the roadway in front of the car is reduced.











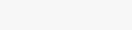
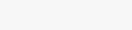
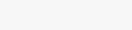
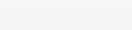

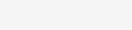

A text message can be cleared by briefly pressing the  button, located in the centre of the steering wheel's right-hand keypad.

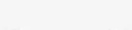
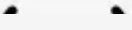
If a message remains: Contact a workshop – an authorised Volvo workshop is recommended.

4.4.14. Symbols in the centre display's status bar

Overview of the symbols that can be shown in the centre display's status bar.









The status bar shows activities in progress and, in some cases, their status. Not all symbols are shown all the time due to the limited space in the status bar.

Symbol	Specification
	Connected to the Internet.
	Roaming activated.
	Signal strength in mobile phone network.
	Bluetooth device connected.
	Bluetooth activated but no device connected.
	Information sent to and from GPS.
	Connected to Wi-Fi network.
	Tethering activated (Wi-Fi hotspot). The car then shares the available connection.
	Car modem activated.
	USB sharing active.
	Phone charging wirelessly.
	Process in progress.
	Timer for preconditioning active.
	Audio source being played back.
	Audio source stopped.
	Phone call in progress.
	Audio source muted.
	News is received from the radio channel.
	Traffic information is received.
	Clock.



4.4.15. Indicator and warning symbols









The indicator and warning systems alert the driver to the fact that a function is activated, a system is working, or a defect or serious error has occurred.

Red symbols



	Warning The red warning symbol illuminates when a fault has been detected which could affect the safety or drivability of the car. An explanatory text is shown on the driver display at the same time. The warning symbol can also illuminate in conjunction with other symbols.
	Seatbelt reminder Illuminates or flashes when someone in the car is not wearing a seatbelt.
	Airbags An error has been detected in any of the car's safety systems. Read the message on the driver display and contact a workshop. Volvo recommends that an authorised Volvo workshop is contacted.
	Fault in brake system An error has occurred on the braking system. Read the message on the driver display and contact a workshop. Volvo recommends that an authorised Volvo workshop is contacted.
	Parking brake Light illuminated permanently: The parking brake is activated. Flashing: an error has occurred with the parking brake. Read the message in the driver display.
	Faults in the electrical system An error has occurred on the electrical system. Read the message on the driver display and contact a workshop. Volvo recommends that an authorised Volvo workshop is contacted.
	High engine temperature The engine temperature is too high. Read the message in the driver display.
	Collision risk City Safety warns of a risk of collision with other vehicles, pedestrians, cyclists or large animals.
	Low oil pressure The engine oil pressure is too low. Stop the engine immediately and check the engine oil level, top up if necessary. If the symbol lights up and the oil level is normal, read the message on the display and contact a workshop. Volvo recommends that an authorised Volvo workshop is contacted.

Amber symbols





	Information A fault has occurred in one of the car's systems. Read the message in the driver display. The information symbol can also illuminate in conjunction with other symbols.
	Fault in brake system An error has occurred on the braking system. Read the message in the driver display.
	ABS fault The system is disengaged. The car's regular brake system continues to work, but without the ABS function.

	Emissions system Emissions systems fault. Drive to a workshop for checking. Volvo recommends that an authorised Volvo workshop is contacted.
	Rear fog lamp The rear fog lamp is illuminated.
	Tyre pressure system Low tyre pressure. If there is a fault in the tyre pressure system, the symbol will flash for approx. 1 minute and then illuminate with a constant glow. This may be because the system cannot detect or warn of low tyre pressure as intended.
	Fault in the headlamp system A fault has occurred on the headlamp system. Read the message in the driver display.
	Lane assistance Lane assistance warns/intervenes.
	Reduced performance Temporary fault on drivetrain. Read the message in the driver display.
	Stability system Light on permanently: a fault has occurred in the system. Flashing: the system is working.
	Stability system, sport mode Sport mode is selected.





Blue symbols

	Active main beam Active main beam is activated and switched on.
	Main beam Main beam is switched on.

Green symbols

	Automatic brake The function is activated and the service brake or parking brake is operating.
	Front fog lamps The front fog lamp is switched on.
	Position lamps The position lamps are switched on.
	Left and right-hand direction indicator The direction indicator is being used.

White/grey symbols

	<p>Active main beam Active main beam is activated, but does not come on.</p>
	<p>Preconditioning Engine and compartment heater/air conditioning pre-condition the car.</p>
	<p>Lane assistance White symbol: Lane assistance is on and road lines are detected. Grey symbol: Lane assistance is on but road lines are not detected.</p>
	<p>Rain sensor The rain sensor is activated.</p>







4.4.16. Symbols and messages for parking climate control

A number of symbols and messages regarding parking climate control can be shown in the driver display.

Messages relating to parking climate control can also be displayed in a device which has the Volvo Cars app*.



This symbol illuminates in the driver display when the parking heater is active.^[1]

Symbol	Message	Specification
	Parking climate Service required	Parking climate control is disengaged. Contact a workshop ^[2] to check the function as soon as possible.
	Parking climate Temporarily unavailable	Parking climate control is temporarily disengaged. If the problem persists for some time, contact a workshop ^[2] to check the function.
	Parking climate Unavailable Fuel level too low ^[1]	Parking climate control cannot be activated when the fuel level is too low to start the parking heater. Fill the vehicle's fuel tank.
	Parking climate Unavailable Charge level too low	Parking climate control cannot be activated if the charge level of the hybrid battery is too low to start the parking heater. Start the car.
	Parking climate Unavailable, not connected to the mains ^[3]	The parking climate control cannot be activated if the charging cable is not connected. Connect the charging cable.
	Parking climate Limited Charge level too low	The running time for parking climate control is limited when the state of charge in the hybrid battery is low. Start the car.

* Option/accessory.









^[1] Applies to fuel-driven heater.

^[2] An authorised Volvo workshop is recommended.

^[3] Applies to the high-voltage heater.

4.4.17. Symbols and messages relating to hybrid drive in the driver display

A number of symbols and messages regarding hybrid drive can be shown in the driver display. They may also be shown in combination with general indicator and warning symbols and are then extinguished when the problems have been rectified.

Symbol	Message	Specification
	12 V Battery Charging fault, service urgent. Drive to workshop	Fault in the 12V battery. Contact a workshop ^[1] to check the battery as soon as possible.
	12 V Battery Charging fault Stop safely	Fault in the 12V battery. Stop the car safely and contact a workshop ^[1] to have the battery checked as soon as possible.
	12 V Battery Fuse failure Service required	Fault in the 12V battery. Contact a workshop ^[1] to check the function as soon as possible.
	HV battery Overheated, stop safely	The temperature of the hybrid battery seems to be rising abnormally. Stop the car and switch off the engine. Wait at least 5 minutes before continuing to drive. Call a workshop ^[1] or check from the outside that everything seems normal before continuing to drive.
	Reduced performance Max car speed limited	The hybrid battery is not sufficiently charged for driving at high speeds. Charge the battery as soon as possible.
	Propulsion system Harsh behaviour at low speed, car ok to use	The hybrid system does not function as intended. Contact a workshop ^[1] to check the function as soon as possible.
	Hybrid system failure Service required	The hybrid system is disengaged. Contact a workshop ^[1] to check the function as soon as possible.
	Charge cable Remove before start	Shown when the driver tries to start the car and the charging cable is connected to the car. Disconnect the charging cable and close the charging hatch.

^[1] An authorised Volvo workshop is recommended.

4.4.18. Overheating in the engine and drive system

Under certain conditions, e.g. hard driving in hilly terrain and hot climate, there is a risk that the engine and drive system may overheat – in particular with a heavy load.



- In the event of overheating, the engine's power may be limited temporarily.
- Remove any auxiliary lamps from in front of the grille when driving in hot climates.
- If the temperature in the engine's cooling system becomes too high then a warning symbol is illuminated and the driver display shows the message **Engine temperature High temperature Stop safely**. Stop the car in a safe way and allow the engine to run at idling speed for several minutes and cool down.

- If the message **Engine temperature High temperature Turn off engine** or **Engine coolant Level low, turn off engine** is shown, stop the car and switch off the engine.
- In the event of overheating in the gearbox, an alternative gear shift program will be selected. In addition, a built-in protection function is activated that, amongst other things, illuminates a warning symbol and the driver display shows the message **Transmission warm Reduce speed to lower temperature** or **Transmission hot Stop safely, wait for cooling**. Follow the recommendation given, reduce speed or stop the car in a safe way and allow the engine to run at idling speed for several minutes to enable the gearbox to cool down.
- If the car overheats, the air conditioning may be switched off temporarily.
- Do not turn the engine off immediately you stop after a hard drive.

 **Note**

It is normal for the engine's cooling fan to operate for a time after the engine has been switched off.

Symbols in the driver display



Symbol	Specification
	High engine temperature. Follow the recommendation given.
	Low level, coolant. Follow the recommendation given.
	Gearbox hot/overheated/cooled. Follow the recommendation given.

4.4.19. Symbols and messages for automatic gearbox

If a fault should occur in the gearbox, a symbol and a message are shown in the driver display.

 **Important**

To prevent damage to any drive system components, the working temperature of the gearbox is checked. If there is a risk of overheating, a warning symbol illuminates in the driver display and a text message is shown - follow the recommendation given.

Symbol	Specification
	An error has occurred in the transmission. Read the message in the driver display.
	Hot or overheated gearbox. Read the message in the driver display.
	Temporary fault on drivetrain. Read the message in the driver display.

4.5. Voice recognition

4.5.1. Controlling climate control with voice recognition ^[1]

Commands for voice control of the climate control system in order to e.g. change temperature, activate a heated seat* or change fan level.

Tap on  and say one of the following commands:

- "Climate" - starts a dialogue for climate control and shows examples of commands.
- "Set temperature to X degrees" - sets the desired temperature.
- "Raise temperature"/"Lower temperature" - raise/lower the temperature setting one step.
- "Sync temperature" - synchronises the temperature for all climate zones in the car with the temperature set for the driver's side.
- "Air on feet"/"Air on body" - opens the desired air flow.
- "Air on feet off"/"Air on body off" - closes the desired air flow.
- "Set fan to max"/"Turn off fan" - changes the air flow to **Max/Off**.
- "Raise fan speed"/"Lower fan speed" - raises/lowers the fan level one step.
- "Turn on auto" - activates automatic climate regulation.
- "Air condition on"/"Air condition off" - activates/deactivates the air conditioning.
- "Recirculation on"/"Recirculation off" - activates/deactivates the air circulation.
- "Turn on defroster"/"Turn off defroster" - activates/deactivates defrosting of windows and door mirrors.
- "Turn on max defroster"/"Turn max defroster off" - activates/deactivates the max defroster.
- "Turn on electric defroster"/"Turn off electric defroster" - activates/deactivates the heated windscreen*.
- "Turn on rear defroster"/"Turn off rear defroster" - activates/deactivates the heated rear window and door mirrors.
- "Turn steering wheel heat on"/"Turn steering wheel heat off" - activates/deactivates the heated steering wheel*.
- "Raise steering wheel heat"/"Lower steering wheel heat" - raises/lowers the setting for the heated steering wheel* one step.
- "Turn on seat heat"/"Turn off seat heat" – activates/deactivates the heated driver seat*.
- "Raise seat heat"/"Lower seat heat" - raises/lowers the setting level for the heated driver seat* one step.
- "Turn on seat ventilation"/"Turn off seat ventilation" – activates/deactivates the ventilated driver seat*.
- "Raise seat ventilation"/"Lower seat ventilation" - raises/lowers the setting level for the ventilated driver seat* one step.

 **Note**

Not all system languages support voice recognition. The ones that do are highlighted with the  symbol in the list of available system languages. Read more about where the information can be found in the section on settings for voice recognition.

[1] Applies to certain markets.

* Option/accessory.

4.5.2. Voice control of radio and media

Commands for radio and media player voice control are shown below^[1].

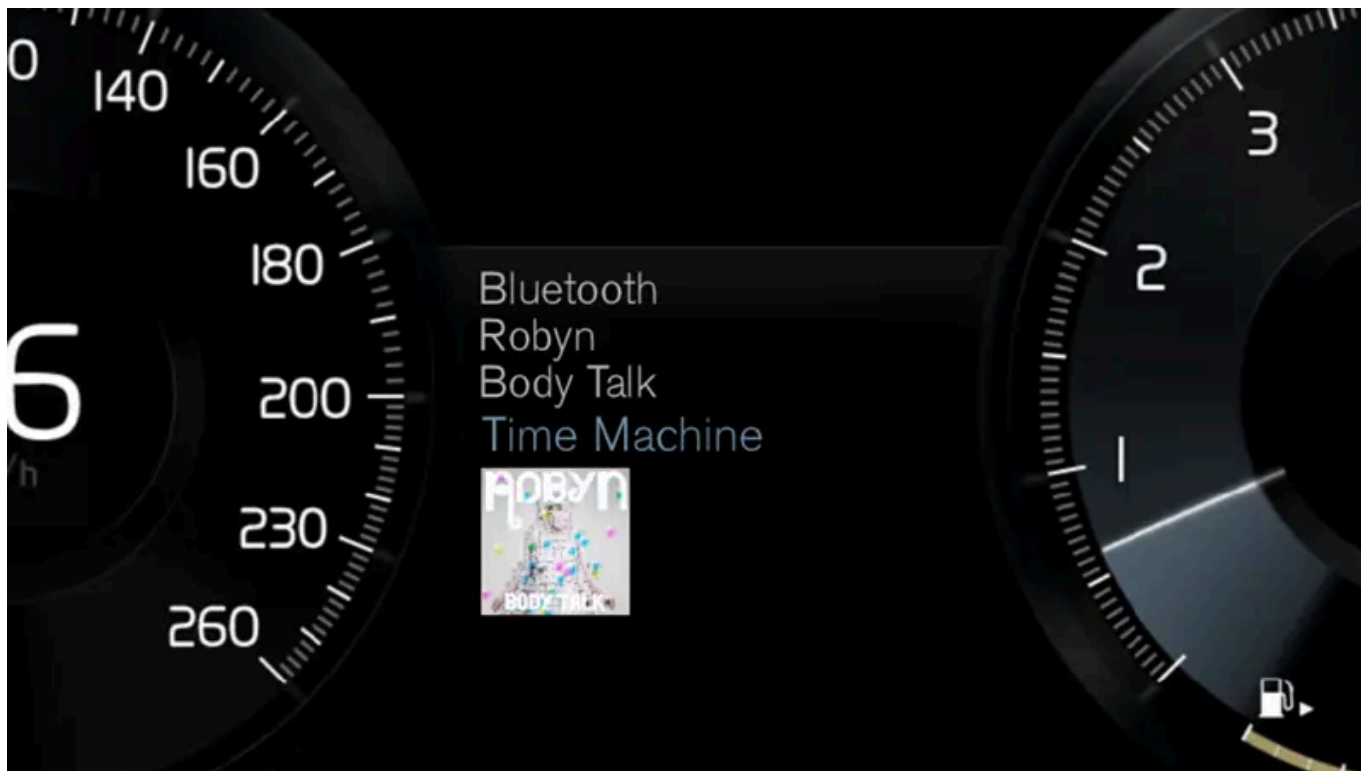

Tap on  and say one of the following commands:

- "Media" - starts a dialogue for media and radio and shows examples of commands.
- "Play[artist]" - plays back music by the selected artist.
- "Play[song title]" - plays back the selected song.
- "Play[song title]from[album]" - plays back the selected song from the selected album.

The content of this manual represents the status of the user manual at the time of printing and may not be completely valid in future instances. For more information, refer to the first page for the complete disclaimer note.

- "Play[radio station]" - starts playing back the selected radio channel.
- "Tune to [frequency]" - starts the selected radio frequency in the current frequency band. If no radio source is active, the FM band is started by default.
- "Tune to [frequency][wavelength]" - starts the selected radio frequency in the selected frequency band.
- "Radio" - starts FM radio.
- "Radio FM" - starts FM radio.
- "DAB" - starts DAB radio*.
- "USB" - starts playback from USB.
- "iPod" - starts playback from iPod.
- "Bluetooth" - starts playback from a Bluetooth-connected media source.
- "Similar music" — plays back music similar to the music currently playing back from USB devices.

 **Note**

Not all system languages support voice recognition. The ones that do are highlighted with the  symbol in the list of available system languages. Read more about where the information can be found in the section on settings for voice recognition.

^[1] Applies to certain markets.

* Option/accessory.

4.5.3. Voice recognition

Voice control^[1] allows you to control functions in the car, e.g. climate system, radio or a Bluetooth-connected phone with spoken commands. In cars equipped with Sensus Navigation*, the navigation system can also be controlled with voice recognition.

What is voice control?

Voice control is an aid that can facilitate the use of different commands in your car. In order to use voice control, certain specific commands must be used. It may therefore be a good idea to learn how, and in what order, a voice command should be spoken in order to achieve the desired result.

The voice control system allows you to control certain infotainment and climate functions using voice commands. The system can respond with speech and by showing information in the driver display.

 **Warning**

The driver always holds overall responsibility for driving the vehicle in a safe manner and complying with all applicable rules of the road.



Voice control system microphone

System updating

The voice recognition system is continuously improved. It is recommended to always have the latest version installed.

 **Note**

Not all system languages support voice recognition. The ones that do are highlighted with the  symbol in the list of available system languages. Read more about where the information can be found in the section on settings for voice recognition.

^[1] Applies to certain markets.

* Option/accessory.

4.5.4. Using voice recognition

It is possible to voice-control a range of different functions in the car. Below is an introduction to what is needed to get started as well as examples of different commands.



Start voice control ^[1]



To give commands via the voice control system, you have a "dialogue" with the system. Depress the steering wheel button for voice recognition  to activate the system and initiate a dialogue using voice commands. After you have pressed the button, a beep tone can be heard and the voice control symbol is shown in the driver display.

This shows that the system has started to listen and you can start to say the commands. As soon as you start to talk, the system is trained to recognise and understand your voice. This takes several seconds and is done automatically, which means that you do not need to start any voice training manually.

Remember the following:

- Speak after the tone with a normal voice at a normal tempo.
- Do not speak while the system is replying (the system cannot understand commands during this time).
- Avoid background noise in the passenger compartment by having the doors, windows and panoramic roof* closed.

Note



Not all system languages support voice recognition. The ones that do are highlighted with the  symbol in the list of available system languages. Read more about where the information can be found in the section on settings for voice recognition.

In general, the system works by listening for a basic command which is followed by more detailed commands that specify what you want the system to do.

To change the system audio volume, turn the rotary volume knob when the voice speaks. It is possible to use other buttons during voice control. However, other sounds will be silenced during dialogue with the system, which means that it is not possible to execute any functions linked with audio using the buttons.

Cancel voice control

Voice control can be cancelled in different ways:

- Tap briefly on  and say "Cancel".
- Give a long press on the steering wheel button for voice control  until you hear two beeps. This stops voice recognition even when the system is speaking.

Voice control is also cancelled if you do not reply during a dialogue. The system will first ask for a reply three times and if there is still no response then voice control will be cancelled automatically.

To speed up communication and skip the prompts from the system, press the steering wheel button for voice control . This cancels the system voice and you can say the next command.

Example of voice recognition control

- 1 Press .
- 2 Say "Call [Forename][Surname][number category]", e.g. "Call RobinSmithMobile".
 - The system dials the selected contact from the phonebook. If the contact has several phone numbers (e.g. home, mobile, work), the right category must be referred to.

Commands/phrases

The following commands can generally be used, regardless of the situation:

- "Repeat" - repeats the last voice instruction in the ongoing dialogue.
- "Cancel" - discontinue the dialogue.^[2]
- "Help" - starts a help dialogue. The system replies with the commands available in the current situation, a prompt or an example.

Commands for specific functions such as phone and radio are described in specific sections.

Digits

The number commands are stated differently depending on the function to be controlled:

- **Phone numbers and postcodes** must be spoken individually, number by number, e.g. "zero, three, one, two, two, four, four, three" (03122443).
- **House numbers** can be spoken individually or in groups, e.g. "two, two" or "twenty-two" (22). For English and Dutch, several groups can be said in sequence, e.g. "twenty-two, twenty-two" (22 22). For English, double or triple can be used, e.g. "double zero" (00). Numbers can be given within the range 0-2300.

- **Frequencies** can be spoken as "ninety eight point eight" (98.8), "a hundred and four point two" or "hundred four point two" (104.2).

Speed and repetition mode

It is possible to adjust the speed if the system is speaking too quickly.

Repetition mode can be enabled so that the system repeats what you have said.

To change the speed or activate/deactivate repetition mode:

- 1 Press **Settings** in the top view.
- 2 Press **System** → **Voice Control** and select settings.
 - **Repeat Voice Command**
 - **Speech Rate**

^[1] Applies to certain markets.

* Option/accessory.

^[2] Note that this only stops the dialogue when the system is not speaking. To stop the dialogue when the system is speaking, give a long press on  until two beep tones are heard.

4.5.5. Updating voice control

Volvo is working constantly on improving voice control in your car. You can download files yourself for updating your car's voice control. Updating occurs in two stages using an empty USB memory.

Preparations

The new voice command files can be downloaded to an empty USB memory stick of at least 8 GB. The memory must have one of the following formats: FAT32, NTFS or exFAT.

Download

You can find current updates under the tab for download of software on the support site. You access the information for the relevant car by selecting your car and model year. Click on the update that you want to install, then follow the instructions below. Downloads for voice control files are carried out using a program that is installed on your computer.

Instructions

- 1 Depending on which system you have, select the download link for either Windows or Mac.

The content of this manual represents the status of the user manual at the time of printing and may not be completely valid in future instances. For more information, refer to the first page for the complete disclaimer note.

- 2 Select **Run** to install the download program.
 - 3 Click on **New download** to download the file to a USB memory stick.
 - 4 You can verify that the download/copying to the USB memory stick has worked correctly before you install the file in the car by repeating steps 1-2 and then pressing on **Check download** in the download program.
 - 5 Take the USB memory with the downloaded file to your car and start the infotainment system.
 - 6 Insert the USB memory in the USB port. If there are two USB ports, the second one must not be used at the same time.
 - 7 The system automatically detects that an update is available and during the update the screen shows how much of the process remains, counted as a percentage.
 - 8 When the installation is complete a notification is shown advising that the updated file is available after the next restart. The USB memory can now be removed.
- If there are any problems with the update, contact your customer support or Volvo dealer.

Updating tips

- An update takes about half an hour and the infotainment system must be on. Use a battery charger or keep the car's engine running while the update is in progress, for example during a journey.
 - New voice control files for download are launched twice a year.
-

4.5.6. Tips for improving voice control

A few tips that might be useful to bear in mind when using voice control are listed here.

If the voice control system does not respond as you expect, this may be due to a number of factors. Examples of these include:

- Make sure you are speaking the language that is selected as system language, and that the language you have selected is supported by voice control.
 - Try saying "Help". You will then receive guidance about what is possible to say. It is possible that the system does not support the phrase that you think the system does not understand.
 - Speak at a natural pace and using a normal conversational tone. Do not speak more slowly because the system does not understand you, this impairs recognition.
 - Remember that in certain situations, the system has to search through a large database in order to give you the right feedback. In these situations it is more difficult to give you exactly the right response. A list of possible responses is then often shown in the car's display.
 - The voice control system in your car is under continuous improvement. You can download update files yourself.
-

4.5.7. Settings for voice recognition

Settings for the voice control system^[1] are selected here.

Settings → System → Voice Control

Settings can be made within the following areas:

- Repeat Voice Command
- Gender
- Speech Rate

Sound settings

Select sound settings under:

Settings → Sound → System Volumes → Voice Control

Language settings

Voice recognition is not possible for all languages. Languages available for voice recognition are marked with an icon in the language list - .

Changing the language also affects menu, message and help texts.

Settings → System → System Languages and Units → System Language

^[1] Applies to certain markets.

4.5.8. Command list for voice control of the navigation system *

Several navigation system functions can be activated with voice commands. A list of them follows below.

Press  on the right-hand keypad on the steering wheel and say one of the following commands:

- "Navigation" - Initiates a navigation dialogue and shows examples of commands.
- "Take me home" - Guidance is given to the Home position.
- "Go to [City]" - Specifies a city as a destination. Example "Drive to London".
- "Go to [Address]" - Specifies an address as a destination. An address must contain city and street. Example "Drive to 5 King's Road, London".
- "Add intersection" - Starts a dialogue where two streets must be specified. The intersection point of the specified streets then becomes the destination.
- "Go to [Post code]" - Specifies a post code as a destination. Example "Drive to 1 2 3 4 5".
- "Go to [contact]" - Specifies an address from the phone book as a destination. Example "Drive to Robyn Smith"^[1].

The content of this manual represents the status of the user manual at the time of printing and may not be completely valid in future instances. For more information, refer to the first page for the complete disclaimer note.

- "Search [POI category]" - Searches for adjacent points of interest (POI) within a certain category (e.g. restaurants)^[2]. To have the list sorted along the route - say "Along the route" when the results list is shown.
- "Search [POI category] in [City]" - Searches for points of interest (POI) within a certain category and city. The list of results is sorted according to the city's central point. Example "Search for restaurant in London".
- "Search [POI name]". Example "Search Kielder Forest".
- "Change country/Change state"^{[3],[4]} - Changes the search area for navigation.
- "Show favourites" – Shows saved positions in the driver display.
- "Clear itinerary" - Erases all the stored intermediate destinations and final destination in an itinerary.
- "Repeat voice guidance" - Repeats the last spoken guidance.
- "Turn off voice guidance" - Switches off voice guidance.
- "Turn on voice guidance" - Starts the switched-off voice guidance.

The following commands can generally be used, regardless of the situation:

- "Repeat" - repeats the last voice instruction in the ongoing dialogue.
- "Help" - starts a help dialogue. The system replies with the commands available in the current situation, a prompt or an example.
- It is possible to stop voice control both when the system is silent and when it is speaking.
 - "Cancel" – stops the dialogue when the system is silent.
 - Give a long press on  until two beep tones are heard – the dialogue stops, even if the system is speaking.

Addresses

When an address is entered, the search area is defined as the search area preset in the navigation system. It is possible to switch to a different search area. If the new search area uses a different language to the selected system language, the system will automatically switch to a different recognition engine. Therefore, state the address in the language used in the new search area.

Note

Note that addresses can only be searched for the country or state that the navigation system is preset for. To search for addresses in another country or state you first need to change search area.

Note

Not all system languages support voice recognition. The ones that do are highlighted with the  symbol in the list of available system languages. Read more about where the information can be found in the section on settings for voice recognition.

* Option/accessory.

^[1] In order to find addresses in the map database, they must have been entered correctly in the phone book, e.g. without spelling mistakes and abbreviations. Go to wego.here.com [<https://wego.here.com>], for spell checking.

^[2] The user has the option of calling the POI or specifying it as a destination.

^[3] In European countries, "Country" is used instead of "State".

[4] For Brazil and India, the search area is changed via the centre display.

4.5.9. Controlling a telephone with voice recognition

Call a contact, have messages read aloud or dictate brief messages with voice control commands to a Bluetooth connected telephone. ^[1]

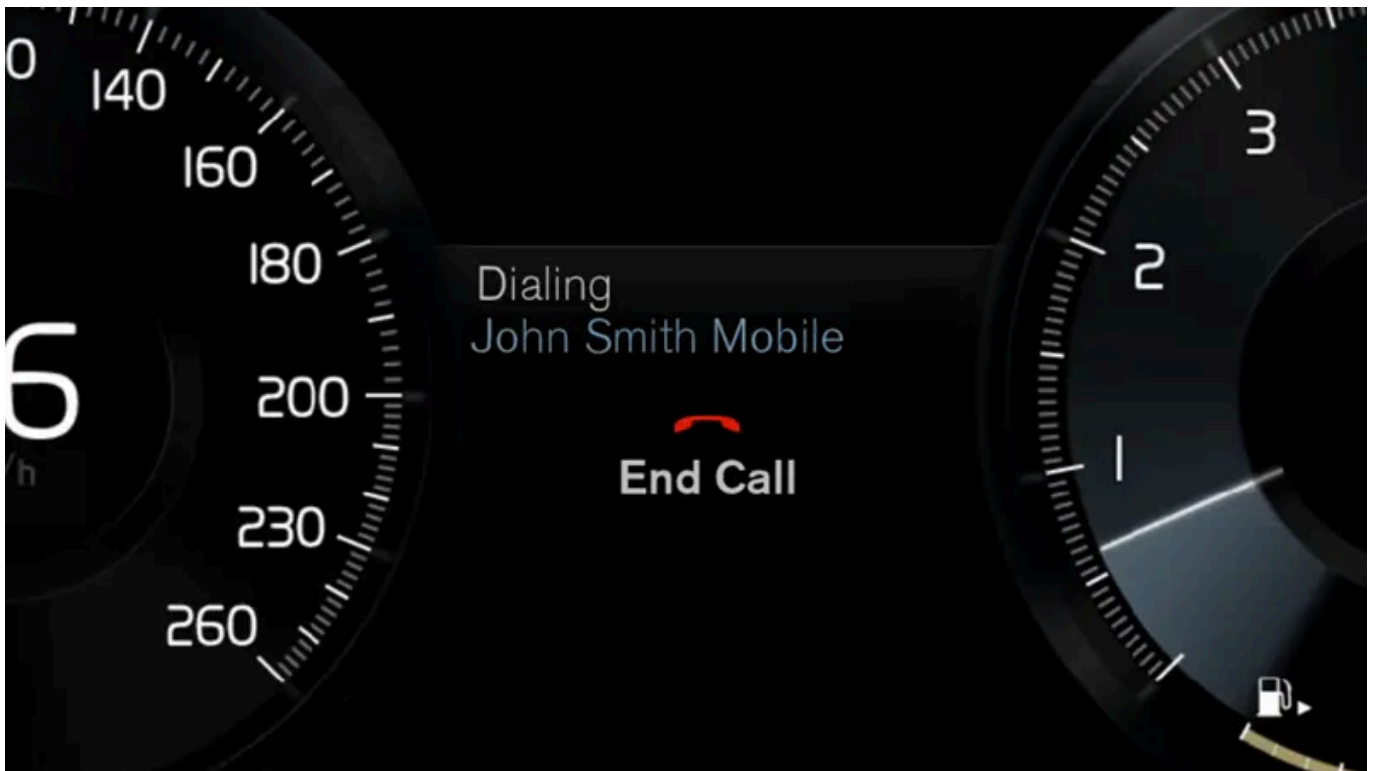

To specify a contact in the phone book, the voice recognition command must include contact information that is entered in the phone book. If a contact, e.g. **Robyn Smith**, has several phone numbers then the number category can also be stated, e.g. Home or Mobile: "Call RobinSmithMobile".

Press  and say one of the following commands:

The content of this manual represents the status of the user manual at the time of printing and may not be completely valid in future instances. For more information, refer to the first page for the complete disclaimer note.

- "Call [contact]" - dials the selected contact from the phone book.
- "Call[phone number]" - dials the phone number.
- "Recent calls" - displays the call list.
- "Read message" - message is read out. If there are several messages - select which message should be read out.
- "Message to [contact]" - the user is prompted to speak a short message. The message is then repeated aloud and the user can choose to send^[2] or revise the message. For this function to work, the car must be connected to the Internet.

Note

Not all system languages support voice recognition. The ones that do are highlighted with the  symbol in the list of available system languages. Read more about where the information can be found in the section on settings for voice recognition.

^[1] Applies to certain markets.

^[2] Only certain phones can send messages via the car.

4.5.10. Voice control of text messages

Voice recognition allows you to control functions in the car, e.g. reading out text messages from a connected mobile phone.

Reading out text messages



Settings and menus in the centre display vary depending on software version.

The content of this manual represents the status of the user manual at the time of printing and may not be completely valid in future instances. For more information, refer to the first page for the complete disclaimer note.

You need to connect a mobile phone to the car before you can use voice commands for a mobile phone's functions (text messages, phone calls and media player).

To read out a text message, press the voice control button on the right-hand side of the steering wheel and say "Read message".

Reading out text messages from an iPhone

To read out text messages from an iPhone, you need to change a setting on your phone so that messages can be sent from the phone to the car.

- 1 Go to **Settings**.
- 2 Select **Bluetooth**.
- 3 Click on the info symbol (i) for the connection to your car.
- 4 Switch on **Show notes**.

Note

Not all system languages support voice recognition. The ones that do are highlighted with the  symbol in the list of available system languages. Read more about where the information can be found in the section on settings for voice recognition.

4.5.11. Control the navigation system* with voice recognition

If your car is equipped with Sensus Navigation you can use voice control to give spoken commands in order to control parts of your navigation system.

Start navigation

Here you can find an introduction on how to start to use voice control in order to control the navigation system in the car.



To activate a navigation command

- 1 Press the voice recognition button on the steering wheel  .
 - > You can now give commands, e.g. "Navigation" that start a navigation dialogue and show examples of commands.

Note

Not all system languages support voice recognition. The ones that do are highlighted with the  symbol in the list of available system languages. Read more about where the information can be found in the section on settings for voice recognition.

Use voice control to get directions to an address

To get directions to a specific address, use the spoken command **Go to** followed by the address. The order in which the address is given is important. To get directions to an address via voice control, the address must be given in the following order: (1) street address; (2) street number; (3) city; according to the following example:

- 1 Give the **Go to** command.
 - > Now you can give the address you want directions to.

2 Give the street address, e.g. "King Street"

3 Give the street number, e.g. "Five"

4 Give the city, e.g. "Gothenburg"

➤ In this case, the combined command will then be: "Go to King Street Five, Gothenburg". Provided the address is found in the system, you will now get directions to the address via your navigation system.

Use voice control to get directions to an address in another country or another county

Your navigation system installs sets of maps for the country or county where the car recognises its location. This means that in order to get correct directions across country or county borders, you need to first tell the system the country or county in which your desired destination address is located. You do this by using the **Change country** or **Change state** command. (The **Change state** command is primarily used in USA. The **Change country** command is used in the example below.)

1 Give the **Change country** command.

➤ Now you can give the country for the address to which you want directions, e.g. "Norway".

2 Now give the address to which you want directions by following the same procedure as in "Use voice control to get directions to an address".

➤ In this scenario, the combined command will be divided into 2 subcommands:

1. "Change country, Norway"

2. "Go to Karl Johans gate twenty two, Oslo"

Provided the address is found in the system, you will now get directions to Karl Johans gate 22, Oslo, Norway via your navigation system

Note

After changing country, try to pronounce the address you want directions to in the language of the destination country. This is necessary since the system's recognition changes automatically to the language of the selected country.

Use voice control to get directions to an address given as Home position

If you have given an address in your navigation system as a **Home** position, you can use a spoken command to get directions to the position.

1 Give the **Take me home** command.

➤ If the navigation system has a home position saved, you will now get directions to the position.

Use voice control to get directions to a place, shop or other specific business without giving an exact address

You can use your navigation system to get directions to special places or a specific type of business, so-called points of interest (POI^[1]). Examples of points of interest are, for example, restaurants, hotels, petrol stations, museums or sights and landmarks.

You use the **Search** command to search for a point of interest. You can search for both a specific point of interest as well as point of interest categories.

Note

It is important which command you choose to use for obtaining directions to different alternatives. Please note that when you want directions to a point of interest, use the **Search** command. This is different from when you want directions to specific addresses. Then the **Go to** command must be used instead.

Search for a specific place or business

[**POI name**] here refers to a specific place or business, a so-called point of interest, e.g. a hotel, a restaurant, a municipal park, etc.

- 1 Give the **Search** command.
 - Now you can specify a specific point of interest you want directions to.
- 2 State [**POI name**], e.g. "Castle Forest"
 - In this case, the combined command will then be: "**Search** Castle Forest". Provided the place is found in the system, you will now get directions to the place via your navigation system.

Search for a point of interest category e.g. shops, hotels, restaurants, museums or other sights and landmarks or businesses

[**POI category**] here refers to specific types of place or business, so-called points of interest, e.g. hotels, restaurants, museums, etc.

- 1 Give the **Search** command.
 - Now you can specify the type of point of interest you want to find and get directions to.
- 2 State [**POI category**], e.g. "restaurant"
 - In this case, the combined command will then be: "**Search** restaurant". The navigation system will now search for restaurants located near and around the car, which results in a list in your driver display. The list that appears consists of suggestions the system has produced based on your command. Categories and close results are at the top, and the lower the relevance a suggestion is deemed to have, the lower down the list it appears.
Since you are looking for a category in this example, it may be a good idea to choose the category option closest to your search.
- 3 Select the category most appropriate for your search target in the list, in this case "restaurant(s)", by speaking the number of the row in which the option appears in the driver display.

The content of this manual represents the status of the user manual at the time of printing and may not be completely valid in future instances. For more information, refer to the first page for the complete disclaimer note.

- Now you can see your search results and select an option that suits you.

Use voice control to stop directions

If you want to stop directions and all of the intermediate destinations and the final destination, this can be done with a spoken command.

- 1 Give the **Clear itinerary** command.
 - The navigation system stops the directions and deletes all of the intermediate destinations and the final destination along the travel itinerary.

How to give postcode and house number

The number commands are stated differently depending on the function to be controlled:

- **Postcodes** must be spoken individually, number by number, e.g. zero three one two two four four three (03122443).
- **House numbers** can be spoken individually or in groups, e.g. two two or twenty-two (22). For some languages, it is also possible to state them with hundreds, e.g. 19 hundred 22 (1922). For English and Dutch, several groups can be said in sequence, e.g. twenty-two twenty-two (22 22). For English, double or triple can be used, e.g. double zero (00). Numbers can be given within the range 0-2300.

Set destination using the phone book's contact list

If you want to set the address for a contact in the phone's phone book as destination then you can do this with the "Go to[contact]" command. However, for the address to be found in the database requires that the address is entered with the correct spelling and without abbreviations.

To spell check addresses in HERE's database, go to wego.here.com [<https://wego.here.com>]

* Option/accessory.

[1] Point Of Interest

4.6. Displays and controls by the driver in a left-hand drive car

The overviews show where the displays and controls near the driver are located.

Steering wheel and instrument panel



- 1 Position lamps, daytime running lights, dipped beam, main beam, direction indicators, rear fog lamp, resetting the trip meter
- 2 Steering wheel paddles for manual gear changing in an automatic gearbox*
- 3 Head-up display*
- 4 Driver display
- 5 Wipers and washing, rain sensor*
- 6 Right-hand steering wheel keypad
- 7 Steering wheel adjustment
- 8 Horn
- 9 Left-hand steering wheel keypad
- 10 Bonnet opening
- 11 Display lighting, tailgate unlocking/opening*/closing*, halogen headlamp levelling

Roof console



- 1 Front reading lamps and interior lighting
- 2 Panoramic roof*
- 3 Display in roof console, ON CALL button*
- 4 Manual dimming of interior rearview mirror *^[1]

Centre and tunnel console

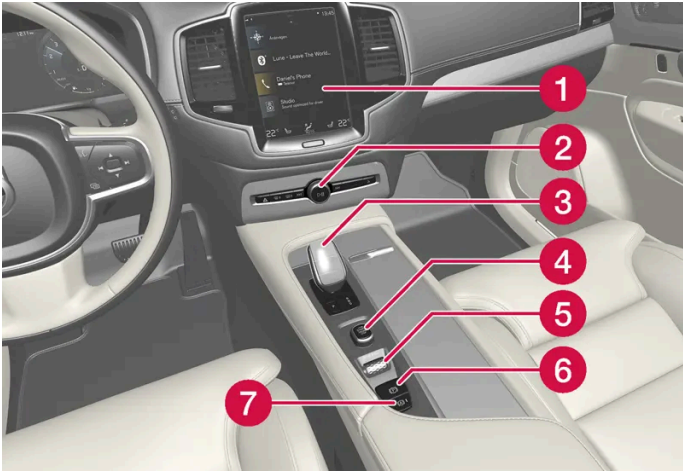

- 1 Centre display
- 2 Hazard warning flashers, defrosting, media, glovebox opening
- 3 Gear selector
- 4 Start knob
- 5 Drive mode control
- 6 Parking brake
- 7 Automatic braking when stationary

Driver's door

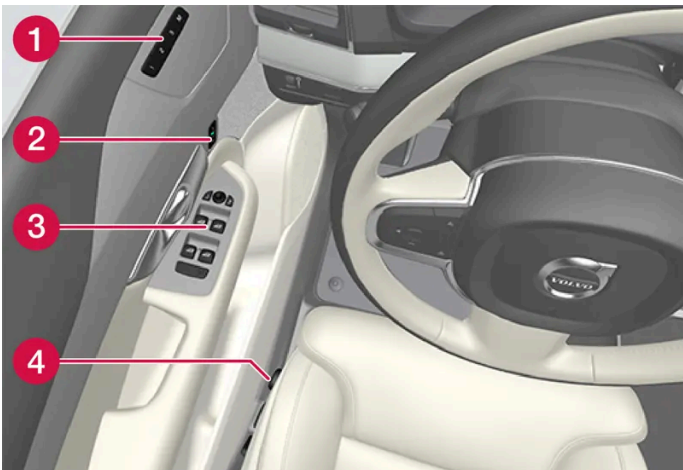

- 1 Memories for power front seat*, door mirror and head-up display* settings
- 2 Central locking
- 3 Power windows, door mirrors, electric child lock*
- 4 Adjusting front seat

* Option/accessory.

[1] There are no controls for manual dimming for cars with automatic dimming.

4.7. Displays and controls by the driver in a right-hand drive car

The overviews show where the displays and controls near the driver are located.

Steering wheel and instrument panel

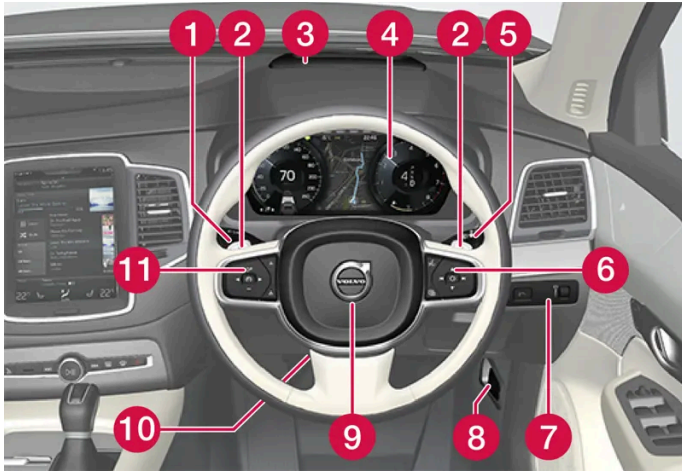

- 1 Position lamps, daytime running lights, dipped beam, main beam, direction indicators, rear fog lamp, resetting the trip meter
- 2 Steering wheel paddles for manual gear changing in an automatic gearbox*
- 3 Head-up display*
- 4 Driver display
- 5 Wipers and washing, rain sensor*
- 6 Right-hand steering wheel keypad
- 7 Display lighting, tailgate unlocking/opening*/closing*, halogen headlamp levelling
- 8 Bonnet opening
- 9 Horn
- 10 Steering wheel adjustment
- 11 Left-hand steering wheel keypad

Roof console



- 1 Front reading lamps and interior lighting
- 2 Panoramic roof*
- 3 Display in roof console, ON CALL button*
- 4 Manual dimming of interior rearview mirror

Centre and tunnel console

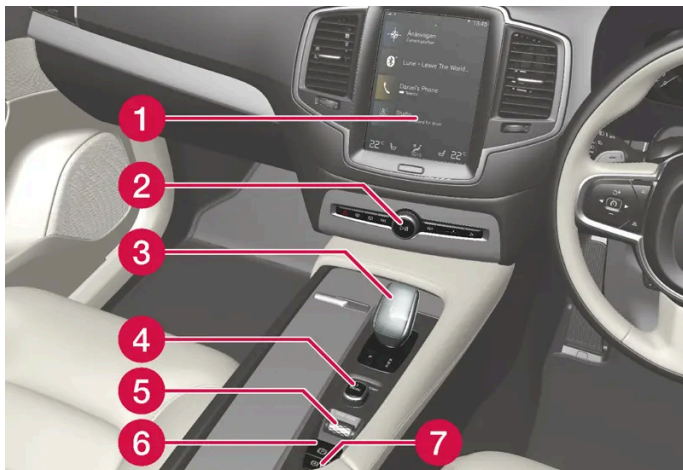

- 1 Centre display
- 2 Hazard warning flashers, defrosting, media, glovebox opening
- 3 Gear selector
- 4 Start knob
- 5 Drive mode control
- 6 Parking brake
- 7 Automatic braking when stationary

Driver's door

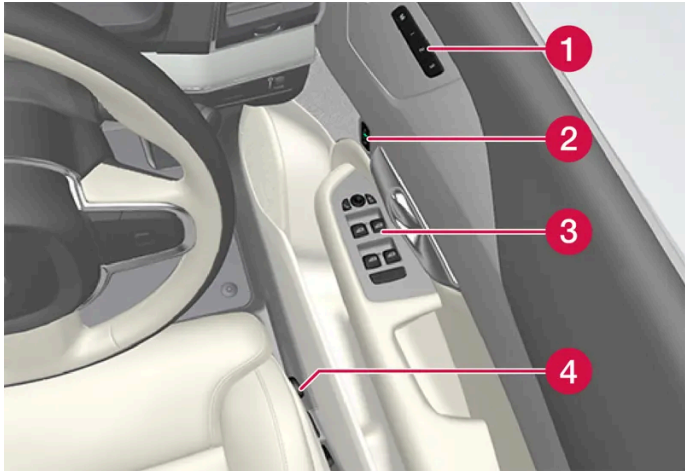

- ① Memories for power front seat*, door mirror and head-up display* settings
- ② Central locking
- ③ Power windows, door mirrors, electric child lock*
- ④ Adjusting front seat

* Option/accessory.

5. Lighting

5.1. Exterior lighting

5.1.1. Active bending lights*

Active bending lights are designed to provide additional illumination in bends and junctions. Cars with LED^[1] headlamps* can have active bending lights, depending on the car's equipment level.

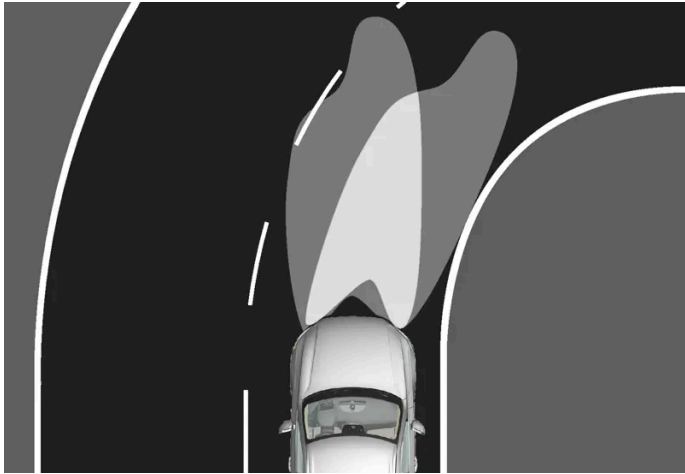

Headlamp pattern with function deactivated (left) and activated (right) respectively.

Active bending lights follow steering wheel movements to provide additional illumination in bends and junctions and can thereby provide the driver with improved visibility.

The function is activated automatically when the car is started. In the event of a fault in the function, the  symbol illuminates in the driver display at the same time as the driver display shows an explanatory text.

The function is only active in weak daylight or darkness and only when the car is moving and dipped beam is switched on.

Deactivating/activating the function

The function is activated when the car is supplied from the factory and can be deactivated/activated via the centre display's function view.



Press the **Active Bending Lights** button.

* Option/accessory.

^[1] LED (Light Emitting Diode)

5.1.2. Active main beam



Active main beam is a function which uses a camera sensor at the top edge of the windscreen to detect the headlamp beams from oncoming traffic or the rear lights of vehicles in front, and then switches from main beam to dipped beam.



The symbol  represents active main beam.

The function can start while driving in the dark when the car's speed is approx. 20 km/h (approx. 12 mph) or higher. The function can also take streetlights into account. When the camera sensor no longer detects any oncoming car or car in front, main beam is switched on again after about a second.

Activate active main beam

Active main beam is activated and deactivated by turning the left-hand stalk switch to position . The rotating ring then returns to position **AUTO**. When active main beam is activated, the symbol  illuminates with a white glow in the driver display. When main beam is activated, the symbol shines blue.

If active main beam is deactivated while main beam is on, the lighting is immediately reset to dipped beam.

Active main beam does not need to be reactivated every time the car is started.

Adaptive functionality

For cars with LED^[1] headlamps*, active main beam has adaptive functionality^[2]. In this case, unlike what happens during conventional dimming, the light beam continues to illuminate with main beam on both sides of oncoming traffic or vehicles ahead – only the part of the light beam that points directly to the vehicle is dimmed.

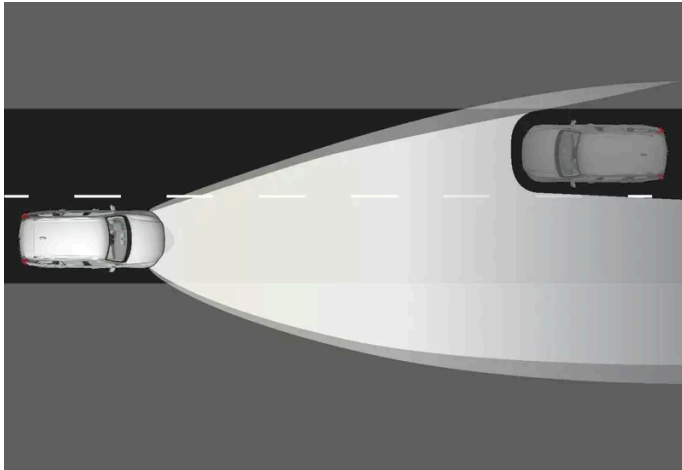

Adaptive functionality: Dipped beam directly towards oncoming vehicle, but continued main beam on both sides of the vehicle.

The main beam is partly dimmed, i.e. if the light beam shines with slightly more than dipped beam, the symbol  in the driver display shines blue.

On motorways or at high speed, the system may change from adaptive to automatic functionality.

Limitations for active main beam

The camera sensor on which the function is based has limitations.

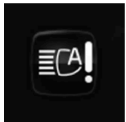

If this symbol is shown in the driver display, together with the message **Active High Beam Temporarily unavailable**, then switching between main and dipped beam must be performed manually. The  symbol extinguishes when these message are shown.



The same applies if this symbol is shown together with the message **Windscreen sensor Sensor blocked, see Owner's manual**.

Active main beam may be temporarily unavailable e.g. in situations with dense fog or heavy rain. When active main beam becomes available again, or the windscreen sensors are no longer blocked, the message goes out and the  symbol illuminates.

Warning

Active main beam is an aid for using the optimum beam pattern when conditions are favourable.

The driver always bears responsibility for manually switching between main and dipped beam when traffic situations or weather conditions so require.

^[1] LED (Light Emitting Diode)

* Option/accessory.

^[2] Depending on the car's equipment level.

5.1.3. Using direction indicators

The car's direction indicators are operated with the left-hand stalk switch. The direction indicator lamps flash three times or continuously, depending on how far up or down the stalk switch is moved.



Direction indicators.

Short flash sequence

- ➔ Move the stalk switch up or down to the first position and release. The direction indicator lamps flash three times. If the function is deactivated via the centre display, the lamps will flash once.

i Note

- This automatic flashing sequence can be stopped by moving the stalk switch immediately in the opposite direction.
- If the symbol for direction indicators in the driver display flashes more quickly than normal - see the message in the driver display.

Continuous flash sequence

- ➔ Move the stalk switch up or down to its end position.

The stalk switch remains in its position and is moved back manually, or automatically by the steering wheel movement.

5.1.4. Brake lights

The brake light automatically comes on during braking.

The brake light is illuminated when the brake pedal is depressed and when the car is braked automatically by one of the driver support systems.

5.1.5. Rear fog lamp

The rear fog lamp is considerably stronger than the normal rear lights and should only be used in reduced visibility due to fog, snow, smoke or dust so that other road users have an early warning of a vehicle ahead.

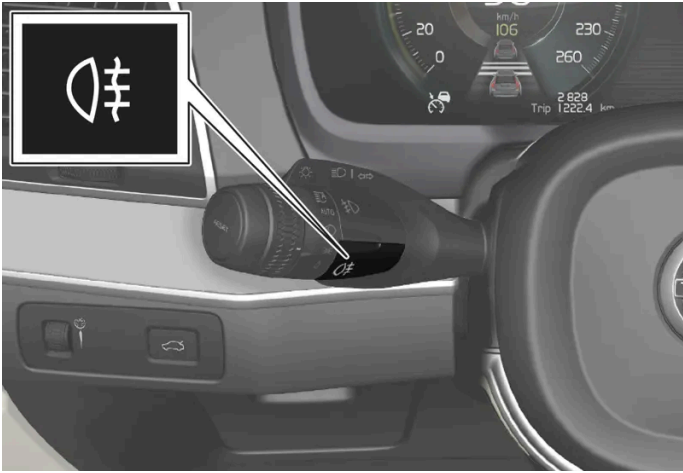



Button for rear fog lamp.

The rear fog lamp is a lamp at the rear of the car, on the driver's side.

The rear fog lamp can only be switched on when ignition position II is active and the rotating ring on the stalk switch is in position AUTO or .

Press the button to switch the lights on/off. The  symbol in the driver display illuminates when the rear fog lamp is switched on.

The rear fog lamp switches off automatically when the car is switched off or when the rotating ring on the stalk switch is set to the  or  position.

Note

Regulations on the use of rear fog lamps vary from country to country.

5.1.6. Dipped beam

When driving with the stalk switch's rotating ring in the **AUTO** position, dipped beam is activated automatically in weak daylight or darkness or when the car's electrical system is in ignition position II.



Stalk switch rotating ring in **AUTO** position.

With the stalk switch's rotating ring in **AUTO** position, dipped beam is also activated automatically if the rear fog lamp is activated.

With the stalk switch's rotating ring in the  position, dipped beam is always activated when the car's electrical system is in ignition position II.

Tunnel detection

The car detects when it is driven into a tunnel and switches from daytime running lights to dipped beam.

Note that the rotating ring in the left-hand stalk switch must be in **AUTO** mode for tunnel detection to work.

5.1.7. Using main beam

Main beam is operated with the left-hand stalk switch. Main beam is the car's strongest lighting and should be used when driving in the dark for better visibility, as long as it does not dazzle other road users.



Steering wheel stalk switch with rotating ring.

Main beam flash

➡ Move the stalk switch backwards slightly to main beam flash position. Main beam comes on until the stalk switch is released.

Main beam

➡ Main beam can be activated when the steering wheel stalk switch's rotating ring is in position AUTO^[1] or . Activate main beam by moving the stalk switch forwards.

➡ Deactivate by moving the stalk switch backwards.

When main beam has been activated the  symbol illuminates in the driver display.

^[1] When dipped beam is activated.

5.1.8. Using home safe lighting

Some of the exterior lighting can be kept switched on to work as home safe lighting after the car has been locked.

To activate the function:

- 1 Switch off the car.
 - 2 Move the left-hand stalk switch forward toward the instrument panel and release.
 - 3 Get out of the car and lock the door.
- A symbol in the driver display is illuminated to indicate that the function is activated and outer lighting is switched on: Position lamps, headlamp beams, number plate lighting and lighting in outer handles*.

The length of time that home safe lighting remains on can be set via the centre display.

* Option/accessory.

5.1.9. Adapting the headlamp pattern from the headlamps

This car does not need to reset the headlamp pattern when changing from right to left-hand traffic, and vice versa.

5.1.10. Emergency brake lights

Emergency brake lights are activated to alert vehicles behind about heavy braking.

The function means that the brake light flashes instead of - as in normal braking - shining with a constant glow.

The emergency brake lights are activated during heavy braking or if the ABS system is activated at high speeds.

After the driver brakes to a low speed and then releases the brake, the brake light returns to normal glow.

The car's hazard warning flashers are activated at the same time. These flash until the driver accelerates the car to a higher speed again or switches off the car's hazard warning flashers.

5.1.11. Position lamps

Position lamps can be used so that other road users can see the car if it stops or is parked. The position lamp is switched on with the rotating ring on the stalk switch.



Stalk switch rotating ring in position lamps position.

Turn the rotating ring to the  position - the position lamps are switched on (number plate lighting is switched on at the same time).

If the car's electrical system is in ignition position II then the daytime running lights are switched on instead of the front position lamps. When the rotating ring is in this position, the position lamps are switched on regardless of the ignition position of the car's electrical system.

If the car is stationary but running, the rotating ring can be moved to the position lamp  position from another position to switch on only the position lamps instead of other lighting.

When driving for more than 30 seconds at max. 10 km/h (approx. 6 mph), or if the speed exceeds 10 km/h (approx. 6 mph), the daytime running lights are switched on. The driver should turn to a position other than .

If the tailgate is opened when it is dark outside, the rear position lamps come on (if not already switched on) to warn road users approaching from behind. This takes place irrespective of the position of the rotating ring or the ignition position of the car's electrical system.

5.1.12. Guidance light

The guidance light is switched on when the car is unlocked and is used to switch on the car's lighting at a distance.

The function is activated when the car is unlocked. In daylight, position lamps, interior roof lamps, floor lights and cargo area lighting are activated. In weak daylight or darkness, number plate lighting and lighting in the outer handles are also activated* with their light source aimed towards the ground.

The lighting stays on for approx. 2 minutes if no doors are opened. If a door is opened within the activation time, the time for the interior lighting and lighting in the outer handles* will be extended.

The function can be activated and deactivated via the centre display.

* Option/accessory.

5.1.13. Hazard warning flashers

Hazard warning flashers warn other road users by means of all of the car's direction indicators being activated simultaneously. The function can be used to give a warning in the event of traffic hazards.

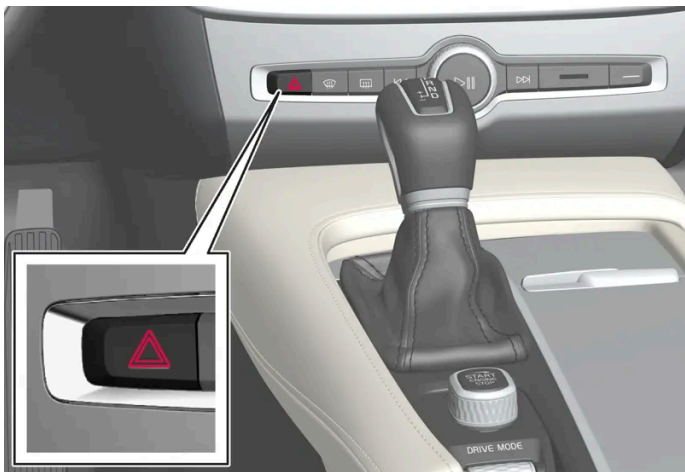

Button for hazard warning flashers.

Press the button to activate the hazard warning flashers.

The hazard warning flashers are automatically activated when the car brakes so powerfully that the emergency brake lights are activated and the speed is low. The hazard warning flashers start to flash after the emergency brake lights have stopped flashing and are then deactivated automatically when the car drives away again or are deactivated if the button is depressed.

The hazard warning flashers are activated automatically in the event of a collision.

Note

Regulations for the use of hazard warning flashers may vary between countries.

5.1.14. Daytime running lights

The car has sensors that detect the light conditions in the surroundings. The daytime running lights are switched on when the rotating ring on the stalk switch is in position **0** , **☰☑☒** or **AUTO** as well as when the car's electrical system is in ignition position II. In position **AUTO**, the headlamps change automatically to dipped beam in weak daylight or darkness.



Stalk switch rotating ring in **AUTO** position.

If the stalk switch rotating ring is in the **AUTO** position, the daytime running lights (DRL ^[1]) are switched on when the car is driven in daylight. The car automatically changes lighting from daytime running light to dipped beam in weak daylight or darkness. Changing to dipped beam also takes place if the front fog lamp* and/or rear fog lamp are activated.

Warning

This system help to save energy - it cannot determine in all situations when daylight is too weak or sufficiently strong, e.g. in mist and rain.

The driver is always responsible for ensuring that the car is driven with the correct beam pattern for the traffic situation and in accordance with applicable traffic regulations.

^[1] Daytime Running Lights

* Option/accessory.

5.1.15. Checking trailer lamps

When connecting a trailer – check that the trailer lamps work before departure.

Checking trailer lamps*

Automatic checking

After a trailer is connected electrically, it is possible to check that the trailer lamps are working via an automatic lamp activation. The function helps the driver check that the trailer lamps are working before starting off.

The car must be switched off to perform the check.

- 1 When a trailer is connected to the towbar, the **Automatic Trailer Lamp Check** message is shown in the driver display.
- 2 Confirm the message by pressing the right-hand steering wheel keypad's **O** button.
 - The lamp check starts.
- 3 Exit the car to check lamp functionality.
 - All trailer lamps start to flash - then the lamps are switched on one at a time.
- 4 Visually check that all lamps available on the trailer are operational.
- 5 After a moment, all lamps on the trailer flash again.
 - The check is complete.

Switching off automatic checking

The automatic checking function can be switched off in the centre display.

- 1 Press **Settings** in the top view.
- 2 Press **My Car** → **Lights and Lighting**.
- 3 Deselect **Automatic Trailer Lamp Check**.

Manual checking

If the automatic checking is switched off then it is possible to start the check manually.

- 1 Press **Settings** in the top view.
 - 2 Press **My Car** → **Lights and Lighting**.
 - 3 Select **Manual Trailer Lamp Check**.
- The lamp check starts. Exit the car to check lamp functionality.

Rear fog lamp on trailer

When connecting the trailer, the rear fog lamp may not light up on the car. In such cases, the rear fog lamp function switches to the trailer. Upon activation of the rear fog lamp, check therefore that the trailer is equipped with a rear fog lamp to travel safely.

Symbols and messages in the driver display

If one or more of the trailer's direction indicators or brake light bulbs is broken, the driver display shows a symbol and a message. Other lights on the trailer must be checked manually by the driver before setting off.

Symbol	Message
	<ul style="list-style-type: none">• Trailer turn indicator Right turn indicator malfunction• Trailer turn indicator Left turn indicator malfunction
	<ul style="list-style-type: none">• Trailer brake light Malfunction

If any lamp for the trailer's direction indicators is broken, the driver display symbol for direction indicators will also flash more quickly than normal.

* Option/accessory.

5.2. Interior lighting

5.2.1. Interior lighting

The passenger compartment is equipped with several types of lighting, e.g. general interior lighting, adjustable decor illumination and reading lighting.

All lighting in the passenger compartment can be switched on and off manually at least 5 minutes from when:

- the car has been switched off and its electrical system is in ignition position 0
- the car has been unlocked but it has not yet been started.

Front roof lighting

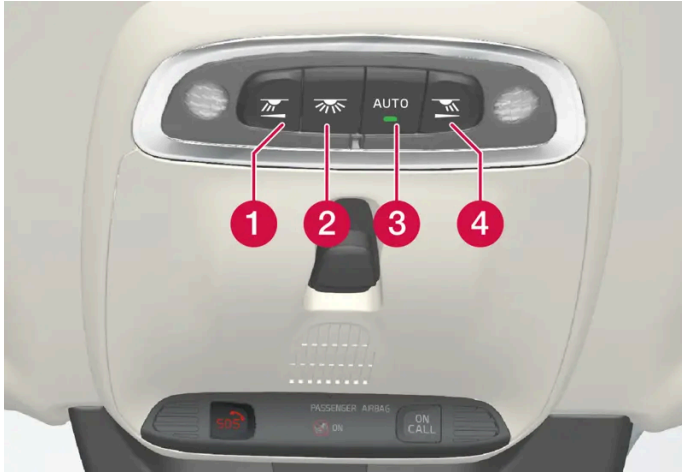

Controls in roof console for the front reading lamps and passenger compartment lighting.

- 1 Reading lamp, left-hand side
- 2 Passenger compartment lighting
- 3 Auto function for passenger compartment lighting
- 4 Reading lamp, right-hand side

Reading lighting

The reading lamps on the right and left-hand sides can be turned on and off by briefly pressing the buttons in the roof console. Brightness is adjusted by holding the button pressed in.

Passenger compartment lighting

The floor lighting and interior roof lighting are switched on or off with a short press on the button in the roof console.

Auto function for passenger compartment lighting

The automatic function is activated by a short press on the **AUTO** button in the roof console. With the automatic system activated, the light indicator in the button illuminates and the passenger compartment lighting is switched on and off according to the following.

The passenger compartment lighting comes on when:

- The car is unlocked
- The car is switched off
- A side door is opened.

The passenger compartment lighting goes off when:

- The car is locked

- The car is started
- A side door is closed
- A side door has remained open for approx. 2 minutes.

Rear roof lighting

The rear area of the car has reading lighting, which is also used as passenger compartment lighting.



Reading lamps above the rear seat^[1].



In cars with panoramic roof* there are two lamp units, one on each side of the roof.^[2]

The reading lamps are switched on or off by briefly pressing the button on the lamp. Brightness is adjusted by holding the button pressed in.

Glovebox lighting

Glovebox lighting is switched on and off respectively when the lid is opened or closed.

Sun visor mirror lighting*

The lighting for the mirror in the sun visor is switched on and off respectively when the cover is opened or closed.

Ground lighting*

The ground lighting is switched on or off when the corresponding door is opened or closed.

Door sill lighting

The door sill lighting is switched on or off when a door is opened or closed.

Lighting in the cargo area

The lighting in the cargo area is switched on or off when the tailgate is opened or closed.

Decor lighting

The ambient light is switched on when you open the doors and is switched off when the car is locked. The intensity of the decor lighting can be adapted in the centre display and also precisely adjusted using the thumbwheel in the instrument panel.

Ambience lights*

The car is equipped with LEDs that make it possible to change the colour of the light. These lights are switched on when the car is running. The ambience light can be adapted in the centre display and also precisely adjusted using the thumbwheel in the instrument panel.

Lighting in storage compartments in doors

The lighting in the storage compartments in the doors is switched on when you open the doors and is switched off when the car is locked. The brightness can be precisely adjusted using the thumbwheel in the instrument panel.

Lighting in the tunnel console's front cup holder*

The lighting in the front cup holders is switched on when the car is unlocked and is switched off when the car is locked. The brightness can be precisely adjusted using the thumbwheel in the instrument panel.

* Option/accessory.

[1] Reading lamps are also available above the third seat row*.

[2] Does not apply to the third seat row*.

5.2.2. Adjusting interior lighting

The lamps inside the car come on differently depending on the ignition position used. The interior lighting can be adjusted with a thumbwheel in the instrument panel, and certain light functions can also be adjusted via the centre display.



The thumbwheel on the instrument panel, to the left of the steering wheel, is used to adjust the brightness of the display lighting, controls lighting, ambient decor illumination and ambience light*.

Adjusting ambient decor illumination

- 1 Press **Settings** in the top view in the centre display.
- 2 Press **My Car** → **Lights and Lighting** → **Interior Lighting**.
- 3 Choose between the following settings:
 - Under **Ambient Light Intensity**, select from **Off**, **Low** and **High**.
 - Under **Ambient Light Level**, select from **Reduced** and **Full**.

Adjusting ambience light*

The car is equipped with a number of LEDs that make it possible to change the colour of the light. These lights are switched on when the car is running.

Changing the brightness of the lights

- 1 Press **Settings** in the top view in the centre display.
- 2 Press **My Car** → **Lights and Lighting** → **Interior Lighting** → **Interior Mood Lighting**.
- 3 Under **Interior Mood Light Intensity**, select from **Off**, **Low** and **High**.

Changing the colour of the light

- 1 Press **Settings** in the top view in the centre display.
- 2 Press **My Car** → **Lights and Lighting** → **Interior Lighting** → **Interior Mood Lighting**.
- 3 Choose between **By Temperature** and **By Colour** in order to change the colour of the light.

With the **By Temperature** option, the light changes according to the set passenger compartment temperature.

With the **By Colour** option, the **Theme Colours** subcategory can be used to adjust further.

* Option/accessory.

5.3. Adjusting light functions via the centre display

Several light functions can be adjusted and activated via the centre display. This applies to home safety light and guidance light, for example.

- 1 Tap on **Settings** in the centre display's top view.
 - 2 Press **My Car** → **Lights and Lighting**.
 - 3 Select **Exterior Lights** or **Interior Lighting** and then select the function that needs to be adjusted.
-

5.4. Lighting control

The different lighting controls are used to control both exterior and interior lighting. The left-hand stalk switch activates and adjusts the exterior lighting. The interior brightness is adjusted using a thumbwheel on the instrument panel.



Exterior lighting

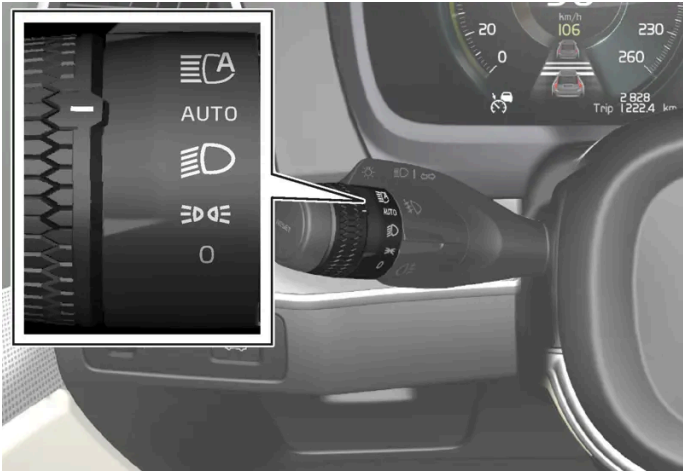

Rotating ring in the left-hand stalk switch.

When the car's electrical system is in ignition position II, the following functions are available for the rotating ring's different positions:

Position	Specification
0	Daytime running lights. Main beam flash can be used.
	Daytime running lights and position lamps. Position lamps when the car is parked. ^[1] Main beam flash can be used.
	Dipped beam and position lamps. Main beam can be activated. Main beam flash can be used.
AUTO	Daytime running lights and position lamps in daylight. Dipped beam and position lamps in weak daylight or darkness, or when the front fog lamp* and/or rear fog lamp are activated. The Active main beam function can be activated. Main beam can be activated when dipped beam is switched on. Main beam flash can be used.
	Active main beam on/off.

Volvo recommends that **AUTO** mode is used when the vehicle is driven.

Warning

The car's lighting system is not able to determine when daylight is too weak or sufficiently strong, e.g. in fog and rain, in all situations.

The driver is always responsible for ensuring that the car is driven with a beam pattern suitable for the traffic situation and in accordance with applicable traffic regulations.

Thumbwheel in instrument panel



Thumbwheel (to left) for adjusting interior brightness.

[1] If the car is stationary but running, the rotating ring can be moved to  position from another position to switch on only the position lamps instead of other lighting.

* Option/accessory.

6. Windows, glass and mirrors

6.1. Rearview mirrors

6.1.1. HomeLink® * [1]

HomeLink® [2] is a programmable remote control integrated into the car's electrical system. It can control up to three different devices remotely, e.g. a garage door opener or alarm system, and hence replace the remote controls for these.

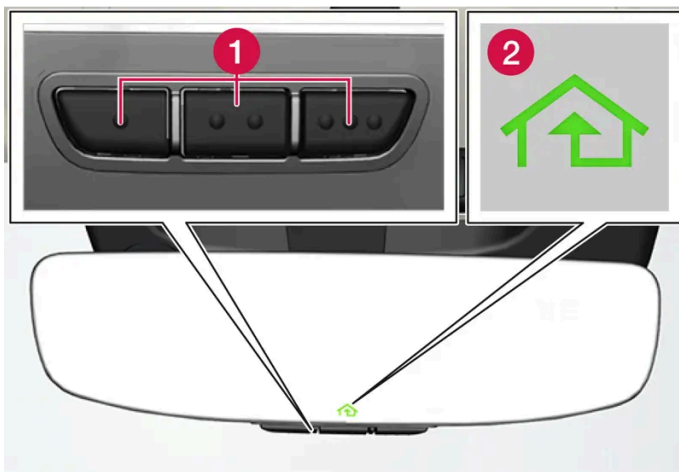

The figure is schematic - the version may vary.

- 1 Programmable buttons
- 2 Indicator lamp

HomeLink® is built into the interior rearview mirror and consists of three programmable buttons and one indicator lamp in the mirror glass.

i Note

Save the original remote controls for future reprogramming (e.g. when changing to another car or for use in another vehicle).

It is also recommended that the programming for the buttons should be deleted when the car is sold.

More information

Visit homelink.com or call 00 8000 466 354 65 (or premium charge number +49 6838 907 277) [3].

* Option/accessory.

[1] Applies to certain markets.

[2] HomeLink and the HomeLink house symbol are registered trademarks of Gentex Corporation.

[3] Note that the toll-free number may not be available depending on operator.

6.1.2. Rearview and door mirrors

The rearview mirrors and door mirrors can be used to give the driver better visibility to the rear.

Interior rearview mirror

The interior rearview mirror is equipped with HomeLink*, automatic dimming* and compass*.

The interior rearview mirror is adjusted by angling it manually.

Door mirrors



Both mirrors are bent to provide optimal vision. Objects may appear to be further away than they actually are.

The door mirror positions are adjusted with the joystick in the driver's door control panel.

There are also a number of automatic settings that can be linked to the memory function buttons for the power seat*.

* Option/accessory.

6.1.3. Angling adjustment of the door mirrors

To ensure better visibility to the rear, the door mirrors need to be set to the preferences of the driver.

There are a number of automatic settings that can also be linked to the memory function buttons for the power seat*.

Using controls for door mirrors

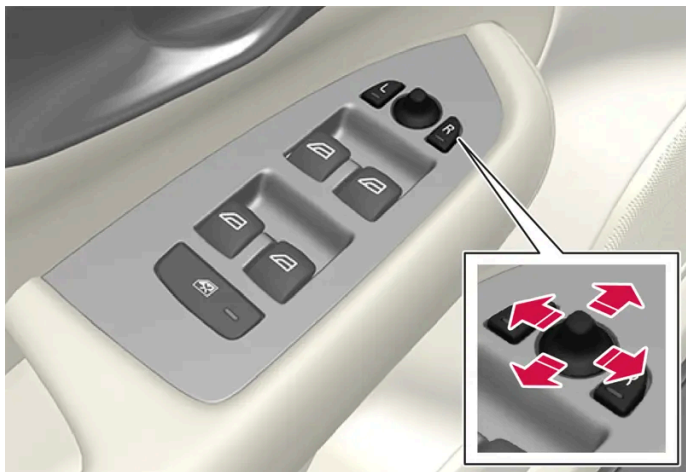

Controls for door mirrors.

The door mirror positions are adjusted with the joystick in the driver's door control panel. Ignition position must be at least I.

- 1 Press the L button for the left-hand door mirror or the R button for the right-hand door mirror. The light in the button illuminates.
- 2 Adjust the position with the joystick in the centre.
- 3 Press the L or R button again. The light should no longer be illuminated.

Folding in rearview mirrors electrically*

The mirrors can be retracted for parking/driving in narrow spaces.

- 1 Depress the L and R buttons simultaneously.
- 2 Release them after approximately 1 second. The mirrors automatically stop in the fully retracted position.

Fold out the mirrors by pressing down the L and R buttons simultaneously. The mirrors automatically stop in the extended position with the previous setting.

Resetting to neutral

Mirrors that have been moved out of position by an external force must be reset electrically to their original position for electric retracting/extending* to work correctly.

- 1 Fold in the door mirrors by pressing down the L and R buttons simultaneously.
- 2 Fold them out again by pressing the L and R buttons simultaneously.

The content of this manual represents the status of the user manual at the time of printing and may not be completely valid in future instances. For more information, refer to the first page for the complete disclaimer note.

- 3 Repeat the above procedure as necessary.

The mirrors are returned to the original position.

Angling during parking^[1]

A door mirror can be angled down for the driver to view the side of the road when parking, for example.

- 1 Engage reverse gear and press the L or R button.

Note that the button may need to be pressed twice, depending on whether it was already preselected. The button flashes when the door mirror is angled down. When reverse gear is disengaged, the door mirror automatically starts to return after approx. 3 seconds and then reaches its original position after approx. 8 seconds.

Automatic angling during parking^[1]

With this setting, the door mirror is automatically angled down when reverse gear is selected. The folded position is preset and cannot be adjusted.

- 1 Tap on **Settings** in the centre display's top view.
- 2 Press **My Car** → **Mirrors and Convenience**.
- 3 Under **Exterior Mirror Tilt at Reverse**, select **Off**, **Driver**, **Passenger** or **Both** to activate/deactivate and to select which review mirror should be angled.

You can make the door mirror return to its original position by pressing the L or R button twice.

Automatic retraction when locking*

In the centre display, you can set all the rearview and door mirrors to retract/extend automatically when the car is locked/unlocked using the key.

- 1 Tap on **Settings** in the centre display's top view.
- 2 Press **My Car** → **Mirrors and Convenience**.
- 3 Select **Fold Mirror When Locked** to activate/deactivate.

Note

If you manually fold the mirrors with the L and R buttons and then lock the car, they will not fold out automatically when you unlock the car, even if this setting has been made. They must be manually folded out.

* Option/accessory.

[1] Only in combination with power seat with memory buttons*.

6.1.4. Adjusting rearview mirror dimming

Bright light from behind could be reflected in the rearview mirrors and dazzle the driver. Use dimming when disturbed by light from behind.

Manual dimming

The interior rearview mirror can be dimmed with a control in the mirror's lower edge.



1 Control for manual dimming.

- 1** Use dimming by moving the control in towards the passenger compartment.
- 2** Return to normal mode by moving the control towards the windscreen.

The control for manual dimming is not available on mirrors with automatic dimming.

Automatic dimming*

If bright light comes from behind, the rearview mirrors automatically dim when it is dark outside or when the light is limited, for example when driving in tunnels. Automatic dimming is always active while driving, apart from when gearbox reverse position is selected.

i Note

When sensitivity is changed there is no immediately noticeable change in dimming, but the change takes place gradually.

Dimming sensitivity will affect both the interior rearview mirror and the door mirrors.

To change dimming sensitivity:

- 1 Press **Settings** in the top view in the centre display.
- 2 Press **My Car** → **Mirrors and Convenience**.
- 3 Under **Rearview Mirror Auto Dimming**, select **Normal**, **Dark** or **Light**.

The interior rearview mirror contains two sensors - one forward facing and one rearward facing - that work together to identify and eliminate dazzling light. The forward facing sensor detects ambient light, while the rearward facing sensor detects the light from vehicle headlights behind.

For the door mirrors to be equipped with automatic dimming, the interior rearview mirror must also be equipped with automatic dimming.

i Note

If the sensors are obscured by e.g. parking permits, transponders, sun visors or objects in the seats or in the cargo area in such a way that light is prevented from reaching the sensors, then the dimming function of the interior rearview and door mirrors is reduced.

* Option/accessory.

6.1.5. Using a stored position for seat, door mirrors and head-up display*

If the positions for the power* seat, the door mirrors and the head-up display* have been stored, they can be activated by using the memory buttons.

Using a stored setting

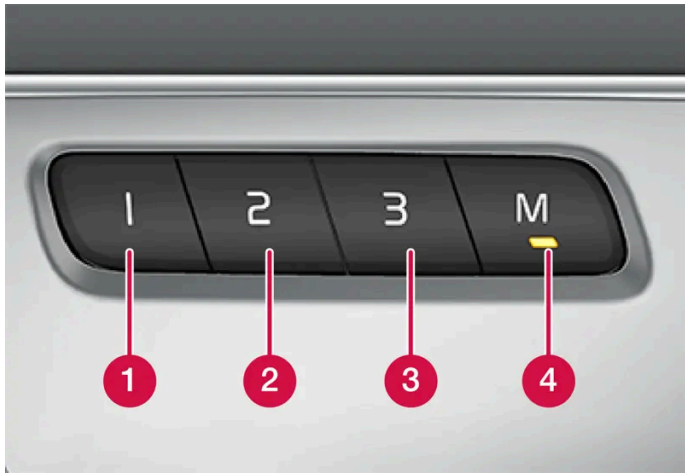

A stored setting can be used with the front door either open or closed:

Open front door

- 1 Press one of the memory buttons 1 - 3 with a brief touch. Power seat, door mirrors and head-up display move and then stop at the positions stored in the selected memory button.

Closed front door

- 1 Hold one of the memory buttons 1 - 3 depressed until seat, door mirrors and head-up display stop in the positions that are stored in the selected memory button.

If the memory button is released, the movement of the seat, door mirrors and head-up display will be stopped.

Warning

- Because the driver's seat can be adjusted with the ignition off, children should never be left unattended in the vehicle.
- Movement of the seat can be STOPPED at any time by pressing any button on the power seat control panel.
- Do not adjust the seat while driving.
- Make sure there is nothing under the seats when they are being adjusted.

Note

All driver profiles need to be set in **Protect Profile** mode in order for the stored positions to work.

* Option/accessory.

The content of this manual represents the status of the user manual at the time of printing and may not be completely valid in future instances. For more information, refer to the first page for the complete disclaimer note.

6.1.6. Storing position for seat, door mirrors and head-up display*

You can store the position for power* seat, door mirrors and head-up display* in the memory buttons.

Store three different positions for the power* seat, the door mirrors and the head-up display* using the memory buttons. The buttons are located on the inside of one of the front doors or both*.

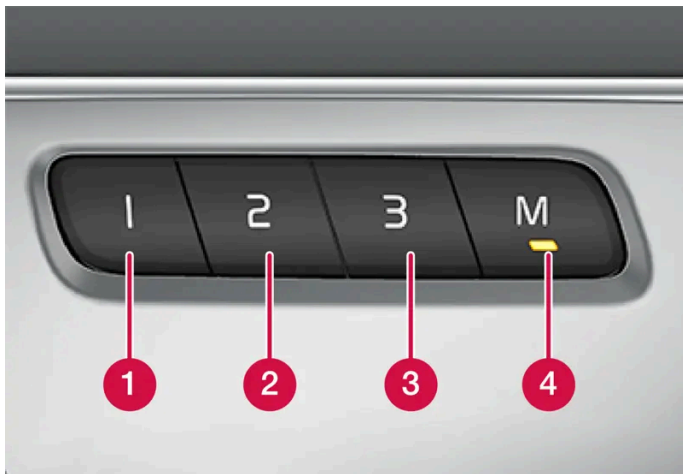

- ❶ Memory button.
- ❷ Memory button.
- ❸ Memory button.
- ❹ Button **M** for storing settings.

Storing a position

- ❶ Adjust seat, door mirrors and head-up display to the desired position.
- ❷ Press and hold the **M** button depressed. The light indicator in the button illuminates.
- ❸ Press and hold the **1**, **2** or **3** button within three seconds.
 - When the position has been stored in the selected memory button, an acoustic signal can be heard and the light indicator in the **M** button extinguishes.

If none of the memory buttons is depressed within three seconds then the **M** button extinguishes and no storing takes place.

The seat, the door mirrors or the head-up-display must be readjusted before a new memory can be set.

Note

All driver profiles need to be set in **Protect Profile** mode in order for the stored positions to work.

* Option/accessory.

6.1.7. Activating and deactivating the heated rear window and door mirrors

The heated rear window and door mirrors are used to quickly remove mist and ice from the windows and mirrors.

Activating and deactivating heated rear window and door mirrors from centre console

In the centre console is a physical button for rapid access to the heated rear window and door mirrors.



Physical button in the centre console.

- 1 Press the button.
 - > Heated rear window and door mirrors are activated/deactivated and the button illuminates/extinguishes.

Activating and deactivating heated rear window and door mirrors from centre display



Open climate view in the centre display by pressing the symbol in the middle of the climate row.

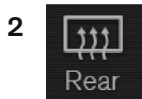

Press **Rear**.

- Heated rear window and door mirrors are activated/deactivated and the button illuminates/extinguishes.

6.1.8. Activating and deactivating automatic starting of the heated rear window and door mirrors

The heated rear window and door mirrors are used to quickly remove mist and ice from the windows and mirrors.

It is possible to set whether automatic start of heated rear window and door mirrors should be activated/deactivated when the engine is started. With automatic start activated, heating will start when there is a risk of ice or misting on the windscreen/window. The heating switches off automatically when the windscreen/window is sufficiently warm and the ice or misting is gone.

- 1 Press **Settings** in the top view in the centre display.
- 2 Press **Climate**.
- 3 Select **Auto Rear Defroster** to activate/deactivate automatic start of heated rear window and door mirrors.

6.2. Windscreen and rear window

6.2.1. Head up display when replacing the windscreen*

Cars with head-up display are equipped with a special type of windscreen that meets the requirements for displaying the projected image.

Volvo recommends that you contact an authorised Volvo workshop when replacing the windscreen. The correct version of the windscreen must be fitted in order that the head-up display's graphics shall be displayed correctly.

* Option/accessory.

6.2.2. Wiper blades and washer fluid

Together with the washer fluid, the wipers aim to improve visibility as well as headlamp pattern.

The washer nozzles are heated* automatically in cold weather to prevent the washer fluid from freezing.

Information indicating that the washer fluid needs topping up appears in the driver display when there is approx. 1 litre (1 qt) of washer fluid remaining.

* Option/accessory.

6.2.3. Using automatic rear windscreen wiping when reversing

Engaging reverse gear while the windscreen wipers are switched on initiates rear window wiping. The function stops when reverse gear is disengaged.

- 1 Press **Settings** in the top view in the centre display.
- 2 Press **My Car** → **Wipers**.
- 3 Select **Auto Rear Wiper** to activate/deactivate wiping when reversing.



If the rear windscreen wiper is already operating at a constant speed then no change takes place when reverse gear is engaged.

6.2.4. Using the rear window wiper and rear window washer

The rear window wiper and rear window washer are designed to clean the rear window. Washing/wiping is started and settings are changed by means of the right-hand steering wheel stalk switch.

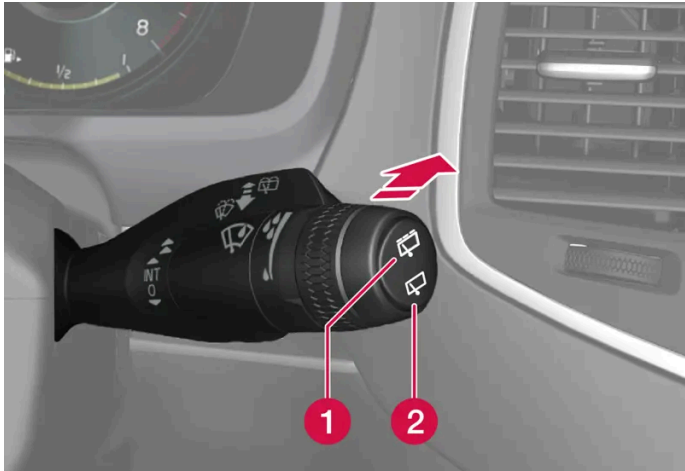
Activating the rear window wiper and rear window washer



- 1 Select  for intermittent wiping with the rear window wiper.
- 2 Select  for continuous speed with the rear window wiper.

- 1 Move the right-hand steering wheel stalk switch forward to start rear window washing and wiping.

Automatic rear windscreen wiping when reversing

Engaging reverse gear while the windscreen wipers are switched on initiates rear window wiping. The function stops when reverse gear is disengaged.

Contact an authorised Volvo workshop in order to deactivate the function.

Note

In low outside temperature, the automatic rear window wiping when reversing is deactivated in order to avoid damage to the wiper arm.

6.2.5. Using the rain sensor

The rain sensor automatically starts the windscreen wipers based on how much water it detects on the windscreen. Rain sensor sensitivity can be adjusted with the thumbwheel on the right-hand stalk switch.

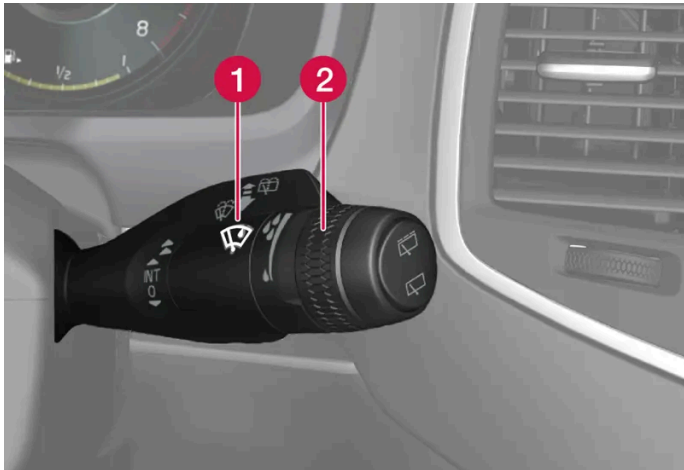

Right-hand stalk switch.

- 1 Rain sensor button
- 2 Thumbwheel sensitivity/frequency

When the rain sensor is activated, the rain sensor symbol  is shown in the driver display.

Activating the rain sensor

When activating the rain sensor, the car must be running or in ignition position I or II while the windscreen wiper stalk switch is in position 0 or in the position for a single sweep.

Activate the rain sensor by pressing the rain sensor button .

Move the lever down to make the wipers move.

Turn the thumbwheel upward for higher sensitivity and downward for lower sensitivity. An extra sweep is made when the thumbwheel is turned upward.

Deactivating the rain sensor

Deactivate the rain sensor by pressing the rain sensor button  or moving the stalk switch up to another wiper program.

The rain sensor is deactivated automatically in ignition position 0 or when the engine is switched off.

The rain sensor is deactivated automatically when wiper blades are set in service position. The rain sensor is reactivated when service mode has been deactivated.

Important

The windscreen wipers could start and be damaged in an automatic car wash. Deactivate the rain sensor while the car is running or when the car's electrical system is in ignition position I or II. The symbol in the driver display extinguishes.

6.2.6. Activating and deactivating the rain sensor's memory function

The rain sensor automatically starts the windscreen wipers based on how much water it detects on the windscreen.

When the memory function is activated, the rain sensor button does not need to be pressed every time the vehicle is started:

- 1 Tap on **Settings** in the centre display's top view.
- 2 Press **My Car** → **Wipers**.
- 3 Select **Rain Sensor Memory** to activate/deactivate the memory function.

6.2.7. Using windscreen and headlamp washers

Windscreen and headlamp washers are designed to clean the windscreen and headlamps. Windscreen and headlamp washers are started using the right-hand stalk switch.

Starting windscreen and headlamp washers



Washing function, right-hand stalk switch.

- 1 Move the right-hand stalk switch toward the steering wheel to start the windscreen and headlamp washers.
 - The windscreen wipers will make several more sweeps once the stalk switch has been released.

! Important

Avoid activating the washer system when it is frozen or the washer reservoir is empty, otherwise there is a risk of damaging the pump.

Headlamp washing*

To save fluid, the headlamps are washed automatically at a defined interval when the headlamps are switched on.

Reduced washing

If only approx. 1 litre (1 qt) of washer fluid remains in the reservoir and the message **Washer fluid Level low, refill**, together with the  symbol, is shown in the driver display, then the supply of washer fluid to the headlamps is switched off. This is to prioritise cleaning the windscreen and the visibility through it. The headlamps are only washed if main or dipped beam is switched on.

* Option/accessory.

6.2.8. Using windscreen wipers

The windscreen wipers are designed to clean the windscreen. Different settings for the windscreen wipers are set using the right-hand stalk switch.

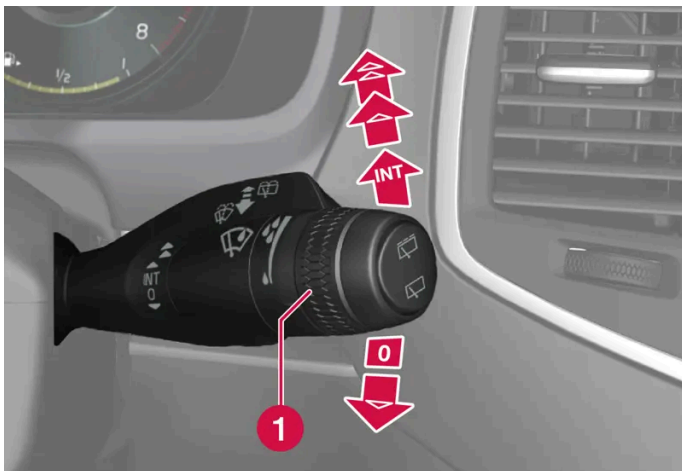

Right-hand stalk switch.

1 The thumbwheel is used to set rain sensor sensitivity and wiper swipe frequency.

Single sweep

- ▼ Lower the stalk switch and release to make one sweep.

Windscreen wipers off

- 0 Move the stalk switch to position 0 to switch off the windscreen wipers.

Intermittent wiping

- INT Move the lever up to switch the wipers to intermittent wiping. Set the number of sweeps per time unit with the thumb-wheel when intermittent wiping is selected.

Continuous wiping

- ▲ Raise the stalk switch for the wipers to sweep at normal speed.
- ▲ Raise the stalk switch further for the wipers to sweep at high speed.

! Important

Before activating the wipers - ensure that the wiper blades are not frozen in, and that any snow or ice on the windscreen and rear window is scraped away.

6.2.9. Activating and deactivating the heated rear window and door mirrors

The heated rear window and door mirrors are used to quickly remove mist and ice from the windows and mirrors.

Activating and deactivating heated rear window and door mirrors from centre console

In the centre console is a physical button for rapid access to the heated rear window and door mirrors.



Physical button in the centre console.

- 1 Press the button.

The content of this manual represents the status of the user manual at the time of printing and may not be completely valid in future instances. For more information, refer to the first page for the complete disclaimer note.

- > Heated rear window and door mirrors are activated/deactivated and the button illuminates/extinguishes.

Activating and deactivating heated rear window and door mirrors from centre display



Open climate view in the centre display by pressing the symbol in the middle of the climate row.

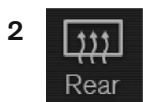

Press **Rear**.

- > Heated rear window and door mirrors are activated/deactivated and the button illuminates/extinguishes.

6.2.10. Activating and deactivating automatic starting of the heated rear window and door mirrors

The heated rear window and door mirrors are used to quickly remove mist and ice from the windows and mirrors.

It is possible to set whether automatic start of heated rear window and door mirrors should be activated/deactivated when the engine is started. With automatic start activated, heating will start when there is a risk of ice or misting on the windscreen/window. The heating switches off automatically when the windscreen/window is sufficiently warm and the ice or misting is gone.

- 1 Press **Settings** in the top view in the centre display.
- 2 Press **Climate**.
- 3 Select **Auto Rear Defroster** to activate/deactivate automatic start of heated rear window and door mirrors.

6.2.11. Activating and deactivating the heated windscreen*

A heated windscreen is used to quickly remove mist and ice from the window.

Activating and deactivating heated windscreen from centre console

In the centre console is a physical button for rapid access to the heated windscreen.



Physical button in the centre console.

- 1 Press the button repeatedly in order to switch between the three levels:
 - Activated heated windscreen
 - Activated heated windscreen and max defroster
 - Deactivated.
- Heated windscreen and max defroster are activated/deactivated and the button illuminates/extinguishes.

Activating and deactivating heated windscreen from centre display



Open climate view in the centre display by pressing the symbol in the middle of the climate row.

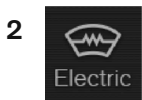

Press **Electric**.

- Heated windscreen is activated/deactivated and the button illuminates/extinguishes.

i Note

A triangular area at the end of each side of the windscreen is not electrically heated, where de-icing may take longer.

i Note

The heated windscreen may affect the performance of transponders and other communication equipment.

* Option/accessory.

6.2.12. Activating and deactivating automatic start of heated windscreen *

A heated windscreen is used to quickly remove mist and ice from the window.

It is possible to set whether automatic start of heated windscreen should be activated/deactivated when the engine is started. With automatic start activated, heating will start when there is a risk of ice or misting on the windscreen/window. The heating switches off automatically when the windscreen/window is sufficiently warm and the ice or misting is gone.

- 1 Press **Settings** in the top view in the centre display.
- 2 Press **Climate**.
- 3 Select **Auto Front Defroster** to activate/deactivate automatic start of heated windscreen.

* Option/accessory.

6.3. Side windows and panoramic roof

6.3.1. Power windows

Each door has a control panel for the electrically-driven power windows. The driver's door has controls for operating all windows and also to activate the child safety locks.

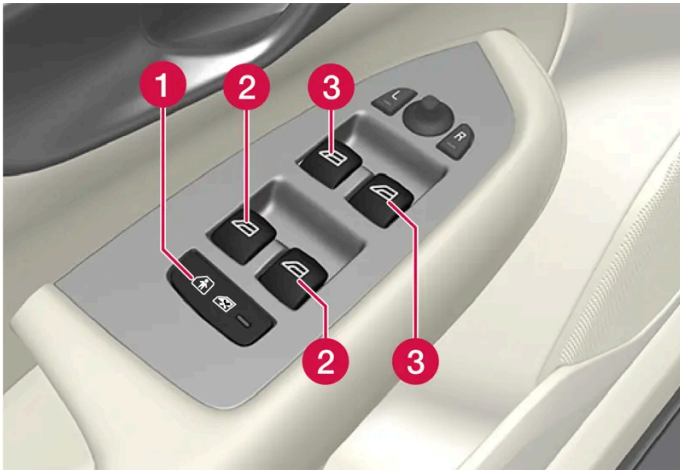

Driver's door control panel.

- 1 Electric child safety locks* that deactivate the controls in the rear doors to prevent doors or windows from being opened from the inside.
- 2 Controls for rear windows.
- 3 Controls for front windows.

 **Warning**

Children, other passengers or objects may be trapped by the moving parts.

- Always operate the windows with caution.
- Do not allow children to play with the controls.
- Never leave children alone in the car.
- Remember to always switch off the power supply to the power windows by setting the car's electrical system in ignition position 0, and then take the key with you when leaving the car.
- Never put an object or part of the body through the windows, even if the car's electrical system is fully disconnected.

* Option/accessory.

6.3.2. Operating power windows

Using the driver's door control panel, all power windows can be operated - using the control panels in the other doors operates the power window in the individual door.

The power windows are equipped with pinch protection. If any fault arises with the pinch protection, a reset sequence can be tested.

 **Warning**

Children, other passengers or objects may be trapped by the moving parts.

- Always operate the windows with caution.
- Do not allow children to play with the controls.
- Never leave children alone in the car.
- Remember to always switch off the power supply to the power windows by setting the car's electrical system in ignition position 0, and then take the key with you when leaving the car.
- Never put an object or part of the body through the windows, even if the car's electrical system is fully disconnected.



Operating the power windows.

- 1 Operating without auto. Move one of the controls gently up or down. The power windows move up or down as long as the control is held in position.
- 2 Operating with auto. Move one of the controls up or down to the end position and release it. The window runs automatically to its end position.

In order for the power windows to be used, the ignition position must be I or II. The power windows can be operated for a few minutes after the car has been switched off and after the ignition has been switched off - although not after a door has been opened. It is only possible to operate one control at a time.

It can also be operated using a remote control key or keyless opening* with the door handle.

 **Warning**

Check that children or other passengers are not at risk of crushing when all the windows are closed with a remote control key or keyless opening* with a door handle.

 **Note**

One way to reduce the pulsating wind noise when the rear windows are open is to also open the front windows slightly.

Note

The windows cannot be opened at speeds above approx. 180 km/h (approx. 112 mph), but they can be closed.

The driver always bears responsibility for following traffic regulations in force.

Note

It may not be possible to operate windows at low temperatures.

* Option/accessory.

6.3.3. Panoramic roof*

The panoramic roof is divided into two glass sections. The front section can be opened vertically at the rear edge (ventilation position) or horizontally (open position). The rear section is fixed roof glass.

The panoramic roof has a wind deflector and a sun blind made of perforated fabric and located under the glass roof to provide extra protection from factors such as strong sunlight.



The panoramic roof and sun blind are operated with a control located in the roof.

In order that the panoramic roof and the sun blind can be operated, the car's electrical system must be in ignition position I or II.

 **Warning**

Children, other passengers or objects may be trapped by the moving parts.

- Always operate the windows with caution.
- Do not allow children to play with the controls.
- Never leave children alone in the car.
- Remember to always switch off the power supply to the power windows by setting the car's electrical system in ignition position 0, and then take the key with you when leaving the car.
- Never put an object or part of the body through the windows, even if the car's electrical system is fully disconnected.

 **Important**

- Do not open the panoramic roof when load carriers are fitted.
- Do not place any heavy objects on the panoramic roof.

 **Important**

- Remove ice and snow before opening the panoramic roof. Take care not to scratch surfaces or damage strips.
- Do not operate the panoramic roof if it has frozen closed.

Wind deflector



The panoramic roof has a wind deflector that is raised when the panoramic roof is in the open position.

* Option/accessory.

6.3.4. Operating the panoramic roof*

The content of this manual represents the status of the user manual at the time of printing and may not be completely valid in future instances. For more information, refer to the first page for the complete disclaimer note.

The panoramic roof and sun blind are operated with a control in the roof panel and both are equipped with pinch protection.

 **Warning**

Children, other passengers or objects may be trapped by the moving parts.

- Always operate the windows with caution.
- Do not allow children to play with the controls.
- Never leave children alone in the car.
- Remember to always switch off the power supply to the power windows by setting the car's electrical system in ignition position 0, and then take the key with you when leaving the car.
- Never put an object or part of the body through the windows, even if the car's electrical system is fully disconnected.

 **Important**

- Do not open the panoramic roof when load carriers are fitted.
- Do not place any heavy objects on the panoramic roof.

 **Important**

- Remove ice and snow before opening the panoramic roof. Take care not to scratch surfaces or damage strips.
- Do not operate the panoramic roof if it has frozen closed.

In order that the panoramic roof and the sun blind can be operated, the car's electrical system must be in ignition position I or II.

It can also be operated using a remote control key or keyless opening* with the door handle.

 **Warning**

Check that children or other passengers are not at risk of crushing when all the windows are closed with a remote control key or keyless opening* with a door handle.

 **Important**

Check that the panoramic roof is properly closed when closing.

The movement of the roof is stopped if the control is released during manual operation, or when the glass reaches the comfort position^[1] or the maximum opening or closing position. The movement of both panoramic roof and sun blind are also stopped if the roof control is operated again in the opposite direction to the current direction of movement.

The panoramic roof and the sun blind are also equipped with pinch protection. If any fault arises with the pinch protection, a re-set sequence can be tested.

i Note

For manual opening, the sun blind must be fully open before the panoramic roof can be opened. When the procedure is reversed, the panoramic roof must be fully closed before the sun blind can be fully closed.

i Note

It may not be possible to operate windows at low temperatures.

Open and close the panoramic roof to/from ventilation position using the roof control

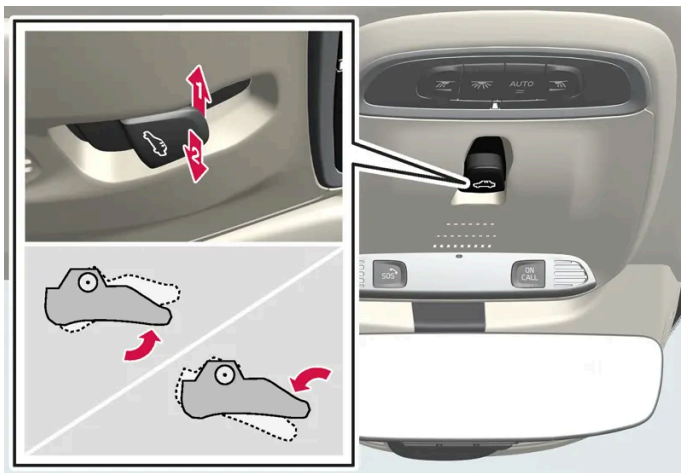

Ventilation position, vertically at the rear edge.

- 1 Open by pressing the control upward once.
- 2 Close by pressing the control downward once.

When the ventilation position is selected the front glass cover is raised at its rear edge. If the sun blind is fully closed when ventilation position is selected, then it opens automatically approx. 50 mm (approx. 2 inches).

The sun blind follows automatically if the panoramic roof is closed from ventilation position.

Fully open and close the panoramic roof using the roof control

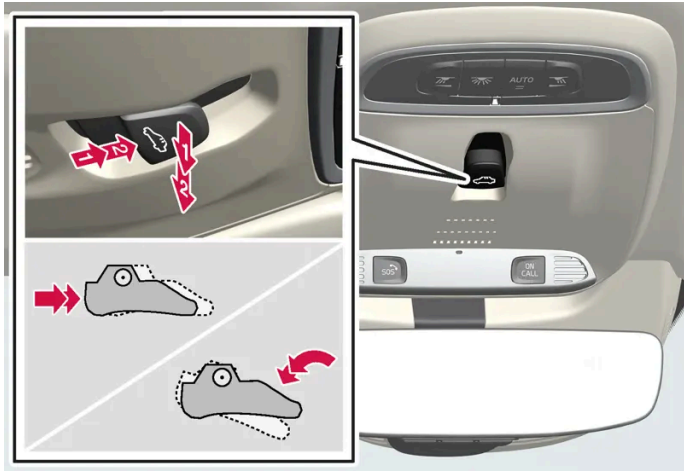

1 Operation, manual mode

2 Operation, automatic mode

Manual operation

- 1 To open the sun blind - press the control backwards to the position for manual opening.
- 2 Open the panoramic roof to comfort position - press the control backwards a second time to the position for manual opening.
- 3 Open the panoramic roof to maximum position - press the control backwards a third time to the position for manual opening.

Close by repeating the preceding procedure in reverse order - press the control forward/downward to the manual closing position instead.

Automatic operation

- 1 Open the sun blind to maximum position - press the control backward to the position for automatic opening and release.
- 2 Open the panoramic roof to comfort position - press the control backwards a second time to the position for automatic opening and release.
- 3 Open the panoramic roof to maximum position - press the control backwards a third time to the position for automatic opening and release.

Close by repeating the preceding procedure in reverse order - press the control forward/downward to the automatic closing position instead.

Automatic operation - rapid opening or closing

The content of this manual represents the status of the user manual at the time of printing and may not be completely valid in future instances. For more information, refer to the first page for the complete disclaimer note.

The panoramic roof and sun blind can be opened or closed simultaneously:

1 To open - press the control rearward to the automatic operation position twice and release.

1 To close - press the control forward/downward to the automatic operation position twice and release.

* Option/accessory.

[1] Comfort position is a position where wind noise and resonance noise are at a comfortably low level while driving.

6.3.5. Automatic closing of the panoramic roof's* sun blind

With this function, the sun blind is closed automatically 15 minutes after the car has been locked if it is parked in hot weather. This is in order to lower the passenger compartment temperature and protect the car's upholstery from sun-fading.

The function is deactivated when the car is supplied from the factory and can be activated or deactivated in the centre display.

1 Press **Settings** in the top view in the centre display.

2 Press **My Car** → **Locking**.

Select **Auto Close Sunroof Curtain** to activate/deactivate.

Note

The sun blind is also closed when all windows are closed using the remote control key or keyless opening* with a door handle.

* Option/accessory.

6.3.6. Using the sun blind*

The content of this manual represents the status of the user manual at the time of printing and may not be completely valid in future instances. For more information, refer to the first page for the complete disclaimer note.

The sun blinds are built into each rear door.

Rear door – manually operated



The figure is schematic - the version may vary.

1 Hook with associated catch

- 1** Pull up the sun blind and attach it to the hook in the upper door frame.

The window can still be opened and closed with the sun blind up.

* Option/accessory.

6.4. Windows, glass and mirrors

The car contains several different windows, glass panes and mirrors. Some of the windows in the car are laminated.

The windscreen has laminated glass, and laminated glass is available as an option for certain other glass areas. Laminated glass is reinforced, which provides better protection against break-ins and improved sound insulation in the passenger compartment.

The panoramic roof* also has laminated glass.



The symbol is shown on the windows where the glass is laminated.^[1]

* Option/accessory.

^[1] Does not apply to the windscreen or panoramic roof* which are always laminated and thus do not have this symbol.

The content of this manual represents the status of the user manual at the time of printing and may not be completely valid in future instances. For more information, refer to the first page for the complete disclaimer note.

6.5. Pinch protection for windows and sun blinds

All power windows and sun blinds* have pinch protection which is deployed if they are blocked by any object while opening or closing.

In the event of blocking, the movement stops and then reverses automatically to approx. 50 mm (approx. 2 inches) from the blocked position (or to full ventilation position).

It is possible to force pinch protection when closing has been cancelled, e.g. when ice is formed, by continuing to press the control in one and the same direction.

If any fault arises with the pinch protection, a reset sequence can be tested.

Warning

If the starter battery is disconnected, the automatic opening and closing function must be reset to work properly. A reset must take place for pinch protection to work.

* Option/accessory.

6.6. Reset sequence for pinch protection

If a problem occurs with the electrical functions for the electric windows, a reset sequence can be tested.

Warning

If the starter battery is disconnected, the automatic opening and closing function must be reset to work properly. A reset must take place for pinch protection to work.

In the event of problems with the panoramic roof, contact a workshop ^[1].

Reset the power window

- 1 Start with the window in closed position.
- 2 Then operate the controls in the manual position 3 times upwards to closed position.
- > The system is initialised automatically.

If problems persist, contact a workshop.

[1] An authorised Volvo workshop is recommended.

6.7. Activating and deactivating max defroster

Max defroster is used to quickly remove mist and ice from windows.

Max defroster deactivates auto-regulation of the climate and air recirculation, activates air conditioning and changes the fan level to **5** and the temperature to **HI**.

i Note

Changing the fan level to **5** increases the noise level.

When max defroster is deactivated, the climate control system returns to the previous settings.

Activating and deactivating max defroster from centre console

There is a physical button in the centre console for quick access to max defroster.

With heated windscreen* the max defroster can only be activated individually from the climate view in the centre display.



Physical button in the centre console.

Cars without heated windscreen:

- 1 Press the button.
- > Max defroster is activated/deactivated and the button illuminates/extinguishes.

Cars with heated windscreen:

- 1 Press the button repeatedly in order to switch between the three levels:
 - Activated heated windscreen
 - Activated heated windscreen and max defroster
 - Deactivated.
- Heated windscreen and max defroster are activated/deactivated and the button illuminates/extinguishes.

 **Note**

Max defroster starts with a certain delay in order to avoid a short increase in fan level if the heated windscreen is deactivated by two quick presses of the button.

Activating and deactivating max defroster from centre display



Open climate view in the centre display by pressing the symbol in the middle of the climate row.

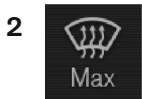

Press **Max**.

- Max defroster is activated/deactivated and the button illuminates/extinguishes.

* Option/accessory.

7. Seats and steering wheel

7.1. Front seat

7.1.1. Climate controls for front seat

7.1.1.1. Activating and deactivating heated front seat*

The seats can be heated in order to increase comfort for driver and passengers when it is cold.

1



Press the left or right-hand side's steering wheel and seat button in the climate row in the centre display in order to open the controls for seat and steering wheel.

If the car is not equipped with ventilated seats or heated steering wheel (for the driver's side), the button for heated seats is immediately available in the climate row.

2



Repeatedly press the button for heated seats in order to change between the four levels: **Off**, **High**, **Medium** and **Low**.

> The level changes and the button shows the set level.

Warning

Heated seats must not be used by people who find it difficult to perceive an increase in temperature due to a lack of sensation or who otherwise have problems operating the controls for the heated seats.

* Option/accessory.

7.1.1.2. Activating and deactivating automatic start of heated front seat*

The seats can be heated in order to increase comfort for driver and passengers when it is cold.

It is possible to set whether automatic start of heated seats should be activated/deactivated when the engine is started. With automatic start activated, heating will start in the event of low ambient temperature.

- 1 Press **Settings** in the top view in the centre display.
- 2 Press **Climate**.
- 3 Select **Auto Driver Seat Heating Level** and **Auto Passenger Seat Heating Level** to activate/deactivate automatic start of heated driver's and passenger seat.
 - An "A" is shown at each button for heated front seats in the climate row when automatic starting has been activated.
- 4 Select **Low**, **Medium** or **High** to select level after the function has been activated.

* Option/accessory.

7.1.1.3. Regulating fan level for front seat

The fan can be set to several different automatically controlled fan speeds for the front seat.



Open climate view in the centre display by pressing the symbol in the middle of the climate row.

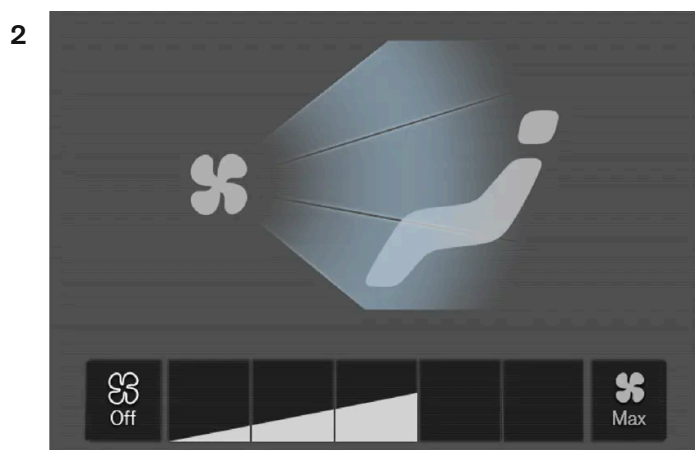

Fan control buttons in the climate view.

Tap on the desired fan level, **Off**, 1-5 or **Max**.

➤ Fan level is changed and the buttons for the selected level illuminate.

! Important

If the fan is fully switched off then the air conditioning is not engaged, which results in a risk of misting on the insides of the windows.

i Note

The climate control system automatically adjusts the air flow within the selected fan level based on requirements. This means that the fan speed may change even though the fan level is the same.

7.1.1.4. Regulating temperature for front seat

The temperature can be set to the desired number of degrees for the front seat's climate zones.

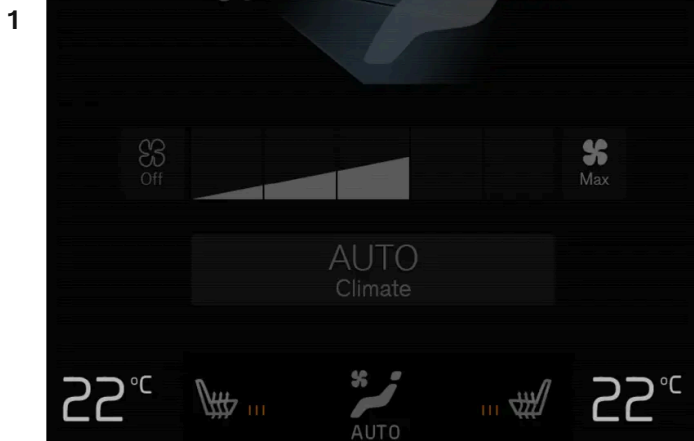

Temperature buttons in the climate row.

Press the left or right-hand side temperature button in the centre display's climate row to open the controls.

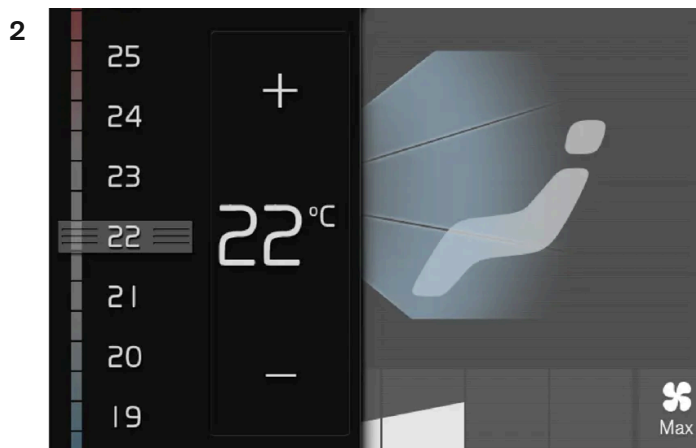

Temperature control.

Regulate the temperature by either of the following:

- drag the control to the desired temperature, or
- press +/- to raise/lower the temperature gradually.

➤ The temperature changes and the button shows the set temperature.

Note

Heating or cooling cannot be hastened by selecting a higher or lower temperature than the actual desired temperature.

7.1.1.5. Synchronising temperature

The temperature in the car's different climate zones can be synchronised with the temperature set on the driver's side.

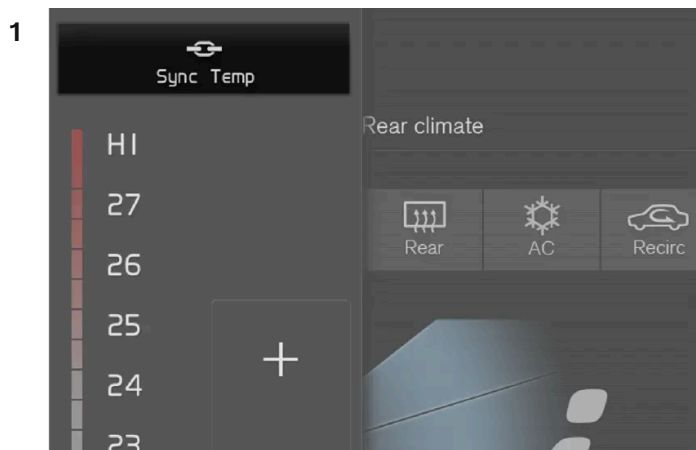

Synchronisation button on the driver's side temperature controls.

Press the driver's side temperature button in the centre display's climate row in order to open the controls.

2 Press **Synchronise temperature**.

- The temperature for all zones in the car is synchronised with the temperature set for the driver's side and the synchronisation symbol is shown adjacent to the temperature button.

The synchronisation is stopped by means of a further press on **Synchronise temperature** or by means of changing the temperature settings for a climate zone other than the driver's.

7.1.1.6. Activating and deactivating ventilated front seat *

The seats can be ventilated to provide increased comfort in a hot climate, for example.

The ventilation system consists of fans in the seats and backrests that draw air through the seat upholstery. The cooling effect increases the cooler the passenger compartment air becomes. The system can be activated when the engine is running.

1



Press the left or right-hand side's steering wheel and seat button in the climate row in the centre display in order to open the controls for seat and steering wheel.

If the car is not equipped with heated seats or heated steering wheel (for the driver's side), the button for ventilated seats is immediately available in the climate row.

2



Repeatedly press the button for ventilated seats in order to change between the four levels: **Off**, **High**, **Medium** and **Low**.

- The level changes and the button shows the set level.

* Option/accessory.

7.1.2. Memory function for front seat

7.1.2.1. Using a stored position for seat, door mirrors and head-up display*

If the positions for the power* seat, the door mirrors and the head-up display* have been stored, they can be activated by using the memory buttons.

Using a stored setting

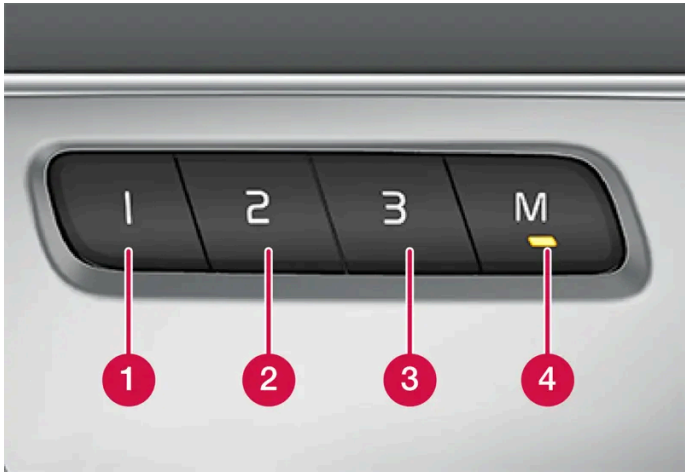

A stored setting can be used with the front door either open or closed:

Open front door

- 1 Press one of the memory buttons 1 - 3 with a brief touch. Power seat, door mirrors and head-up display move and then stop at the positions stored in the selected memory button.

Closed front door

- 1 Hold one of the memory buttons 1 - 3 depressed until seat, door mirrors and head-up display stop in the positions that are stored in the selected memory button.

If the memory button is released, the movement of the seat, door mirrors and head-up display will be stopped.

Warning

- Because the driver's seat can be adjusted with the ignition off, children should never be left unattended in the vehicle.
- Movement of the seat can be STOPPED at any time by pressing any button on the power seat control panel.
- Do not adjust the seat while driving.
- Make sure there is nothing under the seats when they are being adjusted.

Note

All driver profiles need to be set in **Protect Profile** mode in order for the stored positions to work.

* Option/accessory.

7.1.2.2. Storing position for seat, door mirrors and head-up display*

You can store the position for power* seat, door mirrors and head-up display* in the memory buttons.

Store three different positions for the power* seat, the door mirrors and the head-up display* using the memory buttons. The buttons are located on the inside of one of the front doors or both*.

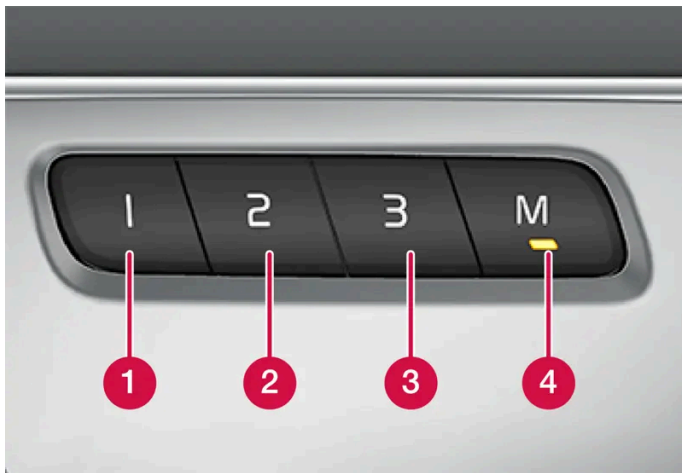

- 1 Memory button.
- 2 Memory button.
- 3 Memory button.
- 4 Button **M** for storing settings.

Storing a position

- 1 Adjust seat, door mirrors and head-up display to the desired position.
 - 2 Press and hold the **M** button depressed. The light indicator in the button illuminates.
 - 3 Press and hold the 1, 2 or 3 button within three seconds.
- When the position has been stored in the selected memory button, an acoustic signal can be heard and the light indicator in the **M** button extinguishes.

If none of the memory buttons is depressed within three seconds then the M button extinguishes and no storing takes place.

The seat, the door mirrors or the head-up-display must be readjusted before a new memory can be set.

 **Note**

All driver profiles need to be set in **Protect Profile** mode in order for the stored positions to work.

* Option/accessory.

7.1.3. Front seats

The seat has a range of adjustment options to increase your comfort.

7.1.4. Power* front seat

The car's front seats have a range of setting options in order to enhance comfort. The power seat can be moved forwards/backwards and upwards/downwards. The front edge of the seat cushion can be raised/lowered as well as adjusted in length* and the backrest inclination can be changed. The lumbar support* can be adjusted upward/downward/forward/backward. ^[1]

Seat adjustment can take place when the car is running and within a certain time after unlocking the door without the car running. Adjustment can also take place within a certain time after the car has been switched off.

 **Important**

The power seats have overload protection that is triggered if any seat is blocked by an object. If this happens, remove the object and then move the seat again.

* Option/accessory.

^[1] Applicable to four-way lumbar support*. Two-way lumbar support* is adjusted forwards/backwards.

7.1.5. Adjusting the power* front seat

Set the preferred seat position using the control on the front seat's seating section. To set the various comfort functions, turn the multifunction control^[1] up/down.

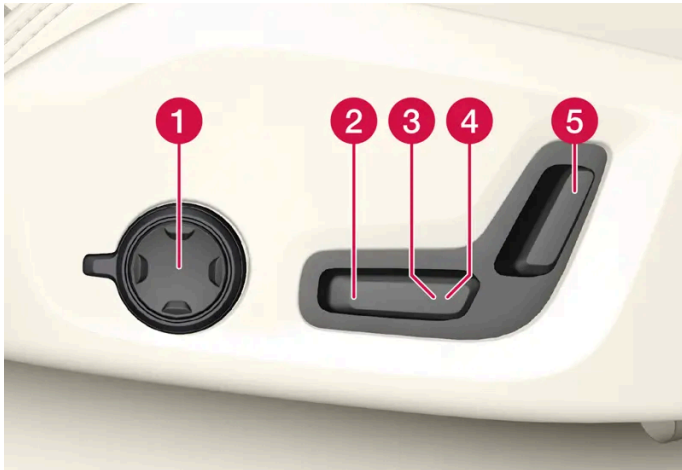

The illustration shows the controls from a car with four-way lumbar support*. Cars with two-way lumbar support* do not have the rotatable multifunction control.

- 1 In cars with four-way lumbar support*, turn the multifunction control^[1] up/down to set the different comfort functions. In cars with two-way lumbar support*, use the round button to adjust the lumbar support forward/backward.
- 2 Raise/lower the seat cushion front edge by adjusting the control up/down.
- 3 Raise/lower the seat by means of adjusting the control up/down.
- 4 Move the seat forward/backward by adjusting the control forward/backward.
- 5 Change the backrest inclination by adjusting the control forward/backward.

Only one movement (forward/back/up/down) can be made at a time.

The backrests of the front seats cannot be lowered fully forward.

* Option/accessory.

^[1] Not available in cars with two-way lumbar support*.

7.1.6. Adjusting the passenger seat from the driver's seat*

The front passenger seat can be adjusted from the driver's seat.

Activating the function

The function is activated via the function view in the centre display:

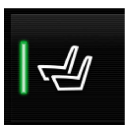

Press the **Adjust Passenger Seat** button to activate.

Adjust passenger seat

The content of this manual represents the status of the user manual at the time of printing and may not be completely valid in future instances. For more information, refer to the first page for the complete disclaimer note.

From activation of the function, the driver must adjust the passenger seat within 10 seconds. If no adjustment is made within this time the function is deactivated.

The driver adjusts the passenger seat using the controls on the driver's seat:



- 1 Move the passenger seat forward/backward by adjusting the control forward/backward.
- 2 Change the passenger seat's backrest inclination by adjusting the control forward/backward.

* Option/accessory.

7.1.7. Manual front seat

The car's front seats have a range of setting options in order to enhance comfort.



- 1 Raise/lower the front edge of the seat cushion* by pumping up/down.^[1]
- 2 Change the length* of the seat cushion by pulling the lever up and moving the seat cushion forward/backward by hand.
- 3 Adjust the seat forward/backward by lifting the handle and adjusting the distance to the steering wheel and pedals. Check that the seat is locked after the position has been adjusted.
- 4 Change the lumbar support* by pressing the button upward/downward/forward/back.^[2]

The content of this manual represents the status of the user manual at the time of printing and may not be completely valid in future instances. For more information, refer to the first page for the complete disclaimer note.

5 Raise/lower the seat by means of adjusting the control up/down.

6 Change the backrest inclination by turning the control knob.

 **Warning**

Adjust the position of the driver's seat before setting off, never while driving. Make sure that the seat is in locked position in order to avoid personal injury in the event of heavy braking or an accident.

* Option/accessory.

[1] Only applies to the driver's seat.

[2] Applicable to four-way lumbar support*. Two-way lumbar support* is adjusted forwards/backwards.

7.1.8. Multifunction* front seat function overview

Enhance the seating comfort using the multi-function control*.

* Option/accessory.

7.1.9. Massage settings* in the front seat

Both the multi-function control on the side of the seat and the centre display can be used in order to change the settings. The range of settings is shown in the centre display.



Multi-function control, located on the side of the seat's seating section.

Settings for massage

The following setting options are available for massage:

The content of this manual represents the status of the user manual at the time of printing and may not be completely valid in future instances. For more information, refer to the first page for the complete disclaimer note.

- **On/Off:** Select **On/Off** in order to switch on/off the massage function.
- **Programs 1-5:** There are 5 preset massage programs. Choose between **Swell, Tread, Advanced, Lumbar** and **Shoulder**.
- **Intensity:** Select between **Low, Normal** and **High**.
- **Speed:** Select between **Slow, Normal** and **Fast**.

Restarting massage

The massage function is deactivated automatically after 20 minutes. Reactivation of the function is performed manually.

- 1 Tap on **Restart**, which is shown in the centre display, to restart the selected massage program.
 - The massage program restarts. If no action is taken, the message remains shown in the top view.

* Option/accessory.

7.1.10. Adjusting massage settings* in the front seat

Both the multi-function control on the seat and the centre display can be used in order to change the settings. The range of settings is shown in the centre display.

Adjusting massage settings in the front seat

The front seat has massage in the backrest. The massage is performed by air cushions that can massage with different settings.

The massage function can only be activated when the car's engine is running.

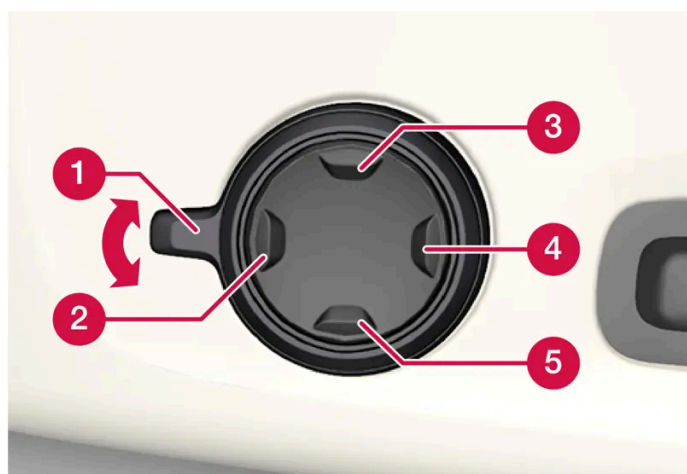

- 1 Activate the multi-function control by turning the control **1** upwards/downwards. The seat settings view will be shown in the centre display.

- 2 Select **Massage** in the seat settings view.
- 3 To choose between the different massage functions, select either directly in the centre display or by moving the cursor up/down using the multi-function control's upper **3** /lower **5** button. Change the setting in the selected function directly in the centre display, by pressing the arrows, or by using the multi-function control's front **2** /rear **4** button.

* Option/accessory.

7.1.11. Adjusting the side support* in the front seat

Increase comfort in the front seat by adjusting the sides of the backrest.

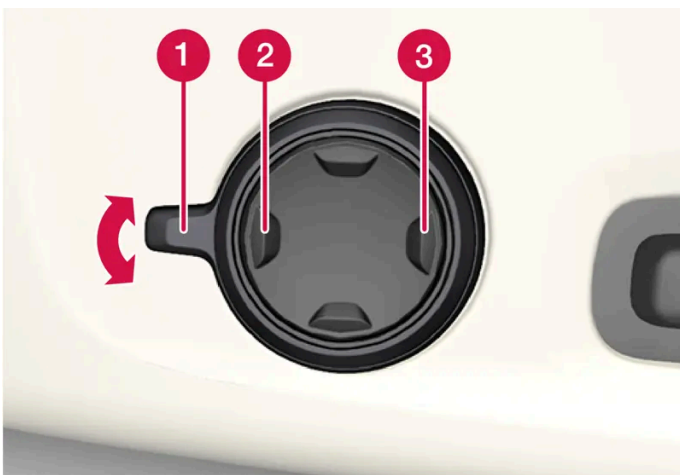

Multi-function button, located on the side of the seat base section.

The sides of the backrest can be adjusted to provide side support. Both the multi-function control on the seat and the centre display can be used in order to change the settings. The range of settings is shown in the centre display.

To adjust the side support:

- 1 Activate the multi-function control by turning the it up/down **1**. The seat settings view will be shown in the centre display.
- 2 Select **Side bolsters** in the seat settings view.
 - Press the front section of the four-way button to increase side support **2**.
 - Press the rear section of the four-way button to decrease side support **3**.

* Option/accessory.

7.1.12. Adjusting* the length of the seat cushion in the front seat

Depending on equipment level selected, seat cushion length is adjusted either using the multifunction control* on the side of the seat's seat cushion, or manually using a control on the front of the seat cushion.

Adjusting the length of the seat cushion using the multifunction control

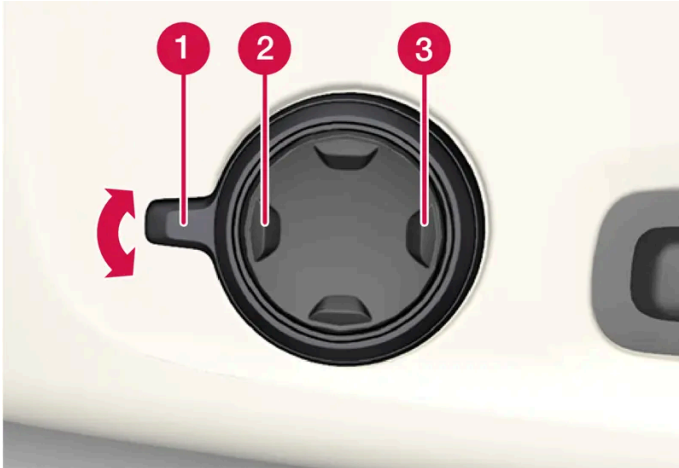

Multifunction control, located on the side of the seat cushion.

- 1 Activate the multi-function control by turning the control **1** upwards/downwards. The seat settings view will be shown in the centre display.
- 2 Select **Cushion extension** in the seat settings view.
 - Press the front section of the four-way button **2** to extend the seat cushion.
 - Press the rear section of the four-way button **3** to retract the seat cushion.

Adjusting the length of the seat cushion manually



Control for seat cushion adjustment.

- 1 Grip the handle **1** on the front of the seat and pull upwards.
- 2 Adjust the length of the seat cushion.
- 3 Release the handle and make sure that the seat cushion has reached the correct position.

* Option/accessory.

7.1.13. Adjusting the lumbar support* in the front seat

The lumbar support is adjusted using a control on the side of the seat cushion.



Multifunction control in cars with four-way lumbar support*.



Control in cars with two-way lumbar support*.

The lumbar support is adjusted using the multifunction control in cars with four-way lumbar support*, or using the round button in cars with two-way lumbar support*. The control is located on the side of the seat's seating section. Depending on the equipment level selected, the lumbar support can be adjusted forward/back and up/down (four-way lumbar support) or forward/back (two-way lumbar support).

Adjust the lumbar support in the car using the four-way lumbar support

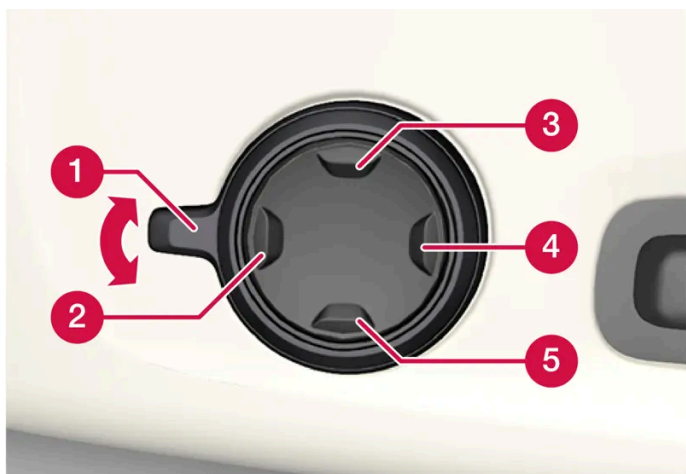

- 1 Activate the multi-function control by turning the control **1** upwards/downwards. The seat settings view will be shown in the centre display.
- 2 Select **Lumbar** in the seat settings view.
 - Press the round button up **3**/down **5** to move the lumbar support upwards/downwards.
 - Press the front section **2** of the button to increase lumbar support.
 - Press the rear section **4** of the button to decrease lumbar support.

Adjust the lumbar support in the car using the two-way lumbar support

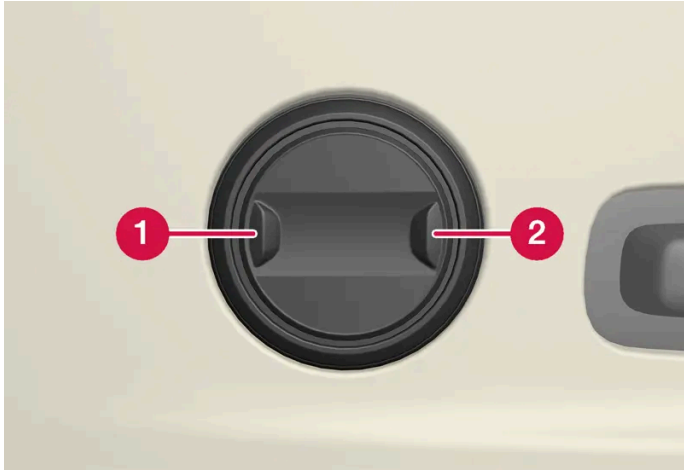

- 1 Press the front section **1** of the round button to increase lumbar support.
- 2 Press the rear section **2** of the round button to decrease lumbar support.

* Option/accessory.

7.2. Rear seat

7.2.1. Climate controls for rear seat

7.2.1.1. Activating and deactivating heated rear seat *

The seats can be heated in order to increase comfort for the passengers when it is cold.

Activating and deactivating the heated rear seat from the front seat



Open climate view in the centre display by pressing the symbol in the middle of the climate row.

2 Select the **Rear climate** tab.



Repeatedly press the button for heated seats in order to change between the four levels: **Off, High, Medium and Low**.

➤ The level changes and the button shows the set level.

Activating and deactivating the heated rear seat from the rear seat



Seat heating indication and controls on the climate panel at the rear of the tunnel console.

Press repeatedly on the left or right-hand side's buttons for heated seats on the tunnel console's climate panel to switch between the four levels: **Off, High, Medium and Low**.

➤ The level changes and the screen in the climate panel shows the set level.

Warning

Heated seats must not be used by people who find it difficult to perceive an increase in temperature due to a lack of sensation or who otherwise have problems operating the controls for the heated seats.

* Option/accessory.

7.2.1.2. Regulating fan level for rear seat

The fan can be set to several different automatically controlled fan speeds for the rear seat.

Regulating the fan level for the rear seat from the front seat



Open climate view in the centre display by pressing the symbol in the middle of the climate row.

2 Select the **Rear climate** tab.

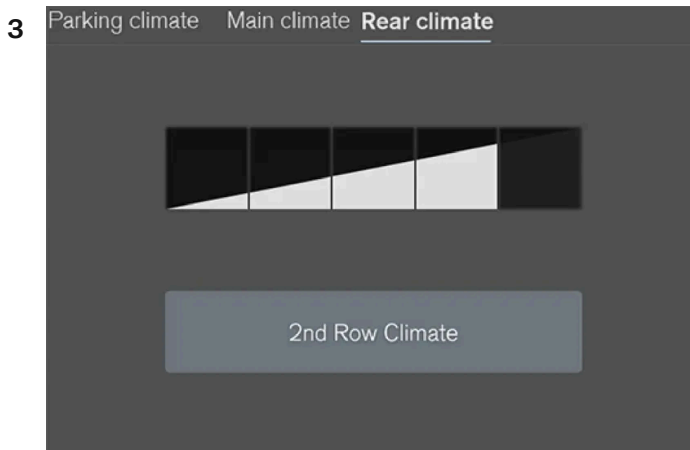

The fan control buttons in the tab **Rear climate** in the climate view.

Tap on the desired fan level, **1-5**.

The fan level for the second and third seat row* can be switched off by tapping on **2nd row climate**.

Third seat row fan level follows the level for the second seat row, but can be deactivated separately by tapping on **3rd row climate**.

➤ Fan level is changed and the buttons for the selected level illuminate.

Regulating the fan level for the rear seat from the rear seat

1 Press the unlocking button on the tunnel console climate panel to access the controls.



Fan controls on the climate panel at the rear of the tunnel console.

Tap on the desired fan level, 1-5.

➤ Fan level is changed and the buttons for the selected level illuminate.

i Note

The fan level for the rear seat cannot be set if the fan level for the front seat is in position **Off**.

The fan level for the rear seat is limited, depending on the fan level mode for the front seat, in order to reduce the noise level.

The rear seat fan speed can only be switched off from the climate view in the centre display.

i Note

The climate control system automatically adjusts the air flow within the selected fan level based on requirements. This means that the fan speed may change even though the fan level is the same.

* Option/accessory.

7.2.1.3. Regulating temperature for rear seat

The temperature can be set to the desired number of degrees for the rear seat's climate zones.

Regulating temperature for rear seat from front seat



Open climate view in the centre display by pressing the symbol in the middle of the climate row.

2 Select the **Rear climate** tab.

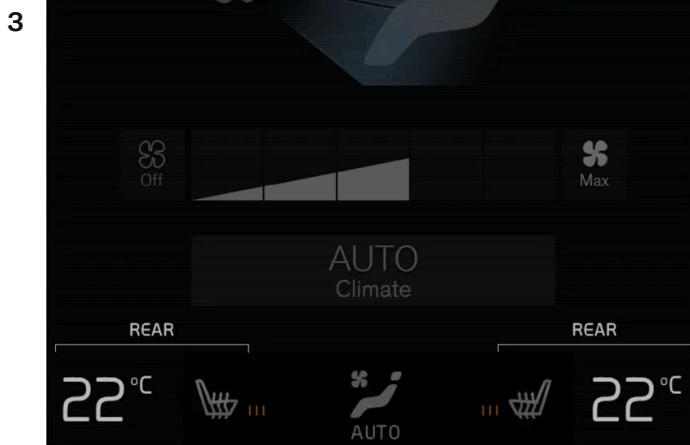

Temperature buttons in the **Rear climate** tab in the climate view.

Press the left or right-hand side temperature button to open the control.

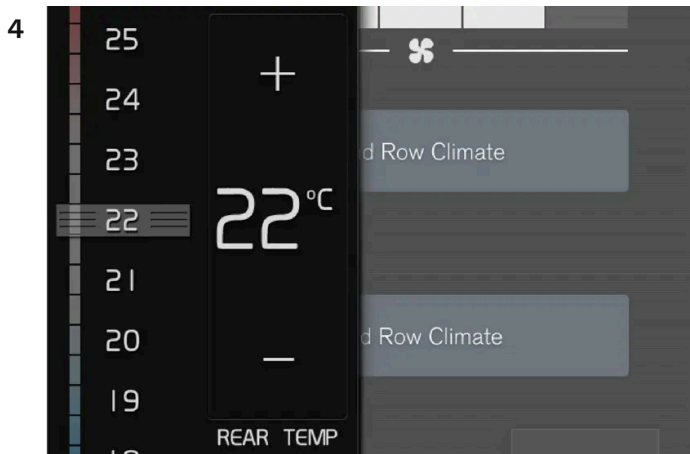

Temperature control.

Regulate the temperature by means of the following:

- drag the control to the desired temperature
- press +/- to raise/lower the temperature gradually.

➤ The temperature changes and the button shows the set temperature.

Regulating temperature for rear seat from rear seat

1 Press the unlocking button on the tunnel console climate panel to access the controls.



Temperature control on the climate panel at the rear of the tunnel console.

Press the left or right-hand side </> buttons on the tunnel console's climate panel in order to lower/raise the temperature gradually.

> The temperature changes and the screen in the climate panel shows the set temperature.

Note

Heating or cooling cannot be hastened by selecting a higher or lower temperature than the actual desired temperature.

7.2.1.4. Activating and deactivating climate for the third row of seats*

The third seat row has separate air conditioning that cools and dehumidifies incoming air when necessary.



Open climate view in the centre display by pressing the symbol in the middle of the climate row.

2 Select the **Rear** climate tab.

3 Press **3rd row climate**.

> Air conditioning is activated/deactivated and the button illuminates/extinguishes.

Note

The air conditioning for the third seat row is activated automatically if anyone in the third seat row puts on a seatbelt. It is not possible to manually activate the third seat row's air conditioning if the main air conditioning is deactivated or the second seat row's climate control is deactivated.

* Option/accessory.

7.2.2. Rear seat

The car has six or seven seats and two rear seat rows. The second seat row has three seats^[1] that can be folded separately. The third seat row has two folding seats.

^[1] In a six-seater car, there is no centre seat on the second row of seats.

7.2.3. Adjusting the seat longitudinally in the second seat row*

In cars with 6 and 7 seats*, the seats in the second seat row can be adjusted forward or back individually in order to adapt the legroom for the second and third row passengers.

Seat adjustment in a 7-seat car



- 1**  Lift the handle that is located under the seat.

- 2  Slide the seat forward or backward to the desired position.
- 3 Release the handle and slide the seat until the catch engages.



Check that the seat is locked after the position has been adjusted.

 **Warning**

- Adjust the seat and fix it before driving away. Take care when adjusting the seat. Uncontrolled or careless adjustment can lead to trapping injuries.
- When loading long objects, they must always be strapped in securely to avoid injury and damage during sudden braking.
- Always switch off the car and apply the parking brake when loading and unloading the car.
- For cars with automatic gearbox, set the gear selector in P to prevent it from being moved by mistake.

Seat adjustment in a 6-seat car^[1]



- 1  Lift the handle that is located under the seat.
- 2  Slide the seat forward or backward to the desired position.
- 3 Release the handle and slide the seat until the catch engages.

Check that the seat is locked after the position has been adjusted.

* Option/accessory.

[1] Cars with six seats are only available in certain markets.

7.2.4. Getting in/out of the third* seat row

The second row of seats can be adjusted in order to facilitate access to and from the third row of seats*.



The illustration is generic.

To lower the backrest:

- 1 Pull upward/forward on the handle located at the top of the outer seats in the second seat row.
- 2 Fold the backrest forward and slide the whole seat forward.

To raise the seat to the upright position:

- 1 Slide the seat backwards until it reaches the stop. The backrest must fall easily back into the correct position.

i Note

If the backrest in the centre seat row cannot be locked on its return after entry/exit, it may need to be moved forward again and then back with slightly more force.

 **Warning**

Check that the backrests and head restraints in the rear seat are locked properly after being folded up.

The head restraints of the outer seats must always be raised when there are passengers on any of the rear seats.

* Option/accessory.

7.2.5. Adjusting the head restraints in the second seat row

Adjust the centre seat head restraint according to passenger height.^[1] Fold the head restraints* for the outer seats in order to improve visibility backwards.

Adjusting the head restraint, centre seat

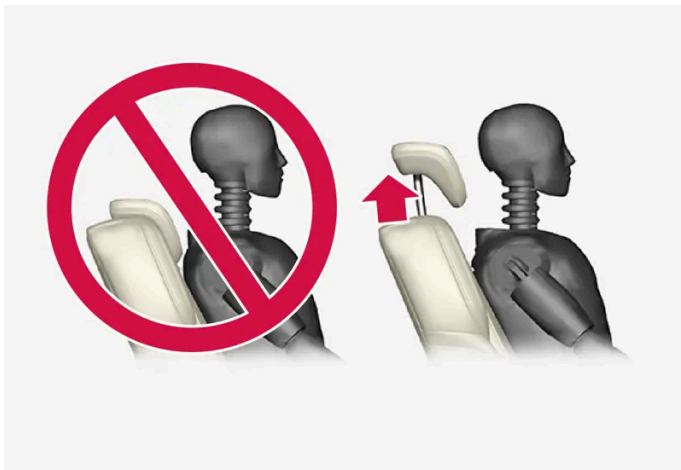

The centre seat's head restraint must be adjusted according to the passenger's height so that, if possible, the whole of the back of the head is covered. Slide it up manually as required.

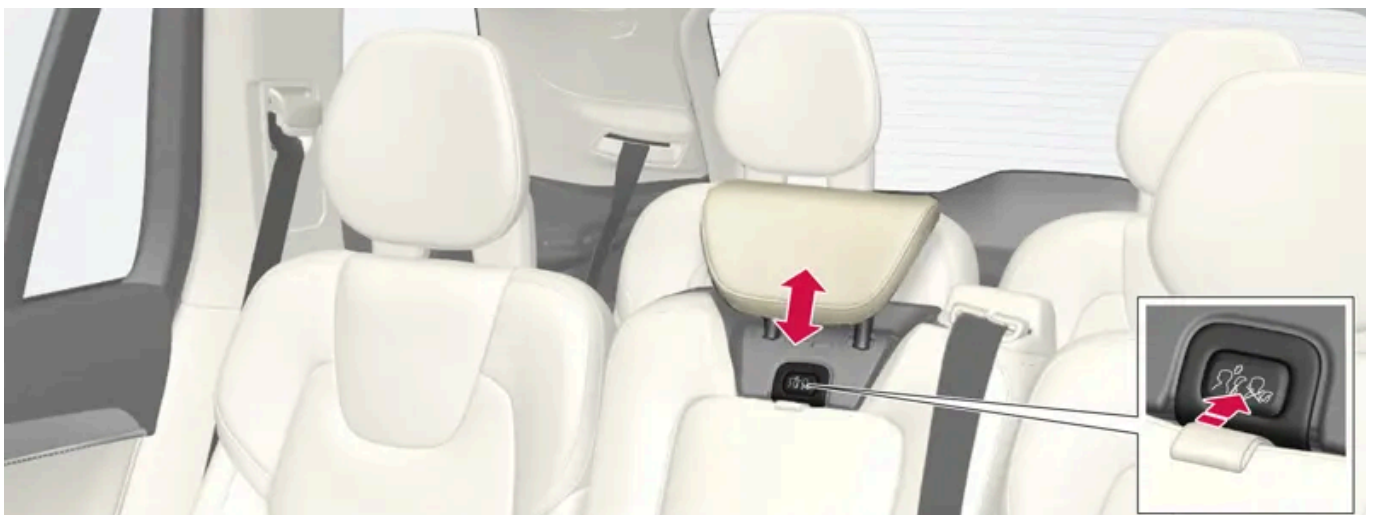

To lower the head restraint, the button (located in the centre between the backrest and head restraint, see illustration) must be pressed in while the head restraint is pressed down carefully.

 **Warning**

The centre seat head restraint must be in its lowest position when the centre seat is not used. When the centre seat is used, the head restraint must be correctly adjusted to the height of the passenger so that it covers the whole of the back of the head if possible.

Electrical lowering of the rear seat's outer head restraints *



The outer head restraints can be retracted via the centre display's function view. You can lower the head restraints in ignition position 0.



Press the **Headrest Fold** button to activate/deactivate lowering.

Move the head restraint back manually until a click is heard.

 **Warning**

Do not lower the outer head restraints if there are passengers in any of the outer rear seats.

 **Warning**

The head restraint must be in locked position after being folded up.

 **Warning**

The head restraints on the outer seats in the second seat row must always be raised when the third seat row* is occupied by passengers.

[1] Cars with six seats do not have a centre seat.

* Option/accessory.

7.2.6. Lowering backrests in the second seat row

The backrests can be lowered forward individually.

Warning

- Adjust the seat and fix it before driving away. Take care when adjusting the seat. Uncontrolled or careless adjustment can lead to trapping injuries.
- When loading long objects, they must always be strapped in securely to avoid injury and damage during sudden braking.
- Always switch off the engine and apply the parking brake when loading and unloading the car.
- For cars with automatic gearbox, set the gear selector in P to prevent it from being moved by mistake.

Important

There must be no objects on the rear seat when the backrest is to be folded down. The seat belts must not be connected either. Otherwise there is a risk of damaging the rear seat upholstery.

Note

The front seats may need to be pushed forwards, and/or the backrests adjusted upwards, in order that the rear backrests can be fully folded forward.

The rear seats may also need to be moved backwards.

The seats must be in raised position when the second seat row is lowered, they should not be lowered when they are tilted forward for entry/exit to/from the third seat row.

Centre seat^[1]



To lower the backrest:

- 1 Lower the head restraint manually.
- 2 Pull the strap located on the centre seat's right-hand side.
- 3 Lower the backrest forward until it locks into position. The seat cushion folds down/forward when the backrest is lowered in order to create a flat surface.

To raise the backrest to the upright position:

- 1 Pull the strap.
- 2 Raise the backrest and release the strap. Slide the backrest until the catch engages.
- 3 If necessary, raise the head restraint.

Outer seats ^[2]

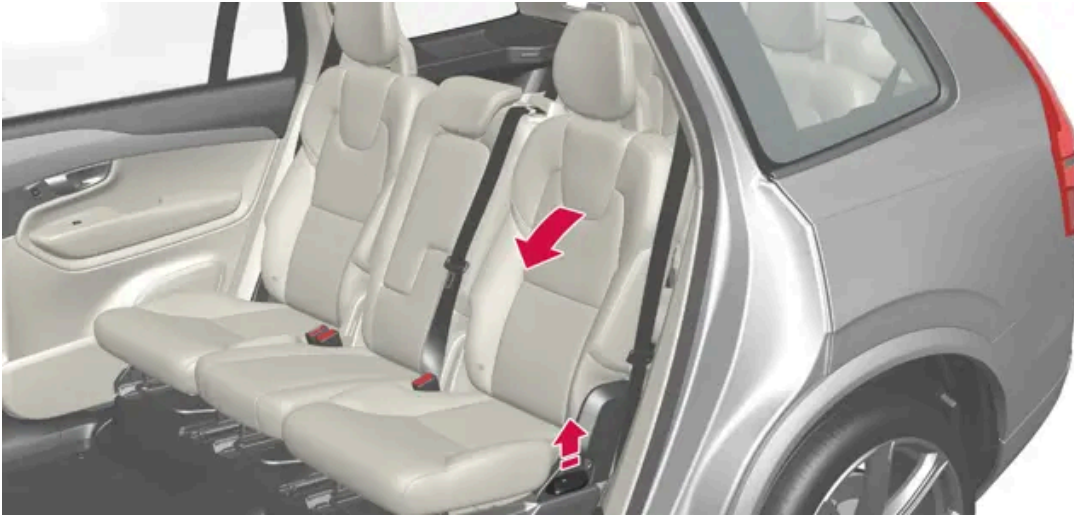

To lower the backrest:

Note

When lowering the second seat row, always start from the seat's normal position.

Do not use lowering lever for the seat when the seat is in entry/exit position for the third seat row.

- 1 Pull the handle on the side of the seat upwards and hold the handle in the raised position while lowering the backrest.
 - 2 Make sure that the backrest with head restraint does not come into contact with the front seat when lowered. Lower the backrest forward until it locks into position.
- The seat cushion folds down/forward when the backrest is lowered in order to create a flat surface. The head restraint lowers automatically when the rear seat is lowered.

Warning

Make sure the backrests are properly locked after they are lowered.

To raise the backrest to the upright position:

- 1 Pull the handle on the side of the seat upwards and hold the handle in the raised position while raising the backrest.
- 2 Make sure that the backrest with head restraint does not come into contact with the front seat when raised. Raise the backrest and release the handle.
- 3 Push the backrest until the lock engages.
- 4 Raise the head restraint manually.

The content of this manual represents the status of the user manual at the time of printing and may not be completely valid in future instances. For more information, refer to the first page for the complete disclaimer note.

 **Warning**

Check that the backrests and head restraints in the rear seat are locked properly after being folded up.

The head restraints of the outer seats must always be raised when there are passengers on any of the rear seats.

 **Warning**

The head restraints on the outer seats in the second seat row must always be raised when the third seat row* is occupied by passengers.

[1] Cars with six seats do not have a centre seat.

[2] The illustration shows a car with seven seats.

* Option/accessory.

7.2.7. Adjusting the backrest inclination in the second seat row

Backrest inclination can be adjusted individually for each seat in the second seat row.

Centre seat [1]



- 1 Pull the strap located on the centre seat's right-hand side.
- 2 Adjust the backrest inclination forward/backward by reducing/increasing the load against the backrest.

- 3 Release the strap to lock the backrest position and slide the backrest until the catch engages.

Check that the seat is locked after the position has been adjusted.

Outer seats



- 1 Pull the handle on the side of the seat upwards.
- 2 Adjust the backrest inclination forward/backward by reducing/increasing the load against the backrest.
- 3 Release the handle to lock the backrest position and slide the backrest until the catch engages.

Check that the seat is locked after the position has been adjusted.

Warning

- Adjust the seat and fix it before driving away. Take care when adjusting the seat. Uncontrolled or careless adjustment can lead to trapping injuries.
- When loading long objects, they must always be strapped in securely to avoid injury and damage during sudden braking.
- Always switch off the car and apply the parking brake when loading and unloading the car.
- For cars with automatic gearbox, set the gear selector in P to prevent it from being moved by mistake.

^[1] Cars with six seats do not have a centre seat.

7.2.8. Lowering backrests in the third seat row*

The third seat row has two individual seats. These can be lowered forward individually.

! Important

To be able to lower the third seat row backrests, it may be necessary to change the position and angle of the seats in the second seat row.



- 1 Pull upward/forward on the handle that is located on the top of the backrest.
- 2 Make sure that the backrest with head restraint does not come into contact with the seat in front when lowered. Fold the backrest forward.
 - The seat cushion folds down/forward when the backrest is lowered in order to create a flat surface. The head restraint lowers automatically when the rear seat is lowered.

To raise the seat, raise the backrest manually until it locks. The head restraint is raised manually.

! Warning

Check that the backrests and head restraints in the rear seat are locked properly after being folded up.

The head restraints of the outer seats must always be raised when there are passengers on any of the rear seats.

* Option/accessory.

7.3. Steering wheel

7.3.1. Speed-dependent steering force

Speed related power steering causes the steering wheel force to increase with the speed of the car so as to be able to give the driver enhanced sensitivity. On motorways the steering is firmer. When parking and at low speed steering is light and requires less effort.

Reduced power

In rare situations, the power steering may need to work at reduced power, and turning the steering wheel may then seem slightly heavier. This may occur when the power steering becomes too hot and it then needs temporary cooling. It may also occur if the power supply is disrupted.



In the event of reduced power, the message **Power steering Assistance temporarily reduced** is shown, as well as this symbol in the driver display.

While the power steering is working at reduced power, the driver support functions and steering assistance systems are not available.



Warning

If the temperature increases too much, the servo may be forced to switch off completely. In such a situation, the driver display shows the **Power steering failure Stop safely** message, combined with a symbol.

Change the steering force level *

Steering wheel resistance can be adjusted when using INDIVIDUAL drive mode.

- 1 Tap on **Settings** in the centre display's top view.
- 2 Select **My Car** → **Drive Modes** → **Steering Force**.

Steering wheel resistance selection can only be accessed if the car is stationary or is moving at low speed and in a straight line.

* Option/accessory.

7.3.2. Steering wheel controls and horn

The steering wheel houses the horn and controls for e.g. the driver support systems and voice control.



Keypads and paddles* in the steering wheel.

- 1 Controls for driver support systems. ^[1]
- 2 Paddle shifter* for manual gear changing in an automatic gearbox.
- 3 Controls for voice control, head-up display settings, and menu, message and phone handling.

Horn



The horn is located in the centre of the steering wheel.

* Option/accessory.

[1] Speed Limiter, Cruise Control, Adaptive Cruise Control*, Distance Warning* and Pilot Assist.

7.3.3. Adjusting the steering wheel

The steering wheel can be adjusted in different positions.

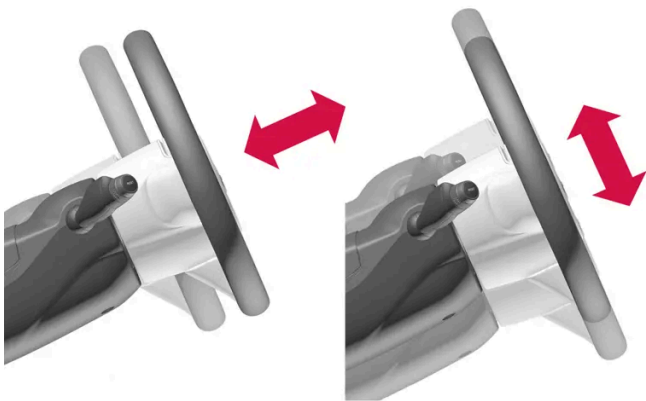

The steering wheel can be adjusted for height and for depth.

 **Warning**

Adjust the steering wheel and fix it before driving away. The steering wheel must never be adjusted while driving.

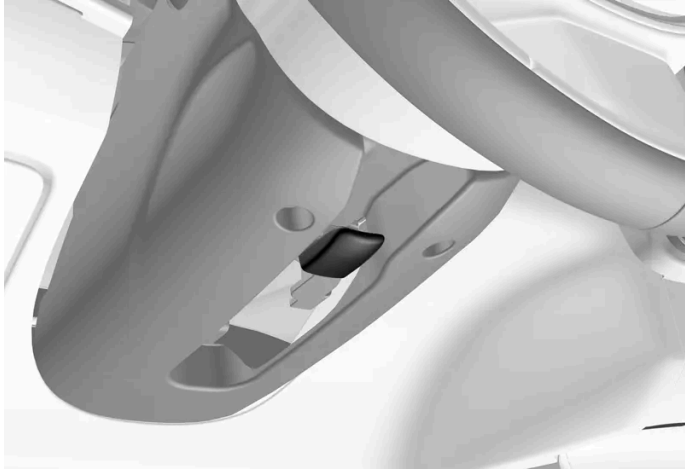

Lever for steering wheel adjustment.

- 1 Push the lever forwards to release the steering wheel.
- 2 Adjust the steering wheel to the position that suits you.
- 3 Pull the lever back to fix the steering wheel in place. If the lever is stiff, press or raise the steering wheel slightly at the same time as you move the lever back.

7.3.4. Steering lock

The steering lock makes it difficult to steer the car if it is stolen, for example. A mechanical noise can be perceived when the steering lock is locked or unlocked.

Activating the steering lock

The steering lock is activated when the car is locked from the outside and the car is switched off. If the car is left unlocked then the steering lock will be activated automatically after a while.

Deactivating the steering lock

The steering lock is deactivated when the car is unlocked from outside. If the car is not locked, the steering wheel lock will be deactivated as long as the remote control key is in the passenger compartment and the car is started.

7.3.5. Activating and deactivating the heated steering wheel*

The steering wheel can be heated in order to increase comfort for the driver when it is cold.

1



Press the driver's side steering wheel and seat button in the climate row of the centre display in order to open the controls for seat and steering wheel.

If the car is not equipped with heated seats or ventilated seats, the button for heated steering wheel is immediately available in the climate row.

2



Repeatedly press the button for heated steering wheel in order to change between the four levels: **Off**, **High**, **Medium** and **Low**.

➤ The level changes and the button shows the set level.

* Option/accessory.

7.3.6. Activating and deactivating automatic start of heated steering wheel*

The steering wheel can be heated in order to increase comfort for the driver when it is cold.

It is possible to set whether automatic start of heated steering wheel should be activated/deactivated when the engine is started. With automatic start activated, heating will start in the event of low ambient temperature.

- 1** Press **Settings** in the top view in the centre display.
- 2** Press **Climate**.
- 3** Select **Auto Steering Wheel Heating Level** to activate/deactivate automatic start of heated steering wheel.
 - An "A" is shown at the button for heated steering wheel in the climate row when automatic starting has been activated.
- 4** Select **Low**, **Medium** or **High** to select level after the function has been activated.

* Option/accessory.

8. Climate

8.1. Climate system controls

8.1.1. Climate controls for passenger compartment

8.1.1.1. Activating auto climate control

With auto climate control activated, multiple climate functions are controlled automatically.



Open climate view in the centre display by pressing the symbol in the middle of the climate row.

2 Give a short or long press on **AUTO Climate**.

- Short press - air recirculation, air conditioning and air distribution are controlled automatically.
- Long press - air recirculation, air conditioning and air distribution are controlled automatically, temperature and fan speed are changed to standard settings: 22 °C (72 °F) and level 3 (level 2 in the rear seat).

➤ Auto-regulation of the climate is activated and the button illuminates.

 **Note**

Temperature and fan speed can be changed without deactivating the automatically-regulated climate control system. The automatically-regulated climate control system is deactivated when the air distribution is changed manually or when maximum defroster is activated.

8.1.1.2. Regulating fan level for rear seat

The fan can be set to several different automatically controlled fan speeds for the rear seat.

Regulating the fan level for the rear seat from the front seat



Open climate view in the centre display by pressing the symbol in the middle of the climate row.

2 Select the **Rear climate** tab.

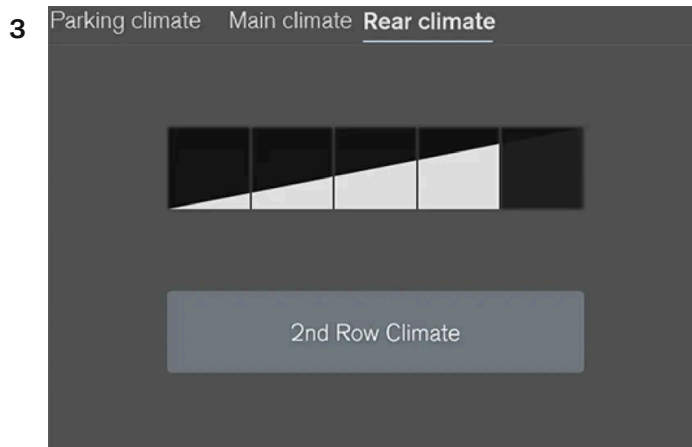

The fan control buttons in the tab **Rear climate** in the climate view.

Tap on the desired fan level, **1-5**.

The fan level for the second and third seat row* can be switched off by tapping on **2nd row climate**.

Third seat row fan level follows the level for the second seat row, but can be deactivated separately by tapping on **3rd row climate**.

➤ Fan level is changed and the buttons for the selected level illuminate.

Regulating the fan level for the rear seat from the rear seat

1 Press the unlocking button on the tunnel console climate panel to access the controls.



The content of this manual represents the status of the user manual at the time of printing and may not be completely valid in future instances. For more information, refer to the first page for the complete disclaimer note.

Fan controls on the climate panel at the rear of the tunnel console.

Tap on the desired fan level, **1-5**.

➤ Fan level is changed and the buttons for the selected level illuminate.

i Note

The fan level for the rear seat cannot be set if the fan level for the front seat is in position **Off**.

The fan level for the rear seat is limited, depending on the fan level mode for the front seat, in order to reduce the noise level.

The rear seat fan speed can only be switched off from the climate view in the centre display.

i Note

The climate control system automatically adjusts the air flow within the selected fan level based on requirements. This means that the fan speed may change even though the fan level is the same.

* Option/accessory.

8.1.1.3. Regulating fan level for front seat

The fan can be set to several different automatically controlled fan speeds for the front seat.



Open climate view in the centre display by pressing the symbol in the middle of the climate row.

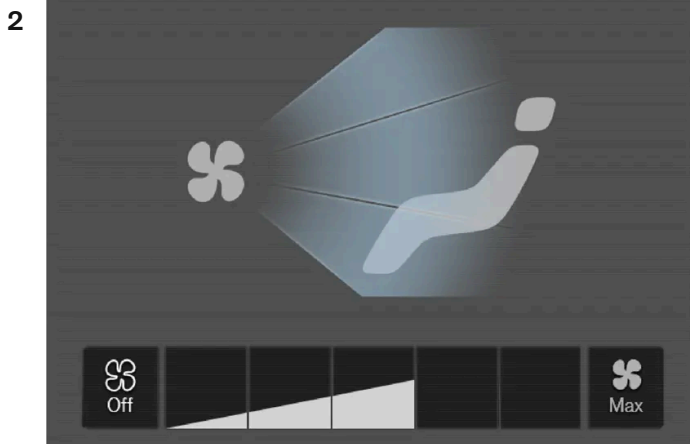

Fan control buttons in the climate view.

Tap on the desired fan level, **Off**, **1-5** or **Max**.

➤ Fan level is changed and the buttons for the selected level illuminate.

! Important

If the fan is fully switched off then the air conditioning is not engaged, which results in a risk of misting on the insides of the windows.

i Note

The climate control system automatically adjusts the air flow within the selected fan level based on requirements. This means that the fan speed may change even though the fan level is the same.

8.1.1.4. Activating and deactivating air conditioning

The air conditioning cools and dehumidifies incoming air as required.

When the air conditioning is activated, the climate control system automatically controls starting and switching off as required.



Open climate view in the centre display by pressing the symbol in the middle of the climate row.



Press **AC**.

➤ Air conditioning is activated/deactivated and the button illuminates/extinguishes.

 **Note**

Close all side windows and the panoramic roof* so that the air conditioning should work as well as possible.

 **Note**

It is not possible to activate the air conditioning when the fan control is in **Off** position.

* Option/accessory.

8.1.1.5. Activating and deactivating air recirculation

Air recirculation shuts out bad air, exhaust gases, etc. from outside the car by the climate control system reusing the air in the passenger compartment.



Open climate view in the centre display by pressing the symbol in the middle of the climate row.

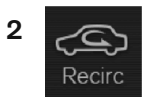

Press **Recirc**.

➤ Air recirculation is activated/deactivated and the button illuminates/extinguishes.

 **Important**

If the air in the car is recirculated for too long then there is a risk of misting on the insides of the windows.

 **Note**

It is not possible to activate air recirculation when max defroster is activated.

8.1.1.6. Activating and deactivating time setting for air recirculation

Air recirculation shuts out bad air, exhaust gases, etc. from outside the car by the climate control system reusing the air in the passenger compartment.

It is possible set whether the air recirculation timer should be activated/deactivated. When the timer is activated, air recirculation is automatically switched off after 20 minutes.

- 1 Press **Settings** in the top view in the centre display.
- 2 Press **Climate**.
- 3 Select **Recirculation Timer** to activate/deactivate the air recirculation timer.

8.1.1.7. Regulating temperature for rear seat

The temperature can be set to the desired number of degrees for the rear seat's climate zones.

Regulating temperature for rear seat from front seat



Open climate view in the centre display by pressing the symbol in the middle of the climate row.

2 Select the **Rear climate** tab.

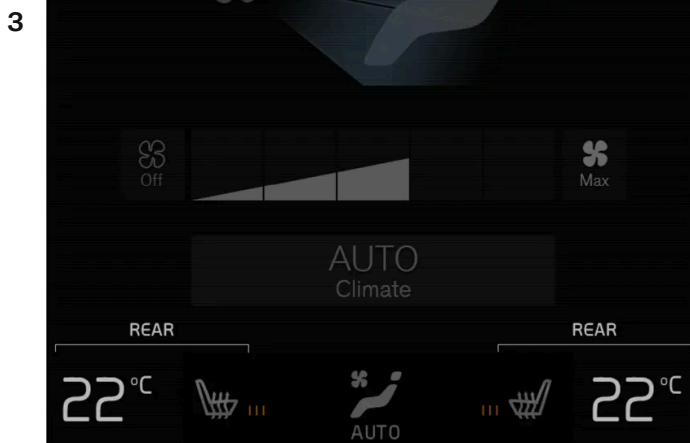

Temperature buttons in the **Rear climate** tab in the climate view.

Press the left or right-hand side temperature button to open the control.

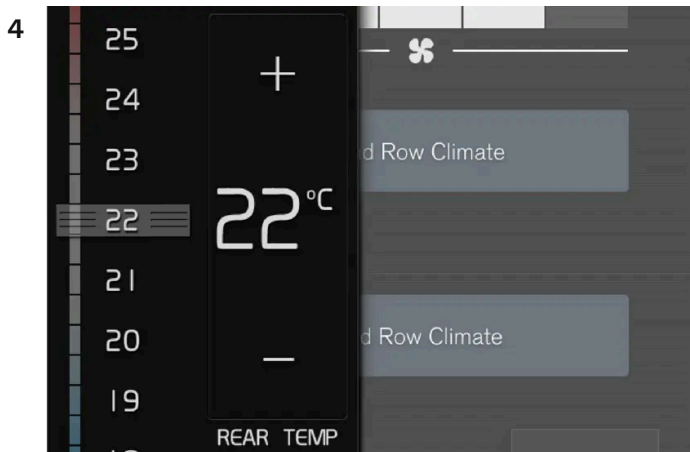

Temperature control.

Regulate the temperature by means of the following:

- drag the control to the desired temperature
- press +/- to raise/lower the temperature gradually.

➤ The temperature changes and the button shows the set temperature.

Regulating temperature for rear seat from rear seat

1 Press the unlocking button on the tunnel console climate panel to access the controls.



Temperature control on the climate panel at the rear of the tunnel console.

Press the left or right-hand side </> buttons on the tunnel console's climate panel in order to lower/raise the temperature gradually.

➤ The temperature changes and the screen in the climate panel shows the set temperature.

i Note

Heating or cooling cannot be hastened by selecting a higher or lower temperature than the actual desired temperature.

8.1.1.8. Regulating temperature for front seat

The temperature can be set to the desired number of degrees for the front seat's climate zones.

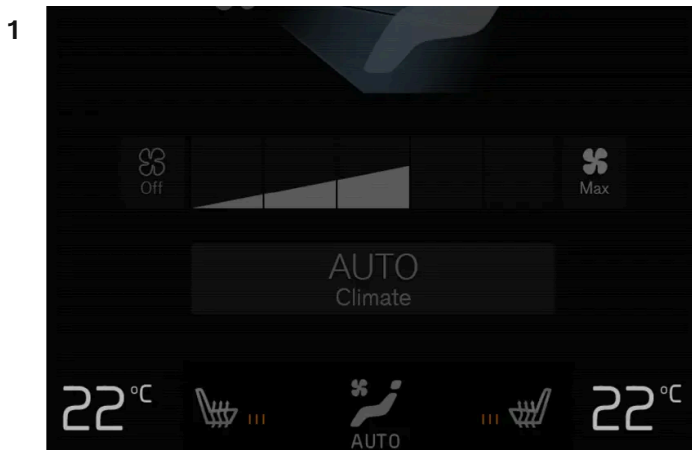

Temperature buttons in the climate row.

Press the left or right-hand side temperature button in the centre display's climate row to open the controls.

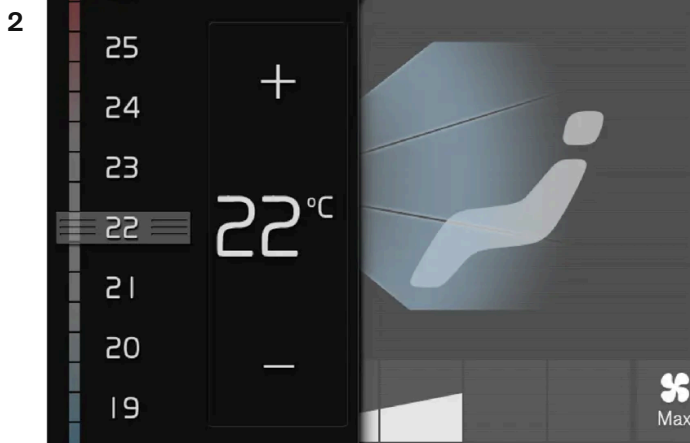

Temperature control.

Regulate the temperature by either of the following:

- drag the control to the desired temperature, or
- press +/- to raise/lower the temperature gradually.

➤ The temperature changes and the button shows the set temperature.

Note

Heating or cooling cannot be hastened by selecting a higher or lower temperature than the actual desired temperature.

8.1.1.9. Synchronising temperature

The temperature in the car's different climate zones can be synchronised with the temperature set on the driver's side.

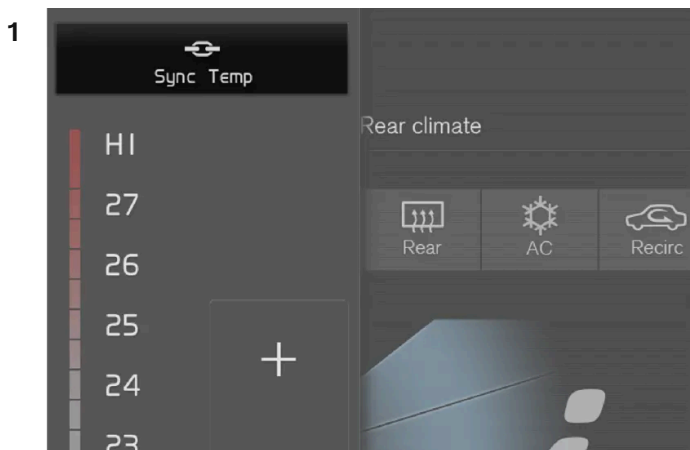

Synchronisation button on the driver's side temperature controls.

Press the driver's side temperature button in the centre display's climate row in order to open the controls.

2 Press **Synchronise temperature**.

- The temperature for all zones in the car is synchronised with the temperature set for the driver's side and the synchronisation symbol is shown adjacent to the temperature button.

The synchronisation is stopped by means of a further press on **Synchronise temperature** or by means of changing the temperature settings for a climate zone other than the driver's.

8.1.1.10. Changing air distribution

The air distribution can be changed manually if required.



Open climate view in the centre display by pressing the symbol in the middle of the climate row.

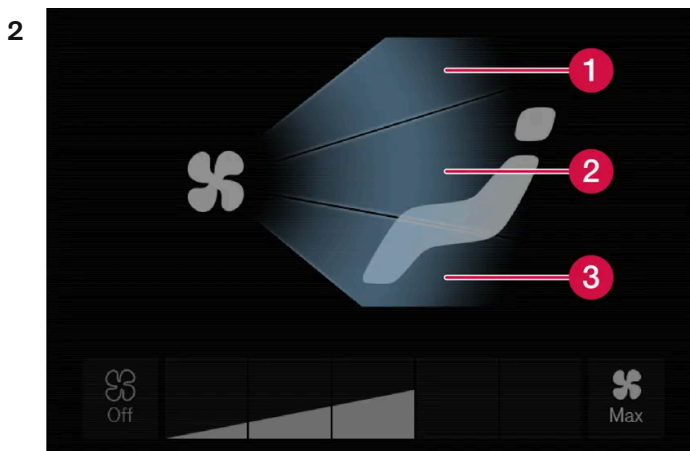

The air distribution buttons in the climate view.

- 1** Air distribution - windscreen defroster vents
- 2** Air distribution - air vents in instrument panel and centre console
- 3** Air distribution - air vents in the floor

Press one or more of the air distribution buttons in order to open/close the corresponding air flow.

- The air distribution is changed and the buttons illuminate/extinguish.

8.1.1.11. Activating and deactivating climate for the third row of seats*

The third seat row has separate air conditioning that cools and dehumidifies incoming air when necessary.



Open climate view in the centre display by pressing the symbol in the middle of the climate row.

2 Select the **Rear climate** tab.

3 Press **3rd row climate**.

➤ Air conditioning is activated/deactivated and the button illuminates/extinguishes.

Note

The air conditioning for the third seat row is activated automatically if anyone in the third seat row puts on a seatbelt.

It is not possible to manually activate the third seat row's air conditioning if the main air conditioning is deactivated or the second seat row's climate control is deactivated.

* Option/accessory.

8.1.2. Climate controls for seat and steering wheel

8.1.2.1. Activating and deactivating the heated steering wheel*

The steering wheel can be heated in order to increase comfort for the driver when it is cold.



Press the driver's side steering wheel and seat button in the climate row of the centre display in order to open the controls for seat and steering wheel.

The content of this manual represents the status of the user manual at the time of printing and may not be completely valid in future instances. For more information, refer to the first page for the complete disclaimer note.

If the car is not equipped with heated seats or ventilated seats, the button for heated steering wheel is immediately available in the climate row.



Repeatedly press the button for heated steering wheel in order to change between the four levels: **Off**, **High**, **Medium** and **Low**.

- The level changes and the button shows the set level.

* Option/accessory.

8.1.2.2. Activating and deactivating automatic start of heated steering wheel *

The steering wheel can be heated in order to increase comfort for the driver when it is cold.

It is possible to set whether automatic start of heated steering wheel should be activated/deactivated when the engine is started. With automatic start activated, heating will start in the event of low ambient temperature.

- 1 Press **Settings** in the top view in the centre display.
- 2 Press **Climate**.
- 3 Select **Auto Steering Wheel Heating Level** to activate/deactivate automatic start of heated steering wheel.
 - An "A" is shown at the button for heated steering wheel in the climate row when automatic starting has been activated.
- 4 Select **Low**, **Medium** or **High** to select level after the function has been activated.

* Option/accessory.

8.1.2.3. Activating and deactivating heated rear seat *

The seats can be heated in order to increase comfort for the passengers when it is cold.

Activating and deactivating the heated rear seat from the front seat



Open climate view in the centre display by pressing the symbol in the middle of the climate row.

2 Select the **Rear climate** tab.

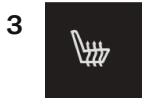

Repeatedly press the button for heated seats in order to change between the four levels: **Off**, **High**, **Medium** and **Low**.

➤ The level changes and the button shows the set level.

Activating and deactivating the heated rear seat from the rear seat



Seat heating indication and controls on the climate panel at the rear of the tunnel console.

Press repeatedly on the left or right-hand side's buttons for heated seats on the tunnel console's climate panel to switch between the four levels: **Off**, **High**, **Medium** and **Low**.

➤ The level changes and the screen in the climate panel shows the set level.

Warning

Heated seats must not be used by people who find it difficult to perceive an increase in temperature due to a lack of sensation or who otherwise have problems operating the controls for the heated seats.

* Option/accessory.

8.1.2.4. Activating and deactivating heated front seat*

The seats can be heated in order to increase comfort for driver and passengers when it is cold.



Press the left or right-hand side's steering wheel and seat button in the climate row in the centre display in order to open the controls for seat and steering wheel.

If the car is not equipped with ventilated seats or heated steering wheel (for the driver's side), the button for heated seats is immediately available in the climate row.



Repeatedly press the button for heated seats in order to change between the four levels: **Off**, **High**, **Medium** and **Low**.

➤ The level changes and the button shows the set level.

Warning

Heated seats must not be used by people who find it difficult to perceive an increase in temperature due to a lack of sensation or who otherwise have problems operating the controls for the heated seats.

* Option/accessory.

8.1.2.5. Activating and deactivating automatic start of heated front seat*

The seats can be heated in order to increase comfort for driver and passengers when it is cold.

It is possible to set whether automatic start of heated seats should be activated/deactivated when the engine is started. With automatic start activated, heating will start in the event of low ambient temperature.

- 1 Press **Settings** in the top view in the centre display.
- 2 Press **Climate**.
- 3 Select **Auto Driver Seat Heating Level** and **Auto Passenger Seat Heating Level** to activate/deactivate automatic start of heated driver's and passenger seat.
 - An "A" is shown at each button for heated front seats in the climate row when automatic starting has been activated.
- 4 Select **Low**, **Medium** or **High** to select level after the function has been activated.

* Option/accessory.

8.1.2.6. Activating and deactivating ventilated front seat*

The seats can be ventilated to provide increased comfort in a hot climate, for example.

The ventilation system consists of fans in the seats and backrests that draw air through the seat upholstery. The cooling effect increases the cooler the passenger compartment air becomes. The system can be activated when the engine is running.



Press the left or right-hand side's steering wheel and seat button in the climate row in the centre display in order to open the controls for seat and steering wheel.

If the car is not equipped with heated seats or heated steering wheel (for the driver's side), the button for ventilated seats is immediately available in the climate row.



Repeatedly press the button for ventilated seats in order to change between the four levels: **Off**, **High**, **Medium** and **Low**.

- The level changes and the button shows the set level.

* Option/accessory.

8.1.3. Climate controls for windows and mirrors

8.1.3.1. Activating and deactivating the heated rear window and door mirrors

The heated rear window and door mirrors are used to quickly remove mist and ice from the windows and mirrors.

Activating and deactivating heated rear window and door mirrors from centre console

In the centre console is a physical button for rapid access to the heated rear window and door mirrors.



Physical button in the centre console.

- 1 Press the button.
 - > Heated rear window and door mirrors are activated/deactivated and the button illuminates/extinguishes.

Activating and deactivating heated rear window and door mirrors from centre display



Open climate view in the centre display by pressing the symbol in the middle of the climate row.

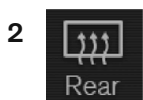

Press **Rear**.

➤ Heated rear window and door mirrors are activated/deactivated and the button illuminates/extinguishes.

8.1.3.2. Activating and deactivating automatic starting of the heated rear window and door mirrors

The heated rear window and door mirrors are used to quickly remove mist and ice from the windows and mirrors.

It is possible to set whether automatic start of heated rear window and door mirrors should be activated/deactivated when the engine is started. With automatic start activated, heating will start when there is a risk of ice or misting on the windscreen/window. The heating switches off automatically when the windscreen/window is sufficiently warm and the ice or misting is gone.

- 1 Press **Settings** in the top view in the centre display.
- 2 Press **Climate**.
- 3 Select **Auto Rear Defroster** to activate/deactivate automatic start of heated rear window and door mirrors.

8.1.3.3. Activating and deactivating the heated windscreen*

A heated windscreen is used to quickly remove mist and ice from the window.

Activating and deactivating heated windscreen from centre console

In the centre console is a physical button for rapid access to the heated windscreen.



Physical button in the centre console.

- 1 Press the button repeatedly in order to switch between the three levels:
 - Activated heated windscreen
 - Activated heated windscreen and max defroster
 - Deactivated.
- Heated windscreen and max defroster are activated/deactivated and the button illuminates/extinguishes.

Activating and deactivating heated windscreen from centre display



Open climate view in the centre display by pressing the symbol in the middle of the climate row.

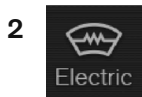

Press **Electric**.

- Heated windscreen is activated/deactivated and the button illuminates/extinguishes.

 **Note**

A triangular area at the end of each side of the windscreen is not electrically heated, where de-icing may take longer.

 **Note**

The heated windscreen may affect the performance of transponders and other communication equipment.

* Option/accessory.

8.1.3.4. Activating and deactivating automatic start of heated windscreen*

A heated windscreen is used to quickly remove mist and ice from the window.

It is possible to set whether automatic start of heated windscreen should be activated/deactivated when the engine is started. With automatic start activated, heating will start when there is a risk of ice or misting on the windscreen/window. The heating switches off automatically when the windscreen/window is sufficiently warm and the ice or misting is gone.

- 1 Press **Settings** in the top view in the centre display.
- 2 Press **Climate**.
- 3 Select **Auto Front Defroster** to activate/deactivate automatic start of heated windscreen.

* Option/accessory.

8.1.3.5. Activating and deactivating max defroster

Max defroster is used to quickly remove mist and ice from windows.

Max defroster deactivates auto-regulation of the climate and air recirculation, activates air conditioning and changes the fan level to **5** and the temperature to **HI**.

Note

Changing the fan level to **5** increases the noise level.

When max defroster is deactivated, the climate control system returns to the previous settings.

Activating and deactivating max defroster from centre console

There is a physical button in the centre console for quick access to max defroster.

With heated windscreen* the max defroster can only be activated individually from the climate view in the centre display.



Physical button in the centre console.

Cars without heated windscreen:

- 1 Press the button.
 - Max defroster is activated/deactivated and the button illuminates/extinguishes.

Cars with heated windscreen:

- 1 Press the button repeatedly in order to switch between the three levels:
 - Activated heated windscreen
 - Activated heated windscreen and max defroster
 - Deactivated.
 - Heated windscreen and max defroster are activated/deactivated and the button illuminates/extinguishes.

Note

Max defroster starts with a certain delay in order to avoid a short increase in fan level if the heated windscreen is deactivated by two quick presses of the button.

Activating and deactivating max defroster from centre display



Open climate view in the centre display by pressing the symbol in the middle of the climate row.



Press **Max**.

➤ Max defroster is activated/deactivated and the button illuminates/extinguishes.

* Option/accessory.

8.1.4. Climate controls

The climate control system's functions are controlled from physical buttons in the centre console, the centre display and the climate controls at the rear of the tunnel console.

Physical buttons in centre console



1 Button for heated windscreen* and max defroster.

2 Button for heated rear window and door mirrors.

Climate row in centre display

The most common climate functions can be regulated from the climate row.

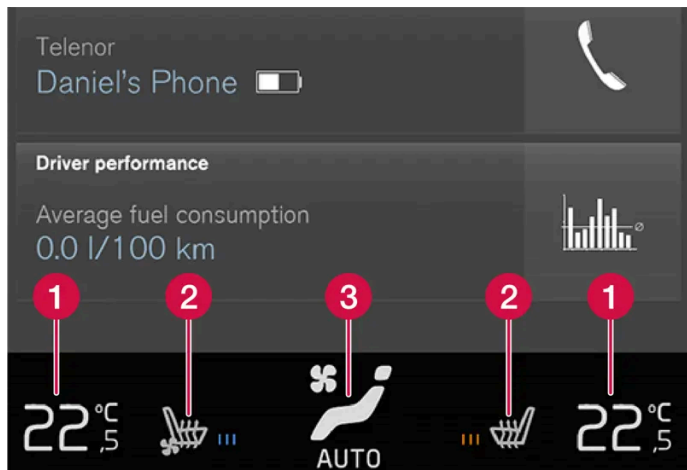

1 Temperature controls for driver and passenger side.

2 Controls for heated* and ventilated* driver and front passenger seat, as well as heated steering wheel*.

3 Button for access to the climate view. The graphic on the button shows activated climate settings.

Climate view in centre display



Open climate view by pressing the symbol in the middle of the climate row.

Depending on equipment level, the climate view can be divided into several tabs. Change between the tabs by swiping left/right or by pressing the respective heading.

Main climate

In addition to the climate row's functions, other main climate functions can also be controlled in the Main climate tab.

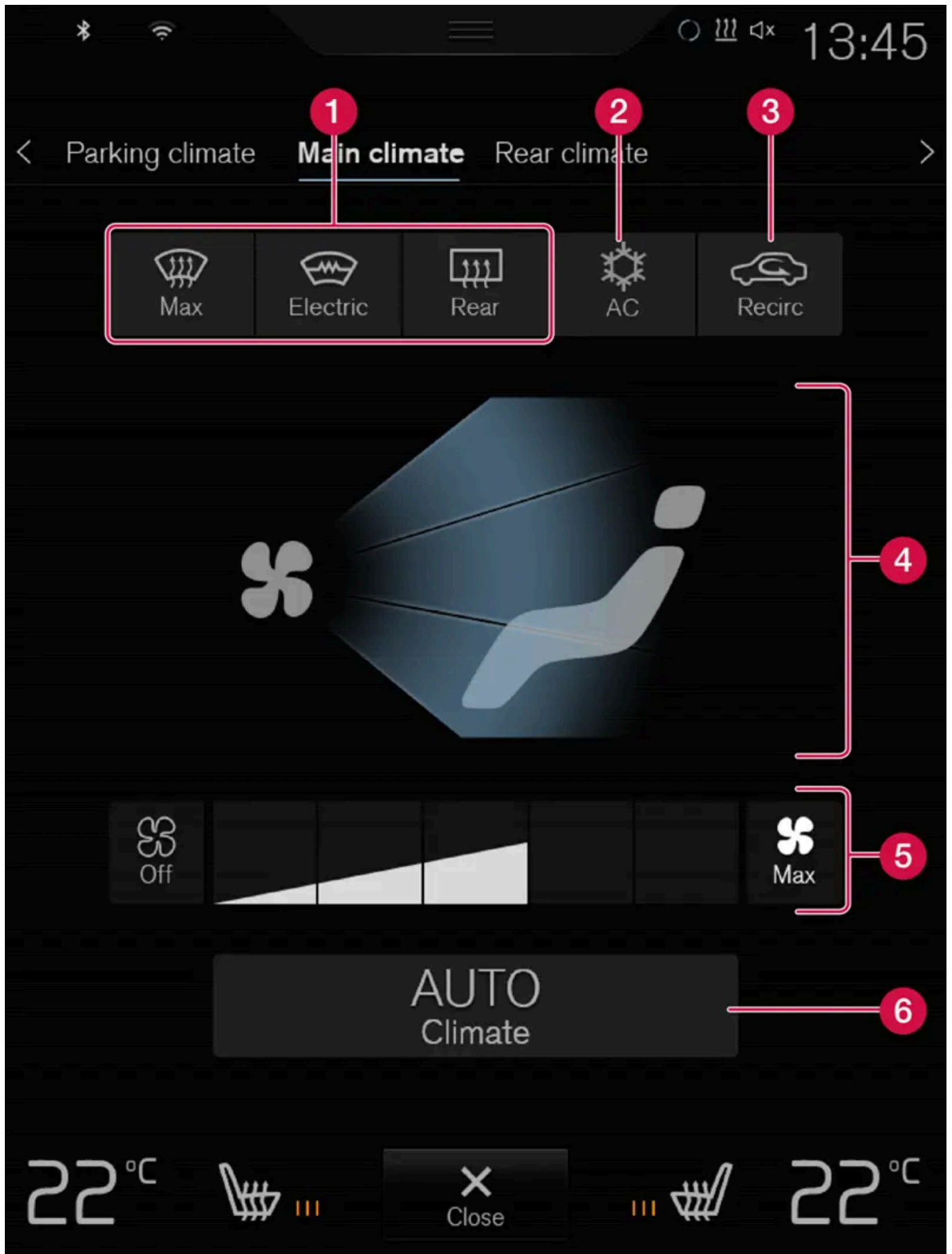

1 Max, Electric, Rear - Controls for defrosting the windows and door mirrors.

- 2 AC - Controls for air conditioning.
- 3 Recirc - Controls for air recirculation.
- 4 Controls for air distribution.
- 5 Fan controls for front seat.
- 6 AUTO - Auto regulating the climate.

Rear climate control

All climate functions for the rear seat can be regulated in the Rear climate tab.

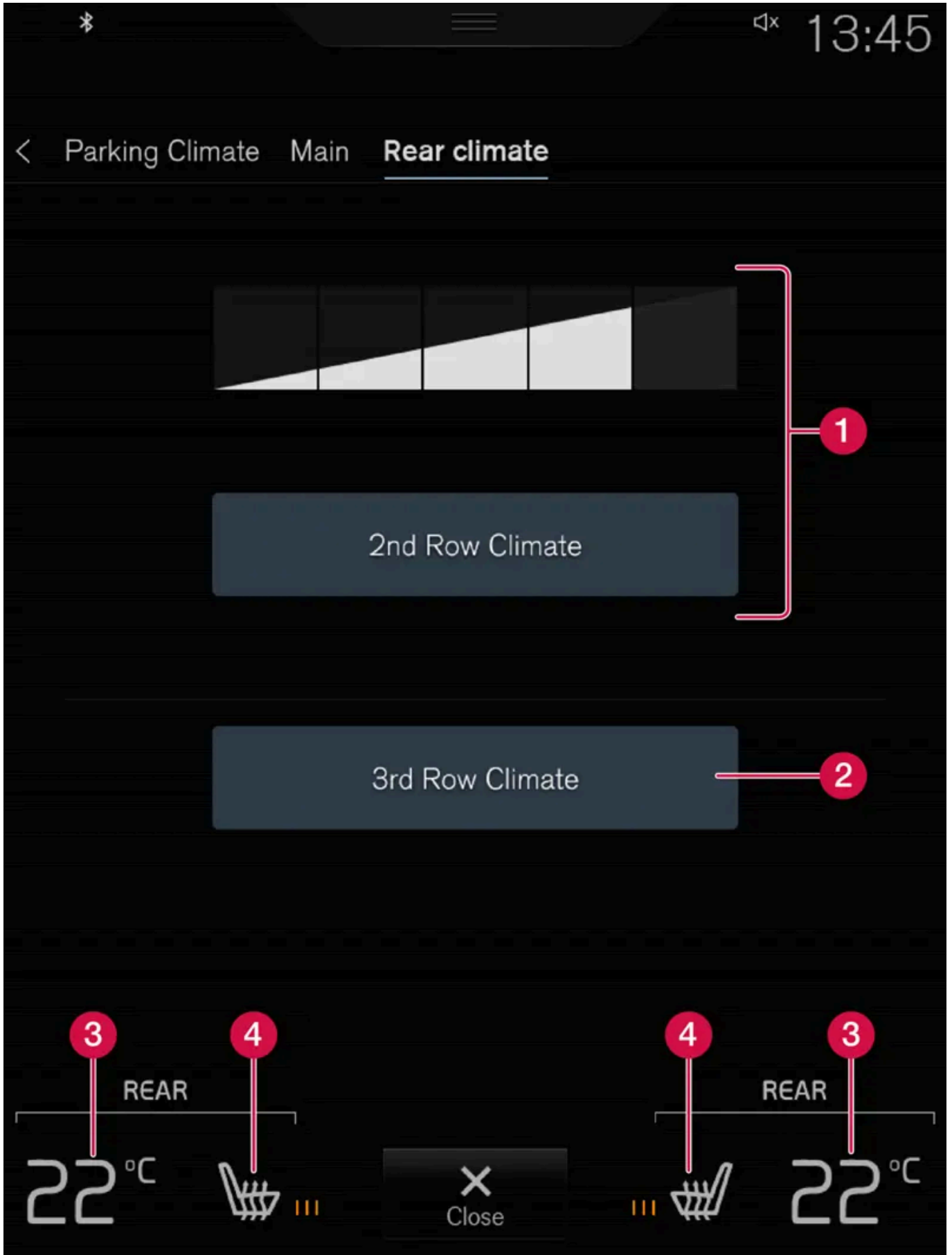

1 2nd row climate - Controls for climate functionality in the rear seat, second seat row. Fan controls for rear seat, second seat row.

The content of this manual represents the status of the user manual at the time of printing and may not be completely valid in future instances. For more information, refer to the first page for the complete disclaimer note.

- ② 3rd row climate - Controls for climate functionality in the rear seat, third seat row*.
- ③ Temperature controls for rear seat.
- ④ Controls for heated rear seat*.

Parking climate

The car's parking climate control can be regulated in the **Parking climate** tab.

Climate controls at rear of tunnel console

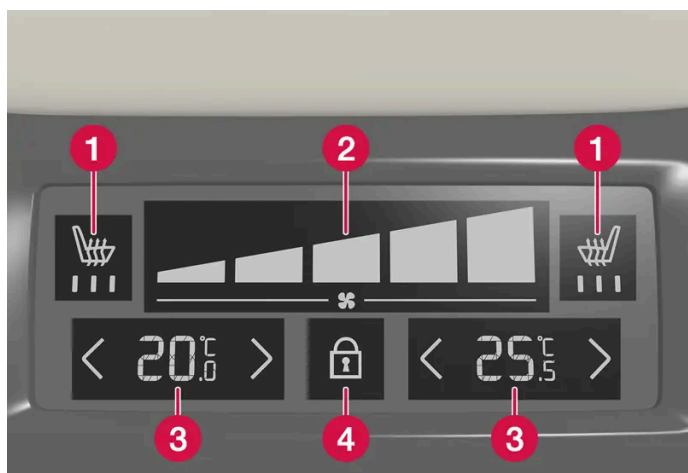

- ① Controls for heated rear seat*.
- ② Fan controls for rear seat.
- ③ Temperature controls for rear seat.
- ④ Locking/unlocking button on the climate panel.

The climate panel has a screen lock to prevent unintentional change of fan speed and temperature. When the screen is locked, only the seat controls* and the unlocking button are shown.

After unlocking, the fan speed and temperature can be changed via the climate panel and all selected climate settings are shown. The screen locks automatically after a period of inactivity.

* Option/accessory.

8.2. Air distribution

8.2.1. Activating and deactivating air recirculation

Air recirculation shuts out bad air, exhaust gases, etc. from outside the car by the climate control system reusing the air in the passenger compartment.



Open climate view in the centre display by pressing the symbol in the middle of the climate row.

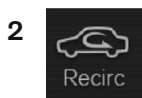

Press **Recirc**.

➤ Air recirculation is activated/deactivated and the button illuminates/extinguishes.

 **Important**

If the air in the car is recirculated for too long then there is a risk of misting on the insides of the windows.

 **Note**

It is not possible to activate air recirculation when max defroster is activated.

8.2.2. Activating and deactivating time setting for air recirculation

Air recirculation shuts out bad air, exhaust gases, etc. from outside the car by the climate control system reusing the air in the passenger compartment.

It is possible set whether the air recirculation timer should be activated/deactivated. When the timer is activated, air recirculation is automatically switched off after 20 minutes.

- 1 Press **Settings** in the top view in the centre display.
- 2 Press **Climate**.
- 3 Select **Recirculation Timer** to activate/deactivate the air recirculation timer.

8.2.3. Activating and deactivating max defroster

Max defroster is used to quickly remove mist and ice from windows.

Max defroster deactivates auto-regulation of the climate and air recirculation, activates air conditioning and changes the fan level to 5 and the temperature to HI.

Note

Changing the fan level to 5 increases the noise level.

When max defroster is deactivated, the climate control system returns to the previous settings.

Activating and deactivating max defroster from centre console

There is a physical button in the centre console for quick access to max defroster.

With heated windscreen* the max defroster can only be activated individually from the climate view in the centre display.



Physical button in the centre console.

Cars without heated windscreen:

- 1 Press the button.
 - Max defroster is activated/deactivated and the button illuminates/extinguishes.

Cars with heated windscreen:

- 1 Press the button repeatedly in order to switch between the three levels:
 - Activated heated windscreen

- Activated heated windscreen and max defroster
- Deactivated.

➤ Heated windscreen and max defroster are activated/deactivated and the button illuminates/extinguishes.

Note

Max defroster starts with a certain delay in order to avoid a short increase in fan level if the heated windscreen is deactivated by two quick presses of the button.

Activating and deactivating max defroster from centre display



Open climate view in the centre display by pressing the symbol in the middle of the climate row.



Press **Max**.

➤ Max defroster is activated/deactivated and the button illuminates/extinguishes.

* Option/accessory.

8.2.4. Air distribution

The climate control system distributes the incoming air via a number of different vents in the passenger compartment.

Automatic and manual air distribution

With auto-regulated climate running the air distribution takes place automatically. If necessary, the air distribution can be controlled manually.

Adjustable air vents

Some of the air vents in the car are adjustable, which means that you can open/close the vent to aim the air flow.

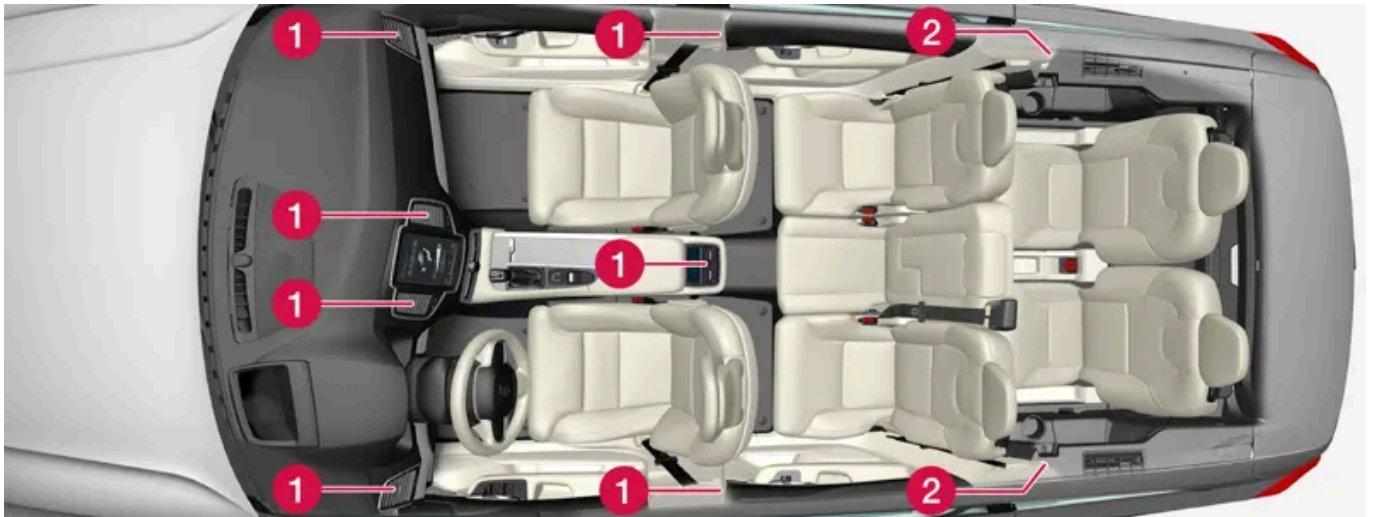

Location of adjustable air vents in the passenger compartment.

- 1 With two seat rows - four on the instrument panel, two at the rear of the tunnel console and one on each of the door pillars between the front and rear doors.
- 2 Addition with a third seat row - one on each of the door pillars behind the rear doors.

8.2.5. Changing air distribution

The air distribution can be changed manually if required.



Open climate view in the centre display by pressing the symbol in the middle of the climate row.

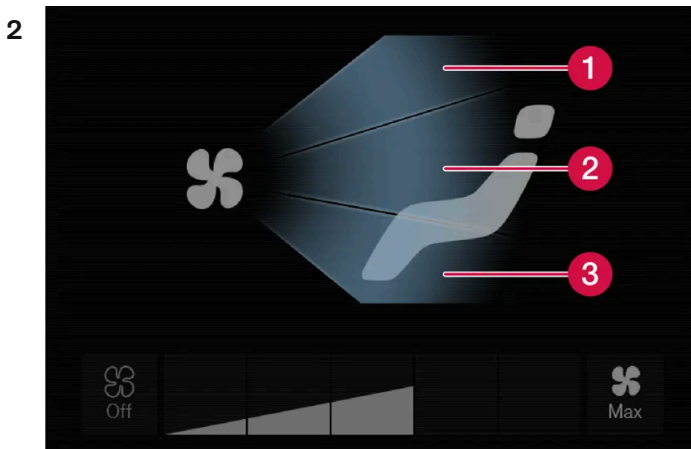

The air distribution buttons in the climate view.

- 1 Air distribution - windscreen defroster vents
- 2 Air distribution - air vents in instrument panel and centre console

The content of this manual represents the status of the user manual at the time of printing and may not be completely valid in future instances. For more information, refer to the first page for the complete disclaimer note.









3 Air distribution - air vents in the floor

Press one or more of the air distribution buttons in order to open/close the corresponding air flow.

- The air distribution is changed and the buttons illuminate/extinguish.

8.2.6. Table of air distribution options

The air distribution can be changed manually if required. The following options are available for setting.

Air distribution	Purpose
 If all air distribution buttons are deselected in manual mode, the climate control system returns to automatically regulated climate control.	
 Main air flow from the defroster vents. Some air flows from other air vents.	Counteracts misting and icing in a cold and humid climate (to achieve this, fan level must not be low).
 Main air flow from the air vents in the instrument panel. Some air flows from other air vents.	Provides efficient cooling in a hot climate.
 Main air flow from the air vents at the floor. Some air flows from other air vents.	Provides heat or cooling to the floor.
 Main air from the defroster vents and air vents in the instrument panel. Some air flows from other air vents.	Provides good comfort in hot and dry climates.
 Main air flow from the defroster vents and air vents at the floor. Some air flows from other air vents.	Provides good comfort and good demisting in a cold or humid climate.
 Main air flow from the air vents in the instrument panel and air vents at the floor. Some air flows from other air vents.	Provides good comfort in sunny weather with cool outdoor temperatures.
 Main air flow from the defroster vents, from the air vents in the instrument panel and air vents at the floor.	Gives balanced comfort in the passenger compartment.

8.2.7. Opening, closing and aiming the air vents

Some air vents in the passenger compartment can be opened, closed and aimed individually.

If the car's outer vents are aimed at the side windows then misting can be eliminated.

If the car's outer vents are aimed inwards then, in a hot climate, a comfortable environment is obtained in the passenger compartment.

Opening and closing the air vents

- 1 Roll the thumbwheel under the air vent in order to open/close the air flow from the vent.

The longer the white lines on the thumbwheel that are visible, the higher the air flow.

Aiming the air vents

- 1 Move the lever in the middle of the air vent horizontally/vertically to direct the air flow from the vent.

8.3. Air quality

8.3.1. Air quality

The materials selected for the passenger compartment and the air purification system ensure that the air quality in the passenger compartment is high.

Materials in the passenger compartment

The interior of the passenger compartment is designed to be pleasant and comfortable, even for people with contact allergies and for asthma sufferers.

Tested materials have been developed in order to reduce the quantity of dust in the passenger compartment and to contribute to making the passenger compartment easier to keep clean.

The carpets in both the passenger compartment and the cargo area are removable and easy to remove and clean.

Use cleaning agents and car care products recommended by Volvo to clean the interior.

Air purification system

In addition to the passenger compartment filter, the car is equipped with an air purification system that helps to maintain high air quality in the passenger compartment.

8.3.2. Advanced Air Cleaner*

Advanced Air Cleaner is a fully-automatic air purifier that collects contaminants in the form of small airborne particulate matter and exhaust gases in the passenger compartment filter, which improves the climate in the passenger compartment.

The content of this manual represents the status of the user manual at the time of printing and may not be completely valid in future instances. For more information, refer to the first page for the complete disclaimer note.

The function is started automatically when the fan is started.

Small airborne particulate matter is sometimes called PM_{2.5} (particles smaller than 2.5 µm), the content of such particles in the car is measured by one of the car's climate sensors. The content in the car is presented in the downloadable Air Quality app.

* Option/accessory.

8.3.3. CleanZone*

The CleanZone function checks and indicates whether or not all conditions have been met for good air quality in the passenger compartment.

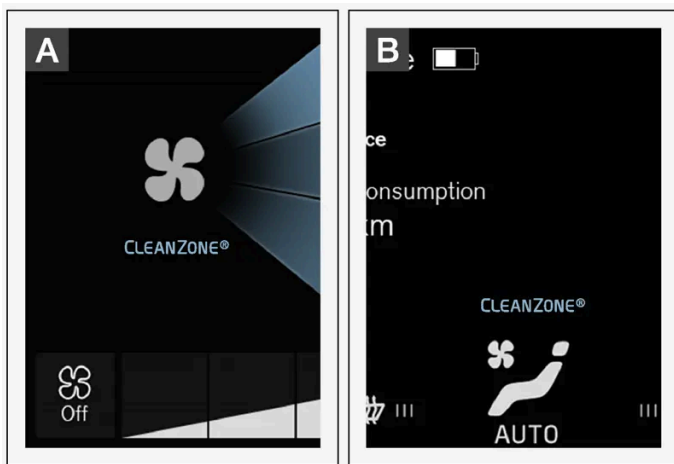

A The indicator is visible in the climate view in the centre display.

B The indicator is visible in the climate row when the climate view is not open.

If the conditions have not been met then the **CleanZone** text is white.

When all conditions have been met, this is indicated by the text changing colour to blue.

Conditions that need to be met:

- That all doors and the tailgate are closed.
- That all side windows and the panoramic roof* are closed.
- That the air quality system Interior Air Quality System* is activated.
- That the ventilation fan is activated.
- That the air recirculation is deactivated.

i Note

CleanZone does not indicate that the air quality is good. It only indicates that the conditions for good air quality have been met.

* Option/accessory.

8.3.4. Clean Zone Interior Package *

Clean Zone Interior Package (CZIP) comprises a series of modifications that keep the passenger compartment even clearer from allergy and asthma-inducing substances, among other things.

The following is included:

- An enhanced fan function that means that the fan starts when the car is unlocked with the remote control key. The fan fills the passenger compartment with fresh air. The function starts when required and is disengaged automatically after a time or when one of the passenger compartment doors is opened. The amount of time the fan runs is reduced gradually due to reduced need up until the car is 4 years old.
- The fully automatic air quality system Interior Air Quality System (IAQS).

* Option/accessory.

8.3.5. Interior Air Quality System *

Interior Air Quality System (IAQS) is a fully automatic air quality system that separates gases and particles to reduce the levels of odours and contaminants in the passenger compartment.

IAQS is a part of the Clean Zone Interior Package (CZIP) and cleans the air in the passenger compartment from contaminants such as particles, hydrocarbons, nitrous oxides and ground-level ozone.

If the air quality sensor senses that the outside air is contaminated, the air intake is closed and air recirculation is activated.

***i* Note**

The air quality sensor should always be engaged in order to improve the air quality in the passenger compartment.

In a cold climate recirculation is limited so as to prevent misting.

In the event of misting, the defrost functions for windscreen, side windows and rear window should be used.

* Option/accessory.

8.3.6. Activating and deactivating the air quality sensor *

The air quality sensor is part of the fully automatic air quality system Interior Air Quality System (IAQS).

It is possible to set whether the air quality sensor should be activated/deactivated.

- 1 Press **Settings** in the top view in the centre display.
- 2 Press **Climate**.
- 3 Select **Air Quality Sensor** to activate/deactivate the air quality sensor.

* Option/accessory.

8.3.7. Passenger compartment filter

All air entering the car's passenger compartment is cleaned with a filter.

Replacing the passenger compartment filter

To maintain high climate system performance, the filter must be changed at regular intervals. Follow the Volvo Service Programme for the recommended replacement intervals. If the car is used in a severely contaminated environment, it may be necessary to replace the filter more often.

 **Note**

There are different types of passenger compartment filter. Make sure that the correct filter is fitted.

8.3.8. Pre-cleaning*

Pre-cleaning of the car prior to departure is used to improve air quality in the passenger compartment.

Pre-cleaning can be started directly from the centre display or a mobile phone, but it also starts automatically when preconditioning ends.

This function uses the ventilation to blow fresh air into the passenger compartment and then circulates the air through the air conditioning system's passenger compartment filter.

* Option/accessory.

8.3.9. Starting and switching off pre-cleaning*

Pre-cleaning improves the air quality in the passenger compartment prior to driving. The function can use direct start from the centre display or a mobile phone.

Start and switch off from car



Open climate view in the centre display by pressing the symbol in the middle of the climate row.

2 Select the **Parking climate** tab.

3 Press **Start Pre-cleaning**.

➤ Pre-cleaning is started/switched off and the button is illuminates/extinguishes.

Starting from the app*

Start of pre-cleaning and information about the selected settings can be managed from a device that has the Volvo On Call* app.

 **Note**

Pre-cleaning always starts automatically when preconditioning is completed.

* Option/accessory.

8.3.10. Air Quality app

The Air Quality app is a service that visualises the measured content of small airborne particulate matter inside the car over time.

A climate sensor measures the content of PM_{2.5} particles (particles smaller than 2.5 µm) in the passenger compartment*.

To be able to use this app, the following is required:

- The car must have access to the network for at least 1 minute when the app is started or the car is restarted.
- The car must be running in order for the PM_{2.5} sensor to take measurements.

* Option/accessory.

8.4. Parking climate

8.4.1. Preconditioning

8.4.1.1. Preconditioning

Preconditioning is a climate function which, if possible, attempts to reach comfort temperature in the passenger compartment before departure.

Preconditioning can use direct start or be set via the timer.

The function utilises several systems in different cases:

- In a cold climate, the parking heater warms up the passenger compartment to a comfortable temperature.
- The air conditioning, in a hot climate, cools the passenger compartment to the comfort temperature.
- Activation of heated steering wheel* and heated seats* for driver and passenger can be selected.
- Heated windscreen, rear window and door mirrors are automatically activated as required.

During preconditioning in a hot climate, condensation from the air conditioning may drip under the car. This is normal.

Note

Preconditioning is only available when the car is connected to an electrical socket.^[1] A charging station that is not constantly active, due to a timer, may result in pre-conditioning failure.

If the car is not connected to an electrical socket, it is still possible to cool the passenger compartment briefly in a warm climate by starting preconditioning directly.

Note

During preconditioning of the passenger compartment, the car works to reach comfort temperature and not the temperature set in the climate control system.

Note

Precleaning* starts automatically when preconditioning is completed.

* Option/accessory.

^[1] Not applicable to fuel-driven auxiliary heater.

8.4.1.2. Start and switch off preconditioning

Preconditioning heats or cools the passenger compartment, if possible, prior to driving. The function can use direct start from the centre display or a mobile phone.

Start and switch off from car



Open climate view in the centre display by pressing the symbol in the middle of the climate row.

- 2 Select the **Parking climate** tab.
 - 3 Select whether seat heating and steering wheel heating should be activated during preconditioning by ticking/unticking the boxes for the respective function.
 - 4 Press **Start Pre-con. & Cleaning**.
- Preconditioning is started/switched off and the button is illuminates/extinguishes.

Note

Preconditioning is only available when the car is connected to an electrical socket.^[1] A charging station that is not constantly active, due to a timer, may result in pre-conditioning failure.

If the car is not connected to an electrical socket, it is still possible to cool the passenger compartment briefly in a warm climate by starting preconditioning directly.

Note

The car's doors and windows should be closed during the preconditioning of the passenger compartment.

 **Note**

Pre-cleaning* starts automatically when preconditioning is completed.

 **Warning**

Do not use preconditioning^[2]:

- In unventilated spaces indoors. Exhaust gases are emitted if the heater starts.
- In locations with combustible or flammable material nearby. Fuel, gas, long grass, sawdust, etc. may ignite.
- When there is a risk that the heater's exhaust line may be blocked. For example, deep snow inside the front right-hand wheel housing can obstruct the heater's ventilation.

Remember that the preconditioning can be started by a timer that has been set for a long time in advance.

Start from the mobile app

Starting the pre-conditioning, as well as information on selected settings, can be managed from a device that has the Volvo Cars app*. Preconditioning heats or cools the compartment (with the car's air conditioning) until a comfortable temperature is reached.

The passenger compartment can also be preconditioned with the car remote start function (Engine Remote Start - ERS)^[3] via the Volvo Cars app*.

^[1] Not applicable to fuel-driven auxiliary heater.

* Option/accessory.

^[2] Applicable to fuel-driven auxiliary heater.

^[3] Certain markets.

8.4.1.3. Preconditioning time setting

The timer can be set so that the preconditioning is finished at a predetermined time.

The timer can handle up to 8 different settings for

- a time on a single date
- a time on one or more days of the week, with or without repetition.

Note

Preconditioning is only available when the car is connected to an electrical socket.^[1] A charging station that is not constantly active, due to a timer, may result in pre-conditioning failure.

If the car is not connected to an electrical socket, it is still possible to cool the passenger compartment briefly in a warm climate by starting preconditioning directly.

^[1] Not applicable to fuel-driven auxiliary heater.

8.4.1.4. Activating and deactivating time setting for preconditioning

A time setting in the timer for preconditioning can be activated or deactivated based on need.

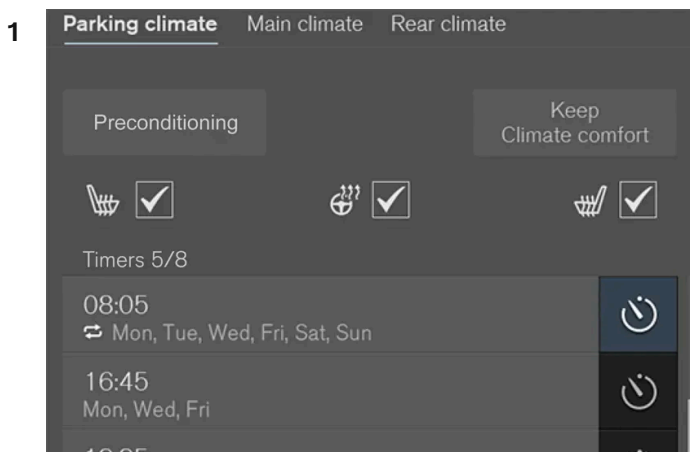

The timer buttons in the Parking climate tab in the climate view.

Open the climate view in the centre display.

- 2 Select the **Parking climate** tab.
- 3 Activate/deactivate a time setting by tapping on the timer button to the right of the setting.
 - The time setting is activated/deactivated and the button illuminates/extinguishes.

 **Warning**

Do not use preconditioning^[1]:

- In unventilated spaces indoors. Exhaust gases are emitted if the heater starts.
- In locations with combustible or flammable material nearby. Fuel, gas, long grass, sawdust, etc. may ignite.
- When there is a risk that the heater's exhaust line may be blocked. For example, deep snow inside the front right-hand wheel housing can obstruct the heater's ventilation.

Remember that the preconditioning can be started by a timer that has been set for a long time in advance.

^[1] Applicable to fuel-driven auxiliary heater.

8.4.1.5. Removing time setting for preconditioning

A time setting for preconditioning that is no longer required can be deleted.

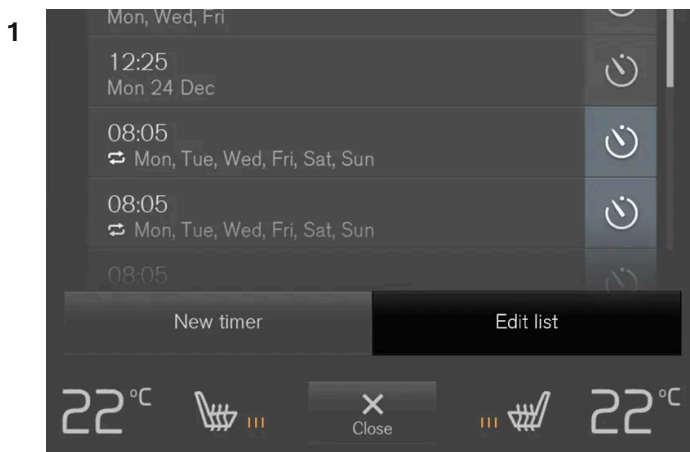

The button for editing the list/deleting the time setting in the tab **Parking climate** in the climate view.

Open the climate view in the centre display.

- 2 Select the **Parking climate** tab.
- 3 Press **Edit list**.
- 4 Press the delete icon to the right in the list.
 - > The icon changes to the text **Delete**.
- 5 Press **Delete** to confirm.
 - > The time setting is removed from the list.

8.4.1.6. Adding and editing time setting for preconditioning

The timer for preconditioning can manage up to 8 time settings.

Adding a time setting

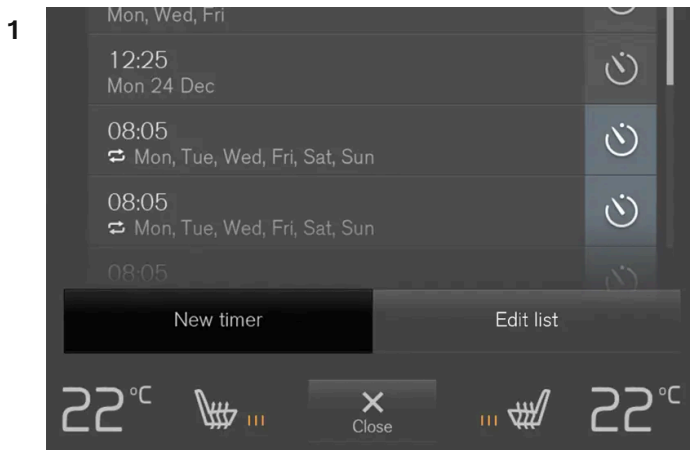

The button to add a time setting in the **Parking climate** tab in the climate view.

Open the climate view in the centre display.

- 2 Select the **Parking climate** tab.
- 3 Press **Add timer**.
- > A pop-up window is shown.

Note

It is not possible to add a time setting if there already are 8 settings entered for the timer. Delete a time setting in order to be able to add a new one.

- 4 Tap on **Date** to set the time for a single date.
Tap on **Days** to set the time for one or more days of the week.
With **Days**: Activate/deactivate repetition by ticking/unticking the box for **Repeat weekly**.
- 5 With **Date**: Select the date for preconditioning by scrolling the date list with the arrows.
With **Days**: Select the days of the week for preconditioning by tapping on the buttons for the days of the week.
- 6 Set the time when the preconditioning should be finished by scrolling with the arrows.
- 7 Tap on **Confirm** in order to add the time setting.
> The time setting is added to the list and is activated.

 **Warning**

Do not use preconditioning^[1]:

- In unventilated spaces indoors. Exhaust gases are emitted if the heater starts.
- In locations with combustible or flammable material nearby. Fuel, gas, long grass, sawdust, etc. may ignite.
- When there is a risk that the heater's exhaust line may be blocked. For example, deep snow inside the front right-hand wheel housing can obstruct the heater's ventilation.

Remember that the preconditioning can be started by a timer that has been set for a long time in advance.

Editing a time setting

- 1 Open the climate view in the centre display.
- 2 Select the **Parking climate** tab.
- 3 Press the time setting that is to be changed.
 - A pop-up window is shown.
- 4 Edit the time setting in the same way as described in "Adding a time setting" above.

^[1] Applicable to fuel-driven auxiliary heater.

8.4.2. Pre-cleaning

8.4.2.1. Pre-cleaning*

Pre-cleaning of the car prior to departure is used to improve air quality in the passenger compartment.

Pre-cleaning can be started directly from the centre display or a mobile phone, but it also starts automatically when preconditioning ends.

This function uses the ventilation to blow fresh air into the passenger compartment and then circulates the air through the air conditioning system's passenger compartment filter.

* Option/accessory.

8.4.2.2. Starting and switching off pre-cleaning*

Pre-cleaning improves the air quality in the passenger compartment prior to driving. The function can use direct start from the centre display or a mobile phone.

Start and switch off from car



Open climate view in the centre display by pressing the symbol in the middle of the climate row.

2 Select the **Parking climate** tab.

3 Press **Start Pre-cleaning**.

> Pre-cleaning is started/switched off and the button is illuminates/extinguishes.

Starting from the app*

Start of pre-cleaning and information about the selected settings can be managed from a device that has the Volvo On Call* app.



Pre-cleaning always starts automatically when preconditioning is completed.

* Option/accessory.

8.4.3. Climate comfort for parking

8.4.3.1. Climate comfort when parking

The climate in the car's passenger compartment can be maintained while the car is parked, e.g. if the engine needs to be switched off but the driver or passenger(s) wants to remain in the car and maintain the level of climate comfort.

Starting climate comfort retention is only possible via direct start from the centre display.

The function utilises several systems in different cases:

- Residual heat from the engine, in a cold climate, heats the passenger compartment to comfort temperature.
- When it is warm, the ventilation cools the passenger compartment by blowing in air from outside the car.

i Note

Climate comfort retention is switched off when the car is locked from the outside to avoid using residual heat unnecessarily. Use of the function is intended to maintain climate comfort when driver or passengers remain inside the car.

There is a limit to how long climate comfort can be maintained in a cold climate, which depends on the amount of residual heat available.

8.4.3.2. Starting and switching off climate comfort when parking

Climate comfort retention maintains the climate in the passenger compartment after driving. The function can use direct start from the centre display.



Open climate view in the centre display by pressing the symbol in the middle of the climate row.

2 Select the **Parking climate** tab.

3 Press **Keep climate comfort**.

➤ Climate comfort retention is started/switched off and the button illuminates/extinguishes.

i Note

It is not possible to start climate comfort retention if there is not enough residual heat in the engine to maintain the passenger compartment climate, or if the outside temperature is above approx. 20°C (68°F).

i Note

Climate comfort retention is switched off when the car is locked from the outside to avoid using residual heat unnecessarily. Use of the function is intended to maintain climate comfort when driver or passengers remain inside the car.

There is a limit to how long climate comfort can be maintained in a cold climate, which depends on the amount of residual heat available.

8.4.4. Parking climate

Parking climate control is a generic term for various functions that improve the passenger compartment climate when the car is parked, e.g. preconditioning.



Functions belonging to the parking climate control are controlled from the **Parking climate** in climate view in the centre display. Open climate view by pressing the symbol in the middle of the climate row.







8.4.5. Symbols and messages for parking climate control

A number of symbols and messages regarding parking climate control can be shown in the driver display.

Messages relating to parking climate control can also be displayed in a device which has the Volvo Cars app*.



This symbol illuminates in the driver display when the parking heater is active.^[1]

Symbol	Message	Specification
	Parking climate Service required	Parking climate control is disengaged. Contact a workshop ^[2] to check the function as soon as possible.
	Parking climate Temporarily unavailable	Parking climate control is temporarily disengaged. If the problem persists for some time, contact a workshop ^[2] to check the function.
	Parking climate Unavailable Fuel level too low ^[1]	Parking climate control cannot be activated when the fuel level is too low to start the parking heater. Fill the vehicle's fuel tank.
	Parking climate Unavailable Charge level too low	Parking climate control cannot be activated if the charge level of the hybrid battery is too low to start the parking heater. Start the car.
	Parking climate Unavailable, not connected to the mains ^[3]	The parking climate control cannot be activated if the charging cable is not connected. Connect the charging cable.
	Parking climate Limited Charge level too low	The running time for parking climate control is limited when the state of charge in the hybrid battery is low. Start the car.

* Option/accessory.

^[1] Applies to fuel-driven heater.

^[2] An authorised Volvo workshop is recommended.

^[3] Applies to the high-voltage heater.

8.4.6. Parking heater

The parking heater heats the passenger compartment as necessary before driving if the car's preconditioning is activated.

The parking heater is one of two subfunctions of the car's heater. The heater is fitted in the front right-hand wheel housing.



When this symbol illuminates in the driver display, the parking heater may be active.^[1]

Note

When the heater is running^[2], smoke may be emitted from the right-hand front wheel housing and a low hum may be heard. A ticking sound from the fuel pump may also be heard from the rear section of the car. This is perfectly normal.

The parking heater starts automatically if the parking climate's preconditioning is activated and the passenger compartment needs to be heated up.

Depending on factors such as battery level, passenger compartment temperature and ambient temperature, the heater has different running times, but never longer than 30 minutes.

Note

Make sure there is enough fuel in the car's fuel tank if the parking heater needs to be used.^[2]

Make sure that there is enough charge in the hybrid battery if the parking heater needs to be used. The car must be connected to an electrical socket for the heater to be used for preconditioning.

Warning

Do not use preconditioning^[2]:

- In unventilated spaces indoors. Exhaust gases are emitted if the heater starts.
- In locations with combustible or flammable material nearby. Fuel, gas, long grass, sawdust, etc. may ignite.
- When there is a risk that the heater's exhaust line may be blocked. For example, deep snow inside the front right-hand wheel housing can obstruct the heater's ventilation.

Remember that the preconditioning can be started by a timer that has been set for a long time in advance.

Warning

If there is a smell of fuel, unusual amounts of smoke, black smoke, or unusual sounds coming from the parking heater^[2], switch off the heater and, if possible, pull out its fuse. Volvo recommends that an authorised Volvo workshop should be contacted for repair.

^[1] Applies to fuel-driven heater.

^[2] Applicable to fuel-driven auxiliary heater.

8.5. Heater

8.5.1. Heater

The heater has two subfunctions that help to heat the passenger compartment or engine in different situations.

The heater has two subfunctions:

- Parking heater - heats the passenger compartment, if necessary, when the parking climate control's preconditioning is activated.
- Additional heater - heats the passenger compartment and engine, if necessary, during driving.

Either a fuel-driven heater or a high-voltage heater is used, depending on the market.^[1]

The heater is fitted in the front right-hand wheel housing.

Note

When the heater is running^[2], smoke may be emitted from the right-hand front wheel housing and a low hum may be heard. A ticking sound from the fuel pump may also be heard from the rear section of the car. This is perfectly normal.

Battery and charging

The heater is powered by the car's hybrid battery. If the charge level of the hybrid battery is too low, then the heater is switched off automatically and the driver display shows a message.

Note

Make sure that there is enough charge in the battery if the heater needs to be used. The car must be connected to an electrical socket for the heater to be used for preconditioning.

Fuel and refuelling^[3]



Warning label on fuel filler flap.

The heater uses fuel from the car's normal fuel tank.

If the car is parked on a steep hill, the front of the car should point downhill to ensure that there is a supply of fuel to the heater.

If the level in the fuel tank is too low then the heater is switched off automatically and the driver display shows a message.

Note

Make sure there is enough fuel in the car's fuel tank if the heater needs to be used.

Warning

Fuel which spills out could be ignited. Switch off the fuel-driven heater before starting to refuel.



Check in the driver display that the heater is switched off. This symbol is lit when it is working as a parking heater.

^[1] An authorised Volvo dealer has information regarding which markets use which type of heater.

^[2] Applicable to fuel-driven auxiliary heater.

^[3] Applies to fuel-driven heater.

8.5.2. Parking heater

The parking heater heats the passenger compartment as necessary before driving if the car's preconditioning is activated.

The parking heater is one of two subfunctions of the car's heater. The heater is fitted in the front right-hand wheel housing.



When this symbol illuminates in the driver display, the parking heater may be active.^[1]

Note

When the heater is running^[2], smoke may be emitted from the right-hand front wheel housing and a low hum may be heard. A ticking sound from the fuel pump may also be heard from the rear section of the car. This is perfectly normal.

The parking heater starts automatically if the parking climate's preconditioning is activated and the passenger compartment needs to be heated up.

Depending on factors such as battery level, passenger compartment temperature and ambient temperature, the heater has different running times, but never longer than 30 minutes.

Note

Make sure there is enough fuel in the car's fuel tank if the parking heater needs to be used.^[2]

Make sure that there is enough charge in the hybrid battery if the parking heater needs to be used. The car must be connected to an electrical socket for the heater to be used for preconditioning.

Warning

Do not use preconditioning^[2]:

- In unventilated spaces indoors. Exhaust gases are emitted if the heater starts.
- In locations with combustible or flammable material nearby. Fuel, gas, long grass, sawdust, etc. may ignite.
- When there is a risk that the heater's exhaust line may be blocked. For example, deep snow inside the front right-hand wheel housing can obstruct the heater's ventilation.

Remember that the preconditioning can be started by a timer that has been set for a long time in advance.

Warning

If there is a smell of fuel, unusual amounts of smoke, black smoke, or unusual sounds coming from the parking heater^[2], switch off the heater and, if possible, pull out its fuse. Volvo recommends that an authorised Volvo workshop should be contacted for repair.

^[1] Applies to fuel-driven heater.

^[2] Applicable to fuel-driven auxiliary heater.

8.5.3. Additional heater

The auxiliary heater helps to heat the passenger compartment and engine while driving.

The additional heater is one of two subfunctions of the car's heater. The heater is fitted in the front right-hand wheel housing.

Note

When the heater is running^[1], smoke may be emitted from the right-hand front wheel housing and a low hum may be heard. A ticking sound from the fuel pump may also be heard from the rear section of the car. This is perfectly normal.

The additional heater starts and is controlled automatically when heating is required while the car is being driven.

It switches off automatically when the car is switched off.

Note

Make sure there is enough fuel in the car's fuel tank if the auxiliary heater needs to be used.^[1]

^[1] Applicable to fuel-driven auxiliary heater.

8.5.4. Activating and deactivating automatic start of auxiliary heater

The auxiliary heater helps to heat the passenger compartment and engine while driving.

It is possible to set whether automatic start for the additional heater should be activated/deactivated.

- 1 Press **Settings** in the top view in the centre display.
- 2 Press **Climate**.
- 3 Select **Additional Heater** to activate/deactivate automatic start of the additional heater.

Note

Volvo recommends that the automatic start for the additional heater should be switched off for short driving distances.^[1]

 **Note**

If the auxiliary heater's automatic starting is deactivated, this may impede comfort in the passenger compartment as the climate control system will then have no heat source during electrical operation.

[1] Applicable to fuel-driven auxiliary heater.

8.6. Climate

The car is equipped with electronic climate control. The climate control system cools or heats as well as dehumidifies the air in the passenger compartment.

All climate control system functions are controlled from the centre display and physical buttons in the centre console.

Some functions for the rear seat can also be controlled from the climate controls* at the rear of the tunnel console.

 **Note**

If necessary, the climate control can be used to cool the media system in the centre display. In these cases, the message **Climate system Cooling the infotainment system** is shown in the driver display.

* Option/accessory.

8.7. Controlling climate control with voice recognition ^[1]

Commands for voice control of the climate control system in order to e.g. change temperature, activate a heated seat* or change fan level.

Tap on  and say one of the following commands:

- "Climate" - starts a dialogue for climate control and shows examples of commands.
- "Set temperature to X degrees" - sets the desired temperature.
- "Raise temperature"/"Lower temperature" - raise/lower the temperature setting one step.
- "Sync temperature" - synchronises the temperature for all climate zones in the car with the temperature set for the driver's side.
- "Air on feet"/"Air on body" - opens the desired air flow.
- "Air on feet off"/"Air on body off" - closes the desired air flow.
- "Set fan to max"/"Turn off fan" - changes the air flow to **Max/Off**.
- "Raise fan speed"/"Lower fan speed" - raises/lowers the fan level one step.

The content of this manual represents the status of the user manual at the time of printing and may not be completely valid in future instances. For more information, refer to the first page for the complete disclaimer note.

- "Turn on auto" - activates automatic climate regulation.
- "Air condition on"/"Air condition off" - activates/deactivates the air conditioning.
- "Recirculation on"/"Recirculation off" - activates/deactivates the air circulation.
- "Turn on defroster"/"Turn off defroster" - activates/deactivates defrosting of windows and door mirrors.
- "Turn on max defroster"/"Turn max defroster off" - activates/deactivates the max defroster.
- "Turn on electric defroster"/"Turn off electric defroster" - activates/deactivates the heated windscreen*.
- "Turn on rear defroster"/"Turn off rear defroster" - activates/deactivates the heated rear window and door mirrors.
- "Turn steering wheel heat on"/"Turn steering wheel heat off" - activates/deactivates the heated steering wheel*.
- "Raise steering wheel heat"/"Lower steering wheel heat" - raises/lowers the setting for the heated steering wheel* one step.
- "Turn on seat heat"/"Turn off seat heat" – activates/deactivates the heated driver seat*.
- "Raise seat heat"/"Lower seat heat" - raises/lowers the setting level for the heated driver seat* one step.
- "Turn on seat ventilation"/"Turn off seat ventilation" – activates/deactivates the ventilated driver seat*.
- "Raise seat ventilation"/"Lower seat ventilation" - raises/lowers the setting level for the ventilated driver seat* one step.

 **Note**

Not all system languages support voice recognition. The ones that do are highlighted with the  symbol in the list of available system languages. Read more about where the information can be found in the section on settings for voice recognition.

^[1] Applies to certain markets.

* Option/accessory.

8.8. Servicing the climate control system

The air conditioning system must only be serviced and repaired by an authorised workshop.

Troubleshooting and repair

The air conditioning system contains fluorescent tracing agents. Ultraviolet light must be used during leak detection.

Volvo recommends that an authorised Volvo workshop is contacted.

The car's climate control system uses a freon-free refrigerant, either R1234yf or R134a depending on market. Information about which refrigerant the car's climate control system uses is printed on a decal located on the inside of the front bonnet.

 **Warning**

The air conditioning system contains pressurised refrigerant R134a. This system must only be serviced and repaired by an authorised workshop.

 **Warning**

The air conditioning system contains pressurised refrigerant R1234yf. In accordance with SAE J2845 (Technician Training for Safe Service and Containment of Refrigerants Used in Mobile A/C System), service and repair of the refrigerant system must only be performed by trained and certified technicians in order to ensure the safety of the system.

8.9. Climate control - sensors

The climate control system has a number of sensors to help control the climate in the car. Do not cover or block the sensors with clothing or other objects.

Sensor location

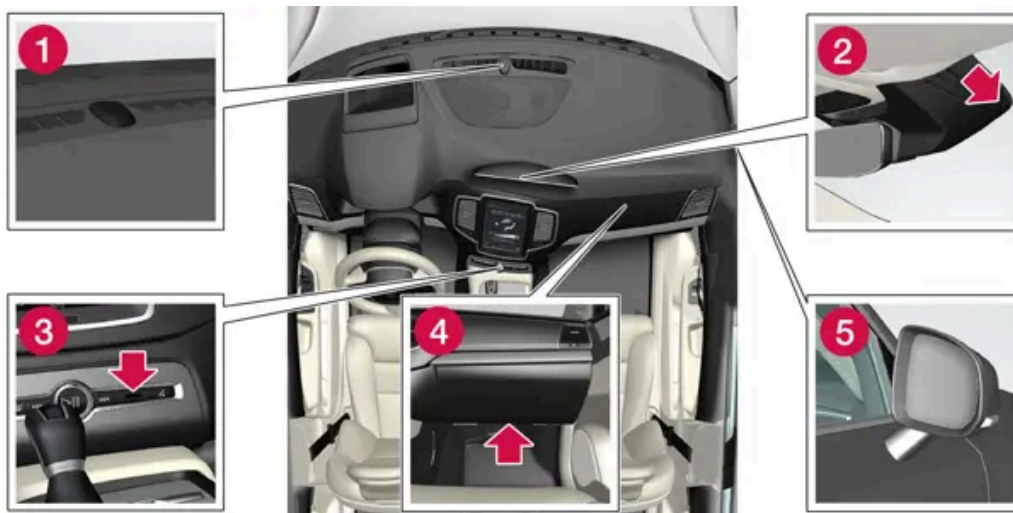

- 1 Sun sensor - on the upper side of the instrument panel.
- 2 Moisture sensor - in the casing by the interior rearview mirror.
- 3 Temperature sensor for the passenger compartment - by the physical buttons in the centre console.
- 4 Airborne particulate matter sensor* – on the underside of the glovebox.
- 5 Outside temperature sensor - in the right-hand door mirror.

With the Interior Air Quality System* there is also an air quality sensor that is fitted into the climate control system air intake.

* Option/accessory.

8.10. Climate zones

The number of climate zones that the car is divided into governs the options for setting different temperatures for different parts of the passenger compartment.

4-zone climate

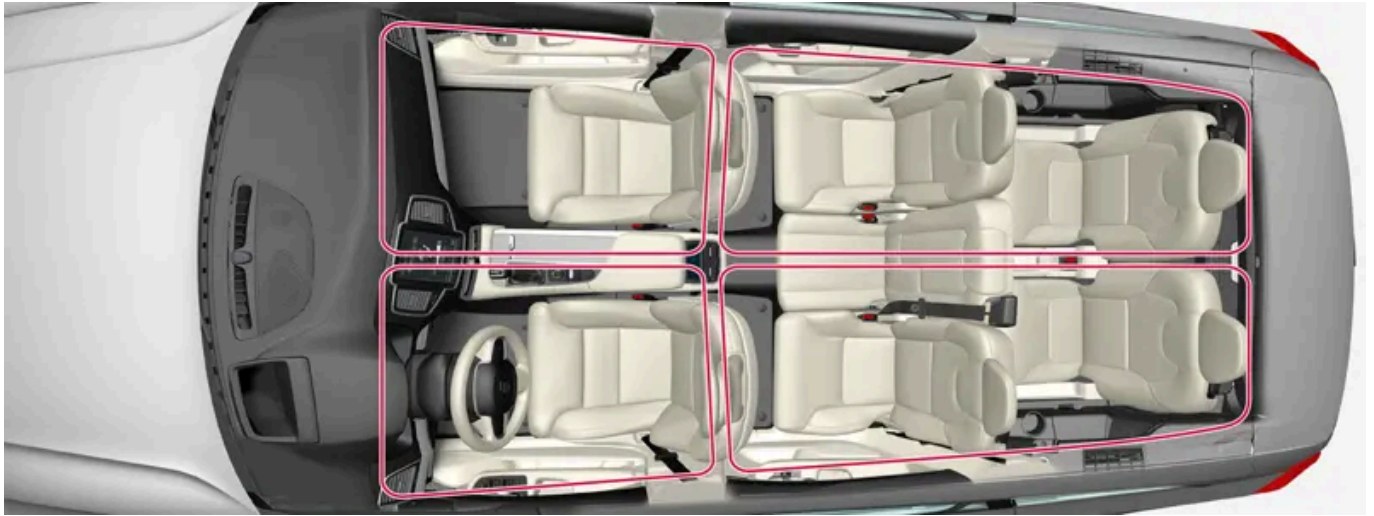

Climate zones with 4-zone climate.

With 4-zone climate the temperature in the passenger compartment can be set separately for the left and right-hand sides in both the front and rear seat.

8.11. Perceived temperature

The climate control system regulates the climate in the passenger compartment based on the perceived temperature, not on actual temperature.

The temperature you select in the passenger compartment corresponds to the physically perceived temperature as affected by factors such as the ambient temperature, air speed, humidity, solar radiation, etc. in and around the car at the time.

The system includes a sun sensor which detects on which side the sun is shining into the passenger compartment. This means that the temperature can differ between the right and left-hand side's air vents despite the controls being set for the same temperature on both sides.

9. Key, locks and alarm

9.1. Remote control key

9.1.1. Driver profiles

9.1.1.1. Driver profiles

Many of the settings made in the car can be adapted according to the driver's personal preferences and can be saved in one or more driver profiles.



The personal settings are automatically saved in the active driver profile. Every remote control key, apart from Care Key, can be linked to a personal driver profile. When the linked key is used, the car is adapted to the settings of that specific driver profile. Care Key is always linked to the latest profile as well as the speed limitation set. This profile cannot be protected as personal.

What settings are saved in the driver profiles?

Many of the settings defined in the car will be saved automatically in the active driver profile unless the profile is protected. In the car, the settings defined are either personal or global. Only personal settings are saved in driver profiles.

Settings that can be saved in a driver profile include, amongst other things, screens, mirrors, front seats, navigation*, audio and media system and language.

Some settings, referred to as global settings, can be changed but are not saved to a specific driver profile. Changes to global settings affect all profiles.

Global settings

The global settings are not changed when changing between driver profiles. They remain the same regardless of which driver profile is active.

Keyboard layout settings are an example of global settings. If driver profile X is used to add additional languages to the keyboard, these remain available for use even if driver profile Y is used. The keyboard layout settings are not saved to a specific driver profile - the settings are global.

Personal preferences

If driver profile X was used to e.g. set centre display brightness, driver profile Y is not affected by this setting. It has been saved to driver profile X - the brightness setting is a personal setting.

* Option/accessory.

9.1.1.2. Renaming a driver profile

It is possible to change the name of the different driver profiles used in the car.

- 1** Press **Settings** in the top view in the centre display.
- 2** Press **System** → **Driver Profiles**.
- 3** Select **Edit Profile**.
 - A menu opens, where the profile can be edited.
- 4** Tap in the box **Profile Name**.
 - A keyboard appears, and it is possible to change the name. Tap on  to close the keyboard.
- 5** Save the name change by pressing **Back** or **Close**.
 - The name has now been changed.

 **Note**

A profile name cannot start with a space, as the profile name will not then be saved.

9.1.1.3. Linking remote control key to driver profile

It is possible to link your key to a driver profile. The driver profile along with all of its settings will then be automatically selected every time the car is used with that specific remote control key.

The first time the remote control key is used, it is not linked to any specific driver profile. When the car is started, the **Guest** profile will automatically be activated.

A driver profile can be selected manually without linking it to the key. When the car is unlocked, the last active driver profile is activated. Once the key has been linked to a driver profile, a driver profile does not need to be selected when that specific key is used.

Linking a remote control key to a driver profile

 **Note**

Connecting a remote control key to a driver profile is only possible when the car is stationary.

First select the profile to be linked to the key, if the profile to be linked is not already active. The active profile can then be linked to the key.

- 1 Press **Settings** in the top view in the centre display.
- 2 Press **System** → **Driver Profiles**.
- 3 Select the desired profile. The display returns to the home view. The **Guest** profile cannot be linked to a key.
- 4 Drag down the top view again and tap on **Settings** → **System** → **Driver Profiles** → **Edit Profile**.
- 5 Select **Connect key** to link the profile with the key. It is not possible to link a driver profile to a different key than the one currently being used in the car. If there are multiple keys in the car, the message **More than one key is found, put the key**

you want to connect on backup reader will be displayed.

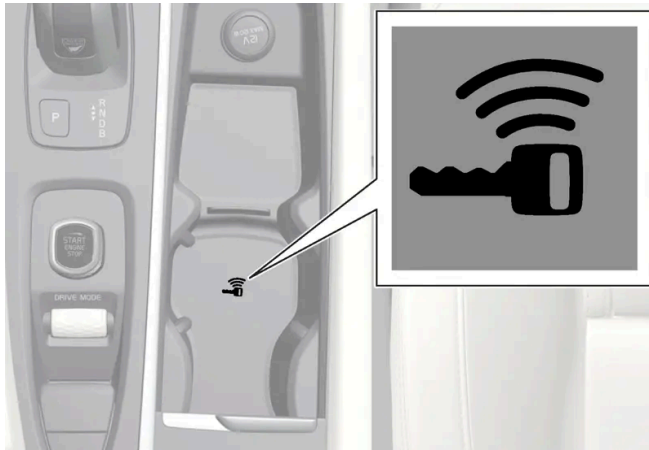

Backup reader's location in the tunnel console.

- When the message **Profile connected to key** is shown, the key and the driver profile are linked.
- 6 Press **OK**.
- This key is now linked to the driver profile and will remain linked as long as the **Connect key** box is not unticked.

9.1.1.4. Protect driver profile

In some cases it is preferable not to save various settings defined in the car to the active driver profile. In this case, it is possible to protect the driver profile.

i Note

Protecting a driver profile is only possible when the car is stationary.

To protect a driver profile:

- 1 Press **Settings** in the top view in the centre display.
- 2 Press **System** → **Driver Profiles**.
- 3 Select **Edit Profile**.
 - A menu opens, where the profile can be edited.
- 4 Select **Protect Profile** to protect the profile.
- 5 Save your profile protection option by pressing **Back/Close**.
 - When the profile is protected, settings defined in the car will not be saved automatically to the profile. Instead, your changes must be saved manually under **Settings** → **System** → **Driver Profiles** → **Edit Profile** by pressing **Save current**

settings to the profile. When the profile is unprotected, on the other hand, your settings will be saved automatically to the profile.

9.1.1.5. Selecting driver profile

When the centre display has been started, the selected driver profile is shown at the top of the screen. The driver profile last used is the one that will be active next time the car is unlocked. It is possible to change to another driver profile after the car has been unlocked. However, if the remote control key has been linked to a driver profile then this is what is selected when the car is started.

There are three options for changing to another driver profile.

Option 1:

- 1 Tap on the name of the driver profile shown in the top of the centre display when the display has been started.
 - A list of selectable driver profiles is shown.
- 2 Select the driver profile required.
- 3 Press **Confirm**.
 - The driver profile is selected and the system loads the settings for the new driver profile.

Option 2:

- 1 Drag down the top view in the centre display.
- 2 Press **Profile**.
 - The same list as for Option 1 is shown.
- 3 Select the driver profile required.
- 4 Press **Confirm**.
 - The driver profile is selected and the system loads the settings for the new driver profile.

Option 3:

- 1 Drag down the top view in the centre display.

- 2 Press **Settings** in the top view in the centre display.
- 3 Press **System** → **Driver Profiles**.
 - A list of selectable driver profiles is shown.
- 4 Select the driver profile required.
 - The driver profile is selected and the system loads the settings for the new driver profile.

9.1.1.6. Resetting settings in the driver profiles

Settings that have been saved to one or more driver profiles can be reset if the car is stationary.

 **Note**

Factory reset is only possible when the car is stationary.

- 1 Press **Settings** in the top view.
- 2 Press **System** → **Factory reset** → **Reset Personal Settings**.
- 3 Select one of the options **Reset for the active profile**, **Reset for all profiles** or **Cancel**.

9.1.2. Linking remote control key to driver profile

It is possible to link your key to a driver profile. The driver profile along with all of its settings will then be automatically selected every time the car is used with that specific remote control key.

The first time the remote control key is used, it is not linked to any specific driver profile. When the car is started, the **Guest** profile will automatically be activated.

A driver profile can be selected manually without linking it to the key. When the car is unlocked, the last active driver profile is activated. Once the key has been linked to a driver profile, a driver profile does not need to be selected when that specific key is used.

Linking a remote control key to a driver profile

Note

Connecting a remote control key to a driver profile is only possible when the car is stationary.

First select the profile to be linked to the key, if the profile to be linked is not already active. The active profile can then be linked to the key.

- 1 Press **Settings** in the top view in the centre display.
- 2 Press **System** → **Driver Profiles**.
- 3 Select the desired profile. The display returns to the home view. The **Guest** profile cannot be linked to a key.
- 4 Drag down the top view again and tap on **Settings** → **System** → **Driver Profiles** → **Edit Profile**.
- 5 Select **Connect key** to link the profile with the key. It is not possible to link a driver profile to a different key than the one currently being used in the car. If there are multiple keys in the car, the message **More than one key is found, put the key you want to connect on backup reader** will be displayed.

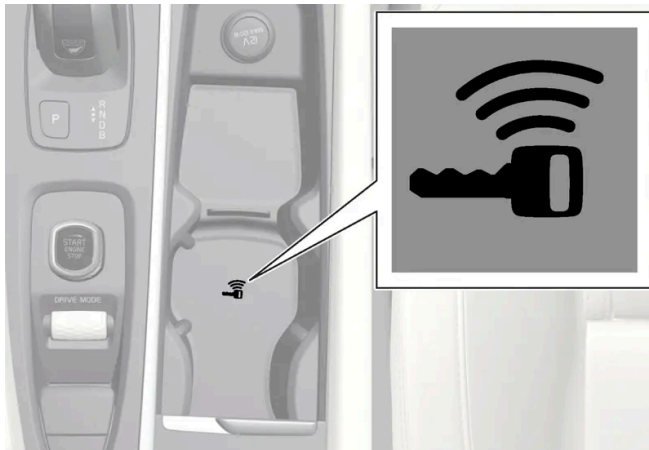

Backup reader's location in the tunnel console.

- When the message **Profile connected to key** is shown, the key and the driver profile are linked.
- 6 Press **OK**.
 - This key is now linked to the driver profile and will remain linked as long as the **Connect key** box is not unticked.

9.1.3. Immobiliser

The electronic immobiliser is a theft protection system that prevents an unauthorised person from starting the car.

The car can only be started with the correct remote control key.

The following error message in the driver display is related to the electronic immobiliser:

Symbol	Message	Specification
	Car key not found	Error reading the remote control key during starting - place the key on the key symbol in the cup holder and try again.

9.1.4. Remote control key

The remote control key locks and unlocks the doors and tailgate. The remote control key needs to be inside the car for it to be started.



Remote control key ^[1], Care Key or respective key tag (Key Tag)*.

The remote control key is not physically used when starting since the car is equipped with support for keyless starting (Passive Start) as standard. You simply need to have the key in the front part of the passenger compartment.

For cars equipped with keyless locking and unlocking (Passive Entry)* the key can be anywhere in the car to start the car. For cars with Passive Entry, a slightly smaller, lighter and button-less key (Key Tag) can also be purchased as an accessory.

The remote control keys^[2] can be linked to different driver profiles to save personal preferences in the car.

 **Warning**

The remote control key contains a button cell battery. Keep new and used batteries out of the reach of children. If someone swallows a battery it may cause serious injury.

If damage is discovered, e.g. if the battery cover cannot be closed properly, then the product should not be used. Keep defective products out of the reach of children.

Remote control key buttons



The remote control key has four buttons - one on the left-hand side and three on the right-hand side.

 **Locking** - Pressing the button locks the doors, tailgate and fuel filler flap and also arms the alarm*.

Press and hold to close all of the windows and the panoramic roof* simultaneously.

 **Unlocking** - Pressing the button unlocks the doors, tailgate and fuel filler flap and also deactivates the alarm.

A longer press opens all windows simultaneously. This total airing function can be used, for example, to quickly air the car in hot weather.

 **Tailgate** - Unlocks the tailgate only and disarms its alarm. On cars with power operated tailgate*, the tailgate is opened automatically when the button is held depressed. The tailgate is also closed with a long press – acoustic warning signals sound.

 **Panic function** - Used to attract attention in an emergency. Press and hold the button for at least 3 seconds or press it twice within 3 seconds to activate the direction indicators and the horn. The function can be turned off with the same button once it has been active for at least 5 seconds. Otherwise the function switches off automatically after 3 minutes.

 **Warning**

If anyone is left in the car, make sure the power windows and panoramic roof* are de-energised by always taking the remote control key with you when you leave the car.

i Note

Be aware of the risk of locking the remote control key in the car.

A remote control key or key tag left in the car will be deactivated when the car is locked and the alarm is armed using another valid key. The "Double lock" function is also deactivated. The key left behind is reactivated when the car is unlocked.

Button-less key (Key Tag)*

A Key Tag can be ordered as an accessory for cars equipped with the keyless locking and unlocking function. A key tag works the same way as the normal remote control key when it comes to keyless starting and locking and unlocking. The key is water-proof to a depth of approx. 10 metres (30 feet) for up to 60 minutes. It has no detachable key blade and the battery cannot be replaced.

Care Key - restricted remote control key

A Care Key allows the car owner to set a limit for the speed of the car. The limitation is intended to encourage the car to be driven in a safe manner, e.g. when being loaned out.

Interference

Remote control key functions for keyless starting and keyless locking and unlocking* can be disrupted by electromagnetic fields and screening.

i Note

Avoid storing the remote control key close to metal objects or electronic apparatus, e.g. mobile phones, tablets, laptops or chargers - preferably no closer than 10-15 cm (4-6 inches).

If there is still interference - use the remote control key's detachable key blade to unlock and then place the key in the backup reader in the cup holder to disarm the car and allow the car to be started.

i Note

When the remote control key is placed in the cup holder, make sure that no other car keys, metal objects or electronic apparatus (e.g. mobile phones, tablets, laptops or chargers) are in the cup holder. Several car keys close to each other in the cup holder can cause interference with each other.

^[1] The figure is schematic - parts may vary depending on car model.

* Option/accessory.

^[2] Does not apply to Care Key.

9.1.5. Ordering more remote control keys

If a key is lost or you need more keys than the standard number, it is possible to order new keys. If the car is equipped with keyless locking and unlocking* a button-less key (Key Tag) can also be ordered.

A total of twelve keys can be programmed and used for one single car. If additional keys are ordered, additional driver profiles are added – one per new key. This also applies for the key tag.

Loss of a remote control key

If you lose a remote control key then a new one can be ordered at a workshop - an authorised Volvo workshop is recommended. The remaining remote control keys must be taken to the workshop. The code of the missing key must be erased from the system as a theft prevention measure.

The current number of keys registered to the car can be checked via driver profiles in the centre display's top view, select **Settings** → **System** → **Driver Profiles**.

* Option/accessory.

9.1.6. Replacing the battery in the remote control key

The battery in the remote control key needs to be replaced when it has become discharged.

Note

All batteries have a limited service life and must eventually be replaced (does not apply to Key Tag). The service life of the battery varies depending on how often the vehicle/key is used.



The battery for the remote control key should be replaced if

- the information symbol illuminates and the message **Car key battery low** is shown in the driver display
- the locks repeatedly do not react to signals from the remote control key within 20 metres (65 feet) of the car.

Note

Always try moving closer to the car and making another unlock attempt.

The battery in the button-less key^[1] (Key Tag) cannot be replaced - a new key can be ordered from an authorised Volvo workshop.

! Important

A discharged Key Tag must be handed over to an authorised Volvo workshop. The key must be deleted from the car since it is still possible to use it to start the car via back-up start.

Opening the key and changing the battery

1 **1**



1

1 Hold the remote control key with the front visible and the Volvo logo facing the right way - slide the button at bottom edge by the key ring to the right. Slide the front side's shell a few millimetres upwards.

2 The shell will then come free and can be lifted off the key.

2 **2**



2

1 Turn the key, move the button to the side and slide the back shell a few millimetres upwards.

2 The shell will then come free and can be lifted off the key.

3 **3**



3

Use a screwdriver or similar to turn the battery cover anticlockwise until the markings meet at the OPEN text.

Carefully lift away the battery cover by pressing e.g. a fingernail into the recess.

Then prize the battery cover upwards.

4 **4**



4

The battery (+) side is facing upwards. Then carefully prize loose the battery as illustrated.

! Important

Avoid touching new batteries and their contact surfaces with your fingers as this may impair their function.

5 **5**



5

Install a new battery with the (+) side up. Avoid touching the remote control key's battery contacts with your fingers.

1 Place the battery in the holder with the edge down. Then slide the battery forwards so that it fastens under the two plastic catches.

2 Press the battery down so that it fastens under the upper black plastic catch.

i Note

Use batteries with the designation CR2032, 3 V.

Note

Volvo recommends that the batteries to be used in the remote control key fulfil UN Manual of Test and Criteria, Part III, sub-section 38.3. Batteries fitted in the factory or replaced by an authorised Volvo workshop fulfil the above criteria.

6



6

Refit the battery cover and turn it clockwise until the marking aligns with the CLOSE text.

7



7

1 Reposition the rear side's shell and press it down until a clicking sound can be heard.

2 Then slide the shell back.

➤ A further click will indicate that the shell is properly positioned and securely attached.

8



8

1 Turn the remote control key over and refit the front side's shell by pressing it down until a clicking sound can be heard.

2 Then slide the shell back.

➤ A further click will indicate that the shell is securely attached.

Warning

Check that the battery is fitted correctly with the correct polarity. If the remote control key shall not been used for a long time, remove the battery to avoid battery leakage and damage. Batteries with damage or leaks may cause corrosive injury on contact with the skin. Therefore, use protective gloves when handling damaged batteries.

- Keep batteries out of the reach of children.
- Do not leave batteries lying around since they can be swallowed by children or pets.
- Batteries must not: be dismantled, short-circuited or thrown into open flames.
- Do not charge non-rechargeable batteries, this may cause an explosion.

Before use, the remote control key should be checked to avoid causing damage. If damage is discovered, e.g. if the battery cover cannot be closed properly, then the product should not be used. Keep defective products out of the reach of children.

Important

Make sure that exhausted batteries are disposed of in a manner which is kind to the environment.

* Option/accessory.

[1] Supplied with cars equipped with keyless locking/unlocking*.

9.1.7. Locking and unlocking with the remote control key

The buttons on the remote control key can be used to lock and unlock all doors and the tailgate simultaneously.

Locking with the remote control key



The figure is schematic - parts may vary depending on car model.

The content of this manual represents the status of the user manual at the time of printing and may not be completely valid in future instances. For more information, refer to the first page for the complete disclaimer note.

- 1 Press the remote control key  button to lock the car.

The driver's door must be closed in order for the lock sequence to be activated^[1]. If any of the other doors or the tailgate is open, then these are not locked and their alarms armed* until they are closed. The alarm's movement detectors* are activated when all the doors and the tailgate are closed and locked.

 **Note**

Be aware of the risk of locking the remote control key in the car.

A remote control key or key tag left in the car will be deactivated when the car is locked and the alarm is armed using another valid key. The "Double lock" function is also deactivated. The key left behind is reactivated when the car is unlocked.

Locking when the tailgate is open

 **Note**

If the car has been locked while the tailgate is open, be careful not to leave the remote control key in the cargo area when the tailgate is closed and the car is completely locked^[2].

Unlocking with the remote control key

- 1 Press the remote control key  button to unlock the car.

Automatic relocking

If none of the doors or the tailgate is opened within 2 minutes of unlocking, they are locked automatically. This function prevents the car from being left unlocked unintentionally.

When the remote control key does not work

 **Note**

Always try moving closer to the car and making another unlock attempt.

If it is not possible to lock or unlock with the remote control key, the battery may be discharged - in which case, lock or unlock the driver's door with the detachable key blade.

* Option/accessory.

[1] If the car is equipped with keyless locking/unlocking* then all side doors must be closed.

[2] If the car is equipped with keyless locking/unlocking and the key is detected inside the car, the tailgate will not lock when it is closed.*

9.1.8. Care Key - restricted remote control key

A Care Key allows the car owner to set a limit for the speed of the car. The limitation is intended to encourage the car to be driven in a safe manner such as when being loaned out, for example.



For a Care Key, you can set your car's maximum speed. Other functions of the key are the same as those of a normal remote control key.

The limits are intended to act as measures to reduce the risk of accidents, thereby making it feel safer to hand over the car to e.g. young drivers, valet parking or a workshop.

Ordering Care Key

One or more Care Key can be ordered from a Volvo dealer. A total of eleven keys with restrictions can be programmed and used for a single car - at least one must be a normal remote control key.

Using Care Key

The key is linked to a special Care Key driver profile, and when it is active, the key's settings cannot be changed. It is not possible to change to another driver profile either; this requires a normal remote control key.

The driver profile is activated when the car is unlocked with a Care Key without a normal remote control key in the vicinity. Alternatively, the Care Key profile can be activated before the normal remote control key is removed.

To activate a normal driver profile, the car must be unlocked using a key without limits.

Indication in driver display

The use of Care Key is indicated by a symbol in the driver display, as well as a red bar in the speedometer, which also indicates the speed limitation.

Symbol	Specification
	Speed limitation is active.

9.1.9. Care Key settings

Change the maximum speed of a Care Key via the centre display.

Setting options

The following limitations are available to be set:

- Speed interval: 50-180 km/h (30-112 mph)
- Increments: 1 km/h (1 mph)



Setting

- 1 Unlock the car with the normal remote control key (not Care Key).
- 2 Tap on **Settings** in the centre display's top view.
- 3 Press **System** → **Driver Profiles** → **Care Key**.
- 4 Tick the box for activating limitation and set the required limitation.

9.1.10. Unlocking the tailgate with the remote control key

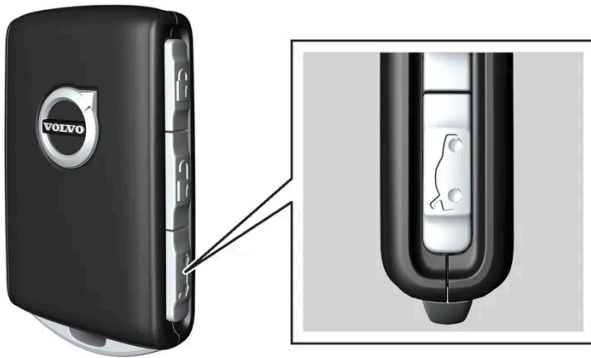
It is possible to unlock just the tailgate by pressing a button on the remote control key.



- 1 Press the remote control key's  button.
 - The tailgate is unlocked but remains closed.
The side doors are still locked and the alarm is armed*. The lock and alarm indicator on the instrument panel extinguishes in order to show that the entire car is not locked.
Lightly grasp the rubberised pressure plate beneath the tailgate handle to open the tailgate. If the tailgate is not opened within 2 minutes then it is relocked and the alarm is re-armed.
- 2 With the power operated tailgate option* -
Long press (approx. 1.5 seconds) on the remote control key's  button
 - The tailgate is unlocked and opened, while the side doors remain locked and their alarm functions armed.

* Option/accessory.

9.1.11. Detachable key blade

The remote control key contains a detachable key blade of metal with which a number of functions can be activated and some operations carried out.

The key blade's unique code is provided by authorised Volvo workshops, which are recommended when ordering new key blades.

The key blade's application areas

Using the remote control key's detachable key blade

- the left-hand ^[1] front door can be opened manually if central locking cannot be activated with the remote control key

The content of this manual represents the status of the user manual at the time of printing and may not be completely valid in future instances. For more information, refer to the first page for the complete disclaimer note.

- all doors are emergency-locked
- the rear doors' mechanical child lock can be activated and deactivated.
- disarm the alarm and start the car by fitting the key in the back-up reader in the tunnel console.

The button-less key^[2] does not have a detachable key blade. If necessary, use the detachable key blade from the normal remote control key.

Detaching the key blade

1 **1**



1

1 Hold the remote control key with the front visible and the Volvo logo facing the right way - slide the button at bottom edge by the key ring to the right. Guide the front side's shell a few millimetres upwards.

2 The shell will then come free and can be lifted off the key.

2 **2**



2

1 Detach the key blade by angling it up.

3 **3**



3

Return the key blade to its intended position in the remote control key after use.

The content of this manual represents the status of the user manual at the time of printing and may not be completely valid in future instances. For more information, refer to the first page for the complete disclaimer note.

1 Refit the shell by pressing it downward until a clicking sound is heard.

2 Then slide the shell back.

> A further click will indicate that the shell is securely attached.

[1] This applies whether the car is left-hand drive or right-hand drive.

* Option/accessory.

[2] Supplied with cars equipped with keyless locking/unlocking*.

9.1.12. Locking and unlocking with the detachable key blade

Amongst other things, the detachable key blade can be used to unlock the car from the outside - e.g. if the remote control key's battery has become discharged.

Unlocking

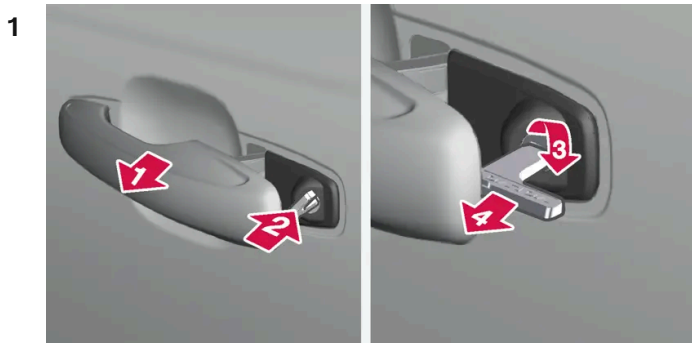

Pull out the front door handle on the left-hand side to its end position so that the lock cylinder becomes visible^[1].



Insert the key in the lock cylinder.



Turn clockwise 45 degrees so that the key blade is pointing straight back.



Turn the key back 45 degrees to its starting position. Remove the key from the lock cylinder and release the handle so that the rear section of the handle is resting against the car again.

5 Pull out the handle.

➤ The door opens.

i Note

When the door is unlocked using the key blade and is then opened, the alarm is triggered. The alarm must be deactivated manually, see separate section.

Locking

The left-hand front door can be locked with its lock cylinder and the detachable key blade.

The other doors have a locking switch at the end that must be pushed in using the key blade – then they are mechanically locked/inhibited from opening from outside.

The doors can still be opened from the inside.

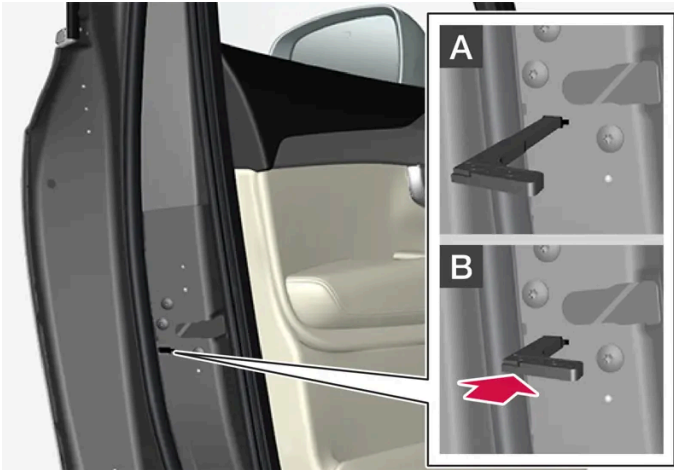

Manual locking of the door. Not to be confused with the child safety lock.

- 1 Remove the detachable key blade from the remote control key.
- 2 Insert the key blade in the hole for lock reset.
- 3 Press in the key until the key bottoms, approximately 12 mm (0.5 inches).

A The door can be opened from both the outside and the inside.

B The door is blocked against opening from the outside. To return to position A, the inner door handle must be opened.

i Note

- A door's lock reset only locks that particular door - not all doors simultaneously.
- A manually locked rear door with child lock activated cannot be opened from inside or outside. The door can then only be unlocked with the key buttons, central locking button, the keyless locking system* or Volvo On Call*.



^[1] This applies whether the car is right-hand drive or left-hand drive.

* Option/accessory.

9.1.13. Remote control key range

In order for the remote control key to work properly it needs to be within a certain distance from the car.

For manual use

The remote control key's functions for e.g. locking/unlocking that are activated by pressing on  or  have a range that extends approx. 20 metres (65 feet) from the car.

The content of this manual represents the status of the user manual at the time of printing and may not be completely valid in future instances. For more information, refer to the first page for the complete disclaimer note.

If the car does not verify a button being pressed - move closer and try again.

For keyless* use

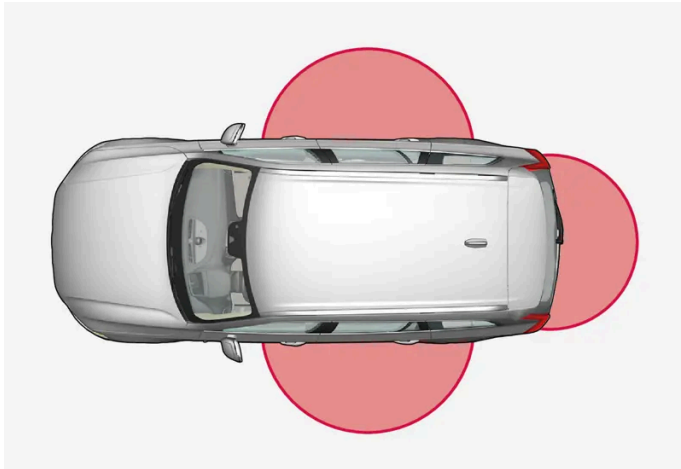

The marked area in the illustration shows areas covered by the system's antennas.

For keyless use, a remote control key or the button-less key (Key Tag) must be within a semicircular area with a radius of approx. 1.5 metres (5 feet) on both long sides and approx. 1 metre (3 feet) from the tailgate.

Note

The remote control key functions may be disrupted by surrounding radio waves, buildings, topographical conditions, etc. The car can always be locked/unlocked with the key blade.

If the remote control key is removed from the car



If the remote control key is removed from the car when the engine is running, the warning message **Car key not found Removed from car** is shown in the driver display and an acoustic reminder sounds when the last door is closed.

The message extinguishes when the key is returned to the car, followed by a press of the right-hand keypad's **O** button, or when the last door is closed.

* Option/accessory.

9.1.14. Type approval for the remote control key system



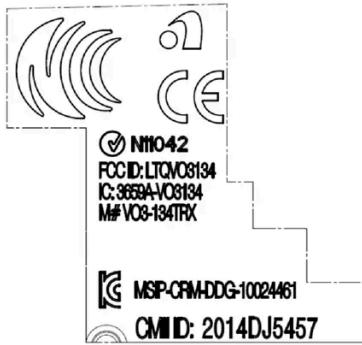

Type approval for the car's remote key system can be seen in the following tables.

Lock system keyless start (Passive Start) and keyless locking/unlocking (Passive

Entry*)











CEM marking for the remote control key system. For supplementary type approval numbers, see following tables.



Country/Area	Type approval	
Argentina	CNC ID: C-14771	
Brazil	MT-3245/2015	 0589-15-6830  (01) 0 7897843840961
Europe	Delphi Deutschland GmbH, 42367 Wuppertal hereby declares that this V03-134TRX conforms to the essential property requirements and other relevant provisions contained in directive 2014/53/EU (RED).	
The United Arab Emirates	ER37847/15 DA0062437/11	
Indonesia	Nomor: 38301/SDPPI/2015	
Jordan	TRC/LPD/2014/250	
Malaysia	RDBV/11A/0816/S(16-2430)	
Mexico	IFETEL: RLVDEVO15-0396	
Namibia	TA-2016-02	 Communications Regulatory Authority of Namibia
Russia		
Serbia	P1614120100	
South Africa	TA-2014-1868	

Remote control key

Country/Area	Type approval	
Europe	Huf Hülsbeck & Fürst GmbH & Co. KG hereby declares that this type of radio equipment HUF8423MS conforms to directive 2014/53/EU. Wavelength: 433.92 MHz Maximum radiated transmission power: 10 mW Manufacturer: Huf Hülsbeck & Fürst GmbH & Co. KG, Steeger Str. 17, 42551 Velbert, Germany	

The content of this manual represents the status of the user manual at the time of printing and may not be completely valid in future instances. For more information, refer to the first page for the complete disclaimer note.

Country/Area	Type approval	
Argentina		See the illustration below the table.
Brazil	Anatel: 06768-19-06643 Modelo: HUF8423MS Este equipamento opera em caráter secundário isto é não tem direito a proteção contra interferência prejudicial, mesmo de estações do mesmo tipo, e não pode causar interferência a sistemas operando em caráter primário.	
Philippines	ESD-1919938C	
The United Arab Emirates		TRA REGISTERED No: ER72465/19 DEALER No: DA36976/14
Ghana	NCA Approved: ZRO-M8-7E3-138	
Indonesia ^[1]	Sertifikat Nomor: 65073/SDPPI/2019 PLG ID: 8093	
CU (Customs Union) Kazakhstan, Russia		
Morocco	AGREE PAR L'ANRT MAROC Numéro d'agrément: MR 20402 ANRT 2019 Date d'agrément: 10/07/2019	
Moldova		
Nigeria	Connection and use of this communication equipment is permitted by the Nigerian Communications Commission	
Oman		OMAN - TRA R/7757/19 D172249
Paraguay	HUF8423MS	HUF8423MS  NR:2019-08-I-0447
Serbia		
Singapore	Complies with IMDA Standards DA103787	
South Africa	TA-2019/772	
Taiwan	<p>????????????????????</p> <p>????????????????????</p> <p>.1</p> <p>????????????????????</p> <ul style="list-style-type: none"> ???????????????????? <p>.2</p> <p>????????????????????</p> <ul style="list-style-type: none"> ???????????????????? ???????????????????? <p>????????????????????</p> <ul style="list-style-type: none"> ?????? 	

Country/Area	Type approval	
Ukraine	.Справжнім Huf Hülsbeck & Fürst GmbH & Co KG заявляє, що тип радіобладнання відповідає Технічному[HUF8423MS] регламенту радіобладнання; повний текст -декларації про відповідність доступний на веб :сайті за такою адресою Робоча частота: 433,92 ГГц	
Vietnam		
Belarus		
Zambia		 ZMB/ZICTA/TA/2019/7/105

Argentina





H-23694

Key Tag

Country/Area	Type approval	
Europe	Huf Hülsbeck & Fürst GmbH & Co. KG hereby declares that this type of radio equipment HUF8432MS conforms to directive 2014/53/EU. Wavelength: 433.92 MHz Maximum radiated transmission power: 10 mW Manufacturer: Huf Hülsbeck & Fürst GmbH & Co. KG, Steeger Str. 17, 42551 Velbert, Germany	
Argentina		See the illustration below the table.
Brazil	Anatel: 04362-16-06643 Modelo: HUF8432MS Este equipo opera em caráter secundário isto é não tem direito a proteção contra interferência prejudicial, mesmo de estações do mesmo tipo, e não pode causar interferência a sistemas operando em caráter primário.	

Country/Area	Type approval	
Ghana	NCA Approved: ZRO-M8-7E3-139	
Philippines	ESD-1919939C	
The United Arab Emirates		
CU (Customs Union) Kazakhstan, Russia		
Indonesia ^[1]	Sertifikat Nomor: 65072/SDPPI/2019 PLG ID: 8093	
Morocco	AGREE PAR L'ANRT MAROC Numéro d'agrément: MR 20403 ANRT 2019 Date d'agrément: 10/07/2019	
Moldova		
Nigeria	Connection and use of this communications equipment is permitted by the Nigerian Communications Commission	
Oman		
Paraguay	HUF8432MS	
Serbia		
Singapore	Complies with IMDA Standards DA103787	
South Africa	TA-2019-773	
Taiwan	<p>????????????????????</p> <p>????????????????????</p> <p>.1</p> <p>????????????????????</p> <ul style="list-style-type: none"> ???????????????????? <p>.2</p> <p>????????????????????</p> <ul style="list-style-type: none"> ???????????????????? ???????????????????? <p>????????????????????</p> <ul style="list-style-type: none"> ?????? 	

Country/Area	Type approval	
Ukraine	.Справжнім Huf Hüsbeck & Fürst GmbH & Co KG заявляє, що тип радіобладнання відповідає Технічному[HUF8432MS] регламенту радіобладнання; повний текст -декларації про відповідність доступний на веб :сайті за такою адресою Робоча частота: 433,92 ГГц	
Vietnam		 ICT
Belarus		
Zambia		 ZMB/ZICTA/TA/2019/7/121

Argentina



H-23695

* Option/accessory.

[1] Only applies to Indonesia.

9.1.15. Antenna locations for the start and lock systems

An antenna for the keyless starting system and antennas for the keyless locking system* are built into the car.

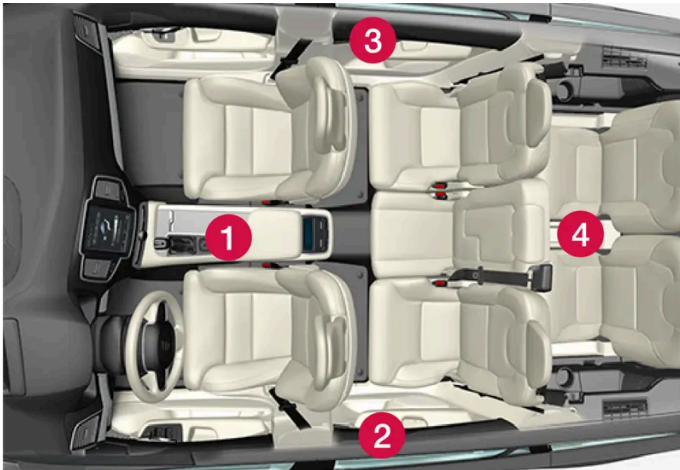

Antenna locations:

- 1 Under the cup holder in the front section of the tunnel console
- 2 In the upper front section of the left-hand rear door^[1]
- 3 In the upper front section of the right-hand rear door^[1]
- 4 In the centre of the rear seat's backrest^[1]

 **Warning**

People with pacemaker operations should not come closer than 22 cm (9 inches) to the keyless system's antennas with their pacemaker. This is to prevent interference between the pacemaker and the keyless system.

* Option/accessory.

^[1] Only in cars equipped with keyless locking and unlocking*.

9.1.16. Ignition positions

The car's electrical system can be set in different levels/positions and in this way make the different functions available.

In order to facilitate the use of a limited number of functions with the engine switched off, the car's electrical system can be set in three different levels – **0**, **I** and **II**. These levels are described with the denomination "ignition position" throughout the owner's manual.

The following table shows the functions available in each ignition position/level:

Level	Functions
0	<ul style="list-style-type: none"> Odometer, clock and temperature gauge are illuminated^[1]. Power* seats can be adjusted. The centre display is started and can be used^[1]. The infotainment system can be used^[1]. <p>In this mode, the functions are controlled by time and are switched off automatically after a short while.</p>
I	<ul style="list-style-type: none"> Panoramic roof, power windows, 12V power socket in the passenger compartment, Bluetooth, navigation, phone, ventilation fan and windscreen wipers can be used. Power seats can be adjusted. 12 V power sockets* in the cargo area can be used. <p>Power is taken from the battery in this ignition position.</p>
II	<ul style="list-style-type: none"> The headlamps come on. Warning/indicator lamps illuminate for 5 seconds. Several other systems are activated. However, heating in seat cushions and the rear window can only be activated after the car has been started. <p>This ignition position consumes a lot of current from the battery and should therefore be avoided!</p>

^[1] Also activated when the door is opened.

* Option/accessory.

9.1.17. Selecting ignition mode

The car's electrical system can be set in different levels/positions and in this way make the different functions available.

Selecting ignition position



Start knob in the tunnel console.

- **Ignition position 0** – Unlock the car and store the remote control key inside the car.

Note

To reach level I or II **without** starting the engine - do **not** depress the brake pedal, or the clutch pedal for cars with manual gear changing, when these ignition positions are to be selected.

- **Ignition position I** – Turn the start knob clockwise and release it. The control automatically returns to its starting position.
- **Ignition position II** – Turn the start knob clockwise and hold it in position for approx. 5 seconds. Then release the knob, which automatically returns to its starting position.
- **Back to ignition position 0** – To return to ignition position 0 from position I and II – Turn the start knob clockwise and release. The control automatically returns to its starting position.

9.2. Locking and unlocking

9.2.1. Keyless locking and unlocking

9.2.1.1. Operating the tailgate with foot movement*

A function which allows the tailgate to open and close by moving a foot under the rear bumper makes life easier when your hands are full.



If the car is equipped with keyless locking and unlocking* then you can unlock the tailgate with a foot movement.

The function with both opening and closing of the tailgate is also available when the car is equipped with power operated tailgate*.

i Note

The foot-operated tailgate function is available in two versions:

- Opening and closing with foot movement
- Only unlocking with foot movement (lift up the tailgate manually to open it)

Note that the function for opening and closing with foot movement requires power operated tailgate*.



The sensor is located on left of centre in the bumper^[1].

One of the car's remote control keys must be within range behind the car, approx. 1 metre (3 feet), for opening and closing to be possible. This also applies to an already unlocked car in order to avoid accidental opening e.g. in a car wash.

Opening and closing with foot movement



Kicking motion within the detector's activation area.

Make **one** forward kicking motion under the left part of the rear bumper. Then take a step back. The bumper must not be touched.

- A short acoustic signal sounds when opening or closing is activated - the tailgate is opened/closed.

If several kicking motions take place without an approved remote control key being located behind the car, opening will not be possible until after a certain delay.

Do not leave your foot positioned under the car during the kicking motion. This could cause activation to fail.

Cancelling opening or closing with foot movement

- 1 Make **one** forward kicking motion while opening or closing is in progress in order to stop the movement of the tailgate.

The remote control key does not have to be in the vicinity of the car to cancel opening or closing of the tailgate.

If the tailgate is stopped close to closed position, the next activation will open the tailgate.

i Note

There is a risk of reduced function, or no function, if the rear bumper is loaded with large amounts of ice, snow, dirt or similar. For this reason, make sure you keep it clean.

i Note

Pay attention to the possibility that the system may be activated in a car wash or similar if the remote key is within range.

Cars with the skid plate* accessory

If the car is equipped with skid plate the sensor is located out on the left-hand corner of the bumper.



To activate opening or closing with a foot movement on a car equipped with skid plate, the kicking motion is made from the side of the car. One of the car's remote control keys must be within range (approx. 1 metre (3 feet)) for opening and closing to be possible.

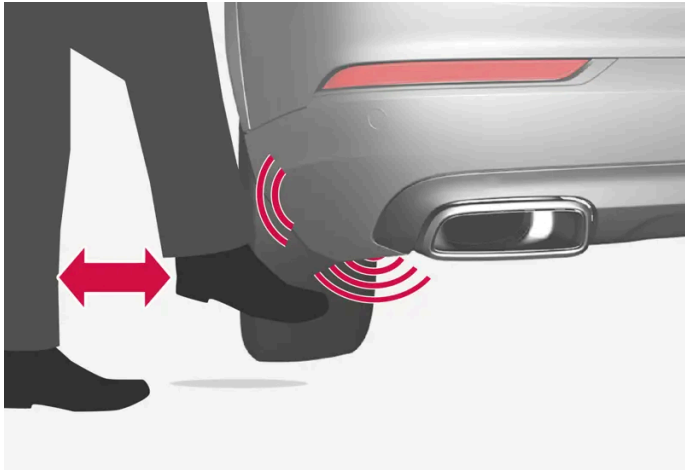

Kicking motion within the detector's valid activation area.

* Option/accessory.

^[1] If the car is equipped with skid plate* the sensor is located out on the left-hand corner of the bumper.

9.2.1.2. Antenna locations for the start and lock systems

An antenna for the keyless starting system and antennas for the keyless locking system* are built into the car.

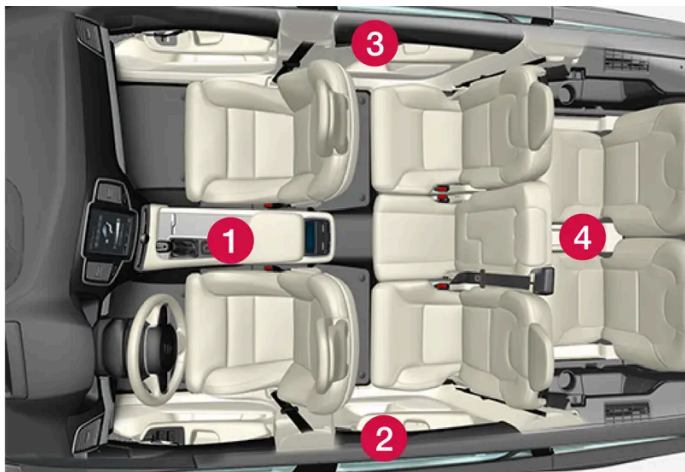

Antenna locations:

- 1 Under the cup holder in the front section of the tunnel console
- 2 In the upper front section of the left-hand rear door^[1]
- 3 In the upper front section of the right-hand rear door^[1]
- 4 In the centre of the rear seat's backrest^[1]

 **Warning**

People with pacemaker operations should not come closer than 22 cm (9 inches) to the keyless system's antennas with their pacemaker. This is to prevent interference between the pacemaker and the keyless system.

* Option/accessory.

[1] Only in cars equipped with keyless locking and unlocking*.

9.2.1.3. Keyless with touch-sensitive surfaces*

With the keyless locking and unlocking function, carrying the remote control key in a pocket or bag will suffice. The car is locked or unlocked via a touch-sensitive surface on the door handle.

Touch-sensitive surfaces

Door handle

The outside of the door handles contains a recess for locking, while the inside contains a touch-sensitive surface for unlocking.

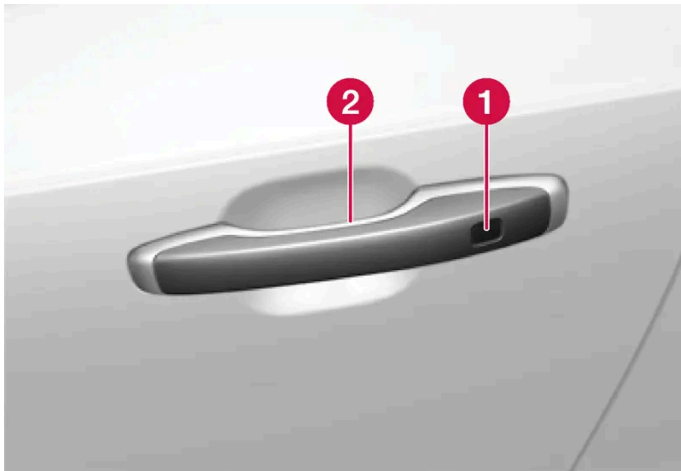

1 Touch-sensitive recess for locking

2 Touch-sensitive surface for unlocking

 **Note**

It is important that only one touch-sensitive surface is activated at a time. Gripping the handle while touching the lock surface risks giving double commands. This means that the requested activity (locking/unlocking) will not be executed, or will be executed with a delay.

Tailgate handle

The tailgate handle has a rubberised pressure plate that is only used for unlocking.



i Note

Be aware that the system may be activated in connection with car washing if the remote control key is in range.

* Option/accessory.

9.2.1.4. Keyless locking and unlocking*

With keyless locking and unlocking, it is sufficient to touch the door handle's touch-sensitive surface to lock or unlock the car.

i Note

One of the car's remote control keys must be within range for locking and unlocking to work.

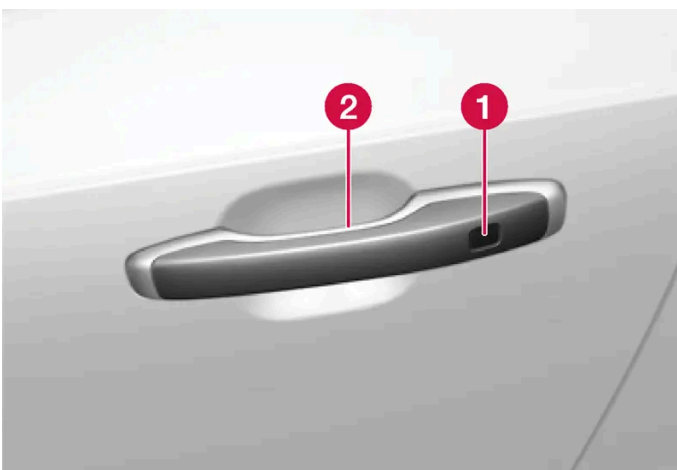

1 Touch-sensitive recess for locking

2 Touch-sensitive surface for unlocking

Note

Be aware that the system may be activated in connection with car washing if the remote control key is in range.

Keyless locking

All side doors must be closed to be able to lock the car. The tailgate, on the other hand, can be open when locking the car with a side door handle.

- 1 Touch the marked surface towards the rear on the outside of a door handle after the door has been closed. Or press the  button on the underside of the tailgate before it closes.
 - The lock indicator on the instrument panel starts to flash to indicate the car is locked.

To close all side windows and the panoramic roof* simultaneously - place a finger against the touch-sensitive recess on the outside of the door handle and hold it there until all of the side windows and the panoramic roof have been closed.

Locking when the tailgate is open

If the car has been locked and the tailgate is still open, make sure that the remote control key is not left in the cargo area when the tailgate is closed.

Note

If the key is detected inside the car, the tailgate will not lock when it is closed.

Keyless unlocking

- 1 Grasp a door handle or gently press the rubberised pressure plate beneath the tailgate handle to unlock the car.

- The lock indicator on the instrument panel stops flashing to indicate that the car is unlocked.



Rubberised pressure plate on the tailgate can only be used for unlocking.

Automatic relocking

If none of the doors or the tailgate is opened within 2 minutes of unlocking, they are locked automatically. This function prevents the car from being left unlocked unintentionally.

* Option/accessory.

9.2.1.5. Settings for Keyless entry*

It is possible to select different sequences for Keyless entry.

To change setting:

- 1 Tap on **Settings** in the centre display's top view.
- 2 Tap on **My Car** → **Locking** → **Keyless Unlock**.
- 3 Select option:
 - **All Doors** - unlocks all doors simultaneously.
 - **Single Door** - unlocks selected door.

* Option/accessory.

9.2.1.6. Closing and locking tailgate with button*

The buttons on the underside of the tailgate can close and lock the car automatically.



Location of the button/buttons on the underside of the tailgate.

! Important

During manual tailgate operation, open or close it slowly. Do not use force to open/close it if there is resistance. It may be damaged and stop working correctly.

Closing^[1]

- 1 Press the  button on the underside of the tailgate.
- > The tailgate closes automatically and remains unlocked.

i Note

- The button is active 24 hours after the hatch has been left open. Thereafter, it must be closed manually.
- If the flap has been open for more than 30 minutes, it will close at a slow speed.

Locking^[2]

- 1 Press the  button on the underside of the tailgate.
- 2 Close the hatch manually.
- > The tailgate and the doors are locked^[3].

Closing and locking^[4]

- 1 Press the  button on the underside of the tailgate.
 - > The tailgate is closed automatically and the car is locked^[3].

Note

- One of the car's remote control keys must be within range for locking and unlocking to work.
- When using keyless* locking or closing, three signals will sound if the key is not detected sufficiently close to the tailgate.

Cancel closing

- Press the button on the instrument panel.
- Press the remote control key's button.
- Press the closing button on the underside of the tailgate^[1].
- Press the rubberised pressure plate beneath the outside handle.
- Using a foot movement*.

The tailgate's movement is interrupted and stops. The tailgate can then be operated manually.

If the tailgate is stopped close to closed position, the next activation will open the tailgate.

Pinch protection

If something with sufficient resistance prevents the tailgate from opening or closing then the pinch protection is activated.

- During opening - movement is interrupted, the tailgate stops and a long acoustic signal sounds.
- During closing - movement is interrupted, the tailgate stops, a long acoustic signal sounds and the tailgate returns to the programmed max. position.

Warning

Watch out for the risk of crushing when opening and closing.

Check that there is nobody near the tailgate before starting to open or close it as a crush injury may have severe consequences.

Always operate the tailgate with caution.

Pre-tensioned springs



The pre-tensioned springs for the power operated tailgate.

Warning

Do not open the pre-tensioned springs for the power operated tailgate. They are pre-tensioned with high pressure and can cause injury if opened.

* Option/accessory.

[1] Applies to cars with power operated boot lid.

[2] Applies to cars with the keyless locking/unlocking option.

[3] All doors must be closed for locking the car.

[4] Applies to cars with keyless locking/unlocking and power operated tailgate.

9.2.1.7. Keyless unlocking of the tailgate *

With keyless locking and unlocking, it is sufficient to press lightly on the rubberized pressure plate on the tailgate handle to unlock.

i Note

One of the car's remote control keys must be within range behind the car for unlocking to work.



The tailgate is held closed by an electrical lock.

To open:

- 1 Press gently on the rubberised pressure plate beneath the tailgate handle.
 - The lock is released.
- 2 Lift by the outside handle in order to open the tailgate.

! Important

- Minimal force is required to release the rear hatch lock - just gently press the rubberised panel.
- Do not place the lift force on the rubber panel when opening the rear hatch - lift the handle. Using too much force may damage the electrical contacts on the rubber panel.

It is also possible to unlock the tailgate hands-free with a foot movement under the rear bumper, see separate section.

! Warning

Do not drive with an open tailgate! Toxic exhaust fumes could be drawn into the car through the cargo area.

* Option/accessory.

9.2.2. Remote control key

The remote control key locks and unlocks the doors and tailgate. The remote control key needs to be inside the car for it to be started.



Remote control key^[1], Care Key or respective key tag (Key Tag)*.

The remote control key is not physically used when starting since the car is equipped with support for keyless starting (Passive Start) as standard. You simply need to have the key in the front part of the passenger compartment.

For cars equipped with keyless locking and unlocking (Passive Entry)* the key can be anywhere in the car to start the car. For cars with Passive Entry, a slightly smaller, lighter and button-less key (Key Tag) can also be purchased as an accessory.

The remote control keys^[2] can be linked to different driver profiles to save personal preferences in the car.

 **Warning**

The remote control key contains a button cell battery. Keep new and used batteries out of the reach of children. If someone swallows a battery it may cause serious injury.

If damage is discovered, e.g. if the battery cover cannot be closed properly, then the product should not be used. Keep defective products out of the reach of children.

Remote control key buttons



The remote control key has four buttons - one on the left-hand side and three on the right-hand side.

 **Locking** - Pressing the button locks the doors, tailgate and fuel filler flap and also arms the alarm*.

Press and hold to close all of the windows and the panoramic roof* simultaneously.

 **Unlocking** - Pressing the button unlocks the doors, tailgate and fuel filler flap and also deactivates the alarm.

A longer press opens all windows simultaneously. This total airing function can be used, for example, to quickly air the car in hot weather.

 **Tailgate** - Unlocks the tailgate only and disarms its alarm. On cars with power operated tailgate*, the tailgate is opened automatically when the button is held depressed. The tailgate is also closed with a long press – acoustic warning signals sound.

 **Panic function** - Used to attract attention in an emergency. Press and hold the button for at least 3 seconds or press it twice within 3 seconds to activate the direction indicators and the horn. The function can be turned off with the same button once it has been active for at least 5 seconds. Otherwise the function switches off automatically after 3 minutes.

 **Warning**

If anyone is left in the car, make sure the power windows and panoramic roof* are de-energised by always taking the remote control key with you when you leave the car.

 **Note**

Be aware of the risk of locking the remote control key in the car.

A remote control key or key tag left in the car will be deactivated when the car is locked and the alarm is armed using another valid key. The "Double lock" function is also deactivated. The key left behind is reactivated when the car is unlocked.

Button-less key (Key Tag)*

A Key Tag can be ordered as an accessory for cars equipped with the keyless locking and unlocking function. A key tag works the same way as the normal remote control key when it comes to keyless starting and locking and unlocking. The key is waterproof to a depth of approx. 10 metres (30 feet) for up to 60 minutes. It has no detachable key blade and the battery cannot be replaced.

Care Key - restricted remote control key

A Care Key allows the car owner to set a limit for the speed of the car. The limitation is intended to encourage the car to be driven in a safe manner, e.g. when being loaned out.

Interference

Remote control key functions for keyless starting and keyless locking and unlocking* can be disrupted by electromagnetic fields and screening.

Note

Avoid storing the remote control key close to metal objects or electronic apparatus, e.g. mobile phones, tablets, laptops or chargers - preferably no closer than 10-15 cm (4-6 inches).

If there is still interference - use the remote control key's detachable key blade to unlock and then place the key in the backup reader in the cup holder to disarm the car and allow the car to be started.

Note

When the remote control key is placed in the cup holder, make sure that no other car keys, metal objects or electronic apparatus (e.g. mobile phones, tablets, laptops or chargers) are in the cup holder. Several car keys close to each other in the cup holder can cause interference with each other.

^[1] The figure is schematic - parts may vary depending on car model.

* Option/accessory.

^[2] Does not apply to Care Key.

9.2.3. Locking and unlocking with the remote control key

The buttons on the remote control key can be used to lock and unlock all doors and the tailgate simultaneously.

Locking with the remote control key



The figure is schematic - parts may vary depending on car model.

- 1 Press the remote control key  button to lock the car.

The driver's door must be closed in order for the lock sequence to be activated^[1]. If any of the other doors or the tailgate is open, then these are not locked and their alarms armed* until they are closed. The alarm's movement detectors* are activated when all the doors and the tailgate are closed and locked.

Note

Be aware of the risk of locking the remote control key in the car.

A remote control key or key tag left in the car will be deactivated when the car is locked and the alarm is armed using another valid key. The "Double lock" function is also deactivated. The key left behind is reactivated when the car is unlocked.

Locking when the tailgate is open

Note

If the car has been locked while the tailgate is open, be careful not to leave the remote control key in the cargo area when the tailgate is closed and the car is completely locked^[2].

Unlocking with the remote control key

- 1 Press the remote control key  button to unlock the car.

Automatic relocking

The content of this manual represents the status of the user manual at the time of printing and may not be completely valid in future instances. For more information, refer to the first page for the complete disclaimer note.

If none of the doors or the tailgate is opened within 2 minutes of unlocking, they are locked automatically. This function prevents the car from being left unlocked unintentionally.

When the remote control key does not work

 **Note**

Always try moving closer to the car and making another unlock attempt.

If it is not possible to lock or unlock with the remote control key, the battery may be discharged - in which case, lock or unlock the driver's door with the detachable key blade.

* Option/accessory.

[1] If the car is equipped with keyless locking/unlocking* then all side doors must be closed.

[2] If the car is equipped with keyless locking/unlocking and the key is detected inside the car, the tailgate will not lock when it is closed.*

9.2.4. Settings for remotely controlled and inside unlocking

It is possible to select different sequences for remotely controlled unlocking.

To change setting:



- 1 Tap on **Settings** in the centre display's top view.
- 2 Press **My Car** → **Locking** → **Remote and Interior Unlock**.
- 3 Select option:
 - **All Doors** - unlocks all doors simultaneously.
 - **Single Door** - unlocks the driver's door. Unlocking all of the doors requires two presses on the remote control key's unlock button.

The settings made here also affect central unlocking via opening handles from the inside.

9.2.5. Unlocking the tailgate with the remote control key

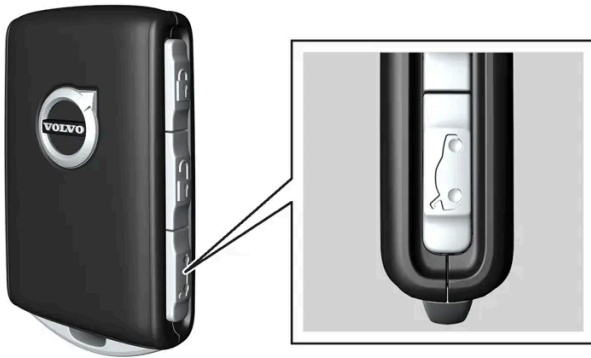
It is possible to unlock just the tailgate by pressing a button on the remote control key.



- 1 Press the remote control key's  button.
 - The tailgate is unlocked but remains closed.
The side doors are still locked and the alarm is armed*. The lock and alarm indicator on the instrument panel extinguishes in order to show that the entire car is not locked.
Lightly grasp the rubberised pressure plate beneath the tailgate handle to open the tailgate. If the tailgate is not opened within 2 minutes then it is relocked and the alarm is re-armed.
- 2 With the power operated tailgate option* -
 - Long press (approx. 1.5 seconds) on the remote control key's  button
 - The tailgate is unlocked and opened, while the side doors remain locked and their alarm functions armed.

* Option/accessory.

9.2.6. Locking and unlocking with the detachable key blade

Amongst other things, the detachable key blade can be used to unlock the car from the outside - e.g. if the remote control key's battery has become discharged.

Unlocking

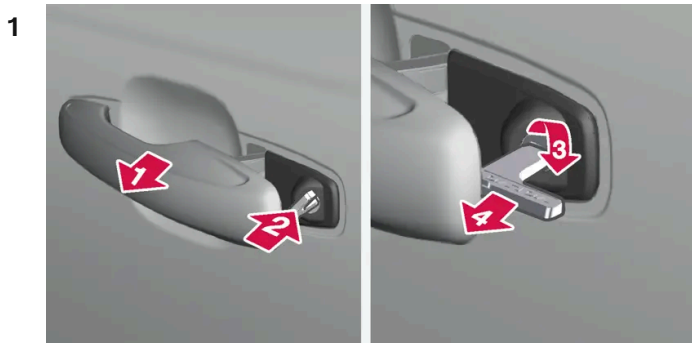

Pull out the front door handle on the left-hand side to its end position so that the lock cylinder becomes visible^[1].



Insert the key in the lock cylinder.



Turn clockwise 45 degrees so that the key blade is pointing straight back.



Turn the key back 45 degrees to its starting position. Remove the key from the lock cylinder and release the handle so that the rear section of the handle is resting against the car again.

5 Pull out the handle.

➤ The door opens.

i Note

When the door is unlocked using the key blade and is then opened, the alarm is triggered. The alarm must be deactivated manually, see separate section.

Locking

The left-hand front door can be locked with its lock cylinder and the detachable key blade.

The other doors have a locking switch at the end that must be pushed in using the key blade – then they are mechanically locked/inhibited from opening from outside.

The doors can still be opened from the inside.

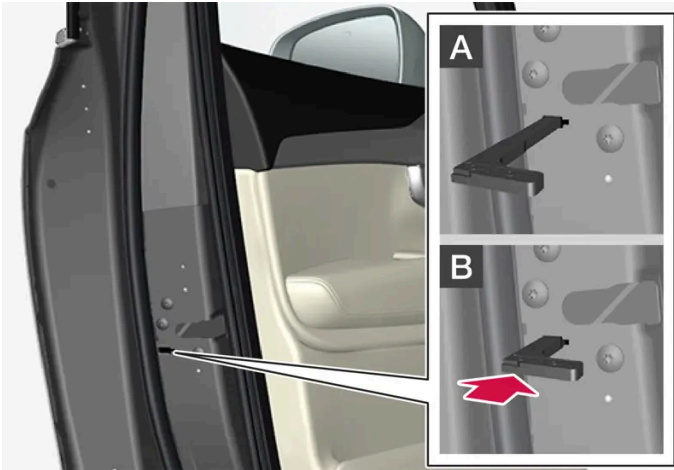

Manual locking of the door. Not to be confused with the child safety lock.

- 1 Remove the detachable key blade from the remote control key.
- 2 Insert the key blade in the hole for lock reset.
- 3 Press in the key until the key bottoms, approximately 12 mm (0.5 inches).

A The door can be opened from both the outside and the inside.

B The door is blocked against opening from the outside. To return to position A, the inner door handle must be opened.

i Note

- A door's lock reset only locks that particular door - not all doors simultaneously.
- A manually locked rear door with child lock activated cannot be opened from inside or outside. The door can then only be unlocked with the key buttons, central locking button, the keyless locking system* or Volvo On Call*.

^[1] This applies whether the car is right-hand drive or left-hand drive.

* Option/accessory.

9.2.7. Automatic locking when driving

The doors and tailgate are locked automatically when the car starts to move.

To change this setting:

The content of this manual represents the status of the user manual at the time of printing and may not be completely valid in future instances. For more information, refer to the first page for the complete disclaimer note.

- 1 Tap on **Settings** in the centre display's top view.
- 2 Press **My Car** → **Locking**.
- 3 Select **Auto Lock Doors While Driving** to deactivate or activate this function.

9.2.8. Double lock*

Double lock means that all opening handles are released mechanically when locking from the outside, which makes it impossible to open the doors from the inside.

Double lock is activated when locking with a remote control key or with keyless locking*, and takes place with a delay of approx. 10 seconds after the doors have locked. If a door is opened within the delay time then the sequence is interrupted and the alarm is deactivated.

The car can only be unlocked with a remote control key, keyless unlocking* or the Volvo Cars app* when double lock is activated.

The front left door can also be unlocked with the detachable key blade. If the car is unlocked with the detachable key blade, the alarm will be triggered.



Warning

Do not lock the car from the outside while there is anyone left in the car.

* Option/accessory.

9.2.9. Setting the max. opening for electrically operated tailgate*

Adjust the max opening of the tailgate, e.g. to make it easier if the car is in a garage with limited space.

To adjust max. opening

- 1 Open the tailgate manually - and stop it in the desired opening position.
 - 2 Press and hold  button on the bottom of the tailgate for approx. 3 seconds.
- Two acoustic signals sound to indicate that the set position has been saved.

i Note

It is not possible to program an opening position lower than half-open tailgate.

Reset max. opening

- 1 Open the tailgate manually to the fully open position.
- 2 Press and hold the * button on the underside of the tailgate for approx. 3 seconds.
 - Two acoustic signals sound to indicate that the set position has been cleared.

i Note

- If the system has been operating continuously for a long time, it is switched off to avoid overload. It can be used again after about 2 minutes.

* Option/accessory.

9.2.10. Locking and unlocking from inside the car

The doors and tailgate can be locked and unlocked from inside using the central locking controls in the front doors.

Central locking



Locking and unlocking button with indicator lamp in the front door.

Unlocking using a button in the front door

- 1 Press the  button to unlock all side doors and the tailgate.

Alternative unlocking method



Opening handle for alternative unlocking in the side door^[1].

- 1 Pull the opening handle on one of the side doors and release.
 - Depending on the settings in the remote control key, either all doors will be unlocked or only the selected door will be unlocked and opened.
To change this setting, tap on **Settings** → **My Car** → **Locking** → **Remote and Interior Unlock** in the centre display's top view.

Locking using a button in the front door

- 1 Press the  button - both front doors must be closed.
 - All doors and the tailgate are locked.

Locking using a button in the rear door*

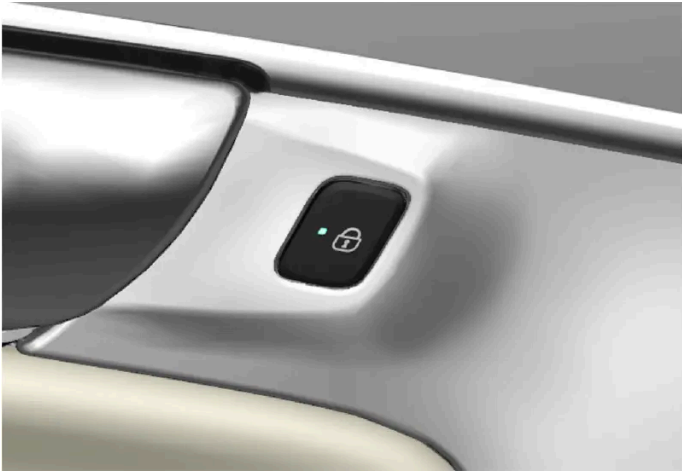

Locking button with indicator lamp in the rear door.

The rear door lock buttons lock their respective rear door.

Unlocking the rear door

- 1 Pull the opening handle.
 - The rear door is unlocked and opened ^[2].

^[1] The figure is schematic - parts may vary depending on car model.

* Option/accessory.

^[2] Provided that the child lock is not activated.

9.2.11. Unlocking the tailgate from the inside of the car

The tailgate can be unlocked from inside by pressing the button on the instrument panel.



- 1 Brief press on the  button on the instrument panel.
 - > The tailgate can be unlocked and opened from the outside by grasping the rubberised pressure plate.

With the power operated tailgate option*:

- 1 Long press on the  button on the instrument panel.
 - > The tailgate is opened.

* Option/accessory.

9.2.12. Private locking

The tailgate and glovebox can be locked with the private locking function which prevents them from being opened, e.g. when the car is taken in for service, left at a hotel or similar.



The private locking function button is located in the centre display function view. Depending on the current status of the lock, **Private Locking Unlocked** or **Private Locking Locked** is shown.

9.2.13. Activating and deactivating private locking

The content of this manual represents the status of the user manual at the time of printing and may not be completely valid in future instances. For more information, refer to the first page for the complete disclaimer note.

Private locking is activated with a function button in the centre display and an optional PIN code.

 **Note**

The car needs to be in ignition mode I as a minimum for the private locking function to be activated.

Private locking has two codes:

- A security code is created the first time the function is used.
- A new PIN code is selected every time the function is activated.

Enter the security code before using for the first time

A security code needs to be selected during the first time the function is used. It can then be used to deactivate private locking if the selected PIN code has been forgotten or lost. The security code acts as a PUK code for all subsequent PIN codes set for the private locking function.

Save the security code in a safe place.

To create a security code:

- 1 Press the button for private locking in the function view.



- > A pop-up window is shown.
- 2 Enter the preferred security code and press **Confirm**.
- > The security code is saved. The private locking function is now ready for activation.

Activate private locking

- 1 Press the button for private locking in the function view.



- > A pop-up window is shown.
- 2 Enter the code to be used in order to unlock the glovebox and tailgate after locking and tap on **Confirm**.
- > The glovebox and the tailgate are locked. Confirmation of locking takes place by means of a green indicator being shown by the button in the function view.

Deactivate private locking

- 1 Press the button for private locking in the function view.



- > A pop-up window is shown.
- 2 Enter the code that was used for locking and tap on **Confirm**.
- > The glovebox and the tailgate are unlocked. Confirmation of unlocking takes place by means of the green indicator by the button in the function view extinguishing.

Forgotten PIN code

If the PIN code has been forgotten or the wrong PIN code has been entered more than three times, the security code can be used to deactivate private locking.

If the car is unlocked via Volvo On Call* or the Volvo Cars app, private locking will be automatically deactivated.

Forgotten security code

If the security code has also been forgotten, contact an authorised Volvo dealer for help with deactivating private locking.

* Option/accessory.

9.2.14. Locking and unlocking

The content of this manual represents the status of the user manual at the time of printing and may not be completely valid in future instances. For more information, refer to the first page for the complete disclaimer note.

The car can be locked and unlocked in several different ways.

The options are:

- using the buttons on the remote control key
- using the detachable key blade (if the battery in the remote control key is exhausted)
- without a key* (Passive Entry), the remote control key must be within range
- from the inside of the car using the locking controls in the doors
- with the Volvo Cars app*
- remote door unlock (RDU) with Volvo On Call*

There are two types of remote control keys to the car.

For cars equipped with keyless locking and unlocking*, a slightly smaller, lighter and button-less key (Key Tag) can be purchased as an accessory.

A Care Key* (restricted remote control key) allows you to enter a limit for the car's maximum speed.

* Option/accessory.

9.2.15. Activating and deactivating child safety locks

The child safety lock prevents the rear doors from being opened from inside. With electric child safety locks, power window operation from the rear seat is also prevented.

The child lock can be either manual or electrical*.

Manual child lock

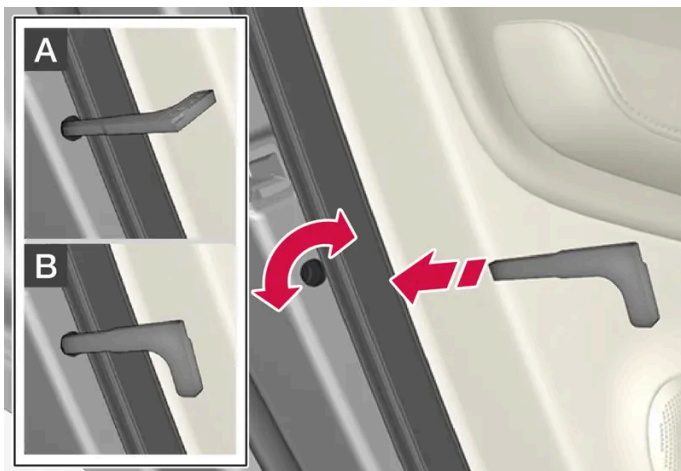

Manual child lock. Not to be confused with manual door locks.

1 Use the remote control key's detachable key blade to turn the knob.

A The door is blocked against opening from the inside.

B The door can be opened from both the outside and the inside.

Note

- A door's knob control only blocks that particular door - not both rear doors simultaneously.
- Cars with an electric child safety lock do not have a manual child lock.

Electric child lock*

The electric child lock can be activated and deactivated in all ignition positions above **0**. Activation and deactivation can be performed up to 2 minutes after switching off the car, provided that no door is opened.



Activation and deactivation button.

Rear child safety lock enabled

When the lamp in the button is illuminated, the child safety lock is enabled.

If the child lock is activated when the car is switched off, it will remain activated the next time the car is started.

- Rear doors cannot be opened from the inside.
- Rear power windows can only be operated from the driver's door.

Rear child safety lock disabled

When the lamp in the button is extinguished, the child safety lock is inactivated.

- Rear doors can be opened from the inside and power windows operated from the rear seat.

Symbols and messages

Symbol	Message	Specification
	Rear child lock Activated	The child lock is activated.
	Rear child lock Deactivated	The child lock is deactivated.

* Option/accessory.

9.2.16. Lock confirmation

The car indicates when the car is locked or unlocked. How the indication is given depends on selected settings for lock indication and settings for door mirrors.

Exterior indication

Locking

- The car's hazard warning flashers indicate locking by flashing and retracting the door mirrors ^[1].

Unlocking

- The car's hazard warning flashers indicate unlocking by two flashes and extending the door mirrors ^[1].

All doors, the tailgate and the bonnet must be closed for the car to indicate that it is locked. If locking takes place with just the driver door closed ^[2], locking will take place but the lock indication with hazard warning flashers will only take place when all doors, the tailgate and the bonnet have been closed.

Lock and alarm indicator on the instrument panel



The lock and alarm indicator shows the status of the locking system:

- A long flash indicates locking.
- Short flashes indicate that the car is locked.

The content of this manual represents the status of the user manual at the time of printing and may not be completely valid in future instances. For more information, refer to the first page for the complete disclaimer note.

- Rapid flashes after disarming the alarm* indicate that the alarm has been triggered.

Indication in lock buttons

Front door



Lock buttons with indicator lamp in the front door.

An illuminated indicator lamp in the lock button of either front door indicates that all doors are locked. If any door is opened, the lamp will extinguish in both doors.

Rear door*



Lock button with indicator lamp in the rear door.

An illuminated indicator lamp in the lock button for one of the doors indicates that the door in question is locked. If any door is unlocked, its lamp will extinguish while the others will continue to illuminate.

Other indication

The home safety light and guidance light functions can also be activated when locking and unlocking.

Retraction/extension of door mirrors can also be used as an aid to indicate locking/unlocking.

[1] Only for cars with retractable power door mirrors.

* Option/accessory.

^[2] Not applicable to with cars equipped with keyless locking/unlocking*.

9.2.17. Lock indication setting

It is possible to select various options for how the car confirms locking and unlocking in the settings menu in the centre display.

To change the locking response setting:

- 1 Tap on **Settings** in the centre display's top view.
- 2 Press **My Car** → **Locking**.
- 3 Press **Visible Locking Feedback** to select when the car is to give a visible response:
 - **Lock**
 - **Unlock**
 - **Both**Or switch off the function by selecting **Off**.

To change the setting for retractable rearview mirrors* when locking:

- 1 Tap on **Settings** in the centre display's top view.
- 2 Press **My Car** → **Mirrors and Convenience**.
- 3 Select **Fold Mirror When Locked** to activate or deactivate the function.

* Option/accessory.

9.3. Alarm

9.3.1. Alarm*

The alarm provides audible and visual warnings if anyone enters the car without a valid remote control key or manipulates the starter battery or alarm siren.

Alarm indicator

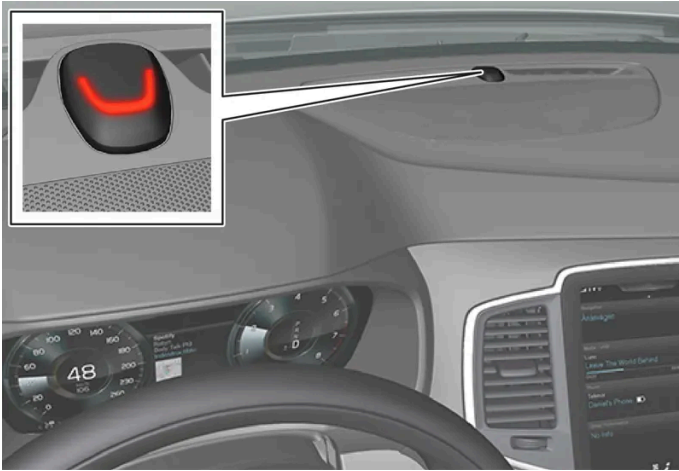

A red LED on the instrument panel indicates the alarm system's status:

- LED not lit – alarm not armed.
- The LED flashes once every other second – alarm is armed.
- After the alarm has been disarmed, the LED flashes rapidly for a maximum of 30 seconds or until ignition position I has been activated - the alarm has been triggered.

When armed, the alarm is triggered if:

- a door, the bonnet or the tailgate is opened^[1]
- a movement is detected in the passenger compartment (if fitted with a movement detector*)
- the car is raised or towed away (if fitted with a tilt detector*)
- the starter battery's cable is disconnected
- the siren is disconnected.

Alarm signals

When the alarm has been triggered, the following happens:

- A siren sounds for 30 seconds or until the alarm is switched off.
- Hazard warning flashers flash for 5 minutes or until the alarm is switched off.

If the cause of alarm activation is not rectified, the alarm cycle is repeated up to 10 times^[1].

Movement and tilt sensors*

Movement and tilt detectors react to movements inside the car^[2] e.g. if the window is broken or if anyone tries to tow the car away.

To avoid triggering the alarm unintentionally:

- Close all windows when leaving the car.
- Close the panoramic roof.
- If the climate control is used – aim the airflow so that it does not point upwards in the passenger compartment.

It is also possible to reduce the alarm level in the centre display.

Symbols and messages

Symbol	Message	Specification
	Alarm system failure Service required	Contact a workshop – an authorised Volvo workshop is recommended.

Note

Do not attempt to repair or alter components in the alarm system yourself. Any such attempts may affect the terms of the insurance.

* Option/accessory.

[1] Applies to certain markets.

[2] Airflows from the climate control are also registered.

9.3.2. Activating and deactivating alarms*

The alarm is activated when the car is locked, and is deactivated when the car is unlocked. It is also possible to deactivate the alarm without a working key.

Activating and deactivating alarms

The alarm is activated when the car is locked, and is deactivated when the car is unlocked.

Note

It is not possible to lock the car without activating the alarm. If the car is parked on a ferry, for example, the function for reduced alarm level should be used instead.

Deactivate the alarm without a functioning remote control key

The car can be unlocked and disarmed even if the remote control key does not work e.g. if the remote control key's battery is dead.

1 Open the driver's door with the detachable key blade.

> The alarm is triggered.



The backup reader's location in the cup holder.

Place the remote control key on the key symbol in the backup reader in the tunnel console's cup holder.

3 Turn the start knob clockwise and release it.

> The alarm is deactivated.

Switching off a triggered alarm

1 Press the remote control key's unlock button or set the car in ignition position I by turning the start knob clockwise and then releasing.

* Option/accessory.

9.3.3. Reduced alarm level*

Reduced alarm level switches off certain types of alarm sensors so that a false alarm is not triggered, e.g. when travelling on a car ferry.

The alarm's movement and tilt detectors are deactivated when reduced alarm level is activated. The alarm then does not react to movement inside the car.

Reduced alarm level is deactivated after each usage and must therefore be reactivated.

Activating reduced alarm level

1 Press the **Reduced Guard** button in the centre display function view.

➤ The function is active until the car is driven, and must therefore be reactivated.

* Option/accessory.

10. Driver support

10.1. Cruise control functions

10.1.1. Cruise control

10.1.1.1. Cruise control

The cruise control (CC^[1]) helps the driver maintain an even speed, which can result in more relaxed driving on motorways and long, straight roads in regular traffic flows.

Using engine braking instead of the foot brake

With Cruise Control, speed is regulated with less frequent application of the foot brake. On a downhill gradient, it may sometimes be desirable to start moving a little faster and instead limit the acceleration by engine braking. In this case the driver can temporarily disable foot brake application by Cruise Control.

To do so, proceed as follows:

- 1 Depress the accelerator pedal about halfway down and release.
 - Cruise Control will disengage its automatic foot braking and then uses engine braking only.

Warning

- The function is supplementary driver support intended to facilitate driving and make it safer – it cannot handle all situations in all traffic, weather and road conditions.
- The driver is advised to read all sections in the Owner's Manual that relate to this function to learn about factors such as its limitations and what the driver should be aware of before using the system.
- Driver support functions are not a substitute for the driver's attention and judgement. The driver is always responsible for ensuring the car is driven in a safe manner, at the appropriate speed, with an appropriate distance to other vehicles, and in accordance with current traffic rules and regulations.

^[1] Cruise Control

10.1.1.2. Standby mode for cruise control

Cruise control (CC^[1]) can be deactivated and set in standby mode. This can take place automatically or be done by the driver.

Standby mode means that the function is selected in the driver display but not activated. The symbol in the driver display is extinguished and cruise control does not then regulate the speed.

Standby mode on driver intervention

Cruise control is deactivated and set to standby mode if any of the following occur:

- The foot brake is used.
- The gear selector is moved to **N** position.
- The driver maintains a speed higher than the stored speed for longer than 1 minute.

The driver must then control the speed himself/herself.

A temporary increase in speed with the accelerator pedal, e.g. during overtaking, does not affect the setting - the car returns to the last stored speed when the accelerator pedal is released.

Automatic standby mode

Activation of automatic standby mode can be due to one of the following:

- The wheels are losing traction.
- The engine speed is too low/high.
- Brake temperature is too high.
- Speed falls below 30 km/h (20 mph).

The driver must then control the speed himself/herself.

^[1] Cruise Control

10.1.1.3. Setting the stored speed for cruise control functions

It is possible to set stored speed for the speed limiter, cruise control, adaptive cruise control* and Pilot Assist* functions.

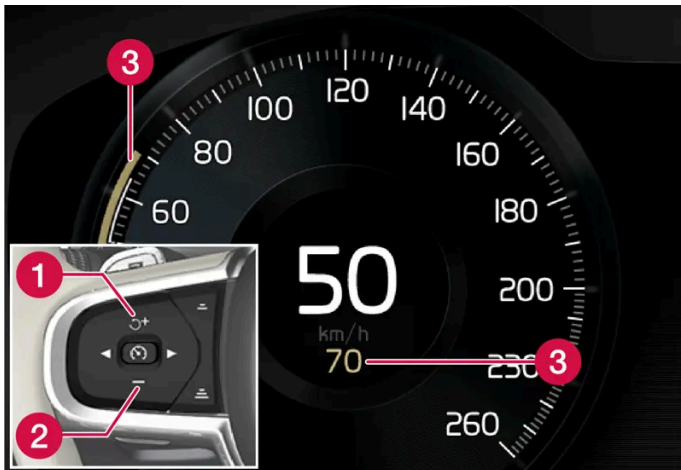

- 1 + : Increases the stored speed
- 2 - : Reduces stored speed
- 3 Stored speed

- 1 Change a set speed with short presses on the steering wheel buttons + (1) or - (2) or by pressing and holding them.
 - **Short** presses: Each press changes the speed in increments of +/- 5 km/h (+/- 5 mph).
 - **Press and hold**: Release the button when the speed indicator (3) has moved to the desired speed.
- The speed set after the last button press is stored in the memory.

Effect of the accelerator pedal

If the driver increases the car's speed using the accelerator pedal before pressing the steering wheel button + (1), the speed stored will be the car's speed when the button is depressed, provided the driver's foot is on the accelerator pedal at the moment when the button is depressed.

A temporary increase in speed with the accelerator pedal, e.g. during overtaking, does not affect the setting - the car returns to the last stored speed when the accelerator pedal is released.

Possible speed

Automatic gearbox

The driver support functions can follow another vehicle at speeds from 0 km/h up to 200 km/h (125 mph).

Pilot Assist can give steering assistance from almost stationary up to 140 km/h (87 mph).

Note that the lowest programmable speed is 30 km/h (20 mph) – even though it is capable of following another vehicle down to 0 km/h, a speed lower than 30 km/h (20 mph) cannot be selected/stored.

* Option/accessory.

10.1.2. Adaptive cruise control

10.1.2.1. Adaptive cruise control*

The adaptive cruise control^[1] (ACC^[2]) can help the driver to maintain a constant speed, combined with a preselected time interval to the vehicle ahead.

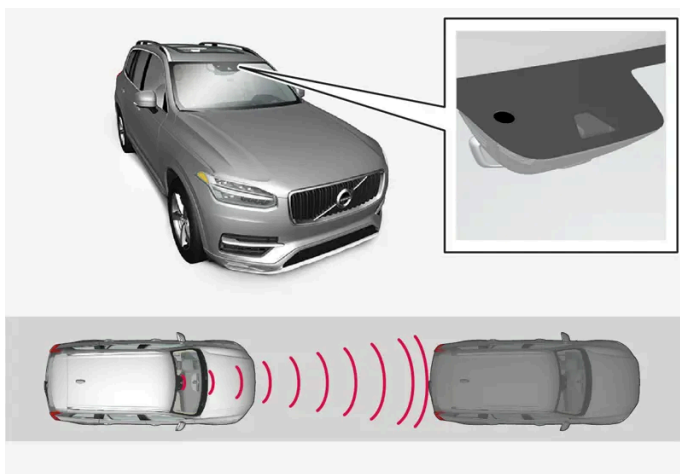

The camera and radar unit measures the distance to the vehicle ahead.

An adaptive cruise control can provide a more relaxing driving experience on long journeys on motorways and long straight main roads in smooth traffic flows.

The driver selects the desired speed and a time interval to the vehicle ahead. If the camera and radar unit detects a slower vehicle in front of the car, the speed is adapted automatically via the preset time interval to the vehicle ahead. When the road is clear again the car returns to the selected speed.

If the cornering support* function is activated, this may also affect the speed of the car.

The adaptive cruise control aims to:

- regulate the speed smoothly. In situations that demand sudden braking the driver must brake himself/herself. This applies in cases of large speed differences or if the vehicle in front brakes suddenly. Due to the limitations of the radar unit, braking may come unexpectedly or not at all.
- follow the vehicle ahead in the same lane at a time interval set by the driver. If the radar unit cannot see any vehicle in front then the car will instead maintain the speed stored by the driver. This also takes place if the speed of the vehicle ahead increases and exceeds the stored speed.

Steep roads and/or heavy load

Bear in mind that the adaptive cruise control is primarily intended for use when driving on level road surfaces. The function may have difficulty in keeping the correct distance from the vehicle ahead when driving on steep downhill slopes – in which case, be extra attentive and ready to brake.

Do not use adaptive cruise control if the car has a heavy load or a trailer is connected to the car.

 **Warning**

- This is not a collision avoidance system. The driver is always responsible and must intervene if the system does not detect a vehicle ahead.
- The function does not brake for humans or animals, and not for small vehicles such as bicycles and motorcycles. Nor for low trailers, oncoming, slow or stationary vehicles and objects.
- Do not use the function in demanding situations, such as in city traffic, at junctions, on slippery surfaces, with a lot of water or slush on the road, in heavy rain/snow, in poor visibility, on winding roads or on slip roads.

 **Warning**

- The function is supplementary driver support intended to facilitate driving and make it safer – it cannot handle all situations in all traffic, weather and road conditions.
- The driver is advised to read all sections in the Owner's Manual that relate to this function to learn about factors such as its limitations and what the driver should be aware of before using the system.
- Driver support functions are not a substitute for the driver's attention and judgement. The driver is always responsible for ensuring the car is driven in a safe manner, at the appropriate speed, with an appropriate distance to other vehicles, and in accordance with current traffic rules and regulations.

 **Note**

This function uses the car's camera and radar units, which have certain general limitations.

 **Important**

Maintenance of driver support components must only be performed at a workshop – an authorised Volvo workshop is recommended.

* Option/accessory.





[1] This function can be either standard or optional, depending on market.

[2] Adaptive Cruise Control

10.1.2.2. Symbols and messages for adaptive cruise control*

The content of this manual represents the status of the user manual at the time of printing and may not be completely valid in future instances. For more information, refer to the first page for the complete disclaimer note.

A number of symbols and messages regarding the adaptive cruise control^[1] (ACC^[2]) can be shown. Here are some examples.

Symbol	Message	Specification
	The symbol is lit	The car is maintaining the stored speed.
	Adaptive Cruise Contr. Unavailable The symbol is extinguished	Adaptive cruise control is set to standby mode.
	Adaptive Cruise Contr. Service required The symbol is extinguished	The system does not function as it should. A workshop should be contacted - an authorised Volvo workshop is recommended.
	Windscreen sensor Sensor blocked, see Owner's manual	Clean the windscreen in front of the camera and radar unit's detectors.

A text message can be cleared by briefly pressing the  button, located in the centre of the steering wheel's right-hand keypad.

If a message remains, contact a workshop - an authorised Volvo workshop is recommended.

* Option/accessory.

^[1] This function can be either standard or optional, depending on market.

^[2] Adaptive Cruise Control

10.1.2.3. Standby mode for adaptive cruise control*

Adaptive cruise control^[1] (ACC^[2]) can be deactivated and set to standby mode. This can take place automatically or be done by the driver.

Standby mode means that the function is selected in the driver display but not activated. Adaptive cruise control does not then regulate the speed or distance to the vehicle in front.

Standby mode on driver intervention

The adaptive cruise control is deactivated and set in standby mode if any of the following occurs:

- The foot brake is used.
- The gear selector is moved to **N** position.
- The driver maintains a speed higher than the stored speed for longer than 1 minute.

A temporary increase in speed with the accelerator pedal, e.g. during overtaking, does not affect the setting - the car returns to the last stored speed when the accelerator pedal is released.

 **Warning**

- With the adaptive cruise control is in standby mode, the driver must intervene and regulate both speed and distance to the vehicle ahead.
- When the adaptive cruise control is in standby mode and the car comes too close to a vehicle ahead, the driver may be warned of the short distance by the Distance Warning* function instead.

Automatic standby mode

 **Warning**

With automatic standby mode, the driver is warned via an acoustic signal and a message in the driver display.

- The driver must then regulate the car's speed, apply the brakes as needed and maintain a safe distance to other vehicles.

Automatic standby mode may be engaged in the event of one of the following:

- One of the systems that Adaptive cruise control is dependent on stops working, e.g. stability control / anti-skid (ESC^[3]).
- The driver opens the door.
- The driver takes off the seatbelt.
- The engine speed is too low/high.
- One or more wheels lose traction.
- The brake temperature is high.
- The parking brake is applied.
- The camera and radar unit is covered by e.g. snow or heavy rainfall (camera lens/radio waves are blocked).
- The speed is below 5 km/h (3 mph) and ACC is uncertain whether the vehicle ahead is a stationary vehicle or an object, such as a speed bump.
- The speed is below 5 km/h (3 mph) and the vehicle ahead turns off so that ACC no longer has a vehicle to follow.

* Option/accessory.

^[1] This function can be either standard or optional, depending on market.

^[2] Adaptive Cruise Control

^[3] Electronic Stability Control

10.1.2.4. Automatic braking with cruise control functions

The driver supports of adaptive cruise control* and Pilot Assist* have a special brake function in slow traffic and while stationary. In certain situations, the parking brake is applied in order to keep the car stationary.

Brake function in slow queues and while stationary

The content of this manual represents the status of the user manual at the time of printing and may not be completely valid in future instances. For more information, refer to the first page for the complete disclaimer note.

For shorter stops in connection with creep mode in slow traffic or at traffic lights, driving is automatically resumed if the stops do not exceed approx. 3 seconds - if it takes longer before the vehicle in front starts moving again then the driver support function is set in standby mode with automatic braking.

1 The function is reactivated in one of the following ways:

- Press the steering wheel button .
- Depress the accelerator pedal.

> The function resumes following the vehicle ahead if it starts moving forward within approx. 6 seconds.

 **Warning**

A significant increase in speed may follow when the speed is resumed with the  steering wheel button.

 **Warning**

Driver supports only warn of obstacles which their radar unit has detected – hence a warning may not be given, or it may be given with a certain delay.

- Never wait for a warning or intervention. Apply the brakes when the situation requires.

 **Note**

The driver supports can hold the car stationary for a maximum of 5 minutes – then the parking brake is applied and the function is disengaged.

Before the driver supports can be reactivated, the parking brake must be released.

Cessation of automatic braking

In some situations, automatic braking ceases on coming to a standstill and the function is set in standby mode. This means that the brakes are released and the car may start to roll - the driver must therefore intervene and brake the car himself/herself to keep it stationary.

This may take place in any of the following situations:

- The driver puts his/her foot on the brake pedal.
- The parking brake is applied.
- The gear selector is moved to P, N, or R position.
- The driver sets the adaptive cruise control or Pilot Assist to standby mode.

Automatic activation of parking brake

The Parking brake is applied if the function is holding the car stationary with the foot brake and:

- The driver opens the door or takes off his/her seatbelt.
- The function has kept the car stationary for more than approx. 5 minutes.
- The brakes have overheated.
- The driver switches the engine off.

* Option/accessory.

10.1.2.5. Setting the stored speed for cruise control functions

It is possible to set stored speed for the speed limiter, cruise control, adaptive cruise control* and Pilot Assist* functions.

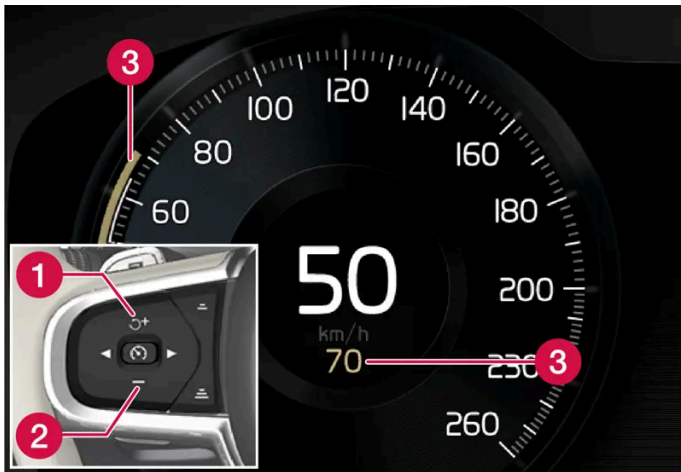

- 1 + : Increases the stored speed
- 2 - : Reduces stored speed
- 3 Stored speed

- 1 Change a set speed with short presses on the steering wheel buttons + (1) or - (2) or by pressing and holding them.
 - **Short** presses: Each press changes the speed in increments of +/- 5 km/h (+/- 5 mph).
 - **Press and hold**: Release the button when the speed indicator (3) has moved to the desired speed.
- > The speed set after the last button press is stored in the memory.

Effect of the accelerator pedal

If the driver increases the car's speed using the accelerator pedal before pressing the steering wheel button + (1), the speed stored will be the car's speed when the button is depressed, provided the driver's foot is on the accelerator pedal at the moment when the button is depressed.

The content of this manual represents the status of the user manual at the time of printing and may not be completely valid in future instances. For more information, refer to the first page for the complete disclaimer note.

A temporary increase in speed with the accelerator pedal, e.g. during overtaking, does not affect the setting - the car returns to the last stored speed when the accelerator pedal is released.

Possible speed

Automatic gearbox

The driver support functions can follow another vehicle at speeds from 0 km/h up to 200 km/h (125 mph).

Pilot Assist can give steering assistance from almost stationary up to 140 km/h (87 mph).

Note that the lowest programmable speed is 30 km/h (20 mph) – even though it is capable of following another vehicle down to 0 km/h, a speed lower than 30 km/h (20 mph) cannot be selected/stored.

* Option/accessory.

10.1.2.6. Change of target with cruise control functions

The driver supports of adaptive cruise control* and Pilot Assist*, in combination with automatic transmission, have a change of target function at certain speeds.

Change of target

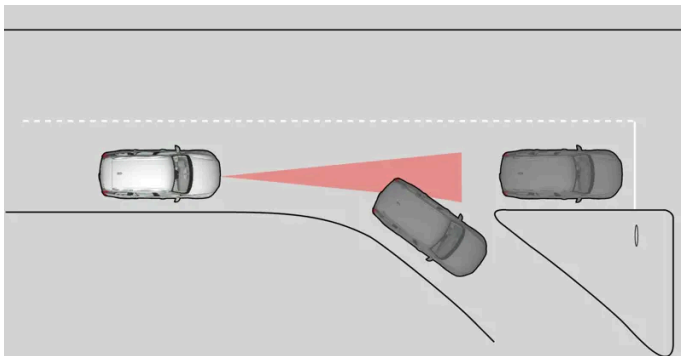

If the target vehicle in front suddenly turns then there may be stationary traffic in front.

When the driver supports are following another vehicle at speeds **below** 30 km/h (20 mph) and changes target vehicle – from a moving vehicle to a stationary vehicle – the driver supports will slow down for the stationary vehicle.

Warning

When the driver supports are following another vehicle at speeds **in excess of** approx. 30 km/h (20 mph) and the target is changed from a moving vehicle to a stationary vehicle, the driver supports will **ignore** the stationary vehicle and instead accelerate to the stored speed.

- The driver must then intervene him/herself and brake.

Automatic standby mode with change of target

The content of this manual represents the status of the user manual at the time of printing and may not be completely valid in future instances. For more information, refer to the first page for the complete disclaimer note.

The driver supports are disengaged and set in standby mode:

- when the speed is below 5 km/h ((3 mph)) and the driver supports are uncertain whether the target object is a stationary vehicle or another object, such as a speed bump.
- when the speed is below 5 km/h ((3 mph)) and the vehicle ahead turns off so that the driver supports no longer have a vehicle to follow.

* Option/accessory.

10.1.2.7. Setting time interval to vehicle ahead

It is possible to set the time interval to the vehicle ahead to be maintained by the adaptive cruise control*, Pilot Assist* and Distance Warning* functions.

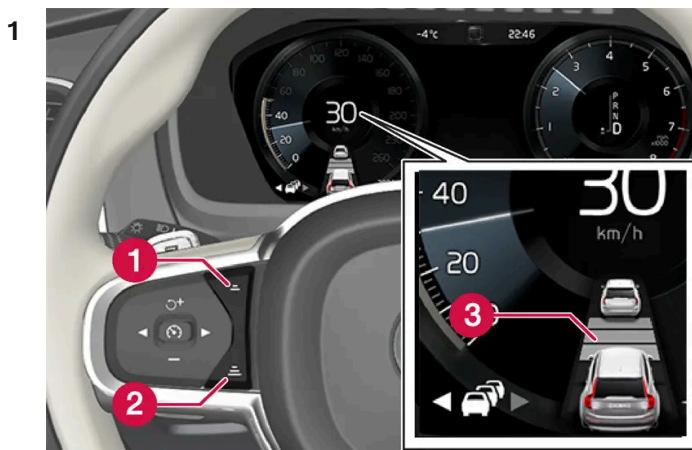

Control for time interval.

- 1 Decrease time interval
- 2 Increase time interval
- 3 Distance indicator

Press the steering wheel button (1) or (2) to increase or decrease the time interval.

- The distance indicator (3) shows the current time interval.

Different time intervals to the vehicle in front can be selected and shown in the driver display as 1-5 horizontal lines - the more lines the longer the time interval. One line represents about 1 second to the vehicle in front, 5 lines represents about 3 seconds.

The adaptive cruise control allows the time interval to vary significantly in certain situations in order to allow the car to follow the vehicle in front smoothly and comfortably. At low speed, when the distances are short, the adaptive cruise control increases the time interval slightly.

 **Note**

When the symbol in the driver display shows a car and a steering wheel, Pilot Assist follows a vehicle in front at a preset time gap.

When only one steering wheel is shown, there is no vehicle within a reasonable distance ahead.

 **Note**

When the symbol in the driver display shows two cars, adaptive cruise control is following the vehicle in front at a pre-set time interval.

When only one car is shown, there is no vehicle within a reasonable distance ahead.

 **Note**

- The higher the speed the longer the calculated distance in metres for a given time interval.
- Only use the time intervals permitted by local traffic regulations.
- If the driver supports do not seem to respond with a speed increase when activated, it may be because the time window to the vehicle ahead is shorter than the set time window.

 **Warning**

- Only use a time window that suits the current traffic conditions.
- The driver should be aware that short time windows limit the amount of time available to react and take action in an unexpected traffic situation.

* Option/accessory.

10.1.2.8. Warning from cruise control functions in the event of a collision risk

The driver support systems of adaptive cruise control* and Pilot Assist* can warn the driver if the distance to the vehicle ahead suddenly becomes too short.

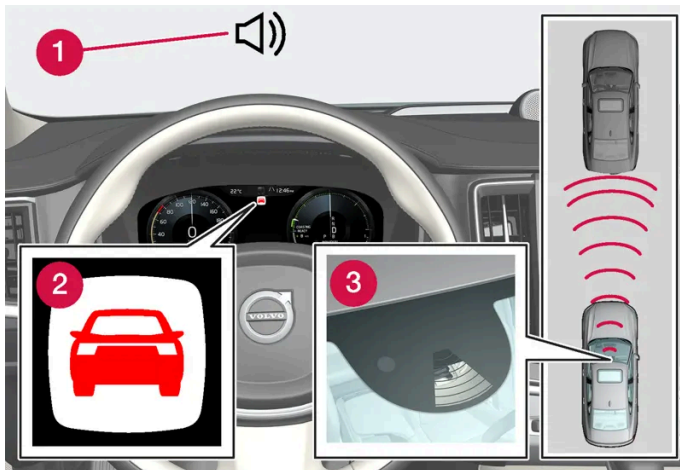

Audio and symbol for collision warning

- 1 Acoustic signal in the event of a risk of collision
- 2 Warning signal in the event of a risk of collision
- 3 Distance measurement with the camera and radar units

Adaptive cruise control and Pilot Assist use approx. 40% of the capacity of the foot brake. If the car needs to be braked more heavily than the driver support is capable of and the driver does not brake, the warning lamp and acoustic warning are activated to alert the driver that immediate intervention is required.

 **Warning**

The driver support systems only warn of vehicles which their radar unit has detected – hence a warning may not be given, or it may be given with a certain delay. Never wait for a warning. Apply the brakes when the situation requires.



Symbol for collision warning on the windscreen

In cars equipped with a head up display*, the warning is shown on the windscreen by a flashing symbol.

 **Note**

Strong sunlight, reflections, extreme light contrasts, the use of sunglasses, or if the driver is not looking straight ahead may make the visual warning signal in the windscreen difficult to recognise.

* Option/accessory.

10.1.3. Pilot Assist

10.1.3.1. Automatic braking with cruise control functions

The driver supports of adaptive cruise control* and Pilot Assist* have a special brake function in slow traffic and while stationary. In certain situations, the parking brake is applied in order to keep the car stationary.

Brake function in slow queues and while stationary

For shorter stops in connection with creep mode in slow traffic or at traffic lights, driving is automatically resumed if the stops do not exceed approx. 3 seconds - if it takes longer before the vehicle in front starts moving again then the driver support function is set in standby mode with automatic braking.

- 1 The function is reactivated in one of the following ways:
 - Press the steering wheel button .
 - Depress the accelerator pedal.
- The function resumes following the vehicle ahead if it starts moving forward within approx. 6 seconds.

 **Warning**

A significant increase in speed may follow when the speed is resumed with the  steering wheel button.

 **Warning**

Driver supports only warn of obstacles which their radar unit has detected – hence a warning may not be given, or it may be given with a certain delay.

- Never wait for a warning or intervention. Apply the brakes when the situation requires.

 **Note**

The driver supports can hold the car stationary for a maximum of 5 minutes – then the parking brake is applied and the function is disengaged.

Before the driver supports can be reactivated, the parking brake must be released.

Cessation of automatic braking

In some situations, automatic braking ceases on coming to a standstill and the function is set in standby mode. This means that the brakes are released and the car may start to roll - the driver must therefore intervene and brake the car himself/herself to keep it stationary.

This may take place in any of the following situations:

- The driver puts his/her foot on the brake pedal.
- The parking brake is applied.
- The gear selector is moved to P, N, or R position.
- The driver sets the adaptive cruise control or Pilot Assist to standby mode.

Automatic activation of parking brake

The Parking brake is applied if the function is holding the car stationary with the foot brake and:

- The driver opens the door or takes off his/her seatbelt.
- The function has kept the car stationary for more than approx. 5 minutes.
- The brakes have overheated.
- The driver switches the engine off.

* Option/accessory.

10.1.3.2. Setting the stored speed for cruise control functions

It is possible to set stored speed for the speed limiter, cruise control, adaptive cruise control* and Pilot Assist* functions.

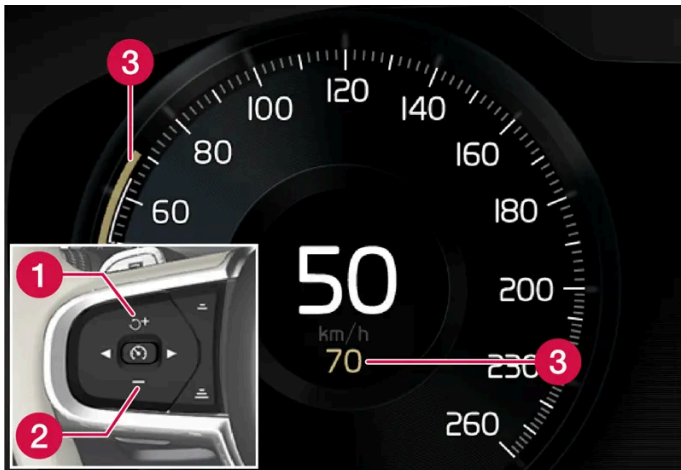

- 1 + : Increases the stored speed
- 2 - : Reduces stored speed
- 3 Stored speed

- 1 Change a set speed with short presses on the steering wheel buttons + (1) or - (2) or by pressing and holding them.
 - **Short** presses: Each press changes the speed in increments of +/- 5 km/h (+/- 5 mph).
 - **Press and hold**: Release the button when the speed indicator (3) has moved to the desired speed.
- The speed set after the last button press is stored in the memory.

Effect of the accelerator pedal

If the driver increases the car's speed using the accelerator pedal before pressing the steering wheel button + (1), the speed stored will be the car's speed when the button is depressed, provided the driver's foot is on the accelerator pedal at the moment when the button is depressed.

A temporary increase in speed with the accelerator pedal, e.g. during overtaking, does not affect the setting - the car returns to the last stored speed when the accelerator pedal is released.

Possible speed

Automatic gearbox

The driver support functions can follow another vehicle at speeds from 0 km/h up to 200 km/h (125 mph).

Pilot Assist can give steering assistance from almost stationary up to 140 km/h (87 mph).

Note that the lowest programmable speed is 30 km/h (20 mph) – even though it is capable of following another vehicle down to 0 km/h, a speed lower than 30 km/h (20 mph) cannot be selected/stored.

* Option/accessory.

10.1.3.3. Change of target with cruise control functions

The driver supports of adaptive cruise control* and Pilot Assist*, in combination with automatic transmission, have a change of target function at certain speeds.

Change of target

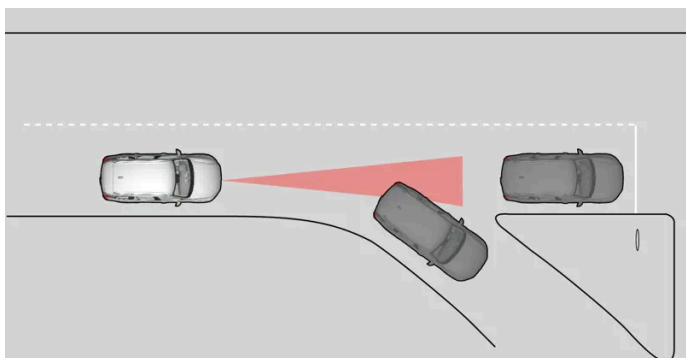

If the target vehicle in front suddenly turns then there may be stationary traffic in front.

When the driver supports are following another vehicle at speeds **below** 30 km/h (20 mph) and changes target vehicle – from a moving vehicle to a stationary vehicle – the driver supports will slow down for the stationary vehicle.

Warning

When the driver supports are following another vehicle at speeds **in excess of** approx. 30 km/h (20 mph) and the target is changed from a moving vehicle to a stationary vehicle, the driver supports will **ignore** the stationary vehicle and instead accelerate to the stored speed.

- The driver must then intervene him/herself and brake.

Automatic standby mode with change of target

The driver supports are disengaged and set in standby mode:

- when the speed is below 5 km/h ((3 mph)) and the driver supports are uncertain whether the target object is a stationary vehicle or another object, such as a speed bump.
- when the speed is below 5 km/h ((3 mph)) and the vehicle ahead turns off so that the driver supports no longer have a vehicle to follow.

* Option/accessory.

10.1.3.4. Pilot Assist*

Pilot Assist^[1] can help the driver to drive the car between the lane's lane markings as well as to maintain a constant speed, combined with a preselected time interval to the vehicle ahead.

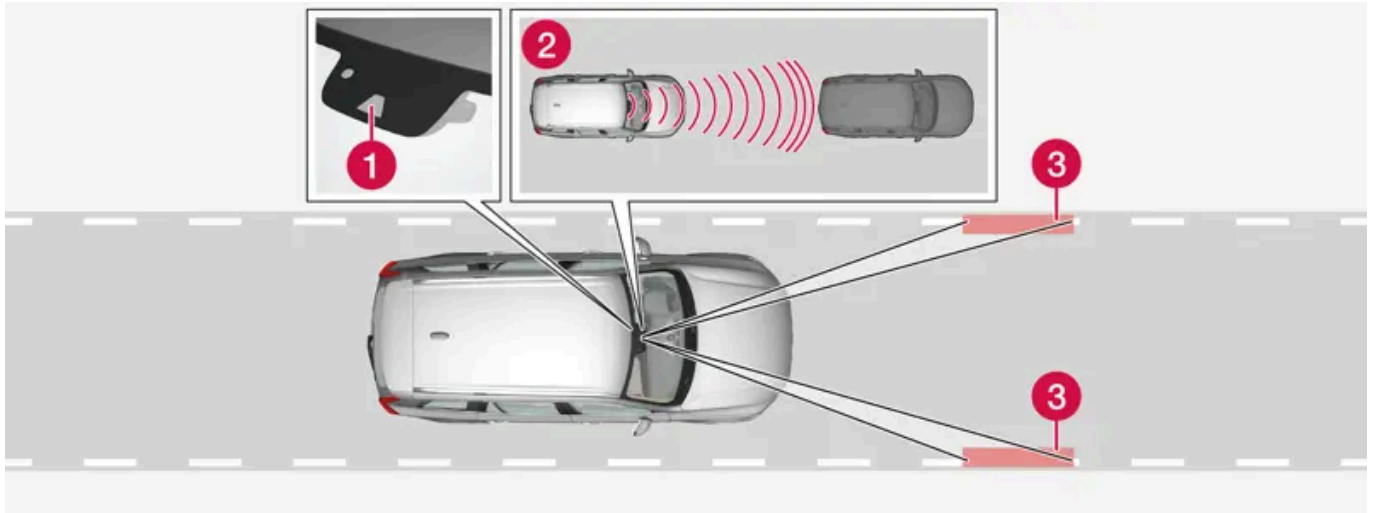

The camera and radar unit measures the distance to the vehicle ahead and detects side markings.

- 1 Camera and radar unit
- 2 Distance readers
- 3 Readers, side markings

Get to know Pilot Assist

Pilot Assist helps to control your car and you may need to drive a few kilometres with Pilot Assist before you feel completely at home with the function. It is important to know about all of the function's applications and limitations in order to safely use all of the advantages.

The Pilot Assist function is primarily intended for use on motorways and similar major roads where it can contribute to more comfortable driving and a more relaxed driving experience.

The driver selects the desired speed and a time interval to the vehicle ahead. Pilot Assist scans the distance to the vehicle ahead and the lane's side markings on the road surface using the camera unit. The preset time interval is maintained with automatic speed adjustment whilst the steering assistance helps to position the car in the lane.

If the cornering support* function is activated, this may also affect the speed of the car.

Pilot Assist regulates the speed with acceleration and braking. It is normal for the brakes to emit a low sound when they are being used to adjust the speed.

Pilot Assist strives to:

- regulate the speed smoothly. In situations that demand sudden braking the driver must brake himself/herself. This applies in cases of large speed differences or if the car in front brakes suddenly. Due to the limitations of the camera and radar unit, braking may come unexpectedly or not at all.
- follow the vehicle ahead in the same lane at a time interval set by the driver. If the radar unit cannot see any vehicle in front then the car will instead maintain the speed set and stored by the driver. This also takes place if the speed of the vehicle ahead increases and exceeds the stored speed.

Position of the car in the lane

When Pilot Assist helps to steer, it attempts to place the car halfway between the visible lane markings. For a smoother drive, it is a good idea to allow the car to find a good position. The driver can always adjust the position him/herself by increasing the steering input. It is important that the driver checks to make sure the car is positioned safely in the lane.

If Pilot Assist does not position the car in an appropriate way in the lane, it is recommended to turn Pilot Assist off or switch to adaptive cruise control*.

Steering assistance



The current status of steering assistance is indicated by the colour of the steering wheel's symbol:

- Steering wheel lit up indicates active steering assistance
- Steering wheel extinguished (as in illustration) indicates deactivated steering assistance.

Pilot Assist steering assistance takes into account the speed of the preceding car and the lane markings. The driver can at any time adjust steering interventions from Pilot Assist and steer in another direction, e.g. to change lane or avoid an obstruction on the road. Resistance is then felt in the steering wheel as long as the steering assistance is active.

Temporary disabling of steering assistance



Warning

Pilot Assist steering assistance is automatically deactivated and is resumed without prior warning.

When the direction indicators are used, Pilot Assist steering assistance is temporarily disengaged. When the direction indicator is switched off, steering assistance is reactivated automatically if the lane's edge markings can still be detected.

If Pilot Assist is unable to interpret the lane clearly, e.g. if the camera unit does not see the lane's edge markings, Pilot Assist shuts off steering assistance temporarily. Speed and distance regulating functions remain active. Steering assistance is resumed when the lane can be interpreted again. In these situations, slight vibration in the steering wheel may alert the driver to the fact that steering assistance has been deactivated temporarily.

Round bends and when the road splits

Pilot Assist interacts with the driver, who should therefore not wait for the steering assistance from Pilot Assist but should always be prepared to increase his/her own steering input, especially in bends.

When the car approaches an exit or if the lane splits, the driver should steer towards the desired lane so that Pilot Assist can detect the desired direction.

Hands on the steering wheel



In order for Pilot Assist to function, the driver's hands must be on the steering wheel. It is also important for the driver always to carry on being active and alert when driving as Pilot Assist is unable to read all situations and the function may toggle between off and on without prior warning.

 **Warning**

Do not wait for all levels of warning and assistance from the systems, but act immediately if any warning signal is triggered.

1. If Pilot Assist detects that the driver does not keep his/her hands on the steering wheel, the system gives a warning with a symbol and text message in the driver display in order to prompt the driver to actively steer the car.
2. If the driver's hands still cannot be detected on the steering wheel after a few seconds the prompt to actively steer the car is repeated supplemented by an acoustic signal.
3. If Pilot Assist does not detect the driver's hands on the steering wheel after a further few seconds then the function is switched off. Following this, Pilot Assist must be restarted using the  steering wheel button. After being switched off, the function continues to use acoustic and visual warning signals for up to 5 seconds.

Steep roads and/or heavy load

Bear in mind that Pilot Assist is primarily intended for use when driving on level road surfaces. The function may have difficulty in keeping the correct distance from the vehicle ahead when driving on steep downhill slopes – in which case, be extra attentive and ready to brake.

Do not use Pilot Assist if the car has a heavy load or a trailer is connected to the car.

 **Note**

Pilot Assist cannot be activated if a trailer, bicycle rack or similar is connected to the car's electrical system.

Read all warnings before use

 **Warning**

- The function is supplementary driver support intended to facilitate driving and make it safer – it cannot handle all situations in all traffic, weather and road conditions.
- The driver is advised to read all sections in the Owner's Manual that relate to this function to learn about factors such as its limitations and what the driver should be aware of before using the system.
- Driver support functions are not a substitute for the driver's attention and judgement. The driver is always responsible for ensuring the car is driven in a safe manner, at the appropriate speed, with an appropriate distance to other vehicles, and in accordance with current traffic rules and regulations.

 **Note**

This function uses the car's camera and radar units, which have certain general limitations.

 **Important**

Maintenance of driver support components must only be performed at a workshop – an authorised Volvo workshop is recommended.

 **Warning**

In certain situations, Pilot Assist steering assistance may have difficulty helping the driver in the right way or it may be automatically deactivated - in which case, the use of Pilot Assist is not recommended. Examples of such situations may be that:

- the lane markings are unclear, worn, missing, or they cross each other, or if there are several sets of lane markings.
- the lane division is changed, e.g. when the lanes split or merge, as well as on slip roads.
- at roadworks and sudden changes in the roadway, e.g. when the lines may stop marking the correct route.
- edges or other lines than lane markings are present on or near the road, e.g. kerbs, joints or repairs to the road surface, edges of barriers, roadside edges or strong shadows.
- the lane is narrow or winding.
- the lane contains ridges or holes.
- weather conditions are poor, e.g. rain, snow or fog or slush or impaired view with poor light conditions, back-lighting, wet road surface etc.

The driver should also note that Pilot Assist has the following limitations:

- High kerbs, roadside barriers, temporary obstacles (traffic cones, safety barriers, etc.) are not detected. Alternatively, they may be detected incorrectly as lane markings, with a subsequent risk of contact between the car and such obstacles. The driver must ensure him/herself that the car is at a suitable distance from such obstacles.
- The camera and radar sensor does not have the capacity to detect all oncoming objects and obstacles in traffic environments, e.g. potholes, stationary obstacles or objects which completely or partially block the route.
- Pilot Assist does not "see" pedestrians, animals, etc.
- The functions steering assist is force limited, which means that Pilot Assist cannot always help the driver to steer and keep the car within the lane.
- In cars equipped with Sensus Navigation *, the function has the option of using information from map data, which may result in varied performance.
- Pilot Assist is switched off if the power steering for speed related steering force is working with reduced power – e.g. during cooling due to overheating.

 **Warning**

Pilot Assist must only be used if there are clear lane lines painted on each side of the lane. All other use involves increased risk of contact with surrounding obstacles that cannot be detected by the function.

 **Warning**

- This is not a collision avoidance system. The driver is always responsible and must intervene if the system does not detect a vehicle ahead.
- The function does not brake for humans or animals, and not for small vehicles such as bicycles and motorcycles. Nor for low trailers, oncoming, slow or stationary vehicles and objects.
- Do not use the function in demanding situations, such as in city traffic, at junctions, on slippery surfaces, with a lot of water or slush on the road, in heavy rain/snow, in poor visibility, on winding roads or on slip roads.



* Option/accessory.

^[1] This function can be either standard or optional, depending on market.

10.1.3.5. Display for adaptive cruise control and Pilot Assist *

The following sample illustration shows how adaptive cruise control (ACC^[1]) and Pilot Assist can be shown in the driver display^[2].

Graphic

	Adaptive cruise control is selected and active.
	Pilot Assist is selected and active. Pilot Assist steering assistance is only active when the steering wheel symbol has switched from extinguished to lit up.
	There is a target vehicle ahead to follow. The time interval to the vehicle ahead is only regulated when the graphic shows a vehicle above.

Speed

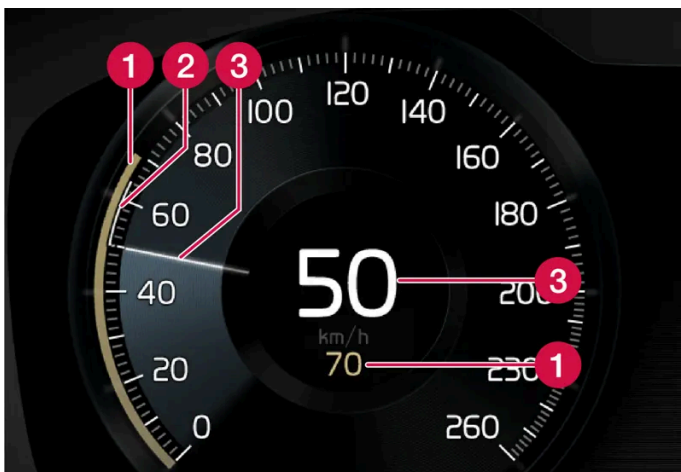

Indication of speeds.

1 Stored speed

The content of this manual represents the status of the user manual at the time of printing and may not be completely valid in future instances. For more information, refer to the first page for the complete disclaimer note.

- 2 Speed of vehicle ahead
- 3 Current speed of your car



* Option/accessory.

[1] Adaptive Cruise Control

[2] These functions can be either standard or optional, depending on market.

10.1.3.6. Symbols and messages for Pilot Assist*

A number of symbols and messages regarding Pilot Assist^[1] can be shown. Here are some examples.

Symbol	Message	Specification
	Steering wheel symbol extinguished	Indicates deactivated steering assistance. When Pilot Assist provides steering assistance, the steering wheel is lit up.
	Symbol for hands on the steering wheel	The system cannot detect whether the driver has his/her hands on the steering wheel. Place your hands on the steering wheel and actively steer the car.
	Windscreen sensor Sensor blocked, see Owner's manual	Clean the windscreen in front of the camera and radar unit's detectors.

A text message can be cleared by briefly pressing the  button, located in the centre of the steering wheel's right-hand keypad.

If a message remains, contact a workshop - an authorised Volvo workshop is recommended.

* Option/accessory.

[1] This function can be either standard or optional, depending on market.

10.1.3.7. Standby mode for Pilot Assist*

Pilot Assist^[1] can be deactivated and set in standby mode. This can take place automatically or be done by the driver.

Standby mode means that the function is selected in the driver display but not activated. In this case, Pilot Assist does not regulate the speed or distance to the vehicle in front, or provide steering assistance.

Standby mode on driver intervention

Pilot Assist is deactivated and set in standby mode if any of the following occurs:

- The foot brake is used.

- The gear selector is moved to **N** position.
- The direction indicators are used for longer than 1 minute.
- The driver maintains a speed higher than the stored speed for longer than 1 minute.

Automatic standby mode

Warning

With automatic standby mode, the driver is warned via an acoustic signal and a message in the driver display.

- The driver must then regulate the car's speed, apply the brakes as needed and maintain a safe distance to other vehicles.

Automatic standby mode may be engaged in the event of one of the following.

- One of the systems that Pilot Assist is dependent on stops working, e.g. stability control / anti-skid ^[2].
- Hands not holding the steering wheel.
- The driver opens the door.
- The driver takes off the seatbelt.
- The engine speed is too low/high.
- One or more wheels lose traction.
- The brake temperature is high.
- The parking brake is applied.
- The camera and radar unit is covered by e.g. snow or heavy rainfall (camera lens/radio waves are blocked).
- The speed is below 5 km/h (3 mph) and Pilot Assist is uncertain whether the vehicle ahead is a stationary vehicle or an object, such as a speed bump.
- The speed is below 5 km/h (3 mph) and the vehicle ahead turns off so that Pilot Assist no longer has a vehicle to follow.

* Option/accessory.

^[1] This function can be either standard or optional, depending on market.

^[2] Electronic Stability Control

10.1.3.8. Setting time interval to vehicle ahead

It is possible to set the time interval to the vehicle ahead to be maintained by the adaptive cruise control*, Pilot Assist* and Distance Warning* functions.

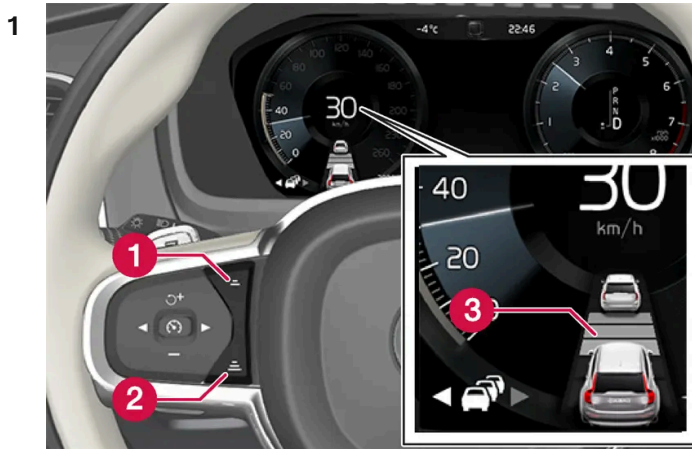

Control for time interval.

- 1 Decrease time interval
- 2 Increase time interval
- 3 Distance indicator

Press the steering wheel button (1) or (2) to increase or decrease the time interval.

➤ The distance indicator (3) shows the current time interval.

Different time intervals to the vehicle in front can be selected and shown in the driver display as 1-5 horizontal lines - the more lines the longer the time interval. One line represents about 1 second to the vehicle in front, 5 lines represents about 3 seconds.

The adaptive cruise control allows the time interval to vary significantly in certain situations in order to allow the car to follow the vehicle in front smoothly and comfortably. At low speed, when the distances are short, the adaptive cruise control increases the time interval slightly.

i Note

When the symbol in the driver display shows a car and a steering wheel, Pilot Assist follows a vehicle in front at a preset time gap.

When only one steering wheel is shown, there is no vehicle within a reasonable distance ahead.

i Note

When the symbol in the driver display shows two cars, adaptive cruise control is following the vehicle in front at a pre-set time interval.

When only one car is shown, there is no vehicle within a reasonable distance ahead.

 **Note**

- The higher the speed the longer the calculated distance in metres for a given time interval.
- Only use the time intervals permitted by local traffic regulations.
- If the driver supports do not seem to respond with a speed increase when activated, it may be because the time window to the vehicle ahead is shorter than the set time window.

 **Warning**

- Only use a time window that suits the current traffic conditions.
- The driver should be aware that short time windows limit the amount of time available to react and take action in an unexpected traffic situation.

* Option/accessory.

10.1.3.9. Difference between Pilot Assist* and lane assistance

Pilot Assist is a comfort function that can help you to keep your car within its own lane and maintain a safe distance from vehicles in front of you. Lane assistance^[1] is a function which, in a similar way, can help you in some situations to reduce the risk of your car accidentally leaving its own lane.

Pilot Assist

Pilot Assist can help you to steer your car between the lane's markings, as well as maintaining a preset speed and time interval to the vehicle ahead. The function can also help to maintain an advantageous position in the lane using the lane's lane lines.

What does Pilot Assist do?

- Can help to keep the car within its lane by assisting steering in some cases.
- Can help to maintain a preset speed or the distance to the vehicle ahead by means of acceleration and braking operations.

How do I know when Pilot Assist is operational?

Symbols in the driver's display in the car indicate when this function is operational.

When the steering wheel in the middle is extinguished, Pilot Assist is running but steering assistance is not active.

When the steering wheel is illuminated, Pilot Assist is running and steering assistance is active.

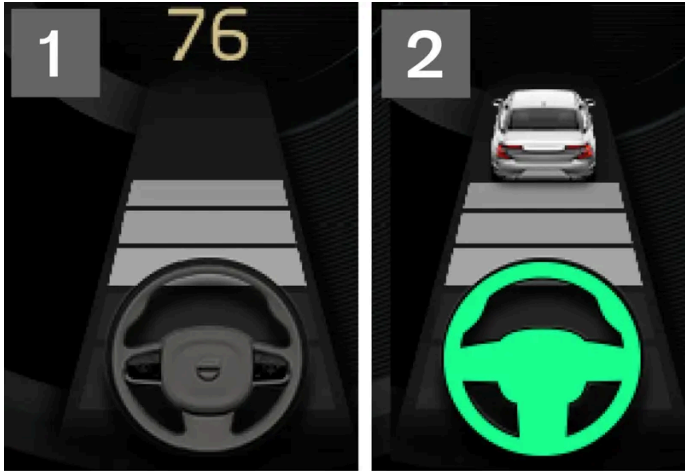

2 When the steering wheel symbol in the driver display is illuminated, Pilot Assist is helping you to steer.

Lane assistance

Lane assistance can provide steering assistance and/or give you an alert when the vehicle is about to leave its own lane unintentionally. This function is active in the speed range 65-200 km/h (40-125 mph) on roads with clearly visible lane lines.

What does lane assistance do?

- Lane assistance can provide the driver with steering assistance, steering the car back into its lane and/or providing warnings using acoustic signals or steering wheel vibration.

How do I know when lane assistance is operational?

Symbols in the driver's display in the car show the status of the function.



An extinguished symbol in the driver display means that the function is running but the conditions for LKA have not been met.



A white symbol in the driver's display means that the conditions for LKA have been met and that the function is available.



An orange symbol in the driver's display means that LKA is providing steering assistance back in to the lane and/or will provide warnings using acoustic signals or steering wheel vibration.

Warning

The driver always bears responsibility for ensuring that the car is driven safely. Before using this function, the driver is recommended to read all sections on the function in the owner's manual.

 **Warning**

- The function is supplementary driver support intended to facilitate driving and make it safer – it cannot handle all situations in all traffic, weather and road conditions.
- The driver is advised to read all sections in the Owner's Manual that relate to this function to learn about factors such as its limitations and what the driver should be aware of before using the system.
- Driver support functions are not a substitute for the driver's attention and judgement. The driver is always responsible for ensuring the car is driven in a safe manner, at the appropriate speed, with an appropriate distance to other vehicles, and in accordance with current traffic rules and regulations.

* Option/accessory.

[1] Lane Keeping Aid

10.1.3.10. Warning from cruise control functions in the event of a collision risk

The driver support systems of adaptive cruise control* and Pilot Assist* can warn the driver if the distance to the vehicle ahead suddenly becomes too short.

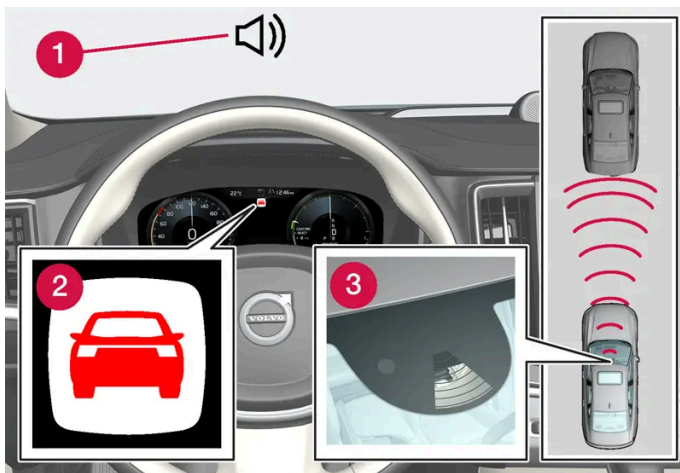

Audio and symbol for collision warning

- 1 Acoustic signal in the event of a risk of collision
- 2 Warning signal in the event of a risk of collision
- 3 Distance measurement with the camera and radar units

Adaptive cruise control and Pilot Assist use approx. 40% of the capacity of the foot brake. If the car needs to be braked more heavily than the driver support is capable of and the driver does not brake, the warning lamp and acoustic warning are activated to alert the driver that immediate intervention is required.

 **Warning**

The driver support systems only warn of vehicles which their radar unit has detected – hence a warning may not be given, or it may be given with a certain delay. Never wait for a warning. Apply the brakes when the situation requires.



Symbol for collision warning on the windscreen

In cars equipped with a head up display*, the warning is shown on the windscreen by a flashing symbol.

 **Note**

Strong sunlight, reflections, extreme light contrasts, the use of sunglasses, or if the driver is not looking straight ahead may make the visual warning signal in the windscreen difficult to recognise.

* Option/accessory.

10.1.4. Cornering support

10.1.4.1. Cornering support*

Curve Speed Assist^[1] can help the driver to reduce speed ahead of sharper bends if the preselected speed for the driver support adaptive cruise control* or Pilot Assist* is estimated as being too high.



In connection with the function reducing the car's speed, this symbol is shown in the driver display.

The calculation is made using information from map data in the car's satellite navigator Sensus Navigation*. After the bend has been passed, the car resumes the previously preset speed.

The driver can cancel the function at any time by choosing to brake or by using the accelerator pedal.

 **Warning**

- The function is supplementary driver support intended to facilitate driving and make it safer – it cannot handle all situations in all traffic, weather and road conditions.
- The driver is advised to read all sections in the Owner's Manual that relate to this function to learn about factors such as its limitations and what the driver should be aware of before using the system.
- Driver support functions are not a substitute for the driver's attention and judgement. The driver is always responsible for ensuring the car is driven in a safe manner, at the appropriate speed, with an appropriate distance to other vehicles, and in accordance with current traffic rules and regulations.

Drive modes

Assistance during cornering depends on the drive mode set. If the drive mode options are unavailable, the function selects the **Comfort** option. Using the **Dynamic** option, the car negotiates bends with sporty characteristics and with slightly more powerful acceleration out of the bends.

* Option/accessory.

^[1] This function is only available in certain markets.

10.1.4.2. Activating and deactivating cornering support *

The cornering support function can be activated as a complement to the adaptive cruise control* or Pilot Assist*. The driver can also choose to deactivate the function.



Activate or deactivate the function using this button in the centre display's function view.

- Illuminated button – the function is activated.
- Extinguished button – the function is deactivated.

During subsequent engine starting, the last used setting is reactivated or settings are followed that were made in the driver profile linked to the key used^[1].

* Option/accessory.

^[1] These options are market-dependent.

10.1.4.3. Limitations for cornering support *

Cornering support^[1] may have limited functionality in certain situations. A driver should be aware about the following examples of limitations.

- Cornering support may have limited performance on smaller roads and in built-up areas.
- On slip roads or intersections, the cornering support may be switched off temporarily.
- If the satellite navigator^[2] map data is not updated, cornering support may have limited functionality.
- If the satellite navigator^[2] does not have contact with the satellite system, cornering support may have limited functionality.
- On new or rebuilt roads, map data may be incorrect.
- When calculating a suitable cornering speed, any risk of reduced traction due to adverse weather or road conditions is not included.

Note

This function uses the car's camera and radar units, which have certain general limitations.

* Option/accessory.

^[1] This function is only available in certain markets.

^[2] Only with Volvo's satellite navigator Sensus Navigation * installed.

10.1.5. Overtaking assistance

10.1.5.1. Overtaking Assistance *

Overtaking Assistance can help the driver when overtaking other vehicles. The function can be used with adaptive cruise control* or Pilot Assist*.

When adaptive cruise control or Pilot Assist is following another vehicle and the driver indicates the intention to overtake by activating the direction indicator^[1], the systems can help by accelerating the vehicle towards the vehicle ahead **before** the driver's vehicle reaches the overtaking lane.

The function then delays reducing speed in order to avoid premature braking when the driver's car is approaching a slower vehicle.

The function remains active until the driver's vehicle has cleared the overtaken vehicle.

 **Warning**

Be aware that this function can be activated in more situations than during overtaking, e.g. when a direction indicator is used to indicate a change of lane or exit to another road – the car will then accelerate briefly.

 **Warning**

- The function is supplementary driver support intended to facilitate driving and make it safer – it cannot handle all situations in all traffic, weather and road conditions.
- The driver is advised to read all sections in the Owner's Manual that relate to this function to learn about factors such as its limitations and what the driver should be aware of before using the system.
- Driver support functions are not a substitute for the driver's attention and judgement. The driver is always responsible for ensuring the car is driven in a safe manner, at the appropriate speed, with an appropriate distance to other vehicles, and in accordance with current traffic rules and regulations.

* Option/accessory.

[1] On left flash only in left-hand-drive car, or right flash in right-hand-drive car.

10.1.5.2. Use Overtaking Assistance

Overtaking assistance can be used with adaptive cruise control* or Pilot Assist*. There are a number of criteria if Overtaking Assistance is to be used.

The following conditions must exist for Overtaking Assistance to be activated:

- there must be a vehicle in front (the “target vehicle”)
- your car's **current speed** is at least 70 km/h (43 mph)
- **the stored speed** must be high enough for overtaking to take place safely.

To start the Overtaking Assistance:

- 1 Activate the direction indicator.

Use the left-hand direction indicator in a left-hand drive car right in a right-hand drive car.

- Overtaking Assistance begins acceleration and reduces the time interval the vehicle ahead for a limited period in order to facilitate overtaking. If no overtake is executed, the time interval returns to the preset value.

 **Warning**

When using the Overtaking Assistance System, the driver should be aware that there may be undesired acceleration if the conditions suddenly change.

Some situations should therefore be avoided, such as if:

- the car is approaching an exit to turn-off in the same direction as overtaking would normally occur.
- the vehicle ahead slows down before the driver's car has crossed over into the overtaking lane.
- the traffic in the overtaking lane slows down.
- a right-hand drive car is driven in a county with left-hand traffic (or vice versa).







Situations of this kind can be avoided by temporarily setting adaptive cruise control or Pilot Assist in standby mode.

* Option/accessory.

10.1.6. Cruise control functions

There are several driver support systems that can assist you while driving in order to maintain a suitable speed depending on situation. Here is a summary to make them more easily distinguishable from each other.

It is recommended that you read all sections in the Owner's Manual that relate to a function in order to learn about factors such as its limitations and what the driver should be aware of before using the system.

	Speed limiter ^[1]	Automatic speed limiter* ^[2]	Cruise control ^[3]	Adaptive cruise control* ^[4] ^[5]	Pilot Assist* ^[5]
Symbol in the driver display		 + 			
Brief description	The driver controls the speed with the accelerator pedal but is prevented by the speed limiter from mistakenly exceeding a preselected/preset maximum speed.	The automatic speed limiter uses speed information from the Road Sign Information* ^[6] function to automatically adapt the car's maximum speed.	The cruise control helps the driver to maintain an even speed, which can result in a more relaxed driving experience on, for example, motorways and long straight main roads in smooth traffic flows.	The adaptive cruise control helps the driver to maintain an even speed combined with a pre-selected time interval to the vehicle ahead.	Pilot Assist can help the driver to drive the car between the lane's side markings using steering assistance as well as to maintain an even speed, combined with a preselected time interval to the vehicle ahead.

^[1] Speed Limiter

* Option/accessory.

^[2] Automatic Speed Limiter

^[3] Cruise Control

^[4] Adaptive Cruise Control

^[5] This function can be either standard or optional, depending on market.

10.1.7. Steering wheel buttons for the cruise control functions

The cruise control functions can be controlled using the left-hand steering wheel keypad. This is applicable to the speed limiter (SL ^[1]), automatic speed limiter (ASL ^[2]), cruise control (CC ^[3]), adaptive cruise control (ACC ^[4]) and Pilot Assist.

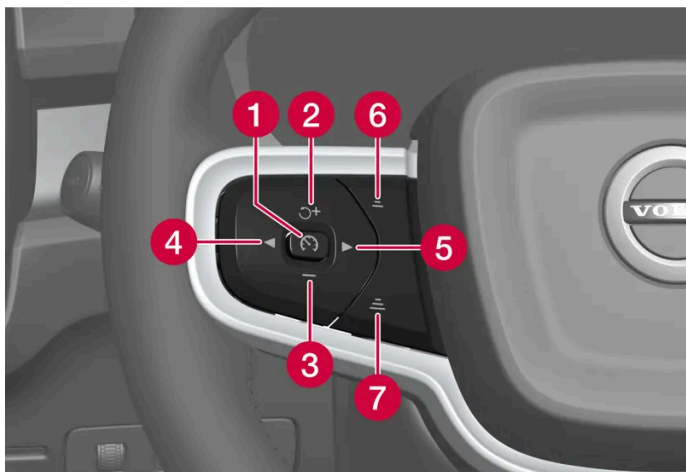

Cruise control function buttons

- 1 : **From standby mode** – Activates the selected function and stores the current speed. : **From active mode** – Sets the function to standby mode.
- 2 : **From standby mode** – Activates the selected function and resumes the stored speed. : **From active mode** – Increases the stored speed.
- 3 : Reduces stored speed.
- 4 : Scroll to the left to the next function.
- 5 : Scroll to the right to the next function.
- 6 : Reduces the time interval to vehicles ahead.
- 7 : Increases the time interval to vehicles ahead.

Warning

- The function is supplementary driver support intended to facilitate driving and make it safer – it cannot handle all situations in all traffic, weather and road conditions.
- The driver is advised to read all sections in the Owner's Manual that relate to this function to learn about factors such as its limitations and what the driver should be aware of before using the system.
- Driver support functions are not a substitute for the driver's attention and judgement. The driver is always responsible for ensuring the car is driven in a safe manner, at the appropriate speed, with an appropriate distance to other vehicles, and in accordance with current traffic rules and regulations.

[1] Speed Limiter

[2] Automatic Speed Limiter





[3] Cruise Control

[4] Adaptive Cruise Control

10.1.8. Selecting and activating cruise control functions

The cruise control functions have to be selected in the centre display first before they can be activated using a steering wheel button. This is applicable to the speed limiter (SL^[1])*, automatic speed limiter (ASL^[2]), cruise control (CC^[3]), adaptive cruise control (ACC^[4]) and Pilot Assist.

1 Press the steering wheel button ◀ or ▶ to scroll to the symbol for the desired function.

- Speed limiter: 
- Cruise control: 
- Adaptive cruise control: 
- Pilot Assist: 

➤ The symbol in the driver display is grey – the function is selected.

2 When a function is selected – press the steering wheel button  to activate it.

➤ The symbol in the driver display lights up – the function is started and the current speed is stored as the maximum speed.

3 If the function is set to standby mode – press the steering wheel button  to reactivate it.

➤ The driver display's cruise control markings light up – the car then continues to follow the last speed stored.

toggling between the speed limiter and the automatic speed limiter

The automatic speed limiter can be activated and deactivated as a supplement to the speed limiter.



Activate or deactivate the function using this button in the centre display's function view.

- • Illuminated button – the function is activated. Press the steering wheel button  to start the automatic speed limiter with the current speed.
- Extinguished button – the function is deactivated. Normal speed limiter is activated instead.

Criteria

Certain criteria have to be met to be able to start any of the functions.

Speed limiter and automatic speed limiter

- The speed limiter cannot be activated until after the engine has been started.
- The lowest maximum speed that can be stored is 30 km/h (20 mph).

Cruise control

- In order to start the cruise control from the standby mode, the car's current speed must be 30 km/h (20 mph) or higher.

Adaptive cruise control

- The driver's seatbelt must be buckled and the driver's door must be closed.
- There must be a vehicle (the "target vehicle") within reasonable distance in front of the car, or the current speed must be at least 15 km/h (9 mph).

Pilot Assist

- The driver's seatbelt must be buckled and the driver's door must be closed.
- The lane's edge markings must be clear and must be detected by the car.
- There must be a vehicle (the "target vehicle") within reasonable distance in front of the car, or the current speed must be at least 15 km/h (9 mph).
- The speed must not exceed 140 km/h (87 mph).
- The driver must keep his/her hands on the steering wheel.

^[1] Speed Limiter

* Option/accessory.

^[2] Automatic Speed Limiter

^[3] Cruise Control

^[4] Adaptive Cruise Control

10.1.9. Deactivating cruise control functions

The cruise control functions can be deactivated using a button on the steering wheel. The function then switches to standby mode. This is applicable to the speed limiter (SL^[1]), automatic speed limiter (ASL^[2]), cruise control (CC^[3]), adaptive cruise control (ACC^[4]) and Pilot Assist.

- 1 Press the steering wheel button .

- The symbol and indicators are extinguished – the speed limiter is set in standby mode.

When a different function is selected using the steering wheel buttons, the driver display's symbol and the indicator for a previously selected function are hidden – the set/stored max. speed is then deleted.

 **Warning**

When the cruise control functions are in standby mode, the driver must intervene and regulate both speed and distance to the vehicle ahead.

[1] Speed Limiter

[2] Automatic Speed Limiter

[3] Cruise Control

[4] Adaptive Cruise Control

10.2. Speed limiter functions

10.2.1. Speed limiter

10.2.1.1. Speed limiter

A speed limiter (SL^[1]) can be likened to a reverse cruise control - the driver regulates the speed using the accelerator pedal but is prevented from accidentally exceeding a pre-selected/set maximum speed by the speed limiter.

Temporary acceleration

The speed limiter can be overridden temporarily when the accelerator pedal is depressed fully, without having to set the speed limiter to standby mode first – e.g. so as to be able to accelerate the car out of a situation quickly.

In which case, proceed as follows:

- 1 Fully depress the accelerator pedal and release it to interrupt acceleration when the desired speed has been reached.

- In this mode, the speed limiter is still activated and the driver display's symbol is therefore lit up.

Fully release the accelerator pedal when the temporary acceleration is finished.

The content of this manual represents the status of the user manual at the time of printing and may not be completely valid in future instances. For more information, refer to the first page for the complete disclaimer note.

- > The car is then engine-braked automatically to below the last stored maximum speed.

Steep roads

On steep hills the speed limiter's braking effect may be inadequate and the stored maximum speed may be exceeded.

Warning

- The function is supplementary driver support intended to facilitate driving and make it safer – it cannot handle all situations in all traffic, weather and road conditions.
- The driver is advised to read all sections in the Owner's Manual that relate to this function to learn about factors such as its limitations and what the driver should be aware of before using the system.
- Driver support functions are not a substitute for the driver's attention and judgement. The driver is always responsible for ensuring the car is driven in a safe manner, at the appropriate speed, with an appropriate distance to other vehicles, and in accordance with current traffic rules and regulations.

^[1] Speed Limiter

10.2.2. Automatic speed limiter

10.2.2.1. Automatic speed limiter

The Automatic Speed Limiter (ASL ^[1]) function helps the driver to adapt the car's maximum speed to the speed shown on the road signs.

Symbol for automatic speed limiter

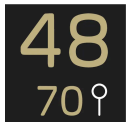

The sign symbol (displayed alongside the stored speed, "70", in the centre of the speedometer) can be shown in three colours with the following meanings:

Colour of sign symbol	Meaning
Greenish yellow	The automatic speed limiter is active
Grey	The automatic speed limiter is set in standby mode
Orange	Automatic speed limiter is in temporary standby mode - e.g. due to a road sign not being read.

Speed information from road signs

The content of this manual represents the status of the user manual at the time of printing and may not be completely valid in future instances. For more information, refer to the first page for the complete disclaimer note.

The automatic speed limiter uses speed information from the Road Sign Information (RSI ^[2]) function to automatically adapt the car's maximum speed.

Road sign information bases its information on the speed limit road signs that the car passes, plus map data. Physical signs passed have top priority, which may be necessary in the case of roadworks, for example.

If road sign information cannot interpret and provide speed information to the driver support systems, the automatic speed limiter is set to standby mode and changes to the normal speed limiter. In such cases the driver must intervene and brake to a suitable speed.

The automatic speed limiter will be reactivated when road sign information can once again interpret and provide speed information.

 **Warning**

Even if the driver clearly sees the speed-related road sign, the speed information from the Road Sign Information* (RSI) function to ASL may be incorrect – in such cases the driver must intervene him/herself and accelerate or brake to a suitable speed.

Tolerance level for automatic speed limiter

The automatic speed limiter can be set to different tolerance levels. The tolerance is adjusted in the same way as the speed setting is in the speed limiter.

If, for example, the car follows a signed speed limit of 70km/h (43 mph) the driver can instead choose to allow the car to maintain 75 km/h (47 mph).

The tolerance is followed until a road sign with a lower or higher speed is passed - then the car follows the new signed speed limit instead and the tolerance is deleted from the memory.

 **Note**

The maximum selectable tolerance is +/- 10 km/h (5 mph).

 **Warning**

- The function is supplementary driver support intended to facilitate driving and make it safer – it cannot handle all situations in all traffic, weather and road conditions.
- The driver is advised to read all sections in the Owner's Manual that relate to this function to learn about factors such as its limitations and what the driver should be aware of before using the system.
- Driver support functions are not a substitute for the driver's attention and judgement. The driver is always responsible for ensuring the car is driven in a safe manner, at the appropriate speed, with an appropriate distance to other vehicles, and in accordance with current traffic rules and regulations.

^[1] Automatic Speed Limiter

^[2] Road Sign Information

* Option/accessory.

10.3. Distance Warning

10.3.1. Distance Warning*

The distance warning^[1] function can assist the driver to notice that the time interval to the vehicle ahead may be too short. This requires the car to be equipped with a head-up display* to be able to display Distance Warning.



Distance Warning symbol on the windscreen with head-up display.

In cars equipped with head-up display, a symbol is shown on the windscreen for as long as the time interval to the vehicle ahead is shorter than the preset value. However, this assumes that the **Show Driver Support** function is activated via the settings in the car's menu system.

Distance warning is active at speeds above 30 km/h (20 mph) and only reacts to the vehicle ahead travelling in the same direction. No distance information is provided for oncoming, slow or stationary vehicles.



Warning light for distance warning is shown on the windscreen.

Even if the car is not equipped with a head-up display, a warning light appears on the windscreen and shines steadily if the time interval to the vehicle in front is shorter than a preset value.

i Note

Strong sunlight, reflections, extreme light contrasts, the use of sunglasses, or if the driver is not looking straight ahead may make the visual warning signal in the windscreen difficult to recognise.

i Note

Distance warning is deactivated during the time the adaptive cruise control* or Pilot Assist* is active.

! Warning

Distance warning only reacts if the time window to the vehicle ahead is shorter than the preset value – the speed of the driver's vehicle is not affected.

! Warning

- The function is supplementary driver support intended to facilitate driving and make it safer – it cannot handle all situations in all traffic, weather and road conditions.
- The driver is advised to read all sections in the Owner's Manual that relate to this function to learn about factors such as its limitations and what the driver should be aware of before using the system.
- Driver support functions are not a substitute for the driver's attention and judgement. The driver is always responsible for ensuring the car is driven in a safe manner, at the appropriate speed, with an appropriate distance to other vehicles, and in accordance with current traffic rules and regulations.

* Option/accessory.

^[1] Distance Alert

10.3.2. Activating and deactivating Distance Warning

The distance warning^[1] function can be deactivated. The function is only available in cars that can show information on the windscreen with a so-called head-up display*.



Activate or deactivate the function using this button in the centre display's function view.

- Illuminated button – the function is activated.
- Extinguished button – the function is deactivated.

Distance Warning is activated automatically each time the engine is started.

^[1] Distance Alert

* Option/accessory.

10.3.3. Limitations of distance warning

Distance warning^[1] may have limited functionality in certain situations. The function is only available in cars that can show information on the windscreen with a so-called head-up display*.

Warning

- A vehicle's size may affect the ability to be detected, e.g. motorcycles, which could mean that the warning lamp illuminates at a shorter time window than set or that the warning is temporarily absent.
- Extremely high speeds can cause the lamp to illuminate at a shorter time window than that set due to limitations in radar unit range.

Note

This function uses the car's camera and radar units, which have certain general limitations.

^[1] Distance Alert

* Option/accessory.

10.3.4. Setting time interval to vehicle ahead

It is possible to set the time interval to the vehicle ahead to be maintained by the adaptive cruise control*, Pilot Assist* and Distance Warning* functions.

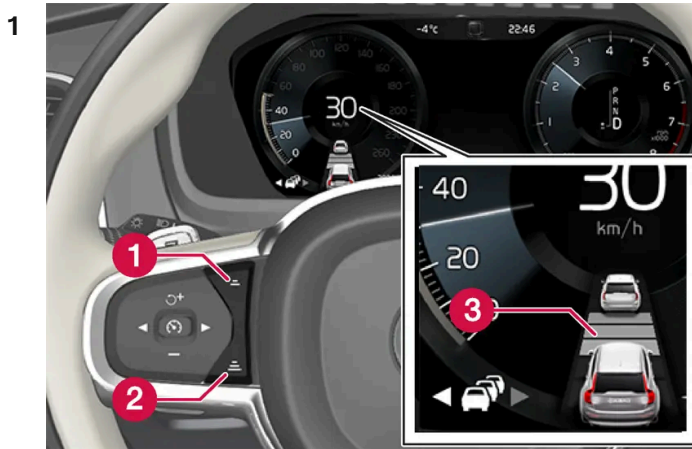

Control for time interval.

- 1 Decrease time interval
- 2 Increase time interval
- 3 Distance indicator

Press the steering wheel button (1) or (2) to increase or decrease the time interval.

➤ The distance indicator (3) shows the current time interval.

Different time intervals to the vehicle in front can be selected and shown in the driver display as 1-5 horizontal lines - the more lines the longer the time interval. One line represents about 1 second to the vehicle in front, 5 lines represents about 3 seconds.

The adaptive cruise control allows the time interval to vary significantly in certain situations in order to allow the car to follow the vehicle in front smoothly and comfortably. At low speed, when the distances are short, the adaptive cruise control increases the time interval slightly.

i Note

When the symbol in the driver display shows a car and a steering wheel, Pilot Assist follows a vehicle in front at a preset time gap.

When only one steering wheel is shown, there is no vehicle within a reasonable distance ahead.

i Note

When the symbol in the driver display shows two cars, adaptive cruise control is following the vehicle in front at a pre-set time interval.

When only one car is shown, there is no vehicle within a reasonable distance ahead.

Note

- The higher the speed the longer the calculated distance in metres for a given time interval.
- Only use the time intervals permitted by local traffic regulations.
- If the driver supports do not seem to respond with a speed increase when activated, it may be because the time window to the vehicle ahead is shorter than the set time window.

Warning

- Only use a time window that suits the current traffic conditions.
- The driver should be aware that short time windows limit the amount of time available to react and take action in an unexpected traffic situation.

* Option/accessory.

10.3.5. Warning from cruise control functions in the event of a collision risk

The driver support systems of adaptive cruise control* and Pilot Assist* can warn the driver if the distance to the vehicle ahead suddenly becomes too short.

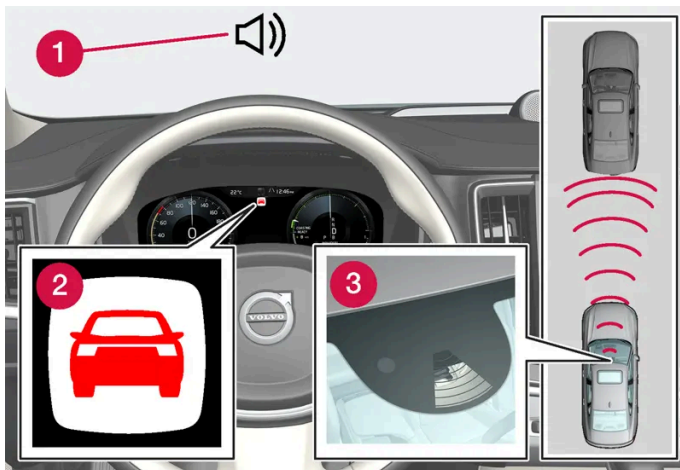

Audio and symbol for collision warning

- 1 Acoustic signal in the event of a risk of collision
- 2 Warning signal in the event of a risk of collision
- 3 Distance measurement with the camera and radar units

Adaptive cruise control and Pilot Assist use approx. 40% of the capacity of the foot brake. If the car needs to be braked more heavily than the driver support is capable of and the driver does not brake, the warning lamp and acoustic warning are activated to alert the driver that immediate intervention is required.

 **Warning**

The driver support systems only warn of vehicles which their radar unit has detected – hence a warning may not be given, or it may be given with a certain delay. Never wait for a warning. Apply the brakes when the situation requires.



Symbol for collision warning on the windscreen

In cars equipped with a head up display*, the warning is shown on the windscreen by a flashing symbol.

 **Note**

Strong sunlight, reflections, extreme light contrasts, the use of sunglasses, or if the driver is not looking straight ahead may make the visual warning signal in the windscreen difficult to recognise.

* Option/accessory.

10.4. Blind Spot Information

10.4.1. BLIS*

The BLIS^[1] function is intended to help the driver detect vehicles diagonally behind and to the side of the car so as to provide assistance in heavy traffic on roads with several lanes in the same direction.



Location of BLIS lamp

BLIS is a driver aid intended to give a warning of:

- vehicles in the car's blind spot
- quickly approaching vehicles in the left and right lanes closest to the car.

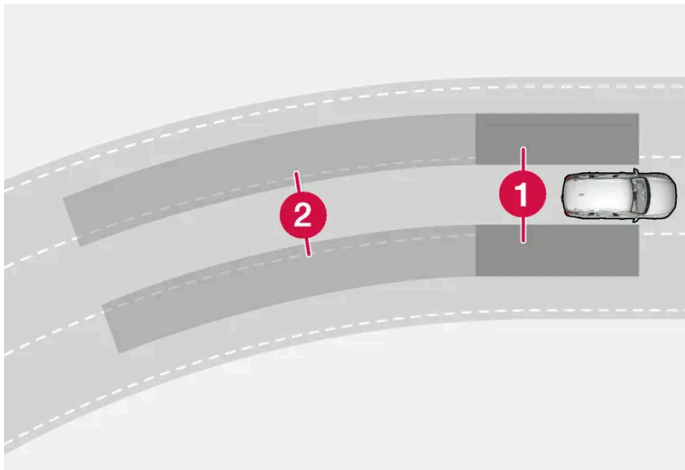

Principle of BLIS

- ❶ Zone in blind spot
- ❷ Zone for quickly approaching vehicle

The system is designed to react when:

- your car is overtaken by other vehicles
- another vehicle is approaching your own car at speed.

When BLIS detects a vehicle in Zone 1 or a quickly approaching vehicle in Zone 2, the indicator lamp on the door mirror on the right or left illuminates with a constant glow. If the driver activates the direction indicator on the same side as the warning, the indicator lamp will change over from a constant glow to flashing with a more intense light.

BLIS is active when the driver's vehicle is travelling at a speed above 12 km/h (7 mph).

If passing vehicles drive more than 15 km/h (9 mph) faster than the driver's vehicle, BLIS will not react.

The content of this manual represents the status of the user manual at the time of printing and may not be completely valid in future instances. For more information, refer to the first page for the complete disclaimer note.
505 / 1131

i Note

The lamp illuminates on the side of the car where the system has detected the vehicle. If the car is overtaken on both sides at the same time then both lamps illuminate.

⚠ Warning

- The function is supplementary driver support intended to facilitate driving and make it safer – it cannot handle all situations in all traffic, weather and road conditions.
- The driver is advised to read all sections in the Owner's Manual that relate to this function to learn about factors such as its limitations and what the driver should be aware of before using the system.
- Driver support functions are not a substitute for the driver's attention and judgement. The driver is always responsible for ensuring the car is driven in a safe manner, at the appropriate speed, with an appropriate distance to other vehicles, and in accordance with current traffic rules and regulations.

* Option/accessory.

^[1] Blind Spot Information

10.4.2. Activating and deactivating BLIS

The BLIS^[1] function can be activated or deactivated.



Activate or deactivate the function using this button in the centre display's function view.

- Illuminated button – the function is activated.
- Extinguished button – the function is deactivated.

If BLIS is activated when starting the engine, the function is confirmed by the door mirror indicator lamps blinking once.

If BLIS was deactivated when the engine was switched off, it will continue to be deactivated when the engine is next started and no indicator lights will then be illuminated.

^[1] Blind Spot Information

10.4.3. Messages for BLIS

A number of messages regarding BLIS^[1] can be shown in the driver display. Here are some examples.

Message	Specification
Blind spot sensor Service required	The system does not function as it should. A workshop should be contacted ^[2] .
Blind spot system off Trailer attached	BLIS and CTA ^[3] have been deactivated as a trailer has been connected to the car's electrical system.

A text message can be cleared by briefly pressing the  button, located in the centre of the steering wheel's right-hand keypad.

If a message remains, contact a workshop - an authorised Volvo workshop is recommended.

^[1] Blind Spot Information

^[2] An authorised Volvo workshop is recommended.

* Option/accessory.

^[3] Cross Traffic Alert*

10.4.4. Limitations of BLIS

The BLIS^[1] function may have limitations in certain situations.



Keep the surface indicated clean – on both the left and right-hand sides of the car^[2].

Examples of limitations:

- Dirt, ice and snow covering the sensors may reduce the functions and deactivate alerts.
- The BLIS function is automatically deactivated if a trailer, bicycle rack or similar is connected to the car's electrical system.
- For good performance of BLIS, there should be no bicycle rack, luggage carrier or similar mounted on the car's towbar.

 **Warning**

- BLIS does not work on sharp bends.
- BLIS does not work when the car is reversing.

 **Note**

This function uses the car's radar units, which have certain general limitations.

^[1] Blind Spot Information

^[2] NOTE: The illustration is schematic - details may vary depending on car model.

10.5. Cross Traffic Alert

10.5.1. Cross Traffic Alert *

Cross Traffic Alert (CTA) is a driver support that supplements BLIS^[1] and is designed to help the driver detect traffic crossing behind the car when it is reversing.

The **auto-brake** subfunction can help the driver to stop the car in the event of a risk of collision with an unobserved vehicle.

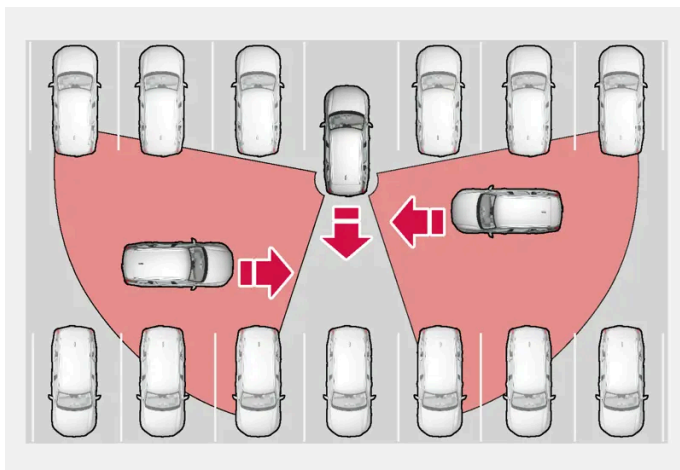

Examples of areas where Cross Traffic Alert can assist the driver to detect obstacles during reversing.

The function is primarily designed to detect vehicles. In favourable conditions it may also be able to detect smaller objects, such as cyclists and pedestrians.

The function is only active if the car rolls backwards or if reverse gear has been selected.

If the function senses that something is approaching from the side, this is indicated with:

- an acoustic signal - the sound is heard in the left-hand or right-hand speaker according to the direction from which the object approaches.
- an illuminated icon in the **Park Assist System** graphic on the screen.
- an icon on the Park assist camera top view.



Illuminated icon for Cross Traffic Alert in the **Park Assist System** graphic on the screen.

If the driver does not observe the warning from the function and a collision is unavoidable, the **auto-brake** function engages in order to stop the car, after which the driver display shows an explanatory text message on why the car was braked.

Warning

- The function is supplementary driver support intended to facilitate driving and make it safer – it cannot handle all situations in all traffic, weather and road conditions.
- The driver is advised to read all sections in the Owner's Manual that relate to this function to learn about factors such as its limitations and what the driver should be aware of before using the system.
- Driver support functions are not a substitute for the driver's attention and judgement. The driver is always responsible for ensuring the car is driven in a safe manner, at the appropriate speed, with an appropriate distance to other vehicles, and in accordance with current traffic rules and regulations.

* Option/accessory.

[1] Blind Spot Information

10.5.2. Activating and deactivating Cross Traffic Alert*

The driver can choose to switch off the Cross Traffic Alert (CTA) function.

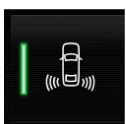

Activate or deactivate the function using this button in the centre display's function view.

- Illuminated button – the function is activated.
- Extinguished button – the function is deactivated.

The function is activated automatically each time the engine is started.

* Option/accessory.

10.5.3. Messages for Cross Traffic Alert *

A number of messages regarding Cross Traffic Alert (CTA) can be shown in the driver display. Here are some examples.

Message	Specification
Blind spot sensor Service required	The system does not function as it should. A workshop should be contacted ^[1] .
Blind spot system off Trailer attached	BLIS ^[2] and CTA have been deactivated as a trailer has been connected to the car's electrical system.

A text message can be cleared by briefly pressing the  button, located in the centre of the steering wheel's right-hand keypad.

If a message remains, contact a workshop - an authorised Volvo workshop is recommended.

* Option/accessory.

^[1] An authorised Volvo workshop is recommended.

^[2] Blind Spot Information System

10.5.4. Limitations of Cross Traffic Alert *

The Cross Traffic Alert (CTA) function with **auto-brake** may have limited functionality in certain situations. Brake intervention is active at speeds below 15 km/h.

Warning

The **auto-brake** subfunction can only detect and brake for other vehicles that are moving – **not** for stationary obstacles, a cyclist or a pedestrian, for example.

The function has a certain limitation – the sensors cannot "see" through other parked vehicles or obstructions, for example.

Here are some examples of situations where the function's "field of vision" may be already limited and approaching vehicles cannot therefore be detected until they are very close:

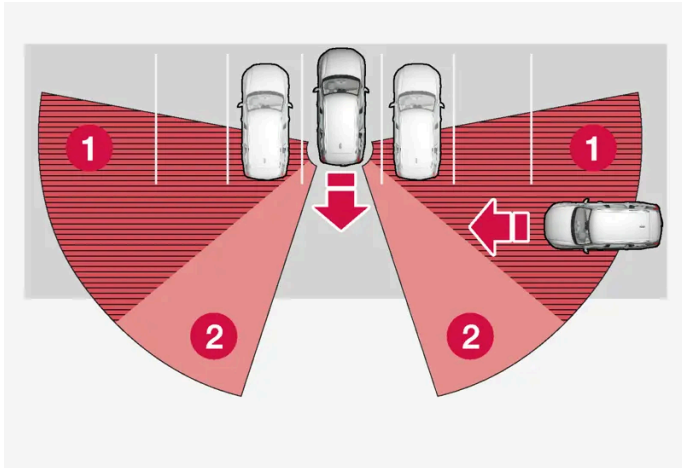

The car is parked deep inside a parking slot.

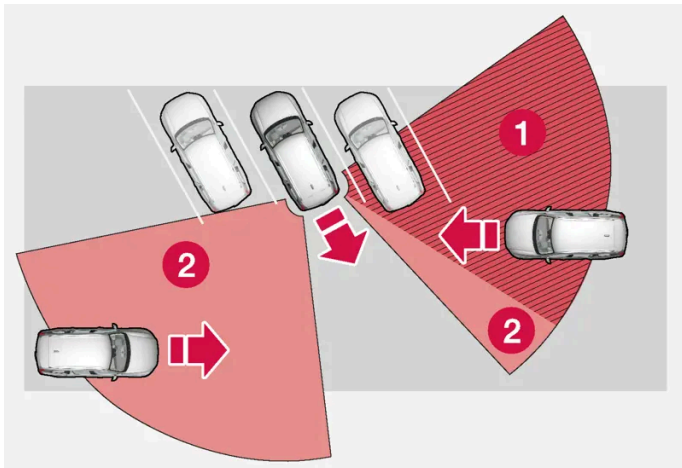

In an angled parking slot Cross Traffic Alert may be completely "blind" on one side.

- 1 Blind sector.
- 2 Sector in which the function can detect/"see".

However, as your car slowly reverses, the angle it makes with the obstructing vehicle/object changes and the blind sector rapidly decreases.

Examples of further limitations

- The **auto-brake** subfunction only detects moving vehicles and therefore **cannot** "see" and brake for stationary obstacles, a cyclist or a pedestrian, for example.
- Dirt, ice and snow covering the sensors may reduce the functions and deactivate alerts.
- CTA is automatically deactivated if a trailer, bicycle rack or similar is connected to the car's electrical system.
- For good performance of CTA, there should be no bicycle rack, luggage carrier or similar mounted on the car's towbar.

i Note

This function uses the car's radar units, which have certain general limitations.

* Option/accessory.

10.6. Rear Collision Warning

10.6.1. Rear Collision Warning*

The Rear Collision Warning^[1] (RCW) function can help the driver to avoid being hit by a vehicle approaching from behind.

Drivers in vehicles behind can be warned about an imminent collision by the function flashing intensively with the direction indicators.

If, at a speed below 30 km/h (20 mph), the function detects that the car is in danger of being hit from behind, the seatbelt tensioners may tension the front seatbelts. The Whiplash Protection System is also activated in the event of a collision.

Immediately before a collision from behind, this function may also activate the foot brake in order to reduce the forward acceleration of the car during the collision. However, the foot brake is only activated if the car is stationary. The foot brake releases immediately if the accelerator pedal is depressed.

This function is activated automatically each time the engine is started.

Warning

- The function is supplementary driver support intended to facilitate driving and make it safer – it cannot handle all situations in all traffic, weather and road conditions.
- The driver is advised to read all sections in the Owner's Manual that relate to this function to learn about factors such as its limitations and what the driver should be aware of before using the system.
- Driver support functions are not a substitute for the driver's attention and judgement. The driver is always responsible for ensuring the car is driven in a safe manner, at the appropriate speed, with an appropriate distance to other vehicles, and in accordance with current traffic rules and regulations.

* Option/accessory.

^[1] The function is not available in all markets.

10.6.2. Limitations of Rear Collision Warning*

In certain cases, the Rear Collision Warning (RCW)^[1] may have difficulty helping the driver in the event of a collision risk.

This can, for example, be if:

- the vehicle approaching from behind is detected too late
- the vehicle approaching from behind changes lane at the last moment
- a trailer, bicycle rack or similar is connected to the car's electrical system - the function is then deactivated automatically.

***i* Note**

In certain markets, RCW does **not** give a warning with the direction indicators due to local traffic regulations - in such cases, this part of the function is deactivated.

***i* Note**

This function uses the car's radar units, which have certain general limitations.

* Option/accessory.

^[1] Rear collision warning.

10.7. Connected Safety

10.7.1. Connected Safety

Connected Safety^[1] communicates information between your own car and other vehicles via the Internet^[2]. The function is intended to make a driver aware that there may be a potentially dangerous traffic situation further ahead on the same road.

The function can inform the driver whether another vehicle further ahead on the same road has activated its hazard warning flashers or detected slippery driving conditions. Information about slippery driving conditions is also given if your own car detects slippery surfaces.

Connected Safety can help the driver with the following:

- Alarm on hazard warning flashers
- Alarm on slippery driving conditions

Connected Safety communication between vehicles only works for vehicles equipped with the function and which have it activated.

Alarm on hazard warning flashers

If your own car's hazard warning flashers are activated, information about this can be sent to vehicles approaching your own car's position.



When your own car is approaching a vehicle with flashing hazard warning flashers, this symbol is shown on the driver display.

In vehicles with head-up display, the warning symbols for Connected Safety are also shown there.

Alarm on slippery driving conditions

If your own car detects reduced friction between your tyres and the road, information on this can be sent to vehicles approaching your own car's position.



If an ice alert is triggered, this symbol is displayed on the Driver display when a vehicle approaches the slippery road section, both in your own car and in other vehicles that have received the information via Connected Safety.

In vehicles with head-up display, the warning symbols for Connected Safety are also shown there.

Warning

- The function is supplementary driver support intended to facilitate driving and make it safer – it cannot handle all situations in all traffic, weather and road conditions.
- The driver is advised to read all sections in the Owner's Manual that relate to this function to learn about factors such as its limitations and what the driver should be aware of before using the system.
- Driver support functions are not a substitute for the driver's attention and judgement. The driver is always responsible for ensuring the car is driven in a safe manner, at the appropriate speed, with an appropriate distance to other vehicles, and in accordance with current traffic rules and regulations.

^[1] Not available on all markets.

^[2] Data is transferred (data traffic) when using the Internet, and this may involve a cost.

10.7.2. Activating and deactivating Connected Safety

For Connected Safety to be able to share information on road conditions with other vehicles, the function needs to be activated. The function can be deactivated if you do not want to share information.

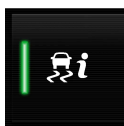

Activate or deactivate the function using this button in the centre display's function view.

- Illuminated button – the function is activated.
- Extinguished button – the function is deactivated.

When activated, special terms and conditions that appear on the display must be acknowledged by the driver before a connection to the Internet^[1] can be made. For example, a situation where the driver must accept data being sent from the car using his/her mobile phone.

If there is no Internet connection, your own car will still inform you, the driver, that slippery driving conditions have been detected by your own car. For Connected Safety to work fully, your own car needs to be connected to the Internet.

^[1] Data is transferred (data traffic) when using the Internet, and this may involve a cost.

10.7.3. Limitations of Connected Safety

Information about vehicles with activated hazard warning flashers or which have detected slippery driving conditions is not always communicated between all vehicles within the same area.

This can be because for example:

- Poor or no contact with the Internet.
- Vehicles on slippery surfaces make manoeuvres that are too weak for friction between tyres and road surface to be detectable, e.g. steering wheel movement, acceleration or braking.
- Vehicles that have detected slippery surfaces, or have activated their hazard warning flashers, do not have the function activated.
- Vehicles that have detected slippery surfaces, or have activated their hazard warning flashers, are not equipped with the function.
- There may be no warning due to missing or defective global positioning/satellite navigation.
- Detection of slippery surfaces or activation of hazard warning flashers has taken place on a road which is missing from Volvo Cars database.
- Connected Safety is not available in all markets and does not cover all areas - a retailer for Volvo has information on current areas.

Warning

- In certain situations, the function may give incorrect warnings for slippery driving conditions.
- The function cannot always detect other vehicles with activated hazard warning flashers or detect all sections of road with slippery surfaces.

10.8. City Safety

10.8.1. City Safety™

The content of this manual represents the status of the user manual at the time of printing and may not be completely valid in future instances. For more information, refer to the first page for the complete disclaimer note.

City Safety^[1] can use lights, sound and a brake pulse warning to alert the driver to pedestrians, cyclists, larger animals and vehicles.

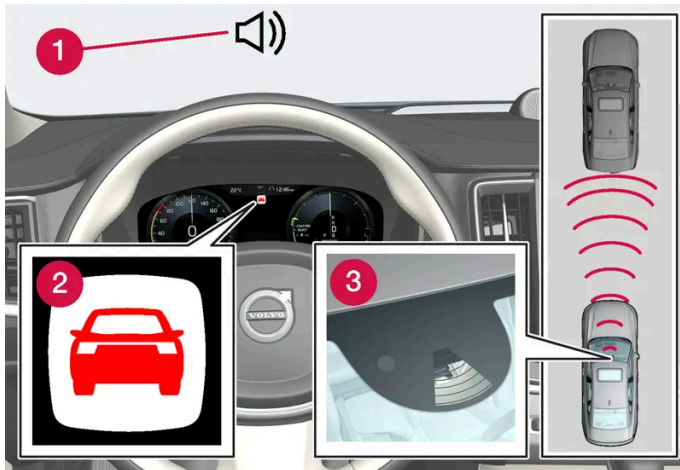

Function overview

- 1 Acoustic signal in the event of a risk of collision
- 2 Warning signal in the event of a risk of collision
- 3 Distance measurement with the camera and radar unit

The function can help the driver avoid a collision when, for example, driving in heavy traffic, where changes in the traffic ahead coupled with inattentiveness can lead to an incident. City Safety then activates brief, heavy braking and the car normally stops just behind the vehicle in front.

The function helps the driver by automatically braking the car in the event of an imminent risk of collision if the driver does not react in time by braking and/or swerving.

City Safety is activated in situations where the driver should have started braking earlier, which is why it cannot help the driver in every situation. The function is designed to be activated as late as possible in order to avoid unnecessary intervention. Automatic braking takes place only after or at the same time as the collision warning.

The driver or passengers are not normally aware of City Safety - it only intervenes in a situation where a collision is immediately imminent.

 **Warning**

- The function is supplementary driver support intended to facilitate driving and make it safer – it cannot handle all situations in all traffic, weather and road conditions.
- The driver is advised to read all sections in the Owner's Manual that relate to this function to learn about factors such as its limitations and what the driver should be aware of before using the system.
- Driver support functions are not a substitute for the driver's attention and judgement. The driver is always responsible for ensuring the car is driven in a safe manner, at the appropriate speed, with an appropriate distance to other vehicles, and in accordance with current traffic rules and regulations.

^[1] The function is not available in all markets.

10.8.2. Subfunctions for City Safety

City Safety^[1] can help to prevent a collision or reduce the collision speed. The function consists of several subfunctions.

Ability to reduce speed

If the speed difference between the driver's car and the obstacle is greater than the following specified speeds, the City Safety auto-brake function cannot prevent a collision but it can mitigate the consequences of a collision.

Vehicles

For a vehicle in front, City Safety can reduce the speed by up to 60 km/h (37 mph).

Cyclists

For a cyclist, City Safety can reduce the speed by up to 50 km/h (30 mph).

Pedestrians

For a pedestrian, City Safety can reduce speed by up to 45 km/h (28 mph).

Large animals

In the event of a risk of a collision with a large animal, City Safety can reduce the car's speed by up to 15 km/h (9 mph).

The brake function for large animals is primarily intended to reduce the force of the impact at higher speeds and is most effective at speeds above 70 km/h (43 mph) but less effective at lower speed.

The steps of City Safety

City Safety carries out three steps in the following order:

1. Collision warning
2. Brake support
3. Auto Brake

1 - Collision warning

The driver is first warned of a potentially imminent collision.

In cars equipped with a head up display*, the warning is shown on the windscreen by a flashing symbol.



Symbol for collision warning on the windscreen

Note

Strong sunlight, reflections, extreme light contrasts, the use of sunglasses, or if the driver is not looking straight ahead may make the visual warning signal in the windscreen difficult to recognise.

City Safety can detect pedestrians, cyclists or vehicles that are stationary or moving in the same direction as the car and are ahead. City Safety can also detect pedestrians, cyclists or large animals that are crossing the road in front of the car.

In the event of a risk of collision with a pedestrian, larger animal, cyclist or vehicle, the driver is alerted by means of a visual, acoustic and brake pulse warning. There is no brake pulse warning at lower speeds, sudden driver braking or acceleration. The brake pulse frequency varies according to the car's speed.

2 - Brake support

If the risk of collision has increased further after the collision warning then the brake support is activated.

Brake support reinforces the driver's braking action if the system considers that the braking is not sufficient to avoid a collision.

3 - Auto Brake

The automatic brake function is activated last.

If in this situation the driver has not yet started to take evasive action and the risk of collision is imminent then the automatic braking function is deployed - this takes place irrespective of whether or not the driver brakes. Braking then takes place with full brake force in order to reduce collision speed, or with limited brake force if it is sufficient to avoid a collision.

The seatbelt tensioner can be activated in connection with the engagement of the automatic brake function.

In some situations, the action of Auto-brake may begin with light braking and then progress to full brake action.

When City Safety has prevented a collision with a stationary object, the car remains stationary in anticipation of positive action by the driver. If the car has been braked to avoid collision with a slower vehicle in front, its speed is reduced to match that of the vehicle in front.

 **Note**

On cars with manual gearbox, the engine stops when the Auto-brake function has stopped the car, unless the driver has managed to depress the clutch pedal beforehand.

The driver can always interrupt a braking intervention by firmly depressing the accelerator pedal.

 **Note**

When City Safety brakes, the brake lights come on.

When City Safety is activated and brakes the vehicle, the driver display shows a text message to the effect that the function is/has been active.

 **Warning**

City Safety must not be used by the driver to change his/her driving style - the driver must not rely on City Safety alone and allow it to do the braking.

^[1] The function is not available in all markets.

* Option/accessory.

10.8.3. Setting the warning distance for City Safety

City Safety^[1] is always activated, but the driver can select the warning distance for the function.

 **Note**

The City Safety function cannot be deactivated. It is activated automatically when the engine/electric operation is started and remains switched on until the engine/electric operation is switched off.

The warning distance determines the sensitivity of the system and regulates the distance at which a visual, acoustic and brake pulse warning should be deployed.

To select warning distance:

- 1 Select **Settings** → **My Car** → **IntelliSafe** in the centre display's top view.
- 2 Under **City Safety Warning**, select either **Late**, **Normal** or **Early** to set the desired warning distance.

If the **Early** setting produces too many warnings, which could be perceived as irritating in certain situations, the **Normal** or **Late** warning distance can be selected.

When warnings are perceived as being too frequent or disturbing, the warning distance can be reduced, which reduces the total number of warnings and instead leads to City Safety giving a warning at a later stage.

The **Late** warning distance should therefore only be used in exceptional cases, as in dynamic driving.

Warning

- No automatic system can guarantee 100% correct function in all situations. Therefore, never test City Safety by driving at people, animals or vehicles - this may cause severe damage and injury and risk lives.
- City Safety warns the driver when there is a risk of a collision, but it cannot shorten the driver's reaction time.
- Even if the warning distance has been set to **Early** warnings could be perceived as being late in certain situations, e.g. when there are large differences in speed or if vehicles ahead suddenly brake heavily.
- With the warning distance set at **Early**, the warnings will come more in advance. This may mean that the warnings come more frequently than at the warning distance **Normal**, but it is recommended since it can make City Safety more effective.

^[1] The function is not available in all markets.

10.8.4. Messages for City Safety

A number of messages regarding City Safety can be shown in the driver display. Here are some examples.

Message	Specification
City Safety Automatic intervention	When City Safety brakes or has done an automatic braking, several of the driver display symbols may be illuminated in connection with a text message being shown.
City Safety Reduced functionality Service required	The system does not function as it should. A workshop should be contacted ^[1] .

A text message can be cleared by briefly pressing the  button, located in the centre of the steering wheel's right-hand keypad.

If a message persists, contact a workshop^[1].

^[1] An authorised Volvo workshop is recommended.

10.8.5. Limitations of City Safety

The City Safety^[1] function may have limitations in certain situations.

Surroundings

Low objects

Low-hanging objects, e.g. a flag/pennant for projecting load, or accessories such as auxiliary lamps and bull bars that are higher than the bonnet, will limit the function.

Skidding

On slippery road surfaces the braking distance is extended, which may reduce the capacity of City Safety to avoid a collision. In such situations, the anti-lock brakes and the stability control ESC^[2] are designed to give the best possible braking force with maintained stability.

Oncoming light

The visual warning signal in the windscreen may be difficult to notice in the event of strong sunlight, reflections, when sunglasses are being worn or if the driver is not looking straight ahead.

Heat

In the event of high passenger compartment temperature, caused by e.g. strong sunlight, the visual warning signal in the windscreen may be temporarily disengaged.

The camera and radar unit's field of view

The camera's field of vision is limited, which is why pedestrians, large animals, cyclists and vehicles in some situations cannot be detected, or they are detected later than anticipated.

Dirty vehicles may be detected later than others and if it is dark, motorcycles may be detected late or not at all.

If a text message in the driver display indicates that the camera or radar unit is obstructed, City Safety may be unable to detect pedestrians, large animals, cyclists, vehicles or road lines ahead of the car. This means that the functionality of City Safety may be reduced.

However, an error message is not shown in all situations where the windscreen sensors are obstructed. The driver must therefore take care to keep the area of windscreen in front of the camera and radar unit clear.

Important

Maintenance of driver support components must only be performed at a workshop – an authorised Volvo workshop is recommended.

Driver intervention

Reversing

When your own car is reversing, City Safety is temporarily deactivated.

Low speed

City Safety is not activated at very low speeds - below 4 km/h (3 mph) - and the system therefore does not intervene in situations where your car is approaching a vehicle ahead very slowly, e.g. when parking.

Active driver

Driver commands are always prioritised, which is why City Safety does not intervene or postpone warning/intervention in situations where the driver is steering and accelerating in a decisive manner, even if a collision is unavoidable.

Active and aware driving behaviour can therefore delay a collision warning and intervention in order to minimise unnecessary warnings.

Important warnings

Warning

Driver supports only warn of obstacles which their radar unit has detected – hence a warning may not be given, or it may be given with a certain delay.

- Never wait for a warning or intervention. Apply the brakes when the situation requires.

Warning

- Warnings and brake interventions could be implemented late or not at all if a traffic situation or external influences mean that the camera and radar unit cannot detect pedestrians, cyclists, large animals or vehicles correctly.
- For vehicles to be detected at night, their headlamps and rear lamp cluster must be switched on and shining clearly.
- The camera and radar unit has a limited range for pedestrians and cyclists. The system can provide effective warnings and brake interventions as long as the relative speed is below 50 km/h (30 mph). For stationary or slow-moving vehicles, warnings and brake interventions are effective at vehicle speeds up to 70 km/h (43 mph). Speed reduction for large animals is less than 15 km/h (9 mph) and can be achieved at vehicle speeds above 70 km/h (43 mph). The warning and brake intervention for large animals is less effective at lower speeds.
- Warnings for stationary or slow-moving vehicles as well as large animals may be disengaged due to darkness or poor visibility.
- Warnings and brake interventions for pedestrians and cyclists are deactivated at vehicle speeds exceeding 80 km/h (50 mph).
- Do not place, stick or mount anything on the outside or inside of the windscreen in front of or around the camera and radar unit — this can interfere with camera-dependent functions.
- Objects, snow, ice or dirt in the area of the camera sensor may reduce its functionality, fully deactivate it or give incorrect function response.

Warning

- The City Safety auto-brake function can prevent a collision or reduce collision speed, but to ensure full brake performance the driver should always depress the brake pedal – even when the car auto-brakes.
- The warning and steering assistance are only activated if there is a high risk of collision – you must therefore never wait for a collision warning or for City Safety to intervene.
- The warning and brake intervention for pedestrians and cyclists are deactivated at vehicle speeds exceeding 80 km/h (50 mph).
- City Safety does not activate any auto-brake functions in the event of heavy acceleration.

Note

This function uses the car's camera and radar units, which have certain general limitations.

Market limitation

City Safety is not available in all countries. If City Safety does not appear in the centre display's **Settings** menu, the car is not equipped with this function.

Search path in the top view of the centre display:

- **Settings** → **My Car** → **IntelliSafe**

^[1] The function is not available in all markets.

^[2] Electronic Stability Control

10.8.6. City Safety brakes for oncoming vehicles

City Safety can assist the driver to use emergency braking for an oncoming vehicle in your car's lane.

If an oncoming vehicle enters your car's lane and a collision is unavoidable, City Safety can reduce the car's speed with a view to reducing the violence of the impact.

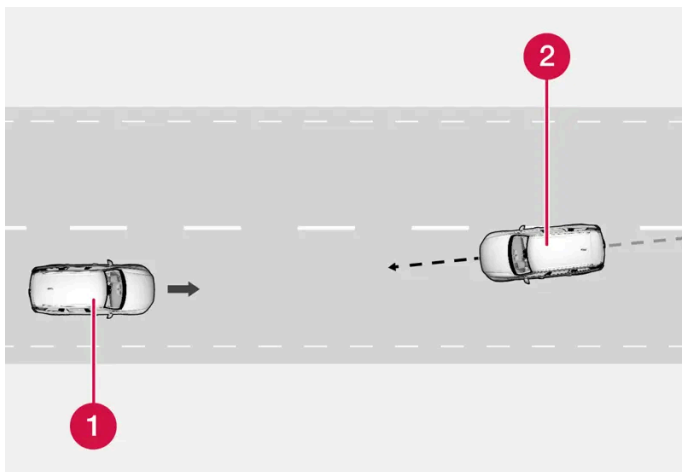

- 1 Your car
- 2 Oncoming vehicles

For this function to work, the following criteria must be met:

- your car must be travelling at more than 4 km/h (3 mph)
- the road section must be straight
- your car's lane must have clear lane markings
- your car must be positioned straight in its own lane

The content of this manual represents the status of the user manual at the time of printing and may not be completely valid in future instances. For more information, refer to the first page for the complete disclaimer note.

- the oncoming vehicle must be within your car's lane markings
- the oncoming vehicle must have its headlamps switched on
- this function can only handle "front to front" collisions
- this function can only detect vehicles with four wheels.

 **Warning**

Warnings and brake interventions due to an impending collision with an oncoming vehicle always come very late.

10.8.7. City Safety in cross traffic

City Safety^[1] can help the driver when turning and crossing the path of another oncoming vehicle at an intersection.

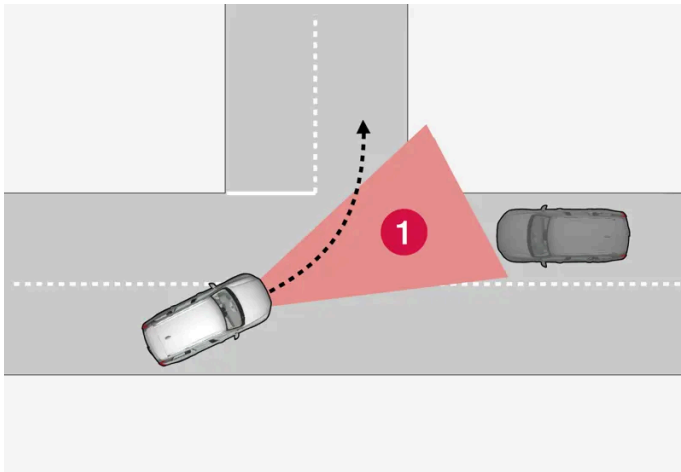

1 Sector in which City Safety can detect oncoming crossing vehicles.

For City Safety to detect an oncoming vehicle on a collision course, the oncoming vehicle must first enter the sector in which City Safety can analyse the situation.

In addition:

- your car's speed must be at least 4 km/h (3 mph).
- your car must turn to the left in markets with right-hand traffic (or to the right in left-hand traffic).
- the oncoming vehicle must have its headlamps switched on.

^[1] The function is not available in all markets.

10.8.8. Limitations for City Safety in cross traffic

The content of this manual represents the status of the user manual at the time of printing and may not be completely valid in future instances. For more information, refer to the first page for the complete disclaimer note.

In some cases City Safety may have difficulty helping the driver deal with collision risks due to oncoming cross traffic.

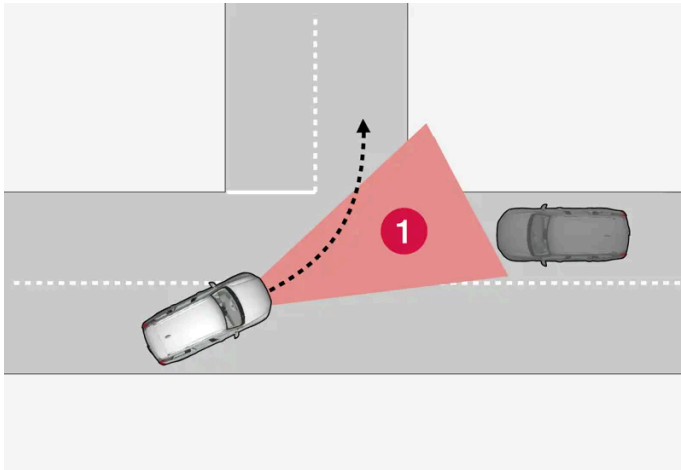

Examples are:

- If there are slippery driving conditions and stability control^[1] intervenes.
- If the oncoming vehicle is detected too late.
- If the oncoming vehicle is obscured by something.
- If the oncoming vehicle has headlamps switched off.
- If the oncoming vehicle drives in an unpredictable manner, for example, abruptly changes lanes at a late stage.

***i* Note**

This function uses the car's camera and radar units, which have certain general limitations.

^[1] Electronic Stability Control (ESC)

10.8.9. City Safety steering assistance for evasive manoeuvre

City Safety steering assistance can help the driver to steer away from a vehicle/obstacle when it is not possible to avoid a collision simply by braking. City Safety steering assistance cannot be switched off, it is always activated.

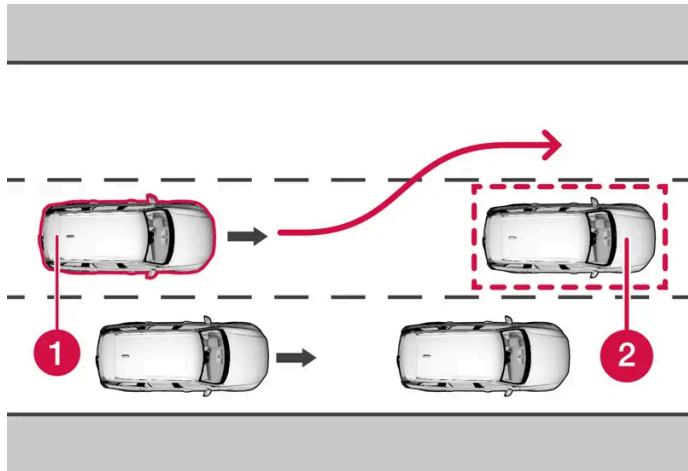

- 1 Your car steers away.
- 2 Slow moving/stationary vehicles or obstacles.

City Safety engages by amplifying the driver's steering input, which only occurs after the driver has begun an evasive manoeuvre - and then only if the driver is not steering enough to avoid a collision.

In parallel with the amplified steering input, the brake system is also used to further amplify the steering input. The function also helps to straighten the car again after passing the obstacle.

City Safety steering assistance can detect:

- vehicles
- cyclists
- pedestrians
- larger animals.

10.8.10. Limitations of City Safety steering assistance when taking evasive action

City Safety may have limited functionality in certain situations and fail to intervene e.g.:

- outside the speed range 50-100 km/h (30-62 mph)
- if the driver initiates an evasive manoeuvre
- if the steering servo creating speed-dependent steering wheel resistance is working at reduced power – e.g. when cooling due to overheating.

Note

This function uses the car's camera and radar units, which have certain general limitations.

10.8.11. Automatic braking in the event of an impeded evasive manoeuvre with City Safety

City Safety^[1] has the facility to assist the driver by automatically braking the car earlier when it is not possible to avoid a collision by only steering away.

City Safety assists the driver by continuously attempting to anticipate whether there are "escape routes" to the side in case a slow or stationary vehicle ahead is discovered at a late stage.

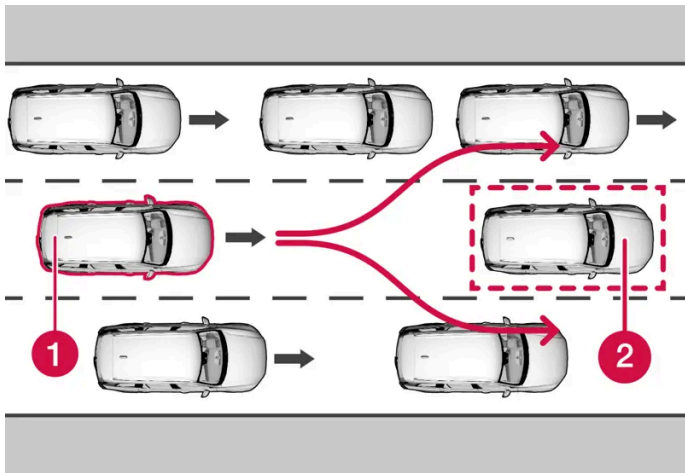

Your car (1) "sees" no options for evading the vehicle ahead (2) and can therefore auto-brake earlier.

- 1 Your car
- 2 Slow/stationary vehicle

City Safety does not intervene with the auto-brake function as long as the driver him/herself has the opportunity to avoid a collision via a steering manoeuvre.

However, if City Safety anticipates that an evasive manoeuvre is not possible due to traffic in an adjacent lane, the function can assist the driver by automatically starting to brake at an earlier stage.

^[1] The function is not available in all markets.

10.8.12. Detection of obstacles with City Safety

City Safety^[1] can help the driver to detect vehicles, cyclists, large animals and pedestrians.

Vehicles

City Safety detect most vehicles that are stationary or moving in the same direction as the driver's own car. This function can also detect oncoming vehicles and cross traffic in certain cases.

In order that City Safety shall be able to detect a vehicle in the dark, the vehicle's front and rear lights must be working and clearly illuminated.

Cyclists



Examples of what City Safety interprets as a cyclist — with clear body outline and bicycle outline.

Good performance requires that the system function that detects a cyclist must receive the clearest possible information about the body and bicycle outline, requiring the ability to identify the bicycle, head, arms, shoulders, legs, upper and lower body plus a normal human pattern of movement.

If large parts of the cyclist's body or bicycle are not visible to the function's camera then the system cannot detect a cyclist.

For the function to be able to detect a cyclist, he/she must be an adult and riding a bicycle designed for adults.

Warning

City Safety is supplementary driver support, but it cannot detect all cyclists in all situations and, for example, cannot see:

- partially obscured cyclists.
- cyclists if the background contrast for the cyclists is poor.
- cyclists wearing clothing that obscures the body outline.
- bicycles loaded with large objects.

Warnings and brake interventions could be late or not occur at all. The driver is always responsible that the vehicle is driven correctly and with a safety distance adapted to the speed.

Pedestrians

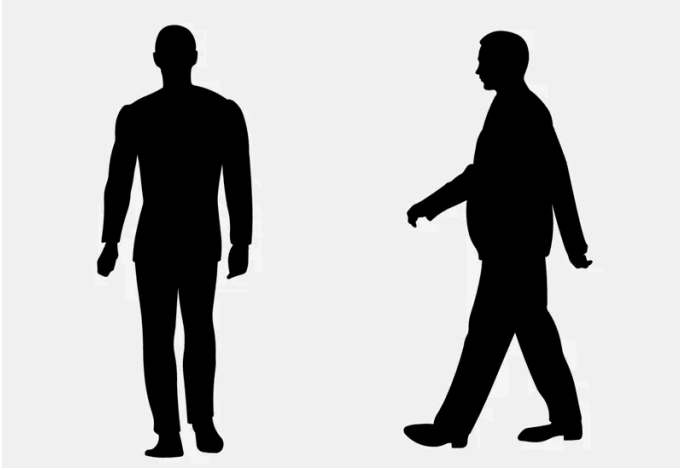

Examples of what the system regards as pedestrians with clear body outlines.

Good performance requires that the system function that detects a pedestrian must receive the clearest possible information about the body outline, requiring the ability to identify the head, arms, shoulders, legs, upper and lower body plus a normal human pattern of movement.

In order that it shall be possible to detect a pedestrian there must be a contrast with the background and this will be affected by such things as clothes, the background and the weather. With poor contrast the pedestrian may either be detected late or not at all, which may mean that warnings and braking are late or omitted.

City Safety can also detect pedestrians in the dark if they are illuminated by the car's headlamps.

Warning

City Safety is supplementary driver support, but it cannot detect all pedestrians in all situations and, for example, cannot see:

- partially obscured pedestrians, people in clothing that hides their body contour or pedestrians shorter than 80 cm (32 in.).
- pedestrians if the background contrast for the pedestrians is poor.
- pedestrians who are carrying larger objects.

Warnings and brake interventions could be late or not occur at all. The driver is always responsible that the vehicle is driven correctly and with a safety distance adapted to the speed.

Large animals

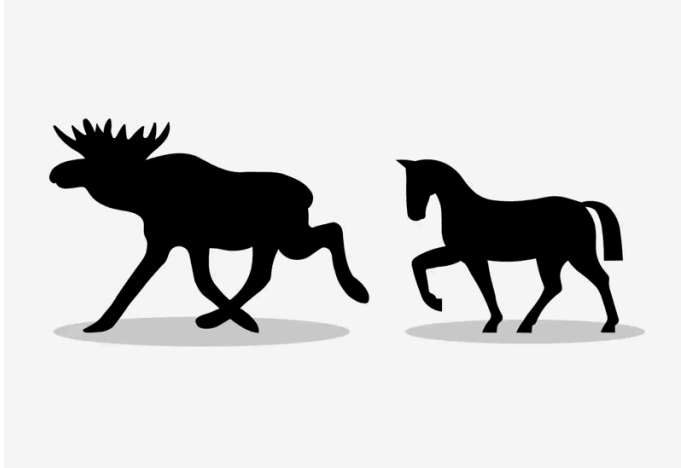

Examples of what City Safety interprets as large animals - standing still or walking slowly and with clear body outline.

Good performance requires that the system function that detects a large animal (e.g. elk and horse) must receive the clearest possible information about the body outline, requiring the ability to identify the animal directly from the side in combination with what is a normal pattern of movement for the animal.

If parts of the animal's body are not visible to the function's camera then the system cannot detect the animal.

City Safety can also detect large animals in the dark if they are illuminated by the car's headlamps.

Warning

City Safety is supplementary driver support, but it cannot detect all large animals in all situations and, for example, cannot see:

- partially obscured large animals.
- larger animals seen from the front or from behind.
- large animals that run or move quickly.
- large animals if the background contrast for the animals is poor.
- small animals such as dogs and cats, for example.

Warnings and brake interventions could be late or not occur at all. The driver is always responsible that the vehicle is driven correctly and with a safety distance adapted to the speed.

^[1] The function is not available in all markets.

10.9. Steering assistance at risk of collision

10.9.1. Steering assistance at risk of collision

The content of this manual represents the status of the user manual at the time of printing and may not be completely valid in future instances. For more information, refer to the first page for the complete disclaimer note.

The function **Collision avoidance** can help the driver reduce the risk of the car leaving its lane unintentionally and/or colliding with another vehicle or obstacle by actively steering the car back into its lane and/or swerving.

The function consists of these subfunctions:

- Steering assistance upon risk of run-off
- Steering assistance upon risk of head-on collision
- Steering assistance upon risk of rear-end collision*

After automatic engagement, the driver display indicates that this has occurred via a text message:

Collision avoidance Automatic intervention

Warning

- The function is supplementary driver support intended to facilitate driving and make it safer – it cannot handle all situations in all traffic, weather and road conditions.
- The driver is advised to read all sections in the Owner's Manual that relate to this function to learn about factors such as its limitations and what the driver should be aware of before using the system.
- Driver support functions are not a substitute for the driver's attention and judgement. The driver is always responsible for ensuring the car is driven in a safe manner, at the appropriate speed, with an appropriate distance to other vehicles, and in accordance with current traffic rules and regulations.

Note

It is always the driver who decides how much the car should steer – the car can never take command.

* Option/accessory.

10.9.2. Activating or deactivating steering assistance in the event of a collision risk

The steering assistance function is optional – the driver can choose to activate or deactivate it.



Activate or deactivate the function using this button in the centre display's function view.

- Illuminated button indication – the function is activated.
- Extinguished button indication – the function is deactivated.

This function is activated automatically each time the engine is started^[1].

 **Note**

When the **Collision avoidance** function is deactivated, all subfunctions are switched off:

- Steering assistance at risk of road departure
- Steering assistance at risk of oncoming collision
- Steering assistance at risk of rear-end collision *



Even though it is possible to deactivate the function, it is advisable for the driver to always have it activated since it improves driving safety in most cases.

^[1] In certain markets, the setting used when the engine is switched off is reactivated.

* Option/accessory.

10.9.3. Symbols and messages for steering assistance upon risk of collision

A number of symbols and messages regarding steering assistance may be shown in the driver display. Here are some examples.

Symbol	Message	Specification
	Collision avoidance Automatic intervention	When the function is activated, a message is shown to the driver indicating that the system has been activated.
	Windscreen sensor Sensor blocked, see Owner's manual	The ability of the camera to scan the roadway in front of the car is reduced.

A text message can be cleared by briefly pressing the  button, located in the centre of the steering wheel's right-hand keypad.

If a message remains: Contact a workshop – an authorised Volvo workshop is recommended.

10.9.4. Limitations for steering assistance at risk of collision

In certain situations the function may have limited functionality and fail to intervene in the following cases, for example:

- for small vehicles, such as motorcycles
- if the majority of the car has steered into the adjacent lane
- on roads/in lanes with unclear or non-existent lane markings
- outside the speed range 60-140 km/h (37-87 mph)

The content of this manual represents the status of the user manual at the time of printing and may not be completely valid in future instances. For more information, refer to the first page for the complete disclaimer note.

- as the steering servo for speed-dependent steering wheel resistance is working at reduced power – e.g. when cooling due to overheating.

Other demanding situations can include:

- road works
- winter road conditions
- narrow roads
- poor road surface
- a very “sporty” driving style
- poor weather with reduced visibility.

In these demanding situations, the function may have difficulty helping the driver correctly. In such cases it is recommended to switch off this function.



Warning

Warnings and steering assistance due to an impending collision with an oncoming vehicle always come very late.



Note

This function uses the car's camera and radar units, which have certain general limitations.

10.9.5. Steering assistance upon risk of run-off

Steering assistance has a number of subfunctions. Steering assistance in the event of run-off risk can help the driver and reduce the risk of the car accidentally leaving the road by actively steering the car back onto the road.

The function has two activation levels on intervention:

- Steering assistance only
- Steering assistance with brake intervention

Steering assistance only

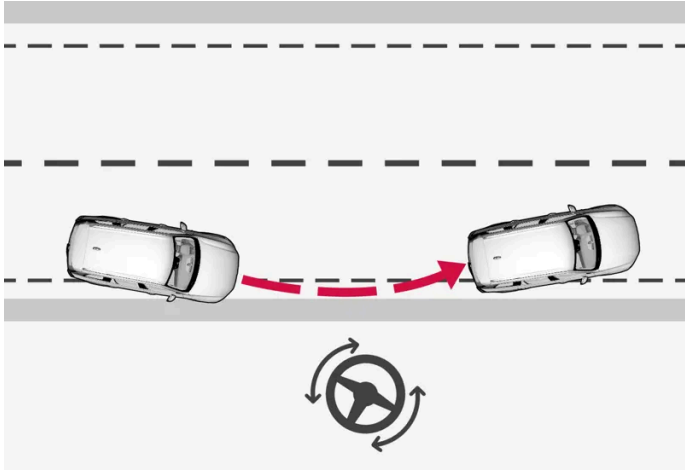

Intervention with steering assistance

Steering assistance with brake intervention

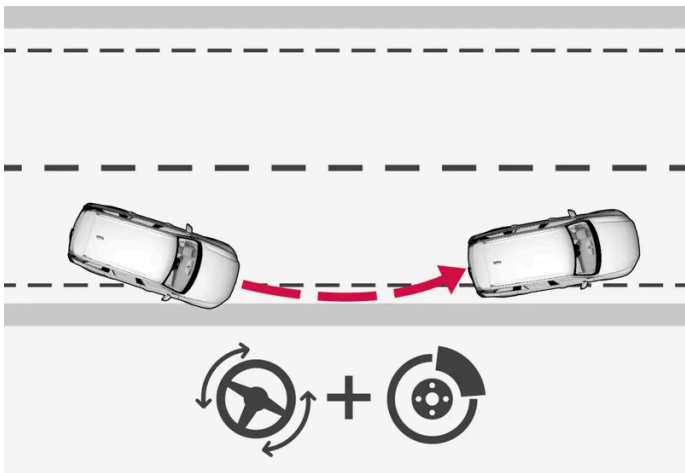

Intervention with steering assistance and braking

Brake intervention helps in situations where steering assistance alone is not sufficient. The brake force is adapted automatically depending on the situation at the time of road run-off.

The function is active within the speed range 65-140 km/h (40-87 mph) on roads with clearly visible lane markings/lines.

A camera scans the edges of the road and the painted side markings. If the car is about to leave the side of the road, the car is steered back onto the road and if the steering intervention is not enough to avoid run-off, the brakes are also activated.

However, the function does **not** intervene with either steering assistance or brake intervention if the direction indicators are used. And if the function detects that the driver is actively driving the car, activation of the function will be delayed.

When the function intervenes, a message is shown in the driver display.

10.9.6. Steering assistance upon risk of head-on collision

Steering assistance has a number of subfunctions. Steering assistance upon risk of head-on collision can help a distracted driver who does not notice that the car is heading into the opposite lane.

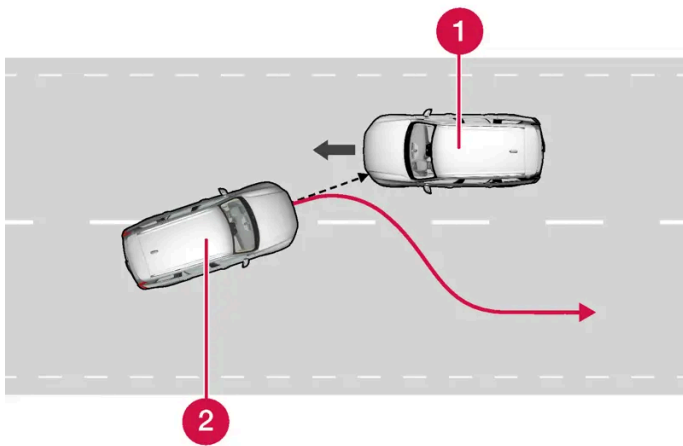

The function can assist by guiding the car back to its own lane.

- 1 Oncoming vehicles
- 2 Your car

At the same time as steering intervention is activated, collision warning for driver support is also activated. However, the brake pulse included in the collision warning will not be activated.

The function is active within the speed range 60-140 km/h (37-87 mph) on roads with clearly visible lane markings/lines.

If the car is about to leave its own lane while an oncoming vehicle is approaching at the same time, the function can help the driver to steer the car back into its own lane.

However, the function does **not** intervene with steering assistance if the direction indicator is used. And if the function detects that the driver is actively driving the car, activation of the function will be delayed.

When the function intervenes, a symbol and a message are shown in the driver display, and an acoustic signal can be heard as well.

10.9.7. Steering assistance upon risk of rear-end collision*

Steering assistance has a number of subfunctions. Steering assistance if there is a risk of rear-end collision can help a distracted driver who does not notice that the car is about to leave its own lane while an oncoming vehicle is approaching at the same time, either from behind or in the blind spot.

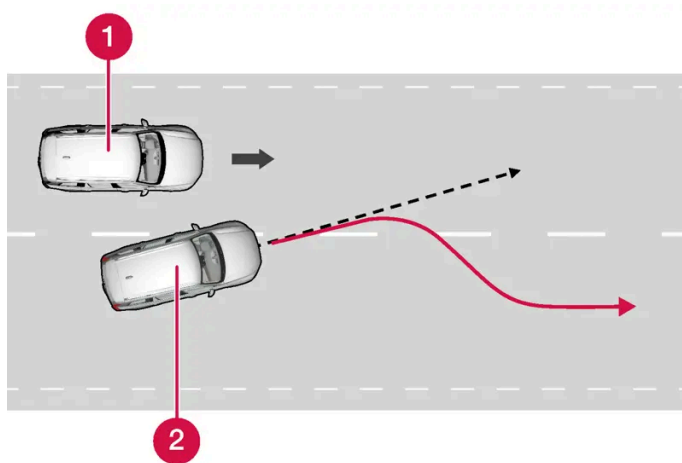

The function can assist by steering the car back to its own lane.

- 1 Other vehicle in the blind spot
- 2 Your car

If the car is about to leave its own lane while another vehicle is in the blind spot, or another vehicle is approaching rapidly in an adjacent lane at the same time, the function can help the driver to steer the car back into its own lane.

The function can even assist if the driver intentionally changes lanes using direction indicators without noticing that another vehicle is approaching.

The function is active within the speed range 60-140 km/h (37-87 mph) on roads with clearly visible lane markings/lines.

The lamps in the door mirrors flash during steering intervention, regardless of whether the BLIS^[1] function is activated. An acoustic signal can also be heard.

When the function intervenes, a message is shown in the driver display.

* Option/accessory.

^[1] Blind Spot Information

10.10. Driver Alert Control

10.10.1. Driver Alert Control

The Driver Alert Control (DAC) function is intended to help make the driver aware that he or she is starting to drive less consistently, e.g. if the driver becomes distracted or starts to fall asleep.

The objective for the function is to detect slowly deteriorating driving ability and it is primarily intended for major roads. The function is not intended for city traffic.

The function is activated when speed exceeds 65 km/h (40 mph) and remains active as long as the speed is over 60 km/h (37 mph).

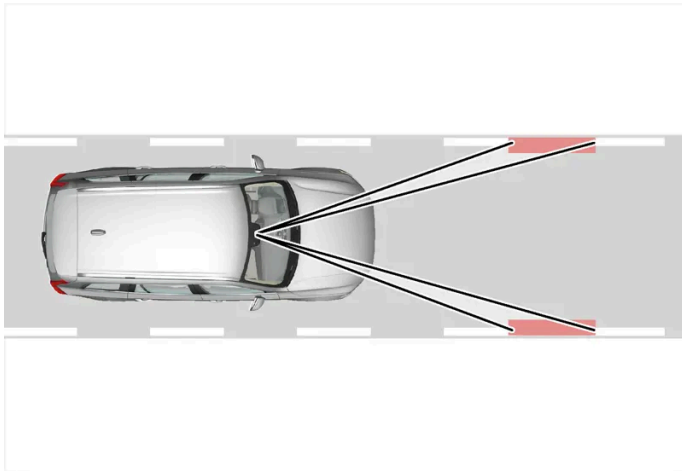

Driver Alert Control reads the position of the car in the lane.

A camera detects the edge markings painted on the carriageway and compares the alignment of the road with the driver's steering wheel movements.

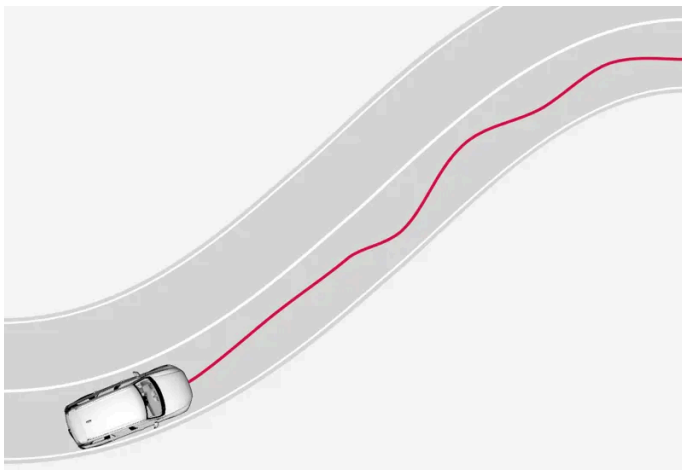

The car is being driven erratically in the lane.



If driving behaviour becomes noticeably inconsistent, the driver is alerted by this symbol in the driver display, combined with an acoustic signal and the text message **Time to take a break**.

If the car is equipped with Sensus Navigation* and has the function **Rest Stop Guidance** activated, suggestions for an appropriate place for a break are also displayed.

The warning is repeated after a time if driving behaviour has not improved.

 **Warning**

Driver Alert Control should not be used to extend a period of driving. The driver should instead plan for breaks at regular intervals and make sure they are well rested.

 **Warning**

An alarm from Driver Alert Control should be taken very seriously, as a sleepy driver is often not aware of his/her own condition.

If the alarm sounds or you feel fatigued:

- Stop the car safely as soon as possible and rest.

Studies have shown that it is just as dangerous to drive while tired as it is to drive under the influence of alcohol or other stimulants.

 **Warning**

- The function is supplementary driver support intended to facilitate driving and make it safer – it cannot handle all situations in all traffic, weather and road conditions.
- The driver is advised to read all sections in the Owner's Manual that relate to this function to learn about factors such as its limitations and what the driver should be aware of before using the system.
- Driver support functions are not a substitute for the driver's attention and judgement. The driver is always responsible for ensuring the car is driven in a safe manner, at the appropriate speed, with an appropriate distance to other vehicles, and in accordance with current traffic rules and regulations.

* Option/accessory.

10.10.2. Activating and deactivating Driver Alert Control

The Driver Alert Control (DAC) function can be activated or deactivated.

- 1 Tap on **Settings** in the centre display's top view.
- 2 Select **My Car** → **IntelliSafe** → **Driver Alert**.
- 3 Select or deselect **Alertness Warning** to activate or deactivate the function.

10.10.3. Selecting rest stop guidance in the event of a warning from Driver Alert Control

In cars equipped with Sensus Navigation*, the driver can activate a guide that can automatically suggest an appropriate rest area when Driver Alert Control (DAC) issues a warning.

It is possible to select whether the **Rest Stop Guidance** function should be activated or deactivated.

- 1 Tap on **Settings** in the centre display's top view.
- 2 Select **My Car** → **IntelliSafe** → **Driver Alert**.
- 3 Select or deselect **Rest Stop Guidance** to activate or deactivate the function.

* Option/accessory.

10.10.4. Limitations of Driver Alert Control

The Driver Alert Control (DAC) function may have limitations in certain situations.

In some cases the system may issue a warning despite driving ability not deteriorating, for example:

- in strong side winds
- on rutted road surfaces.

Warning

In some cases, driving behaviour is not affected despite driver fatigue – e.g. when using the Pilot Assist* function – resulting in the driver not getting a warning from DAC.

It is therefore important to always stop and take a break at the slightest feeling of fatigue, regardless of whether the function has given a warning.

Note

This function uses the car's camera and radar units, which have certain general limitations.

* Option/accessory.

10.11. Lane assistance

10.11.1. Lane assistance

The function of the Lane Keeping Aid (LKA^[1]) is to help the driver to reduce the risk of the car accidentally leaving its own lane on motorways and similar major routes.

Lane Keeping Aid steers the car back into its lane and/or alerts the driver with vibrations in the steering wheel.

Lane Keeping Aid is active within the speed range 65–200 km/h (40–125 mph) on roads with clearly visible side lines.

On narrow roads the function may be unavailable, in which case it goes into standby mode. The function becomes available again when the road is wide enough.

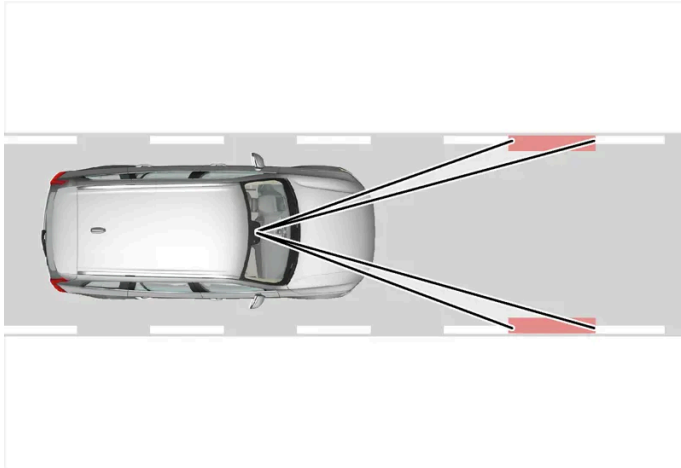

A camera reads the side lines of the road/lane.

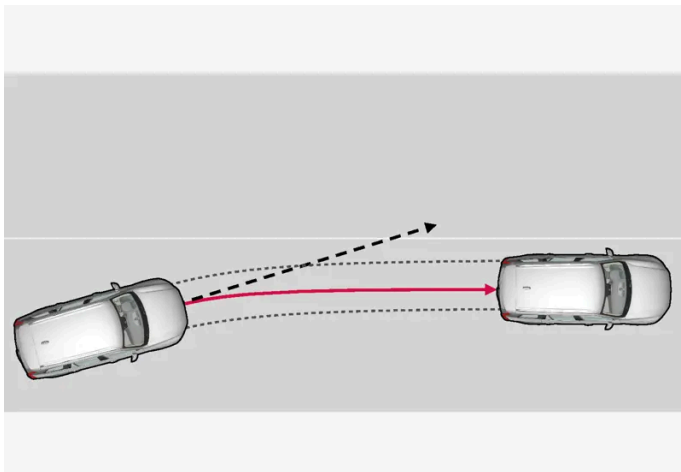

Lane assistance steers the car back into its lane.

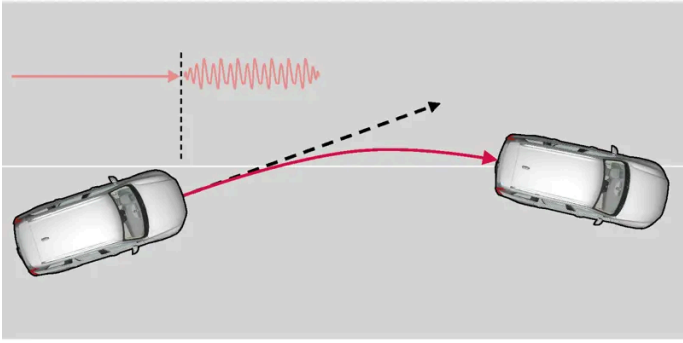

Lane assistance warns with steering wheel vibrations.

Depending on settings, lane assistance acts in accordance with the following:

- **Assist** activated: When the car is approaching a lane line, the function will actively steer the car back into its lane by applying a slight torque to the steering wheel.
- **Warning** activated: If the car is about to cross a lane line, the driver is warned by means of vibrations in the steering wheel.
- There is also an option where both steering assistance and warning are activated simultaneously.

Note

When a direction indicator/flasher is switched on, there are no steering corrections or alerts from lane assistance.

Warning

- The function is supplementary driver support intended to facilitate driving and make it safer – it cannot handle all situations in all traffic, weather and road conditions.
- The driver is advised to read all sections in the Owner's Manual that relate to this function to learn about factors such as its limitations and what the driver should be aware of before using the system.
- Driver support functions are not a substitute for the driver's attention and judgement. The driver is always responsible for ensuring the car is driven in a safe manner, at the appropriate speed, with an appropriate distance to other vehicles, and in accordance with current traffic rules and regulations.

Lane assistance does not intervene

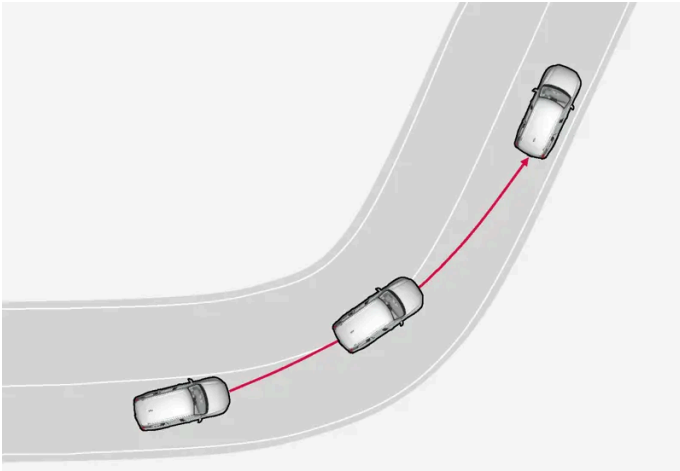

Lane assistance does not engage on sharp inside curves.

In some situations, lane assistance allows lane lines to be crossed without intervening with either steering assistance or a warning – e.g. when using the direction indicators or if the car is allowed to cut the corners in bends.

Hands on the steering wheel

For steering assistance with lane assistance to work, the driver must have his/her hands on the steering wheel, which the system will continue to monitor.



If the driver does not keep his/her hands on the steering wheel, a warning signal is heard and a message encourages the driver to steer the car actively:

- Lane Keeping Aid Apply steering

If the driver does not follow the prompt to start steering, the function is set in standby mode, and this message is shown:

- Lane Keeping Aid Standby until steering applied

The function will then be unavailable until the driver starts to steer the car again.

^[1] Lane Keeping Aid

10.11.2. Activating and deactivating lane assistance

The Lane Keeping Aid (LKA) function (LKA^[1]) is optional – the driver can choose to activate or deactivate this function.



Activate or deactivate the function using this button in the centre display's function view.

- Illuminated button – the function is activated.
- Extinguished button – the function is deactivated.

^[1] Lane Keeping Aid

10.11.3. Difference between Pilot Assist* and lane assistance

Pilot Assist is a comfort function that can help you to keep your car within its own lane and maintain a safe distance from vehicles in front of you. Lane assistance^[1] is a function which, in a similar way, can help you in some situations to reduce the risk of your car accidentally leaving its own lane.

Pilot Assist

Pilot Assist can help you to steer your car between the lane's markings, as well as maintaining a preset speed and time interval to the vehicle ahead. The function can also help to maintain an advantageous position in the lane using the lane's lane lines.

What does Pilot Assist do?

- Can help to keep the car within its lane by assisting steering in some cases.
- Can help to maintain a preset speed or the distance to the vehicle ahead by means of acceleration and braking operations.

How do I know when Pilot Assist is operational?

Symbols in the driver's display in the car indicate when this function is operational.

When the steering wheel in the middle is extinguished, Pilot Assist is running but steering assistance is not active.

When the steering wheel is illuminated, Pilot Assist is running and steering assistance is active.

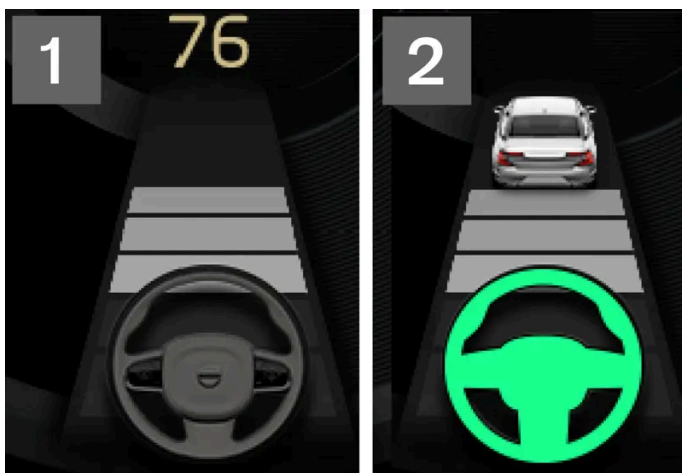

² When the steering wheel symbol in the driver display is illuminated, Pilot Assist is helping you to steer.

Lane assistance

Lane assistance can provide steering assistance and/or give you an alert when the vehicle is about to leave its own lane unintentionally. This function is active in the speed range 65-200 km/h (40-125 mph) on roads with clearly visible lane lines.

What does lane assistance do?

- Lane assistance can provide the driver with steering assistance, steering the car back into its lane and/or providing warnings using acoustic signals or steering wheel vibration.

How do I know when lane assistance is operational?

Symbols in the driver's display in the car show the status of the function.



An extinguished symbol in the driver display means that the function is running but the conditions for LKA have not been met.



A white symbol in the driver's display means that the conditions for LKA have been met and that the function is available.



An orange symbol in the driver's display means that LKA is providing steering assistance back in to the lane and/or will provide warnings using acoustic signals or steering wheel vibration.

Warning

The driver always bears responsibility for ensuring that the car is driven safely. Before using this function, the driver is recommended to read all sections on the function in the owner's manual.

Warning

- The function is supplementary driver support intended to facilitate driving and make it safer – it cannot handle all situations in all traffic, weather and road conditions.
- The driver is advised to read all sections in the Owner's Manual that relate to this function to learn about factors such as its limitations and what the driver should be aware of before using the system.
- Driver support functions are not a substitute for the driver's attention and judgement. The driver is always responsible for ensuring the car is driven in a safe manner, at the appropriate speed, with an appropriate distance to other vehicles, and in accordance with current traffic rules and regulations.

* Option/accessory.

[1] Lane Keeping Aid

10.11.4. Select assistance option for lane assistance





The driver can select how the Lane Keeping Aid (LKA^[1]) should react if the car leaves its lane.

- 1 Select **Settings** → **My Car** → **IntelliSafe** in the centre display's top view.
- 2 In the event of **Lane Keeping Aid Mode**, select how the function should react:
 - **Assist** - the driver is given steering assistance without a warning.
 - **Warning** – the driver is only warned by steering wheel vibration.
 - **Both** – the driver is given a warning both from the steering wheel vibrating and from steering assistance.

^[1] Lane Keeping Aid

10.11.5. Symbols and messages for lane assistance

A number of symbols and messages regarding lane assistance (LKA^[1]) can be shown on the driver display. Here are some examples.

Symbol	Message	Specification
	Driver support system Reduced functionality Service required	The system does not function as it should. A workshop should be contacted ^[2] .
	Windscreen sensor Sensor blocked, see Owner's manual	The ability of the camera to scan the roadway in front of the car is reduced.
	Lane Keeping Aid Apply steering	The LKA steering assistance does not function if the driver does not have his/her hands on the steering wheel. Follow the instruction and steer the car.
	Lane Keeping Aid Standby until steering applied	LKA is set in standby mode until the driver starts to steer the car again.

A text message can be cleared by briefly pressing the  button, located in the centre of the steering wheel's right-hand keypad.

If a message remains, contact a workshop - an authorised Volvo workshop is recommended.

^[1] Lane Keeping Aid

^[2] An authorised Volvo workshop is recommended.

10.11.6. Display mode for lane assistance

Lane assistance (LKA^[1]) is visualised by symbols in the driver display depending on the situation.



Here are some examples of symbols and the situations in which they are shown:

Available



Available – the lane lines in the symbol are white.

Lane assistance is scanning one or both lane lines.

Unavailable

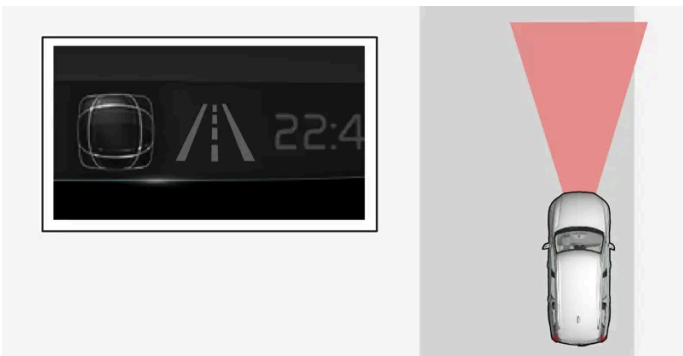

Unavailable – the lane lines in the symbol are extinguished.

The Lane assistance cannot detect the lane lines, the speed is too low or the road is too narrow.

Indication of steering assistance/warning



Steering assistance/warning – the lane lines in the symbol are coloured.

Lane assistance indicates that the system is giving a warning and/or attempting to steer the car back into the lane.

10.11.7. Limitations of Lane assistance

In certain demanding conditions lane assistance (LKA ^[1]) may have difficulty helping the driver correctly. In such cases it is recommended to switch off this function.

Examples of such conditions are:

- road works
- winter road conditions
- poor road surface
- a very “sporty” driving style
- poor weather with reduced visibility
- roads with unclear or non-existent side markings
- sharp edges or lines other than the lane's side markings
- as the steering servo for speed-dependent steering wheel resistance is working at reduced power – e.g. when cooling due to overheating.

The function is unable to detect barriers, rails or similar obstacles at the side of the carriageway.

Note

This function uses the car's camera and radar units, which have certain general limitations.

10.12. Electronic stability control

10.12.1. Electronic stability control

Electronic Stability Control (ESC ^[1]) helps the driver to avoid skidding and improves the car's traction.



The driver display shows this symbol when the system is engaged.

Braking from the system may be heard as a pulsing sound, and the car may accelerate more slowly than expected when applying the throttle.

The system consists of the following subfunctions:

- Stability function ^[2]
- Spin control and traction control system
- Engine Drag Control
- Trailer stability assist
- Roll Stability Control

 **Warning**

- The function is supplementary driver support intended to facilitate driving and make it safer – it cannot handle all situations in all traffic, weather and road conditions.
- The driver is advised to read all sections in the Owner's Manual that relate to this function to learn about factors such as its limitations and what the driver should be aware of before using the system.
- Driver support functions are not a substitute for the driver's attention and judgement. The driver is always responsible for ensuring the car is driven in a safe manner, at the appropriate speed, with an appropriate distance to other vehicles, and in accordance with current traffic rules and regulations.

Stability function ^[2]

The function checks the driving and brake force of the wheels individually in order to stabilise the car.

Spin control and traction control system

The function is active at low speed and brakes the drive wheels that spin so that additional traction shall be transferred to the drive wheels that are not spinning.

The function can also prevent the driving wheels from spinning against the road surface during acceleration.

Engine Drag Control

Engine Drag Control (EDC ^[3]) can prevent involuntary wheel lock-up, e.g. when engine braking on slippery road surfaces. Involuntary wheel locking while driving can, amongst other things, impair the driver's ability to steer the car.

Trailer stability assist* ^[4]

Trailer stability assist (TSA ^[5]) stabilises a car towing a trailer in situations where they begin snaking.

 **Note**

Trailer Stability Assist is deactivated if **ESC Sport Mode** is activated.

Roll Stability Control

This function reduces the risk of overturning, for example during a sudden evasive manoeuvre or if the car skids. The system registers if and how much the car's lateral inclination changes. This information is used to calculate the risk of the car overturn-

ing. If the car is at risk, its electronic stability control system engages, the engine torque is reduced and one or more wheels are braked until the car has regained its stability.

 **Warning**

Under normal driving conditions, the system improves the car's road safety, but this must not be taken as a reason to increase speed. Always follow the normal precautions for safe driving.

^[1] Electronic Stability Control

^[2] Also known as Active Yaw Control.

^[3] Engine Drag Control





* Option/accessory.

^[4] Trailer stability assist is included when the Volvo genuine towbar is installed.

^[5] Trailer Stability Assist

10.12.2. Symbols and messages for electronic stability control

A number of symbols and messages regarding electronic stability control (ESC^[1]) can be shown on the driver display. Here are some examples.

Symbol	Message	Specification
	Constant glow for approx. 2 seconds	System check when the engine is started.
	Flashing light	The system is being activated.
	Constant glow	Sport mode is activated. NOTE: The system is not deactivated in this mode – it is partly reduced.
	ESC Temporarily off	The system has been temporarily reduced due to excessive brake temperature - the function is reactivated automatically when the brakes have cooled.
	ESC Service required	The system is disengaged. Stop the car in a safe place, switch off the engine and start it again.

A text message can be cleared by briefly pressing the  button, located in the centre of the steering wheel's right-hand keypad.

If a message remains, contact a workshop - an authorised Volvo workshop is recommended.

^[1] Electronic Stability Control

10.12.3. Electronic Stability Control in sport mode

The stability system (ESC ^[1]) is always activated – it cannot be switched off. However, the driver can select ECS Sport mode, which allows for a more active driving experience.

With Sport mode selected, interventions from the system are reduced and the car is allowed to skid more and greater control than normal is thus transferred to the driver.

When Sport mode is selected, the function can be considered as deactivated, despite the function continuing to help the driver in many cases.

Note

With Sport mode selected, trailer stability assist (TSA) (TSA ^[2]) is deactivated.

Sport mode also provides more traction even if the car has become bogged down or is driving on a loose surface, such as in sand or deep snow.

^[1] Electronic Stability Control

^[2] Trailer Stability Assist

10.12.4. Activating and deactivating sport mode for electronic stability control

The stability system (ESC ^[1]) is always activated – it cannot be switched off. However, the driver can select sport mode, which allows for a more active driving experience.



The driver display indicates activated **ESC Sport Mode** by displaying this symbol with a constant glow until the function is deactivated or the engine is switched off. The next time the engine is started, the system is back in its normal mode again.



Activate or deactivate the function using this button in the centre display's function view.

- Illuminated button – the function is activated.
- Extinguished button – the function is deactivated.

The Sport mode function cannot be selected when one of the following functions is activated:

- Speed limiter
- Cruise control
- Adaptive cruise control *

- Pilot Assist*

^[1] Electronic Stability Control

* Option/accessory.

10.13. Road Sign Information

10.13.1. Road Sign Information*

The Road Sign Information function (RSI^[1]) can help the driver to observe speed-related road signs and certain prohibition signs.

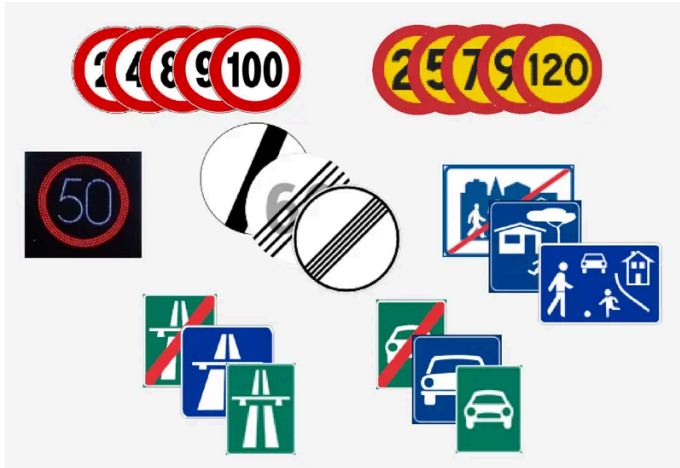

Examples of readable signs^[2].

RSI can provide information about such things as current speed, when a motorway or road is starting/ending, when overtaking is prohibited or when the direction of travel is one-way.

If the car passes a speed limit sign, it will be shown in the driver's display and the Head-up display*.

Road sign information (RSI^[1]) also includes subfunctions that can warn the driver if a speed limit has been exceeded or in connection with speed cameras.

Note

In certain markets, the road sign information function is only available in combination with map data.

 **Warning**

- The function is supplementary driver support intended to facilitate driving and make it safer – it cannot handle all situations in all traffic, weather and road conditions.
- The driver is advised to read all sections in the Owner's Manual that relate to this function to learn about factors such as its limitations and what the driver should be aware of before using the system.
- Driver support functions are not a substitute for the driver's attention and judgement. The driver is always responsible for ensuring the car is driven in a safe manner, at the appropriate speed, with an appropriate distance to other vehicles, and in accordance with current traffic rules and regulations.

* Option/accessory.

^[1] Road Sign Information

^[2] Road signs are market-dependent - illustrations in these instructions only show a few examples.

10.13.2. Road Sign Information and Sensus Navigation *

The Road Sign Information function (RSI^[1]) can receive speed-related information from Sensus Navigation.

If the car is equipped with Sensus Navigation *, speed information is read from the navigation unit in the following cases:

- On detection of signs that indirectly indicate a speed limit, such as motorway, dual carriageway and city limit signs.
- If a previously detected speed sign is assumed not to apply any longer, but no new sign has been detected.

 **Note**

In certain markets, the Road Sign Information function * is only available in combination with Sensus Navigation *.

 **Note**

If a downloaded third-party app is used for navigation then there is no support for speed-related information.

* Option/accessory.

^[1] Road Sign Information

10.13.3. Activating and deactivating Road Sign Information *

The Road Sign Information function (RSI^[1]) is optional – the driver can choose to activate or deactivate this function.



Activate or deactivate the function using this button in the centre display's function view.

- Illuminated button – the function is activated.
- Extinguished button – the function is deactivated.

Note

- If the automatic speed limiter function is activated, road sign information is shown in the driver display even if the Road Sign Information function is not activated.
- To remove road sign information from the driver display, you must deactivate **both** the automatic speed limiter and Road Sign Information.
- When the automatic speed limiter function is activated but Road Sign Information is deactivated, no warnings are given from Road Sign Information. Road Sign Information must also be activated in order to receive warnings.

* Option/accessory.

^[1] Road Sign Information

10.13.4. Limitations of Road Sign Information *

The Road Sign Information (RSI^[1]) function may have limitations in certain situations.

Examples of what can reduce the function are as follows:

- Faded signs
- Signs positioned on bends
- Rotated or damaged signs
- Signs positioned high above the roadway
- Fully/partially obscured or poorly positioned signs
- Signs completely or partly covered with frost, snow and/or dirt
- Digital road maps^[2] with outdated, incorrect or missing speed information^[3]

Note

In certain markets, the road sign information function is only available in combination with map data.

Note

The RSI function may interpret some types of bicycle rack, connected to the electrical socket for trailers, as a connected trailer. In such cases, the driver display may show incorrect speed information.

Note

This function uses the car's camera and radar units, which have certain general limitations.

* Option/accessory.

[1] Road Sign Information

[2] In cars equipped with Sensus Navigation*.

[3] Map data with speed information does not exist for all areas.

10.13.5. Warning for speed limitation and speed camera from road sign information*

Road sign information (RSI^[1]) includes subfunctions that can warn the driver if a speed limit has been exceeded or in connection with speed cameras.



Warning for speed limit



The speed warning is given by the driver display symbol^[2] showing the applicable maximum permitted speed temporarily flashing when this speed is exceeded.

A speed warning is always given if the speed limit is exceeded in connection with speed camera information.

The speed warning alerts the driver when the applicable speed limit or stored maximum speed is exceeded. This warning is repeated once after approx. 1 minute within one and the same speed limit zone unless the driver reduces the speed.

A new warning for exceeding the speed limit, including a reminder, will be given only when the car reaches an area with a different speed limit.

 **Note**

To get an acoustic warning if you exceed the required speed, the **Speed Limit Warning** function must be activated and the **Road Sign Audio Warning** subfunction must be set to **On**. An acoustic warning is then given if the car's speed exceeds the speed indicated by the Road Sign Information function in the driver display.

Warning for speed camera



A car equipped with Road Sign Information and map data^[3] can provide information on an upcoming speed camera in the driver display^[4].

If the car exceeds a detected speed limit with the Speed warning function activated, a speed warning is given when the car approaches a speed camera, provided that the navigation map for the area in question contains information on speed cameras.

 **Note**

An option is available to receive an acoustic warning for speed cameras independently of the car's speed and exceeded speed limit, even if the **Road Sign Audio Warning** function is deactivated.

* Option/accessory.

^[1] Road Sign Information

^[2] Road signs are customised for each market – the one shown here is just an example.

^[3] Sensus Navigation

^[4] Information on speed cameras on the navigation map is not available for all markets/areas.

10.13.6. Activating and deactivating warnings from road sign information *

The driver can choose which warnings are activated for road sign information (RSI^[1]) and adjust the limit for them.

- 1 Select **Settings** → **My Car** → **IntelliSafe** → **Road Sign Information** in the centre display's top view.
- 2 Select **Speed Limit Warning** and the desired settings.

You can choose to do the following:

- Activate speed warning
- Adjust the limit for Speed Warning^[2]
- Activating acoustic warning in connection with speed warning^[3]
- Activating acoustic warning in connection with speed camera warning^[4]

* Option/accessory.

^[1] Road Sign Information

^[2] The function does not take account of the selected limit adjustment when the driver display shows the symbol for speed camera.

^[3] The driver can also be warned when driving towards one-way traffic/no entry road. Applies to certain markets.

^[4] The car needs access to map data with information on speed cameras.

10.13.7. Display mode for road sign information *

The Road Sign Information function (RSI^[1]) shows road signs in different ways depending on the sign and the situation. The following illustrations are examples.



Example^[2] of detected speed information.

When the function detects a road sign with an imposed speed limit the driver display shows the sign as a symbol combined with a coloured indication on the speedometer.

If the car is equipped with map data*, speed-related information is also obtained from map data, which means that the driver display can show or change information on the speed limit without having passed a speed-related sign.



An additional sign, such as "no overtaking", may be shown together with the speed limit symbol.



If the driver enters a road marked with this no-entry sign on each side, or on one side with confirmation from map data, the symbol for this sign flashes on and off in the driver display to warn the driver. The driver can also be given an acoustic warning when driving towards a no-entry road if the function for acoustic warning for road signs is activated.^[3]

Speed limit or end of motorway

When the function detects an "indirect speed limit sign" stating the end of the current speed limit – e.g. at the end of a motorway – a symbol appears with the corresponding road sign in the driver's display.

If the car is equipped with map data*, direct speed limit signs are normally displayed – indirect speed limit signs are only displayed if map data has no information on the speed limit for the road section in question.

Example of indirect speed limit sign:

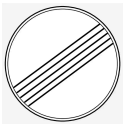

End of all restrictions.



End of motorway.

The driver display symbol extinguishes after 10-30 seconds and remains so until the next speed related sign is passed.

Changed speed limit

When passing a direct speed limit sign when a speed limit changes a symbol with the corresponding road sign appears in the driver's display.



Example of direct speed limit sign.

The driver display symbol extinguishes after about 5 minutes until the next speed-related sign is passed.

If the car is equipped with map data*, speed limit signs are shown in the driver display when map data contains information on the speed limit for the road section in question, even if no direct sign has been passed. If there is no information in map data, the sign is extinguished approx. 3 minutes after the last passing of a speed limit sign.

Additional signs

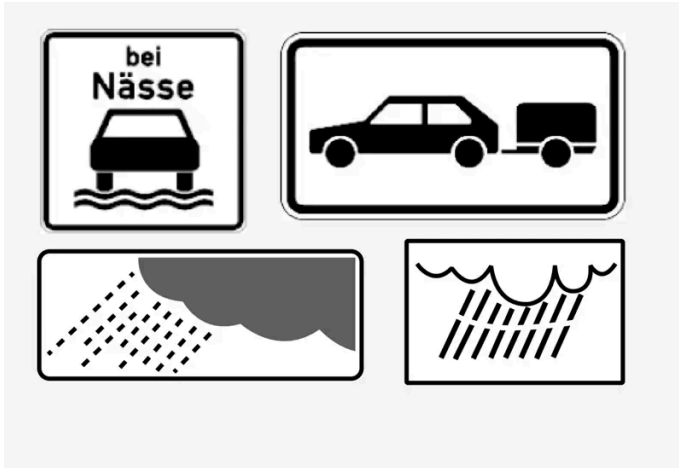

Examples of additional signs.

Sometimes different speed limits are signed for the same road - an additional sign then indicates the circumstances under which the different speeds apply. The road section may be particularly susceptible to accidents in rain and/or fog, for example.

An additional sign relating to rain is displayed only if the windscreen wipers are in use.

If a trailer is connected to the car's electrical system and you pass a speed sign with the additional sign "trailer", the indicated speed will appear on the driver display.

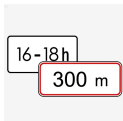

Some speed limits only apply after a certain distance or at a certain time of day. The driver's attention is drawn to this fact by means of a symbol for an additional sign below the speed symbol.

The additional symbol in the driver display will show either "DIST" or "TIME".

Sign for "School" and "Children at play"



If a warning sign for "School" or "Children at play" is included in the map data*, the driver display shows a sign of this type.

* Option/accessory.

[1] Road Sign Information

[2] Road signs are market-dependent - the illustrations in these instructions only show examples.

[3] Applies to certain markets.

10.14. Parking functions

10.14.1. Parking assistance

The content of this manual represents the status of the user manual at the time of printing and may not be completely valid in future instances. For more information, refer to the first page for the complete disclaimer note.

10.14.1.1. Park Assist *

The Parking Assistance System (PAS^[1]) uses sensors to assist the driver when manoeuvring in tight spaces by indicating the distance to obstacles through acoustic signals combined with a graphic in the centre display.



Example of screen view with obstacle zones and sensor sectors.

The centre display shows an overview of the relationship between the car and detected obstacles.

The highlighted sector indicates the location of the obstacle. The closer the car symbol is to a highlighted sector box at the front/back, the shorter the distance between the car and detected obstacle.

The side sectors change colour as the distance between the car and an object is reduced.

The shorter the distance to the obstacle, the faster the signal sounds. Other sound from the audio system is muted automatically.

The acoustic signal for obstacles ahead and to the sides is active when the car is moving but stops after the car has been stationary for approx. 2 seconds. The acoustic signal for obstacles behind is also active when the car is stationary.

At a distance within approx. 30 cm (1 foot) from an obstacle behind or in front of the car, the tone is constant and the active sensor field closest to the car symbol is filled.

At a distance within approx. 25 cm (0.8 foot) from an obstacle To the sides, the tone pulses intensively and the active sector field changes colour from ORANGE to RED.

The volume of the parking assistance signal can be adjusted while the signal is sounding by means of the [[>11](#)] knob on the centre console. Adjustment can also be performed in the parking assistance system's settings.

Note

Except in the sector nearest to the car symbol, audible warnings are only given for objects directly in the path of the car.

 **Warning**

- The function is supplementary driver support intended to facilitate driving and make it safer – it cannot handle all situations in all traffic, weather and road conditions.
- The driver is advised to read all sections in the Owner's Manual that relate to this function to learn about factors such as its limitations and what the driver should be aware of before using the system.
- Driver support functions are not a substitute for the driver's attention and judgement. The driver is always responsible for ensuring the car is driven in a safe manner, at the appropriate speed, with an appropriate distance to other vehicles, and in accordance with current traffic rules and regulations.

* Option/accessory.

^[1] Park Assist System

10.14.1.2. Park Assist System front, rear and along the sides*

Parking Assistance System (PAS^[1]) has different behaviour depending on which part of the car is approaching an obstacle.

Forwards

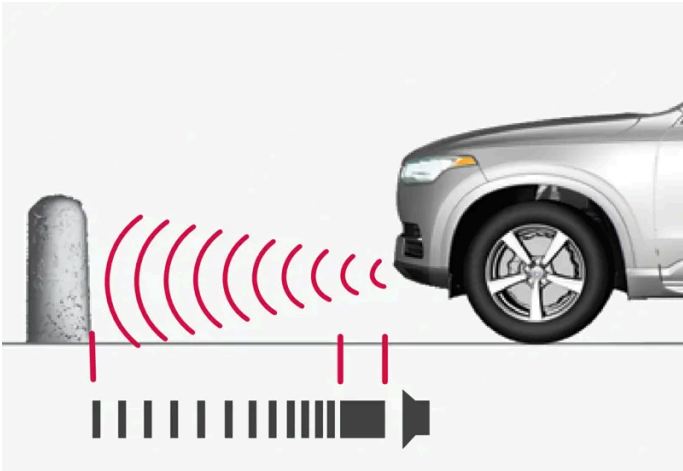

The warning signal has a constant acoustic signal at less than approx. 30 cm (1 foot) from an obstacle.

The Parking Assistance System's front detectors are activated automatically when the engine is started. They are active at speeds below 10 km/h (6 mph).

The measuring range is approx. 80 cm (2.5 feet) in front of the car.

i Note

Parking assistance is deactivated when the parking brake is used or **P** mode is selected in a car with an automatic gearbox.

! Important

When auxiliary lamps are fitted: Remember that these must not obscure the sensors - the auxiliary lamps may then be perceived as an obstacle.

Backwards

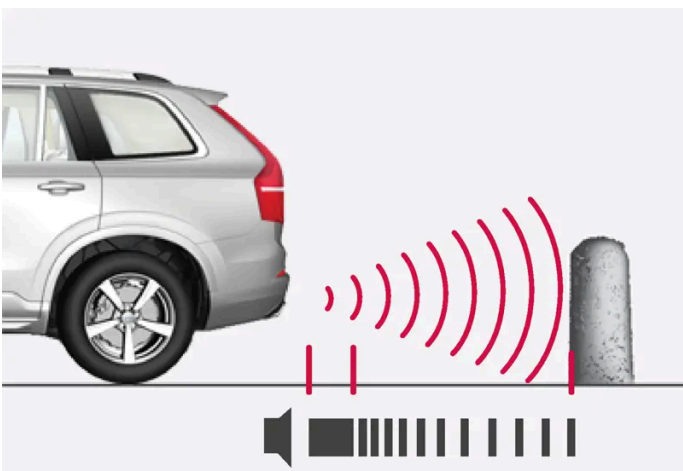

The warning signal has a constant tone at less than approx. 30 cm (1 foot) from an obstacle.

The sensors for reverse are activated if the car rolls backward without a gear engaged or when the gear lever is moved to reverse position.

The measuring range is approx. 1.5 metres (5 feet) behind the car.

When reversing with a trailer connected to the car's electrical system, parking assistance backward is deactivated automatically.

Note

When reversing with e.g. a trailer or bike carrier on the towbar - without Volvo genuine trailer wiring - parking assistance may need to be switched off manually in order that the sensors do not react to them.

Along the sides

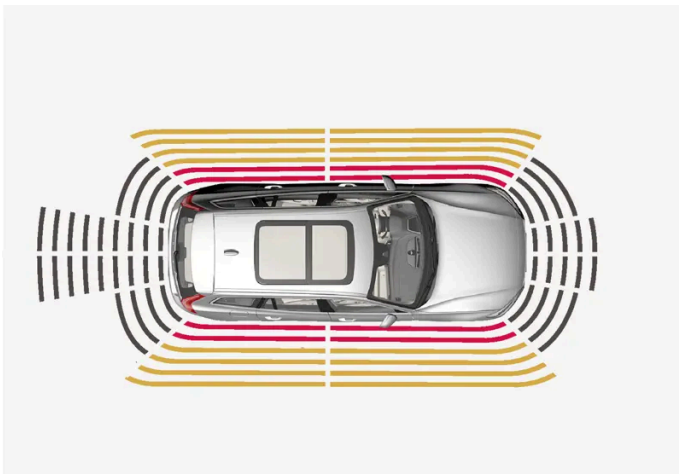

The warning signal pulses intensively at less than approx. 25 cm (0.8 foot) from an obstacle.

Parking assistance side sensors are activated automatically when the engine is started. They are active at speeds below 10 km/h (6 mph).

The measuring range is approx. 25 cm (0.8 foot) from the sides.

However, the detection range of the side sensors increases significantly when the steering angle of the front wheels is increased, and obstacles of up to approx. 90 cm (3 feet) located diagonally behind or in front of the vehicle are detected when the steering wheel is turned.

* Option/accessory.

^[1] Park Assist System

10.14.1.3. Activating and deactivating Parking Assistance System *

The Parking Assistance System (PAS^[1]) can be activated or deactivated.

The front and side parking assistance detectors are activated automatically when the engine is started. The rear detectors are activated if the car rolls backwards or when reverse gear is engaged.



Activate or deactivate the function using this button in the centre display's function view.

- Illuminated button – the function is activated.
- Extinguished button – the function is deactivated.

In cars equipped with a park assist camera *, Park Assist Pilot can also be activated or deactivated from the relevant camera view.

* Option/accessory.

^[1] Park Assist System

10.14.1.4. Symbols and messages for Park Assist

Symbols and messages for Park Assist System (PAS^[1]) can be shown in the driver display and/or the centre display. Here are some examples.

Symbol	Message	Specification
		The rearward parking assistance sensors are deactivated , so there are no acoustic warnings for obstacles/objects.
	Park Assist System Sensors blocked, cleaning needed	One or more of the function's sensors are blocked - check and correct as soon as possible.
	Park Assist System Unavailable Service required	The system does not function as it should. A workshop should be contacted ^[2] .

A text message can be cleared by briefly pressing the button, located in the centre of the steering wheel's right-hand keypad.

If a message remains, contact a workshop - an authorised Volvo workshop is recommended.

^[1] Park Assist System

^[2] An authorised Volvo workshop is recommended.

10.14.1.5. Limitations of Parking assistance

The Parking Assistance System (PAS^[1]) cannot detect everything in all situations and may therefore have limited functionality in some cases.

A driver should be aware about the following examples of Park Assist Pilot's limitations:

 **Warning**

- The parking sensors have blind spots where obstacles cannot be detected.
- Pay particular attention if there are people and animals near the car.
- Bear in mind that the front of the car may swing out towards oncoming traffic during the parking manoeuvre.
- Objects/obstacles may be closer to the car than they appear to be on the screen.

 **Warning**



Pay additional attention while reversing when this symbol is shown if a trailer, bicycle rack or similar is mounted and electrically connected to the car.

The symbol indicates that the parking assistance sensors rearward are **switched off** and will not warn of any obstacles.

 **Important**

Objects e.g. chains, thin glossy poles or low barriers may be in the "signal shadow" and are then temporarily not detected by the sensors - the pulsating tone may then unexpectedly stop instead of changing over to the expected constant tone.

The sensors cannot detect high objects, such as projecting loading docks.

- In such situations, pay extra attention and manoeuvre/reposition the car particularly slowly or stop the current parking manoeuvre - there may be a high risk of damage to vehicles or other objects since information from the sensors is not always reliable in such situations.

 **Important**

In certain conditions the parking assistance system may produce incorrect warning signals that are caused by external sound sources with the same ultrasonic frequencies that the system works with.

Examples of such sources include horns, wet tyres on asphalt, pneumatic brakes, exhaust noises from motorcycles, etc.

 **Note**

Since a towbar is configured with the car's electrical system, towbar protrusion is included when the function measures the distance to an object behind the car.

^[1] Park Assist System

10.14.2. Active park assist

10.14.2.1. Park Assist Pilot *

Park Assist Pilot (PAP^[1]) can assist the driver to manoeuvre the car while parking. The function can also assist with steering when driving out from parallel parking.



The function first checks if a space is large enough and if so then assists the driver to steer the car into the space.

The centre display indicates with symbols, graphics and text the various operations to be carried out and when to do so.

 **Warning**

- The function is supplementary driver support intended to facilitate driving and make it safer – it cannot handle all situations in all traffic, weather and road conditions.
- The driver is advised to read all sections in the Owner's Manual that relate to this function to learn about factors such as its limitations and what the driver should be aware of before using the system.
- Driver support functions are not a substitute for the driver's attention and judgement. The driver is always responsible for ensuring the car is driven in a safe manner, at the appropriate speed, with an appropriate distance to other vehicles, and in accordance with current traffic rules and regulations.

* Option/accessory.

^[1] Park Assist Pilot

10.14.2.2. Parking variants with Park Assist Pilot *

Park Assist Pilot (PAP^[1]) can be used for both parallel and perpendicular parking.

Parallel parking

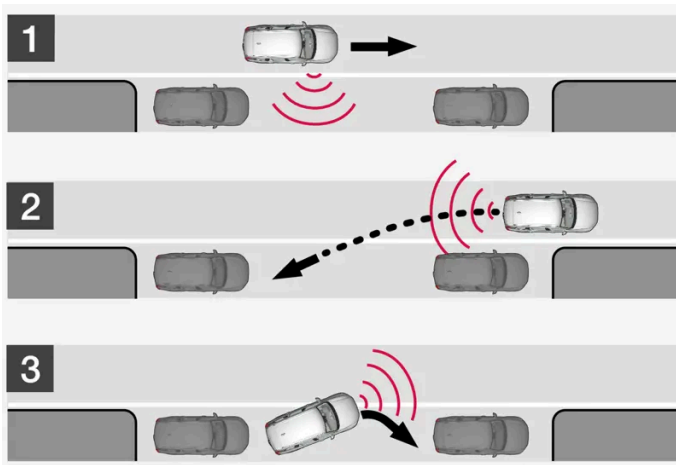

The principal of parallel parking.

The function parks the car using the following steps:

1. A parking space is identified and measured.
2. The car is reversed into the space.
3. The car is positioned in the space by means of driving forward/backward.

With the **Park Out** function, a parallel-parked car can also get help from the function with leaving the parking space.

Perpendicular parking

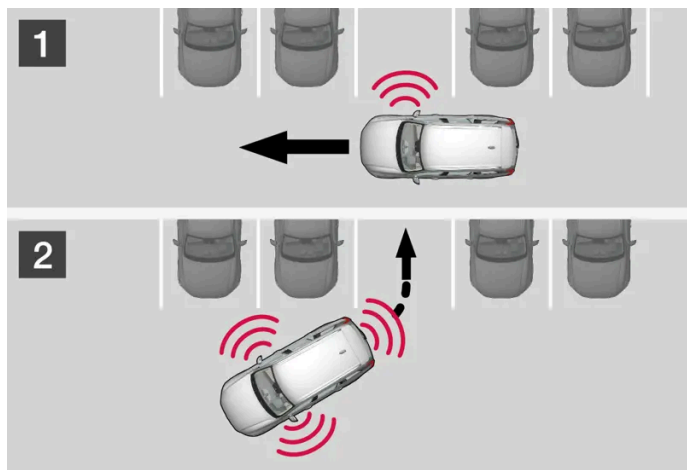

Principle for perpendicular parking.

The function parks the car using the following steps:

1. A parking space is identified and measured.
2. The car is reversed into the space and then positioned in the space by means of driving forward/backward.

i Note

When leaving a parking space, the **Park Out** function must only be used for a parallel-parked car - it does not work for a perpendicular-parked car.

* Option/accessory.

^[1] Park Assist Pilot

10.14.2.3. Using Park Assist Pilot*

Park Assist Pilot (PAP^[1]) helps the driver park via three steps. The function can also help the driver to leave a parking space.

This function measures space and steers the car – the driver's job is to:

- keep an eye on what is happening around the car
- follow the instructions in the centre display
- select a gear (reverse/forward) – an acoustic signal indicates when the driver should change gear
- regulate and maintain a safe speed
- brake and stop.

Symbols, graphic and/or text appear on the centre display when the different steps are to be performed.

The function can be activated if the following criteria are met once the engine has been started:

- No trailer is attached to the car
- Speed is lower than 30 km/h (20 mph).

Note

The distance between the car and parking spaces should be 0.5–1.5 metres (1.6–5.0 ft) while the function is searching for a parking space.

Parking with Park Assist Pilot

The function parks the car using the following steps:

1. A parking space is identified and measured.
2. The car is reversed into the space.
3. The car is positioned into the space - the system may then request that the driver changes gear and brakes.

Find and measure parking spaces



The function can be activated in the centre display's function view.

It can also be accessed from the camera views.

- Illuminated button – the function is activated.
- Extinguished button – the function is deactivated.

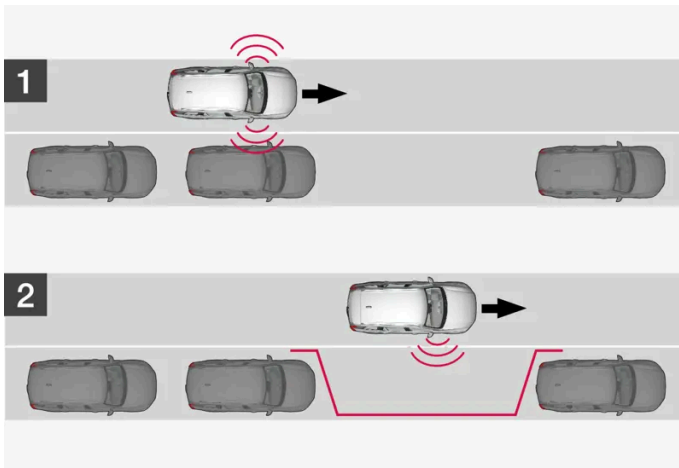

Principle for searching before parallel parking.

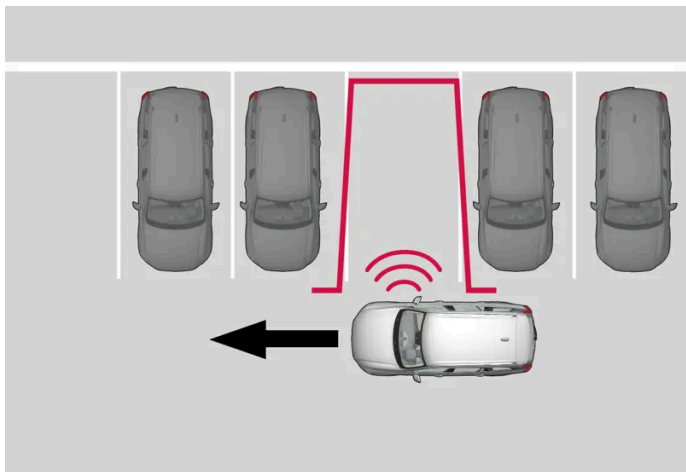

Principle for searching before perpendicular parking.

Drive no faster than 30 km/h (20 mph) for parallel parking or 20 km/h (12 mph) for perpendicular parking.

- 1 Tap on the **Park In** button in the function view or in the camera view.
 - The function searches for a parking space and checks whether it is big enough.
- 2 Be prepared to stop the car when the graphic and message on the centre display state that a suitable parking space has been found.
 - A pop-up window is shown.
- 3 Select **Parallel parking** or **Perpendicular parking** and select reverse gear.

Note

The function searches the area for parking, displays instructions and guides the car in on its passenger side. But if required the car can also be parked on the driver's side of the street:

- Activate the direction indicator to the driver's side - then the system searches for a parking space on that side of the car instead.

Reversing in to the parking space

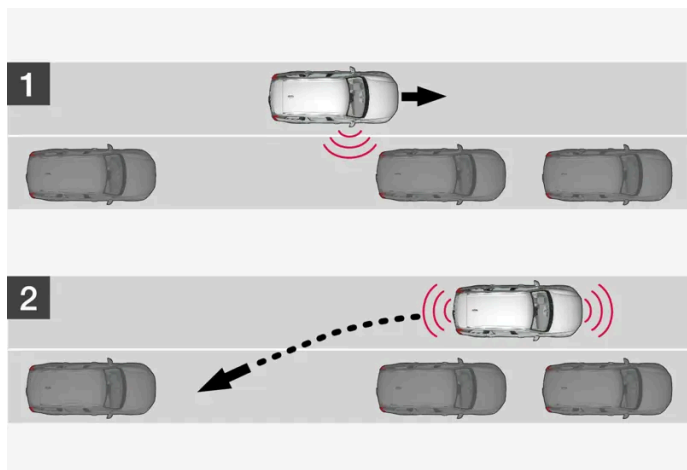

Principle for reversing into parallel parking.

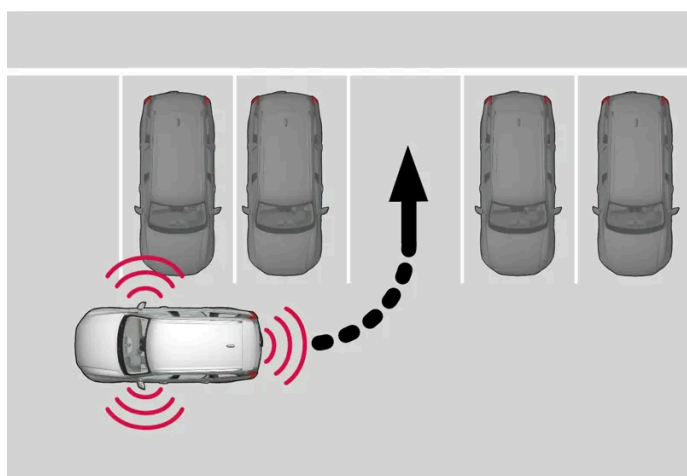

Principle for reversing into perpendicular parking.

- 1 Check that the area behind the car is clear, then engage reverse gear.
- 2 Reverse slowly and carefully without touching the steering wheel - and no faster than 7 km/h (4 mph).
- 3 Be prepared to stop the car when instructed by the graphic and message on the centre display.

Note

- Keep your hands away from the steering wheel when the function is activated.
- Make sure that the steering wheel is not hindered in any way and can rotate freely.
- To achieve optimum results - wait until the steering wheel is fully turned before starting to drive backward/forward.

Positioning the car in the parking space

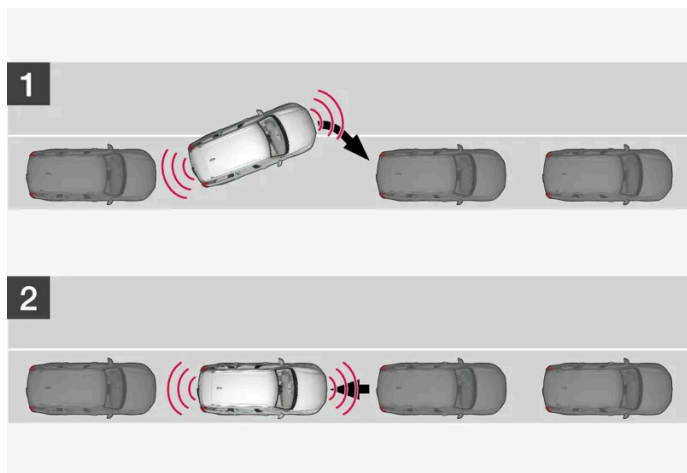

Principle for positioning during parallel parking.

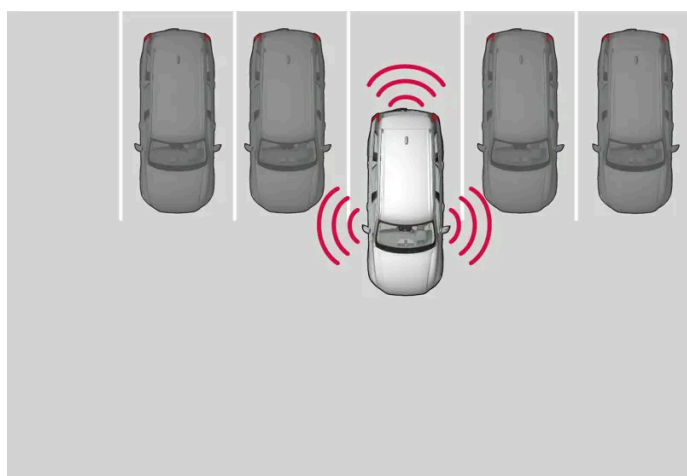

Principle for positioning during perpendicular parking.

- 1 Move the gear selector to the gear position as instructed by the system, wait until the steering wheel has been turned and drive forward slowly.
- 2 Be prepared to stop the car when instructed by the graphic and message on the centre display.
- 3 Select reverse gear and drive slowly backwards.
- 4 Be prepared to brake the car when instructed by the graphic and message on the centre display.

The function is deactivated automatically and the graphics and message show that parking is complete. It may be necessary for the driver to correct the car's position. Only the driver can determine whether the car is properly parked.

Important

The warning distance is shorter when the sensors are used by Park Assist Pilot (PAP^[2]) compared with when Park Assist System uses the sensors.

Auto-brake during parking sequence

If the parking sensors detect a vehicle or pedestrian within the intended route in front of or behind the car during a parking manoeuvre, the car is auto-braked to stationary.

The driver display then shows a pop-up message where the driver can choose to cancel the parking manoeuvre by tapping on **Cancel**, or tap **Resume** to continue the parking sequence.

Proceed as follows after selecting **Resume**:

- 1 Check that there is free space around the car and follow the instructions in the centre display, such as:
To continue – Gently accelerate away from object.

* Option/accessory.

[1] Park Assist Pilot

[2] Park Assist Pilot

10.14.2.4. Leaving parallel parking with Park Assist Pilot*

The **Park Out** function can help the driver to leave a parking space when the car is parallel parked.



Note

When leaving a parking space, the **Park Out** function must only be used for a parallel-parked car - it does not work for a perpendicular-parked car.



The **Park Out** function is activated in the centre display's function view or in the camera view.

- Illuminated button – the function is activated.
- Extinguished button – the function is deactivated.

- 1 Tap on the **Park Out** button in the function view or in the camera view.
- 2 Use the direction indicator to select the direction in which the car should leave the parking space.
- 3 Be prepared to stop the car when instructed by the graphic and message on the centre display - follow the instructions in the same way as for the parking procedure.

Note the steering wheel can "spring" back when the function is completed - the driver may then need to turn the steering wheel back to the maximum steering angle in order to leave the parking space.

If the function considers that the driver can leave the parking space without any extra manoeuvring then the function will be stopped, even if the driver may consider that the car is still in the parking space.

* Option/accessory.

10.14.2.5. Messages for Park Assist Pilot *

Messages for Park Assist Pilot (PAP^[1]) can be shown in the driver display and/or the centre display. Here are some examples.

Message	Specification
Park Assist System Sensors blocked, cleaning needed	One or more of the function's sensors are blocked - check and correct as soon as possible.
Park Assist System Unavailable Service required	The system does not function as it should. A workshop should be contacted ^[2] .

A text message can be cleared by briefly pressing the  button, located in the centre of the steering wheel's right-hand keypad.

If a message remains, contact a workshop - an authorised Volvo workshop is recommended.

* Option/accessory.

^[1] Park Assist Pilot

^[2] An authorised Volvo workshop is recommended.

10.14.2.6. Limitations of Park Assist Pilot*

The Park Assist Pilot (PAP^[1]) function cannot detect everything in all situations and may therefore have limited functionality.

A driver should be aware about the following examples of Park Assist Pilot limitations.

Warning

- The parking sensors have blind spots where obstacles cannot be detected.
- Pay particular attention if there are people and animals near the car.
- Bear in mind that the front of the car may swing out towards oncoming traffic during the parking manoeuvre.
- Objects/obstacles may be closer to the car than they appear to be on the screen.

Important

Objects situated higher than the sensor detection area are not included when calculating the parking manoeuvre, which could cause the function to swing into the parking space too early – such parking spaces should be avoided for this reason.

Parking is discontinued

A parking sequence will be discontinued:

- if the driver moves the steering wheel
- if the car is driven too quickly - above 7 km/h (4 mph)
- if the driver presses **Cancel** in the centre display
- when the anti-lock brakes or the Electronic stability control are engaged - e.g. when a wheel loses grip on a slippery road
- as the steering servo for speed-dependent steering wheel resistance is working at reduced power – e.g. when cooling due to overheating.
- when the parking sensors detect a vehicle or pedestrian within the intended route in front of or behind the car during a parking manoeuvre, the car is auto-braked to stationary.

Where applicable, a message in the centre display states the reason for a parking sequence being discontinued.

 **Important**

Under certain circumstances, the function is unable to find parking spaces - one reason for this may be the fact that there is interference with the sensors from external sound sources which emit the same ultrasound frequencies as those with which the system works.

Examples of such sources include horns, wet tyres on asphalt, pneumatic brakes and exhaust noises from motorcycles etc.

 **Note**

Dirt, ice and snow covering the sensors will reduce their function and may prevent measurement.

Driver responsibility

The driver should bear in mind that the function is an aid – not an infallible, fully-automatic function. The driver must therefore be prepared to interrupt a parking step.

There are also a few details to bear in mind while parking, e.g.:

- The driver is always responsible for determining whether the space selected by the function is suitable for parking.
- Do not use the function if snow chains or a spare wheel are fitted.
- Do not use the function if cargo items are protruding from the car.
- Heavy rain or snow may cause the system to measure the parking space incorrectly.
- During the search and check-measurement of the parking space, the function may miss objects positioned deep in the parking space.
- Parking spaces on narrow streets are not always feasible, since the space required for manoeuvring may not be sufficient.
- Use approved tyres^[2] with the correct tyre pressure - this affects the ability of the function to park the car.
- The function bases itself on the locations of vehicles already parked nearby – if they are inappropriately parked, your own car's tyres and wheel rims may be damaged by contact with the kerb.
- Perpendicular parking spaces may be missed or offered unnecessarily if one parked car is protruding more than other parked cars.
- The function is designed for parking on straight streets – not sharp curves or bends. For this reason, make sure the car is parallel to the potential parking spaces when the function measures the space.

* Option/accessory.

^[1] Park Assist Pilot

^[2] "Approved tyres" refers to tyres of the same type and make as those fitted on delivery from the factory.

10.14.3. Park assist camera

10.14.3.1. Park assist camera*

Park assist camera (PAC^[1]) can assist the driver when manoeuvring in tight spaces by indicating obstacles with a camera image and graphics in the centre display.



Example of camera view.

- 1 Zoom^[2] - zoom in/out
- 2 360° view* - activates/deactivates all cameras
- 3 PAS^[3] - activates/deactivates the parking assistance sensors
- 4 Lines - activates/deactivates park assist lines
- 5 Towbar* - activates/deactivates the towbar park assist line*^[4]
- 6 CTA* - activates/deactivates Cross Traffic Alert

The park assist camera is a support function which is activated automatically when reverse gear is selected or manually in the centre display.

 **Warning**

- The parking sensors have blind spots where obstacles cannot be detected.
- Pay particular attention if there are people and animals near the car.
- Bear in mind that the front of the car may swing out towards oncoming traffic during the parking manoeuvre.
- Objects/obstacles may be closer to the car than they appear to be on the screen.

 **Warning**

- The function is supplementary driver support intended to facilitate driving and make it safer – it cannot handle all situations in all traffic, weather and road conditions.
- The driver is advised to read all sections in the Owner's Manual that relate to this function to learn about factors such as its limitations and what the driver should be aware of before using the system.
- Driver support functions are not a substitute for the driver's attention and judgement. The driver is always responsible for ensuring the car is driven in a safe manner, at the appropriate speed, with an appropriate distance to other vehicles, and in accordance with current traffic rules and regulations.

* Option/accessory.

^[1] Park Assist Camera

^[2] The park assist lines are switched off when zooming in.

^[3] Park Assist System

^[4] Not available for all models and markets.

10.14.3.2. Activate park assist camera

The park assist camera (PAC^[1]) is activated automatically when reverse gear is engaged or manually with one of the centre display's function buttons.

Camera view when reversing

The content of this manual represents the status of the user manual at the time of printing and may not be completely valid in future instances. For more information, refer to the first page for the complete disclaimer note.

When reverse gear is engaged, the screen shows the 360° view if it or any of the side views was the last used camera view, otherwise the rear view is shown.

Camera view for manual camera activation



Activate the parking camera with this button in the centre display's function view. The screen then initially shows the last used camera view. However, after each engine start, the previously shown side view is replaced by the 360° view and the previously shown zoomed rear view is replaced by the rear view.

- Illuminated button – the function is activated.
- Extinguished button – the function is deactivated.

Automatic deactivation of camera

The front view extinguishes at 25 km/h (16 mph) to avoid distracting the driver – it reactivates automatically if the speed drops to 22 km/h (14 mph) within 1 minute, on the condition that the speed has not exceeded 50 km/h (31 mph).

Other camera views are extinguished at 15 km/h (9 mph) and not reactivated.

^[1] Park Assist Camera

10.14.3.3. Symbols and messages for Park assist camera

Symbols and messages for Park assist camera (PAC ^[1]) can be shown in the driver display and/or the centre display. Here are some examples.

Symbol	Message	Specification
		The rearward parking assistance sensors are deactivated , so there are no acoustic warnings and field marks for obstacles/objects.
		The camera is disengaged.
	Park Assist System Sensors blocked, cleaning needed	One or more of the function's sensors are blocked - check and correct as soon as possible.
	Park Assist System Unavailable Service required	The system does not function as it should. A workshop should be contacted ^[2] .

A text message can be cleared by briefly pressing the button, located in the centre of the steering wheel's right-hand keypad.

If a message remains, contact a workshop - an authorised Volvo workshop is recommended.

^[1] Park Assist Camera

^[2] An authorised Volvo workshop is recommended.

10.14.3.4. Park assist lines for park assist camera *

The Park assist cameras (PAC^[1]) indicate the position of the car in relation to its surroundings by displaying lines on the screen.

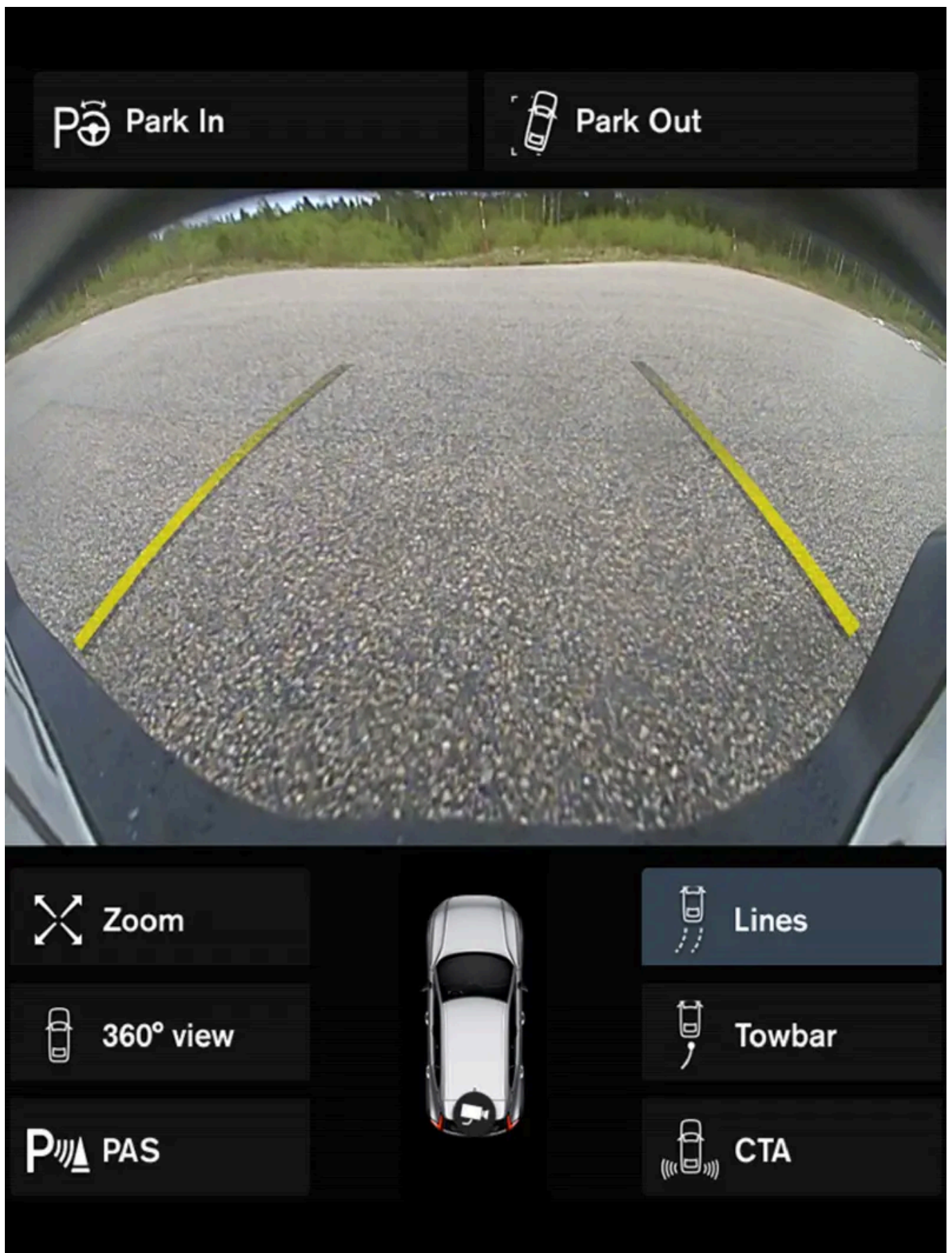

Example of park assist lines

The content of this manual represents the status of the user manual at the time of printing and may not be completely valid in future instances. For more information, refer to the first page for the complete disclaimer note.

Park assist lines show the intended route for the car's external dimensions with the current steering wheel angle - this can facilitate parallel parking, reversing into tight spaces and when connecting a trailer.

The lines on the screen are projected as if they were at ground level behind the car and respond directly to steering wheel movements, showing the driver the path the car will take - also when the car is turning.

These park assist lines include the car's most protruding parts, e.g. towbar, door mirrors and corners.

(i) Note

- When reversing with a trailer which is not connected electrically to the car, the park assist lines on the display show the route the **car** will take – not the trailer.
- The screen shows no park assist lines when a trailer is connected electrically to the car's electrical system.
- Park assist lines are not shown when zooming in.

(!) Important

- Remember, that with the rear camera view selected, the monitor only displays the area behind the car. Be aware of the sides and front of the car when manoeuvring in reverse.
- The same applies vice versa - note what happens to the rear parts of the car when the front camera view is selected.
- Note that the park assist lines show the **shortest** route. Therefore, pay extra attention to the car's sides so that they do not go against/over something when the steering wheel is turned when driving forward or that the front sweeps against/over something when the steering wheel is turned when reversing.

Park assist lines in 360° view*

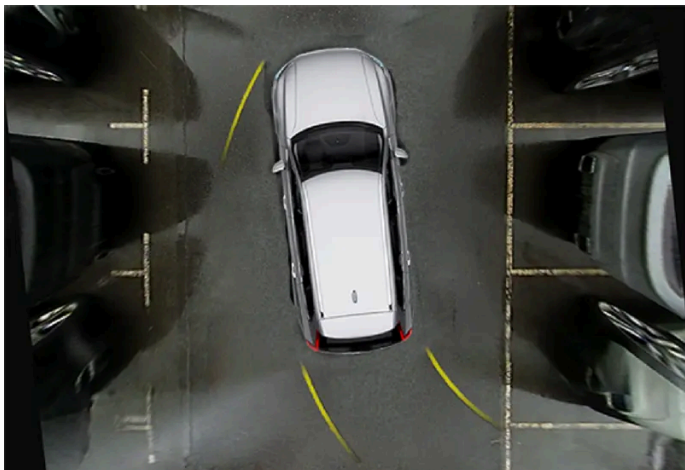

360° view with park assist lines

With the 360° view, park assist lines are shown behind, in front of and at the side of the car (depending on the direction of travel):

- When driving forwards: Front lines
- When reversing: Side lines and reversing lines

With front or rear camera selected, the park assist lines appear regardless of the car's direction of travel.

With one side camera selected, the park assist lines only appear when reversing.

Towbar assist line*

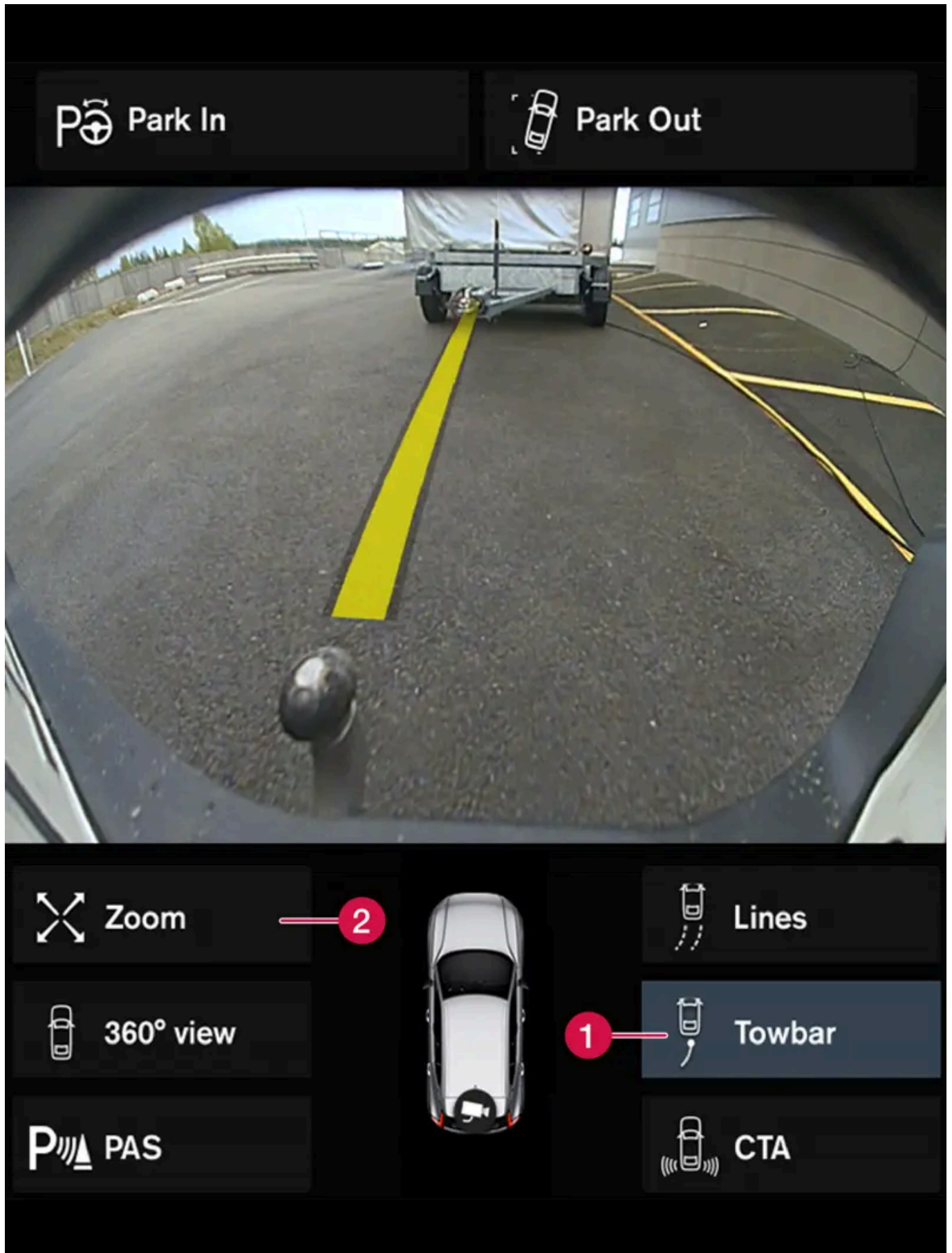

Towbar with park assist line

- 1 **Towbar** - activates the towbar assist line.
- 2 **Zoom** - zoom in/out.

To use the camera for connecting a trailer:

- 1 Press **Towbar** (1).
 - The park assist lines for the towbar's intended path appear - the car's park assist lines will disappear at the same time. Park assist lines for both car and towbar cannot be shown at the same time.
- 2 Press **Zoom** (2) when a more precise manoeuvring is required.
 - The camera view zooms in.

* Option/accessory.

^[1] Park Assist Camera

10.14.3.5. Park assist camera locations and surveillance areas*

The park assist cameras (PAC^[1]) can show rear, front, left or right camera view individually. You can also have a composite 360° view that shows all sides.

360° view*

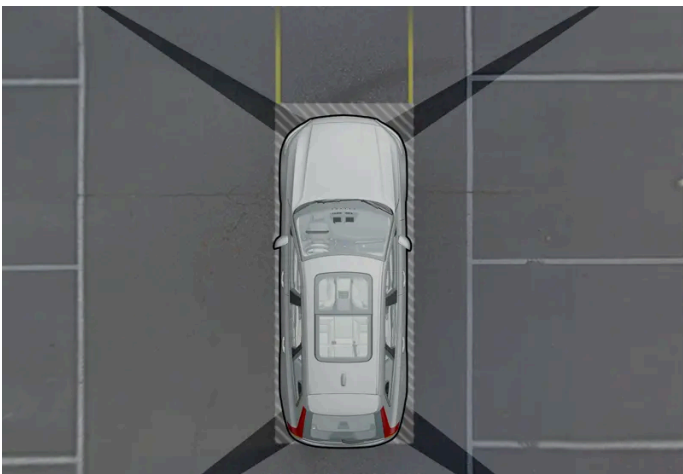

Example of "field of vision" for the parking cameras with approximate coverage area.

The **360° view** function activates all parking cameras, whereupon the four sides of the car are shown simultaneously in the centre display, which helps the driver to observe what is around the car when manoeuvring at slow speeds. From the 360° view, each camera view can be activated separately. Tap on the screen to show the camera symbols and select the desired view.



A camera symbol on the centre display's car symbol indicates which of the cameras is active.

If the car is also equipped with **Park Assist System*** then distance to detected obstacles is illustrated with fields in different colours.

The cameras can be activated automatically or manually.

Backwards



The backwards-facing camera is fitted above the registration plate.

The backward-facing camera shows a wide area behind the car. For certain models, part of the bumper can be seen as well as the towbar in some cases.

Objects shown in the centre display may appear slightly tilted – this is normal.

Forwards



The forwards parking camera is located in the grille.

The front camera can be helpful on an exit road with limited visibility to the sides, e.g. when driving out of a garage. It is active at speeds up to 25 km/h (16 mph) - following which, the front camera is switched off.

If the car does not reach 50 km/h (30 mph) and the speed falls below 22 km/h (14 mph) within 1 minute after the forward-facing camera has been extinguished, the camera is reactivated.

The sides



The side cameras are positioned in each door mirror.

The side cameras can show what is along each side of the car.

* Option/accessory.

^[1] Park Assist Camera

10.14.3.6. Sensor fields for parking assistance system

If the car is equipped with the Parking Assistance System (PAS^[1]) then the distance is shown in the Parking Assistance Camera (PAC^[2]) 360° view with coloured fields for each sensor that registers an obstacle.

Sensor fields backwards and forwards



The screen can show coloured sensor fields on the car symbol.

The fields for the front and reversing sensors change colour as the distance to the obstacle decreases – from yellow through orange to red.

Field colour reverse	Distance in metres (feet)
Yellow	0.6-1.5 (2.0-4.9)
Orange	0.3-0.6 (1.0-2.0)
Red	0-0.3 (0-1.0)

Field colour forwards	Distance in metres (feet)
Yellow	0.6-0.8 (2.0-2.6)
Orange	0.3-0.6 (1.0-2.0)
Red	0-0.3 (0-1.0)

For red sensor fields, the pulsating acoustic signal changes over to a constant tone.

Sensor field to the sides

Warning signals depend on the intended route of the car. When the steering wheel is turned, therefore, there may also be a warning for obstacles diagonally in front of or diagonally behind the car, not just straight ahead or directly behind.

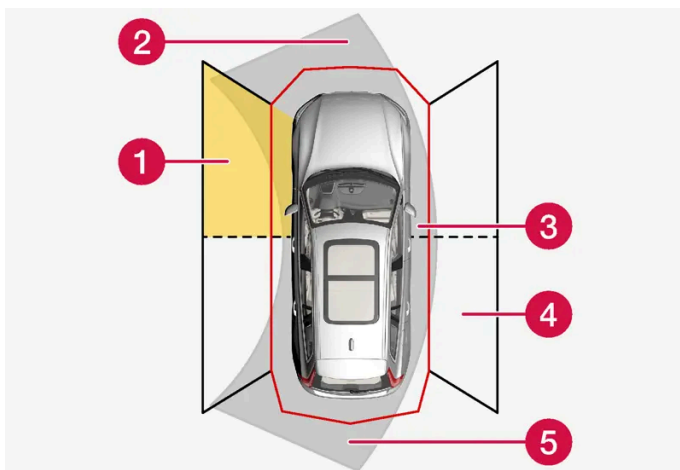

Parking sensor sectors where obstacles can be detected.

- 1 Left-hand side front sensor field
- 2 Obstacle sector in the car's intended route forwards – depending on steering wheel angle
- 3 Sector with red field colour and intensively pulsing tone
- 4 Right-hand side rear sensor field
- 5 Obstacle sector in the car's intended route in reverse – depending on steering wheel angle.

The colour of the side fields changes with reduced distance to the obstacle – from amber to red.

Colour of side fields	Distance in metres (feet)
Yellow	0,25-0,9 (0,8-3,0)
Red	0-0,25 (0-0,8)

In the case of red sensor fields, the acoustic signal changes from pulsing to intensively pulsing.

[1] Park Assist System

[2] Park Assist Camera

10.15. Camera and radar unit

10.15.1. Recommended maintenance for camera and radar units

In order that the camera and radar units shall function correctly, they must be kept clear of dirt, ice and snow, and be cleaned regularly with water and car shampoo.

***i* Note**

Dirt, ice and snow covering the sensors may cause incorrect warning signals, reduced or no function.

The following illustrations mark out the surfaces to be kept clean – on both the left and right-hand sides of the car.

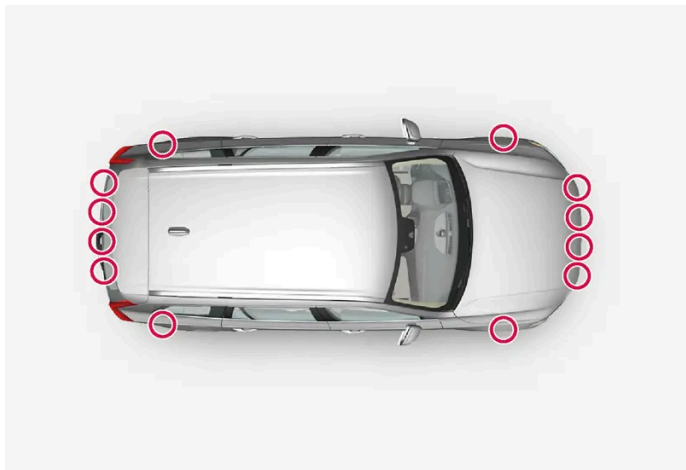

Location of the parking sensors around the car



Location of front camera and radar unit



Location of rear radar units

- To ensure best possible functionality, the surfaces in front of the sensors must be kept clean.
- Do not affix any objects, tape or labels in the area of the sensors.
- Clean camera lenses regularly with lukewarm water and car shampoo - be careful not to scratch the lenses.

 **Important**

Maintenance of driver support components must only be performed at a workshop – an authorised Volvo workshop is recommended.

10.15.2. Symbols and messages for camera and radar units

Here are examples of some of the display messages and symbols regarding the camera and radar that can be shown in the driver display.

Detector blocked



If the driver display shows this symbol and the message **Windscreen sensor Sensor blocked**, see **Owner's manual**, this means that the camera and radar unit cannot detect other vehicles, cyclists, pedestrians and large animals in front of the car, and that the car's camera-based and radar-based functions may be disrupted.

The following table presents examples of possible causes for a message being shown, along with the appropriate action:

Cause	Action
The windscreen surface in front of the camera and radar unit is dirty or covered with ice or snow.	Clean dirt, ice and snow from the windscreen surface in front of the camera and radar unit.
Thick fog and heavy rain or snow block the radar signals or the camera view.	No action. Sometimes the unit does not work during heavy rain or snowfall.
Water or snow from the road surface swirls up and blocks the radar signals or camera view.	No action. Sometimes the unit does not work on a very wet or snow-covered road surface.
Dirt has appeared between the inside of the windscreen and the camera and radar unit.	Visit a workshop to have the windscreen inside the unit's cover cleaned - an authorised Volvo workshop is recommended.
Strong oncoming light	No action. The camera unit is reset automatically in more favourable light conditions.

Defective camera



If a camera sector is black and contains this symbol then it means that the camera is out of order.

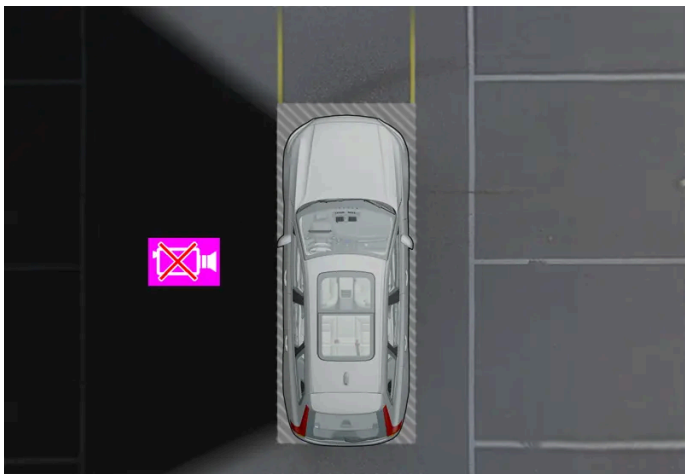

Example for showing when the car's left camera is non-operational.

A black camera sector is also shown in the following instances, but then **without** the symbol for defective camera:

- open door
- open tailgate
- folded-in door mirror.

Rear parking camera

 **Warning**



Pay additional attention while reversing when this symbol is shown if a trailer, bicycle rack or similar is mounted and electrically connected to the car.

The symbol indicates that the parking assistance sensors rearward are **switched off** and will not warn of any obstacles.

10.15.3. Limitations for camera and radar units

The camera and radar have certain limitations – which in turn also limits those functions that use the units. A driver should be aware about the following examples of limitations.

Common limitations for camera and radar

Blocked unit

Do not position, stick or install anything in front of or around the camera and radar units – this may disrupt camera and radar-based functions. This may result functions being reduced, being switched off completely or giving incorrect function responses.

High temperature

At very high temperatures the camera and radar can temporarily be switched off for about 15 minutes after the engine is started so as to protect the unit's electronics. The units restart automatically when the temperature has fallen sufficiently.

Damaged windscreen

The following rules are also applicable when a camera or radar is placed in the windscreen:

- If a scratch, crack or stone chip appears in front of the unit and covers an area of approx. 0.5 × 3.0 mm (0.02 × 0.12 inches) or more, a workshop^[1] must be contacted so that the windscreen can be replaced.
- Volvo recommends **not** repairing cracks, scratches or stone chips in the area in front of the unit – the entire windscreen should be replaced instead.
- Before replacing a windscreen, contact a workshop^[1] to verify that the correct windscreen has been ordered and will be fitted.
- The same type of windscreen wipers or windscreen wipers approved by Volvo must be fitted when the windscreen is replaced.
- When replacing the windscreen, the camera and radar unit must be recalibrated by a workshop^[1] to ensure the functionality of all the camera and radar-based systems in the car.

 **Note**

If not rectified, it can lead to reduced performance for the driver support systems that use the camera and/or radar units. This may result functions being reduced, being switched off completely or giving incorrect function responses.

Further limitations for radar

Vehicle speed

The radar unit's ability to detect a vehicle ahead is greatly reduced if the speed of the vehicle ahead is very different to the speed of your own car.

Limited field of vision

The radar unit has a limited field of vision. In some situations another vehicle is not detected, or the detection is made later than expected.

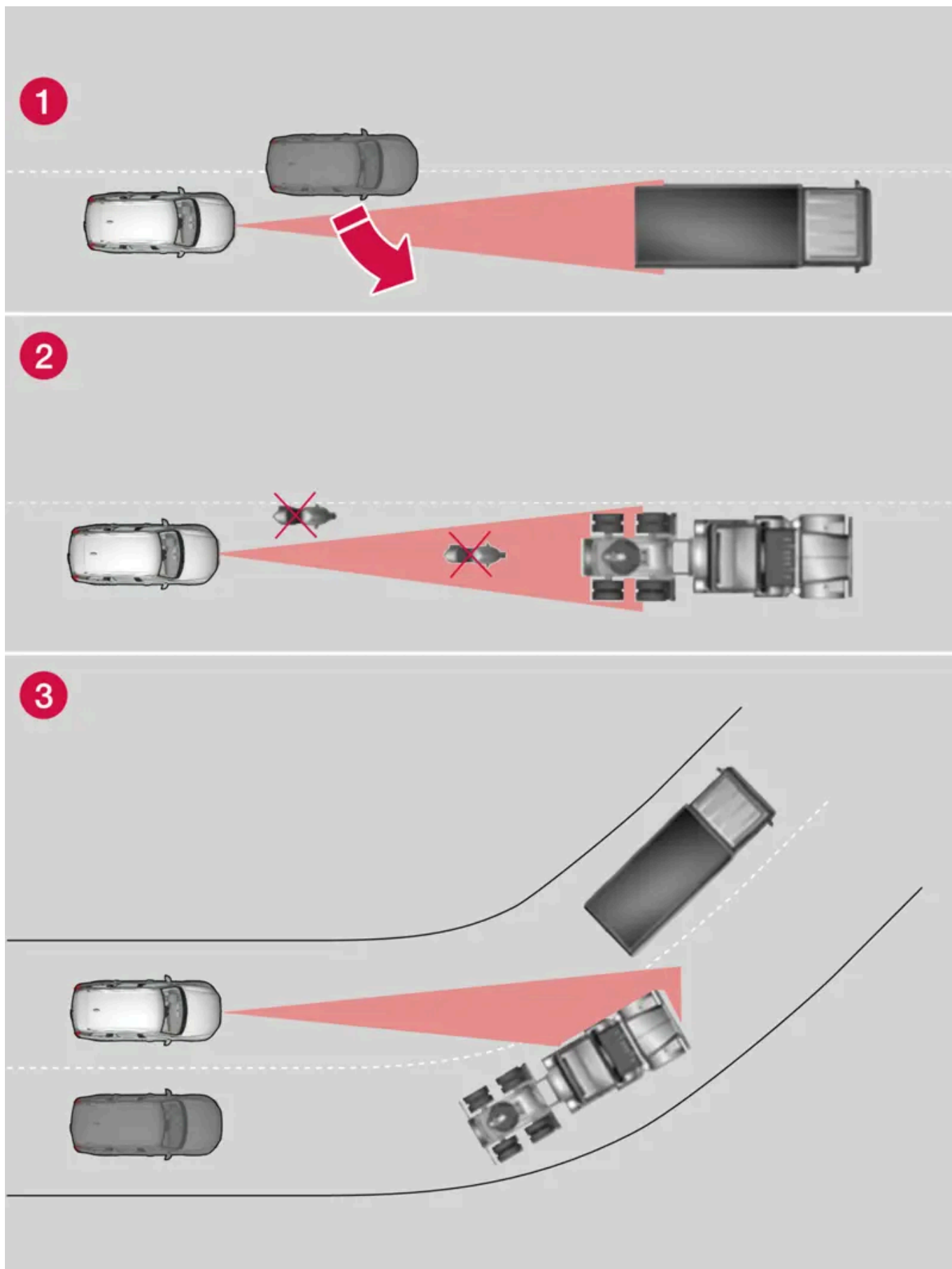

The radar unit's field of vision

- 1 Sometimes the radar unit is late at detecting vehicles at close distances - e.g. a vehicle that drives in between your car and the vehicle ahead.
- 2 Small vehicles, such as motorcycles, or vehicles not driving in the centre of the lane can remain undetected.
- 3 In bends, the radar unit may detect a different vehicle than intended or lose a detected vehicle from view.

Low trailers

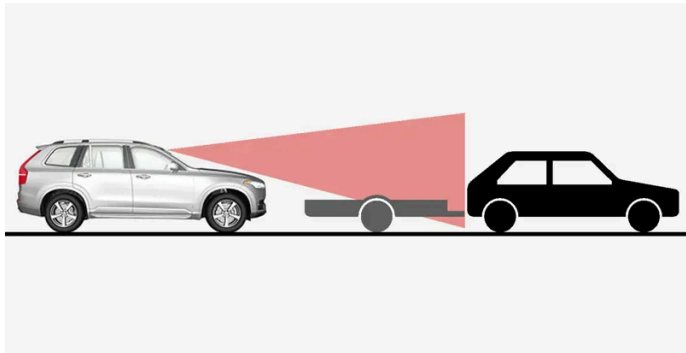

Low trailer in radar shadow

Low trailers can also be difficult for the radar unit to detect, or are not detected at all - the driver should therefore be particularly careful when driving behind low trailers when the adaptive cruise control* or Pilot Assist* is activated.

Further limitations for camera

Impaired vision

The cameras have limitations similar to the human eye, i.e. may "see" worse in for example intense snowfall or rain, dense fog, heavy dust storms and snow flurries. Under such conditions, the functions of camera-dependent systems could be significantly reduced or temporarily disengaged.

Strong oncoming light, reflections in the carriageway, snow or ice on the road surface, dirty road surfaces or unclear lane markings can also significantly reduce camera function when it is used to scan the carriageway to detect pedestrians, cyclists, large animals and other vehicles.

Bicycle racks or other accessories mounted at the rear of the car may obscure the camera's view.

Further limitations for Park assist camera*

Blind sectors

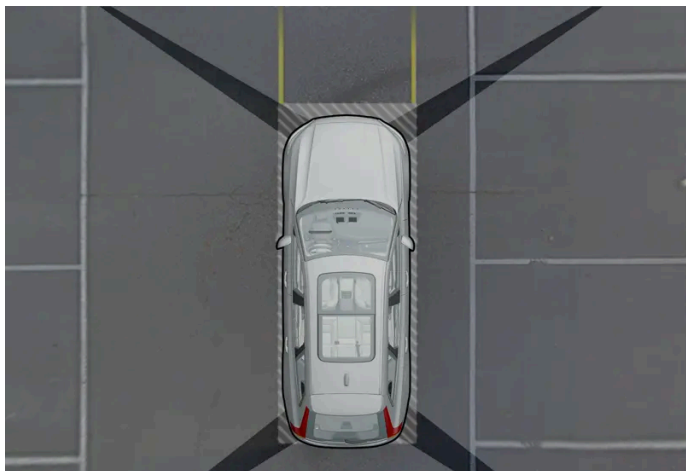

There are "blind" sectors between the cameras' fields of vision.

In the park assist camera's 360° view* obstacles/objects may "vanish" in the gaps between the individual cameras.

Warning

Pay attention to the possibility that, even if it only looks like a relatively small part of the image is obscured, a relatively large sector could be hidden from view. An obstacle could thereby go undetected until the car is very close to it.

Light conditions

The camera image is adjusted automatically according to prevailing light conditions. Because of this, the image may vary slightly in brightness and quality. Poor light conditions can result in reduced image quality.

[1] An authorised Volvo workshop is recommended.

* Option/accessory.

10.15.4. Camera unit

The camera unit is used by several driver support systems and has the task of for example detecting lane lines or traffic signs.



Location of the camera unit

The camera unit is used by the following functions:

- Adaptive cruise control *
- Pilot Assist*
- Lane assistance*
- City Safety
- Steering assistance at risk of collision
- Driver Alert Control *
- Road Sign Information *
- Active main beam *
- Park Assist*

! Important

Do not attempt to access the camera using sharp or foreign objects through the air vents as this may damage the equipment.

* Option/accessory.

10.15.5. Radar unit

Radar is used by several driver support systems and has the task of sensing other vehicles.



Location of front radar unit

The radar unit is used by the following functions:



- Distance Warning*
- Adaptive cruise control*
- Pilot Assist*
- Lane assistance
- City Safety
- Steering assistance at risk of collision





Modification of the radar unit could result in its use being illegal.











* Option/accessory.

10.15.6. Type approval for radar device



Here you can find type approval for the car's radar units for adaptive cruise control* (ACC^[1]), Pilot Assist* and BLIS*^[2].

Market	ACC & PA	BLIS	Symbol	Type approval
Botswana		✓		
Brazil	✓			Este equipamento opera em caráter secundário, isto é, não tem direito à proteção contra interferência prejudicial, mesmo de estações do mesmo tipo, e não pode causar interferência a sistemas operando em caráter primário. Modelo: L2C0054TR 4122-14-8645 EAN: (01)07897843840855

Market	ACC & PA	BLIS	Symbol	Type approval
		✓		Este equipamento não tem direito à proteção contra interferência prejudicial e não pode causar interferência em sistemas devidamente autorizados. 03563-17-05364
Europe	✓			Hereby, Delphi Electronics and Safety declares that L2C0054TR / L2C0055TR are in compliance with the essential requirements and other relevant provisions of Directive 2014/53/EU (RED). The original declaration of conformity can be accessed at the following link www.delphi.com/automotive-homologation . Frequency Band: 76GHz – 77GHz Maximum Output Power: 55dBm EIRP The Declaration of Conformity may be consulted at Delphi Electronics & Safety / 2151 E. Lincoln Road / Kokomo, Indiana 46902 USA
		✓		Hereby, Hella KGaA Hueck & Co. Declares that the radio equipment type RS4 is in compliance with Directive 2014/53/EU. The full text of the EU declaration of conformity is available at the following internet address: www.hella.com/vcc . Technical information: Frequency range: 24.05 ... 24.25 GHz Transmission power: 20 dBm (maximum) EIRP Manufacturer and Address: Manufacturer: Hella KGaA Hueck & Co. Address: Rixbecker Straße 75, 59552 Lippstadt, Germany
The United Arab Emirates (UAE)	✓			Registered No: ER37536/15 Dealer No: DA37380/15
		✓		Registered No: ER53878/17 Dealer No: DA44932/15
Ghana		✓		NCA Approved: 1R3-1M-7E1-0B7
Indonesia	✓			37295/POSTEL/2014 4927
		✓		Certificate number: 50459/SDPPI/2017 Country of origin Germany Certificate number: 53578/SDPPI/2017 Country of origin China PLG ID: 6051
Jamaica		✓		This product contains a Type Approved Module by Jamaica: SMA – “RS4”.
Jordan	✓			Type Approval No.: TRC/LPD/2014/255 Equipment Type: Low Power Device (LPD)
		✓		Type Approval No.: TRC/LPD/2017/63 Equipment Type: Low Power Device (LPD)
China		✓		RS4 24.05-24.25GHz 20mW H 24.05-24.25GHz 20mW H
Malaysia		✓		CID F 15000578
Morocco	✓			AGREE PAR L'ANRT MAROC NUMÉRO D'AGRÉMENT: MR 9929 ANRT 2014 DATE D'AGRÉMENT: 26/12/2014
Mexico	✓			IFETEL: RLVDEL215-0299
		✓		Radar de corto alcance RS4 Hella KGaA Hueck & Co IFETEL: RLVHERS17-0286 La operación de este equipo esta sujeta a las siguientes dos condiciones: (1) es posible que este equipo o dispositivo no cause interferencia perjudicial y (2) este equipo o dispositivo debe aceptar cualquier interferencia, incluyendo la que pueda causar su operación no deseada.
Moldova	✓	✓		

Market	ACC & PA	BLIS	Symbol	Type approval
Nigeria		✓		Connection and use of this communications equipment is permitted by the Nigerian Communications Commission.
Oman		✓		
Russia		✓		
Serbia	✓			И011 14
		✓		И011 17
Singapore	✓			DA 105753
		✓		DA 103238
South Africa	✓			TA-2014/1824
		✓		TA-2016/3407
South Korea	✓			Certification No. MSIP-CMI-DPH-L2C0054TR
		✓		R-CMM-HLA-RS4 [REDACTED]
Taiwan	✓			CCAB15LP0560T3
		✓		CCAB17LP0470T5 [REDACTED]
Thailand		✓		[REDACTED]
Ukraine	✓			Delphi цім стверджує, що обладнання RACAM/SRR2 відповідає вимогам Про затвердження Технічного регламенту радіоблабднання і телекомунікаційного кінцевого (термінального) обладнання (Постанова КМУ № 679 від 24 червня 2009 р.) Декларація відповідності знаходиться на сайті Delphi за адресою: Delphi. Частотний діапазон: 24,05 – 24,25 ГГц Потужність передачі: 20 дБм (макс.) EIRP
		✓		Цим HELLA GmbH & Co. KGaA заявляє, що радіотехнічне обладнання типу RS4 відповідає Технічному регламенту радіотехнічного обладнання та Директиві 2014/53/ЄС. Повний текст декларації про відповідність доступний за адресою: www.hella.com/vcc Частотний діапазон: 24,05 – 24,25 ГГц Потужність передачі: 20 дБм (макс.) EIRP
Vietnam		✓		
Zambia		✓		

Type approval for radio equipment

Market	Symbol	Type approval
Europe		Hereby, Volvo cars, declares that all radio equipment's are in compliance with the essential requirements and other relevant provisions of Directive 2014/53/EU.
Japan		R 204-750001 This device is granted pursuant to the Japanese Radio Law and the Japanese Telecommunications Business Law. This device should not be modified (otherwise the granted designation number will become invalid).

* Option/accessory.

^[1] Adaptive Cruise Control

^[2] Blind Spot Information

10.16. Driving support systems

The car is equipped with different driver support systems which can assist the driver in different situations, either actively or passively.

For example, the systems can help the driver to:

- maintain a set speed
- maintain a certain time interval to the vehicle ahead
- prevent a collision by giving a warning to the driver and braking the car
- help the driver to park.

Some of the systems are fitted as standard while others are options – which alternative applies is market dependent.



Warning

The functions are supplementary aids - they cannot handle all situations in all conditions.

The driver always bears responsibility that the vehicle is driven safely and that applicable road traffic rules and regulations are followed.

10.17. Safety check of driver support when starting

When you start the car after it has been fully switched off, a safety check of the car's driver support systems is shown in the driver display. The check shows which driver support systems are available in the car and whether they are ready for use.

The safety check is shown in the driver display



The illustration shows the 12" driver display

The green dots indicate that everything looks OK. If any system needs an additional check, this is shown by an orange dot and a message in the driver display.

i Note

Available driver support systems may vary depending on the market, options, car model and model year.

10.18. Warnings from various driver support systems

If you notice that the car acts in an unexpected way then this may be due to one of the car's safety-related functions being activated.

What is happening in your car?

There are several functions in your car that can contribute actively to increasing safety in traffic, both for yourself and other road users. You have the option of viewing a list of some of the functions and what they may do – the aim of this is to ensure you are not surprised by the activation of any of the functions. If a function should be activated, you can also be informed of this via a text message in the driver display.

i Note

Read the individual sections on each system in order to fully understand the functions and learn about important warnings.

Warning with the symbol, acoustic signals, visual signals or vibration

The safety functions in your car can alert you in different ways. For example, with vibration in the steering wheel, brake pulse, with visual or acoustic signals or via symbols in the driver display.

Alerts can also be shown in the head-up display*.

City Safety™



City Safety is a function that can prevent or mitigate a collision with pedestrians, cyclists, larger animals or vehicles. Visual, acoustic and brake pulse warnings are given in the event of a risk of collision to help the driver act in time. If the driver does not react to the warning and the risk of collision is assessed as imminent then City Safety can automatically brake the car.

- Brake pulse warnings, visual and acoustic signals.
- The car brakes in certain situations if the driver does not react him/herself within a reasonable amount of time.

Steering assistance at risk of collision



The function for collision avoidance assistance can help you reduce the risk of the car unintentionally leaving its lane and/or colliding with another vehicle or obstacle. The function can assist you by helping to steer the car back into its own lane and/or steer aside.

When you start the function, three subfunctions are activated which can help in different situations. Your experience of the function may therefore differ depending on which of the subfunctions is activated.

- Steering assistance upon risk of run-off: If the camera detects that the car is about to cross the edge of the road, you may feel that the function is attempting to steer the car back into its own lane. If the steering intervention is assessed as insufficient, the function will also attempt to brake the car. There will be no steering or brake intervention if you have activated the direction indicators or if the function assesses that the car is being driven actively by you as the driver.
- Steering assistance upon risk of head-on collision: If the car is about to leave its own lane while an oncoming vehicle is approaching at the same time, the function can help you as the driver to steer the car back into its own lane by means of steering intervention. There will be no steering or brake intervention if you have activated the direction indicators or if the function assesses that the car is being driven actively by you as the driver.
- Steering assistance upon risk of rear-end collision: If the car is about to leave its own lane while another vehicle is diagonally behind, in the blind spot or is approaching rapidly from behind, the function can help you to steer the car back into its own lane. Even if the direction indicators are activated and you actively steer the vehicle, the function can assist with steering intervention.

Lane Keeping Aid (LKA ^[1])



Lane assistance can help you to reduce the risk of the car unintentionally leaving its own lane. Since you have the option to choose the setting for how the function should assist you, your experience of the safety function may vary.

- Steering assistance: If the function detects that the car is approaching a lane line, you will feel a gentle steering action applied to the steering wheel. You must have both hands on the steering wheel for the function to work.
- Warning: If the function detects that the car is approaching a lane line, you will be alerted by vibration in the steering wheel.
- Both: You are alerted with vibration and a gentle steering action applied to the steering wheel.

Rear Collision Warning (RCW) *



Rear Collision Warning is a system that can help you avoid being hit by a vehicle approaching from behind. If the system detects a risk of rear-end collision, it can give a warning and take the following action, depending on the conditions.

- Intensive flashing with the direction indicators.
- At low speeds the function can tension the seatbelts by activating the seatbelt tensioners, and also activate the Whiplash Protection System.
- If the car is stationary, the foot brake can be activated.

Blind Spot Information (BLIS)



BLIS is designed to give a warning of rapidly approaching vehicles as well as vehicles diagonally behind and to the side of your vehicle so as to give you assistance in heavy traffic on roads with several lanes in the same direction.



- Alerts with an indicator lamp in the side mirror, with fixed glow and flashing light.

Driver Alert Control (DAC)



The function is intended to attract the driver's attention if he/she starts to drive less consistently, e.g. if he/she becomes distracted or starts to fall asleep.

- Acoustic signal combined with a symbol in the driver display and a message.

Distance Warning* ^[2]



Distance Warning can alert you if the time interval to the vehicle ahead suddenly becomes too short.

- Warning light and/or a symbol in the windscreen Head-up display. To have the function, the car must be equipped with a Head-up display*.

Cross Traffic Alert (CTA)*



CTA is a function designed to alert for crossing traffic when the car is being reversed.

- Acoustic signal from left or right-hand speaker, depending on the direction from which the object is approaching
- Icon in the driver display
- Icon in the park assist camera's top view

Roll Stability Control (RSC)



RSC is a stabiliser system that, in certain situations, can help to reduce the risk of overturning, for example, during sudden evasive manoeuvres or if the car skids. If the system registers that there is a risk of the car overturning, it can react with the following action:

- Engine **torque is reduced**.
- **One or more wheels are braked**.

Whiplash Protection System (WHIPS)

WHIPS is a function that can protect against whiplash injuries. The system consists of energy absorbing backrests and seat cushion, as well as a specially designed head restraint in the front seats.

Warning

The functions described are supplementary aids - they cannot handle all situations in all conditions.

The driver always bears responsibility that the vehicle is driven safely and that applicable road traffic rules and regulations are followed.

* Option/accessory.

[1] Lane Keeping Aid

[2] Distance Alert

10.19. Speed-dependent steering force

Speed related power steering causes the steering wheel force to increase with the speed of the car so as to be able to give the driver enhanced sensitivity. On motorways the steering is firmer. When parking and at low speed steering is light and requires less effort.

Reduced power

In rare situations, the power steering may need to work at reduced power, and turning the steering wheel may then seem slightly heavier. This may occur when the power steering becomes too hot and it then needs temporary cooling. It may also occur if the power supply is disrupted.



In the event of reduced power, the message **Power steering Assistance temporarily reduced** is shown, as well as this symbol in the driver display.

While the power steering is working at reduced power, the driver support functions and steering assistance systems are not available.



Warning

If the temperature increases too much, the servo may be forced to switch off completely. In such a situation, the driver display shows the **Power steering failure Stop safely** message, combined with a symbol.

Change the steering force level*

Steering wheel resistance can be adjusted when using INDIVIDUAL drive mode.

- 1 Tap on **Settings** in the centre display's top view.
- 2 Select **My Car** → **Drive Modes** → **Steering Force**.

Steering wheel resistance selection can only be accessed if the car is stationary or is moving at low speed and in a straight line.

* Option/accessory.

10.20. Drive modes when using time interval to vehicles

The driver can select different driving styles for how driver support should maintain the preset time interval to the vehicle ahead.

Selection is made via the drive mode control **DRIVE MODE**.

Select one of the following options:

- **Pure** – The driver support focuses on good fuel economy, which means longer time interval to the vehicle ahead.
- **Hybrid** – The driver support focuses on following the set time interval to the vehicle ahead as smoothly as possible.
- **Power** – The driver support focuses on following the set time interval to the vehicle ahead more closely, which in certain cases may mean heavier acceleration and braking.

10.21. IntelliSafe – driver support and safety

IntelliSafe is the Volvo Cars concept for car safety. IntelliSafe comprises a number of systems^[1], whose purpose is to make a car journey safer, to prevent injuries and to protect passengers and other road users.

Warning

The functions are supplementary aids - they cannot handle all situations in all conditions.

The driver always bears responsibility that the vehicle is driven safely and that applicable road traffic rules and regulations are followed.

Support

With the aim of assisting the driver to drive the car in a safer way, IntelliSafe has the following functions.

- Active main beam
- Tunnel detection
- Pilot Assist
- Cross Traffic Alert*
- Blind Spot Information*
- Park Assist*
- Park Assist Pilot*
- Park assist camera*
- Road Sign Information*
- Electronic stability control
- Roll Stability Control
- Speed limiter*
- Cruise control

- Adaptive cruise control *
- Rear Collision Warning
- Driver Alert Control
- All-wheel drive^[2]

Prevention

With the aim of assisting the driver to avoid an accident, IntelliSafe has the following functions.

- City Safety
- Distance Warning *
- Lane assistance
- **Collision Avoidance**

Protection

With the aim of protecting the driver and passengers in certain situations in the event of an accident, IntelliSafe has the following collaborative functions.

- Whiplash Protection System
- Seatbelts with seatbelt tensioners
- Airbags

Note

Read the individual sections on each system in order to fully understand the functions and learn about important warnings.

^[1] Some of the systems are fitted as standard, while others are options. This may vary depending on market, model year and car model.

* Option/accessory.

^[2] All Wheel Drive*

10.22. Auto braking after a collision

In the event of a collision in which the activation level is reached for the pyrotechnic seatbelt tensioners or airbags, or if a collision with a large animal is detected, the car's brakes are automatically applied. This function is to prevent or reduce the effects of any subsequent collision.

After a serious collision there is a risk that it is no longer possible to control and steer the car. In order to avoid or mitigate a possible further collision with a vehicle or an object in the vehicle's path, the auto braking system is activated automatically and brakes the car in a safe manner.

The content of this manual represents the status of the user manual at the time of printing and may not be completely valid in future instances. For more information, refer to the first page for the complete disclaimer note.

Brake lights and hazard warning lights are activated during braking. When the car has stopped, the hazard warning lights continue to flash and the parking brake is applied.

If braking is not appropriate, e.g. if there is a risk of being hit by following traffic, the system can be overridden by the driver depressing the accelerator pedal.



The function assumes that the brake system is intact after the collision.

11. Electric operation and charging

11.1. Charging the hybrid battery

11.1.1. Charging status in the car's driver display

The driver display shows the status for charging with both image and text. The information is shown for as long as the driver display is operating.

Image	Message	Specification
	Fully charged at: [Time] is shown together with an animation with blue pulsating light through the charging cable.	Charging continues and an approximate time for when the battery is estimated to be fully charged is shown.
	The text Charging complete is shown. An illustration of the car is shown with an LED indicator at the charging input socket that illuminates in green.	The battery is fully charged.
	The text Charging error is shown. The LED indicator at the charging input socket illuminates in red.	A fault has occurred, check the connection of the charging cable to the car's charging input socket and to the 230 V socket ^[1] (alternating current).

Note

If the driver display is not used for a while then it is dimmed. Reactivate the display by means of one of the following:

- depress the brake pedal
- open one of the doors
- set the car in ignition position I by turning the START knob clockwise and releasing.

^[1] The voltage in the socket may vary depending on market.

11.1.2. Regenerative braking*

The car recovers kinetic energy during braking in order to reduce fuel consumption and emissions.



The battery symbol is shown in the driver display when the car is generating power for the battery.

The function is available in all drive modes together with gear position D or B.

The content of this manual represents the status of the user manual at the time of printing and may not be completely valid in future instances. For more information, refer to the first page for the complete disclaimer note.

Activating brake regeneration

Brake regeneration is activated by gentle pressure on the brake pedal or during engine braking.



Regeneration increases during engine braking when manual gearshift mode B is selected.

* Option/accessory.

11.1.3. Opening and closing the hatch to the charging input socket

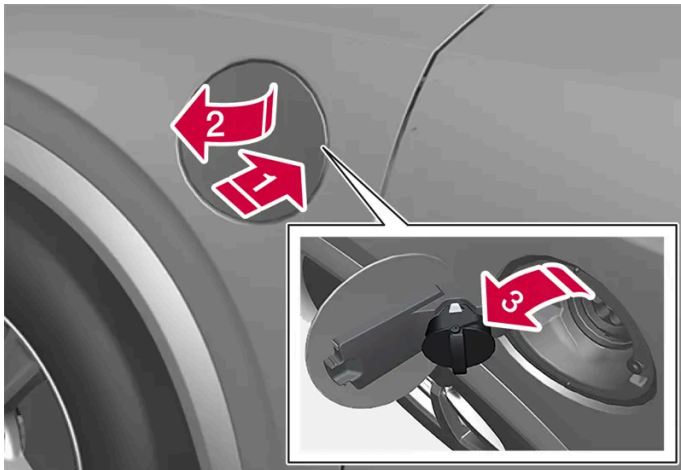
The flap for the car's charging input socket is opened manually.



- 1**  Press in the rear section of the cover and release.
- 2**  Open the cover.
- 3**  Pull away the cover for the charging input socket and secure it in the holder inside the cover. Make sure that the cover's rubber straps are bent downwards in order to prevent the cover coming off from the holder.

Important

Position the charging input socket's cover so that it does not damage the paintwork (e.g. in blustery wind).

Close the cover for the charging input socket in reverse order.

11.1.4. Charging status in the car's charging input socket

The charging input socket shows the charging status using an LED lamp.

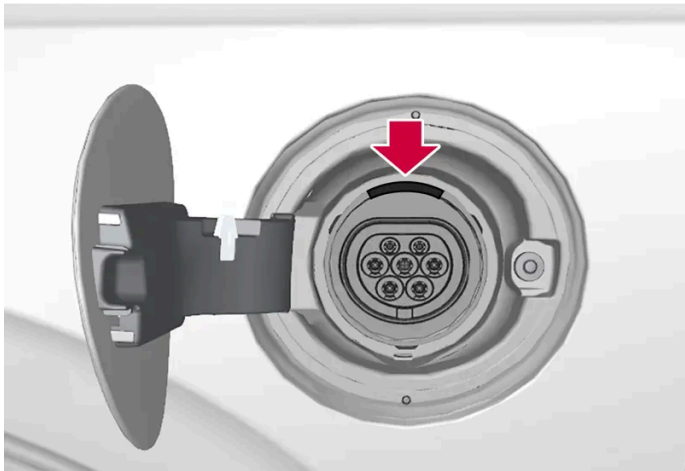

LED lamp location in the car's charging input socket.

The LED lamp shows the existing status while charging is in progress. If the LED lamp does not illuminate, check that the cable is firmly plugged into the wall socket and the socket in the car. The white, red, yellow or blue lamps are activated when the passenger compartment lighting is switched on - they remain switched on for a while after the passenger compartment lighting has been switched off.

LED lamp's glow	Specification
White	LED light
Yellow	Waiting mode ^[1] - waiting for charging to start.
Flashing green	Charging in progress ^[2] .
Green	Charging complete ^[3]
Red	A fault has arisen.
Blue	Scheduled Charging activated

^[1] For example, after a door has been opened or if the charging cable's handle is not locked in.

^[2] The slower the flashing, the closer to fully charged.

^[3] Extinguishes after a while.

11.1.5. Charging cable

The charging cable with its control unit is used to charge the car's hybrid battery.

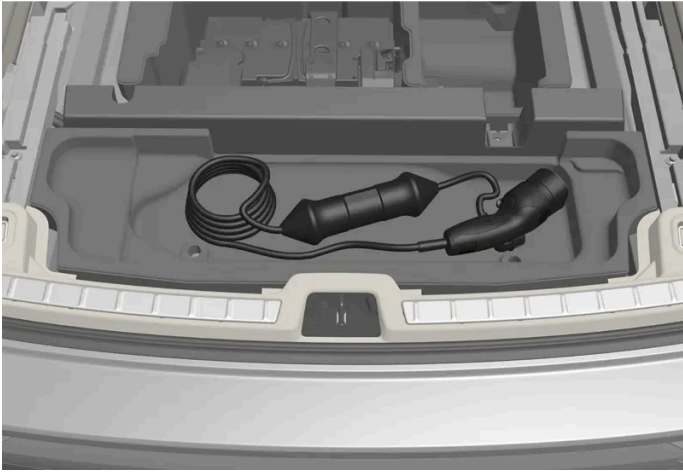

The charging cable is located in the storage compartment under the cargo area's floor hatch.

 **Warning**

Only use the charging cable provided with your vehicle or a replacement cable purchased from a Volvo retailer.

Specifications, charging cable

Ambient temperature	-32 °C to 50 °C (-25 °F to 122 °F)
---------------------	------------------------------------

 **Warning**

- The charging cable has a built-in circuit breaker. Charging must only take place with grounded and approved sockets.
- Children should be supervised when in the vicinity of the charging cable when it is plugged in.
- High voltage in the charging cable. Contact with high voltage can cause death or serious personal injury.
- Do not use the charging cable if it is damaged in any way. A damaged or inoperative charging cable must only be repaired by a workshop - an authorised Volvo workshop is recommended.
- Always position the charging cable so that it will not be driven over, stepped on, tripped over or damaged in some other way, or cause personal injury.
- Disconnect the charger from the wall outlet before cleaning it.
- Never connect the charging cable to an extension cord or a multiple plug socket.
- Do not use one or more adapters between the charging cable and the electrical socket.
- Do not use an external timer between the charging cable and the electrical socket.

Also, refer to the manufacturer's instructions for using the charging cable and its components.

! Important

Multiple plugs, external timers, adapters, extension cables, overvoltage protection or similar devices must not be used together with the charging cable as this result in a risk of fire, electric shocks, etc.

An adapter between the 230 V socket (alternating current) and the charging cable may only be used if the adapter is approved in accordance with IEC 61851 and IEC 62196.

! Important

Never unplug the charging cable from the 230 V socket (alternating current) while charging is in progress - there is then a risk of damaging the 230 V socket. Always stop charging first before unplugging the charging cable from the car's charging input socket and then from the 230 V socket.

! Important

Clean the charging cable with a clean cloth, moistened with water or a mild detergent. Do not use chemicals or solvents.

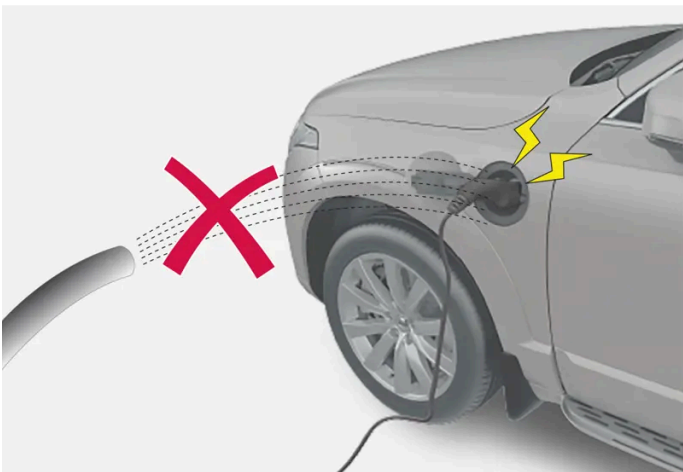

! Warning

The charging cable and its associated parts must not be swamped or immersed in water.

! Important

Avoid exposing the control unit and its plug to direct sunlight. In such cases, the overheating protection in the plug is at risk of reducing or interrupting the charging of the hybrid battery.

11.1.6. Ground fault breaker in charging cable

The control unit for the charging cable has a built-in ground fault breaker that protects the car and the user from electric shocks caused by system faults.

 **Warning**

Charging the hybrid battery must only take place with grounded and approved 230 V sockets (alternating current). If the capacity for the socket or fuse circuit is unknown, ask a licensed electrician to check the capacity. Charging above the capacity of a fuse circuit may lead to fire or damage the fuse circuit.

 **Warning**

- The charging cable's overvoltage protection helps to protect the car's charging system, but cannot guarantee that overload will never occur.
- Never use visibly worn or damaged electrical sockets. This could cause fire or serious injury.
- Never connect the charging cable to a cable extension.
- Maintenance or replacement of the hybrid battery must only be performed by a trained and qualified Volvo service technician.
- Do not use a charging cable that has not been recommended.
- An external timer must not be used between the charging cable and the electrical socket.
- One or more adapters must not be used between the charging cable and the power socket.

 **Important**

The ground fault breaker does not protect the 230 V socket (alternating current)/electrical installation.



Control unit LED^[1] lamp.

 LED lamp

If the control unit's built-in ground fault breaker is tripped then the LED lamp illuminates with a red constant glow - check the 230 V socket (alternating current).

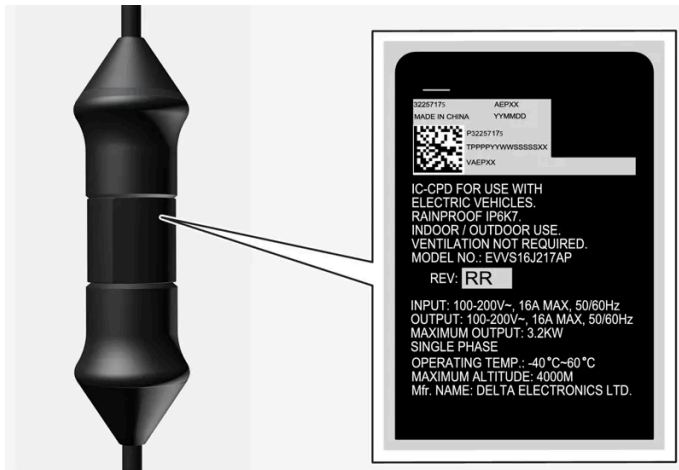

! Important

- Check the capacity of the socket.
- Other electronic equipment connected to the same fuse circuit must be disconnected if the total load is exceeded.
- Do not connect the charging cable if the socket is damaged.

^[1] LED (Light Emitting Diode)

11.1.7. Charging status in the charging cable's control unit

The indicator on the charging cable's control unit shows the status of ongoing charging as well as status after completed charging.



Control unit LED^[1] lamp.

1 LED lamp

LED	Status	Specification	Recommended action
Extinguished	Charging is not possible.	No power supply to charging cable.	<ol style="list-style-type: none"> 1. Unplug the charging cable from the socket. 2. Plug the charging cable into the socket again or use another socket. 3. If the problem persists – contact Volvo Support.
White light	Charging possible.	The charging cable is ready to be plugged into the car.	<p>If the LED lamp is white but charging is not possible:</p> <ol style="list-style-type: none"> 1. Unplug the charging cable from the charging input socket. 2. Plug the charging cable into the charging input socket again. 3. If the indicator does not flash white within approx. 10 seconds – first unplug the charging cable from the charging input socket and then from the power socket. Plug the charging cable into the charging input socket and the socket again. 4. If the problem persists – contact Volvo Support.
Flashes white	Charging in progress.	The car's electronics have started charging Charging in progress.	Wait until the batteries are fully charged.

LED	Status	Specification	Recommended action
Illuminates in red	Charging is not possible.	Temporary fault.	<ol style="list-style-type: none"> 1. Unplug the charging cable from the charging input socket. 2. Wait for a short time. 3. Plug the charging cable into the charging input socket again. 4. If the problem persists – contact Volvo Support.
Flashes red	Charging is not possible.	Critical fault.	First remove the charging cable from the charging input socket and then from the power outlet. If the problem persists – contact Volvo Support.

[1] LED (Light Emitting Diode)

11.1.8. Charging cable temperature monitoring

For the car's hybrid battery to be charged safely every time, the control unit for the charging cable and the plug have built-in monitoring devices for the temperature.

Temperature monitoring takes place in the control unit and the plug.

Note

Volvo recommends a charging cable in accordance with IEC 62196 and IEC 61851 which supports temperature monitoring.

Monitoring in the control unit

Charging is switched off if the temperature of the control unit is too high. This is to protect the electronics. This may take place at a high outside temperature, for example, and/or when strong sunlight shines directly on the control unit.

Monitoring at the plug

If the temperature at the power source to which the charging cable is connected is too high, the charging current is reduced. If the temperature exceeds a critical level, charging is stopped completely.

Important

If the temperature monitoring has automatically lowered the charging current repeatedly and charging has been interrupted then the cause of the overheating must be investigated and rectified.

11.1.9. Charging the hybrid battery

In addition to the fuel tank, as in a conventional car, the car is equipped with a rechargeable battery - a so-called hybrid battery of the lithium-ion type.

The hybrid battery is charged using a charging cable which is located in a storage compartment in the cargo area.

Note

Volvo recommends a charging cable in accordance with IEC 62196 and IEC 61851 which supports temperature monitoring.

The time it takes for the hybrid battery to be charged is dependent on the charging current that is used.

Note

The capacity of the hybrid battery decreases slightly with age and use, which may result in increased use of the petrol engine and thereby slightly increased fuel consumption.

Warning

Replacing the hybrid battery must only be performed by a workshop - an authorised Volvo workshop is recommended.

Charging cable handle and charging input socket



Charging cable handle and charging input socket.

Charging status is indicated in three ways:

- Indicators on the charging cable's control unit
- indicator lamp in the car's charging input socket
- image and text in the driver display.

The car's starter battery is charged when the hybrid battery is charging and charging is ended when the hybrid battery is fully charged. The starter battery is also charged while driving.

If the hybrid battery's temperature is below $-10\text{ }^{\circ}\text{C}$ ($14\text{ }^{\circ}\text{F}$) or above $40\text{ }^{\circ}\text{C}$ ($104\text{ }^{\circ}\text{F}$) then it may mean that some of the car's functions are changed or unavailable because the capacity of the hybrid batteries is reduced outside this temperature range.

Electric operation is not possible if the temperature of the battery is too low or too high. If drive mode PURE is selected, the combustion engine starts.

Decal on the inside of the charging flap



Use charging that is approved for use in the car in accordance with the identifier^[1] on the inside of the charging input socket flap.

Charging with fixed control unit in accordance with mode 3^[2]

In certain markets the control unit is installed within a charging station connected to the mains power circuit. In which case, the charging cable has no control unit of its own. Therefore, use the charging station's charging cable and follow the instructions at the charging station.

Energy recovery during braking



Indication in driver display during energy recovery.

Energy is regenerated to the battery during light pressure on the brake pedal or during engine braking.

The function is available in all drive modes together with gear position D or B.

^[1] Identifiers that comply with CEN standard EN 17186 can be found on the inside of the charging input socket flap.

^[2] European standard - EN 61851-1.

11.1.10. Starting hybrid battery charging

The car's hybrid battery is charged with a charging cable between the car and a 230 V socket^[1] (alternating current).

Only use the charging cable provided with your car or a replacement cable recommended by Volvo.

 **Important**

Never connect the charging cable when there is a risk of thunderstorm or lightning strike.

 **Note**

Volvo recommends a charging cable in accordance with IEC 62196 and IEC 61851 which supports temperature monitoring.

 **Warning**

- The hybrid battery must only be charged at maximum permitted charging current or lower in accordance with applicable local and national recommendations for hybrid charging from 230 V sockets (alternating current)/plugs.
- Charging the hybrid battery must only take place from an approved grounded 230 V socket^[2] or from a charging station with a loose charging cable (Mode 3) supplied by Volvo.
- The control unit's ground fault breaker protects the car, but there may still be a risk of overloading the 230 V mains power circuit.
- Avoid visible worn or damaged mains sockets since they may lead to fire damage and/or personal injury if used.
- Never use an extension cable.
- Never use an adapter or external timer.

 **Warning**

- The charging cable has a built-in circuit breaker. Charging must only take place with grounded and approved sockets.
- Children should be supervised when in the vicinity of the charging cable when it is plugged in.
- High voltage in the charging cable. Contact with high voltage can cause death or serious personal injury.
- Do not use the charging cable if it is damaged in any way. A damaged or inoperative charging cable must only be repaired by a workshop - an authorised Volvo workshop is recommended.
- Always position the charging cable so that it will not be driven over, stepped on, tripped over or damaged in some other way, or cause personal injury.
- Disconnect the charger from the wall outlet before cleaning it.
- Never connect the charging cable to an extension cord or a multiple plug socket.
- Do not use one or more adapters between the charging cable and the electrical socket.
- Do not use an external timer between the charging cable and the electrical socket.

Also, refer to the manufacturer's instructions for using the charging cable and its components.

 **Important**

Check that the 230 V socket (alternating current) has adequate power capacity for charging electric vehicles – in the event of uncertainty, the socket must be checked by a qualified professional.

Note that the car must be switched off before charging.

Take out the charging cable from the storage compartment.

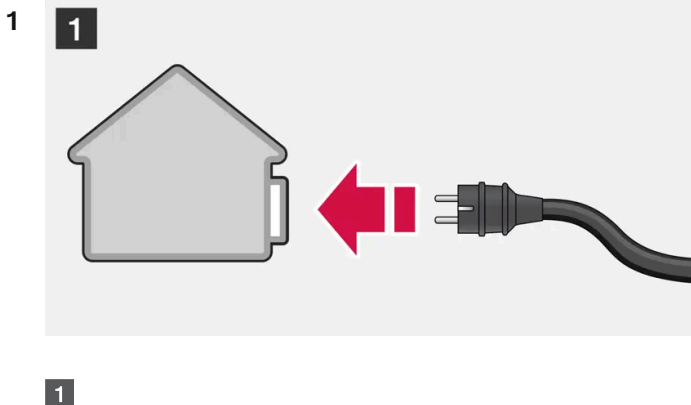

Connect the charging cable to a 230 V socket. Never use an extension cable.



2

Open the charging hatch and undo the charging input socket cover. Remove the charging handle's protective cover and then press the handle the whole way into the socket for the car.



3

Clamp the charging handle's cover in place as illustrated.

 **Important**

To avoid damage to the paint, e.g. in the event of high winds, position the charging handle's protective cover so that it does not touch the car.

4 The charging cable's charging handle is fastened/locked in, and charging starts within 5 seconds. When charging has started, the LED lamp in the charging input socket flashes with a green glow. The driver display shows the remaining estimated charging time or whether charging is not working as intended.

Battery charging can be interrupted for a while if the car is unlocked. If the charging cable is left in the charging input socket, the charge will restart again after a while.

 **Important**

Never unplug the charging cable from the 230 V socket (alternating current) while charging is in progress - there is then a risk of damaging the 230 V socket. Always stop charging first before unplugging the charging cable from the car's charging input socket and then from the 230 V socket.

Condensation from the air conditioning may drip under the car during charging. This is normal and takes place due to cooling of the hybrid battery.

[1] The voltage in the socket may vary depending on market.

[2] Or equivalent sockets with a different voltage, depending on market.

11.1.11. Ending hybrid battery charging

Finish charging by unlocking the car, unplugging the charging cable from the car's charging input socket and then from the 230 V socket [1] (alternating current).

! Important

Before the charging cable is disconnected from the car's charging input socket, the car must be unlocked using the unlock button on the remote control key. This must be carried out even if the doors on the car are already unlocked. If the car is not unlocked using the unlock button, this may lead to damage to the charging cable or to the system.

i Note

Always unlock the car so that charging is stopped before the connection to the 230 V socket (alternating current) is unplugged. Note that the charging cable must be unplugged from the car's charging input socket before being unplugged from the 230 V socket, partly to avoid damage to the system and partly to avoid stopping the charging unintentionally.



Unlock the car with the remote control key - charging is finished and the charging cable's locked handle releases/is unlocked.

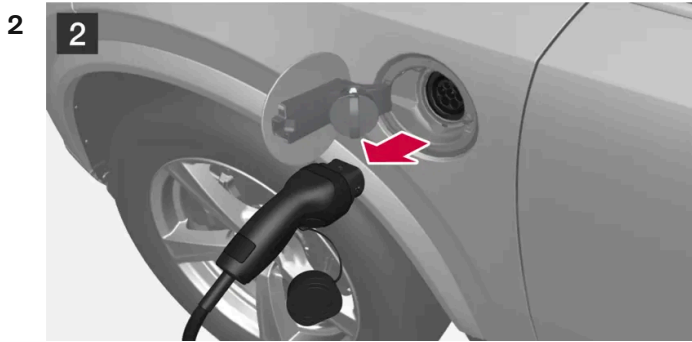

2
Unplug the cable from the car's charging input socket, refit the charging input socket's cover and close the hatch.

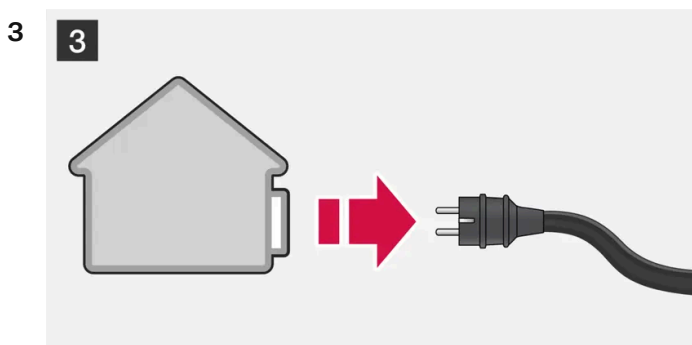

3
Unplug the cable from the 230 V socket.
Return the charging cable to the car's storage compartment.

The charging cable is locked automatically

If the charging cable is not unplugged from the charging input socket, it is locked in again automatically shortly after unlocking in order to maximise charging and range, as well as to facilitate preconditioning prior to the journey. The charging cable can be unplugged again if the car is unlocked using the remote control key. For cars with Passive Entry*, you can lock and unlock using the handle again.

^[1] The voltage in the socket may vary depending on market.

* Option/accessory.

11.1.12. Charging current

Charging current is used for charging the hybrid battery as well as preconditioning of the car. Charging takes place with a charging cable connected to the car's charging input socket and a 230 V socket^[1] (alternating

current).

When the charging cable is activated, the driver display shows a message and a lamp in the car's charging input socket illuminates. The charging current is mainly used for battery charging, but it is also used for preconditioning of the car. The 12V battery is also charged when the car's battery is charged.

! Important

Never unplug the charging cable from the 230 V socket (alternating current) while charging is in progress - there is then a risk of damaging the 230 V socket. Always stop charging first before unplugging the charging cable from the car's charging input socket and then from the 230 V socket.

! Important

Ensure that the wall socket fuse can handle the specified amperage for the charging cable.

i Note

- If the weather is very hot or very cold, some of the charging current is used to heat/cool the hybrid battery and the passenger compartment, which results in a longer charging time.
- The charging time is extended if preconditioning has been selected. The time required depends mainly on the outside temperature.

Charging time

Charging times may vary. The following charging times are applicable when air conditioning or any other consumer is not affecting charging. If charging time seems long, it should be investigated.

Charging times for charging with 230V	
Current intensity (A) ^[2]	Charging time (hours)
6	8
10	4
16	3

Fuse

Normally several 230 V consumers are included in a fuse circuit, so additional consumers (e.g. lighting, vacuum cleaner, electric drill, etc.) can be on the same fuse.

^[1] The voltage in the socket may vary depending on market.

^[2] Maximum charging current may vary depending on market.

11.2. Hybrid battery gauge

The hybrid battery gauge shows how much energy there is in the hybrid battery.

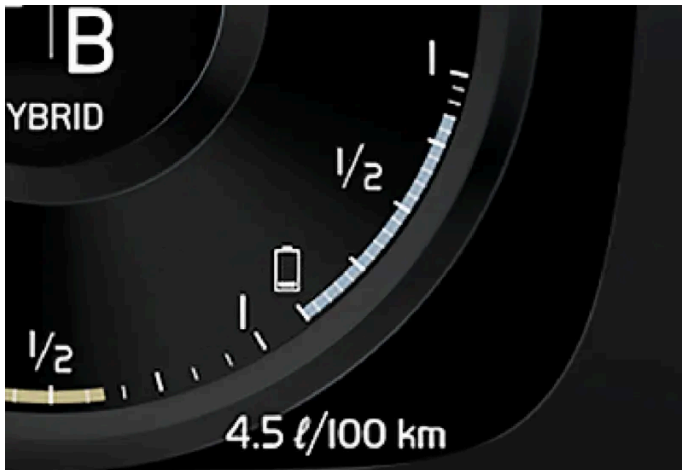

The energy in the hybrid battery is used for the electric motor, but also to cool or heat the car. The trip computer calculates an approximate distance for the energy left in the hybrid battery.

Symbols in the hybrid battery gauge



The  symbol in the hybrid battery gauge indicates that the **Hold** function is activated, and the  symbol indicates that the **Charge** function is activated.

11.3. Hybrid gauge

In drive modes Hybrid and Pure, the driver display shows a hybrid gauge that can help the driver to drive the car in a more energy-efficient way.

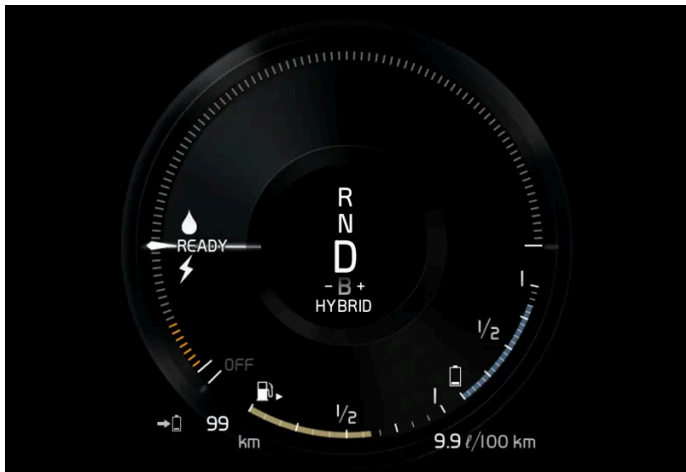

The hybrid gauge shows in different ways the relationship between how much power is being taken from the electric motor and how much power is available.

Symbols in the hybrid gauge



Indicates current level for available electric motor power. If the symbol is filled in, it means that the electric motor is in use.



If the symbol is not filled in, it means that the electric motor is not in use.



Indicates the power level when the combustion engine starts. If the symbol is filled in, it means that the combustion engine is in use.



Indicates the power level when the internal combustion engine is due to start. If the symbol is not filled in, it means that the combustion engine is not in use.



Indicator that shows that the hybrid battery is being charged e.g. if the brake pedal is gently depressed.

Driver-requested power

The pointer in the hybrid gauge indicates the amount of engine power requested by the driver by regulating the accelerator pedal. The higher the reading on the scale, the more power is requested by the driver in the current gear. The marker between the lightning flash and the drop shows the point at which the internal combustion engine starts.

Example:

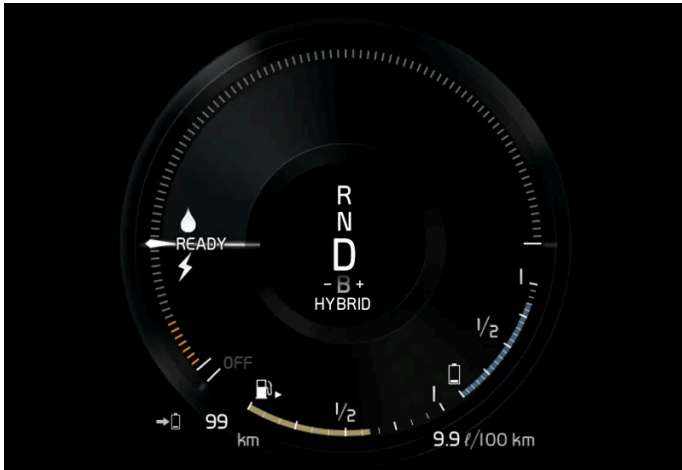

The car is started but stationary, no power is requested.

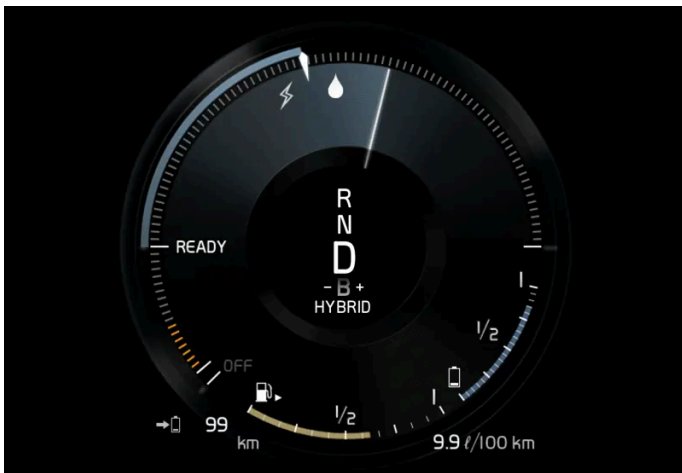

The electric motor cannot supply the amount of engine power requested and the internal combustion engine starts.

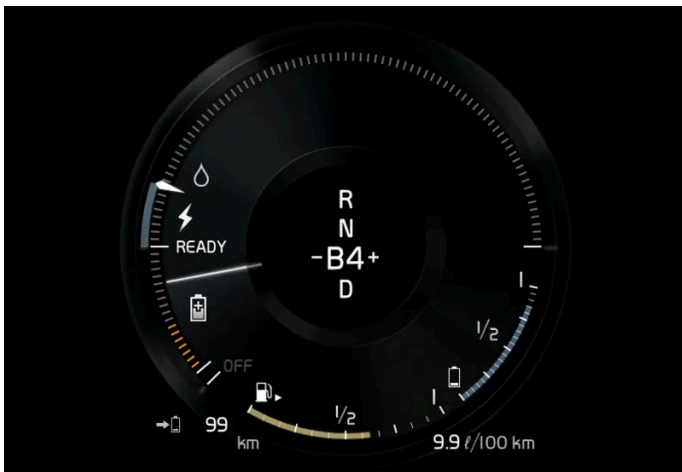

The car generates current to the battery, the battery is charged, e.g. when the brake pedal is pressed lightly or during engine braking down a hill.

11.4. Drive systems

The content of this manual represents the status of the user manual at the time of printing and may not be completely valid in future instances. For more information, refer to the first page for the complete disclaimer note.

The car combines an internal combustion engine that drives the front wheels with an electric motor that drives the rear wheels.

Two drive systems

Depending on the driver-selected drive mode and available electric energy, the two drive systems can be used either individually or in parallel.

The electric motor is supplied its energy from a hybrid battery fitted in the tunnel console. The hybrid battery can be charged in a wall socket, or in a special charging station. The internal combustion engine can also charge the hybrid battery with a special high-voltage generator.

Both the internal combustion engine and electric motor can generate motive force directly to the wheels. An advanced control system combines the properties of both drive systems in order to provide optimum driving economy.



- 1 Hybrid battery - The function of the hybrid battery is to store energy. It receives energy when charging from the mains power circuit, during regenerative braking or from the high-voltage generator. It provides energy for electric operation as well as for temporarily operating the electric air conditioning during the preconditioning of the passenger compartment.
- 2 Internal combustion engine - The internal combustion engine starts when the energy level in the hybrid battery is insufficient for the engine power that the driver requests.
- 3 High voltage generator^[1] - Charges the hybrid battery. Starter motor for the internal combustion engine. Can support the internal combustion engine with extra electrical energy.
- 4 Electric motor - Powers the car in electric operation. If necessary, provides extra torque and power during acceleration. Provides electrical all-wheel drive functionality. Recycles brake energy to electrical energy.

^[1] CISG (Crank Integrated Starter Generator) - Combined high-voltage generator and starter motor.

11.5. Hold and Charge

In some situations, it can be useful to be able to control the hybrid battery's state of charge while driving is in progress. This is possible with the functions **Hold** and **Charge**.

Hold and **Charge** are available in all drive modes. The functions are cancelled if **Pure** drive mode is activated.

Activating Hold and Charge

The functions are activated in the centre display's function view.

Hold



Battery level sustained for later use.

The function maintains the charge in the hybrid battery for electric drive and saves available electricity for later use e.g. for driving in an urban environment.

The car works as for normal hybrid operation with discharged battery where, in addition to re-using brake-generated energy, for example, the car starts the internal combustion engine more often in order to maintain the charge in the battery.

Charge



Engine charges hybrid battery.

The function charges the hybrid battery with assistance from the internal combustion engine for using increased electric operation at a later time.

Symbols in the driver display



The symbol  is shown in the hybrid battery gauge when Hold is activated.

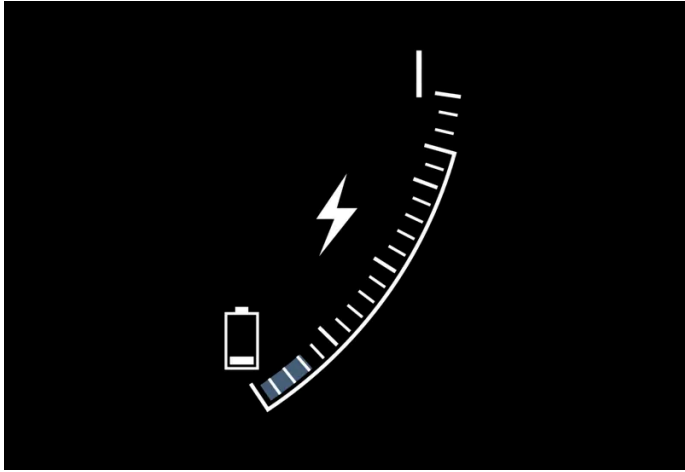

The symbol  is shown in the hybrid battery gauge when Charge is activated.

11.6. Drive modes

Selection of drive mode affects the car's driving characteristics in order to enhance the driving experience and facilitate driving in special situations.

Using the drive modes it is possible to quickly have access to the car's numerous functions and settings for different driving needs. Each drive mode is adapted to provide optimum driving characteristics:

- Steering
- Engine/gearbox/all-wheel drive
- Brakes
- Level control* and shock absorption
- Driver display
- Climate settings

Select the drive mode adapted for the current driving conditions. Remember that not all drive modes are available in all situations.

Selectable drive modes

 **Warning**

Remember that the car does not emit any engine noise when it is only powered by the electric motor and may therefore be difficult to notice by children, pedestrians, cyclists and animals. This applies in particular at low speeds such as in car parks.

 **Warning**

Do not leave the car in an unventilated area with activated drive mode and the fuel-driven engine switched off - automatic engine start occurs at low energy level in the hybrid battery, and the exhaust gases could then cause serious injury to people and animals.

Hybrid

- This is the car's normal mode where the electric motor and internal combustion engine work together.

When the car starts, it is in the **Hybrid** mode. The control system uses both the electric motor and internal combustion engine – individually or in parallel – and adapts use with regard to performance, fuel consumption and comfort. At higher speeds the ground clearance is adjusted automatically to a lower level^[1] in order to reduce wind resistance. The capacity to run solely with the electric motor depends on the hybrid battery's energy level and, for example, the need for heating or cooling in the passenger compartment.

If high power output is available, it is possible to drive with electrical power alone. When the accelerator pedal is depressed, only the electric motor is activated until a certain position is reached. The internal combustion engine starts when this position is exceeded and the energy level in the battery is insufficient for the engine power that the driver requests with the accelerator pedal.

At low energy level (hybrid battery almost empty) the battery's energy level must be maintained, leading to the internal combustion engine starting more often. Charge the hybrid battery from a 230 VAC socket with the charging cable, or activate **Charge** in the function view in order to restore the capacity to run on electricity alone.

The drive mode is designed for low energy consumption with a mix of the electric motor and the internal combustion engine, without compromising the climate comfort and driving experience. When higher acceleration is required, maximum additional power from the electric drive line is used.

The car also senses if the driving conditions require all-wheel drive and automatically engages it if necessary. All-wheel drive and electric additional power are always available regardless of the battery's state of charge.

Information in the driver display

When driving in hybrid mode the driver display shows a hybrid gauge. The pointer in the hybrid gauge indicates how much energy the driver requests with the accelerator pedal. The marking between the lightning bolt and the drop shows how much energy is available.

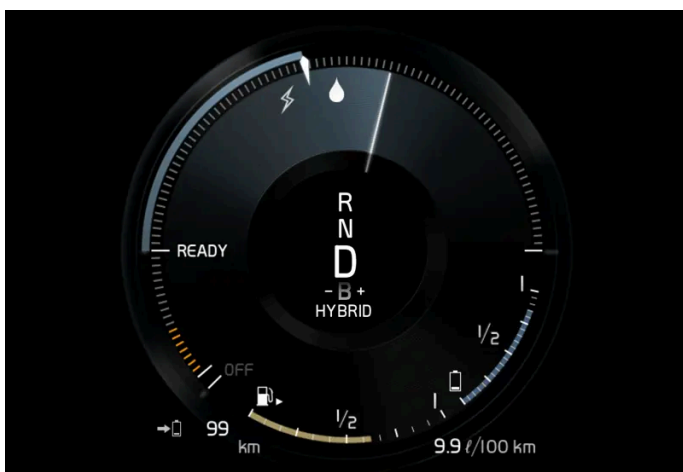

The driver display for propulsion with both the electric motor and internal combustion engine.



The driver display also shows when energy is returned to the battery (regenerated) during light braking.

Pure

- Drive the car with electric motor, with energy consumption as low as possible and with lowest possible carbon dioxide emissions.

The drive mode prioritises driving on the hybrid battery. This means, for example, that the ground clearance is lower^[1] to reduce wind resistance and the output of certain climate settings is reduced to provide the longest possible mileage range on electric power alone.

The **Pure** mode is available when the hybrid battery has a sufficiently high State of Charge (SoC) and available power output, which may be affected by temperature. When the internal combustion engine starts, the drive mode automatically changes to the **Hybrid** mode until the driver has the opportunity to select the **Pure** mode again.

The internal combustion engine starts:

- if the battery's State of Charge (SoC) is too low
- if the driver fully depresses the accelerator pedal.

The **Pure** mode is not available:

- if the battery's State of Charge (SoC) is too low
- if the speed exceeds 140 km/h(87 mph) (does not apply when driving downhill, etc.)
- in the event of system/component limitations e.g. low outside temperature.

Note

The internal combustion engine may start temporarily in certain driving situations when the **Pure** drive mode is in use. This is in order to provide the wheels with the desired torque in driving situations that require higher load, e.g. when driving with a trailer or on an uphill gradient.

The drive mode is adapted for maximum range with electric propulsion and especially developed for urban traffic. **Pure** means lowest combustion even when the hybrid battery is empty. The climate in the passenger compartment is regulated to Eco climate, and in slippery driving conditions, more wheel spin can be permitted before all-wheel drive is activated automatically.

ECO climate control

In the **Pure** drive mode, eco climate control is activated automatically in the passenger compartment in order to reduce energy consumption.

 **Note**

When the **Pure** drive mode is activated, several parameters in the climate control system's settings are changed, and several electricity consumer functions are reduced. Certain settings can be reset manually, but full functionality is only regained by leaving **Pure** drive mode or adapting **Individual** drive mode with full climate functionality.

In the event of difficulties due to misting, press the button for max. defroster which has normal functionality.

Off Road

- Prioritise the car's traction when driving in difficult terrain and on poor roads.

The drive mode provides high ground clearance^[1], steering is light, all-wheel drive and the function for low speed control with hill descent control (Hill Descent Control) are activated.

The drive mode is only available at low speeds, up to 40 km/h (25 mph). If this speed is exceeded, **Off Road** mode is cancelled and the **Constant AWD** drive mode is activated instead.

To be able to drive all four wheels, the internal combustion engine and electric motor run continually, which results in increased fuel consumption.

In the **Off Road** mode the driver display has a compass between the speedometer and tachometer. The speedometer shows the range for speed limitation.

The drive mode is adapted for maximum controllability at low speeds in poor road conditions or difficult terrain. It raises the chassis^[1], reduces the driveline's throttle response and locks the car in all-wheel drive. The Hill Descent Control function facilitates controlled driving on steep descents.

 **Note**

The driving mode is not designed to be used on public roads.

 **Note**

If the car is switched off in **Off Road** mode, and therefore has high ground clearance, the car is lowered next time it is started.

 **Important**

The **Off Road** drive mode must not be used while driving with a trailer without trailer connector. Otherwise, there is a risk of damage to the air bellows.

Constant AWD

- Improve the car's roadholding and traction with enhanced all-wheel drive.

The drive mode locks the car in all-wheel drive. An adapted distribution between the front and rear axle torque provides good traction, stability and roadholding, for example on slippery roads, when driving with a heavy trailer, or when towing. **Constant AWD** drive mode is always available regardless of the battery's state of charge.

Both the internal combustion engine and electric motor are engaged in order to drive all four wheels, which results in increased fuel consumption.

In the car's other drive modes, the car automatically adapts the need for all-wheel drive to the road surface, and can engage the electric motor or start the internal combustion engine when necessary.

Power

- The car has sportier characteristics and faster response to accelerating.

The drive mode adapts the combined power from the internal combustion engine and electric motor by means of the car being driven by both front and rear wheels. The gear changes become faster and more distinct, and the gearbox prioritises a gear with greater traction. Steering response is faster, shock absorption is harder and a lower ground clearance^[1] means that the body follows the roadway in order to reduce roll during cornering.

Both the internal combustion engine and electric motor are engaged in order to drive all four wheels, which results in increased fuel consumption.

The drive mode is adapted for maximum performance and response on acceleration. It changes the internal combustion engine's accelerator pedal response, gear shift pattern and boost pressure system. Chassis settings, steering and brake response are also as good as possible. **Power** drive mode is always available regardless of the battery's state of charge.

The **Power** mode is also available in the **Polestar Engineered** version*.

Individual

- Adapting a drive mode according to individual preferences.

Select a drive mode to start from, and then adjust the settings according to the desired driving characteristics. These settings are saved in an individual driver profile.

An individual drive mode is only available if it is first activated in the centre display.

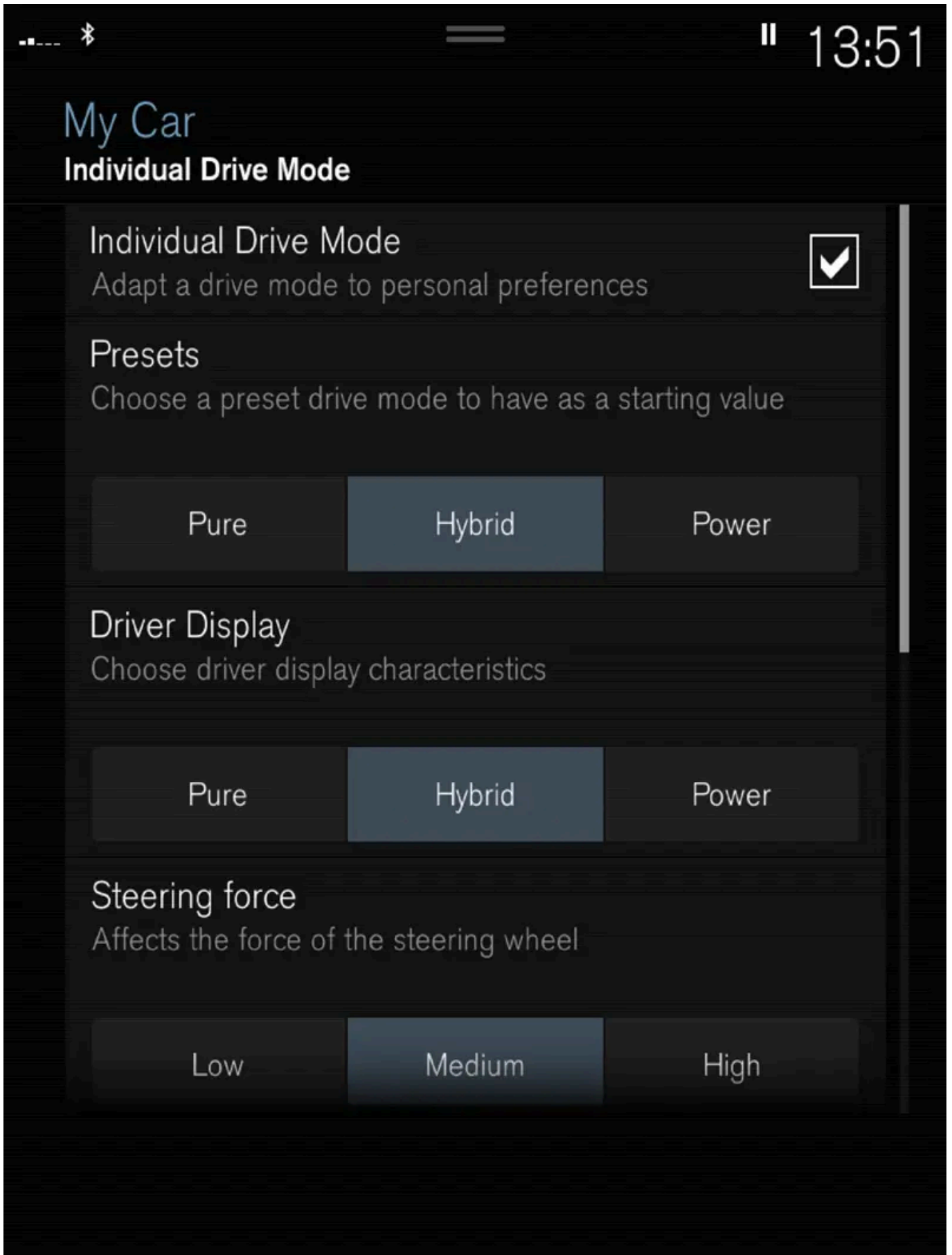

Settings view^[2] for individual drive mode.

- 1 Press **Settings** in the top view.

The content of this manual represents the status of the user manual at the time of printing and may not be completely valid in future instances. For more information, refer to the first page for the complete disclaimer note.

2 Press **My Car** → **Individual Drive Mode** and select **Individual Drive Mode**.

3 In **Presets**, select a drive mode to start from: **Pure**, **Hybrid**, **Power** or **Polestar Engineered***.

Possible adjustments apply to settings for:

- **Driver Display**
- **Steering Force**
- **Powertrain Characteristics**
- **Brake Characteristics**
- **Suspension Control**
- **ECO Climate**

Using the electric motor or internal combustion engine

An advanced control system determines the extent to which the car is driven on internal combustion engine, electric motor or both in parallel.

The primary function is to use the engine or motor and the available energy in the hybrid battery as efficiently as possible, with regard to the characteristics of the different drive modes as well as the driver's request for power via the accelerator pedal.

There are also cases where temporary limitations in the system, or functions governed by legal requirements aimed at maintaining a low level of total emissions for the car, may use the internal combustion engine to a greater extent.

* Option/accessory.

^[1] Applies with air suspension.

^[2] The figure is schematic - parts may vary depending on car model.

11.7. General information on electric drive

The hybrid car runs like a regular car, but certain functions differ from a car that only runs on petrol or diesel. The electric motor drives the car mostly at low speeds, the petrol engine at higher speeds, as well as during more active driving.

The driver display shows some information that is unique to the Recharge - charging information, selected drive mode, distance to empty battery as well as the hybrid battery's charge level.

It is possible to set the car in different drive modes while driving, e.g. electric operation only or, when power is required, both electric motor and petrol engine. The car calculates a combination of drivability, driving experience, environmental impact and fuel economy according to the drive mode selected.

In order that the car should have optimal function it is important that the hybrid battery with associated electrical drive systems, as well as the petrol engine and its drive systems, have the correct operating temperature. Battery capacity may be reduced considerably if the battery is too cold or too hot.

Preconditioning prepares the car's drive systems and the passenger compartment before departure so that both wear and energy needs during the journey are reduced. Connecting the car to charging while preconditioning is in progress can increase the range for the hybrid battery.

The hybrid battery which drives the electric motor is charged via a charging cable but can also be charged by gentle braking and engine braking in gear position B. The hybrid battery can also be charged by the car's engine.

Important to know

Warning

Charging the car can affect the function of an implanted pacemaker or other medical equipment. People with an implanted pacemaker are recommended to consult a doctor before starting charging.

Car without power

Bear in mind that important functions such as the servo brakes and power steering are limited when the car is without power.

Warning

The brake servo only works when the electric motor or internal combustion engine is running.

Towing not permitted

Towing the car is not permitted since this damages the electric motor.

Exterior engine noise

Warning

Remember that the car does not emit any engine noise when it is only powered by the electric motor and may therefore be difficult to notice by children, pedestrians, cyclists and animals. This is especially true at low speeds, such as in car parks.

High-voltage current











Warning

Several components in the car work with high-voltage current that could be dangerous in the event of incorrect intervention. These components, and all orange-coloured cables, must only be handled by qualified personnel.

Do not touch anything that is not clearly described in the owner's manual.

11.8. Symbols and messages relating to hybrid drive in the driver display

A number of symbols and messages regarding hybrid drive can be shown in the driver display. They may also be shown in combination with general indicator and warning symbols and are then extinguished when the problems have been rectified.

Symbol	Message	Specification
	12 V Battery Charging fault, service urgent. Drive to workshop	Fault in the 12V battery. Contact a workshop ^[1] to check the battery as soon as possible.
	12 V Battery Charging fault Stop safely	Fault in the 12V battery. Stop the car safely and contact a workshop ^[1] to have the battery checked as soon as possible.
	12 V Battery Fuse failure Service required	Fault in the 12V battery. Contact a workshop ^[1] to check the function as soon as possible.
	HV battery Overheated, stop safely	The temperature of the hybrid battery seems to be rising abnormally. Stop the car and switch off the engine. Wait at least 5 minutes before continuing to drive. Call a workshop ^[1] or check from the outside that everything seems normal before continuing to drive.
	Reduced performance Max car speed limited	The hybrid battery is not sufficiently charged for driving at high speeds. Charge the battery as soon as possible.
	Propulsion system Harsh behaviour at low speed, car ok to use	The hybrid system does not function as intended. Contact a workshop ^[1] to check the function as soon as possible.
	Hybrid system failure Service required	The hybrid system is disengaged. Contact a workshop ^[1] to check the function as soon as possible.
	Charge cable Remove before start	Shown when the driver tries to start the car and the charging cable is connected to the car. Disconnect the charging cable and close the charging hatch.

^[1] An authorised Volvo workshop is recommended.

11.9. Long-term storage of cars with hybrid batteries

To minimise the risk of damage to the hybrid battery during long-term storage (longer than 1 month) it is recommended that the state of charge (SoC) is maintained at approximately 25%. Check the charge level in the driver display on a regular basis.

Before long-term storage

Recommended state of charge (SoC) for long-term storage is approximately 25%.

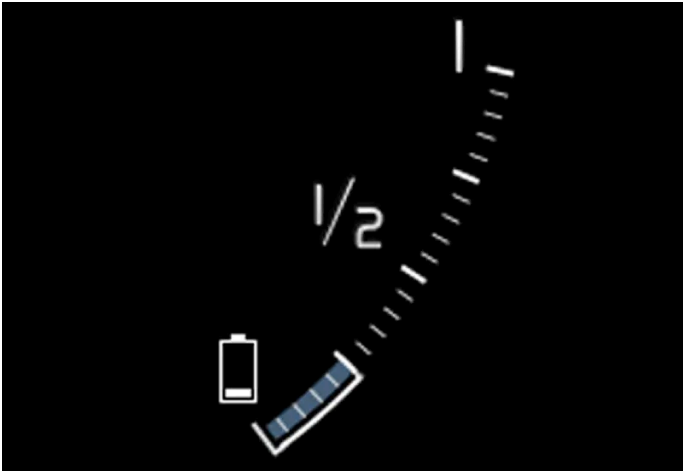

- If the state of charge (SoC) is high – drive the car until it reaches the recommended level.
- If the state of charge (SoC) is low – charge the car to the recommended level.

During long-term storage

Check the state of charge (SoC) in the driver display on a regular basis.

Charge the car if the state of charge (SoC) has fallen noticeably, or if it has not been charged for longer than 6 months. This compensates for the natural self-discharge of the battery.

Note

Store the car in a cool place and avoid extreme temperatures during long-term storage in order to minimise the risk of battery damage. Select a storage location indoors or in the shade, depending on where the temperature is lowest, particularly in a hot climate.

11.10. Range in electric mode

The car's range depends on several factors. The ability to achieve a long range varies according to the circumstances and conditions under which the car is being driven.

The certified value for the car's mileage should not be interpreted as an expected range. The certified value should primarily be used to compare different cars and is obtained during special test cycles.

Range in the driver display

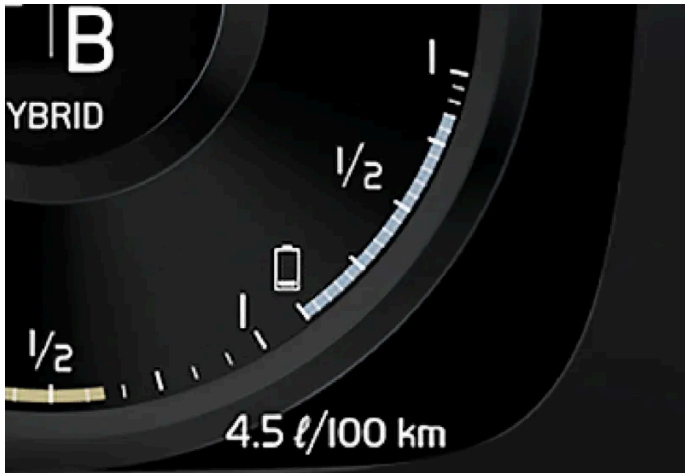

When the car is delivered from the factory, or after a factory reset, the range is based on the certified value.

When the car has been driven for a while, the range is based on historical driving patterns. The amount of history used depends on the battery's state of charge. Therefore, the less charge there is in the hybrid battery, the faster the range adapts to a changed driving pattern.

Factors that affect the range

In addition to historical trip data, there are several different factors that affect the range. The longest range is achieved under extremely favourable conditions when all factors have a positive impact.

Examples of factors that affect the range:

- speed
- climate settings
- topography
- preconditioning
- tyres and tyre pressure
- traffic situation
- temperature and weather
- road conditions.

Range based on speed and outside temperature

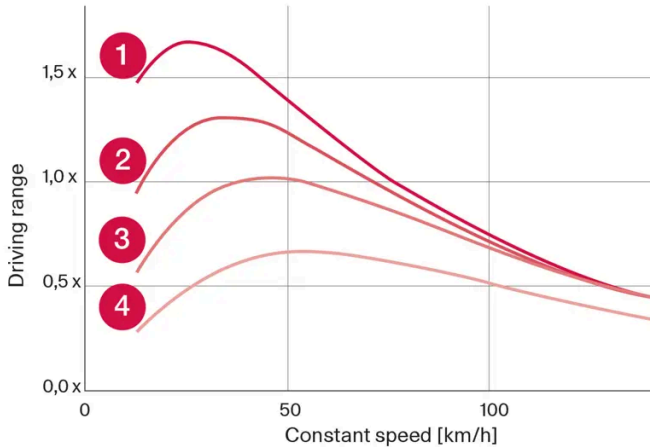

- 1 20 °C (68 °F) outside temperature and passenger compartment climate Off.
- 2 0 °C (32 °F) outside temperature and passenger compartment climate On.
- 3 35 °C (95 °F) outside temperature and passenger compartment climate On.
- 4 -10 °C (14 °F) outside temperature and passenger compartment climate On.

The graph shows the approximate relationship between constant speed and range, where a lower constant speed has a positive effect on range.

A higher outside temperature and deactivated climate control are also more beneficial for the range.

11.11. Economical driving

To achieve the longest possible range, the driver should plan driving and adapt driving style and speed to the prevailing situation.

Before driving

- Precondition the car before driving if possible using the charging cable connected to the mains power circuit.
- If preconditioning is not possible when it is cold outside, use seat heating and steering wheel heating first of all. Avoid warming up the whole of the interior which takes energy from the hybrid battery.
- Choice of tyres and tyre pressure can affect energy consumption - seek advice on suitable tyres from an authorised Volvo dealer.
- Remove unnecessary items from the car - the greater the load the higher the consumption.

While driving

- Activate drive mode **Pure**.
- Activate the **Hold** function at higher speeds during journeys that are longer than the range of the electricity.
- If possible, avoid using the **Charge** function to charge the hybrid battery.
- Drive at a steady speed and keep a good distance to other vehicles and objects in order to avoid braking.

The content of this manual represents the status of the user manual at the time of printing and may not be completely valid in future instances. For more information, refer to the first page for the complete disclaimer note.

- The hybrid battery is recharged during braking by braking gently with the brake pedal.
- High speed results in increased energy consumption since the wind resistance increases with speed.
- In a cold climate, reduce electrical heating of windows, mirrors, seats and steering wheel, if possible.
- Avoid driving with open windows.
- Do not hold the car stationary on a hill with the accelerator pedal. Instead, activate the function for braking when stationary.
- If possible, deactivate the climate control while driving a short distance after preconditioning.

After driving

- If possible, park in an acclimated garage with charging facilities.

11.12. Recycling the batteries

Used batteries must be recycled in an environmentally sound manner.

Consult a workshop in the event of uncertainty about how this type of waste should be discarded - an authorised Volvo workshop is recommended. The hybrid battery must only be handled by authorised workshop personnel.

11.13. Hybrid battery

The car is equipped with a hybrid battery for electric motor operation - a maintenance-free rechargeable Lithium-ion type battery.

Note

The car cannot be started if the hybrid battery is discharged.

If both the starter battery and the hybrid battery are discharged then both batteries must be charged. In such a case, charging only the hybrid battery is not possible. In order for the hybrid battery to be charged, the starter battery must have a certain state of charge.

Warning

The hybrid battery must only be replaced by a workshop - an authorised Volvo workshop is recommended.

The service life and capacity of the hybrid battery

The capacity of the hybrid battery diminishes with age and use, which may result in increased use of the internal combustion engine and, as a consequence, reduced fuel economy and reduced range during electric operation.

Coolant

The hybrid battery's cooling system has a separate expansion tank.

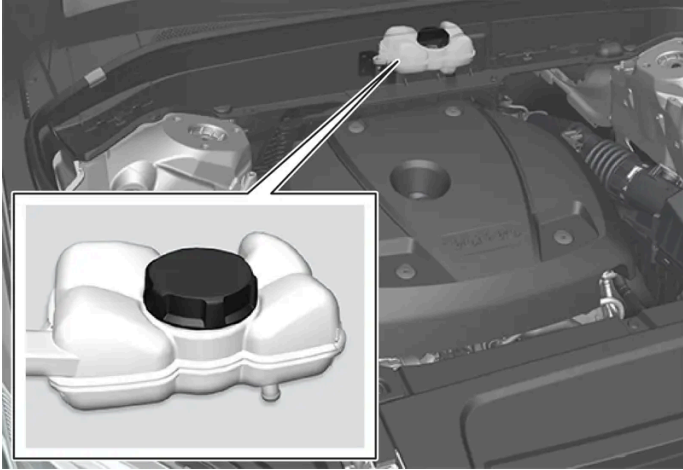

Important

The hybrid battery's coolant must only be topped up by a workshop - an authorised Volvo workshop is recommended.

Specifications for hybrid battery

Type: Lithium-ion

Total amount of energy: 11.6 kWh.

12. Starting and driving

12.1. Starting and switching off the car

12.1.1. Immobiliser

The electronic immobiliser is a theft protection system that prevents an unauthorised person from starting the car.

The car can only be started with the correct remote control key.

The following error message in the driver display is related to the electronic immobiliser:

Symbol	Message	Specification
	Car key not found	Error reading the remote control key during starting - place the key on the key symbol in the cup holder and try again.

12.1.2. Starting the car

The car is started using the start knob in the tunnel console when the remote control key is in the passenger compartment.



Start knob in the tunnel console.

 **Warning**

Before starting:

- Fasten the seatbelt.
- Adjust the seat, steering wheel and mirrors.
- Make sure that the brake pedal can be fully depressed.

The remote control key is not physically used when starting the car since it is equipped with support for keyless starting (Passive start).

To start the car:

1

 **Important**

The car cannot be started if the charging cable is still connected. Make sure the charging cable is unplugged and the charging hatch is closed before the starting the car.

The remote control key must be inside the car. For cars with Passive Start, the key needs to be located in the front part of the passenger compartment. With the option for keyless locking/unlocking* of the car, the key can be anywhere in the car.

- 2 Hold the brake pedal depressed^[1] fully. For cars with automatic gear changing, make sure that gear position P or N is selected. For cars with a manual gearbox, make sure that the gear lever is in neutral position or that the clutch pedal is depressed.
- 3 Turn the start knob clockwise and then release it. The control automatically returns to its starting position.

When the engine is started, the starter motor works until the engine is started or until its overheating protection triggers.

When starting in normal conditions, the car's electric drive motor is prioritised - the petrol engine remains switched off. This means that after the start knob has been turned clockwise, the electric motor has "started" and the car is ready to drive. A started car is indicated by the driver display's indicator lamps extinguishing and its preset theme illuminating.

However there are situations where the petrol engine is started instead e.g. in the event of the temperature being too low or if the hybrid battery needs charging.

Error messages

If the **Car key not found** message is shown in the driver display when starting, place the remote control key by the backup reader. Then try to start the car again.

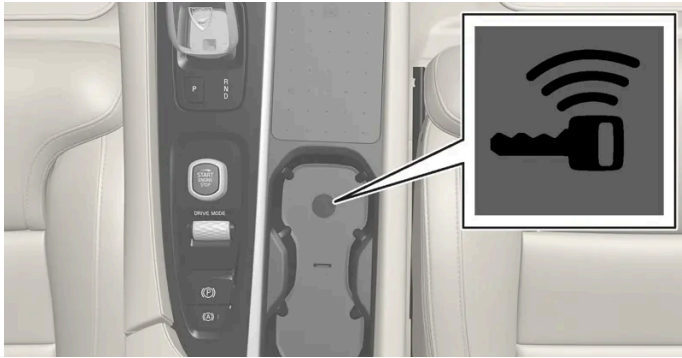

Backup reader's location in the tunnel console.

i Note

When the remote control key is positioned by the backup reader, make sure that there are no car keys, metal objects or electronic apparatus by the backup reader, (e.g. mobile phones, tablets, laptops or chargers). Several car keys close to one another by the backup reader may cause interference with each other.

If the message **Car start System check, wait** is shown in the driver display when starting, wait until the message disappears and then try to start the car again.

! Important

If the engine fails to start after 3 attempts - wait for 3 minutes before making a further attempt. Starting capacity increases if the battery is allowed to recover.

i Note

The car cannot be started if the hybrid battery is discharged.

! Warning

Never remove the remote control key from the car while driving.

! Warning

Always take the remote control key out from the car when leaving the car and make sure the car's electrical system is in ignition position **0** - especially if there are children in the car.

Note

The idling speed can be noticeably higher than normal for certain engine types during cold starting. This is done in order that the emissions system can reach normal operating temperature as quickly as possible, which minimises exhaust emissions and protects the environment.

* Option/accessory.

[1] If the car is moving, the engine can be started by turning the start knob clockwise.

12.1.3. Using jump starting with another battery

If the starter battery is discharged then the car can be started with current from another battery.

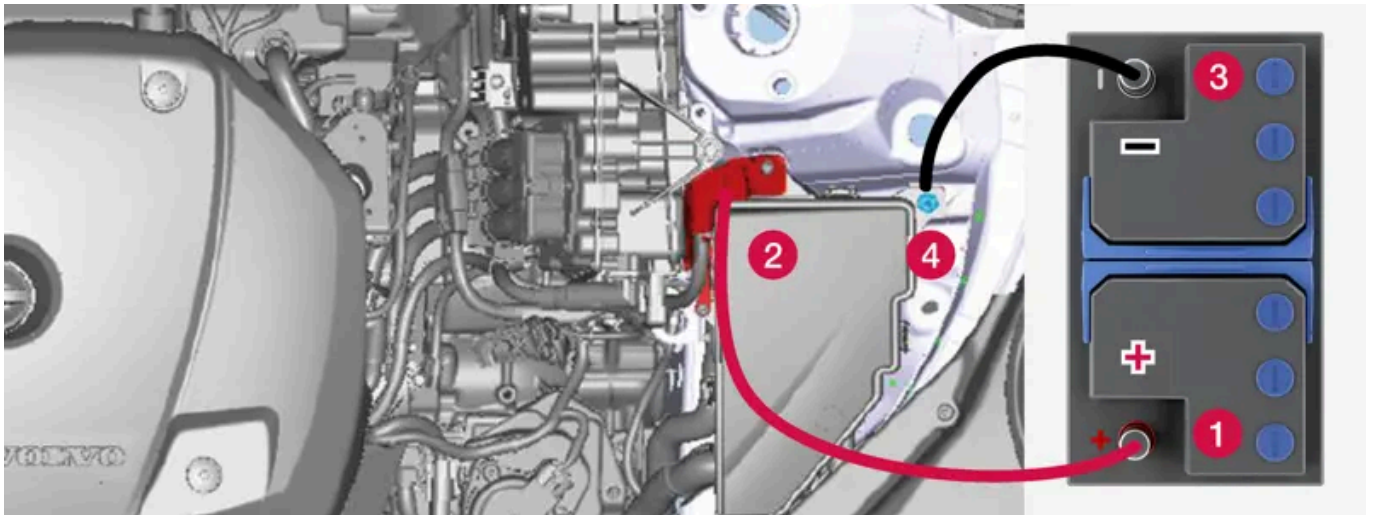

Charging point for jump-starting own car.

Important

The car's charging point is only intended for jump-starting the car itself. The charging point is not intended for jump-starting another car. Using the charging point to jump start another car may cause a fuse to blow, which means the charging point will stop working.

If a fuse has blown, the message **12 V Battery Fuse failure Service required** is shown in the driver display. Volvo recommends that an authorised Volvo workshop is contacted.

When jump-starting the car, the following steps are recommended to avoid short circuits or other damage:

- 1 Set the car's electrical system in ignition position 0.
- 2 Check that the donor battery has a voltage of 12 V.

- 3 If the donor battery is installed in another car - switch off the donor car's engine and make sure that the two cars do not touch each other.
- 4 Connect one of the red jump lead's clamps to the donor battery's positive terminal (1).

 **Important**

Connect the start cable carefully to avoid short circuits with other components in the engine compartment.

- 5 Open the positive jump-starting point's cover (2).
- 6 Connect the red jump lead's other clamp onto the car's positive jump-starting point (2).
- 7 Connect one of the black jump lead's clamps to the donor battery's negative terminal (3).
- 8 Connect the black jump lead's other clamp onto the car's negative jump-starting point (4).
- 9 Check that the jump lead clamps are affixed securely so that there are no sparks during the starting attempt.
- 10 Start the engine of the "donor car" and allow it to run a few minutes at a speed slightly higher than idle approx. 1500 rpm.
- 11 Start your own car's engine. If the start attempt fails then extend the charging time to 10 minutes, and then make a new start attempt.

 **Note**

When starting the engine in normal conditions the car's electric drive motor is prioritised - the petrol engine remains switched off. This means that after the start knob has been turned clockwise, the electric motor has "started" and the car is ready to move. A started motor is indicated by the driver display's indicator lamps extinguishing and its preset theme illuminating.

 **Important**

Do not touch the connections between cable and car during the starting attempt. There is a risk of sparks forming.

- 12 Remove the jump leads in reverse order - first the black and then the red.
Make sure that none of the black jump lead's clamps comes into contact with the car's positive jump-starting point/donor battery's positive terminal or the clamp connected to the red jump lead.

 **Warning**

- The battery can generate oxyhydrogen gas, which is highly explosive. A spark can be formed if a jump lead is connected incorrectly, and this can be enough for the battery to explode.
- Do not connect the jump leads to any fuel system component or any moving part. Be careful of hot engine parts.
- The battery contains sulphuric acid, which can cause serious burns.
- If sulphuric acid comes into contact with eyes, skin or clothing, flush with large quantities of water. If acid splashes into the eyes - seek medical attention immediately.
- Never smoke near the battery.

 **Note**

The car cannot be started if the hybrid battery is discharged.

12.1.4. Switching off the car

The car is switched off using the start knob in the tunnel console.



Start knob in the tunnel console.

To switch off the car:

- 1 Turn the start knob clockwise and release it - the car is switched off. The control automatically returns to its starting position.

If the gear selector for cars with an automatic gearbox is not in position P or if the car rolls:

- 1 Turn the knob clockwise and hold it until the car is switched off.

12.1.5. Ignition positions

The car's electrical system can be set in different levels/positions and in this way make the different functions available.

In order to facilitate the use of a limited number of functions with the engine switched off, the car's electrical system can be set in three different levels – **0**, **I** and **II**. These levels are described with the denomination "ignition position" throughout the owner's manual.

The following table shows the functions available in each ignition position/level:

Level	Functions
0	<ul style="list-style-type: none"> Odometer, clock and temperature gauge are illuminated^[1]. Power* seats can be adjusted. The centre display is started and can be used^[1]. The infotainment system can be used^[1]. <p>In this mode, the functions are controlled by time and are switched off automatically after a short while.</p>
I	<ul style="list-style-type: none"> Panoramic roof, power windows, 12V power socket in the passenger compartment, Bluetooth, navigation, phone, ventilation fan and windscreen wipers can be used. Power seats can be adjusted. 12 V power sockets* in the cargo area can be used. <p>Power is taken from the battery in this ignition position.</p>
II	<ul style="list-style-type: none"> The headlamps come on. Warning/indicator lamps illuminate for 5 seconds. Several other systems are activated. However, heating in seat cushions and the rear window can only be activated after the car has been started. <p>This ignition position consumes a lot of current from the battery and should therefore be avoided!</p>

^[1] Also activated when the door is opened.

* Option/accessory.

12.1.6. Selecting ignition mode

The car's electrical system can be set in different levels/positions and in this way make the different functions available.

Selecting ignition position



Start knob in the tunnel console.

- **Ignition position 0** – Unlock the car and store the remote control key inside the car.

 **Note**

To reach level I or II **without** starting the engine - do **not** depress the brake pedal, or the clutch pedal for cars with manual gear changing, when these ignition positions are to be selected.

- **Ignition position I** – Turn the start knob clockwise and release it. The control automatically returns to its starting position.
- **Ignition position II** – Turn the start knob clockwise and hold it in position for approx. 5 seconds. Then release the knob, which automatically returns to its starting position.
- **Back to ignition position 0** – To return to ignition position 0 from position I and II – Turn the start knob clockwise and release. The control automatically returns to its starting position.

12.2. Alcohol lock

12.2.1. Alcohol lock*

The function of the alcohol lock is to prevent the car from being driven by individuals under the influence of alcohol. Before starting is possible, the driver must take a breath test that verifies that he/she is not under the influence of alcohol. Alcohol lock calibration takes place in accordance with each market's limit value in force for driving legally.

The car has an interface for the electrical connection of the different makes and models of alcohol lock recommended by Volvo. The interface facilitates alcohol lock connection, and gives the option of an integrated function including messages related to the alcohol lock in the car's main display. For information about a specific alcohol lock, please refer to the owner's manual from the respective alcohol lock manufacturer.

 **Warning**

The alcohol lock is an aid and does not exempt the driver from responsibility. It is always the responsibility of the driver to be sober and to drive the car safely.

* Option/accessory.

12.2.2. Bypass of the alcohol lock*

In the event of an emergency situation or if the alcohol lock is out of order, it is possible to bypass the alcohol lock in order to drive the car.

For deactivation via the alcohol lock, see supplier's manual.

* Option/accessory.

12.2.3. Before starting with the alcohol lock*

The alcohol lock is activated automatically and is then ready for use when the car is opened.

To bear in mind

In order to obtain correct function and as accurate a measurement result as possible:

- Avoid eating or drinking approx. 5 minutes before the breath test.
- Avoid excess windscreen washing - the alcohol in the washer fluid may result in an incorrect measurement result.



Note

After a completed period of driving, the car can be restarted within 30 minutes without a new breath test.

* Option/accessory.

12.3. Gearbox

12.3.1. Kick-down function

Kick-down can be used when maximum acceleration is needed such as for overtaking.

When the accelerator pedal is pressed all the way to the floor (beyond the position normally regarded as full acceleration) a lower gear is immediately engaged. This is known as kick-down.

If the accelerator is released from the kick-down position, the gearbox automatically changes up.

Safety function

To prevent over-revving of the engine, the gearbox control program has a protective downshift inhibitor.

The gearbox does not permit downshifting/kick-down which would result in an engine speed high enough to damage the engine. Nothing happens if the driver still tries to shift down in this way at high engine speed – the original gear remains engaged.

On kick-down the car can shift down one or more steps at a time, depending in engine speed. The car shifts up when the engine has reached its maximum engine speed in order to prevent engine damage.

12.3.2. Launch function*

Launch can be used when maximum acceleration is required from stationary. The function is available in the following drive modes: **Hybrid**, **Constant AWD**, **Power** and **Individual**.

Activate Launch

Make sure the car is stationary and the wheels are pointing straight forward.

- 1 Move to gear position D.
- 2 Depress the brake pedal fully.
- 3 Then fully depress the accelerator pedal.
- 4 Release the brake pedal within 2 seconds.

Note

If the Launch function does not work, wait a few minutes and let the drivetrain cool down to working temperature before retrying.

Important

The drivetrain is subject to wear and tear when using Launch and therefore the function is only available a limited number of times.

* Option/accessory.

12.3.3. Gearbox

The gearbox is part of the car's powertrain (power transmission) between engine and drive wheels. The function of the gearbox is to change the gear ratio depending on speed and power requirements.

The car has an eight-speed automatic gearbox, and an electric motor for rear-wheel drive. The number of gear changes means that the engine's torque and power range can be used effectively.

Two of the gears are overdrive gears that save fuel when driving at constant engine speed. The driver display shows the selected gear position.

12.3.4. Automatic gearbox

Gears are selected automatically so that you can drive as energy-efficiently as possible. The gearbox also has a manual gearshift mode.



Overview of gear lever and shift pattern in the driver display.

The driver display shows the selected gear position:

P, R, N, D or B.

12.3.5. Changing gear with automatic gearbox

Change gear position by pressing the spring-loaded gear selector forwards or backwards, or sideways for manual shifting.

Changing gear

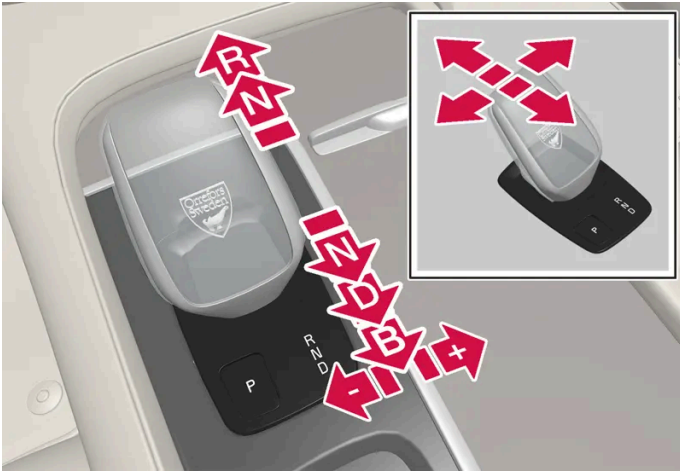

Overview of gear lever and gear positions.

Gear positions

Parking – P



Overview of gear lever and position P.

Parking is activated with the P button located next to the gear selector.

The gearbox is mechanically blocked when the P position is engaged.

Select position P for parking. The car can start in position P. The car must be stationary when the P position is selected.

To park - first apply the parking brake and then select P position.

Warning

Always use the parking brake when parking on an inclined surface. Engaging a gear or the automatic transmission's P position is not sufficient to hold the car stationary in all situations.

Note

To be able to lock the car and arm the alarm, the gear position must be in **P**.

Help functions

The system will change to the **P** position automatically:

- if the car is switched off in **D** or **R** position when stationary.
- if the car is moving at low speed when the driver unbuckles the seatbelt and opens the driver's door without a pedal depressed.

To park a car without wearing the seatbelt and with the door open - exit the **P** position by selecting **R** or **D** again.

If the car is switched off in **N** position there is no automatic change-over to **P** position. This makes it possible to wash the car in an automatic car wash.

Reverse – R

Select position **R** to reverse. The car must be stationary when the **R** position is selected.

Neutral – N

The car freewheels in position **N**. The car can start in position **N**. Apply the parking brake if the car is stationary with the gear selector in the **N** position.

In order to change from **N** position to another gear position, the brake pedal must be depressed and the ignition position must be **II**.

Drive position - D

D is the normal driving position. Shifting up and down takes place automatically based on the level of acceleration and speed.

The car must be stationary when changing gear from **R** position to **D** position.

Brake – B^[1]



Overview of brake positions in the driver display.

In B position, it is possible to change gear manually. The car brakes using its electric motor when the accelerator pedal is released, while also charging the hybrid battery.

Position B is selected by moving the gear selector backwards from the D position.

- Press the gear selector to the right to "+" (plus) to change up one step and release it.
- Press the gear selector to the left to "-" (minus) to change down one step and release it.
- Press the gear selector backwards to return to the D position.

The gearbox automatically shifts down if the speed decreases to a level lower than appropriate for the selected gear, in order to avoid jerking and stalling.



^[1] Brake position B is not available in Pure Drive mode.

12.3.6. Symbols and messages for automatic gearbox

If a fault should occur in the gearbox, a symbol and a message are shown in the driver display.

 **Important**

To prevent damage to any drive system components, the working temperature of the gearbox is checked. If there is a risk of overheating, a warning symbol illuminates in the driver display and a text message is shown - follow the recommendation given.

Symbol	Specification
	An error has occurred in the transmission. Read the message in the driver display.
	Hot or overheated gearbox. Read the message in the driver display.
	Temporary fault on drivetrain. Read the message in the driver display.

12.3.7. All-wheel drive

All-wheel drive (AWD ^[1]) means that the car is driving all four wheels at the same time, which improves traction.

The electric motor that drives the rear wheels enables electric all-wheel drive functionality. All-wheel drive characteristics vary depending on the selected drive mode.

12.3.8. Gear selector inhibitor

The gear selector inhibitor prevents accidental changing between different gear positions in an automatic gearbox.

Automatic gear selector inhibitor

The automatic gear selector inhibitor has special safety systems.

From park position – P or neutral position – N

In order to move the gear selector from P or N position to another gear position, the brake pedal must be depressed and the ignition position must be II. For some gearbox variants, the engine must be running.

If the gear selector is in the N position and the car has been stationary for at least 3 seconds (irrespective of whether the engine is running) then the gear selector is locked.

Message in the driver display

If the gear selector is inhibited a message is shown in the driver display e.g. **Gear lever Press brake pedal to activate gear lever.**

The gear selector is not inhibited mechanically.

12.3.9. Gear shift indicator

The gear shift indicator in the driver display shows the current gear during manual gearshifting and when it is appropriate to engage the next gear for optimum fuel economy.

For eco-driving during manual gear changing, it is important to drive in the right gear and to change gear in good time.

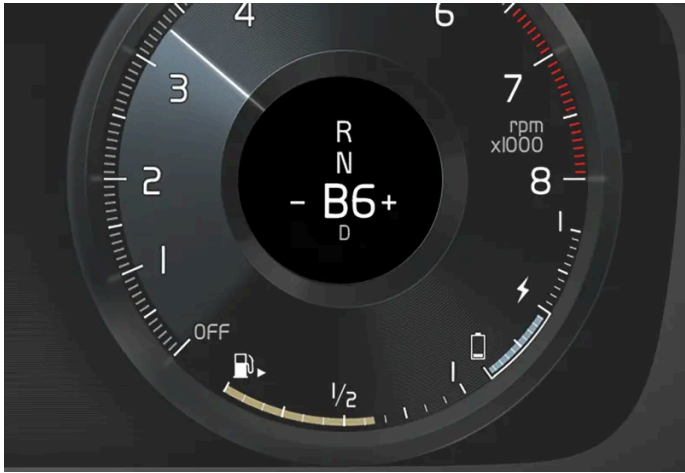

Gear shift indicator in the driver display^[1].

The gear shift indicator is shown in gear position B. The gear shift indicator shows the current gear in the driver display and indicates recommended shifting to a higher gear by a flashing plus sign.

^[1] The figure is schematic – parts may vary depending on car model.

12.4. Brakes

12.4.1. Foot brake

12.4.1.1. Brake assistance

The brake assist system (BAS^[1]) helps to increase brake force during braking, and can thereby shorten the braking distance.

The system detects the way in which the driver brakes and increases brake force where necessary. The brake force can be boosted up to the level when the ABS system is engaged.

^[1] Brake Assist System

12.4.1.2. Braking on gritted roads

When driving on salted roads, a layer of salt may form on the brake discs and brake linings.

This may extend braking distance. You should therefore maintain a greater safety distance to vehicles in front. In addition, make sure you do the following:

- Brake now and again to remove any layer of salt. Make sure that other road users are not put at risk by the braking.
 - Gently depress the brake pedal after finishing driving and before starting your next trip.
-

12.4.1.3. Braking on wet roads

When driving for a prolonged period of time in heavy rain without braking, the braking effect may be delayed slightly when next using the brakes.

This may also be the case after a car wash. It is then necessary to depress the brake pedal more forcefully. You should therefore maintain a greater distance to the vehicles in front.

Brake the car firmly after driving on wet roads or using a car wash. This warms up the brake discs, enabling them to dry faster and protecting them against corrosion. Bear in mind the current traffic situation when braking.

12.4.1.4. Foot brake

The foot brake is part of the brake system.

The car is equipped with two brake circuits. If a brake circuit is damaged, the brake pedal may engage deeper. Higher pressure on the pedal will therefore be needed to produce the normal braking effect.

If the foot brake is used when the car is switched off, the brake pedal needs to be depressed passed the normal braking position using a higher pressure to brake the car.

In very hilly terrain or when driving with a heavy load the brakes can be relieved by using engine braking in gearshift mode B.

Use drive mode Off Road for increased engine braking while driving on steep downhill gradients at low speeds.

Anti-lock braking system

The car has anti-lock brakes (ABS^[1]), which prevents the wheels from locking while braking and allows maintained steering control. Vibration may be felt in the brake pedal when this is engaged and this is normal.

A short test of the ABS system is made automatically after the car has been started when the driver releases the brake pedal. A further automatic test of the system may be made at low speed. The test may be felt as pulses in the brake pedal.

Light braking charges the hybrid battery





The electric motor's engine brake is used during light braking. The car's kinetic energy is then converted to electrical energy instead, which is used to charge the hybrid battery. Battery charging with electric motor braking is indicated in the driver display.



The driver display indicates charging during electric motor braking.

This function is active in the speed interval 150-5 km/h (93-3 mph). During heavier braking, as well as outside the speed interval, braking is supplemented by the hydraulic brake system. The driver's display shows this by the indicator being down in the red zone.

Symbols in the driver display

Symbol	Specification
	Check the brake fluid level. If the level is low, fill with brake fluid and check for the cause of the brake fluid loss.
	Fault in pedal sensor.
	Constant glow for 2 seconds when the engine is started: Automatic function check. Constant glow for more than 2 seconds: Fault in the ABS system. The car's normal brake system is still working, but without the ABS function.
	In the event of the message: Brake pedal Characteristics changed Service required The brake pedal needs to be depressed past the normal braking position using a higher pressure to brake the car.

Warning

If both the warning lamps for brake fault and ABS fault illuminate at the same time, a fault has occurred in the brake system.

- If the level in the brake fluid reservoir is normal at this stage, drive carefully to the nearest workshop and have the brake system checked - an authorised Volvo workshop is recommended.
- If the brake fluid is below the MIN level in the brake fluid reservoir, do not drive further before topping up the brake fluid. The reason for the loss of brake fluid must be investigated.

^[1] Anti-lock Braking System

12.4.1.5. Brake system maintenance

Check brake system components regularly for wear.

To keep the car as safe and reliable as possible, follow the Volvo service intervals as specified in the Service and Warranty Booklet. After replacing brake linings and brake discs, braking effect is only adapted after they have been "worn in" for a few hundred kilometres (miles). Compensate for the reduced braking effect by depressing the brake pedal harder. Volvo recommends only fitting brake linings that are approved for your Volvo.

Important

The wear on the brake system's components must be checked regularly.

Contact a workshop for information about the procedure or engage a workshop to carry out the inspection - an authorised Volvo workshop is recommended.

12.4.2. Parking brake

12.4.2.1. Parking brake

The parking brake prevents the car from rolling away from stationary by means of mechanically locking/blocking two wheels.



The control for the parking brake is located in the tunnel console between the seats.

A faint electric motor noise can be heard when the electrically-operated parking brake is being applied. The noise can also be heard during the automatic function checking of the parking brake.

If the car is stationary when the parking brake is activated, it only acts on the rear wheels. If it is activated when the car is moving then the normal foot brake is used, i.e. the brake acts on all four wheels. Brake function changes over to the rear wheels when the car is almost stationary.

12.4.2.2. Activating and deactivating the parking brake

Use the parking brake to prevent the car from rolling from stationary.

Activating the parking brake



- 1 Pull the control upward.
 - The symbol in the driver display illuminates when the parking brake is activated.
- 2 Check that the car is stationary.

Symbol in the driver display

Symbol	Specification
	The symbol is illuminated when the parking brake is activated. If the symbol flashes, it indicates a fault has occurred. Read the message in the driver display.

Automatic activation

The parking brake is activated automatically

- when the car is switched off and the setting for automatic activation of the parking brake is activated in the centre display.
- when gear position P is selected on a steep hill.
- if the Auto hold (Automatic brake when stationary) function is activated and
 - the car has been stationary for a long time (5-10 minutes)
 - the car is switched off
 - the driver leaves the car.

Emergency brake

The content of this manual represents the status of the user manual at the time of printing and may not be completely valid in future instances. For more information, refer to the first page for the complete disclaimer note.

In an emergency, the parking brake can be activated when the car is in motion by pulling and holding up the control. Braking stops when the control is released, or if the accelerator pedal is depressed.

i Note

An acoustic signal sounds while emergency braking is active at high speeds.

Deactivating the parking brake



Deactivate manually

To deactivate the parking brake, the engine needs to be running.

- 1 Depress the brake pedal firmly.
 - 2 Press the control down.
- The parking brake releases and the symbol in the driver display extinguishes.

Deactivate automatically

- 1 Start the car.
 - 2 Depress the brake pedal firmly. Select gear position D or R and depress the accelerator pedal.
- The parking brake releases and the symbol in the driver display extinguishes.

i Note

For automatic deactivation, either the driver has to have put on their seatbelt or the driver door has to be closed.

12.4.2.3. Parking on a hill

Always make sure that the parking brake has been activated when parking on a hill.

 **Warning**

Always use the parking brake when parking on an inclined surface. Engaging a gear or the automatic transmission's P position is not sufficient to hold the car stationary in all situations.

If the car is parked facing uphill:

- Turn the wheels **away from** the kerb.

If the car is parked facing downhill:

- Turn the wheels **towards** the kerb.

Heavy load uphill

A heavy load, such as a trailer, can cause the car to roll backward when the parking brake is released automatically on a steep incline. Avoid this by pulling the control upwards while driving the car away. Release the control when the engine achieves traction.

12.4.2.4. Automatic parking brake activation setting

Choose whether the parking brake is to be activated automatically when the car is switched off.

To change setting:

- 1 Tap on **Settings** in the centre display's top view.
- 2 Press **My Car** → **Parking Brake and Suspension** to select or deselect the function **Auto Activate Parking Brake**.

12.4.2.5. In the event of a fault in the parking brake

Contact an authorised Volvo workshop if it is not possible to deactivate or activate the parking brake after several attempts.

An acoustic warning signal sounds when driving with the parking brake activated.

If the car must be parked before a possible fault is rectified, then the wheels must be turned as for parking on a hill and the gear selector must be in position P.



Low battery voltage

If the battery voltage is too low then the parking brake can be neither deactivated nor activated. Connect a donor battery if the battery voltage is too low.

Replacing the brake linings

The rear brake linings must be replaced at a workshop due to the design of the electrically-operated parking brake - an authorised Volvo workshop is recommended.

Symbols in the driver display

Symbol	Specification
	If the symbol flashes, it indicates a fault has occurred. See the message in the driver display.
	Fault in brake system. See the message in the driver display.
	Information message in driver display.

12.4.3. Brake fluid – specifications

Brake fluid is the medium in a hydraulic brake system that is used to transfer pressure from e.g. a brake pedal via a master brake cylinder, which in turn acts on the brake callipers.

Prescribed grade: Volvo Original or equivalent fluid compliant with a combination of Dot 4, 5.1 and ISO 4925 class 6.

Note

It is recommended that brake fluid is changed or filled by an authorised Volvo workshop.

12.4.4. Brake functions

The car's brakes are used to reduce the speed or prevent the car from rolling.

Besides the foot brake and parking brake, the car is equipped with several automatic brake assist functions. These can assist the driver by not needing to keep his/her foot on the brake pedal when at a traffic light, or when starting on an uphill gradient.

Depending on the car's equipment, the following auto braking functions are available:

The content of this manual represents the status of the user manual at the time of printing and may not be completely valid in future instances. For more information, refer to the first page for the complete disclaimer note.

- Automatic brake when stationary (Auto Hold)
- Hill start assist (Hill Start Assist)
- Auto braking after a collision
- City Safety
- Hill descent control (Hill Descent Control)

12.4.5. Automatic braking when stationary

Automatic brake when stationary (Auto hold) means that the driver can release the brake pedal while maintaining braking effect when the car has stopped at traffic lights or a junction.

When the car has stopped, the brakes are activated automatically. The function can use either foot brake or parking brake to hold the car stationary and it works on all gradients. When driving off, the brakes are released automatically if the driver is wearing the seatbelt and/or the driver's door is closed.

Note



When braking to a standstill on an uphill or downhill slope, the brake pedal should be depressed a little harder before being released to ensure the car does not roll.

The parking brake is activated if

- the car is switched off
- the driver's door is opened
- the driver's seatbelt is unbuckled
- the car has been stationary for a longer time (5-10 minutes).

Auto hold can also change over to the parking brake in other situations.

Symbols in the driver display

Symbol	Specification
	The symbol is illuminated when the function uses the foot brake to keep the car stationary.
	The symbol is illuminated when the function uses the parking brake to keep the car stationary.

12.4.6. Activating and deactivating the automatic brake at a standstill

The content of this manual represents the status of the user manual at the time of printing and may not be completely valid in future instances. For more information, refer to the first page for the complete disclaimer note.

The automatic brake function at a standstill is activated using the button in the tunnel console.



- 1 Press the button in the tunnel console to activate or deactivate the function.
 - The indicator in the button illuminates when the function is activated. Activated function remains even when the car is started next time.

Applicable when switching off



If the function is active and holds the car with the foot brake (A-symbol illuminated in the driver display), the brake pedal must be depressed at the same time as the button is depressed in order to deactivate.

- The function remains deactivated until it is reactivated.
- When the function is deactivated, hill start assist (HSA) remains active to prevent the car from rolling backwards when starting on an uphill gradient.

12.4.7. Auto braking after a collision

In the event of a collision in which the activation level is reached for the pyrotechnic seatbelt tensioners or airbags, or if a collision with a large animal is detected, the car's brakes are automatically applied. This function is to prevent or reduce the effects of any subsequent collision.

After a serious collision there is a risk that it is no longer possible to control and steer the car. In order to avoid or mitigate a possible further collision with a vehicle or an object in the vehicle's path, the auto braking system is activated automatically and brakes the car in a safe manner.

Brake lights and hazard warning lights are activated during braking. When the car has stopped, the hazard warning lights continue to flash and the parking brake is applied.

If braking is not appropriate, e.g. if there is a risk of being hit by following traffic, the system can be overridden by the driver depressing the accelerator pedal.

The function assumes that the brake system is intact after the collision.

12.4.8. Help when starting on a hill

Hill start assist (HSA^[1]) prevents the car from rolling backwards when starting on an uphill gradient. When reversing uphill, it prevents the car from rolling forwards.

The function means that the pedal pressure in the brake system remains for several seconds while the driver's foot is moved from brake pedal to accelerator pedal.

The temporary braking effect releases after several seconds or when the driver starts to drive away.

The Hill Start Assist is activated when stopping on a steep slope. The function is available even when the automatic braking when stationary (Auto hold) function is deactivated.

^[1] Hill Start Assist

12.4.9. Regenerative braking*

The car recovers kinetic energy during braking in order to reduce fuel consumption and emissions.



The battery symbol is shown in the driver display when the car is generating power for the battery.

The function is available in all drive modes together with gear position D or B.

Activating brake regeneration

Brake regeneration is activated by gentle pressure on the brake pedal or during engine braking.

Regeneration increases during engine braking when manual gearshift mode B is selected.

* Option/accessory.

12.4.10. Low speed control

The low speed control function (LSC^[1]) facilitates and improves traction for driving off-road and on slippery surfaces, such as with a caravan on grass or a boat trailer on a launch ramp.

The function is included in drive mode **Off Road**.

The function is adapted for off-road driving and driving with a trailer at low speed, up to approx. 40 km/h (25 mph).

Low speed control prioritises low gears and traction. If the car is all-wheel drive, the motive force is distributed evenly in order to provide as good traction as possible on all wheels and to reduce the risk of wheel spin. The accelerator pedal is less responsive in order to facilitate traction and speed control at low speed.

The function is activated together with hill descent control, (HDC^[2]) which means that speed down steep hills can be controlled with the accelerator pedal, reducing the need to use the brake pedal. The system facilitates a low and even speed while driving on steep downhill gradients.

 **Note**

When LSC with HDC is activated by the **Off Road** driving mode, the feel of the accelerator pedal and engine response are changed.

 **Note**

The driving mode is not designed to be used on public roads.

 **Note**

The function is deactivated when driving at higher speeds and must be reactivated at a lower speed, if required.

^[1] Low Speed Control

^[2] Hill Descent Control

12.4.11. Hill descent control

Hill descent control (HDC^[1]) is a low speed function with enhanced engine braking. The function makes it possible to increase or reduce the car's speed on steep downhill gradients using only the accelerator pedal, without using the foot brake.

The function is included in drive mode **Off Road**.

Hill descent control is adapted for off-road driving at low speeds and facilitates driving on steep downhill gradients with difficult surfaces. The driver does not need to use the brake pedal, but can instead focus on steering.

 **Warning**

HDC does not work in all situations but is designed merely as a supplementary aid.

The driver always bears ultimate responsibility for ensuring that the vehicle is driven safely.

Function

Hill descent control allows the car to roll at inching speed both forward and backward, assisted by the brake system. The speed can be increased by using the accelerator pedal. When the accelerator pedal is then released the car slows back down to crawling speed, regardless of the gradient of the hill and without the need for the foot brake to be used. The brake lights are switched on when the function is operating.

The driver can brake and reduce crawling speed, or stop the car at any time by using the foot brake.

The function is activated together with low speed control (LSC^[2]) which facilitates driving and improves traction^[2] for driving off-road and on slippery surfaces. The systems are designed for use at low speed, up to approx. 40 km/h (25 mph).

Points to remember when driving with HDC

- If the function is disabled while driving on a steep downhill gradient, the braking effect will gradually decrease.
- HDC can be used in gear position D, R, and with 1st or 2nd gear with manual gear changing.
- It is not possible to change to 3rd gear or higher with manual gear changing.

 **Note**

When LSC with HDC is activated by the **Off Road** driving mode, the feel of the accelerator pedal and engine response are changed.

 **Note**

The driving mode is not designed to be used on public roads.

 **Note**

The function is deactivated when driving at higher speeds and must be reactivated at a lower speed, if required.

^[1] Hill Descent Control

^[2] Low Speed Control

12.5. Drive system

12.5.1. Drive systems

The car combines an internal combustion engine that drives the front wheels with an electric motor that drives the rear wheels.

Two drive systems

Depending on the driver-selected drive mode and available electric energy, the two drive systems can be used either individually or in parallel.

The electric motor is supplied its energy from a hybrid battery fitted in the tunnel console. The hybrid battery can be charged in a wall socket, or in a special charging station. The internal combustion engine can also charge the hybrid battery with a special high-voltage generator.

Both the internal combustion engine and electric motor can generate motive force directly to the wheels. An advanced control system combines the properties of both drive systems in order to provide optimum driving economy.



- 1 Hybrid battery - The function of the hybrid battery is to store energy. It receives energy when charging from the mains power circuit, during regenerative braking or from the high-voltage generator. It provides energy for electric operation as well as for temporarily operating the electric air conditioning during the preconditioning of the passenger compartment.
- 2 Internal combustion engine - The internal combustion engine starts when the energy level in the hybrid battery is insufficient for the engine power that the driver requests.
- 3 High voltage generator^[1] - Charges the hybrid battery. Starter motor for the internal combustion engine. Can support the internal combustion engine with extra electrical energy.
- 4 Electric motor - Powers the car in electric operation. If necessary, provides extra torque and power during acceleration. Provides electrical all-wheel drive functionality. Recycles brake energy to electrical energy.

^[1] CISG (Crank Integrated Starter Generator) - Combined high-voltage generator and starter motor.

12.6. Drive modes

12.6.1. Regenerative braking *

The car recovers kinetic energy during braking in order to reduce fuel consumption and emissions.



The battery symbol is shown in the driver display when the car is generating power for the battery.

The function is available in all drive modes together with gear position D or B.

Activating brake regeneration

Brake regeneration is activated by gentle pressure on the brake pedal or during engine braking.

Regeneration increases during engine braking when manual gearshift mode B is selected.

* Option/accessory.

12.6.2. Hold and Charge

In some situations, it can be useful to be able to control the hybrid battery's state of charge while driving is in progress. This is possible with the functions **Hold** and **Charge**.

Hold and **Charge** are available in all drive modes. The functions are cancelled if **Pure** drive mode is activated.

Activating Hold and Charge

The functions are activated in the centre display's function view.

Hold



Battery level sustained for later use.

The function maintains the charge in the hybrid battery for electric drive and saves available electricity for later use e.g. for driving in an urban environment.

The car works as for normal hybrid operation with discharged battery where, in addition to re-using brake-generated energy, for example, the car starts the internal combustion engine more often in order to maintain the charge in the battery.

Charge



Engine charges hybrid battery.

The function charges the hybrid battery with assistance from the internal combustion engine for using increased electric operation at a later time.

Symbols in the driver display



The symbol  is shown in the hybrid battery gauge when Hold is activated.

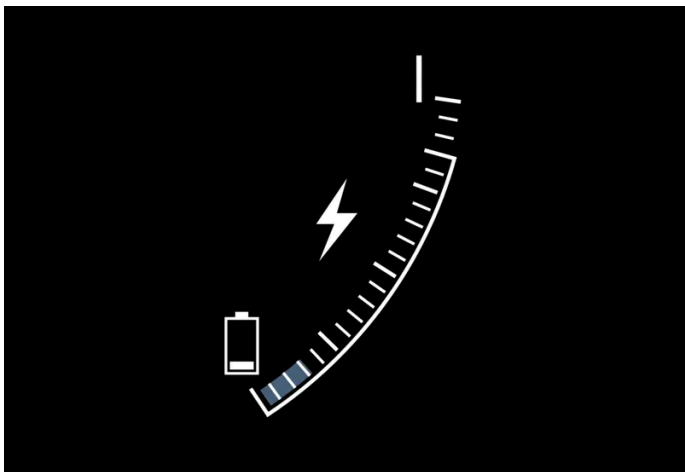

The symbol  is shown in the hybrid battery gauge when Charge is activated.

12.6.3. Drive modes

Selection of drive mode affects the car's driving characteristics in order to enhance the driving experience and facilitate driving in special situations.

Using the drive modes it is possible to quickly have access to the car's numerous functions and settings for different driving needs. Each drive mode is adapted to provide optimum driving characteristics:

- Steering
- Engine/gearbox/all-wheel drive

- Brakes
- Level control* and shock absorption
- Driver display
- Climate settings

Select the drive mode adapted for the current driving conditions. Remember that not all drive modes are available in all situations.

Selectable drive modes

Warning

Remember that the car does not emit any engine noise when it is only powered by the electric motor and may therefore be difficult to notice by children, pedestrians, cyclists and animals. This applies in particular at low speeds such as in car parks.

Warning

Do not leave the car in an unventilated area with activated drive mode and the fuel-driven engine switched off - automatic engine start occurs at low energy level in the hybrid battery, and the exhaust gases could then cause serious injury to people and animals.

Hybrid

- This is the car's normal mode where the electric motor and internal combustion engine work together.

When the car starts, it is in the **Hybrid** mode. The control system uses both the electric motor and internal combustion engine – individually or in parallel – and adapts use with regard to performance, fuel consumption and comfort. At higher speeds the ground clearance is adjusted automatically to a lower level^[1] in order to reduce wind resistance. The capacity to run solely with the electric motor depends on the hybrid battery's energy level and, for example, the need for heating or cooling in the passenger compartment.

If high power output is available, it is possible to drive with electrical power alone. When the accelerator pedal is depressed, only the electric motor is activated until a certain position is reached. The internal combustion engine starts when this position is exceeded and the energy level in the battery is insufficient for the engine power that the driver requests with the accelerator pedal.

At low energy level (hybrid battery almost empty) the battery's energy level must be maintained, leading to the internal combustion engine starting more often. Charge the hybrid battery from a 230 VAC socket with the charging cable, or activate **Charge** in the function view in order to restore the capacity to run on electricity alone.

The drive mode is designed for low energy consumption with a mix of the electric motor and the internal combustion engine, without compromising the climate comfort and driving experience. When higher acceleration is required, maximum additional power from the electric drive line is used.

The car also senses if the driving conditions require all-wheel drive and automatically engages it if necessary. All-wheel drive and electric additional power are always available regardless of the battery's state of charge.

Information in the driver display

When driving in hybrid mode the driver display shows a hybrid gauge. The pointer in the hybrid gauge indicates how much energy the driver requests with the accelerator pedal. The marking between the lightning bolt and the drop shows how much energy is available.

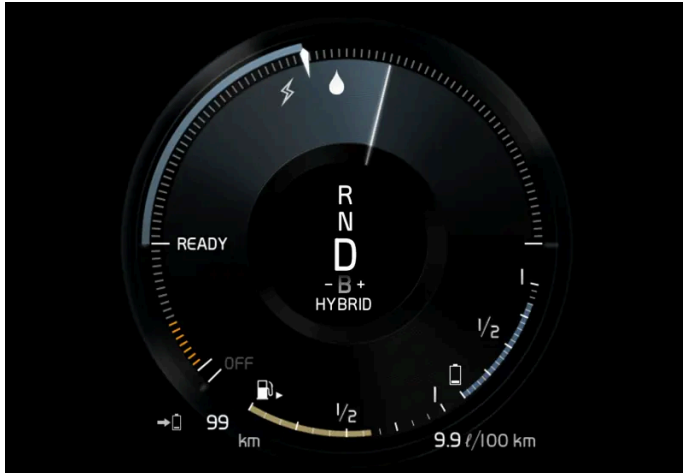

The driver display for propulsion with both the electric motor and internal combustion engine.



The driver display also shows when energy is returned to the battery (regenerated) during light braking.

Pure

- Drive the car with electric motor, with energy consumption as low as possible and with lowest possible carbon dioxide emissions.

The drive mode prioritises driving on the hybrid battery. This means, for example, that the ground clearance is lower^[1] to reduce wind resistance and the output of certain climate settings is reduced to provide the longest possible mileage range on electric power alone.

The **Pure** mode is available when the hybrid battery has a sufficiently high State of Charge (SoC) and available power output, which may be affected by temperature. When the internal combustion engine starts, the drive mode automatically changes to the **Hybrid** mode until the driver has the opportunity to select the **Pure** mode again.

The internal combustion engine starts:

- if the battery's State of Charge (SoC) is too low
- if the driver fully depresses the accelerator pedal.

The **Pure** mode is not available:

- if the battery's State of Charge (SoC) is too low
- if the speed exceeds 140 km/h(87 mph) (does not apply when driving downhill, etc.)
- in the event of system/component limitations e.g. low outside temperature.

 **Note**

The internal combustion engine may start temporarily in certain driving situations when the **Pure** drive mode is in use. This is in order to provide the wheels with the desired torque in driving situations that require higher load, e.g. when driving with a trailer or on an uphill gradient.

The drive mode is adapted for maximum range with electric propulsion and especially developed for urban traffic. **Pure** means lowest combustion even when the hybrid battery is empty. The climate in the passenger compartment is regulated to Eco climate, and in slippery driving conditions, more wheel spin can be permitted before all-wheel drive is activated automatically.

ECO climate control

In the **Pure** drive mode, eco climate control is activated automatically in the passenger compartment in order to reduce energy consumption.

 **Note**

When the **Pure** drive mode is activated, several parameters in the climate control system's settings are changed, and several electricity consumer functions are reduced. Certain settings can be reset manually, but full functionality is only regained by leaving **Pure** drive mode or adapting **Individual** drive mode with full climate functionality.

In the event of difficulties due to misting, press the button for max. defroster which has normal functionality.

Off Road

- Prioritise the car's traction when driving in difficult terrain and on poor roads.

The drive mode provides high ground clearance^[1], steering is light, all-wheel drive and the function for low speed control with hill descent control (Hill Descent Control) are activated.

The drive mode is only available at low speeds, up to 40 km/h (25 mph). If this speed is exceeded, **Off Road** mode is cancelled and the **Constant AWD** drive mode is activated instead.

To be able to drive all four wheels, the internal combustion engine and electric motor run continually, which results in increased fuel consumption.

In the **Off Road** mode the driver display has a compass between the speedometer and tachometer. The speedometer shows the range for speed limitation.

The drive mode is adapted for maximum controllability at low speeds in poor road conditions or difficult terrain. It raises the chassis^[1], reduces the driveline's throttle response and locks the car in all-wheel drive. The Hill Descent Control function facilitates controlled driving on steep descents.

 **Note**

The driving mode is not designed to be used on public roads.

 **Note**

If the car is switched off in **Off Road** mode, and therefore has high ground clearance, the car is lowered next time it is started.

 **Important**

The **Off Road** drive mode must not be used while driving with a trailer without trailer connector. Otherwise, there is a risk of damage to the air bellows.

Constant AWD

- Improve the car's roadholding and traction with enhanced all-wheel drive.

The drive mode locks the car in all-wheel drive. An adapted distribution between the front and rear axle torque provides good traction, stability and roadholding, for example on slippery roads, when driving with a heavy trailer, or when towing. **Constant AWD** drive mode is always available regardless of the battery's state of charge.

Both the internal combustion engine and electric motor are engaged in order to drive all four wheels, which results in increased fuel consumption.

In the car's other drive modes, the car automatically adapts the need for all-wheel drive to the road surface, and can engage the electric motor or start the internal combustion engine when necessary.

Power

- The car has sportier characteristics and faster response to accelerating.

The drive mode adapts the combined power from the internal combustion engine and electric motor by means of the car being driven by both front and rear wheels. The gear changes become faster and more distinct, and the gearbox prioritises a gear with greater traction. Steering response is faster, shock absorption is harder and a lower ground clearance^[1] means that the body follows the roadway in order to reduce roll during cornering.

Both the internal combustion engine and electric motor are engaged in order to drive all four wheels, which results in increased fuel consumption.

The drive mode is adapted for maximum performance and response on acceleration. It changes the internal combustion engine's accelerator pedal response, gear shift pattern and boost pressure system. Chassis settings, steering and brake response are also as good as possible. **Power** drive mode is always available regardless of the battery's state of charge.

The **Power** mode is also available in the **Polestar Engineered** version*.

Individual

- Adapting a drive mode according to individual preferences.

Select a drive mode to start from, and then adjust the settings according to the desired driving characteristics. These settings are saved in an individual driver profile.

An individual drive mode is only available if it is first activated in the centre display.

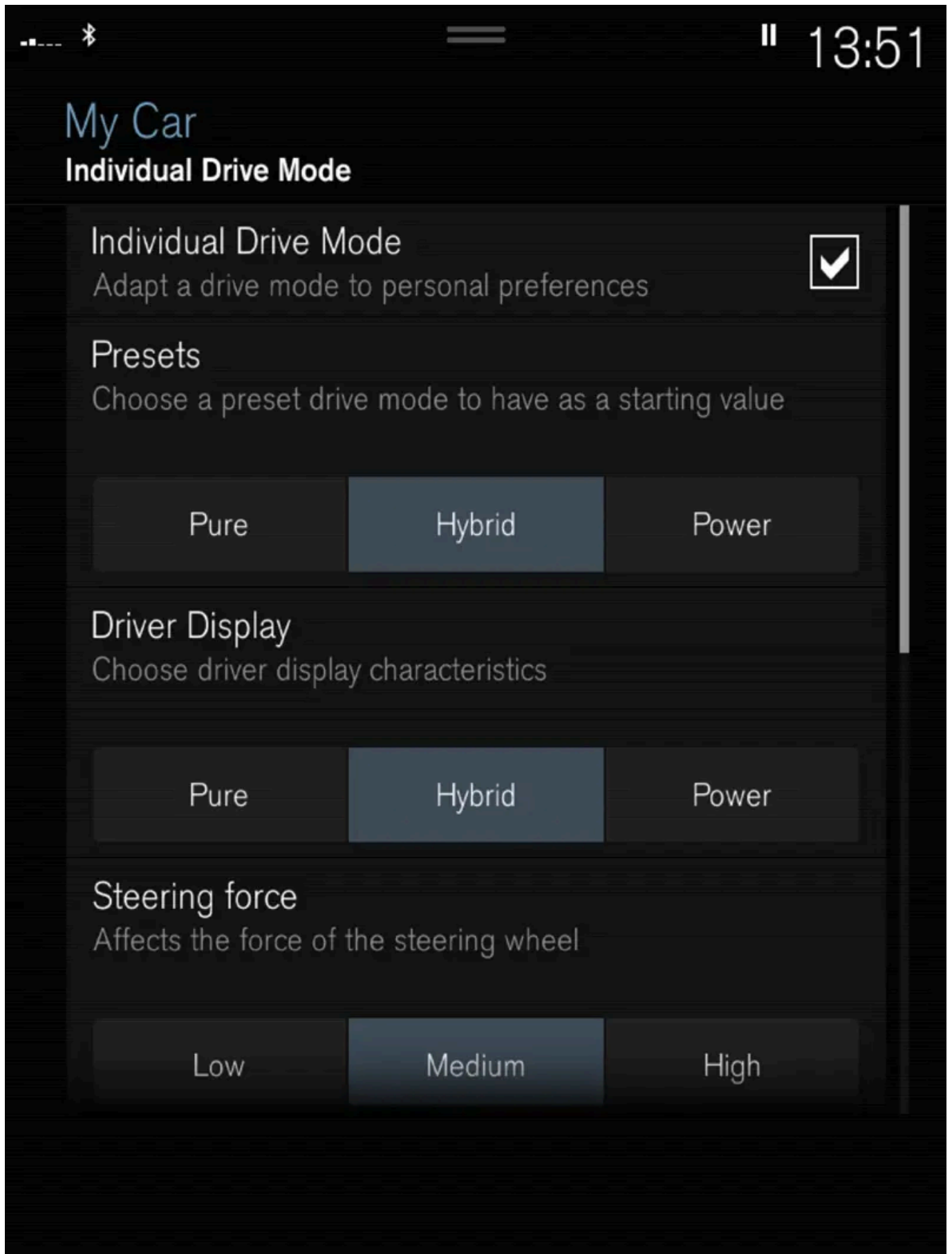

Settings view^[2] for individual drive mode.

- 1 Press **Settings** in the top view.
- 2 Press **My Car** → **Individual Drive Mode** and select **Individual Drive Mode**.
- 3 In **Presets**, select a drive mode to start from: **Pure**, **Hybrid**, **Power** or **Polestar Engineered***.

Possible adjustments apply to settings for:

- **Driver Display**
- **Steering Force**
- **Powertrain Characteristics**
- **Brake Characteristics**
- **Suspension Control**
- **ECO Climate**

Using the electric motor or internal combustion engine

An advanced control system determines the extent to which the car is driven on internal combustion engine, electric motor or both in parallel.

The primary function is to use the engine or motor and the available energy in the hybrid battery as efficiently as possible, with regard to the characteristics of the different drive modes as well as the driver's request for power via the accelerator pedal.

There are also cases where temporary limitations in the system, or functions governed by legal requirements aimed at maintaining a low level of total emissions for the car, may use the internal combustion engine to a greater extent.

* Option/accessory.

[1] Applies with air suspension.

[2] The figure is schematic - parts may vary depending on car model.

12.6.4. Changing drive mode

Select the drive mode adapted for the current driving conditions.

Change the drive mode using the control in the centre console.

Remember that not all drive modes are available in all situations.

To change drive mode:



Press the drive mode control **DRIVE MODE**.

- A pop-up menu is opened in the centre display.
- 2 Roll the wheel upward or downward until the desired drive mode is highlighted.
 - 3 Press the drive mode control or tap directly on the touch screen to confirm the selection.
- The selected drive mode is indicated in the driver display.

12.6.5. Energy distribution using map data *

In the driving position **Hybrid** the car is powered by both the electric motor and the internal combustion engine. If a destination has been selected in the navigation system*, the Predictive Efficiency^[1] function distributes the electric energy consumption along the whole driving distance using the map data.

In addition to the map data, the function also takes into account speed limits, traffic and elevation differences.

The electric motor is used primarily when driving at low speeds e.g. during city driving with more stops and starts. The combustion engine is used primarily when driving at high speeds and can, in good conditions, generate power for the electric motor.

Conditions for the function

For the function to work requires that a number of conditions are met:

- A destination is set in the navigation system and the driving distance to the destination is longer than the range possible only on electric drive.
- **Hybrid** drive mode is selected.
- The **Hold** and **Charge** functions are deactivated.

Tips for use

If the car is used for commuting to work and it is not possible to charge the car at the place of work, specify the place of work as an intermediate destination and your home as the final destination. The discharging of the hybrid battery will then take place over your runs both to and from work.

Add similar commuting routes, i.e. the route between two charging points, as **Favourites** in the navigation system to facilitate arrival.

* Option/accessory.

^[1] Certain markets only.

12.6.6. Launch function *

Launch can be used when maximum acceleration is required from stationary. The function is available in the following drive modes: **Hybrid**, **Constant AWD**, **Power** and **Individual**.

Activate Launch

Make sure the car is stationary and the wheels are pointing straight forward.

- 1 Move to gear position D.
- 2 Depress the brake pedal fully.
- 3 Then fully depress the accelerator pedal.
- 4 Release the brake pedal within 2 seconds.

Note

If the Launch function does not work, wait a few minutes and let the drivetrain cool down to working temperature before retrying.

Important

The drivetrain is subject to wear and tear when using Launch and therefore the function is only available a limited number of times.

* Option/accessory.

12.6.7. Low speed control

The low speed control function (LSC^[1]) facilitates and improves traction for driving off-road and on slippery surfaces, such as with a caravan on grass or a boat trailer on a launch ramp.

The function is included in drive mode **Off Road**.

The function is adapted for off-road driving and driving with a trailer at low speed, up to approx. 40 km/h (25 mph).

Low speed control prioritises low gears and traction. If the car is all-wheel drive, the motive force is distributed evenly in order to provide as good traction as possible on all wheels and to reduce the risk of wheel spin. The accelerator pedal is less responsive in order to facilitate traction and speed control at low speed.

The function is activated together with hill descent control, (HDC^[2]) which means that speed down steep hills can be controlled with the accelerator pedal, reducing the need to use the brake pedal. The system facilitates a low and even speed while driving on steep downhill gradients.

Note

When LSC with HDC is activated by the **Off Road** driving mode, the feel of the accelerator pedal and engine response are changed.

Note

The driving mode is not designed to be used on public roads.

Note

The function is deactivated when driving at higher speeds and must be reactivated at a lower speed, if required.

^[1] Low Speed Control

^[2] Hill Descent Control

12.6.8. Activating and deactivating low speed control

There is a function button for low-speed driving with **Hill Descent Control** in the centre display's function view unless the car was equipped with drive mode control in the tunnel console.

Select low-speed driving in the centre display function view

- 1 Press the **Hill Descent Control** button to activate or deactivate the function.



- An indicator in the button illuminates when the function is activated.

This function is disabled automatically when the engine is switched off.

Note

The function is deactivated when driving at higher speeds and must be reactivated at a lower speed, if required.

12.6.9. Level control* and shock absorption

Level control regulates the car's suspension and shock absorption characteristics automatically to ensure optimum comfort and functionality while driving. It is also possible to adjust the level manually in order to facilitate loading or entry and exit.

Level control and shock absorption

The system is adapted according to the selected drive mode and according to the speed of the car. Using level control, the car's ground clearance is adjusted to a lower level at higher speeds, which reduces wind resistance and increases stability. Shock absorption is normally set for optimum comfort and is regulated continuously depending on the road surface, the car's acceleration, braking and cornering.



The driver display indicates when level control is in progress.

When a side door or the tailgate is open, the following applies:

- If a side door is open, the level can only be regulated upwards.
- If the tailgate is open, the level can only be regulated downwards.

During parking

During parking, make sure you allow adequate space above and below the car since the car's ground clearance may vary e.g. depending on the outside temperature, how the car is loaded, the use of loading mode or the drive mode that is selected after starting.







The level may also be adjusted some time after the car has been parked. This is to compensate for any changes in height that may occur due to temperature changes in the air springs when the car cools down.

During transport

During transport of the car on a ferry, train or truck, the car must be lashed around the tyres and not around other parts of the chassis. Changes in the level control may occur during transport, which could have a negative effect on the lashing.

Symbols and messages

If a fault arises with the level control, a message is shown in the driver display.

Symbol	Message	Specification
	Suspension Deactivated by user	The active self-levelling has been switched off manually by the user.
	Suspension Temporarily reduced performance	The performance of the active self-levelling has been temporarily reduced due to extensive system use.
	Suspension Service required	A fault has occurred. Visit a workshop ^[1] as soon as possible.
	Suspension failure Stop safely	A critical fault has occurred. Stop safely, have the car transported (raised with all wheels on the flat-bed) to a workshop ^[1] .
	Suspension Slow down Car too high	A fault has occurred. If the message appears whilst driving, contact a workshop ^[1] .
	Suspension Auto adjusting car level	Level control to target height in progress.

* Option/accessory.

^[1] An authorised Volvo workshop is recommended.

12.6.10. Settings for level control *

Switch off the level control when the car is to be jacked up in order to prevent problems with automatic level control.

Regulate the level to facilitate loading, or on entry and exit.

Adjusting loading mode



Use the buttons in the cargo area to regulate the height of the car's rear section and facilitate loading and unloading or when connecting or disconnecting a trailer.

Settings in the centre display

Entry assistance

The car can be lowered to facilitate entry and exit.

Activating entry assistance via the centre display:

- 1 Press **Settings** in the top view.
 - 2 Press **My Car** → **Mirrors and Convenience**.
 - 3 Select **Easy Entry and Exit Suspension Control**.
- When the car is parked and switched off, the car is lowered (level control stops if a door is opened and there may be a certain delay before level control resumes after the door has been closed). When the car is started and begins to move, the car will rise to the height setting for the drive mode selected.

Disable Leveling Control

In certain cases the function must be deactivated e.g. before the car is raised with a jack*. The difference in level created when lifting with a jack would otherwise mean the automatic control starting to adjust the height, creating an undesired effect.

Deactivating the function via the centre display:

- 1 Press **Settings** in the top view.
- 2 Press **My Car** → **Parking Brake and Suspension**.
- 3 Select **Disable Leveling Control**.

* Option/accessory.

12.6.11. Hill descent control

Hill descent control (HDC^[1]) is a low speed function with enhanced engine braking. The function makes it possible to increase or reduce the car's speed on steep downhill gradients using only the accelerator pedal, without using the foot brake.

The function is included in drive mode **Off Road**.

Hill descent control is adapted for off-road driving at low speeds and facilitates driving on steep downhill gradients with difficult surfaces. The driver does not need to use the brake pedal, but can instead focus on steering.

Warning

HDC does not work in all situations but is designed merely as a supplementary aid.

The driver always bears ultimate responsibility for ensuring that the vehicle is driven safely.

Function

Hill descent control allows the car to roll at inching speed both forward and backward, assisted by the brake system. The speed can be increased by using the accelerator pedal. When the accelerator pedal is then released the car slows back down to crawling speed, regardless of the gradient of the hill and without the need for the foot brake to be used. The brake lights are switched on when the function is operating.

The driver can brake and reduce crawling speed, or stop the car at any time by using the foot brake.

The function is activated together with low speed control (LSC^[2]) which facilitates driving and improves traction for driving off-road and on slippery surfaces. The systems are designed for use at low speed, up to approx. 40 km/h (25 mph).

Points to remember when driving with HDC

The content of this manual represents the status of the user manual at the time of printing and may not be completely valid in future instances. For more information, refer to the first page for the complete disclaimer note.

- If the function is disabled while driving on a steep downhill gradient, the braking effect will gradually decrease.
- HDC can be used in gear position D, R, and with 1st or 2nd gear with manual gear changing.
- It is not possible to change to 3rd gear or higher with manual gear changing.

Note

When LSC with HDC is activated by the **Off Road** driving mode, the feel of the accelerator pedal and engine response are changed.

Note

The driving mode is not designed to be used on public roads.

Note

The function is deactivated when driving at higher speeds and must be reactivated at a lower speed, if required.

^[1] Hill Descent Control

^[2] Low Speed Control

12.6.12. Activating and deactivating hill descent control

There is a function button for hill descent control with **Hill Descent Control** in the centre display's function view unless the car was equipped with drive mode control in the tunnel console.

Selecting hill descent control in the centre display function view

Hill descent control only works at low speeds.

- 1 Press the **Hill Descent Control** button to activate or deactivate the function.

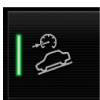

- > An indicator in the button illuminates when the function is activated.

This function is disabled automatically when the engine is switched off.

Note

The function is deactivated when driving at higher speeds and must be reactivated at a lower speed, if required.

12.6.13. Range in electric mode

The car's range depends on several factors. The ability to achieve a long range varies according to the circumstances and conditions under which the car is being driven.

The certified value for the car's mileage should not be interpreted as an expected range. The certified value should primarily be used to compare different cars and is obtained during special test cycles.

Range in the driver display

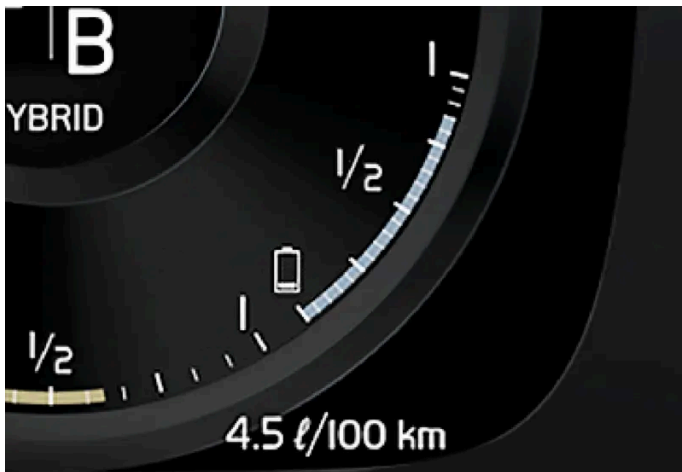

When the car is delivered from the factory, or after a factory reset, the range is based on the certified value.

When the car has been driven for a while, the range is based on historical driving patterns. The amount of history used depends on the battery's state of charge. Therefore, the less charge there is in the hybrid battery, the faster the range adapts to a changed driving pattern.

Factors that affect the range

In addition to historical trip data, there are several different factors that affect the range. The longest range is achieved under extremely favourable conditions when all factors have a positive impact.

Examples of factors that affect the range:

- speed
- climate settings
- topography
- preconditioning
- tyres and tyre pressure
- traffic situation

- temperature and weather
- road conditions.

Range based on speed and outside temperature

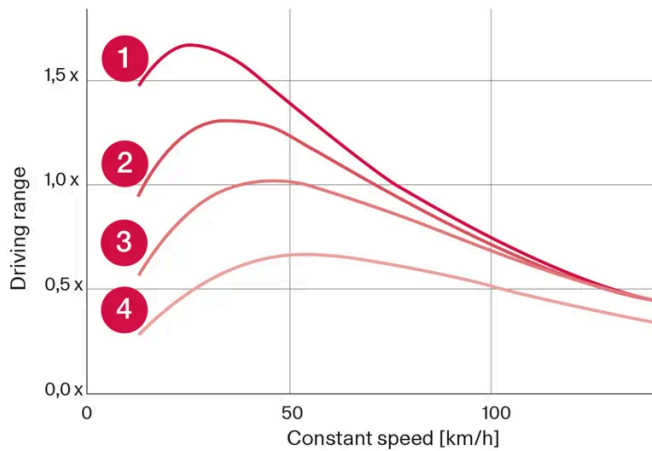

- ① 20 °C (68 °F) outside temperature and passenger compartment climate Off.
- ② 0 °C (32 °F) outside temperature and passenger compartment climate On.
- ③ 35 °C (95 °F) outside temperature and passenger compartment climate On.
- ④ -10 °C (14 °F) outside temperature and passenger compartment climate On.

The graph shows the approximate relationship between constant speed and range, where a lower constant speed has a positive effect on range.

A higher outside temperature and deactivated climate control are also more beneficial for the range.

12.6.14. All-wheel drive

All-wheel drive (AWD^[1]) means that the car is driving all four wheels at the same time, which improves traction.

The electric motor that drives the rear wheels enables electric all-wheel drive functionality. All-wheel drive characteristics vary depending on the selected drive mode.

^[1] All-wheel drive

12.7. Recommendations for driving

12.7.1. Towing

During towing, the car is towed by another vehicle by means of a towline.

Towing the car is not permitted as this will damage the electric motor. Instead, the car must be transported raised with all the wheels on a recovery vehicle's platform, neither of the wheel pairs may have road contact.

When towing another car

Towing a car requires a lot of energy - use the **Constant AWD** drive mode. This then charges the hybrid battery, in combination with improving the car's driving characteristics and roadholding.

Find out the statutory maximum speed limit for towing before the towing begins.

Jump starting

Tow-starting the motor is not permitted as this will damage the electric motor. Use a donor battery if the starter battery is discharged and the engine does not start.

Important

The electric drive motor and the catalytic converter may be damaged during attempts to tow-start the car.

12.7.2. Help when starting on a hill

Hill start assist (HSA^[1]) prevents the car from rolling backwards when starting on an uphill gradient. When reversing uphill, it prevents the car from rolling forwards.

The function means that the pedal pressure in the brake system remains for several seconds while the driver's foot is moved from brake pedal to accelerator pedal.

The temporary braking effect releases after several seconds or when the driver starts to drive away.

The Hill Start Assist is activated when stopping on a steep slope. The function is available even when the automatic braking when stationary (Auto hold) function is deactivated.

^[1] Hill Start Assist

12.7.3. Braking on gritted roads

When driving on salted roads, a layer of salt may form on the brake discs and brake linings.

This may extend braking distance. You should therefore maintain a greater safety distance to vehicles in front. In addition, make sure you do the following:

- Brake now and again to remove any layer of salt. Make sure that other road users are not put at risk by the braking.
- Gently depress the brake pedal after finishing driving and before starting your next trip.

12.7.4. Braking on wet roads

When driving for a prolonged period of time in heavy rain without braking, the braking effect may be delayed slightly when next using the brakes.

This may also be the case after a car wash. It is then necessary to depress the brake pedal more forcefully. You should therefore maintain a greater distance to the vehicles in front.

Brake the car firmly after driving on wet roads or using a car wash. This warms up the brake discs, enabling them to dry faster and protecting them against corrosion. Bear in mind the current traffic situation when braking.

12.7.5. Parking on a hill

Always make sure that the parking brake has been activated when parking on a hill.

Warning

Always use the parking brake when parking on an inclined surface. Engaging a gear or the automatic transmission's P position is not sufficient to hold the car stationary in all situations.

If the car is parked facing uphill:

- Turn the wheels **away from** the kerb.

If the car is parked facing downhill:

- Turn the wheels **towards** the kerb.

Heavy load uphill

A heavy load, such as a trailer, can cause the car to roll backward when the parking brake is released automatically on a steep incline. Avoid this by pulling the control upwards while driving the car away. Release the control when the engine achieves traction.

12.7.6. Petrol particle filter^[1]

The content of this manual represents the status of the user manual at the time of printing and may not be completely valid in future instances. For more information, refer to the first page for the complete disclaimer note.

Petrol cars are fitted with particle filters for more efficient emission control.

Particles in the exhaust gases are collected in the petrol particle filter during normal driving. In normal driving conditions, passive regeneration takes place, which leads to the particles being oxidised and burned away. The filter is emptied in this way.

If the car is driven at low speed or with repeated cold starts in low outside temperature, active regeneration may be necessary. Regeneration of the particulate filter is automatic and normally takes 10-20 minutes. Fuel consumption may temporarily increase during regeneration.

When driving short distances at low speeds in a petrol car

The capacity of the emissions system is affected by how the car is driven. Driving varying distances and at different speeds is important in order to achieve performance that is as energy-efficient as possible.

Driving short distances at low speeds (or in cold climates) frequently, where the engine does not reach normal operating temperature, can lead to problems that can eventually cause a malfunction and trigger a warning message. If the vehicle is mostly driven in city traffic, it is important to regularly drive at higher speeds to allow the emissions system to regenerate.

- The car should be driven on A-roads at speeds in excess of 70 km/h (44 mph) for at least 20 minutes between each refuelling.

^[1] Applicable to certain variants.

12.7.7. Petrol station

Use the car's navigation system* in order to find the route to the closest petrol station.

When stopping to refuel it is a good idea to make a general inspection of the car as well, such as checking tyre pressure, bulbs, wiper blades, topping up washer fluid, etc.

* Option/accessory.

12.7.8. Energy distribution using map data*

In the driving position **Hybrid** the car is powered by both the electric motor and the internal combustion engine. If a destination has been selected in the navigation system*, the Predictive Efficiency^[1] function distributes the electric energy consumption along the whole driving distance using the map data.

In addition to the map data, the function also takes into account speed limits, traffic and elevation differences.

The electric motor is used primarily when driving at low speeds e.g. during city driving with more stops and starts. The combustion engine is used primarily when driving at high speeds and can, in good conditions, generate power for the electric motor.

Conditions for the function

For the function to work requires that a number of conditions are met:

- A destination is set in the navigation system and the driving distance to the destination is longer than the range possible only on electric drive.
- **Hybrid** drive mode is selected.
- The **Hold** and **Charge** functions are deactivated.

Tips for use

If the car is used for commuting to work and it is not possible to charge the car at the place of work, specify the place of work as an intermediate destination and your home as the final destination. The discharging of the hybrid battery will then take place over your runs both to and from work.

Add similar commuting routes, i.e. the route between two charging points, as **Favourites** in the navigation system to facilitate arrival.

* Option/accessory.

[1] Certain markets only.

12.7.9. Range in electric mode

The car's range depends on several factors. The ability to achieve a long range varies according to the circumstances and conditions under which the car is being driven.

The certified value for the car's mileage should not be interpreted as an expected range. The certified value should primarily be used to compare different cars and is obtained during special test cycles.

Range in the driver display

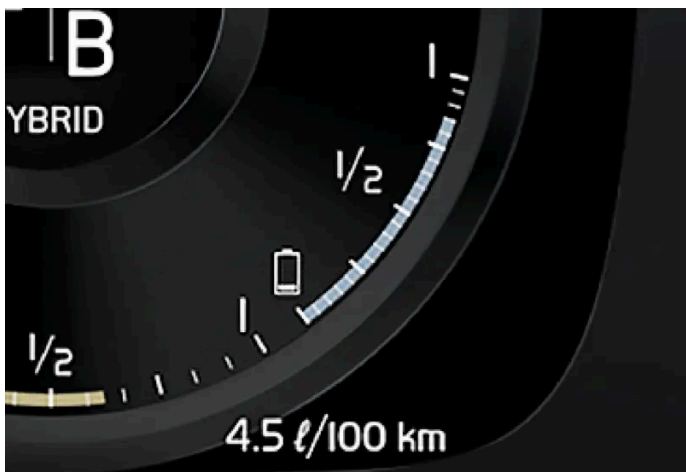

When the car is delivered from the factory, or after a factory reset, the range is based on the certified value.

The content of this manual represents the status of the user manual at the time of printing and may not be completely valid in future instances. For more information, refer to the first page for the complete disclaimer note.

When the car has been driven for a while, the range is based on historical driving patterns. The amount of history used depends on the battery's state of charge. Therefore, the less charge there is in the hybrid battery, the faster the range adapts to a changed driving pattern.

Factors that affect the range

In addition to historical trip data, there are several different factors that affect the range. The longest range is achieved under extremely favourable conditions when all factors have a positive impact.

Examples of factors that affect the range:

- speed
- climate settings
- topography
- preconditioning
- tyres and tyre pressure
- traffic situation
- temperature and weather
- road conditions.

Range based on speed and outside temperature

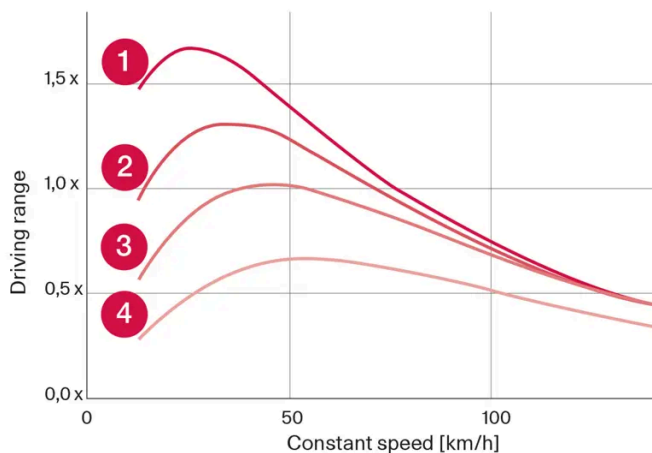

1 20 °C (68 °F) outside temperature and passenger compartment climate Off.

2 0 °C (32 °F) outside temperature and passenger compartment climate On.

3 35 °C (95 °F) outside temperature and passenger compartment climate On.

4 -10 °C (14 °F) outside temperature and passenger compartment climate On.

The graph shows the approximate relationship between constant speed and range, where a lower constant speed has a positive effect on range.

A higher outside temperature and deactivated climate control are also more beneficial for the range.

12.7.10. Economical driving

To achieve the longest possible range, the driver should plan driving and adapt driving style and speed to the prevailing situation.

Before driving

- Precondition the car before driving if possible using the charging cable connected to the mains power circuit.
- If preconditioning is not possible when it is cold outside, use seat heating and steering wheel heating first of all. Avoid warming up the whole of the interior which takes energy from the hybrid battery.
- Choice of tyres and tyre pressure can affect energy consumption - seek advice on suitable tyres from an authorised Volvo dealer.
- Remove unnecessary items from the car - the greater the load the higher the consumption.

While driving

- Activate drive mode **Pure**.
- Activate the **Hold** function at higher speeds during journeys that are longer than the range of the electricity.
- If possible, avoid using the **Charge** function to charge the hybrid battery.
- Drive at a steady speed and keep a good distance to other vehicles and objects in order to avoid braking.
- The hybrid battery is recharged during braking by braking gently with the brake pedal.
- High speed results in increased energy consumption since the wind resistance increases with speed.
- In a cold climate, reduce electrical heating of windows, mirrors, seats and steering wheel, if possible.
- Avoid driving with open windows.
- Do not hold the car stationary on a hill with the accelerator pedal. Instead, activate the function for braking when stationary.
- If possible, deactivate the climate control while driving a short distance after preconditioning.

After driving

- If possible, park in an acclimated garage with charging facilities.

12.7.11. Preparations for a long trip

Before a driving holiday or some other type of long journey, it is important to check the car's functions and equipment particularly carefully.

Check that

- the engine is working normally and that fuel consumption is normal
- there are no leaks (fuel, oil or other fluid)
- braking effect on braking works as intended

- the tyres have sufficient tread depth and pressure. Change to winter tyres when driving to areas where there is a risk of snowy or icy road surfaces
- starter battery charging is good
- the wiper blades are in good condition
- a warning triangle and high-visibility vest are located in the car - legally required in certain countries

It may also be advisable to make sure that the maps in the navigation system* are updated, and to check the regulations for loading and for travelling on a car ferry or train, if appropriate.

Note that additional data roaming costs may be charged when the car is online abroad.

* Option/accessory.

12.7.12. Overloading the starter battery

High power consumption without the car being able to charge the starter battery leads to low State of Charge (SoC) and some electric functions being reduced or switched off. If the State of Charge (SoC) decreases to below a certain limit, it is no longer possible to start the car without jump starting or charging with an external charger.

There are several measures that reduce power consumption. Avoid using the ignition position II when the car is switched off. Instead, use ignition position I - which consumes less power. Do not use functions which use a lot of power when the car is not being driven. Examples of such functions are:

- ventilation fan
- headlamps
- windscreen wiper
- audio system
- accessories that are activated in the car.

If the starter battery voltage is low, a message is shown in the driver display. The energy-saving function then shuts down certain functions or reduces certain functions such as the ventilation fan and audio system.

- 1 In which case, charge the starter battery by starting the car and then running it for at least 15 minutes - starter battery charging is more effective during driving than running the engine at idling speed while stationary.

If the battery's State of Charge (SoC) continues to be low or fully discharged after the measures have been taken, the car should be checked at a workshop – an authorised Volvo workshop is recommended.

 **Note**

High current take-off may lead to battery capacity falling below the lowest permitted level, which temporarily limits the start/stop function. The engine then starts automatically without the driver lifting his/her foot from the brake pedal.

12.7.13. Driving in water

Wading means the car being driven through water e.g. on a flooded road. Driving in water must be performed with great caution.

Observe the following to prevent damage to the car when driving through water:

- The water level must not be higher than the floor of the car. If possible, check the depth at the deepest point before starting to drive through the water. Extra caution should be exercised when passing through flowing water.
- Always change to **Off Road** drive mode before driving through water in order to ensure that the internal combustion engine is running.
- Do not drive faster than walking pace.
- Do not stop the car in the water. Drive forward carefully or reverse the car back out of the water.
- Remember that waves created by oncoming traffic may rise above the level for the floor of the car.
- Avoid driving through salt water (corrosion risk).

 **Important**

Parts of the car (e.g. engine, gearbox, driveline or electrical components) may be damaged when driving through water with a level higher than the floor of the car. Damaged caused to a component caused by submersion, hydrolock or lack of oil is not covered by the warranty.

In the event of stalling in water, do not try to restart. Instead, tow the car out of the water and transported on a low loader to a workshop. An authorised Volvo workshop is recommended.

When the water has been passed, depress the brake pedal lightly and check that full brake function is achieved. Water and mud for example can make the brake linings wet resulting in delayed brake function.

If necessary, clean the contact for the trailer coupling after driving in water and mud.

12.7.14. Winter driving

For winter driving it is important to perform certain checks of the car in order to ensure that it can be driven safely.

Check the following in particular before a cold season:

- The engine coolant must contain 50% glycol. This mixture protects the engine against frost down to approx. -35°C (-31°F). To avoid health risks, different types of glycol must not be mixed.
- The fuel tank must be kept filled to prevent condensation.
- Engine oil viscosity is important. Oils with lower viscosity (thinner oils) facilitate starting in cold weather and also reduce fuel consumption while the engine is cold.
- The condition of the starter battery and charge level must be inspected. Cold weather places great demands on the starter battery and its capacity is reduced by the cold.
- The condition of the battery and its charge level must be inspected. Cold weather places higher demands on the battery and its capacity is reduced by the cold.
- Use washer fluid with antifreeze to avoid ice forming in the washer fluid reservoir.

See the separate section for engine oil recommendations.

Slippery driving conditions

To achieve optimum roadholding Volvo recommends using winter tyres on all wheels if there is a risk of snow or ice.



Note

The use of winter tyres is a legal requirement in certain countries. Studded tyres are not permitted in all countries.

Practise driving on slippery surfaces under controlled conditions to learn how the car reacts.

12.7.15. Overheating in the engine and drive system



Under certain conditions, e.g. hard driving in hilly terrain and hot climate, there is a risk that the engine and drive system may overheat – in particular with a heavy load.

- In the event of overheating, the engine's power may be limited temporarily.
- Remove any auxiliary lamps from in front of the grille when driving in hot climates.
- If the temperature in the engine's cooling system becomes too high then a warning symbol is illuminated and the driver display shows the message **Engine temperature High temperature Stop safely**. Stop the car in a safe way and allow the engine to run at idling speed for several minutes and cool down.
- If the message **Engine temperature High temperature Turn off engine** or **Engine coolant Level low, turn off engine** is shown, stop the car and switch off the engine.
- In the event of overheating in the gearbox, an alternative gear shift program will be selected. In addition, a built-in protection function is activated that, amongst other things, illuminates a warning symbol and the driver display shows the message **Transmission warm Reduce speed to lower temperature** or **Transmission hot Stop safely, wait for cooling**. Follow the recommendation given, reduce speed or stop the car in a safe way and allow the engine to run at idling speed for several minutes to enable the gearbox to cool down.
- If the car overheats, the air conditioning may be switched off temporarily.
- Do not turn the engine off immediately you stop after a hard drive.

 **Note**

It is normal for the engine's cooling fan to operate for a time after the engine has been switched off.

Symbols in the driver display

Symbol	Specification
	High engine temperature. Follow the recommendation given.
	Low level, coolant. Follow the recommendation given.
	Gearbox hot/overheated/cooled. Follow the recommendation given.

12.7.16. Driving with a trailer

When driving with a trailer, there are a number of points that are important to think about regarding the towbar, the trailer and how the load is positioned in the trailer.

Payload depends on the car's kerb weight. The total of the weight of the passengers and all accessories, e.g. towbar, reduces the car's payload by a corresponding weight.

The car is supplied with the necessary equipment for towing a trailer.

- The car's towbar must be of an approved type.
- Distribute the load on the trailer so that the weight on the towbar complies with the specified maximum towball load. Towball load is calculated as part of the car's payload.
- Increase the tyre pressure to the recommended pressure for a full load.
- The engine is loaded more heavily than usual when driving with a trailer.
- Do not tow a heavy trailer when the car is brand new. Wait until it has been driven at least 1000 km (620 miles).
- The brakes are loaded much more than usual on long and steep downhill slopes. Downshift to a lower gear when shifting manually and adjust your speed.
- Follow the regulations in force for the permitted speeds and weights.
- Maintain a low speed when driving with a trailer up long, steep ascents.
- The maximum indicated trailer weight only applies to heights up to 1000 metres above sea level (3280 ft). At higher elevations, the engine output and the vehicle's climbing ability are reduced due to the reduced air density, and the maximum trailer load must therefore be reduced. The weight of the car and trailer must be decreased by 10% for each additional 1000 m (3280 ft) or part thereof.
- Avoid driving with a trailer on inclines of more than 12%.

 **Important**

When driving with a trailer in a car with air suspension*, use the **Suspension Control** → **Dynamic** setting in Individual drive mode.

 **Note**

Extreme weather conditions, driving with a trailer or driving at high altitudes, in combination with poorer fuel quality than recommended, are factors that considerably increase the car's fuel consumption.

Trailer weights

 **Warning**

Follow the stated recommendations for trailer weights. Otherwise, the car and trailer may be difficult to control in the event of sudden movement and braking.

 **Note**

The stated maximum permitted trailer weights are those permitted by Volvo. National vehicle regulations can further limit trailer weights and speeds. Towbars can be certified for higher towing weights than the car can actually tow.

Level control*

The car's system for level control endeavours to maintain a constant height regardless of load (up to the maximum permissible weight). When the car is stationary the rear of the car lowers slightly, which is normal.

When driving in hilly terrain

Under certain circumstances, there may be a risk of overheating when towing a trailer. If the engine and drive system overheats, a warning symbol comes on in the driver display and a message is displayed.

The automatic gearbox adapts the gears depending on load and engine speed.

Steep inclines

Do not lock the automatic gearbox in a higher gear than the engine "can cope with" - it is not always a good idea to drive at a high gear with low engine speed.

Parking on a hill

- 1 Depress the brake pedal fully.
- 2 Activate the parking brake.
- 3 Select gear position P.

The content of this manual represents the status of the user manual at the time of printing and may not be completely valid in future instances. For more information, refer to the first page for the complete disclaimer note.

- 4 Release the brake pedal.

Block the wheels with chocks when parking a car with hitched trailer on a hill.

Starting on a hill

- 1 Depress the brake pedal fully.
- 2 Select gear position D.
- 3 Releasing the parking brake.
- 4 Release the brake pedal and start driving off.

* Option/accessory.

12.8. Towbar and trailer

12.8.1. Towing capacity and towball load

Towing capacity and towball load for driving with a trailer can be read in the tables.

Max. weight braked trailer

 **Note**

Use of vibration dampers on the towbar is recommended for trailers heavier than 1800 kg.

Engine	Engine code ^[1]	Gearbox	Max. weight braked trailer (kg)	Max. towball load (kg)
T8 Recharge	B4204T34	Automatic	2400	110
T8 Recharge	B4204T35	Automatic	2400	110
T8 Recharge	B4204T28	Automatic	2400	110

 **Important**

When driving with a trailer, it is permitted to exceed the vehicle's gross vehicle weight (including towball load) by a maximum of 100 kg (220 lbs), provided that speed is limited to 100 km/h (62 mph). National legal requirements for the vehicle combination, such as speed, etc. must be observed.

 **Note**

If there is no weight data in the table, this is available in an enclosed supplement.

Max. weight unbraked trailer

Unbraked trailer	
Max. weight (kg)	750
Max. towball load (kg)	50

^[1] The engine code, component number and serial number can be found on the engine.

12.8.2. Towbar*

The car can be equipped with a towbar that makes it possible to tow e.g. a trailer behind the car.

There may be different towbar variants available for the car. Contact a Volvo dealer for more information.

 **Important**

When the car is switched off, the constant battery voltage to the trailer connector can be switched off automatically in order not to drain the starter battery.

 **Important**

The towball needs regular cleaning and lubrication with grease in order to prevent wear.

 **Note**

When a hitch with a vibration damper is used, the towball must not be lubricated.

This also applies when fitting a bicycle rack that is clamped in around the towball.

Note

If the car is equipped with a towbar, there is no rear mounting for a towing eye.

* Option/accessory.

12.8.3. Specifications for towbar*

Dimensions and mounting points for towbar.

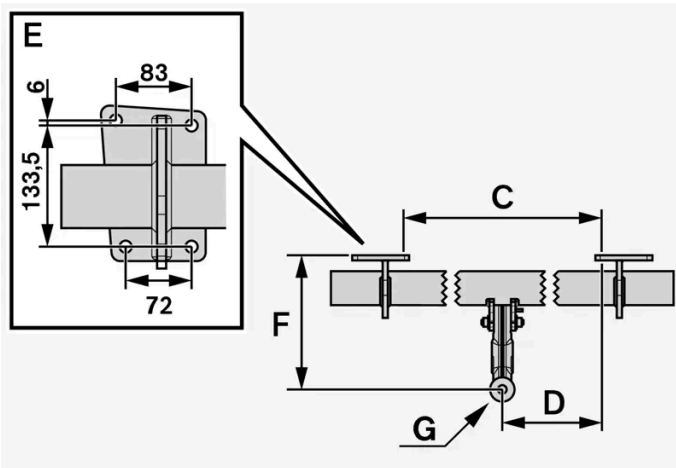
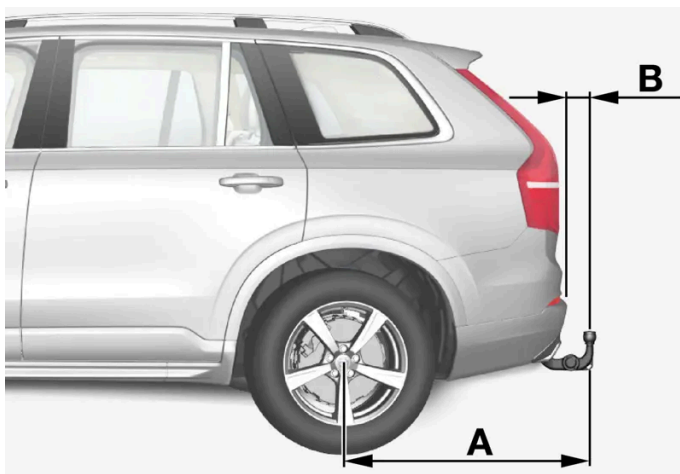

Dimensions, mounting points in mm (inches)

A	1476 (58,1)
B	86 (3,4)
C	875 (34,4)
D	437,5 (17,2)
E	See the image above
F	273 (10,7)

The content of this manual represents the status of the user manual at the time of printing and may not be completely valid in future instances. For more information, refer to the first page for the complete disclaimer note.

Dimensions, mounting points in mm (inches)

G	Ball centre
---	-------------

* Option/accessory.

12.8.4. Towbar-mounted bicycle rack*

When using a bicycle rack, the bicycle racks that Volvo has developed are recommended.

This is in order to avoid damage to the car and in order to achieve the maximum possible safety during a journey. Volvo's bicycle racks are available for purchase at authorised Volvo dealers.

Carefully follow the instructions enclosed with the bicycle rack.

- Bicycle rack including load must weigh a maximum of 75 kg (165 pounds).
- The bicycle rack may be designed for a maximum of three bicycles.

Warning

Incorrect use of the bicycle rack may cause damage to the towbar and car.

The bicycle rack can loosen from the towbar if it

- is incorrectly fitted on the towball
- is overloaded, see the bicycle rack's instructions for maximum load weight
- is used for carrying something other than bicycles.

The car's driving characteristics are affected when a bicycle rack is fitted on the towbar. For example due to:

- increased weight
- reduced acceleration capacity
- reduced ground clearance
- changed braking capacity.

Recommendations for loading bicycles on the bicycle rack

The larger the distance between the load's centre of gravity and the towball, the greater the load on the towbar.

Load according to the following recommendations:

- Fit the heaviest bicycle furthest in, closest to the car.
- Keep the load symmetrical and as close to the centre of the car as possible e.g. by loading the bicycles facing alternately if several bicycles are loaded.

- Remove loose objects from the bicycle for transportation, e.g. bicycle basket, battery, child seat. Partly to reduce the load on the towbar and bicycle rack, and partly to reduce the wind resistance, which affects fuel consumption.
- Do not use protective covers on the bicycles. This may affect manoeuvrability, impair visibility and increase fuel consumption. It may also lead to an increased load on the towbar.

* Option/accessory.

12.8.5. Extendable and retractable towbar*

The retractable tow hook is easy to retract or extend as required. In the retracted position, the towbar is completely concealed.

Warning

Follow the instructions for retracting and extending the towbar carefully.

Warning

Do not press the extend/retract button if a trailer or accessory is attached to the tow bar.

Extending the towbar

Warning

Avoid standing close to the bumper in the centre behind the car when extending the towing hitch.



Open the tailgate. A button for extending/retracting the towbar is located on the right-hand side at the rear of the cargo area. An indicator lamp in the button must illuminate with a constant orange glow for the extension function to be active.

- 2 Press and release the button – extension might not start if the button is pressed for too long.



- The towbar extends out and down in an unlocked position - the indicator lamp flashes orange. The tow hook is ready to continue moving to the locked position.



Move the towbar to its end position, where it is secured and locked in place - the indicator lamp illuminates with a constant orange glow.

- The towbar is ready for use.

! Important

When the tow bar is activated by pressing a key and has been placed in the unlocked position:

Wait at least 2 seconds before the tow bar is moved to the locked position. If the tow bar does not remain in the locked position, wait another few seconds and try again.

Do not kick the tow bar.

! Warning

Take care to secure the trailer's safety cable in the intended bracket.

i Note

Power save mode activates after a while and the indicator lamp goes out. The system is reactivated by closing and opening the tailgate. This applies when retracting or extending the towbar.

If the car detects a connected trailer electrically, the indicator lamp stops illuminating with a constant glow. Towbar retraction and extension are then not possible.

Retracting the towbar

! Important

Make sure that there is no plug or adapter in the electrical socket when retracting the towbar.

- 1 Open the tailgate. Press and release the button on the right-hand side at the rear of the cargo area - retraction might not start if the button is pressed for too long.

> The towbar automatically lowers in an unlocked position - the indicator lamp in the button flashes orange.

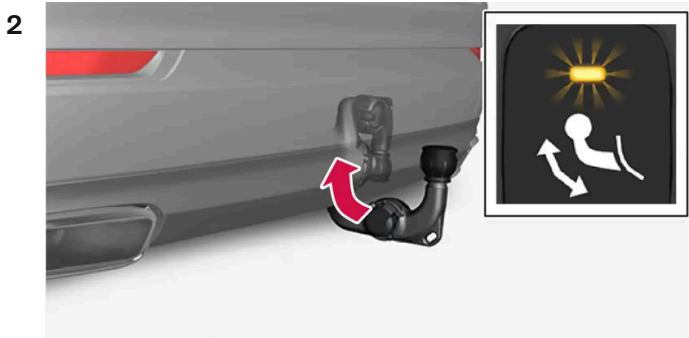

Lock the towbar by moving it back to its retracted position, where it is locked.

> The indicator lamp will now illuminate with a constant glow if the towbar is correctly retracted.

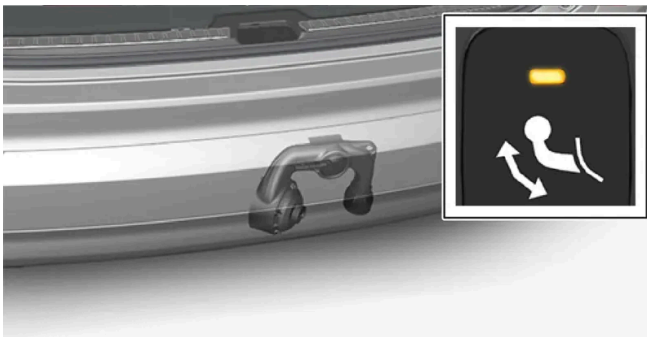

! Important

When the tow bar is activated by pressing a key and has been placed in the unlocked position:

Wait at least 2 seconds before the tow bar is moved to the locked position. If the tow bar does not remain in the locked position, wait another few seconds and try again.

Do not kick the tow bar.

! Important

The towbar must always be retracted when not in use.

* Option/accessory.

12.8.6. Low speed control

The low speed control function (LSC^[1]) facilitates and improves traction for driving off-road and on slippery surfaces, such as with a caravan on grass or a boat trailer on a launch ramp.

The function is included in drive mode **Off Road**.

The function is adapted for off-road driving and driving with a trailer at low speed, up to approx. 40 km/h (25 mph).

Low speed control prioritises low gears and traction. If the car is all-wheel drive, the motive force is distributed evenly in order to provide as good traction as possible on all wheels and to reduce the risk of wheel spin. The accelerator pedal is less responsive in order to facilitate traction and speed control at low speed.

The function is activated together with hill descent control, (HDC^[2]) which means that speed down steep hills can be controlled with the accelerator pedal, reducing the need to use the brake pedal. The system facilitates a low and even speed while driving on steep downhill gradients.

Note

When LSC with HDC is activated by the **Off Road** driving mode, the feel of the accelerator pedal and engine response are changed.

Note

The driving mode is not designed to be used on public roads.

Note

The function is deactivated when driving at higher speeds and must be reactivated at a lower speed, if required.

^[1] Low Speed Control

^[2] Hill Descent Control

12.8.7. Driving with a trailer

When driving with a trailer, there are a number of points that are important to think about regarding the towbar, the trailer and how the load is positioned in the trailer.

Payload depends on the car's kerb weight. The total of the weight of the passengers and all accessories, e.g. towbar, reduces the car's payload by a corresponding weight.

The car is supplied with the necessary equipment for towing a trailer.

- The car's towbar must be of an approved type.
- Distribute the load on the trailer so that the weight on the towbar complies with the specified maximum towball load. Towball load is calculated as part of the car's payload.
- Increase the tyre pressure to the recommended pressure for a full load.
- The engine is loaded more heavily than usual when driving with a trailer.
- Do not tow a heavy trailer when the car is brand new. Wait until it has been driven at least 1000 km (620 miles).
- The brakes are loaded much more than usual on long and steep downhill slopes. Downshift to a lower gear when shifting manually and adjust your speed.
- Follow the regulations in force for the permitted speeds and weights.
- Maintain a low speed when driving with a trailer up long, steep ascents.
- The maximum indicated trailer weight only applies to heights up to 1000 metres above sea level (3280 ft). At higher elevations, the engine output and the vehicle's climbing ability are reduced due to the reduced air density, and the maximum trailer load must therefore be reduced. The weight of the car and trailer must be decreased by 10% for each additional 1000 m (3280 ft) or part thereof.
- Avoid driving with a trailer on inclines of more than 12%.

 **Important**

When driving with a trailer in a car with air suspension*, use the **Suspension Control** → **Dynamic** setting in Individual drive mode.

 **Note**

Extreme weather conditions, driving with a trailer or driving at high altitudes, in combination with poorer fuel quality than recommended, are factors that considerably increase the car's fuel consumption.

Trailer weights

 **Warning**

Follow the stated recommendations for trailer weights. Otherwise, the car and trailer may be difficult to control in the event of sudden movement and braking.

 **Note**

The stated maximum permitted trailer weights are those permitted by Volvo. National vehicle regulations can further limit trailer weights and speeds. Towbars can be certified for higher towing weights than the car can actually tow.

Level control *

The car's system for level control endeavours to maintain a constant height regardless of load (up to the maximum permissible weight). When the car is stationary the rear of the car lowers slightly, which is normal.

When driving in hilly terrain

Under certain circumstances, there may be a risk of overheating when towing a trailer. If the engine and drive system overheats, a warning symbol comes on in the driver display and a message is displayed.

The automatic gearbox adapts the gears depending on load and engine speed.

Steep inclines

Do not lock the automatic gearbox in a higher gear than the engine "can cope with" - it is not always a good idea to drive at a high gear with low engine speed.

Parking on a hill

- 1 Depress the brake pedal fully.
- 2 Activate the parking brake.
- 3 Select gear position P.
- 4 Release the brake pedal.

Block the wheels with chocks when parking a car with hitched trailer on a hill.

Starting on a hill

- 1 Depress the brake pedal fully.
- 2 Select gear position D.
- 3 Releasing the parking brake.
- 4 Release the brake pedal and start driving off.

* Option/accessory.

12.8.8. Trailer stability assist *

The content of this manual represents the status of the user manual at the time of printing and may not be completely valid in future instances. For more information, refer to the first page for the complete disclaimer note.

The function of trailer stability assist (TSA^[1]), which is included in the stability system ESC^[2], is to stabilise cars towing trailers in situations where they begin snaking. The function is available with towbar installation, contact a Volvo dealer for more information.

Reasons for snaking

The snaking phenomenon can occur with any car/trailer combination. Snaking normally occurs at high speeds. However, there is a risk of it occurring at lower speeds if the trailer is overloaded or the load is improperly distributed, e.g. too far back.

Triggering factors for snaking may, for example, include:

- Car with trailer subjected to a sudden and powerful side wind.
- Car with trailer drives on an uneven road surface or in a pothole.
- Sweeping steering wheel movements.

If snaking has started, it could be difficult or even impossible to suppress. This makes the car/trailer combination difficult to control and there is a risk that you could end up in the wrong lane or leave the carriageway.

Trailer stability assist function

The trailer stability assist function continually monitors the car's movements, particularly lateral movements. If snaking is detected, the front wheels are individually braked. This serves to stabilise the car/trailer combination. This is often enough to help the driver regain control of the car.

If snaking is not eliminated the first time that trailer stability assist intervenes, the car/trailer combination is braked with all wheels and the car's traction is reduced. Once snaking has been gradually suppressed and the car/trailer combination is stable once again, the system stops regulating and the driver once again has full control of the car.

Note

The stability function is deactivated if the driver chooses to activate **ESC Sport Mode** via the menu system in the centre display.

Trailer stability assist may fail to intervene if the driver uses severe steering wheel movements to try to rectify the snaking because in such a situation the system cannot determine whether it is the trailer or the driver causing the snaking.



When Trailer Stability Assist (TSA) is operating, the ESC symbol flashes in the driver display.

Note

Retrofitting a towbar requires an update of the car's software, contact a Volvo dealer.

* Option/accessory.

^[1] Trailer Stability Assist

^[2] Electronic Stability Control

12.8.9. Checking trailer lamps

When connecting a trailer – check that the trailer lamps work before departure.

Checking trailer lamps *

Automatic checking

After a trailer is connected electrically, it is possible to check that the trailer lamps are working via an automatic lamp activation. The function helps the driver check that the trailer lamps are working before starting off.

The car must be switched off to perform the check.

- 1 When a trailer is connected to the towbar, the **Automatic Trailer Lamp Check** message is shown in the driver display.
- 2 Confirm the message by pressing the right-hand steering wheel keypad's **O** button.
 - > The lamp check starts.
- 3 Exit the car to check lamp functionality.
 - > All trailer lamps start to flash - then the lamps are switched on one at a time.
- 4 Visually check that all lamps available on the trailer are operational.
- 5 After a moment, all lamps on the trailer flash again.
 - > The check is complete.

Switching off automatic checking

The automatic checking function can be switched off in the centre display.

- 1 Press **Settings** in the top view.
- 2 Press **My Car** → **Lights and Lighting**.
- 3 Deselect **Automatic Trailer Lamp Check**.

Manual checking

If the automatic checking is switched off then it is possible to start the check manually.

- 1 Press **Settings** in the top view.

2 Press **My Car** → **Lights and Lighting**.

3 Select **Manual Trailer Lamp Check**.



➤ The lamp check starts. Exit the car to check lamp functionality.

Rear fog lamp on trailer

When connecting the trailer, the rear fog lamp may not light up on the car. In such cases, the rear fog lamp function switches to the trailer. Upon activation of the rear fog lamp, check therefore that the trailer is equipped with a rear fog lamp to travel safely.

Symbols and messages in the driver display

If one or more of the trailer's direction indicators or brake light bulbs is broken, the driver display shows a symbol and a message. Other lights on the trailer must be checked manually by the driver before setting off.

Symbol	Message
	<ul style="list-style-type: none">Trailer turn indicator Right turn indicator malfunctionTrailer turn indicator Left turn indicator malfunction
	<ul style="list-style-type: none">Trailer brake light Malfunction

If any lamp for the trailer's direction indicators is broken, the driver display symbol for direction indicators will also flash more quickly than normal.

* Option/accessory.

12.9. Fuel

12.9.1. Fuel gauge

The fuel gauge in the driver display shows the fuel level in the tank.



The figure is schematic - parts may vary depending on car model.

The beige zone in the fuel gauge indicates the quantity of fuel in the tank.

When the fuel level is low, the fuel pump symbol illuminates and turns amber colour. The trip computer also shows the distance to empty tank.

12.9.2. Handling of fuel

Do not use fuel with a lower quality than that recommended by Volvo, as this will negatively affect engine power and fuel consumption.

Warning

Always avoid inhaling fuel vapour and getting fuel splashes in the eyes.

In the event of fuel in the eyes, remove any contact lenses and rinse the eyes in plenty of water for at least 15 minutes and seek medical attention.

Never swallow fuel. Fuels such as petrol, bioethanol and mixtures of them and diesel are highly toxic and could cause permanent injury or be fatal if swallowed. Seek medical attention immediately if fuel has been swallowed.

Warning

Fuel which spills onto the ground can be ignited.

Switch off the fuel-driven heater before starting to refuel.

Never carry an activated mobile phone when refuelling. The ring signal could cause spark build-up and ignite petrol fumes, leading to fire and injury.

! Important

Mixtures of various fuel types or use of fuels which are not recommended will invalidate Volvo's guarantees and any supplementary service agreements; this is applicable to all engines.

12.9.3. Petrol

It is important to use the correct fuel during refuelling. Petrol is available with different octane ratings that are adapted for different types of driving.

Only use petrol from well-known producers. Never use fuel of dubious quality. The petrol must fulfil the EN 228 standard.

Identifier for petrol

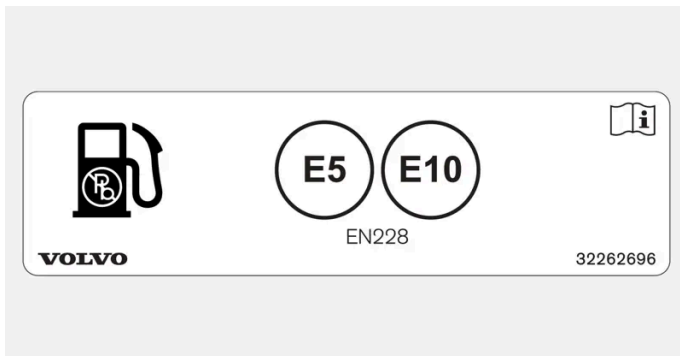

Decal on the inside of the fuel filler flap.

The identifier in accordance with the CEN standard EN16942 is located on the inside of the fuel filler flap, and will be on corresponding fuel pumps and their nozzles at filling stations throughout Europe by 12 October 2018 at the latest.

These are the identifiers that apply for current standard fuels in Europe. Petrol with the following identifiers may be used in cars with petrol engine:



E5 is a petrol with maximum 2.7% oxygen and maximum 5 volume % ethanol.



E10 is a petrol with maximum 3.7% oxygen and maximum 10 volume % ethanol.

! Important

- Fuel that contains up to 10 percent by volume ethanol is permitted.
- EN 228 E10 petrol (max 10 percent by volume ethanol) is approved for use.
- Ethanol higher than E10 (max. 10 percent by volume ethanol) is not permitted, e.g. E85 is not permitted.

Octane rating

- RON 95 can be used for normal driving.
- RON 98 is recommended for good power and low fuel consumption.
- An octane rating lower than RON 95 must not be used.

When driving in temperatures above +38 °C (100 °F), fuel with the highest octane rating is recommended for adapted performance and fuel economy.

Important

- Use only unleaded petrol to avoid damaging the catalytic converter.
- Fuel containing metallic additives must not be used.
- Do not use any additives which have not been recommended by Volvo.

Messages in the driver display

If the car has been driven with the electric motor only for a long time, the fuel may become too old and need to be consumed. If this takes place, the following messages will be shown in the driver display.

Message	Explanation
Aged fuelStart engine to consume fuel	The tank contains a lot of aged fuel. Start the engine to consume the fuel.
Aged fuelEngine will run to consume fuel	The tank contains a lot of aged fuel. The engine is started automatically to consume the fuel.
Aged fuelFill up fuel tank	The tank contains a small amount of aged fuel. Fully refuel the car in order to dilute the aged fuel.

12.10. Refuelling

12.10.1. Handling of fuel

Do not use fuel with a lower quality than that recommended by Volvo, as this will negatively affect engine power and fuel consumption.

Warning

Always avoid inhaling fuel vapour and getting fuel splashes in the eyes.

In the event of fuel in the eyes, remove any contact lenses and rinse the eyes in plenty of water for at least 15 minutes and seek medical attention.

Never swallow fuel. Fuels such as petrol, bioethanol and mixtures of them and diesel are highly toxic and could cause permanent injury or be fatal if swallowed. Seek medical attention immediately if fuel has been swallowed.

 **Warning**

Fuel which spills onto the ground can be ignited.

Switch off the fuel-driven heater before starting to refuel.

Never carry an activated mobile phone when refuelling. The ring signal could cause spark build-up and ignite petrol fumes, leading to fire and injury.







 **Important**

Mixtures of various fuel types or use of fuels which are not recommended will invalidate Volvo's guarantees and any supplementary service agreements; this is applicable to all engines.

12.10.2. Fuel consumption and CO₂ emissions

The information in the tables below is in accordance with WLTP (Worldwide Harmonised Light-Duty Vehicles Test Procedure), which is an international test method for vehicles.

The fuel consumption for a vehicle is measured in litres per 100 km and carbon dioxide emissions (CO₂) are measured in gram CO₂ per km.









Explanation	
	Weighted combined value. The value is weighted between electric mode and fuel mode over the entire drive cycle.
CO ₂	Gram CO ₂ /km
	Litres/100 km
Range	Certified value for the car's potential range ("up to") in km in electric mode. The value should not be interpreted as an expected range, and the range is difficult to achieve during normal driving.
	Urban and suburban driving
	Average value over all four drive cycle phases (urban, suburban, extra-urban and motorway driving)
aut	Automatic gearbox
	Low value
	High value

 **Note**

If there is no consumption and emissions data in the table, this is available in an enclosed supplement.

Note

The capacity of the hybrid battery diminishes with age and use, which may result in increased use of the internal combustion engine and, as a consequence, reduced fuel economy and reduced range during electric operation.

						
			CO ₂	l/100km	Range	Range
T8 Recharge(B4204T34)	aut		57	2.5	56 ^[1]	51 ^[1]
			76	3.4	46 ^[1]	44 ^[1]

The values in the table above for fuel consumption, CO₂ emissions, and range for electric mode are based on special drive cycles (see below). The car's weight may increase depending on its equipment level. Together with how heavily the car is loaded, this affects fuel consumption and CO₂ emissions, and reduces its range in electric mode. According to WLTP, each car has unique fuel consumption, CO₂ emission values and electric range values, depending on how the car is equipped. These values range between the low value and high value in the table above. In many markets, you can find your car's unique fuel consumption, CO₂ emission values and electric range values in the car's registration document.

The certified values for the car should not be interpreted as the expected values. The certification values are the comparative values obtained during special drive cycles (see below).

There are several reasons for fuel consumption that is higher and an electric range that is shorter than the values in the table. Examples of these include:

- If the car is not regularly charged from the mains.
- If the car is equipped with extra equipment that affects its weight.
- Driving style.
- If the customer chooses wheels other than those mounted as standard on the basic version of the model, this could increase rolling resistance.
- High speed causes increased air resistance.
- Fuel quality, road and traffic conditions, weather and the condition of the car.

A combination of the examples above could increase consumption considerably.

There may be huge deviations in fuel consumption if comparing to the drive cycle profiles (see below), which are used in the certification of the car and on which consumption figures in the table are based. For further information, please refer to the referenced regulations.

Note

Extreme weather conditions, driving with a trailer or driving at high altitudes, in combination with poorer fuel quality than recommended, are factors that considerably increase the car's fuel consumption.

WLTP standard

From and including 1 September 2018, a new standard was introduced for calculating consumption values in the car. The WLTP standard (Worldwide Harmonised Light-Duty Vehicles Test Procedure) represents the average driving conditions for everyday driving. In comparison with the previous standard (NEDC), WLTP takes into account more varied traffic situations and speeds, but also equipment and weight classes. Optional equipment that affects consumption is deactivated during testing, e.g. air conditioning, seat heating, etc. The new standard should provide more realistic figures when it comes to fuel consumption, carbon dioxide and emissions, as well as range for electric operation. The values are intended to allow comparison between different cars and not to represent your typical normal consumption and range for electric mode.

Drive cycle profiles

A drive cycle simulates actual average driving of the car. The standard is based on four different drive cycle profiles, which are as follows:

- **Urban driving** – slow driving
- **Suburban driving** – average speed driving
- **Extra-urban driving** – fast driving
- **Motorway driving** – very fast driving.

Every drive cycle is determined by different conditions such as speed, time and mileage, for example.

The official value for combined driving, which is shown in the table, is a combination of the results from the four drive cycles, in accordance with legal requirements.

The exhaust gases are collected in order to extrapolate the carbon dioxide emissions (CO₂ emissions) during the four drive cycles. These were then analysed to determine the value for CO₂ emissions.

[1] Drive mode PURE

12.10.3. Petrol station

Use the car's navigation system* in order to find the route to the closest petrol station.

When stopping to refuel it is a good idea to make a general inspection of the car as well, such as checking tyre pressure, bulbs, wiper blades, topping up washer fluid, etc.

* Option/accessory.

12.10.4. Fuel tank - volume

The fuel tank's filling capacity can be read in the table below.

	All engines
Litres (approx)	70
US gallons (approx)	18.5

12.10.5. Filling fuel

The fuel tank is fitted with a coverless fuel filler system.

Refuelling the car at a petrol station

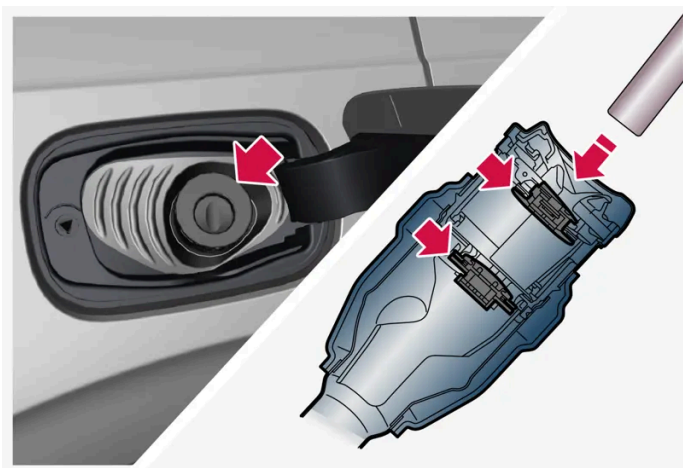

It is important to feed the pump nozzle past the filler pipe's two openable hatches before starting to fuel the car.

Fuelling instruction:

- 1 Switch off the car and open the fuel filler flap.

Note

After the fuel filler flap has been opened, refuelling must take place within about 15 minutes. After this, the valve that was opened by pressing the button to open the fuel filler cap is closed, and it is no longer possible to refuel because the pump nozzle cuts out.

If the valve is closed before refuelling is complete - press the button again and wait until the driver display shows the message **Fuel tank Ready for refuelling**.

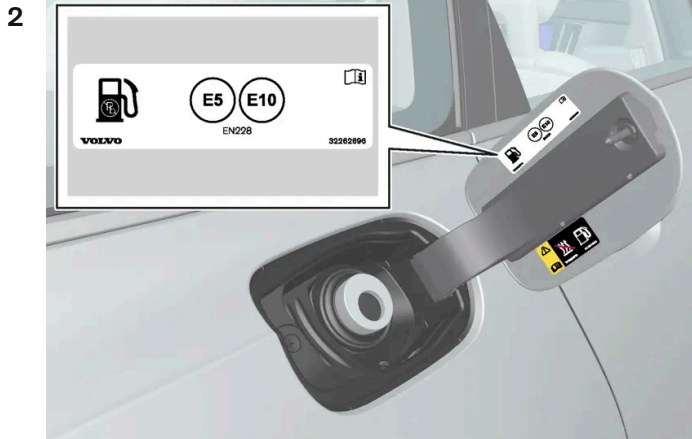

Choose fuel that is approved for use in the car in accordance with the identifier^[1] on the inside of the fuel filler flap. See information on approved fuels and identifier in the section on "Petrol".

- 3 Insert the pump nozzle in the fuel filler opening. The filler pipe has two opening caps. The pump nozzle must be pushed past both caps before refuelling is started.
- 4 Do not overfill the tank but fill until the pump nozzle cuts out the first time.
 - > The tank is full.

Note

Overfilled fuel in the tank can overflow in hot weather.

Topping up fuel from a fuel can

When filling with a fuel can, use the funnel located in the foam block under the floor hatch in the cargo area.

- 1 Open the fuel filler flap.
- 2 Insert the funnel in the fuel filler opening. The filler pipe has two opening caps. The funnel's pipe must be pushed past both caps before filling can be started.

Applicable to cars with fuel-driven auxiliary heater*

The content of this manual represents the status of the user manual at the time of printing and may not be completely valid in future instances. For more information, refer to the first page for the complete disclaimer note.

Never use the fuel-driven heater when the car is in a filling station area.

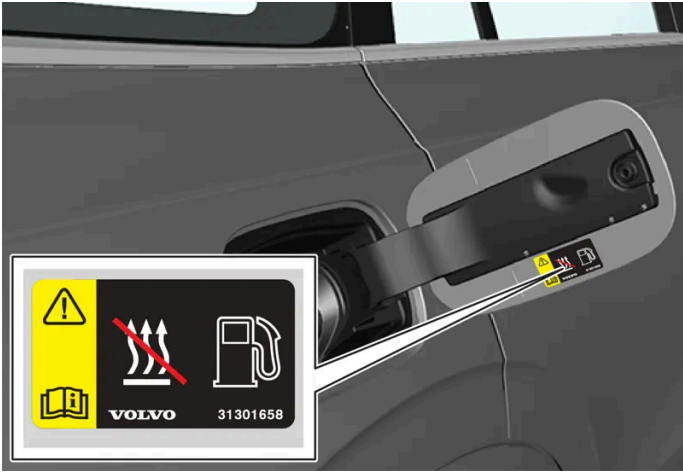

Decal on the inside of the fuel filler flap.

[1] The identifier in accordance with the CEN standard EN16942 is located on the inside of the fuel filler flap, and will be on corresponding fuel pumps and their nozzles at filling stations throughout Europe by 12 October 2018 at the latest.

* Option/accessory.

12.10.6. Opening and closing the fuel filler flap

The fuel filler flap is unlocked by pressing a button on the instrument panel.

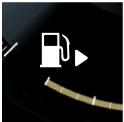

In the driver display, the arrow next to the tank symbol indicates which side of the car the fuel filler flap is located.



Press the button on the instrument panel.

- Pressure equalisation of the fuel tank involves a certain delay in opening the flap. The message **Preparing for refuel Fuel lid will be unlocked when ready** appears in the driver display, and when the system is ready the message **Fuel tank**

The content of this manual represents the status of the user manual at the time of printing and may not be completely valid in future instances. For more information, refer to the first page for the complete disclaimer note.

Ready for refuelling appears in the driver display. If the internal combustion engine is switched on when the button is pressed, it is generally switched off and the car switches to electric mode.

 **Note**

After the fuel filler flap has been opened, refuelling must take place within about 15 minutes. After this, the valve that was opened by pressing the button to open the fuel filler cap is closed, and it is no longer possible to refuel because the pump nozzle cuts out.

If the valve is closed before refuelling is complete - press the button again and wait until the driver display shows the message **Fuel tank Ready for refuelling**.

- 2 After refuelling is finished - close the flap with a gentle press.

12.11. Emission control

12.11.1. Petrol particle filter ^[1]

Petrol cars are fitted with particle filters for more efficient emission control.

Particles in the exhaust gases are collected in the petrol particle filter during normal driving. In normal driving conditions, passive regeneration takes place, which leads to the particles being oxidised and burned away. The filter is emptied in this way.

If the car is driven at low speed or with repeated cold starts in low outside temperature, active regeneration may be necessary. Regeneration of the particulate filter is automatic and normally takes 10-20 minutes. Fuel consumption may temporarily increase during regeneration.

When driving short distances at low speeds in a petrol car

The capacity of the emissions system is affected by how the car is driven. Driving varying distances and at different speeds is important in order to achieve performance that is as energy-efficient as possible.

Driving short distances at low speeds (or in cold climates) frequently, where the engine does not reach normal operating temperature, can lead to problems that can eventually cause a malfunction and trigger a warning message. If the vehicle is mostly driven in city traffic, it is important to regularly drive at higher speeds to allow the emissions system to regenerate.

- The car should be driven on A-roads at speeds in excess of 70 km/h (44 mph) for at least 20 minutes between each refuelling.



^[1] Applicable to certain variants.

12.12. Electric operation and charging

12.12.1. Charging the hybrid battery

12.12.1.1. Charging status in the car's driver display

The driver display shows the status for charging with both image and text. The information is shown for as long as the driver display is operating.

Image	Message	Specification
	Fully charged at: [Time] is shown together with an animation with blue pulsating light through the charging cable.	Charging continues and an approximate time for when the battery is estimated to be fully charged is shown.
	The text Charging complete is shown. An illustration of the car is shown with an LED indicator at the charging input socket that illuminates in green.	The battery is fully charged.
	The text Charging error is shown. The LED indicator at the charging input socket illuminates in red.	A fault has occurred, check the connection of the charging cable to the car's charging input socket and to the 230 V socket ^[1] (alternating current).

Note

If the driver display is not used for a while then it is dimmed. Reactivate the display by means of one of the following:

- depress the brake pedal
- open one of the doors
- set the car in ignition position I by turning the START knob clockwise and releasing.

^[1] The voltage in the socket may vary depending on market.

12.12.1.2. Regenerative braking*

The car recovers kinetic energy during braking in order to reduce fuel consumption and emissions.



The battery symbol is shown in the driver display when the car is generating power for the battery.

The function is available in all drive modes together with gear position D or B.

The content of this manual represents the status of the user manual at the time of printing and may not be completely valid in future instances. For more information, refer to the first page for the complete disclaimer note.

Activating brake regeneration

Brake regeneration is activated by gentle pressure on the brake pedal or during engine braking.



Regeneration increases during engine braking when manual gearshift mode **B** is selected.

* Option/accessory.

12.12.1.3. Opening and closing the hatch to the charging input socket

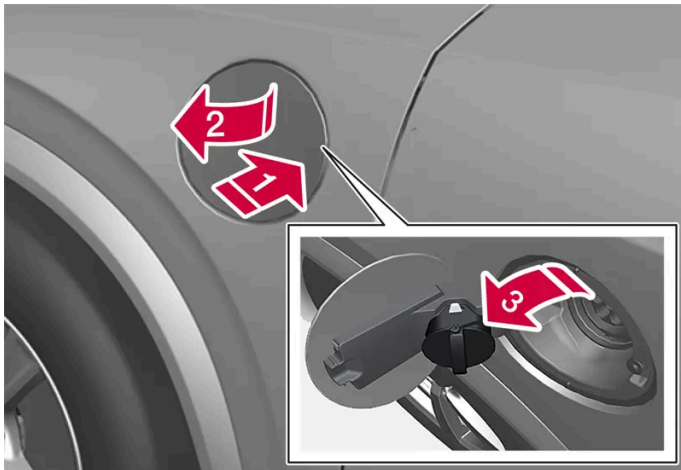
The flap for the car's charging input socket is opened manually.



- 1  Press in the rear section of the cover and release.
- 2  Open the cover.
- 3  Pull away the cover for the charging input socket and secure it in the holder inside the cover. Make sure that the cover's rubber straps are bent downwards in order to prevent the cover coming off from the holder.

Important

Position the charging input socket's cover so that it does not damage the paintwork (e.g. in blustery wind).

Close the cover for the charging input socket in reverse order.

The content of this manual represents the status of the user manual at the time of printing and may not be completely valid in future instances. For more information, refer to the first page for the complete disclaimer note.

12.12.1.4. Charging status in the car's charging input socket

The charging input socket shows the charging status using an LED lamp.

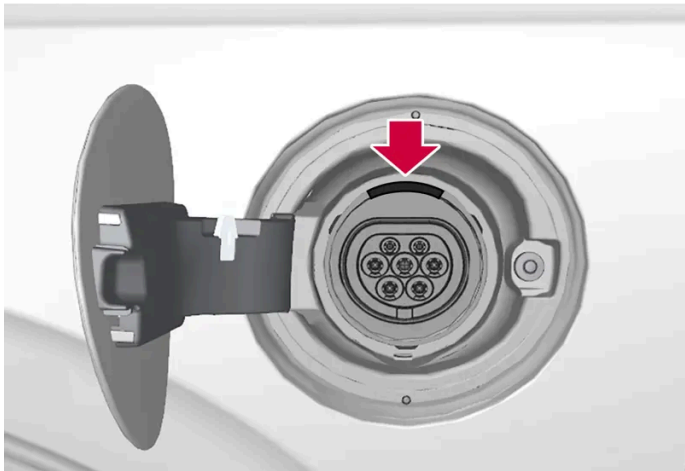

LED lamp location in the car's charging input socket.

The LED lamp shows the existing status while charging is in progress. If the LED lamp does not illuminate, check that the cable is firmly plugged into the wall socket and the socket in the car. The white, red, yellow or blue lamps are activated when the passenger compartment lighting is switched on - they remain switched on for a while after the passenger compartment lighting has been switched off.

LED lamp's glow	Specification
White	LED light
Yellow	Waiting mode ^[1] - waiting for charging to start.
Flashing green	Charging in progress ^[2] .
Green	Charging complete ^[3]
Red	A fault has arisen.
Blue	Scheduled Charging activated

^[1] For example, after a door has been opened or if the charging cable's handle is not locked in.

^[2] The slower the flashing, the closer to fully charged.

^[3] Extinguishes after a while.

12.12.1.5. Charging cable

The charging cable with its control unit is used to charge the car's hybrid battery.



The charging cable is located in the storage compartment under the cargo area's floor hatch.

 **Warning**

Only use the charging cable provided with your vehicle or a replacement cable purchased from a Volvo retailer.

Specifications, charging cable

Ambient temperature	-32 °C to 50 °C (-25 °F to 122 °F)
---------------------	------------------------------------

 **Warning**

- The charging cable has a built-in circuit breaker. Charging must only take place with grounded and approved sockets.
- Children should be supervised when in the vicinity of the charging cable when it is plugged in.
- High voltage in the charging cable. Contact with high voltage can cause death or serious personal injury.
- Do not use the charging cable if it is damaged in any way. A damaged or inoperative charging cable must only be repaired by a workshop - an authorised Volvo workshop is recommended.
- Always position the charging cable so that it will not be driven over, stepped on, tripped over or damaged in some other way, or cause personal injury.
- Disconnect the charger from the wall outlet before cleaning it.
- Never connect the charging cable to an extension cord or a multiple plug socket.
- Do not use one or more adapters between the charging cable and the electrical socket.
- Do not use an external timer between the charging cable and the electrical socket.

Also, refer to the manufacturer's instructions for using the charging cable and its components.

! Important

Multiple plugs, external timers, adapters, extension cables, overvoltage protection or similar devices must not be used together with the charging cable as this result in a risk of fire, electric shocks, etc.

An adapter between the 230 V socket (alternating current) and the charging cable may only be used if the adapter is approved in accordance with IEC 61851 and IEC 62196.

! Important

Never unplug the charging cable from the 230 V socket (alternating current) while charging is in progress - there is then a risk of damaging the 230 V socket. Always stop charging first before unplugging the charging cable from the car's charging input socket and then from the 230 V socket.

! Important

Clean the charging cable with a clean cloth, moistened with water or a mild detergent. Do not use chemicals or solvents.

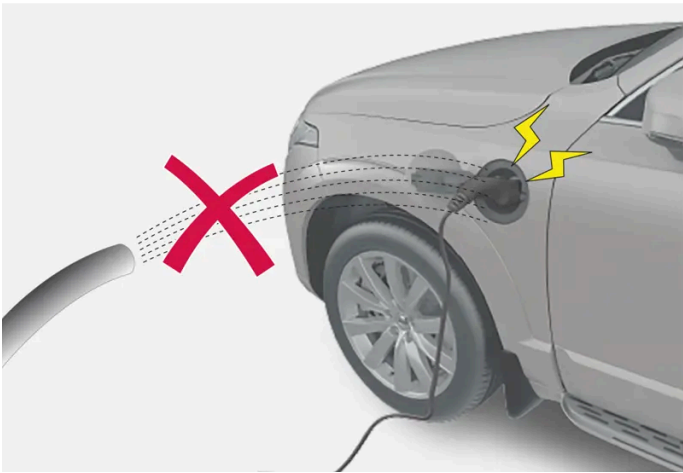

! Warning

The charging cable and its associated parts must not be swamped or immersed in water.

! Important

Avoid exposing the control unit and its plug to direct sunlight. In such cases, the overheating protection in the plug is at risk of reducing or interrupting the charging of the hybrid battery.

12.12.1.6. Ground fault breaker in charging cable

The control unit for the charging cable has a built-in ground fault breaker that protects the car and the user from electric shocks caused by system faults.

 **Warning**

Charging the hybrid battery must only take place with grounded and approved 230 V sockets (alternating current). If the capacity for the socket or fuse circuit is unknown, ask a licensed electrician to check the capacity. Charging above the capacity of a fuse circuit may lead to fire or damage the fuse circuit.

 **Warning**

- The charging cable's overvoltage protection helps to protect the car's charging system, but cannot guarantee that overload will never occur.
- Never use visibly worn or damaged electrical sockets. This could cause fire or serious injury.
- Never connect the charging cable to a cable extension.
- Maintenance or replacement of the hybrid battery must only be performed by a trained and qualified Volvo service technician.
- Do not use a charging cable that has not been recommended.
- An external timer must not be used between the charging cable and the electrical socket.
- One or more adapters must not be used between the charging cable and the power socket.

 **Important**

The ground fault breaker does not protect the 230 V socket (alternating current)/electrical installation.



Control unit LED^[1] lamp.

 LED lamp

If the control unit's built-in ground fault breaker is tripped then the LED lamp illuminates with a red constant glow - check the 230 V socket (alternating current).

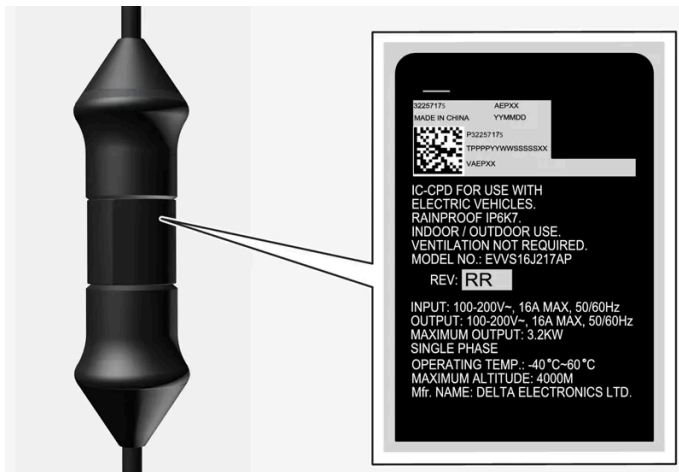

! Important

- Check the capacity of the socket.
- Other electronic equipment connected to the same fuse circuit must be disconnected if the total load is exceeded.
- Do not connect the charging cable if the socket is damaged.

^[1] LED (Light Emitting Diode)

12.12.1.7. Charging status in the charging cable's control unit

The indicator on the charging cable's control unit shows the status of ongoing charging as well as status after completed charging.

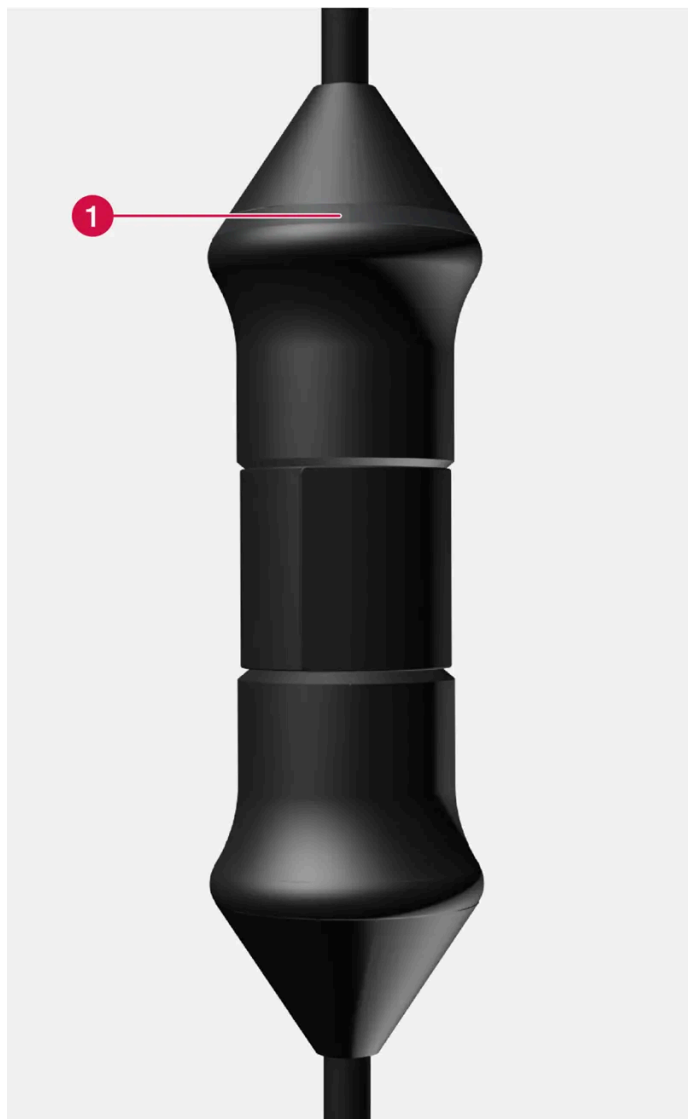

Control unit LED^[1] lamp.

1 LED lamp

LED	Status	Specification	Recommended action
Extinguished	Charging is not possible.	No power supply to charging cable.	<ol style="list-style-type: none"> 1. Unplug the charging cable from the socket. 2. Plug the charging cable into the socket again or use another socket. 3. If the problem persists – contact Volvo Support.
White light	Charging possible.	The charging cable is ready to be plugged into the car.	<p>If the LED lamp is white but charging is not possible:</p> <ol style="list-style-type: none"> 1. Unplug the charging cable from the charging input socket. 2. Plug the charging cable into the charging input socket again. 3. If the indicator does not flash white within approx. 10 seconds – first unplug the charging cable from the charging input socket and then from the power socket. Plug the charging cable into the charging input socket and the socket again. 4. If the problem persists – contact Volvo Support.
Flashes white	Charging in progress.	The car's electronics have started charging Charging in progress.	Wait until the batteries are fully charged.

LED	Status	Specification	Recommended action
Illuminates in red	Charging is not possible.	Temporary fault.	<ol style="list-style-type: none"> 1. Unplug the charging cable from the charging input socket. 2. Wait for a short time. 3. Plug the charging cable into the charging input socket again. 4. If the problem persists – contact Volvo Support.
Flashes red	Charging is not possible.	Critical fault.	First remove the charging cable from the charging input socket and then from the power outlet. If the problem persists – contact Volvo Support.

[1] LED (Light Emitting Diode)

12.12.1.8. Charging cable temperature monitoring

For the car's hybrid battery to be charged safely every time, the control unit for the charging cable and the plug have built-in monitoring devices for the temperature.

Temperature monitoring takes place in the control unit and the plug.

Note

Volvo recommends a charging cable in accordance with IEC 62196 and IEC 61851 which supports temperature monitoring.

Monitoring in the control unit

Charging is switched off if the temperature of the control unit is too high. This is to protect the electronics. This may take place at a high outside temperature, for example, and/or when strong sunlight shines directly on the control unit.

Monitoring at the plug

If the temperature at the power source to which the charging cable is connected is too high, the charging current is reduced. If the temperature exceeds a critical level, charging is stopped completely.

Important

If the temperature monitoring has automatically lowered the charging current repeatedly and charging has been interrupted then the cause of the overheating must be investigated and rectified.

12.12.1.9. Charging the hybrid battery

In addition to the fuel tank, as in a conventional car, the car is equipped with a rechargeable battery - a so-called hybrid battery of the lithium-ion type.

The hybrid battery is charged using a charging cable which is located in a storage compartment in the cargo area.

Note

Volvo recommends a charging cable in accordance with IEC 62196 and IEC 61851 which supports temperature monitoring.

The time it takes for the hybrid battery to be charged is dependent on the charging current that is used.

Note

The capacity of the hybrid battery decreases slightly with age and use, which may result in increased use of the petrol engine and thereby slightly increased fuel consumption.

Warning

Replacing the hybrid battery must only be performed by a workshop - an authorised Volvo workshop is recommended.

Charging cable handle and charging input socket



Charging cable handle and charging input socket.

Charging status is indicated in three ways:

- Indicators on the charging cable's control unit
- indicator lamp in the car's charging input socket
- image and text in the driver display.

The car's starter battery is charged when the hybrid battery is charging and charging is ended when the hybrid battery is fully charged. The starter battery is also charged while driving.

If the hybrid battery's temperature is below $-10\text{ }^{\circ}\text{C}$ ($14\text{ }^{\circ}\text{F}$) or above $40\text{ }^{\circ}\text{C}$ ($104\text{ }^{\circ}\text{F}$) then it may mean that some of the car's functions are changed or unavailable because the capacity of the hybrid batteries is reduced outside this temperature range.

Electric operation is not possible if the temperature of the battery is too low or too high. If drive mode PURE is selected, the combustion engine starts.

Decal on the inside of the charging flap



Use charging that is approved for use in the car in accordance with the identifier^[1] on the inside of the charging input socket flap.

Charging with fixed control unit in accordance with mode 3^[2]

In certain markets the control unit is installed within a charging station connected to the mains power circuit. In which case, the charging cable has no control unit of its own. Therefore, use the charging station's charging cable and follow the instructions at the charging station.

Energy recovery during braking



Indication in driver display during energy recovery.

Energy is regenerated to the battery during light pressure on the brake pedal or during engine braking.

The function is available in all drive modes together with gear position D or B.

^[1] Identifiers that comply with CEN standard EN 17186 can be found on the inside of the charging input socket flap.

^[2] European standard - EN 61851-1.

12.12.1.10. Starting hybrid battery charging

The car's hybrid battery is charged with a charging cable between the car and a 230 V socket^[1] (alternating current).

Only use the charging cable provided with your car or a replacement cable recommended by Volvo.

 **Important**

Never connect the charging cable when there is a risk of thunderstorm or lightning strike.

 **Note**

Volvo recommends a charging cable in accordance with IEC 62196 and IEC 61851 which supports temperature monitoring.

 **Warning**

- The hybrid battery must only be charged at maximum permitted charging current or lower in accordance with applicable local and national recommendations for hybrid charging from 230 V sockets (alternating current)/plugs.
- Charging the hybrid battery must only take place from an approved grounded 230 V socket^[2] or from a charging station with a loose charging cable (Mode 3) supplied by Volvo.
- The control unit's ground fault breaker protects the car, but there may still be a risk of overloading the 230 V mains power circuit.
- Avoid visible worn or damaged mains sockets since they may lead to fire damage and/or personal injury if used.
- Never use an extension cable.
- Never use an adapter or external timer.

 **Warning**

- The charging cable has a built-in circuit breaker. Charging must only take place with grounded and approved sockets.
- Children should be supervised when in the vicinity of the charging cable when it is plugged in.
- High voltage in the charging cable. Contact with high voltage can cause death or serious personal injury.
- Do not use the charging cable if it is damaged in any way. A damaged or inoperative charging cable must only be repaired by a workshop - an authorised Volvo workshop is recommended.
- Always position the charging cable so that it will not be driven over, stepped on, tripped over or damaged in some other way, or cause personal injury.
- Disconnect the charger from the wall outlet before cleaning it.
- Never connect the charging cable to an extension cord or a multiple plug socket.
- Do not use one or more adapters between the charging cable and the electrical socket.
- Do not use an external timer between the charging cable and the electrical socket.

Also, refer to the manufacturer's instructions for using the charging cable and its components.

 **Important**

Check that the 230 V socket (alternating current) has adequate power capacity for charging electric vehicles – in the event of uncertainty, the socket must be checked by a qualified professional.

Note that the car must be switched off before charging.

Take out the charging cable from the storage compartment.

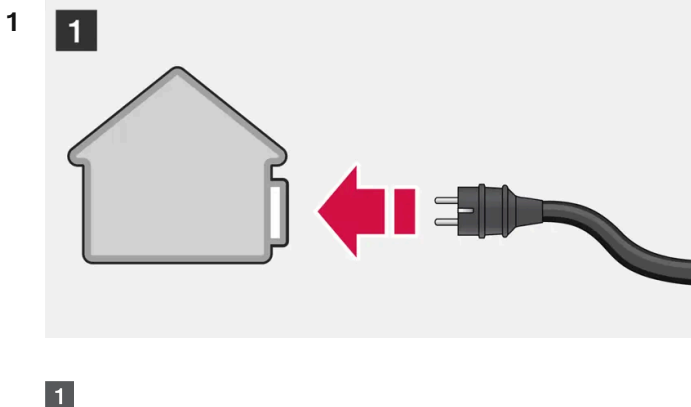

Connect the charging cable to a 230 V socket. Never use an extension cable.



2

Open the charging hatch and undo the charging input socket cover. Remove the charging handle's protective cover and then press the handle the whole way into the socket for the car.



3

Clamp the charging handle's cover in place as illustrated.

 **Important**

To avoid damage to the paint, e.g. in the event of high winds, position the charging handle's protective cover so that it does not touch the car.

4 The charging cable's charging handle is fastened/locked in, and charging starts within 5 seconds. When charging has started, the LED lamp in the charging input socket flashes with a green glow. The driver display shows the remaining estimated charging time or whether charging is not working as intended.

Battery charging can be interrupted for a while if the car is unlocked. If the charging cable is left in the charging input socket, the charge will restart again after a while.

 **Important**

Never unplug the charging cable from the 230 V socket (alternating current) while charging is in progress - there is then a risk of damaging the 230 V socket. Always stop charging first before unplugging the charging cable from the car's charging input socket and then from the 230 V socket.

Condensation from the air conditioning may drip under the car during charging. This is normal and takes place due to cooling of the hybrid battery.

[1] The voltage in the socket may vary depending on market.

[2] Or equivalent sockets with a different voltage, depending on market.

12.12.1.11. Ending hybrid battery charging

Finish charging by unlocking the car, unplugging the charging cable from the car's charging input socket and then from the 230 V socket [1] (alternating current).

Important

Before the charging cable is disconnected from the car's charging input socket, the car must be unlocked using the unlock button on the remote control key. This must be carried out even if the doors on the car are already unlocked. If the car is not unlocked using the unlock button, this may lead to damage to the charging cable or to the system.

Note

Always unlock the car so that charging is stopped before the connection to the 230 V socket (alternating current) is unplugged. Note that the charging cable must be unplugged from the car's charging input socket before being unplugged from the 230 V socket, partly to avoid damage to the system and partly to avoid stopping the charging unintentionally.



Unlock the car with the remote control key - charging is finished and the charging cable's locked handle releases/is unlocked.

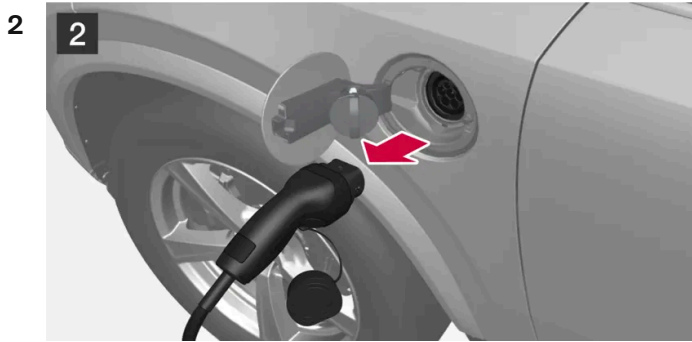

2
Unplug the cable from the car's charging input socket, refit the charging input socket's cover and close the hatch.

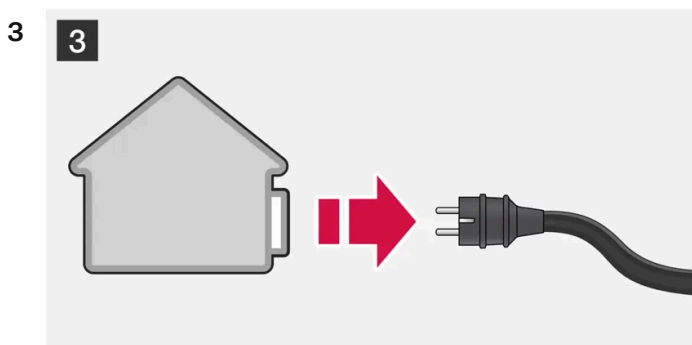

3
Unplug the cable from the 230 V socket.
Return the charging cable to the car's storage compartment.

The charging cable is locked automatically

If the charging cable is not unplugged from the charging input socket, it is locked in again automatically shortly after unlocking in order to maximise charging and range, as well as to facilitate preconditioning prior to the journey. The charging cable can be unplugged again if the car is unlocked using the remote control key. For cars with Passive Entry*, you can lock and unlock using the handle again.

^[1] The voltage in the socket may vary depending on market.

* Option/accessory.

12.12.1.12. Charging current

Charging current is used for charging the hybrid battery as well as preconditioning of the car. Charging takes place with a charging cable connected to the car's charging input socket and a 230 V socket^[1] (alternating

current).

When the charging cable is activated, the driver display shows a message and a lamp in the car's charging input socket illuminates. The charging current is mainly used for battery charging, but it is also used for preconditioning of the car. The 12V battery is also charged when the car's battery is charged.

! Important

Never unplug the charging cable from the 230 V socket (alternating current) while charging is in progress - there is then a risk of damaging the 230 V socket. Always stop charging first before unplugging the charging cable from the car's charging input socket and then from the 230 V socket.

! Important

Ensure that the wall socket fuse can handle the specified amperage for the charging cable.

i Note

- If the weather is very hot or very cold, some of the charging current is used to heat/cool the hybrid battery and the passenger compartment, which results in a longer charging time.
- The charging time is extended if preconditioning has been selected. The time required depends mainly on the outside temperature.

Charging time

Charging times may vary. The following charging times are applicable when air conditioning or any other consumer is not affecting charging. If charging time seems long, it should be investigated.

Charging times for charging with 230V	
Current intensity (A) ^[2]	Charging time (hours)
6	8
10	4
16	3

Fuse

Normally several 230 V consumers are included in a fuse circuit, so additional consumers (e.g. lighting, vacuum cleaner, electric drill, etc.) can be on the same fuse.

^[1] The voltage in the socket may vary depending on market.

^[2] Maximum charging current may vary depending on market.

12.12.2. Hybrid battery gauge

The hybrid battery gauge shows how much energy there is in the hybrid battery.

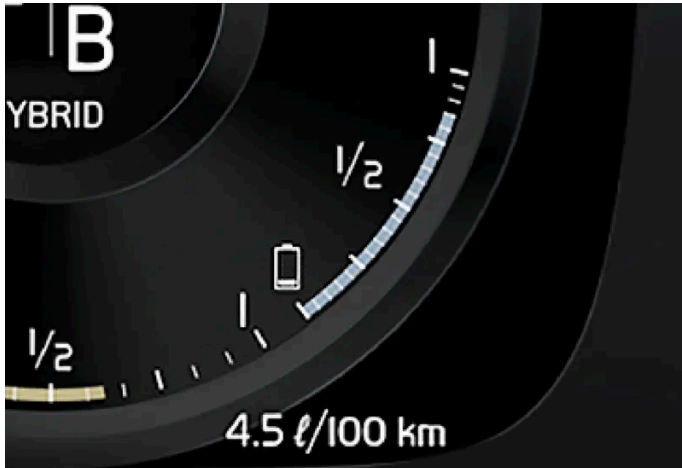

The energy in the hybrid battery is used for the electric motor, but also to cool or heat the car. The trip computer calculates an approximate distance for the energy left in the hybrid battery.

Symbols in the hybrid battery gauge

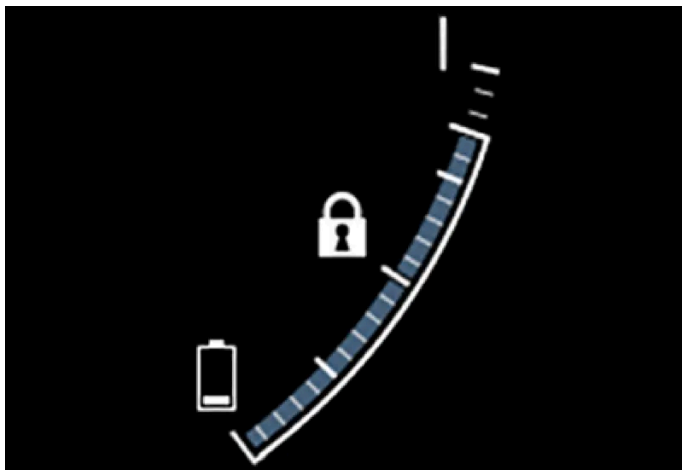

The  symbol in the hybrid battery gauge indicates that the **Hold** function is activated, and the  symbol indicates that the **Charge** function is activated.

12.12.3. Hybrid gauge

In drive modes Hybrid and Pure, the driver display shows a hybrid gauge that can help the driver to drive the car in a more energy-efficient way.

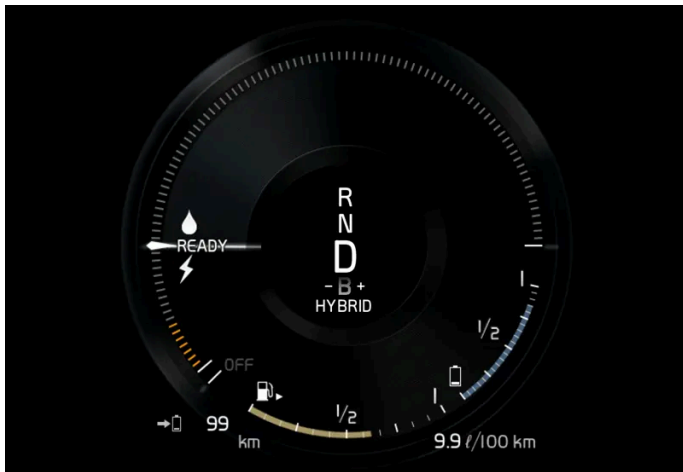

The hybrid gauge shows in different ways the relationship between how much power is being taken from the electric motor and how much power is available.

Symbols in the hybrid gauge



Indicates current level for available electric motor power. If the symbol is filled in, it means that the electric motor is in use.



If the symbol is not filled in, it means that the electric motor is not in use.



Indicates the power level when the combustion engine starts. If the symbol is filled in, it means that the combustion engine is in use.



Indicates the power level when the internal combustion engine is due to start. If the symbol is not filled in, it means that the combustion engine is not in use.



Indicator that shows that the hybrid battery is being charged e.g. if the brake pedal is gently depressed.

Driver-requested power

The pointer in the hybrid gauge indicates the amount of engine power requested by the driver by regulating the accelerator pedal. The higher the reading on the scale, the more power is requested by the driver in the current gear. The marker between the lightning flash and the drop shows the point at which the internal combustion engine starts.

Example:

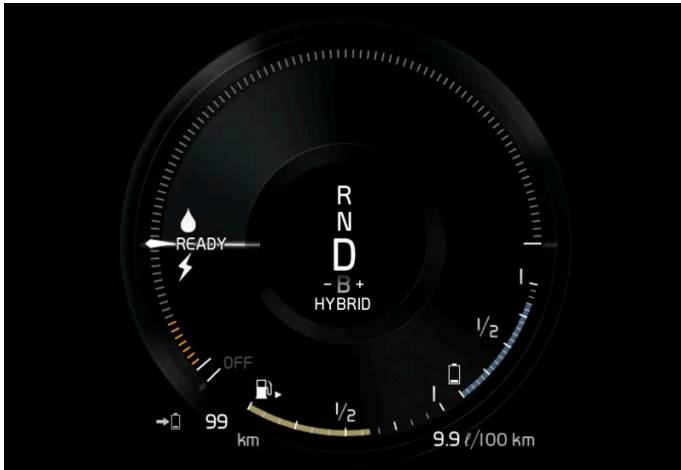

The car is started but stationary, no power is requested.

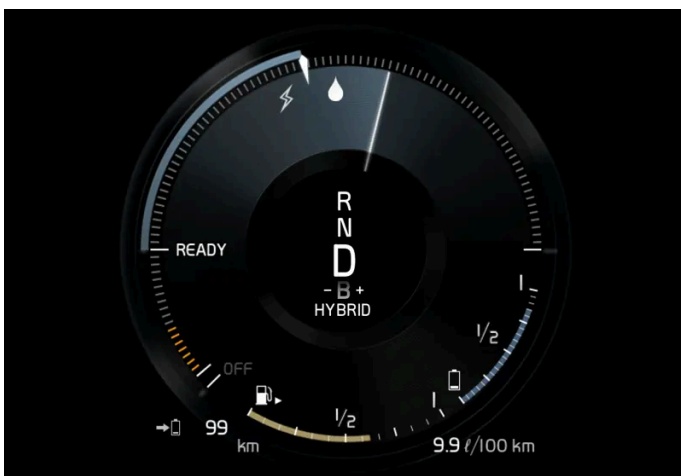

The electric motor cannot supply the amount of engine power requested and the internal combustion engine starts.

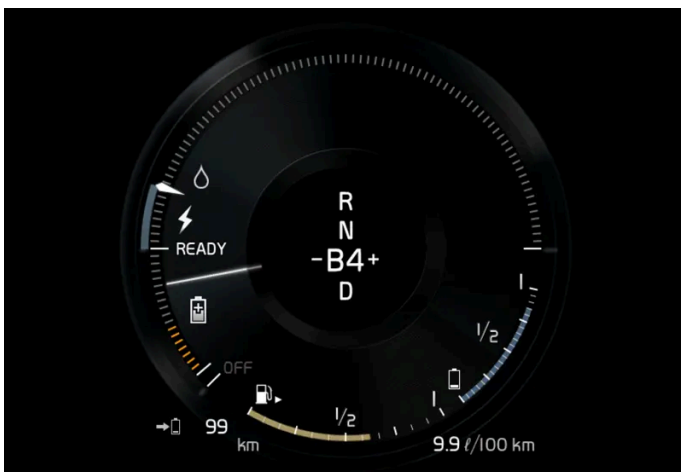

The car generates current to the battery, the battery is charged, e.g. when the brake pedal is pressed lightly or during engine braking down a hill.

12.12.4. Drive systems

The content of this manual represents the status of the user manual at the time of printing and may not be completely valid in future instances. For more information, refer to the first page for the complete disclaimer note.

The car combines an internal combustion engine that drives the front wheels with an electric motor that drives the rear wheels.

Two drive systems

Depending on the driver-selected drive mode and available electric energy, the two drive systems can be used either individually or in parallel.

The electric motor is supplied its energy from a hybrid battery fitted in the tunnel console. The hybrid battery can be charged in a wall socket, or in a special charging station. The internal combustion engine can also charge the hybrid battery with a special high-voltage generator.

Both the internal combustion engine and electric motor can generate motive force directly to the wheels. An advanced control system combines the properties of both drive systems in order to provide optimum driving economy.

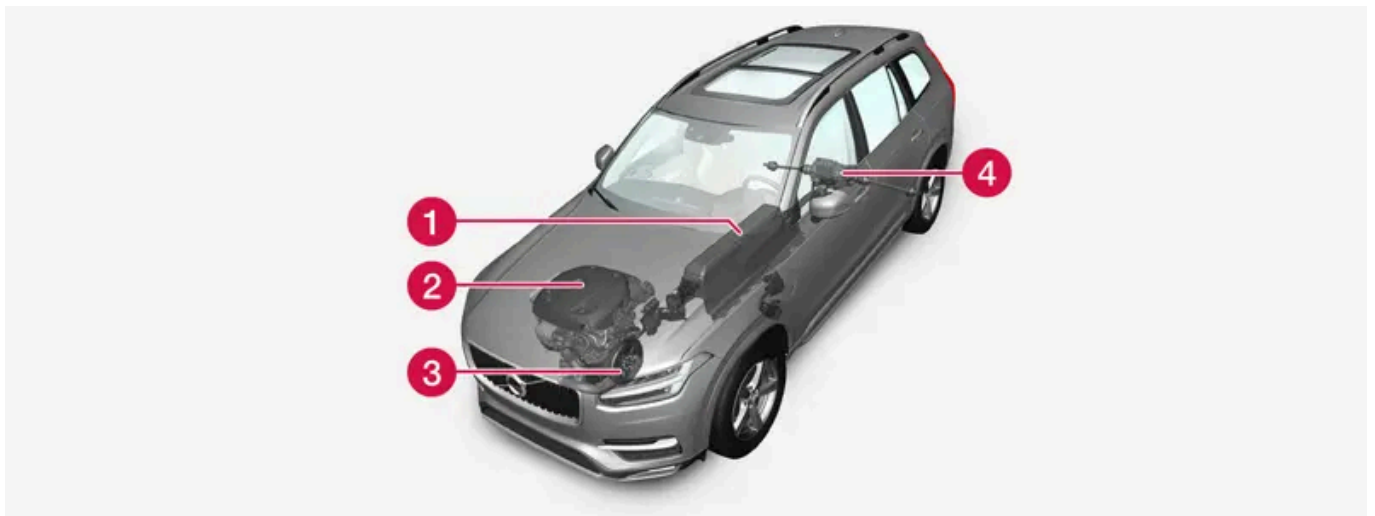

- 1 Hybrid battery - The function of the hybrid battery is to store energy. It receives energy when charging from the mains power circuit, during regenerative braking or from the high-voltage generator. It provides energy for electric operation as well as for temporarily operating the electric air conditioning during the preconditioning of the passenger compartment.
- 2 Internal combustion engine - The internal combustion engine starts when the energy level in the hybrid battery is insufficient for the engine power that the driver requests.
- 3 High voltage generator^[1] - Charges the hybrid battery. Starter motor for the internal combustion engine. Can support the internal combustion engine with extra electrical energy.
- 4 Electric motor - Powers the car in electric operation. If necessary, provides extra torque and power during acceleration. Provides electrical all-wheel drive functionality. Recycles brake energy to electrical energy.

^[1] CISG (Crank Integrated Starter Generator) - Combined high-voltage generator and starter motor.

12.12.5. Hold and Charge

In some situations, it can be useful to be able to control the hybrid battery's state of charge while driving is in progress. This is possible with the functions **Hold** and **Charge**.

Hold and **Charge** are available in all drive modes. The functions are cancelled if **Pure** drive mode is activated.

Activating Hold and Charge

The functions are activated in the centre display's function view.

Hold



Battery level sustained for later use.

The function maintains the charge in the hybrid battery for electric drive and saves available electricity for later use e.g. for driving in an urban environment.

The car works as for normal hybrid operation with discharged battery where, in addition to re-using brake-generated energy, for example, the car starts the internal combustion engine more often in order to maintain the charge in the battery.

Charge



Engine charges hybrid battery.

The function charges the hybrid battery with assistance from the internal combustion engine for using increased electric operation at a later time.

Symbols in the driver display



The symbol  is shown in the hybrid battery gauge when Hold is activated.

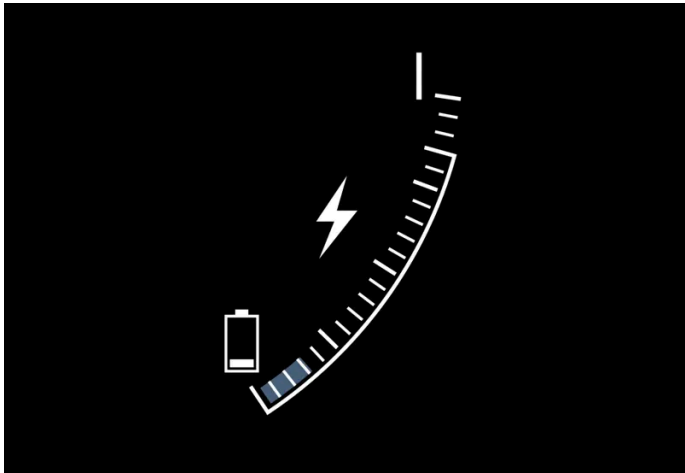

The symbol  is shown in the hybrid battery gauge when Charge is activated.

12.12.6. Drive modes

Selection of drive mode affects the car's driving characteristics in order to enhance the driving experience and facilitate driving in special situations.

Using the drive modes it is possible to quickly have access to the car's numerous functions and settings for different driving needs. Each drive mode is adapted to provide optimum driving characteristics:

- Steering
- Engine/gearbox/all-wheel drive
- Brakes
- Level control* and shock absorption
- Driver display
- Climate settings

Select the drive mode adapted for the current driving conditions. Remember that not all drive modes are available in all situations.

Selectable drive modes

 **Warning**

Remember that the car does not emit any engine noise when it is only powered by the electric motor and may therefore be difficult to notice by children, pedestrians, cyclists and animals. This applies in particular at low speeds such as in car parks.

 **Warning**

Do not leave the car in an unventilated area with activated drive mode and the fuel-driven engine switched off - automatic engine start occurs at low energy level in the hybrid battery, and the exhaust gases could then cause serious injury to people and animals.

Hybrid

- This is the car's normal mode where the electric motor and internal combustion engine work together.

When the car starts, it is in the **Hybrid** mode. The control system uses both the electric motor and internal combustion engine – individually or in parallel – and adapts use with regard to performance, fuel consumption and comfort. At higher speeds the ground clearance is adjusted automatically to a lower level^[1] in order to reduce wind resistance. The capacity to run solely with the electric motor depends on the hybrid battery's energy level and, for example, the need for heating or cooling in the passenger compartment.

If high power output is available, it is possible to drive with electrical power alone. When the accelerator pedal is depressed, only the electric motor is activated until a certain position is reached. The internal combustion engine starts when this position is exceeded and the energy level in the battery is insufficient for the engine power that the driver requests with the accelerator pedal.

At low energy level (hybrid battery almost empty) the battery's energy level must be maintained, leading to the internal combustion engine starting more often. Charge the hybrid battery from a 230 VAC socket with the charging cable, or activate **Charge** in the function view in order to restore the capacity to run on electricity alone.

The drive mode is designed for low energy consumption with a mix of the electric motor and the internal combustion engine, without compromising the climate comfort and driving experience. When higher acceleration is required, maximum additional power from the electric drive line is used.

The car also senses if the driving conditions require all-wheel drive and automatically engages it if necessary. All-wheel drive and electric additional power are always available regardless of the battery's state of charge.

Information in the driver display

When driving in hybrid mode the driver display shows a hybrid gauge. The pointer in the hybrid gauge indicates how much energy the driver requests with the accelerator pedal. The marking between the lightning bolt and the drop shows how much energy is available.

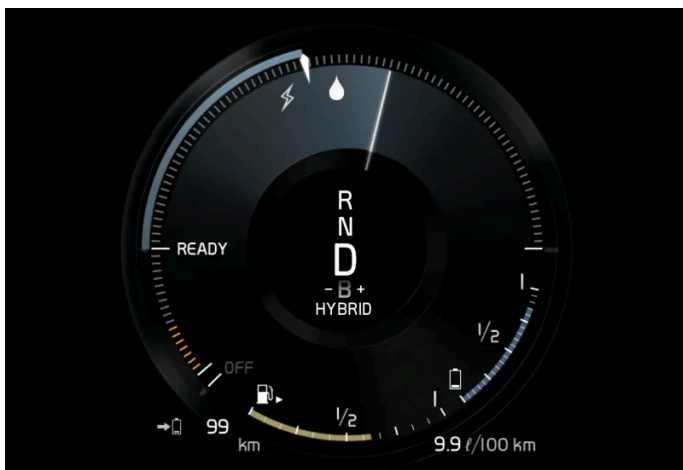

The driver display for propulsion with both the electric motor and internal combustion engine.



The driver display also shows when energy is returned to the battery (regenerated) during light braking.

Pure

- Drive the car with electric motor, with energy consumption as low as possible and with lowest possible carbon dioxide emissions.

The drive mode prioritises driving on the hybrid battery. This means, for example, that the ground clearance is lower^[1] to reduce wind resistance and the output of certain climate settings is reduced to provide the longest possible mileage range on electric power alone.

The **Pure** mode is available when the hybrid battery has a sufficiently high State of Charge (SoC) and available power output, which may be affected by temperature. When the internal combustion engine starts, the drive mode automatically changes to the **Hybrid** mode until the driver has the opportunity to select the **Pure** mode again.

The internal combustion engine starts:

- if the battery's State of Charge (SoC) is too low
- if the driver fully depresses the accelerator pedal.

The **Pure** mode is not available:

- if the battery's State of Charge (SoC) is too low
- if the speed exceeds 140 km/h(87 mph) (does not apply when driving downhill, etc.)
- in the event of system/component limitations e.g. low outside temperature.

Note

The internal combustion engine may start temporarily in certain driving situations when the **Pure** drive mode is in use. This is in order to provide the wheels with the desired torque in driving situations that require higher load, e.g. when driving with a trailer or on an uphill gradient.

The drive mode is adapted for maximum range with electric propulsion and especially developed for urban traffic. **Pure** means lowest combustion even when the hybrid battery is empty. The climate in the passenger compartment is regulated to Eco climate, and in slippery driving conditions, more wheel spin can be permitted before all-wheel drive is activated automatically.

ECO climate control

In the **Pure** drive mode, eco climate control is activated automatically in the passenger compartment in order to reduce energy consumption.

 **Note**

When the **Pure** drive mode is activated, several parameters in the climate control system's settings are changed, and several electricity consumer functions are reduced. Certain settings can be reset manually, but full functionality is only regained by leaving **Pure** drive mode or adapting **Individual** drive mode with full climate functionality.

In the event of difficulties due to misting, press the button for max. defroster which has normal functionality.

Off Road

- Prioritise the car's traction when driving in difficult terrain and on poor roads.

The drive mode provides high ground clearance^[1], steering is light, all-wheel drive and the function for low speed control with hill descent control (Hill Descent Control) are activated.

The drive mode is only available at low speeds, up to 40 km/h (25 mph). If this speed is exceeded, **Off Road** mode is cancelled and the **Constant AWD** drive mode is activated instead.

To be able to drive all four wheels, the internal combustion engine and electric motor run continually, which results in increased fuel consumption.

In the **Off Road** mode the driver display has a compass between the speedometer and tachometer. The speedometer shows the range for speed limitation.

The drive mode is adapted for maximum controllability at low speeds in poor road conditions or difficult terrain. It raises the chassis^[1], reduces the driveline's throttle response and locks the car in all-wheel drive. The Hill Descent Control function facilitates controlled driving on steep descents.

 **Note**

The driving mode is not designed to be used on public roads.

 **Note**

If the car is switched off in **Off Road** mode, and therefore has high ground clearance, the car is lowered next time it is started.

 **Important**

The **Off Road** drive mode must not be used while driving with a trailer without trailer connector. Otherwise, there is a risk of damage to the air bellows.

Constant AWD

- Improve the car's roadholding and traction with enhanced all-wheel drive.

The drive mode locks the car in all-wheel drive. An adapted distribution between the front and rear axle torque provides good traction, stability and roadholding, for example on slippery roads, when driving with a heavy trailer, or when towing. **Constant AWD** drive mode is always available regardless of the battery's state of charge.

Both the internal combustion engine and electric motor are engaged in order to drive all four wheels, which results in increased fuel consumption.

In the car's other drive modes, the car automatically adapts the need for all-wheel drive to the road surface, and can engage the electric motor or start the internal combustion engine when necessary.

Power

- The car has sportier characteristics and faster response to accelerating.

The drive mode adapts the combined power from the internal combustion engine and electric motor by means of the car being driven by both front and rear wheels. The gear changes become faster and more distinct, and the gearbox prioritises a gear with greater traction. Steering response is faster, shock absorption is harder and a lower ground clearance^[1] means that the body follows the roadway in order to reduce roll during cornering.

Both the internal combustion engine and electric motor are engaged in order to drive all four wheels, which results in increased fuel consumption.

The drive mode is adapted for maximum performance and response on acceleration. It changes the internal combustion engine's accelerator pedal response, gear shift pattern and boost pressure system. Chassis settings, steering and brake response are also as good as possible. **Power** drive mode is always available regardless of the battery's state of charge.

The **Power** mode is also available in the **Polestar Engineered** version*.

Individual

- Adapting a drive mode according to individual preferences.

Select a drive mode to start from, and then adjust the settings according to the desired driving characteristics. These settings are saved in an individual driver profile.

An individual drive mode is only available if it is first activated in the centre display.

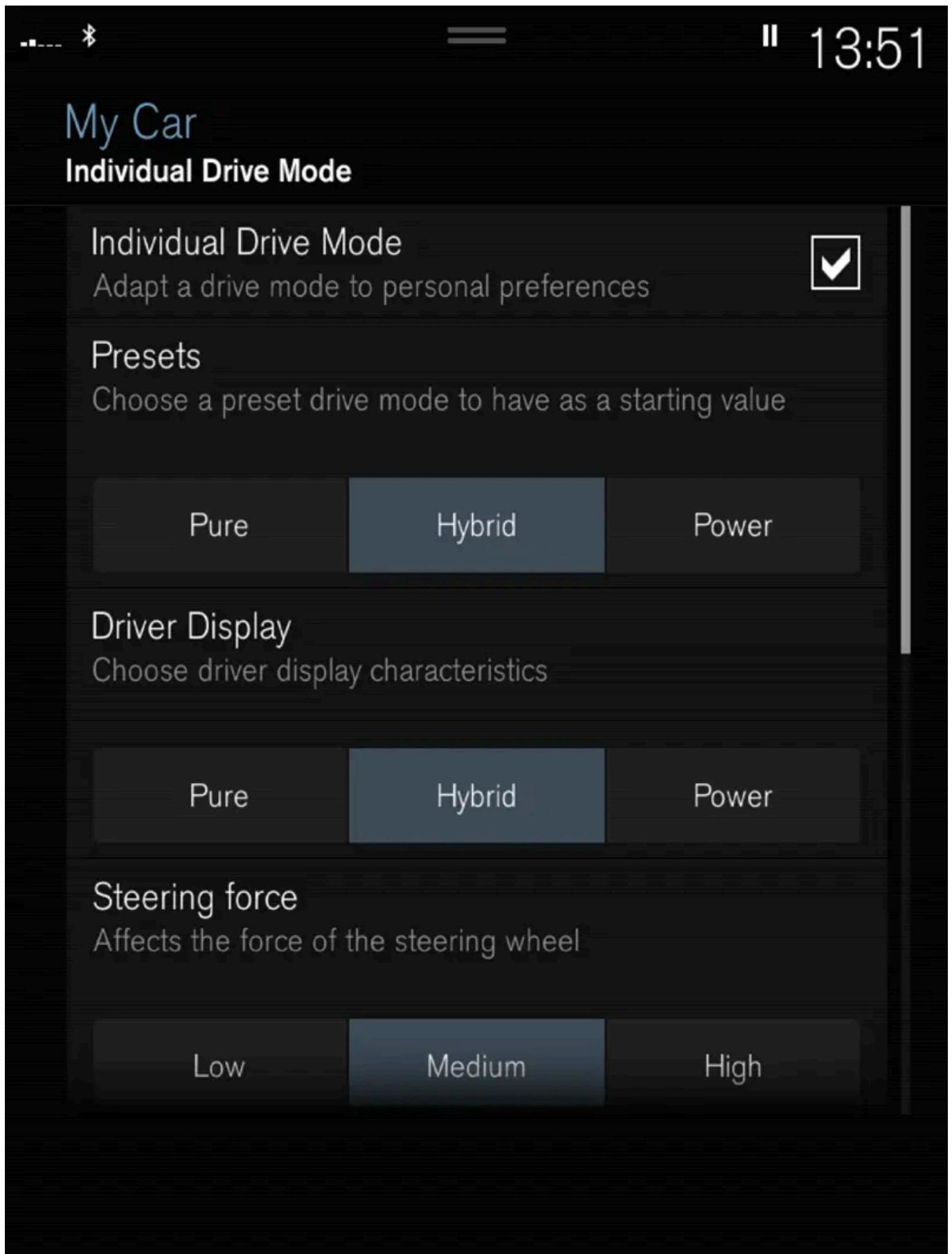

Settings view^[2] for individual drive mode.

- 1 Press **Settings** in the top view.

The content of this manual represents the status of the user manual at the time of printing and may not be completely valid in future instances. For more information, refer to the first page for the complete disclaimer note.

2 Press **My Car** → **Individual Drive Mode** and select **Individual Drive Mode**.

3 In **Presets**, select a drive mode to start from: **Pure**, **Hybrid**, **Power** or **Polestar Engineered***.

Possible adjustments apply to settings for:

- **Driver Display**
- **Steering Force**
- **Powertrain Characteristics**
- **Brake Characteristics**
- **Suspension Control**
- **ECO Climate**

Using the electric motor or internal combustion engine

An advanced control system determines the extent to which the car is driven on internal combustion engine, electric motor or both in parallel.

The primary function is to use the engine or motor and the available energy in the hybrid battery as efficiently as possible, with regard to the characteristics of the different drive modes as well as the driver's request for power via the accelerator pedal.

There are also cases where temporary limitations in the system, or functions governed by legal requirements aimed at maintaining a low level of total emissions for the car, may use the internal combustion engine to a greater extent.

* Option/accessory.

^[1] Applies with air suspension.

^[2] The figure is schematic - parts may vary depending on car model.

12.12.7. General information on electric drive

The hybrid car runs like a regular car, but certain functions differ from a car that only runs on petrol or diesel. The electric motor drives the car mostly at low speeds, the petrol engine at higher speeds, as well as during more active driving.

The driver display shows some information that is unique to the Recharge - charging information, selected drive mode, distance to empty battery as well as the hybrid battery's charge level.

It is possible to set the car in different drive modes while driving, e.g. electric operation only or, when power is required, both electric motor and petrol engine. The car calculates a combination of drivability, driving experience, environmental impact and fuel economy according to the drive mode selected.

In order that the car should have optimal function it is important that the hybrid battery with associated electrical drive systems, as well as the petrol engine and its drive systems, have the correct operating temperature. Battery capacity may be reduced considerably if the battery is too cold or too hot.

Preconditioning prepares the car's drive systems and the passenger compartment before departure so that both wear and energy needs during the journey are reduced. Connecting the car to charging while preconditioning is in progress can increase the range for the hybrid battery.

The hybrid battery which drives the electric motor is charged via a charging cable but can also be charged by gentle braking and engine braking in gear position B. The hybrid battery can also be charged by the car's engine.

Important to know

Warning

Charging the car can affect the function of an implanted pacemaker or other medical equipment. People with an implanted pacemaker are recommended to consult a doctor before starting charging.

Car without power

Bear in mind that important functions such as the servo brakes and power steering are limited when the car is without power.

Warning

The brake servo only works when the electric motor or internal combustion engine is running.

Towing not permitted

Towing the car is not permitted since this damages the electric motor.

Exterior engine noise

Warning

Remember that the car does not emit any engine noise when it is only powered by the electric motor and may therefore be difficult to notice by children, pedestrians, cyclists and animals. This is especially true at low speeds, such as in car parks.

High-voltage current











Warning

Several components in the car work with high-voltage current that could be dangerous in the event of incorrect intervention. These components, and all orange-coloured cables, must only be handled by qualified personnel.

Do not touch anything that is not clearly described in the owner's manual.

12.12.8. Symbols and messages relating to hybrid drive in the driver display

A number of symbols and messages regarding hybrid drive can be shown in the driver display. They may also be shown in combination with general indicator and warning symbols and are then extinguished when the problems have been rectified.

Symbol	Message	Specification
	12 V Battery Charging fault, service urgent. Drive to workshop	Fault in the 12V battery. Contact a workshop ^[1] to check the battery as soon as possible.
	12 V Battery Charging fault Stop safely	Fault in the 12V battery. Stop the car safely and contact a workshop ^[1] to have the battery checked as soon as possible.
	12 V Battery Fuse failure Service required	Fault in the 12V battery. Contact a workshop ^[1] to check the function as soon as possible.
	HV battery Overheated, stop safely	The temperature of the hybrid battery seems to be rising abnormally. Stop the car and switch off the engine. Wait at least 5 minutes before continuing to drive. Call a workshop ^[1] or check from the outside that everything seems normal before continuing to drive.
	Reduced performance Max car speed limited	The hybrid battery is not sufficiently charged for driving at high speeds. Charge the battery as soon as possible.
	Propulsion system Harsh behaviour at low speed, car ok to use	The hybrid system does not function as intended. Contact a workshop ^[1] to check the function as soon as possible.
	Hybrid system failure Service required	The hybrid system is disengaged. Contact a workshop ^[1] to check the function as soon as possible.
	Charge cable Remove before start	Shown when the driver tries to start the car and the charging cable is connected to the car. Disconnect the charging cable and close the charging hatch.

^[1] An authorised Volvo workshop is recommended.

12.12.9. Long-term storage of cars with hybrid batteries

To minimise the risk of damage to the hybrid battery during long-term storage (longer than 1 month) it is recommended that the state of charge (SoC) is maintained at approximately 25%. Check the charge level in the driver display on a regular basis.

Before long-term storage

Recommended state of charge (SoC) for long-term storage is approximately 25%.

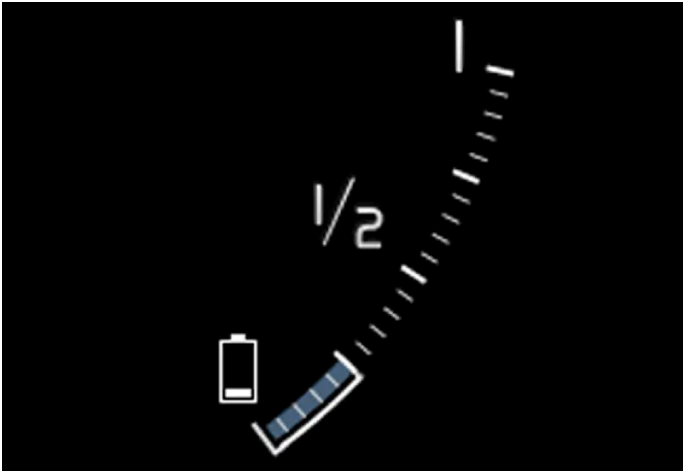

- If the state of charge (SoC) is high – drive the car until it reaches the recommended level.
- If the state of charge (SoC) is low – charge the car to the recommended level.

During long-term storage

Check the state of charge (SoC) in the driver display on a regular basis.

Charge the car if the state of charge (SoC) has fallen noticeably, or if it has not been charged for longer than 6 months. This compensates for the natural self-discharge of the battery.

i Note

Store the car in a cool place and avoid extreme temperatures during long-term storage in order to minimise the risk of battery damage. Select a storage location indoors or in the shade, depending on where the temperature is lowest, particularly in a hot climate.

12.12.10. Range in electric mode

The car's range depends on several factors. The ability to achieve a long range varies according to the circumstances and conditions under which the car is being driven.

The certified value for the car's mileage should not be interpreted as an expected range. The certified value should primarily be used to compare different cars and is obtained during special test cycles.

Range in the driver display



When the car is delivered from the factory, or after a factory reset, the range is based on the certified value.

When the car has been driven for a while, the range is based on historical driving patterns. The amount of history used depends on the battery's state of charge. Therefore, the less charge there is in the hybrid battery, the faster the range adapts to a changed driving pattern.

Factors that affect the range

In addition to historical trip data, there are several different factors that affect the range. The longest range is achieved under extremely favourable conditions when all factors have a positive impact.

Examples of factors that affect the range:

- speed
- climate settings
- topography
- preconditioning
- tyres and tyre pressure
- traffic situation
- temperature and weather
- road conditions.

Range based on speed and outside temperature

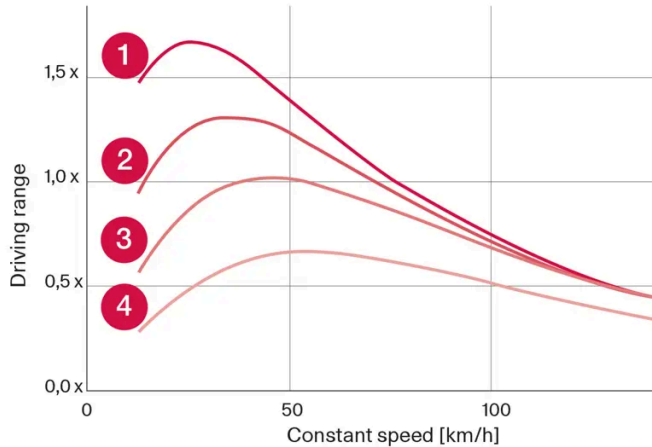

- 1 20 °C (68 °F) outside temperature and passenger compartment climate Off.
- 2 0 °C (32 °F) outside temperature and passenger compartment climate On.
- 3 35 °C (95 °F) outside temperature and passenger compartment climate On.
- 4 -10 °C (14 °F) outside temperature and passenger compartment climate On.

The graph shows the approximate relationship between constant speed and range, where a lower constant speed has a positive effect on range.

A higher outside temperature and deactivated climate control are also more beneficial for the range.

12.12.11. Economical driving

To achieve the longest possible range, the driver should plan driving and adapt driving style and speed to the prevailing situation.

Before driving

- Precondition the car before driving if possible using the charging cable connected to the mains power circuit.
- If preconditioning is not possible when it is cold outside, use seat heating and steering wheel heating first of all. Avoid warming up the whole of the interior which takes energy from the hybrid battery.
- Choice of tyres and tyre pressure can affect energy consumption - seek advice on suitable tyres from an authorised Volvo dealer.
- Remove unnecessary items from the car - the greater the load the higher the consumption.

While driving

- Activate drive mode **Pure**.
- Activate the **Hold** function at higher speeds during journeys that are longer than the range of the electricity.
- If possible, avoid using the **Charge** function to charge the hybrid battery.
- Drive at a steady speed and keep a good distance to other vehicles and objects in order to avoid braking.

The content of this manual represents the status of the user manual at the time of printing and may not be completely valid in future instances. For more information, refer to the first page for the complete disclaimer note.

- The hybrid battery is recharged during braking by braking gently with the brake pedal.
- High speed results in increased energy consumption since the wind resistance increases with speed.
- In a cold climate, reduce electrical heating of windows, mirrors, seats and steering wheel, if possible.
- Avoid driving with open windows.
- Do not hold the car stationary on a hill with the accelerator pedal. Instead, activate the function for braking when stationary.
- If possible, deactivate the climate control while driving a short distance after preconditioning.

After driving

- If possible, park in an acclimated garage with charging facilities.

12.12.12. Recycling the batteries

Used batteries must be recycled in an environmentally sound manner.

Consult a workshop in the event of uncertainty about how this type of waste should be discarded - an authorised Volvo workshop is recommended. The hybrid battery must only be handled by authorised workshop personnel.

12.12.13. Hybrid battery

The car is equipped with a hybrid battery for electric motor operation - a maintenance-free rechargeable Lithium-ion type battery.

Note

The car cannot be started if the hybrid battery is discharged.

If both the starter battery and the hybrid battery are discharged then both batteries must be charged. In such a case, charging only the hybrid battery is not possible. In order for the hybrid battery to be charged, the starter battery must have a certain state of charge.

Warning

The hybrid battery must only be replaced by a workshop - an authorised Volvo workshop is recommended.

The service life and capacity of the hybrid battery

The capacity of the hybrid battery diminishes with age and use, which may result in increased use of the internal combustion engine and, as a consequence, reduced fuel economy and reduced range during electric operation.

Coolant

The hybrid battery's cooling system has a separate expansion tank.

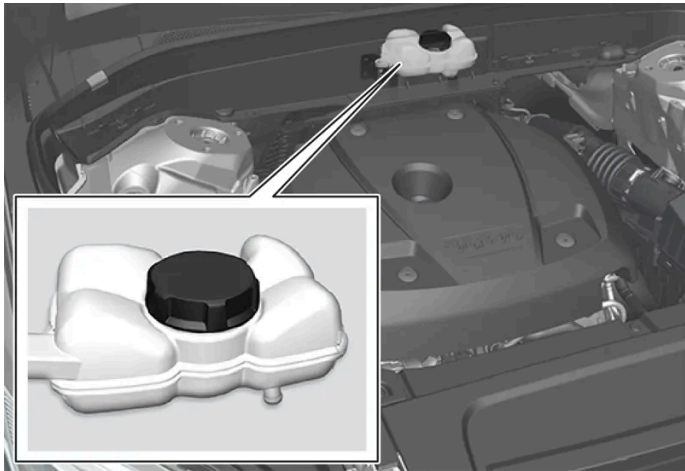

Important

The hybrid battery's coolant must only be topped up by a workshop - an authorised Volvo workshop is recommended.

Specifications for hybrid battery

Type: Lithium-ion

Total amount of energy: 11.6 kWh.

12.13. HomeLink

12.13.1. HomeLink[®] * [\[1\]](#)

HomeLink[®] [\[2\]](#) is a programmable remote control integrated into the car's electrical system.

It can control up to three different devices remotely, e.g. a garage door opener or alarm system, and hence replace the remote controls for these.

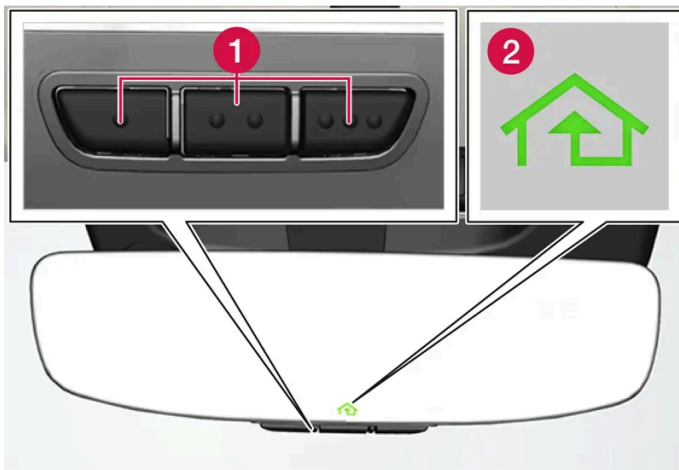

The figure is schematic - the version may vary.

- 1 Programmable buttons
- 2 Indicator lamp

HomeLink[®] is built into the interior rearview mirror and consists of three programmable buttons and one indicator lamp in the mirror glass.

Note

Save the original remote controls for future reprogramming (e.g. when changing to another car or for use in another vehicle).

It is also recommended that the programming for the buttons should be deleted when the car is sold.

More information

Visit homelink.com or call 00 8000 466 354 65 (or premium charge number +49 6838 907 277)^[3].

* Option/accessory.

^[1] Applies to certain markets.

^[2] HomeLink and the HomeLink house symbol are registered trademarks of Gentex Corporation.

^[3] Note that the toll-free number may not be available depending on operator.

12.13.2. Using HomeLink[®] * ^[1]

When HomeLink[®] is fully programmed it can be used in place of the separate original remote controls.

Depress the programmed button. The garage door, gate, alarm system or similar is activated (may take a few seconds). If the button is depressed for more than 20 seconds then the reprogramming is started. The indicator lamp illuminates or flashes

The content of this manual represents the status of the user manual at the time of printing and may not be completely valid in future instances. For more information, refer to the first page for the complete disclaimer note.

when the button has been depressed. Naturally the original remote controls can still be used in parallel with HomeLink® if required.

 **Note**

When the ignition has been switched off, HomeLink® works for at least 7 minutes.

 **Note**

HomeLink® cannot be used if the car is locked and the alarm is armed* from the outside.

 **Warning**

- If HomeLink® is used to control a garage door or gate, ensure that nobody is near the door or gate while it is in motion.
- Do not use HomeLink® for any garage door that does not have safety stop and safety reverse.

* Option/accessory.

[1] Applies to certain markets.

12.13.3. Programming HomeLink® * [1]

Program HomeLink®, reset programming or reprogram individual buttons.

Programming

- 1 Aim the remote control towards the HomeLink® button to be programmed and hold it approx. 2-8 cm (approx. 1-3 inches) from the button. Do not obstruct the indicator lamp on HomeLink®.
 - 2 Press and hold depressed both the button on the remote control and the button to be reprogrammed on HomeLink®.
 - 3 Do not release the buttons until the indicator lamp has switched from flashing slowly (approx. once per second) to either flashing quickly (approx. 10 times per second) or illuminating with a constant glow.
- **If the indicator lamp illuminates with a constant glow:** Indication that the programming has finished. Press the programmed button twice to activate.
- If the indicator lamp flashes quickly:** The device to be programmed to HomeLink® may have a security function that requires extra steps.

Test by pressing the programmed button twice to see whether the programming is working. Otherwise, continue with the following steps.

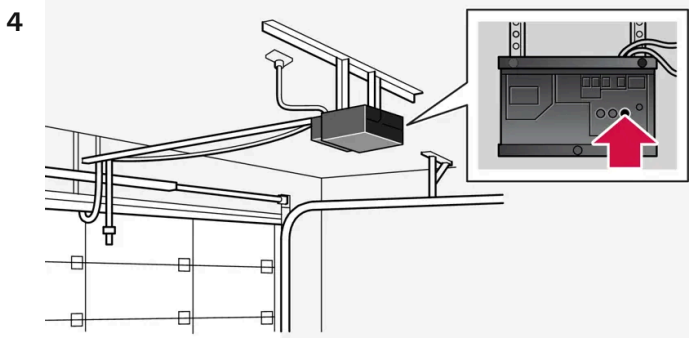

Locate programming button ^[2] on the receiver for the garage door or similar. It is normally located close to the antenna's bracket on the receiver.

5 Depress and release the receiver's programming button once.

The programming must be completed within 30 seconds of the button being depressed.

6 Press and release the button on HomeLink[®] that you want to program. Repeat the sequence of pressing/holding/releasing a second time and, depending on the receiver model, even a third time.

➤ Programming is finished.

i Note

The ability of some remote controls to program HomeLink[®] is improved at a distance of approx. 15–20 cm (approx. 6–12 inches).

Reprogramming individual buttons

1 Press the desired button and hold it depressed for approx. 20 seconds.

2 Once the indicator lamp on HomeLink[®] starts to flash slowly, programming can continue as normal.

i Note

If the button to be reprogrammed is not programmed with a new unit, it will resume the previously saved programming.

Resetting the HomeLink[®] buttons

It is only possible to reset all HomeLink[®] buttons at the same time. Individual buttons can only be reprogrammed.

1 Press and hold depressed the outer buttons on HomeLink® for approx. 10 seconds.

> When the indicator lamp changes over from a constant glow to starting to flash, the buttons are reset and ready to be reprogrammed.

Problems with programming

Visit homelink.com or call 00 8000 466 354 65 (or premium charge number +49 6838 907 277) ^[3].

* Option/accessory.

^[1] Applies to certain markets.

^[2] Button designation and colour varies between manufacturers.

^[3] Note that the toll-free number may not be available depending on operator.

12.13.4. Type approval for HomeLink® * ^[1]

The type approval for HomeLink® can be read below.

Country/Area	Type approval
USA and Canada	This device complies with FCC rules part 15 and Industry Canada RSS-210. Operation is subject to the following two conditions: (1) This device may not cause harmful interference, and (2) This device must accept any interference that may be received including interference that may cause undesired operation.
Europe	Gentex Corporation hereby declares that HomeLink® Model UAHL5 complies with the Radio equipment directive 2014/53/EU. Wavelength within which the radio equipment functions: <ul style="list-style-type: none">• 433.05MHz-434.79MHz <10mW E.R.P.• 868.00MHz-868.60MHz <25mW E.R.P.• 868.70MHz-868.20MHz <25mW E.R.P.• 869.40MHz-869.65MHz <25mW E.R.P.• 869.70MHz-870.00MHz <25mW E.R.P. Certificate holder address: Gentex Corporation, 600 North Centennial Street, Zeeland MI 49464, USA

* Option/accessory.

^[1] Applies to certain markets.

12.14. Compass

12.14.1. Compass*

The upper right-hand corner of the rearview mirror has an integrated display that shows the compass direction^[1] in which the front of the car is pointing.



Rearview mirror with compass.

Eight different compass directions are shown by their English abbreviations:

- **N** – north
- **NE** – northeast
- **E** – east
- **SE** – southeast
- **S** – south
- **SW** – southwest
- **W** – west
- **NW** – northwest

* Option/accessory.

^[1] A rearview mirror with a compass is available as an option on certain markets and models only.

12.14.2. Activating and deactivating the compass*

The upper right-hand corner of the rearview mirror has an integrated display that shows the compass direction^[1] in which the front of the car is pointing.

The compass is activated automatically when the car is started.

Activating or deactivating the compass manually

- 1 Depress the button on the underside of the rearview mirror using e.g. a paper clip.
- If the compass is deactivated when the car is switched off, it will not be activated the next time the car is started. In this case, the compass needs to be activated manually.

* Option/accessory.

[1] A rearview mirror with a compass is available as an option on certain markets and models only.

12.14.3. Calibrating the compass*

The earth is divided into 15 magnetic zones. The compass [1] should be calibrated if the car is moved between several magnetic zones.

- 1 Stop the car in a large open area free from steel structures and high-voltage power lines.
- 2 Start the car and switch off all electrical equipment (air conditioning, wipers, etc.) and ensure that all doors are closed.

Note

Calibration may fail or not start at all if electrical equipment is not switched off.

- 3 Hold the button on the underside of the rearview mirror depressed for approx. 3 seconds (use a paper clip, for example). The number for the current magnetic zone is shown.

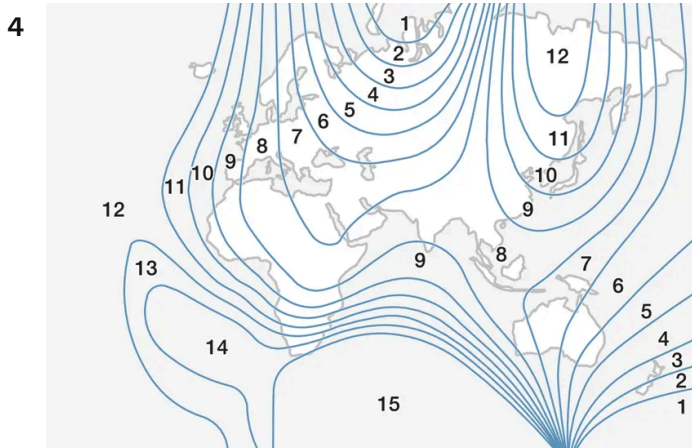

Magnetic zones.

Press the button repeatedly until the required magnetic zone (1–15) is shown. See the map of magnetic zones for the compass.

- 5 Wait until the display returns to showing the character **C**, or hold the button on the underside of the rearview mirror depressed for approx. 6 seconds until the character **C** is shown.

The content of this manual represents the status of the user manual at the time of printing and may not be completely valid in future instances. For more information, refer to the first page for the complete disclaimer note.

- 6 Drive slowly in a circle at a speed of no more than 10 km/h (6 mph) until a compass direction is shown in the display, indicating that calibration is complete. Then drive a further 2 circles to fine-tune calibration.
- 7 **Cars with heated windscreen***: If the character C is shown in the display when the heated windscreen is activated, perform the calibration in accordance with point 6 above with the heated windscreen activated.
- 8 Repeat the above procedure as necessary.

* Option/accessory.

^[1] A rearview mirror with a compass is available as an option on certain markets and models only.

12.15. Towing and recovery

12.15.1. Towing

During towing, the car is towed by another vehicle by means of a towline.

Towing the car is not permitted as this will damage the electric motor. Instead, the car must be transported raised with all the wheels on a recovery vehicle's platform, neither of the wheel pairs may have road contact.

When towing another car

Towing a car requires a lot of energy - use the **Constant AWD** drive mode. This then charges the hybrid battery, in combination with improving the car's driving characteristics and roadholding.

Find out the statutory maximum speed limit for towing before the towing begins.

Jump starting

Tow-starting the motor is not permitted as this will damage the electric motor. Use a donor battery if the starter battery is discharged and the engine does not start.

 **Important**

The electric drive motor and the catalytic converter may be damaged during attempts to tow-start the car.

12.15.2. Fitting and removing the towing eye

Use the towing eye if the car shall tow another vehicle. The towing eye is screwed into a threaded socket behind a cover on the right-hand side of the rear bumper.

i Note

If the car is equipped with a towbar, there is no rear mounting for a towing eye.

Fitting the towing eye

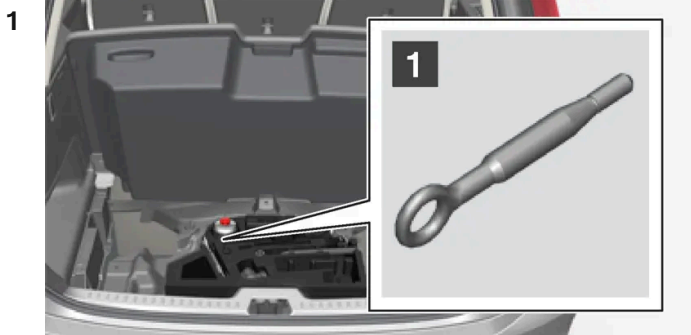

1

Take out the towing eye from the foam block under the floor in the cargo area.

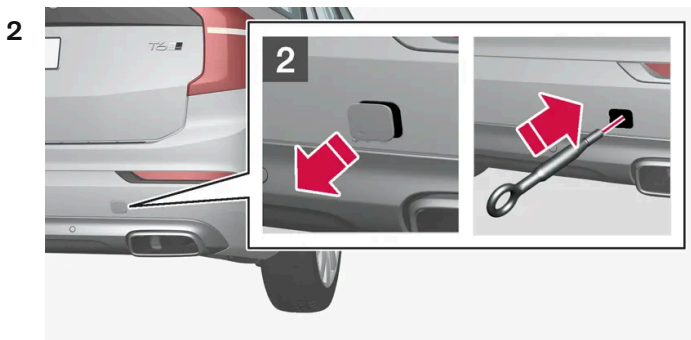

2

Remove the cover – press on the marking with a finger while you fold out the opposite side/corner.

➤ The cover pivots around its centre line and can then be removed.

3 Screw in the towing eye until it reaches its end stop.

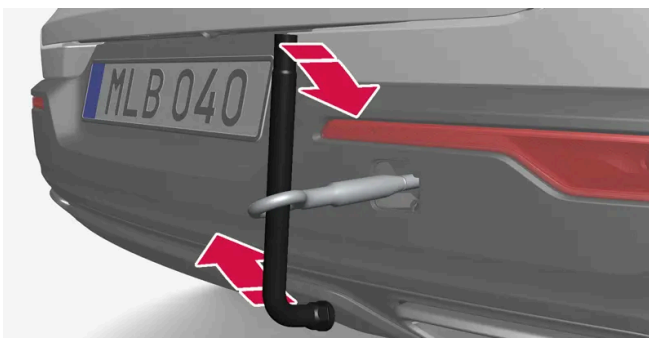

Screw the eye in firmly. For example, thread through the wheel bolt wrench* and use it as a lever.

 **Important**

It is important that the towing eye is firmly screwed into place - right in until it stops.

Removing the towing eye

- 1 Unscrew and remove the towing eye after use and return it to its foam block.
Finish by refitting the cover onto the bumper.

* Option/accessory.

12.15.3. Recovery

For recovery, the car is taken away with the help of another vehicle.

Call a recovery service for recovery assistance.

The towing eye can be used to pull the car up onto a recovery vehicle with a flatbed platform.

 **Important**

Note that the car must always be transported raised up with all the wheels on the recovery vehicle's platform.

Applies to cars with level control*: If the car is equipped with air suspension, this must be disabled before the car is raised. Deactivating the function via the centre display.

- 1 Press **Settings** in the top view.
- 2 Press **My Car** → **Parking Brake and Suspension**.
- 3 Select **Disable Leveling Control**.

The car's position and ground clearance determine whether it is possible to pull it up onto a flatbed platform. If the slope of the recovery vehicle's ramp is too steep, or if the ground clearance under the car is inadequate, then the car may be damaged if you try to pull it up. The car should then be lifted using the recovery vehicle's lifting device.

 **Warning**

No one/nothing is allowed to remain behind the recovery vehicle while the car pulled up onto the flatbed platform.

* Option/accessory.

12.15.4. Safety mode

Safety mode is a protective state that is triggered when a collision may have damaged any of the car's vital functions, such as the fuel lines, sensors for any of the safety systems, or the brake system.

If the car has been in a collision, the message **Safety mode See Owner's manual** may be shown on the driver display with a warning symbol as long as the display is not damaged and the car's electrical system is still in working order. This message means that the car has reduced functionality.

 **Warning**

Never, under any circumstances, attempt to restart the car if it smells of fuel when the **Safety mode See Owner's manual** message is shown in the driver display. Leave the car at once.

If the car is in safety mode, it is possible to attempt to reset the system in order to start and move the car for a short distance, if in a dangerous traffic situation for example.

 **Warning**

Never attempt to repair your car or reset the electronics yourself if the car has been in safety mode. This could result in personal injury or the car not functioning as normal. Volvo recommends engaging an authorised Volvo workshop to check and restore the car to normal status after **Safety mode See Owner's manual** has been shown.

 **Warning**

If the car is in safety mode it must not be towed. It must be transported from its location. Volvo recommends that it is transported to an authorised Volvo workshop.

12.15.5. Starting and moving the car after safety mode

If the car is in safety mode, it is possible to attempt to reset the system in order to start and move the car for a short distance, if in a dangerous traffic situation for example.

Reset and start the car after safety mode

- 1 Check the general damage situation of the car and whether any fuel has been leaking. There must be no smell of fuel either.

If there is only minor damage and a check has revealed no fuel leaks, starting can be attempted.

Warning

Never, under any circumstances, attempt to restart the car if it smells of fuel when the **Safety mode See Owner's manual** message is shown in the driver display. Leave the car at once.

- 2 Switch off the car.
- 3 Then try to start the car.
 - The car's electronics carry out a systems check and then try to resume normal status. The driver display shows the message **Car start System check, wait** during this time. This can take up to one minute.
- 4 Then try to start the car again when the message **Car start System check, wait** is no longer shown in the driver's display.

Important

If the message **Safety mode See Owner's manual** is still shown on the display the car must not be driven or towed but a vehicle recovery service must then be used instead. Even if the car appears to be driveable, hidden damage may make the car impossible to control once moving.

Moving the car after safety mode

- 1 If the driver display shows the message **Normal mode The car is now in normal mode** after a start attempt, the car can be carefully moved if standing in a dangerous position.
- 2 Do not move the car further than necessary.

Warning

If the car is in safety mode it must not be towed. It must be transported from its location. Volvo recommends that it is transported to an authorised Volvo workshop.

12.16. Operational disruption

An operational disruption may have different causes and is not necessarily due to a direct fault.

Some functions have limitations in special situations and circumstances, or require that certain conditions are fulfilled in order to work. The driver display and centre display may show messages in order to inform about such events.

Find out more about fault-tracing and the limitations of various functions in related articles below.

If the car is not drivable

Activate the hazard warning flashers if the car has broken down or been forced to stop unexpectedly in a trafficked environment. Think about safety. If possible, move the car out of danger from traffic. Put on a reflective vest and then position the warning triangle so that other road users are warned in good time. Call roadside assistance.

12.17. Traffic accident

If your car is involved in a traffic accident, activate the hazard warning flashers and move the car into a safer position if possible.

Do not attempt to restart the car if there is a smell of fuel when the driver display shows the message **Safety mode See Owner's manual**. If so, leave the car at once!

Call the emergency services or roadside assistance as necessary.

Depending on the car's equipment, the car itself can detect an accident and contact the nearest emergency call centre. If the car does not have Volvo On Call*, there is a European legal requirement, Pan-European eCall, that provides access to an automatic collision alarm and urgent assistance in emergency situations^[1].

- Think about safety when exiting the car!
- Use a reflective vest and position the warning triangle so that other road users are warned.

If you collide with a wild animal

Be careful, injured animals can feel trapped and then defend themselves.

Call the police to get help with humane killing if the animal is seriously injured, or move a dead animal away from the road so that it is not a danger to other road users.

* Option/accessory.

^[1] Applies to certain markets.

13. Sound, media and Internet

13.1. Radio

13.1.1. Digital radio

13.1.1.1. Digital radio *

Digital radio (DAB^[1]) is a digital broadcasting system for radio. The radio supports DAB, DAB+ and DMB^[2].



The radio can be operated using voice recognition, the steering wheel keypad or the centre display.



The digital radio app is launched from app view in the centre display.

Digital radio is played back in the same way as other radio bands, such as FM. Besides the option to select playback from **Stations**, **Favourites** and **Genres**, there is also the option to select playback from subchannels and **Ensembles**. An ensemble is a set of radio channels (a channel group) broadcasting on the same frequency.

In the cases where the radio channel transmits its logotype, it is downloaded and shown beside the station name (download time varies).

DAB subchannel

Secondary components are usually named subchannels. These are temporary and can contain e.g. translations of the main programme into other languages. Subchannels are indicated with an arrow symbol in the channel list.

* Option/accessory.

^[1] Digital Audio Broadcasting

^[2] Digital Multimedia Broadcasting

13.1.1.2. Link between FM and digital radio *

The function enables the digital radio (DAB) to switch from a channel with poor or no reception to the same channel in another channel group (ensemble) with better reception, within DAB and/or between DAB and FM.

DAB to DAB and DAB to FM linking

- 1 Press **Settings** in the top view.
- 2 Press **Media** → **DAB**.
- 3 Tick/untick **DAB To DAB Handover** and/or **DAB To FM Handover** in order to activate/deactivate the respective functions.

* Option/accessory.

13.1.2. Voice control of radio and media

Commands for radio and media player voice control are shown below^[1].

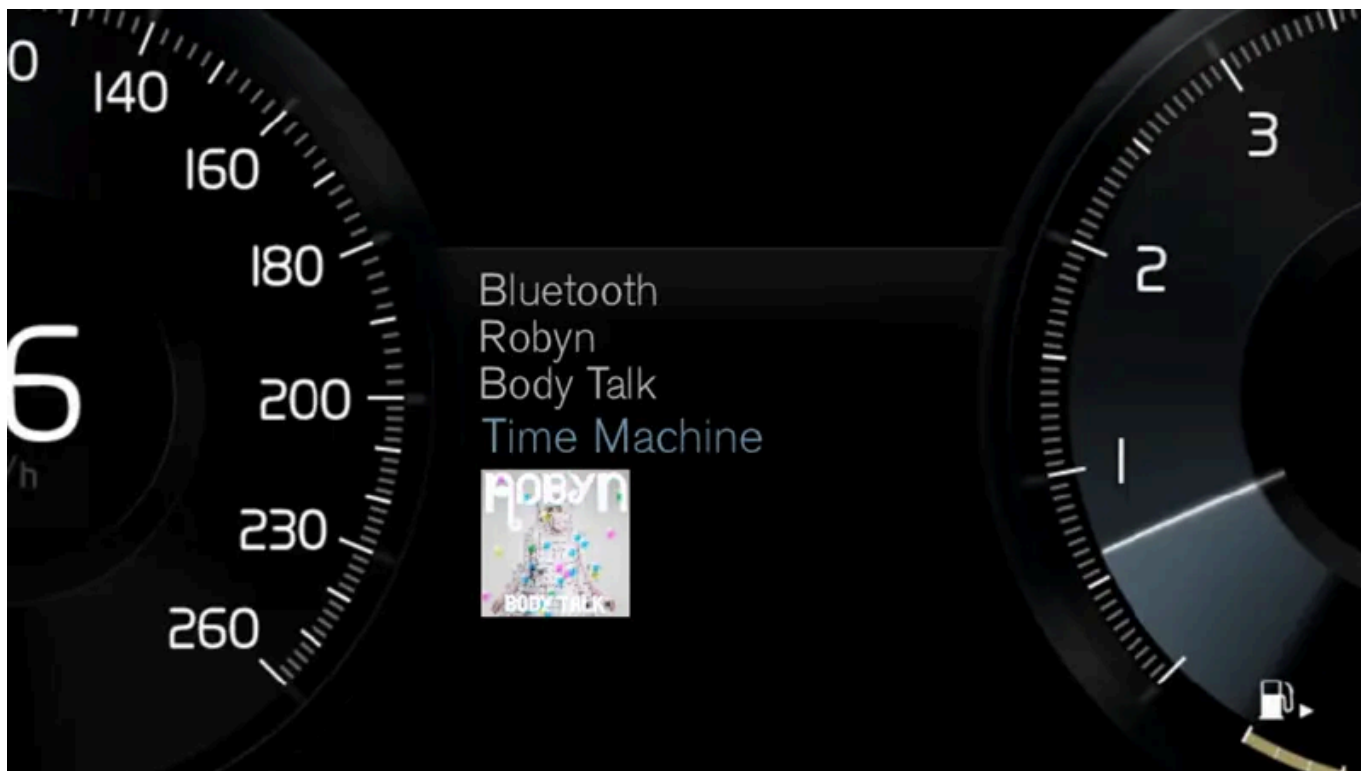

Tap on  and say one of the following commands:

- "Media" - starts a dialogue for media and radio and shows examples of commands.
- "Play[artist]" - plays back music by the selected artist.
- "Play[song title]" - plays back the selected song.
- "Play[song title]from[album]" - plays back the selected song from the selected album.

The content of this manual represents the status of the user manual at the time of printing and may not be completely valid in future instances. For more information, refer to the first page for the complete disclaimer note.

- "Play[radio station]" - starts playing back the selected radio channel.
- "Tune to [frequency]" - starts the selected radio frequency in the current frequency band. If no radio source is active, the FM band is started by default.
- "Tune to [frequency][wavelength]" - starts the selected radio frequency in the selected frequency band.
- "Radio" - starts FM radio.
- "Radio FM" - starts FM radio.
- "DAB" - starts DAB radio*.
- "USB" - starts playback from USB.
- "iPod" - starts playback from iPod.
- "Bluetooth" - starts playback from a Bluetooth-connected media source.
- "Similar music" — plays back music similar to the music currently playing back from USB devices.

Note

Not all system languages support voice recognition. The ones that do are highlighted with the  symbol in the list of available system languages. Read more about where the information can be found in the section on settings for voice recognition.

^[1] Applies to certain markets.

* Option/accessory.

13.1.3. Radio

It is possible to listen to the FM bands and to digital radio (DAB)*. When the car is online, it is also possible to listen to Internet radio.

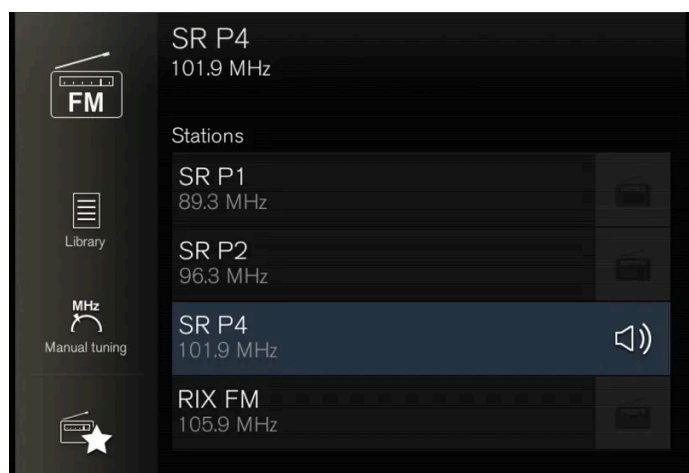

The radio can be operated using voice recognition, the steering wheel keypad or the centre display.

* Option/accessory.

13.1.4. Start radio

The radio is started from the centre display app view.

- 1 Open the required frequency band (e.g. FM) from the app view.



- 2 Select a radio station.

13.1.5. Changing radio band and radio station

There are instructions here for changing the radio band, the list in the radio band and the radio station in the selected list.

Changing radio band

Swipe to show the app view in the centre display and select the preferred radio band (e.g. **FM**), or open the driver display's app menu using the right-hand keypad on the steering wheel and make your selection from there.

Changing lists within the frequency band

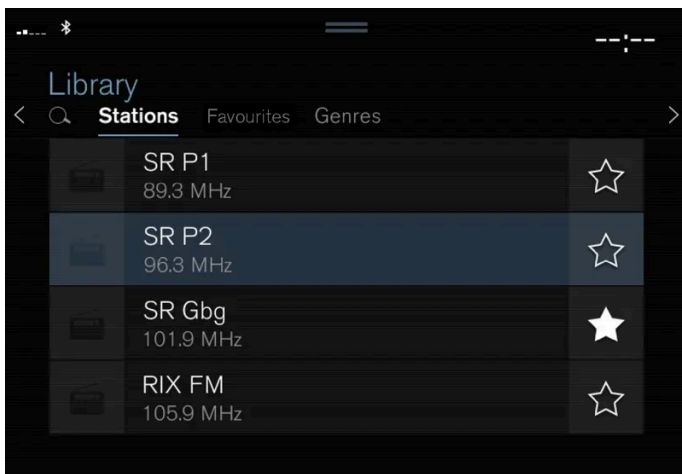

- 1 Press **Library**.
- 2 Select playback from **Stations**, **Favourites**, **Genres** or **Ensembles**^[1].
- 3 Tap on the desired station from the list.

Favourites - only plays back selected favourite channels.

Genres — only plays back channels broadcasting the selected genre/programme type, e.g. pop or classical.

Changing stations within the selected list

- 1 Press on **⏮** or **⏭** under the centre display or the steering wheel's right-hand keypad.
 - The highlight moves up or down one place in the selected playlist.

You can also change radio station in the selected list via the centre display.

* Option/accessory.

[1] Only applies to digital radio (DAB*).

13.1.6. Searching for radio stations

The radio automatically compiles a station list of the radio stations within the area that are transmitting the strongest signals.

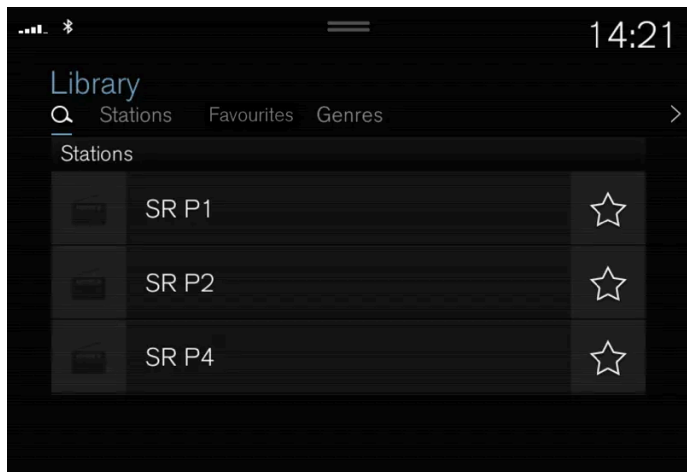

The parameters you can search on depend on the frequency band selected:

- FM - station, genre and frequency.
- DAB* - ensembles and stations.

1 Press **Library**.

2 Press **Q**.

➤ Search view with keyboard is opened.

3 Enter the search terms.

➤ Searching takes place with each input of a character and the search results are shown by category.

Manual tuning



Searching manually makes it possible to find and tune to stations that are not on the automatically compiled list of the strongest stations in the area.

On changing over to manual tuning, the radio no longer changes frequency automatically when reception is poor.

- 1 Press **Manual tuning**, pull the control or press **⏪** or **⏩**. With a long press, the search jumps to the next available station in the frequency band. It is also possible to use the right keypad on the steering wheel.

* Option/accessory.

13.1.7. Settings for radio

There are various radio functions to activate and deactivate.

Cancelling traffic messages

The broadcast of traffic messages etc. can be temporarily interrupted by tapping on **○** in the right-hand steering wheel keypad or by tapping on **Cancel** in the centre display.

Activating and deactivating radio functions

Drag down the top view and select **Settings** → **Media** and the desired radio band to view available functions.

FM Radio

- **Show Broadcast Information:** shows information on programme content, artists, etc.
- **Freeze Program Name:** select to stop the programme service name from scrolling continuously. It will freeze after 20 seconds instead.

- **Select Announcements:**^[1]
 - **Local Interruptions:** interrupts the current media playback and broadcasts information about traffic disruptions in the neighbourhood. Playback of previous media source is resumed when the message is finished. The **Local Interruptions** function is a geographically restricted version of the **Traffic Announcements** function. The **Traffic Announcements** function must be activated at the same time.
 - **News :** interrupts the current media playback and broadcasts news. Playback of previous media source is resumed when the news broadcast is finished.
 - **Alarm:** interrupts the current media playback and sends alerts about major accidents and disasters. Playback of previous media source is resumed when the message is finished.
 - **Traffic Announcements:** interrupts the current media playback and broadcasts information about traffic disruptions. Playback of previous media source is resumed when the message is finished.

DAB* (digital radio)

- **Sort Services:** option for how channels will be sorted. Either alphabetically or by service number.
- **DAB To DAB Handover:** starts the function for linking within DAB. If reception of a radio channel is lost, another channel is found automatically in another channel group (ensemble).
- **DAB To FM Handover:** starts the function for linking between DAB and FM. If reception of a radio channel is lost, an alternative FM frequency is searched for automatically.
- **Show Broadcast Information:** select to show radio text or selected types of radio text, e.g. artist.
- **Show Program Related Images:** select whether or not to show images for programmes on the screen.
- **Select Announcements:** select the types of messages to be received while DAB is playing. Selected messages will interrupt the current media playback to play back the message. Playback of previous media source is resumed when the message is finished.
 - **Alarm:** interrupts the current media playback and sends alerts about major accidents and disasters. Playback of previous media source is resumed when the message is finished.
 - **Traffic Flash:** receives information about traffic disruptions.
 - **News Flash:** receives news.
 - **Transport Flash:** receives information about public transport, e.g. ferry and train timetables.
 - **Warning/Services:** receives information about incidents of lower significance than the Alarm function, e.g. power failures.

^[1] Not all stations support all message types.

* Option/accessory.

13.1.8. RDS radio

RDS (Radio Data System) means that the radio automatically changes to the strongest transmitter. RDS provides the ability to receive e.g. traffic information and to search for certain programme types.

RDS links FM transmitters into a network. An FM transmitter in such a network sends information that gives an RDS radio the following functions:

- Switch automatically to a stronger transmitter if reception in the area is poor.
- Search for programme category, e.g. programme types or traffic information.
- Receive text information on current radio programme.

 **Note**

Some radio stations do not use RDS or only selected parts of its functionality.

When broadcasting news or traffic messages, the radio can switch stations, interrupting the audio source currently in use. The radio returns to the previous audio source and volume when the set programme type is no longer broadcast. To go back earlier, press  on the right-hand steering wheel keypad or tap **Cancel** in the centre display.

13.1.9. Save radio channels in the Radio Favourites app

It is possible to add a radio channel to the **Radio favourites** app and the favourites list for the radio band (e.g. FM). Instructions on how to add and remove radio channels can be found below.



Radio Favourites



The Radio Favourites app shows saved radio channels from all frequency bands.

- 1 Open the app **Radio favourites** from the app view.
- 2 Tap on the desired station in the list to start listening.

Adding and removing radio favourites

- 1 Tap on  to add a channel to or from frequency band favourites and the Radio Favourites app.
- 2 Tap on **Library**, select **Edit** and tap on  to remove a radio channel from the favourites.

When a radio channel is saved from a station list, the radio will automatically search for the best frequency. But if a radio channel is saved from a manual station search, the radio does not automatically change to a stronger frequency.

If a radio channel is removed from the Radio Favourite app, the channel will also be removed from the favourites list for the relevant frequency band.

13.2. Media player

13.2.1. Video

13.2.1.1. Video

Videos on USB-connected devices can be played back using the media player.

No picture is shown when the car starts to move, but only the audio is played back. The picture is shown again when the car is stationary.

Information on compatible formats for media can be found in a separate section.

13.2.1.2. Playing a video

Videos are played using the **USB** app in the app view.

- 1 Connecting a media source (USB device).
 - 2 Open the app **USB** from the app view.
 - 3 Tap on the title of the desired item to play back.
- Playback begins.

Finding video files may be problematic if the USB device also contains music and audio tracks. In this case, it is possible to find them by going to **Library** and selecting the video tab.

13.2.1.3. Playing back DivX[®]

This DivX Certified[®] device must be registered in order to play back purchased DivX Video-on-Demand (VOD) films.

- 1 Press **Settings** in the top view.
- 2 Tap **Video** → **DivX® VOD** and retrieve the registration code.
- 3 Go to vod.divx.com for more information and to complete the registration.

13.2.1.4. Settings for video

Certain language settings can be changed for video playback.

With the video player in full screen mode, or by opening the top view and pressing **Settings** → **Media** → **Video**, the following can be adjusted: **Audio Language** and **Subtitle Language**.

13.2.2. Media via Bluetooth®

The car's media player is equipped with Bluetooth and can wirelessly play audio files from external Bluetooth devices, such as mobile phones and tablets.

For the media player to be able to play back audio files wirelessly from an external device, the device must first be connected to the car via Bluetooth^[1].

^[1] Note that the device must be connected for media playback in order for playback via Bluetooth to work.

13.2.3. Connecting a device via Bluetooth®

Connect a Bluetooth® device to the car for wireless playback of media and to provide the car with an Internet connection where possible.

Most phones on the market now have wireless Bluetooth® technology, but not all of them are fully compatible with the car.

The procedure for connecting a media device is the same as for connecting a phone to the car via Bluetooth®^[1].

Note

Some phones require that the phone's Bluetooth volume is manually set to 100% in order for the audio volume in the car to be sufficiently high. This setting needs to be made for each phone connected. The setting is made once for phone calls and once for streaming media. The system will then remember the setting and it does not need to be repeated next time the phone is connected.

[1] Note that the device must be connected for media playback in order for playback via Bluetooth to work.

13.2.4. Voice control of radio and media

Commands for radio and media player voice control are shown below^[1].

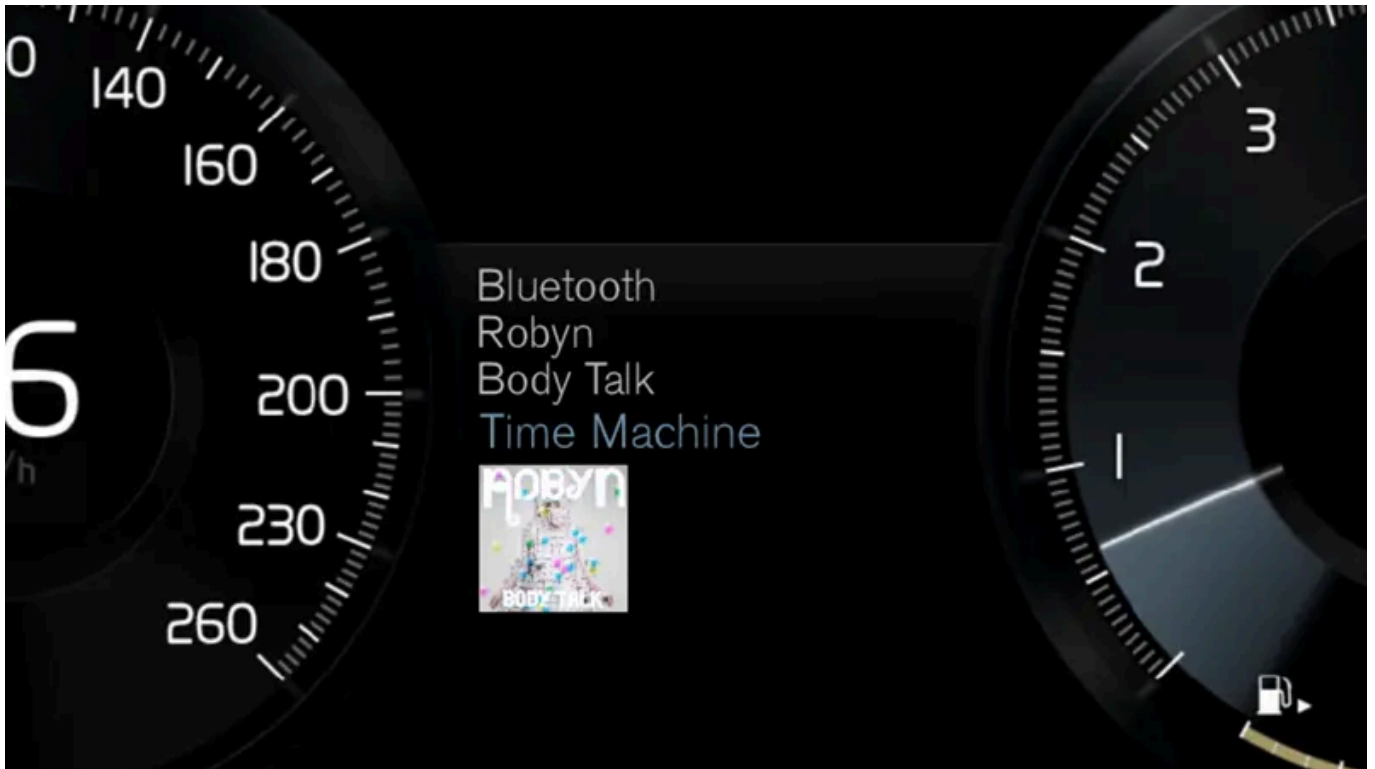

Tap on  and say one of the following commands:

- "Media" - starts a dialogue for media and radio and shows examples of commands.
- "Play[artist]" - plays back music by the selected artist.

- "Play[song title]" - plays back the selected song.
- "Play[song title]from[album]" - plays back the selected song from the selected album.
- "Play[radio station]" - starts playing back the selected radio channel.
- "Tune to [frequency]" - starts the selected radio frequency in the current frequency band. If no radio source is active, the FM band is started by default.
- "Tune to [frequency][wavelength]" - starts the selected radio frequency in the selected frequency band.
- "Radio" - starts FM radio.
- "Radio FM" - starts FM radio.
- "DAB " - starts DAB radio*.
- "USB" - starts playback from USB.
- "iPod" - starts playback from iPod.
- "Bluetooth" - starts playback from a Bluetooth-connected media source.
- "Similar music" — plays back music similar to the music currently playing back from USB devices.

 **Note**

Not all system languages support voice recognition. The ones that do are highlighted with the  symbol in the list of available system languages. Read more about where the information can be found in the section on settings for voice recognition.

^[1] Applies to certain markets.

* Option/accessory.

13.2.5. Media player

The media player can play back audio from external audio sources connected via the USB port or Bluetooth. It can also play back video format via the USB port.

When the car is connected to the internet, it is also possible to listen to web radio, audio books and music services via apps.

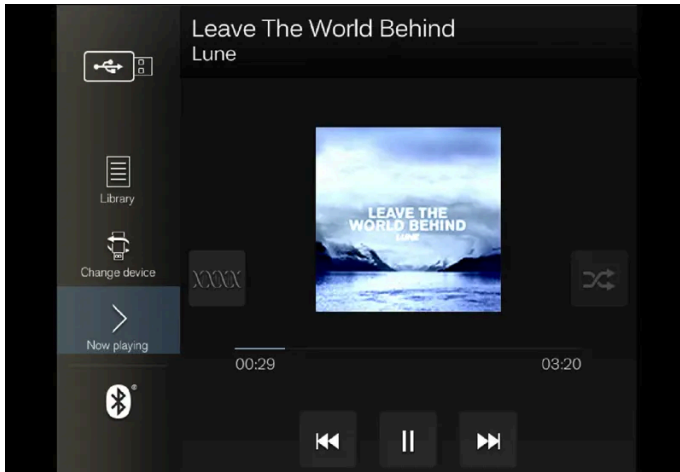

The media player is operated from the centre display, but several functions can be operated using the steering wheel's right-hand keypad or voice control.

The radio is operated in the media player and is described in a separate section.

13.2.6. Media playback

The media player is controlled from the centre display. Several functions can also be operated using the steering wheel's right-hand keypad or voice control.

The media player also operates the radio, which is described in a separate section.

Starting the media source



App view. (Generic image, basic apps vary by market and model.)

USB memory

- 1 Insert the USB memory.
 - 2 Open the app **USB** from the app view.
 - 3 Select what to play back.
- Playback begins.

Mp3 player and iPod®

Note

To start playback from iPod, use the iPod app (not USB).

When an iPod is used as audio source, the car's audio and media system has a menu structure that is similar to the iPod player's own menu structure.

- 1 Connect media source.
 - 2 Start playback from the connected media source.
 - 3 Open the app (**iPod**, **USB**) from the app view.
- Playback begins.

Bluetooth connected device

- 1 Activate Bluetooth in the media source.
 - 2 Connect media source^[1].
 - 3 Start playback from the connected media source.
 - 4 Open the app **Bluetooth** from the app view.
- Playback begins.

 **Note**

Some phones require that the phone's Bluetooth volume is manually set to 100% in order for the audio volume in the car to be sufficiently high. This setting needs to be made for each phone connected. The setting is made once for phone calls and once for streaming media. The system will then remember the setting and it does not need to be repeated next time the phone is connected.

Media with Internet connection

Play back media from Internet-connected apps:

- 1 Connect the car to the Internet.
 - 2 Open the current app from the app view.
- Playback begins.

Read the separate section on how apps are downloaded.

Video

- 1 Connect media source.
 - 2 Open the app **USB** from the app view.
 - 3 Tap on the title of the desired item to play back.
- Playback begins.

Apple CarPlay

CarPlay is described in a separate section.

Android Auto

Android Auto is described in a separate section.

^[1] Note that the device must be connected for media playback in order for playback via Bluetooth to work.

13.2.7. Controlling and changing media

The playback of media can be controlled with voice control, steering wheel keypad or the centre display.



The media player can be operated by voice recognition, from the steering wheel keypad or the centre display.

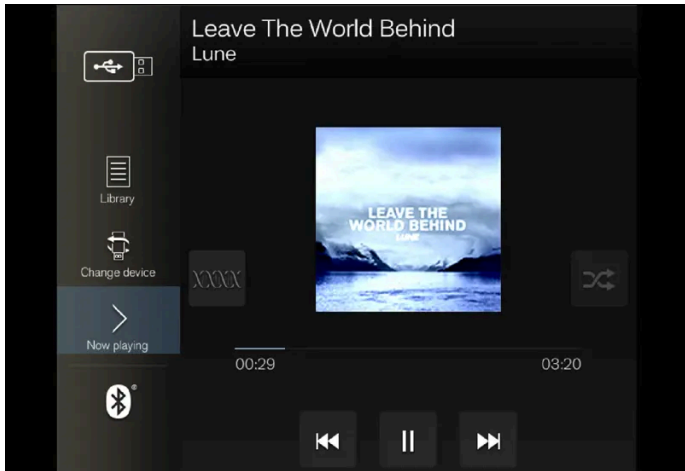

Volume - turn the control knob under the centre display or press ▲ ▼ on the steering wheel's right-hand keypad in order to increase or decrease the volume.

Play/pause - tap on the image belonging to the song being played back, the physical button under the centre display or ○ on the steering wheel's right-hand keypad.

Change track/song - tap on the desired track in the centre display, press on ⏮ or ⏭ under the centre display or on the steering wheel's right-hand keypad.

Fast forward/move in time - tap on the time axis in the centre display and drag sideways, or press and hold ⏮ or ⏭ under the centre display or on the steering wheel's right-hand keypad.

Changing media - select from previous sources in the app, in the app view, press on the desired app or select with the steering wheel's right-hand keypad via the app menu ☰.

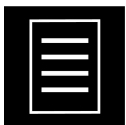

Library - tap on the button to play back from the library.



Shuffle - tap on the button to shuffle the playback order.



Similar - tap on the button in order to use Gracenote to search for similar music on the USB device and to create a playlist from it. The playlist can contain a maximum of 50 songs.



Change device - tap on the button in order to switch between USB devices when several are connected.

13.2.8. Searching media

It is possible to search by artist, composer, song titles, album, video, audio book, playlist and, when the car is connected to the Internet, podcasts (digital media via Internet).

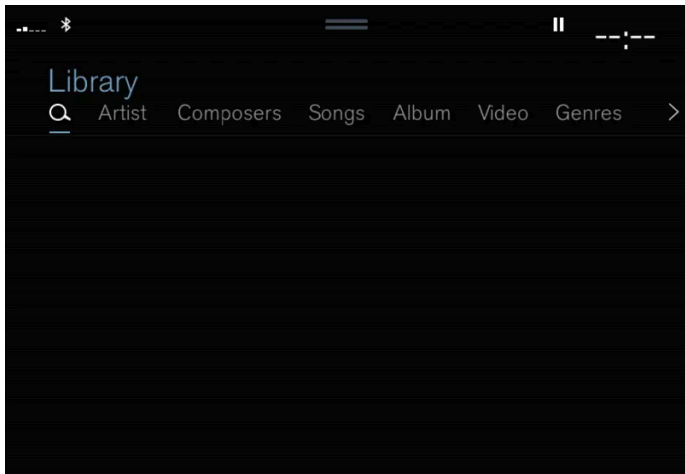

- 1 Press **Q**.
 - > Search view with keyboard is opened.
- 2 Enter the search terms.
- 3 Press **Search**.
 - > Connected devices are searched and the search results are listed by category.

Swipe sideways across the screen to show each category separately.

13.2.9. Compatible media formats

The following file formats must be used for media playback.

Audio files

Format	File extension	Codec
MP3	.mp3	MPEG1 Layer III, MPEG2 Layer III, MP3 Pro (mp3 compatible), MP3 HD (mp3 compatible)
AAC	.m4a, .m4b, .aac	AAC LC (MPEG-4 part III Audio), HE-AAC (aacPlus v1/v2)
WMA	.wma	WMA8/9, WMA9/10 Pro
WAV	.wav	LPCM
FLAC	.flac	FLAC

Video files

Format	File extension
MP4	.mp4, .m4v
MPEG-PS	.mpg, .mp2, .mpeg, .m1v
AVI	.avi
AVI (DivX)	.avi, .divx
ASF	.asf, .wmv

Subtitles

Format	File extension
SubViewer	.sub
SubRip	.srt
SSA	.ssa

DivX®

DivX certified devices have been tested for high-quality DivX (.divx, .avi) video playback. When you see the DivX logo, you have the freedom to play DivX films.

Profile	DivX Home Theater
Video codec	DivX, MPEG-4
Resolution	720x576
Bit rate	4.8Mbps
Frame rate	30 fps
File extension	.divx, .avi
Max file size	4 GB
Audio codec	MP3, AC3
Subtitles	XSUB
Special functions	Multiple subtitles, multiple audio, resume play
Reference	Meets all requirements of the DivX Home Theater profile. Visit divx.com for more information and software tools to convert your files into DivX Home Theater video.

13.2.10. Gracenote®

Gracenote identifies artist, album, song titles and associated images, which are shown during playback.

Gracenote MusicID® is a standard for music recognition. Information on the music can be presented by means of the identification and analysis of the metadata in the music files. Sometimes metadata from different sources can be inconsistent or inadequate.

Gracernote has support for phonetic processing of artist name, album titles and genres, and in this way, voice control can be used to play back music.

- 1 Press **Settings** in the top view.
- 2 Press **Media** → **Gracernote®**.
- 3 Select settings for Gracernote data:

- **Gracernote® Online Search** - searches in Gracernote's online database for playing media.
- **Gracernote® Multiple Results** - selects how to display Gracernote data if there are more than one search results.

1 - the file's original data are used.

2 - Gracernote data are used.

3 - Gracernote or original data can be selected.

- **None** - no results are shown.

Updating Gracernote

The content of the Gracernote database is updated continuously. Download the latest update to take advantage of improvements.

13.2.11. Updating Gracernote®

Volvo is constantly working to keep your car up to date. It is therefore a good idea to update Gracernote® at regular intervals. Updating occurs in two stages using an empty USB memory.

Download files and update Gracernote®

It is a good idea to update Gracernote® at regular intervals. A description of how to download update files and update Gracernote® in your Volvo can be found below.

Preparations

The files can be downloaded to an empty USB memory of at least 8 GB. The memory must have one of the following formats: FAT32, NTFS or exFAT.

Download program

Gracernote® files are downloaded using a program that is installed on your computer when you download update files.

Update Gracernote® files

The content of this manual represents the status of the user manual at the time of printing and may not be completely valid in future instances. For more information, refer to the first page for the complete disclaimer note.

To download update files for Gracenote[®], go to [volvocars.com/support](https://www.volvocars.com/support) [<https://www.volvocars.com/intl/support>], select your market, and then click on **Downloads** in the top menu. Under the heading **Gracenote[®]**, click on **Update Gracenote** and then select the relevant system for your car. Then follow the instructions below:

Instructions

- 1 Depending on which system you have, select the download link for either Windows or Mac.
- 2 Select **Run to install** the download program.
- 3 Click on **New download** to download the file to a USB memory stick.
- 4 You can verify that the download/copying to the USB memory stick has worked correctly before you install the file in the car by repeating steps 1-2 and then pressing on **Check download** in the download program.
- 5 Take the USB memory with the downloaded file to your car and switch on the infotainment system.
- 6 Insert the USB memory in the USB port. If there are two USB ports, the second one must not be used at the same time.



The position of this port may vary depending on the car model.

- 7 The system automatically detects the availability of an update and a message appears on screen showing that updating is in progress.
- 8 When installation is complete, a notification is displayed indicating that the update has been installed. The USB memory can now be removed.

If there are any problems with the update, contact your customer support or Volvo dealer.

Updating tips

- An update takes about 15 minutes and the infotainment system must be on. Use a battery charger or keep the car's engine running while the update is in progress, for example during a journey.
- Gracenote[®] is updated all the time. Keep an eye out for new updates.

13.2.12. Media via USB port

An external audio source, e.g. an iPod® or MP3 player, can be connected to the audio system via the car's USB port.

Devices with rechargeable batteries are recharged when connected via USB and the ignition is in position I, II or the engine is running.

The content of the external source can be loaded more quickly if it only consists of compatible formats. Video files can also be played back via the USB port.

Certain MP3 players have their own file system that the car does not support.

13.2.13. Connecting a device via USB port

An external audio source, e.g. an iPod® or MP3 player, can be connected to the audio system via one of the car's USB ports.

The phone must be connected to the USB port with white frame (when there are two USB ports) when using Apple CarPlay* and Android Auto*.



USB ports (type A) in the tunnel console. Allow the cable to lie forwards so that it is not trapped when the lid is closed.



USB ports (type C) on rear of tunnel console for charging phones and tablets^[1], for example.

* Option/accessory.

^[1] It is not possible to playback media in the car's audio or media system via this port.

13.2.14. Technical specifications for USB devices

The following specifications must be met to allow the contents of the USB devices to be read.

No folder structure will be shown in the centre display during playback.

	Max number
Files	15 000
Folder levels	8
Folders	1 000
Items in a playlist	1 000
Playlists	100
Subfolders	No limit

Technical specification for USB A connector

- Type A socket
- Version 2.0
- Voltage supply 5 V
- Current supply max. 2.1 A

Technical specification for USB C connector

- Type C socket
- Version 3.1
- Voltage supply 5 V
- Current supply max. 3.0 A

13.3. Phone

13.3.1. Phone connection

13.3.1.1. Connecting a phone to the car via Bluetooth automatically

It is possible to connect a phone to the car automatically via Bluetooth. The phone has to have been connected to the car for the first time.

It is only the two last connected phones that can be connected automatically.

- 1 Activate Bluetooth in the phone before setting the car in ignition position I.

The content of this manual represents the status of the user manual at the time of printing and may not be completely valid in future instances. For more information, refer to the first page for the complete disclaimer note.

- 2 Set the car in ignition position I or higher.
 - The phone will connect.

13.3.1.2. Connecting a phone to the car via Bluetooth for the first time

Connect a phone with Bluetooth activated to then be able to make calls from the car, send/receive messages, play back media wirelessly and connect the car to the Internet.



It is possible to have two Bluetooth devices connected at once, in which case one of them can only play back wirelessly. The most recently connected phone will automatically be connected to make calls, send/receive messages, play back media and provide an Internet connection ^[1]. It is possible to change what the phone is to be used for under **Bluetooth Devices** via the settings menu in the centre display's top view. Your mobile phone needs to be equipped with Bluetooth and support tethering.

After the device has been connected/registered a first time via Bluetooth, it no longer needs to be visible/discoverable, but only have Bluetooth activated. A maximum of 20 connected Bluetooth devices can be stored in the car.

If you have a new device and it has the same name as one you have previously connected to the car, you may first have to delete the old device from the car's list of previously connected devices. After that, the new device is connected as normal.

There are two options for connecting. Either search the phone from the car or search the car from the phone.

Option 1 - search phone from car

- 1 Make the phone searchable/visible via Bluetooth.
- 2 Open the phone tile in the centre display.
 - If there is no phone connected to the car, tap on **Add phone**.
 - If there is a phone connected to the car, tap on **Change** . In the pop-up window, tap on **Add phone**.
- Available Bluetooth devices are listed. The list is updated as new devices are detected.
- 3 Tap on the name of the phone to be connected.
- 4 Check that the specified number code in the car matches that in the phone. In which case, choose to accept in both places.
- 5 On the phone, choose to accept or reject any options for phone contacts and messages.

 **Note**

- The message function must be activated in certain phones.
- Not all phones are fully compatible and may therefore not show contacts and messages in the car.

Option 2 - search car from phone

- 1 Open the phone tile in the centre display.
 - If there is no phone connected to the car, tap on **Add phone** → **Make car discoverable**.
 - If there is a phone connected to the car, tap on **Change** . In the pop-up window, tap on **Add phone** → **Make car discoverable**.
- 2 Activate Bluetooth on the phone.
- 3 Search on the phone for Bluetooth devices.
 - Available Bluetooth devices are listed.
- 4 Select the name of the car on the phone.
- 5 A pop-up window for the connection is shown in the car. Confirm the connection.
- 6 Check that the specified number code in the car matches the one shown in the external device. In which case, choose to accept in both places.
- 7 On the phone, choose to accept or reject any options for phone contacts and messages.

i Note

- The message function must be activated in certain phones.
- Not all phones are fully compatible and may therefore not show contacts and messages in the car.

i Note

If the phone's operating system is updated then the connection may be broken. In which case, delete the phone from the car and then connect again.

[1] You can also adjust manually under the settings.

13.3.1.3. Disconnecting a Bluetooth-connected phone

It is possible to disconnect a phone connected to Bluetooth, and it will then no longer be connected to the car.

- When the phone is out of range of the car it is automatically disconnected. If disconnection occurs during a current call, then the call will be continued on the phone.
- It is also possible to disconnect the phone by manually deactivating Bluetooth.

13.3.1.4. Switch between Bluetooth-connected phones

It is possible to switch between a number of Bluetooth-connected phones.

- 1 Open the subview for phone.
- 2 Tap on **Change**  or drag down the top view and tap on **Settings** → **Communication** → **Bluetooth Devices** → **Add device**.
 - > Available Bluetooth devices are listed.
- 3 Tap on the phone to be connected.

13.3.1.5. Removing devices connected to Bluetooth

The content of this manual represents the status of the user manual at the time of printing and may not be completely valid in future instances. For more information, refer to the first page for the complete disclaimer note.

It is possible to remove phones from the list of registered Bluetooth devices, for example.

- 1 Press **Settings** in the top view.
- 2 Press **Communication** → **Bluetooth Devices**.
 - Registered Bluetooth devices are listed.
- 3 Tap on the device to be removed.
- 4 Tap on **Remove device** and confirm your selection.
 - The device is no longer registered to the car.

If you have a new device and it has the same name as one you have previously connected to the car, you may first have to delete the old device from the car's list of previously connected devices. After that, the new device is connected as normal.

13.3.1.6. Bluetooth profiles for Sensus Connect

Sensus Connect IHU^[1] supports Bluetooth Core version 2.1+EDR^[2]. The table provides information about which Bluetooth profiles are supported by your car's infotainment system. (The article is relevant for cars with the Sensus Connect IHU 3.2 infotainment system.)



Centre display for Sensus Connect.

Profile	Version
Hands-Free Profile (HFP)	Hands-Free (HF)
	HFP-version 1.6
Phone Book Access Profile (PBAP)	Phone Book Client Equipment (PCE)
	PBAP version 1.0

Profile	Version
Audio/Video Remote Control Profile (AVRCP)	Controller (CT)
	AVRCP version 1.4
Advanced Audio Distribution Profile (A2DP)	Sink (SNK)
	A2DP version 1.2
Object Push Profile (OPP)	Object Push Server

IHU versions per car model and date of manufacture

Model	Week of manufacture/Structure week	Version
All 40-models XC40 and XC40 Recharge	From week 17, 2018	IHU 3.2
All 60-models S60, S60 Recharge, V60, V60 Recharge, V60 Cross Country, XC60 and XC60 Recharge	From week 17, 2018	IHU 3.2
All 90-models S90, S90 Recharge, V90, V90 Recharge, V90 Cross Country, XC90 and XC90 Recharge	From week 17, 2018	IHU 3.2

[1] Infotainment Head Unit

[2] Enhanced Data Rate

13.3.1.7. Connecting a phone to the car via Bluetooth manually

It is possible to connect a phone to the car manually via Bluetooth. The phone has to have been connected to the car for the first time.

- 1 Activate Bluetooth on the phone.
- 2 Open the subview for phone.
 - > Connected phones are listed.
- 3 Tap on the name of the phone to be connected.
 - > The phone will connect.

13.3.2. Apple CarPlay

13.3.2.1. Apple[®] CarPlay[®] *

CarPlay^[1] gives you the option to listen to music, make phone calls, get directions, send/receive messages and use Siri, all while you stay focused on your driving.





CarPlay works with selected iOS devices. If the car does not already support CarPlay there is the option to install it retroactively. Contact a Volvo dealer to install CarPlay.

Information about which apps are supported and which iOS devices are compatible is available on Apple's website: www.apple.com/ios/carplay/ [<https://www.apple.com/ios/carplay/>]. Using apps that are not compatible with CarPlay may sometimes mean that the connection between the device and the car is broken. Please note that Volvo is not responsible for the content in CarPlay.

When using map navigation via CarPlay, there is no guidance in the driver display or head-up display, but only in the centre display.

When navigation is started through Apple CarPlay, ongoing native turn-by-turn route guidance will be ended.

The CarPlay apps can be controlled via the centre display, the iOS device or using the steering wheel's right-hand keypad (applies to certain functions). The apps can also be voice-controlled using Siri. A long press on the steering wheel button  starts voice control using Siri and a short press activates the car's own voice control. If Siri breaks off too early, hold the steering wheel button  ^[2] depressed.

By using Apple CarPlay you acknowledge the following: Apple CarPlay is a service provided by Apple Inc. under its terms and conditions. Volvo Cars is thus not responsible for Apple CarPlay or its features/applications. When using Apple CarPlay, certain information from your car (including its position) is transferred to your iPhone. In relation to Volvo Cars, you are fully responsible for your and any others person's use of Apple CarPlay.

* Option/accessory.

^[1] Availability may vary depending on market.

^[2] Apple and CarPlay are registered trademarks owned by Apple Inc.

13.3.2.2. Using Apple[®] CarPlay[®] *

To use CarPlay^[1], Siri voice control must be activated on your iOS device. The device also needs an Internet connection via Wi-Fi or the mobile network for all functions to work.



Connect an iOS device and start CarPlay

Note

CarPlay can only be used if Bluetooth is deactivated. A phone or media player connected to the car via Bluetooth will therefore not be available when CarPlay is active. An alternative Internet source must be used to connect to the Internet for the car's apps. Use Wi-Fi or the car's built-in modem*.

To start CarPlay from an iOS device that has not been connected previously:

- 1 Connect an iOS device with support for CarPlay to the USB port. In the cases where there are two USB ports, the one with the white frame around the port must be used.
- 2 Read the terms and conditions and then tap on **Accept** to connect.
 - The subview with CarPlay is opened and compatible apps are shown.
- 3 Tap on the desired app.
 - The app starts.

Starting CarPlay

To start CarPlay from an iOS device that has been connected previously:

- 1 Connect an iOS device to the USB port. In the cases where there are two USB ports, the one with the white frame around the port must be used.
 - > **If the setting for automatic start is selected** - the name of the device will be shown. The tile with CarPlay is opened automatically in the cases where the home view is shown when connecting the iOS device.
- 2 If the tile with CarPlay does not open automatically, tap on the device name. The subview with CarPlay is opened and compatible apps are shown.
- 3 If an app is active in the same tile, tap on **Apple CarPlay** in the app view.
 - > The subview with CarPlay is opened and compatible apps are shown.
- 4 Tap on the desired app.
 - > The app starts.

CarPlay runs in the background if another app is started, or is already active when connecting, in the same tile. To show CarPlay in the subview again - tap on the CarPlay icon in the app view.

Switch the connection between CarPlay and iPod

CarPlay to iPod

- 1 Press **Settings** in the top view.
- 2 Continue to **Communication** → **Apple CarPlay**.
- 3 Untick the box for the iOS device that shall no longer start CarPlay automatically when the USB cable is connected.
- 4 Disconnect and connect the iOS device to the USB port.
- 5 Open the app **iPod** from the app view.

iPod to CarPlay

- 1 Tap on **Apple CarPlay** in the app view.
- 2 Read the information in the pop-up window and then tap on **OK**.
- 3 Disconnect and connect the iOS device to the USB port.
 - > The subview with Apple CarPlay is opened and compatible apps are shown [\[2\]](#).

* Option/accessory.

^[1] Availability may vary depending on market.

^[2] Apple, CarPlay, iPhone and iPod are registered trademarks owned by Apple Inc.

13.3.2.3. Tips for using Apple[®] CarPlay[®] *

Here are some useful tips for using CarPlay[®] ^[1].

- Update your iOS device with the latest version of the iOS operating system and ensure that the apps have been updated.
- In the event of a problem with CarPlay, disconnect the iOS device from the USB port and reconnect. Otherwise, try to close the app on the device that is not working and then restart the app, or try closing all apps and restart your device.
- If the apps do not appear when CarPlay starts (black screen), try minimising and expanding the tile for CarPlay.
- Using apps that are not compatible with CarPlay may sometimes mean that the connection between the iOS device and the car is broken. Information about supported apps and compatible telephone devices can be found on the Apple website. You can also search for CarPlay in the App Store to find information about apps that are compatible with CarPlay on your market.
- Using Siri it is possible to write/dictate and read out messages. Messages are read out and dictated in the language selected in the settings for Siri. When the message is written/dictated, no text will be shown in the centre display – instead, the text will appear on the iOS device. When Siri is used, note that the telephone's microphones are used and that the quality is therefore dependent on the position of the telephone.
- If the device is connected to the car via Bluetooth, the connection will be interrupted when CarPlay is used. Resume the Internet connection in the car by sharing the Internet via the Wi-Fi hotspot from the device.
- Some of the CarPlay functions (such as voice call and messages) mean that use of the car's own functions is stopped and CarPlay is shown automatically instead. If this behaviour is not wanted, deselect the display of the equivalent function in CarPlay under the phone's settings for notifications.
- CarPlay only works with iPhone ^[2].

 **Note**

Availability and functionality may vary depending on market.

* Option/accessory.

^[1] Availability may vary depending on market.

^[2] Apple, CarPlay and iPhone are registered trademarks owned by Apple Inc.

13.3.2.4. Settings for Apple[®] CarPlay[®] *

Settings for iOS device connected with CarPlay ^[1], ^[2].

The content of this manual represents the status of the user manual at the time of printing and may not be completely valid in future instances. For more information, refer to the first page for the complete disclaimer note.

Automatic start

- 1 Press **Settings** in the top view.
- 2 Continue to **Communication** → **Apple CarPlay** and select setting:
 - Tick the box - CarPlay starts automatically when the USB cable is connected.
 - Untick the box - CarPlay does not start automatically when the USB cable is connected.

If the car is shared by a lot of people, such as in a car pool, it is worth noting that a maximum of 20 iOS devices can be stored simultaneously in the list. When the list is full and a new device is connected the oldest one is deleted.

To delete the list, the settings must be reset in the centre display (factory reset).

System volumes

- 1 Press **Settings** in the top view.
- 2 Tap on **Sound** → **System Volumes** and make the settings for the following:
 - **Voice Control**
 - **Navi Voice Guidance**
 - **Phone Ringtone**

* Option/accessory.

[1] Apple and CarPlay are registered trademarks owned by Apple Inc.

[2] Availability may vary depending on market.

13.3.3. Android Auto

13.3.3.1. Android Auto*

Android Auto^[1] gives you the option to listen to music, make phone calls, get directions and use car-adapted apps from an Android device. Android Auto works with selected Android devices.

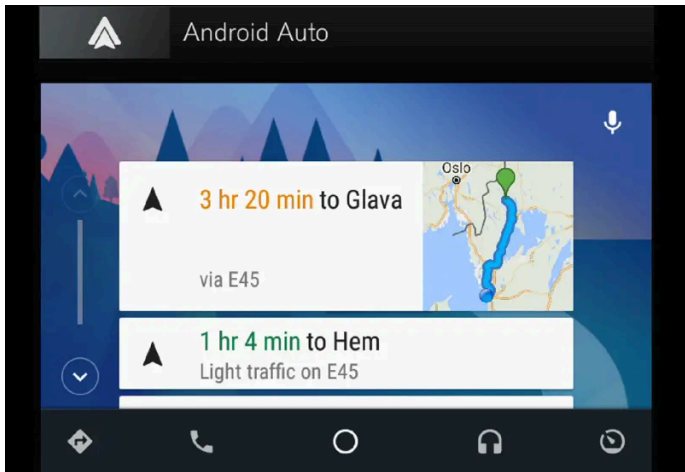

Information about which apps are supported and which Android devices are compatible is available on the website: www.android.com/auto/ [<https://www.android.com/auto/>]. For third-party apps, see Google Play. Please note that Volvo is not responsible for the content in Android Auto.

Android Auto is started from the app view. After Android Auto has been started once, the app will be started automatically the next time the device is connected. Automatic start can be deactivated under settings.

Note

When a device is connected to Android Auto it is possible to stream via Bluetooth to another media player. Bluetooth is active while Android Auto is being used.

When using map navigation via Android Auto there is no guidance in the driver display or head-up display, but only in the centre display.

Android Auto can be controlled via the centre display using the steering wheel's right-hand keypad or voice control. Holding down the steering wheel button  starts Google Assistant and a short press deactivates it.

By using Android Auto, you acknowledge the following: Android Auto is a service provided by Google Inc. under its terms and conditions. Volvo Cars is not responsible for Android Auto or its features or applications. When you use Android Auto, your car transfers certain information (including its location) to your connected Android phone. You are fully responsible for your and any other person's use of Android Auto.

* Option/accessory.

^[1] Availability may vary depending on market.

13.3.3.2. Using Android Auto*

To use the **Android Auto**^[1] app, the app must be installed on your Android device and the device must be connected to the car's USB port.



i Note

For installation of Android Auto to be possible, the car must be equipped with two USB ports (USB hub)*. If the car only has one USB port, it is not possible to use Android Auto.

The first time an Android is connected

- 1 Connect your Android device to the USB port with a white frame.
- 2 Read the information in the pop-up window and then tap on **OK**.
- 3 Tap on **Android Auto** in the app view.
- 4 Read the terms and conditions and then tap on **Accept** to connect.
 - > The subview with Android Auto is opened and compatible apps are shown.
- 5 Tap on the desired app.
 - > The app starts.

Previously connected Android

- 1 Connect your device to the USB port with a white frame.
 - **If the setting for automatic start is selected** - the name of the device is shown.
- 2 Tap on the device name – the tile with Android Auto is opened and compatible apps are shown.
- 3 **If the setting for automatic start is not selected** - open the **Android Auto** app from the app view.
 - The subview with Android Auto is opened and compatible apps are shown.
- 4 Tap on the desired app.
 - The app starts.

Android Auto runs in the background if another app is started in the same subview. To show Android Auto in the subview again - tap on the Android Auto icon in the app view.

* Option/accessory.

^[1] Availability may vary depending on market.

13.3.3.3. Tips for using Android Auto *

Here are some useful tips for using Android Auto^[1].

- Ensure that your apps are updated.
- When starting the car, wait until the centre display has started, connect the device and then open Android Auto from the app view.
- In the event of problems with Android Auto, disconnect your Android device from the USB port and then reconnect via USB. Otherwise, try closing the app on the device and then restarting the app.
- When a device is connected to Android Auto it is still possible to playback media via Bluetooth to another media player. The Bluetooth function is on when Android Auto is used.
- If the icon for Android Auto is greyed out, this means no device is connected. When you connect your device the icon will be illuminated. If the icon is not visible at all then the car does not have support for connecting a device for this purpose.
- If the device is connected to the car via Bluetooth, the connection will be interrupted when Android Auto is used. Resume the Internet connection in the car by sharing the Internet via the Wi-Fi hotspot from the device.

* Option/accessory.

^[1] Availability may vary depending on market.

13.3.3.4. Settings for Android Auto *

The content of this manual represents the status of the user manual at the time of printing and may not be completely valid in future instances. For more information, refer to the first page for the complete disclaimer note.

Settings for an Android device that has been connected for the first time with Android Auto^[1].

Automatic start

- 1 Press **Settings** in the top view.
- 2 Press **Communication** → **Android Auto** and select setting:
 - Tick the box - Android Auto starts automatically when the USB cable is connected.
 - Untick the box - Android Auto does not start automatically when the USB cable is connected.

A maximum of 20 Android devices can be stored in the list. When the list is full and a new device is connected the oldest one is deleted.

A factory reset has to be executed in order to clear the list.

System volumes

- 1 Press **Settings** in the top view.
- 2 Tap on **Sound** → **System Volumes** and make the settings for the following:
 - **Voice Control**
 - **Navi Voice Guidance**
 - **Phone Ringtone**

* Option/accessory.

^[1] Availability may vary depending on market.

13.3.4. Settings for Bluetooth devices

Settings for Bluetooth-connected devices.

- 1 Press **Settings** in the top view.
- 2 Press **Communication** → **Bluetooth Devices** and select settings:

- **Add device** - starts the pairing of a new device.
- **Previously paired devices** - lists registered/paired devices.
- **Remove device** - removes the connected device.
- **Allowed services for this device** - sets device usage options: calling, sending/receiving messages, streaming media and as Internet connection.
- **Internet connection** - connects the car to the Internet via the device's Bluetooth connection.

 **Note**

Some phones require that the phone's Bluetooth volume is manually set to 100% in order for the audio volume in the car to be sufficiently high. This setting needs to be made for each phone connected. The setting is made once for phone calls and once for streaming media. The system will then remember the setting and it does not need to be repeated next time the phone is connected.

13.3.5. Bluetooth compatibility with phones

Bluetooth is a wireless technology that enables connectivity between multiple media devices. To connect a phone to Volvo's Bluetooth system, the phone must be compatible with the car.

Compatible phones and functions

Not all phones are compatible with Volvo's Bluetooth system. The phones that can be connected to Volvo's Bluetooth system may also have different functions, and not all functions in the system are available on all phones.

13.3.6. Connect the car to the Internet via a Bluetooth-enabled phone

Create an Internet connection via Bluetooth by sharing your phone's Internet access and access several online services in the car.

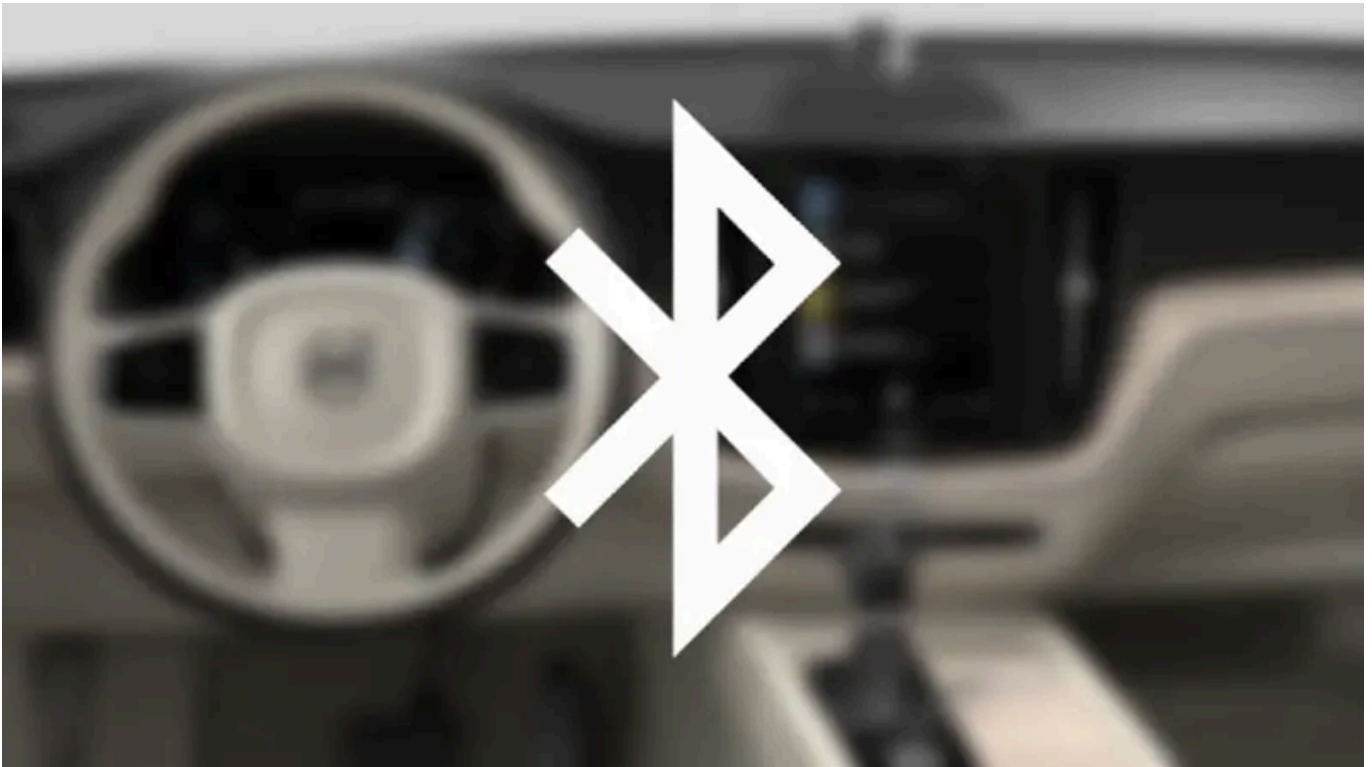

- 1 To be able to connect the car to the Internet via a Bluetooth-connected phone, the phone has to have already been connected to the car via Bluetooth for a first time.
 - 2 Make sure that your phone supports tethering and that this function is activated. On an iPhone, this function is known as "tethering". On Android phones, this function may have different names but is frequently known as "hotspot". For iPhones, the menu page "tethering" must also be open until the Internet connection has been established.
 - 3 If the phone has been connected via Bluetooth previously, press **Settings** in the centre display top view.
 - 4 Press **Communication** → **Bluetooth Devices**.
 - 5 Tick the box for **Bluetooth Internet connection** under the heading **Internet connection**.
 - 6 If another connection source has been used, confirm the option to change connection.
- Your car is now connected to the Internet via the Bluetooth-connected phone.

 **Note**

The telephone and network provider must support tethering (Internet connection sharing), and the subscription must include data.

Note

When using Apple CarPlay, it is only possible to connect the car to the Internet using Wi-Fi or the car modem*.

* Option/accessory.

13.3.7. Phone

A phone with Bluetooth can be connected wirelessly to the car's built-in hands-free system.

The audio and media system acts as hands-free, with the facility to remotely control a selection of the phone's functions. The phone can still be operated with its own keys even if it is connected to the car.

When a phone has been connected online and connected with the car, it can be used make calls, send/receive messages, play back media wirelessly and be used as an Internet connection.

The phone is operated from the centre display, but also via voice recognition and the app menu, which are accessed from the right-hand steering wheel keypad.

Overview

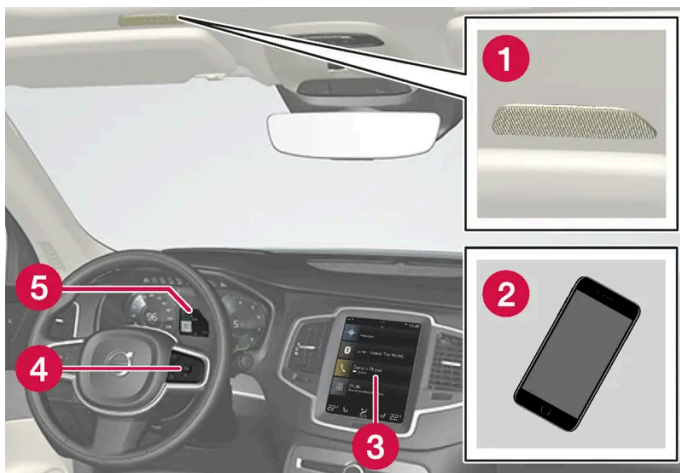

- 1 Microphone.
- 2 Phone.
- 3 Phone operation from centre display.
- 4 Keypad for operating phone functions that are shown in the driver display and voice recognition.
- 5 Driver display.

13.3.8. Controlling a telephone with voice recognition

The content of this manual represents the status of the user manual at the time of printing and may not be completely valid in future instances. For more information, refer to the first page for the complete disclaimer note.

Call a contact, have messages read aloud or dictate brief messages with voice control commands to a Bluetooth connected telephone. ^[1]

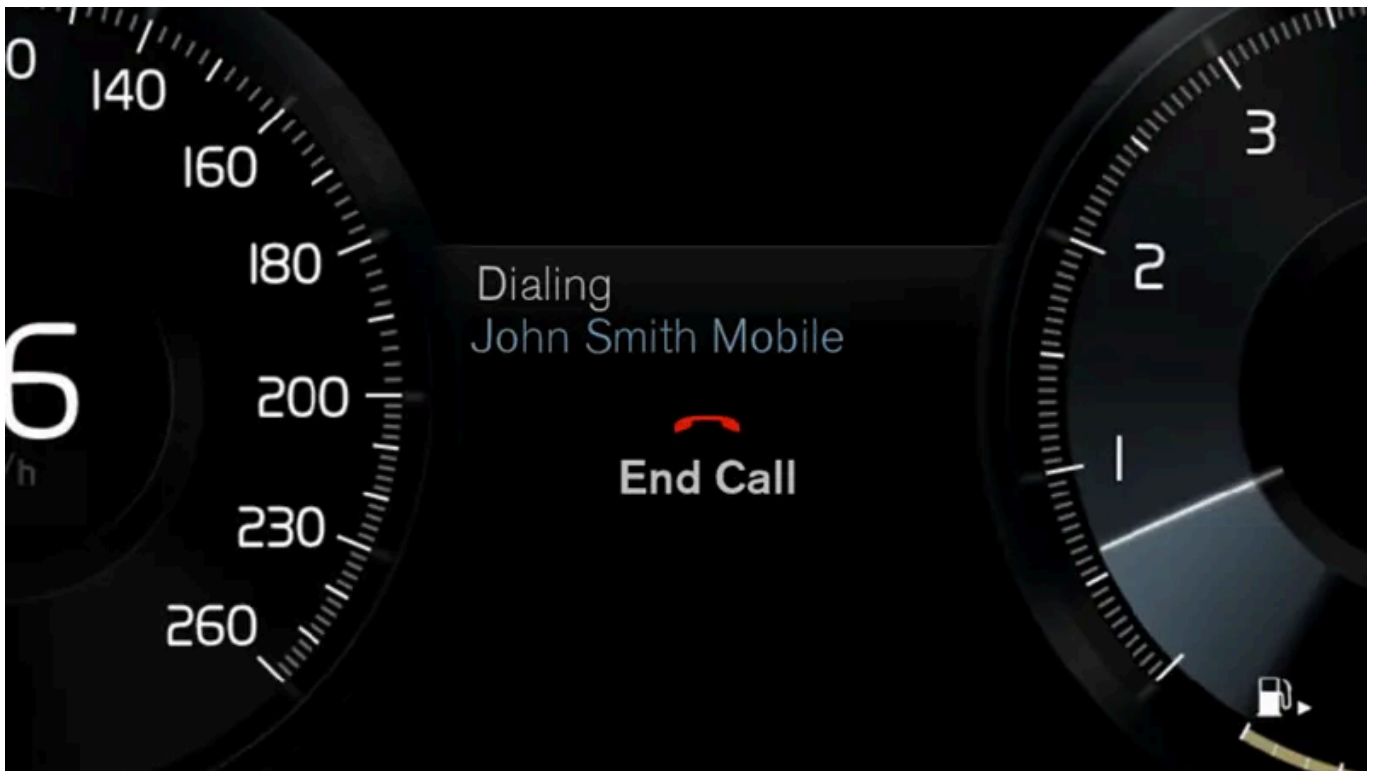

To specify a contact in the phone book, the voice recognition command must include contact information that is entered in the phone book. If a contact, e.g. **Robyn Smith**, has several phone numbers then the number category can also be stated, e.g. Home or Mobile: "Call RobinSmithMobile".

Press  and say one of the following commands:

- "Call [contact]" - dials the selected contact from the phone book.
- "Call[phone number]" - dials the phone number.
- "Recent calls" - displays the call list.
- "Read message" - message is read out. If there are several messages - select which message should be read out.
- "Message to [contact]" - the user is prompted to speak a short message. The message is then repeated aloud and the user can choose to send^[2] or revise the message. For this function to work, the car must be connected to the Internet.

 **Note**

Not all system languages support voice recognition. The ones that do are highlighted with the  symbol in the list of available system languages. Read more about where the information can be found in the section on settings for voice recognition.

^[1] Applies to certain markets.

^[2] Only certain phones can send messages via the car.

13.3.9. Settings for phone

When the telephone is connected to the car, the following settings can be made:

- 1 Press **Settings** in the top view.
- 2 Press **Communication** → **Phone** and select settings:
 - **Ringtones** - select ringtone. It is possible to use a ringtone from the phone or the car. Some phones are not fully compatible and their ringtones may therefore not be available for use in the car.
 - **Sort Order** - select sort order of contact list.

 **Note**

Some phones require that the phone's Bluetooth volume is manually set to 100% in order for the audio volume in the car to be sufficiently high. This setting needs to be made for each phone connected. The setting is made once for phone calls and once for streaming media. The system will then remember the setting and it does not need to be repeated next time the phone is connected.

Call notifications in head up display*

- 1 Tap on **Settings** in the centre display's top view.

The content of this manual represents the status of the user manual at the time of printing and may not be completely valid in future instances. For more information, refer to the first page for the complete disclaimer note.

2 Press **My Car** → **Displays** → **Head-Up Display Options**.

3 Select **Show Phone**.

* Option/accessory.

13.3.10. Managing the phone book

When a phone is connected to the car with Bluetooth, contacts can be managed directly in the centre display.

Up to 3000 contacts can be shown from the phone selected in the centre display.

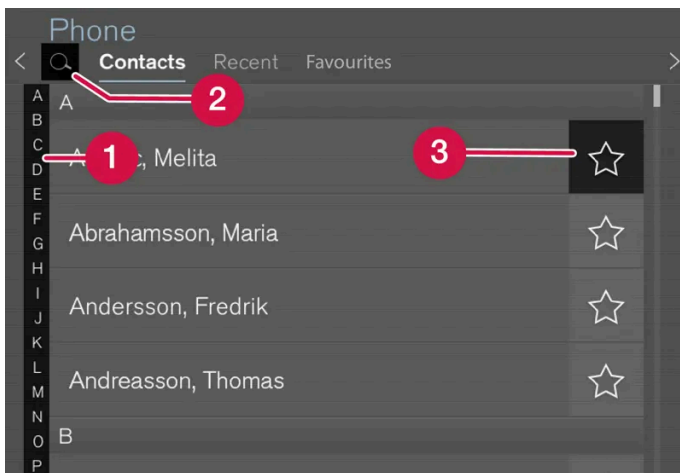

1 Browse between the letters and # to find a matching contact. Depending on existing contacts in the phone book, only matching letters are shown.

2 Search contacts - tap on  to search for a phone number or name in the contact list.

3 Favourites - tap on  to add/remove a contact to/from the favourites list.

Sorting

The contact list is sorted in alphabetical order where special characters and numbers are sorted under #. It is possible to sort by first name or surname, and this setting is adjusted in the telephone setup.

13.3.11. Managing phone calls

Call handling in the car for a Bluetooth-connected phone.

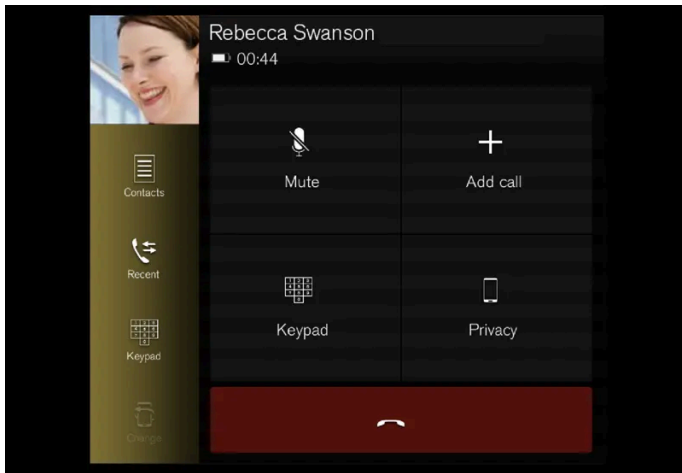

The figure is schematic.

Making phone calls

- 1 Open the subview for phone.
- 2 Select call from call history, enter number using the keypad or via the contact list. It is possible to search or browse in the contact list. Tap on ☆ in the contact list in order to add a contact under **Favourites**.
- 3 Press 📞 to make a call.
- 4 Tap on 📞 to end the call.

You can also make calls from the call log via the app menu, which is accessed from the right-hand steering wheel keypad 📞.

Making multi-party calls

During a call:

- 1 Press **Add call**.
- 2 Choose to make a call from the call log, favourites or the contact list.
- 3 Tap on an entry/row in the call log, or tap on 📞 alongside the contact in the contact list.
- 4 Tap on **Swap call** to switch between the parties.
- 5 Tap on 📞 to end the active call.

Conference calls

During an active multi-party call:

- 1 Tap on **Join calls** to merge the active multi-party call.
- 2 Tap on  to end the call.

Incoming phone calls

Incoming phone calls are shown in the driver display and the centre display. Manage the call on the right-hand steering wheel keypad or in the centre display.

- 1 Tap on **Answer/Reject**.
- 2 Tap on  to end the call.

Incoming phone call during an active call

- 1 Tap on **Answer/Reject**.
- 2 Tap on  to end the call.

Private call

- 1 During the current call, press **Privacy** and select setting:
 - **Switch to mobile phone** - the handsfree function is disconnected and the call continues on your mobile phone.
 - **Driver focused** - the microphone in the roof on the passenger side is switched off and the call continues with the car's handsfree function.

Note

Some phones require that the phone's Bluetooth volume is manually set to 100% in order for the audio volume in the car to be sufficiently high. This setting needs to be made for each phone connected. The setting is made once for phone calls and once for streaming media. The system will then remember the setting and it does not need to be repeated next time the phone is connected.

13.3.12. Managing text messages

Message handling in the car for a Bluetooth-connected phone. ^[1]

In some phones, the message function must be activated. Not all phones are compatible. In such cases, they cannot display contacts and messages in the car.

Managing text messages in the centre display

Text messages are only shown in the centre display if the setting is selected.

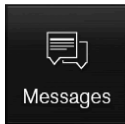

Press **Messages** in the app view to manage text messages in the centre display.

Reading text messages in the centre display



Press the icon to get the message read aloud.

Sending text messages in the centre display ^[2]

- 1 You can reply to a message or create a new message.
 - Reply to message - tap on the contact whose message you wish to reply to, then tap on **Answer**.
 - Create new message - tap on **Create new**. Select a contact or enter a number.
- 2 Compose the message.
- 3 Press **Send**.

Managing text messages in the driver display

Text messages are only shown in the driver display if the setting is selected.

Reading a new text message in the driver display

- 1 To have the message read aloud – select **Read out** with the steering wheel keypad.

Dictating a reply in the driver display

After the text message has been read out, it is possible to reply briefly with dictation if the car is connected to the Internet.

- 1 Press **Answer** with the steering wheel keypad. A dictation dialogue starts.

Message notification

It is possible to activate and deactivate notifications in the text message settings.

[1] Valid in certain markets only. Contact a Volvo dealer for more information.

[2] Only certain phones can send messages via the car. The connected phone must support the Bluetooth Message Access Profile (MAP).

13.3.13. Settings for text messages

Settings for text messages on connected phone.

- 1 Press **Settings** in the top view.
- 2 Press **Communication** → **Text Messages** and select settings:
 - **Notification in centre display** - shows message notifications in the centre display's status bar.
 - **Notification in driver display** - displays notifications in the driver's display and incoming messages can be managed using the steering wheel's right-hand keypad.
 - **Text message tone** - select tone for incoming text messages.

13.3.14. Wireless phone charger*

There is a charging plate for wireless phone charging located in the tunnel console.



A condition for being able to charge the phone is that it supports wireless charging (Qi). Phones not equipped with wireless charging receivers can often be supplemented with a shell that makes wireless charging possible.

Warning

Wireless charging may affect the operation of an implanted pacemaker or other medical devices. If you have one, it is recommended to consult with your doctor before using the wireless charging system.

* Option/accessory.

13.3.15. Using the wireless phone charger*

The rubber plate in the tunnel console makes it possible to charge a phone without the need to use the phone's cable.



Wireless phone charger in the tunnel console.

Warning

Wireless charging may affect the operation of an implanted pacemaker or other medical devices. If you have one, it is recommended to consult with your doctor before using the wireless charging system.

You can switch the charging plate on and off via the function view in the centre display. The default mode is that the charging plate is not activated. When the charging plate is switched on, a message is shown about the risks to users with an implanted pacemaker or other devices that could be affected by the charging plate. Confirm that the charging plate should be switched on in the centre display.

To use the wireless charging plate:

- 1 Check that the charging plate is switched on in the function view of the centre display.
- 2 Remove all other objects from the charging plate and position the phone in the centre of the charging plate.
- > Phone charging is started and the  symbol is shown at the top in the centre display.

 **Important**

Avoid storing cards with Near Field Communication (NFC), such as debit cards for contactless payment, together with the phone. This type of card can be destroyed when charging is in progress.

 **Note**

Some phones may become hot during wireless charging. This is normal.

If the phone does not charge:

- Check that the charging pad is switched on in the centre display.
- Check that the charging plate is free from other objects.
- Check that the phone supports wireless charging (Qi).
- Remove the case from the phone if one is fitted.
- Lift the phone and position it in the centre of the charging plate once again.
- Check that the car is running.
- Check that your phone has not slid off the charging pad while driving.
- If battery temperature becomes too high during charging, the charging function is deactivated.
- If any of the doors are opened, charging is interrupted for several seconds.

If the phone is positioned incorrectly, or if objects prevent charging on the charging plate, a message is shown in the centre display.

 **Important**

Keep the phone and charging plate free of other objects while charging to avoid overheating.

* Option/accessory.

13.3.16. Certificate for wireless charger

13.4. Apps

13.4.1. Available in-car apps

13.4.1.1. Android Auto*

Android Auto^[1] gives you the option to listen to music, make phone calls, get directions and use car-adapted apps from an Android device. Android Auto works with selected Android devices.

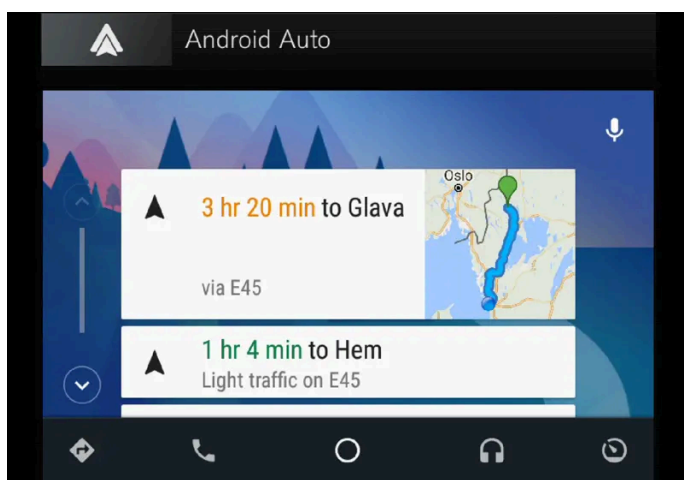

Information about which apps are supported and which Android devices are compatible is available on the website: www.android.com/auto/ [<https://www.android.com/auto/>]. For third-party apps, see Google Play. Please note that Volvo is not responsible for the content in Android Auto.

Android Auto is started from the app view. After Android Auto has been started once, the app will be started automatically the next time the device is connected. Automatic start can be deactivated under settings.

Note

When a device is connected to Android Auto it is possible to stream via Bluetooth to another media player. Bluetooth is active while Android Auto is being used.

When using map navigation via Android Auto there is no guidance in the driver display or head-up display, but only in the centre display.

Android Auto can be controlled via the centre display using the steering wheel's right-hand keypad or voice control. Holding down the steering wheel button  starts Google Assistant and a short press deactivates it.

By using Android Auto, you acknowledge the following: Android Auto is a service provided by Google Inc. under its terms and conditions. Volvo Cars is not responsible for Android Auto or its features or applications. When you use Android Auto, your car transfers certain information (including its location) to your connected Android phone. You are fully responsible for your and any other person's use of Android Auto.

* Option/accessory.

^[1] Availability may vary depending on market.

13.4.1.2. Available apps

Volvo provides a wide selection of services, apps and programs that you can use in your car.

Sensus Connect gives you access to apps for entertainment, navigation and service in the car. To see which apps are available for download, go to **Download Centre** in the car's centre display^[1].

Tips for using apps

Many apps need an online connection to use certain functions^[2].

If you notice that an app stops working, try uninstalling and reinstalling the app.

Note

The range of apps available may vary depending on market. Support for services from Volvo's third-party suppliers may also vary. One or more apps may not be available on the market in which the car is sold or used.

^[1] Availability may vary depending on market.

^[2] Data is transferred (data traffic) when using the Internet, and this may involve a cost.

13.4.1.3. Apple[®] CarPlay[®] *

CarPlay^[1] gives you the option to listen to music, make phone calls, get directions, send/receive messages and use Siri, all while you stay focused on your driving.

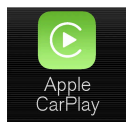



CarPlay works with selected iOS devices. If the car does not already support CarPlay there is the option to install it retroactively. Contact a Volvo dealer to install CarPlay.

Information about which apps are supported and which iOS devices are compatible is available on Apple's website: www.apple.com/ios/carplay/ [<https://www.apple.com/ios/carplay/>]. Using apps that are not compatible with CarPlay may sometimes mean that the connection between the device and the car is broken. Please note that Volvo is not responsible for the content in CarPlay.

When using map navigation via CarPlay, there is no guidance in the driver display or head-up display, but only in the centre display.

When navigation is started through Apple CarPlay, ongoing native turn-by-turn route guidance will be ended.

The content of this manual represents the status of the user manual at the time of printing and may not be completely valid in future instances. For more information, refer to the first page for the complete disclaimer note.

The CarPlay apps can be controlled via the centre display, the iOS device or using the steering wheel's right-hand keypad (applies to certain functions). The apps can also be voice-controlled using Siri. A long press on the steering wheel button  starts voice control using Siri and a short press activates the car's own voice control. If Siri breaks off too early, hold the steering wheel button  ^[2] depressed.

By using Apple CarPlay you acknowledge the following: Apple CarPlay is a service provided by Apple Inc. under its terms and conditions. Volvo Cars is thus not responsible for Apple CarPlay or its features/applications. When using Apple CarPlay, certain information from your car (including its position) is transferred to your iPhone. In relation to Volvo Cars, you are fully responsible for your and any others person's use of Apple CarPlay.

* Option/accessory.

^[1] Availability may vary depending on market.

^[2] Apple and CarPlay are registered trademarks owned by Apple Inc.

13.4.1.4. Air Quality app

The Air Quality app is a service that visualises the measured content of small airborne particulate matter inside the car over time.

A climate sensor measures the content of PM_{2.5} particles (particles smaller than 2.5 µm) in the passenger compartment*.

To be able to use this app, the following is required:

- The car must have access to the network for at least 1 minute when the app is started or the car is restarted.
- The car must be running in order for the PM_{2.5} sensor to take measurements.

* Option/accessory.

13.4.1.5. Google Local Search

Using the Google Local Search^[1] app you can search for restaurants, hotels and petrol stations and a lot more along your route directly in Volvo's centre display.

Functions in Google Local Search

Google Local Search is a free service. You do not need to register for access to the online database. However, you need an Internet connection to be able to use the service^[2].

Using the Google Local Search app you can, amongst other things, search for locations, restaurants, hotels and other businesses along the route and in the vicinity of your destination.

In Google Local Search you can see information on different search results such as addresses, distances, opening times and telephone numbers. The app includes the option to call a business directly from the car, and you can get directions to a destination.

The content of this manual represents the status of the user manual at the time of printing and may not be completely valid in future instances. For more information, refer to the first page for the complete disclaimer note.

tion by sending an address to Sensus Navigation.

In Google Local Search you can read, and in some cases listen to, reviews and see user ratings for, amongst other things, restaurants and hotels. You can also browse through and look at images linked to search results and you have access to photographs from Google Street View which can make it easier to find your way to a desired location or business.

Operating

Google Local Search can be used while you drive.

Tips for using Google Local Search

If you experience problems with Google Local Search, make sure you have an Internet connection and good signal strength.

^[1] Availability varies depending on market.

^[2] Data is transferred (data traffic) when using the Internet, and this may involve a cost.

13.4.1.6. Park and Pay

Park and Pay^[1] is an app that can help you find vacant parking spaces. In some cases, you can also pay for your parking via the app. Park and Pay can be used if the car is equipped with Sensus Connect and Sensus Navigation.

The Park and Pay app

You can use the Park and Pay app to search for vacant parking spaces and pay for your parking. The pay service works for the parking spaces that are connected to payment providers that are supported by Park and Pay. The spaces are displayed in the app with an icon in list view, and under "detailed information" for each parking space. You can also find information there on payment providers and parking identification.

Using Park and Pay

To use the Park and Pay app, an account does not need to be registered, but in order to be able to pay for parking via the app, you need to register on the payment provider's website.

The Park and Pay app is a free service, but you will be charged by the payment provider if you use the pay function. Note that a data usage costs may be incurred, depending on your subscription. Contact your Internet service provider for more information about the costs that apply for data usage.

Price example

A price example is shown in the detailed view for parking spaces, and the price may vary depending on time and date. The price stated once you have set the estimated time for parking is the actual cost of the parking for the estimated time.

Ending the parking stay

If you use a parking space where you only pay for the time you park then the app asks you to enter an estimated time for parking in advance, so that you avoid forgetting to end the parking stay. If you end the parking stay before the estimated time has elapsed then you only need to pay for the time you were parked^[2].

Tips for using Park and Pay

If you experience problems with Park and Pay, make sure you have an Internet connection and good signal strength.

^[1] Availability varies depending on market.

^[2] Only applicable to payment providers that support payment on completion of parking.

13.4.1.7. Record & Send

Record & Send^[1] is an in-car app that allows you to record personal voice messages and send them to a selected recipient.



Record and send recording

Two options are given when the app is started: enter recipient and record by tapping on the microphone symbol.

- 1 Tap on **Recipient** and enter the e-mail address the recording shall be sent to.
 - 2 Tap on the microphone symbol to start recording.
 - 3 Say the message.
 - 4 Tap on the microphone symbol again to end the recording.
- The option appears to send or discard the recording.

Opening the voice recording

When the recording has been sent, the recipient receives an e-mail message that can be opened in a normal e-mail program, either on a mobile or in a computer. The recording is included as an attached file in MP3 format.

Open software

Use the LAME open software library to compress your recordings in MP3 format. You can find out more about LAME on their website: www.mp3dev.org.

^[1] Availability varies depending on market.

13.4.1.8. Spotify

You can use the Spotify^[1] app in your Volvo to listen to music when the car has an Internet connection.



Getting started with Spotify

To use Spotify requires a Spotify Premium account. Currently, it is not possible to create an account from the app in the car, but you can easily create an account from the Spotify website. If you already have a Spotify Premium account then you can of course use it.

Internet connection when using Spotify

To use Spotify in your car, the app must have access to the Internet. Offline mode is currently not available.

Sound quality

You can choose which sound quality you prefer in the app's settings. You can choose between Normal, High and Extreme sound quality.

- Normal (96 kbps)
- High (160 kbps)

- Extreme (320 kbps)

Functions

The Spotify app offers a range of options and functions, such as:

- Free text searching
- Auto search
- Play/Pause/Resume
- Browse through albums, playlists, news, etc.
- Add/remove tracks from the library
- Logging in/out
- Skip between tracks
- Spotify Connect
- Spotify Radio

Note

Volvo does not save information that is used in the Spotify app with the exception of locally stored data that is necessary for the app to work. Your password is never saved and if you have logged out of the app you must enter both your username and password to login again.

Deleting user information

To delete user information, logout from the Spotify app via the Settings menu. The user information is also deleted during a factory reset of the centre display.

Tips for using Spotify

If you experience problems with Spotify, make sure you have an Internet connection and good signal strength.

^[1] Availability varies depending on market.

13.4.1.9. TuneIn

TuneIn^[1] is a radio app that can be used when the car has an Internet connection. TuneIn offers over 100,000 global live radio stations from all continents and over two million on-demand programmes (e.g. podcasts, concerts and interviews).

TuneIn account

When using TuneIn, you are recommended to have a TuneIn account, which can be created at www.tunein.com. You do not need to have a TuneIn account to be able to use the service, but it is recommended. An account will allow you to choose your preferred radio stations which you can then easily listen to in your car.

Sound quality

You can choose a stream quality among basic, medium to high bitrates. The amount of bandwidth used depends on which quality you choose, see specifications below.

Speed (kbps)	Duration (hours)	Size (MB)
32 (Basic sound quality)	1	14
64 (Basic sound quality)	1	28
96 (Medium sound quality)	1	42
128 (High sound quality)	1	56

Tips for using TuneIn

If you experience problems with TuneIn, make sure you have an Internet connection and good signal strength.

^[1] Availability varies depending on market.

13.4.1.10. Using TuneIn

The Internet radio service TuneIn^[1] has several different functions. You can, for example, play local radio, add favourites to radio stations or create shortcuts to radio stations if you prefer. This article describes how you use these services and how you access them from your car.

Starting TuneIn

- 1 Download the TuneIn app from **Download Centre** in the app view.
- 2 Open the TuneIn app in the app view.
 - The car connects to TuneIn. The music buffers the first time you connect, which can take several seconds.

Access your account information for TuneIn

- 1 Open the TuneIn app in the app view.
- 2 Expand the view and click on **Sign in**.

The content of this manual represents the status of the user manual at the time of printing and may not be completely valid in future instances. For more information, refer to the first page for the complete disclaimer note.

- A pop-up box opens, where you can log in.
- 3** Enter your username and password, then press **Sign in**.
- You can now access account information.

TuneIn categories

TuneIn makes it easy to scroll through different categories.

- 1** Open the TuneIn app in the app view.
- 2** Expand the view and click on **Library**.
- A list of stations and categories is shown.

TuneIn favourites

If you are logged in to TuneIn in the car, your selected favourites will be synchronised with your account. Otherwise your selected favourites will only be available in the car.

- 1** In Expanded view: Click on the radio station you want to set as a favourite.
- 2** Mark the star icon on the right.
- The station has now been added to your favourites.

^[1] Availability varies depending on market.

13.4.1.11. Weather

The Weather ^[1] app provides you with weather information in the car's local area or in a selected location. Weather can only be used if the car is equipped with Sensus Navigation.

The Weather app

Weather gives you daily and weekly weather forecasts. You set the location for which you want updated weather in the app settings. You can access the settings in the display mode for the app. You can also change settings for measuring wind speed here.

Using Weather

Weather is a free service and you do not need to register an account to use the service.

Note that a data usage cost may be incurred, depending on your subscription. Contact your Internet service provider for more information.

Tips for using Weather

If you experience problems with Weather, make sure you have an Internet connection and good signal strength.

^[1] Availability varies depending on market.

13.4.1.12. WikiLocations

Using the WikiLocations ^[1] app, you can read Wikipedia articles that are related to your car's position and destination.

The WikiLocations app

Using WikiLocations, you have access to content based on Wikipedia. This is a service which does not form part of the car's navigation system, but you can view items, images and summaries related to your car's position and destination.

The items shown in WikiLocations have been assigned a geographical location. WikiLocations only shows items which match the car's language settings, as well as items in English.

Using WikiLocations

WikiLocations is a free service ^[1] and you do not need an account to use the service.

Note that a data usage cost may be incurred, depending on your subscription. Contact your Internet service provider for more information.

Use the steering wheel knob for safer use of the app while you drive.

Tips for using WikiLocations

If you experience problems with WikiLocations, make sure you have an Internet connection and good signal strength.

^[1] Availability varies depending on market.

13.4.1.13. Yelp

You can use the Yelp^[1] app to find local companies (e.g. restaurants or shops) and can read other users' ratings and reviews of companies near to you. Yelp can only be used if the car is fitted with both Sensus Connect and Sensus Navigation.

The Yelp app

You can use Yelp to search for e.g. restaurants, shops, spas and local services. You can read reviews on companies that you are interested in and would like to know more about.

Note that the display of reviews depends on the language they were written in.

Using Yelp

Yelp is a free service and you do not need to register an account to use the service.

Note that a data usage cost may be incurred, depending on your subscription. Contact your Internet service provider for more information on what applies for your subscription.

Use the steering wheel knob for safer use of the app while you drive.

Search for companies nearby

To search for companies near to your destination, this destination needs to be set in your navigation system.

Try to use specific terms to make your search results as good as possible, since the free text search matches both the name of the company and the text in the reviews.

Tips for using Yelp

If it is not possible to start navigation to a selected company, this is probably because Yelp does not have information about the company's precise position. The same is true if it is not possible to display the location on the map.

If you experience problems with Yelp, make sure you have an Internet connection with good signal strength.

^[1] Availability varies depending on market.

13.4.1.14. Car status

The general status of the car can be shown in the centre display.

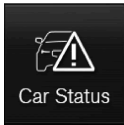

The **Car Status** app is started from app view in the centre display and has four tabs:

- **Messages** - status messages
- **Status** – checking engine oil level and AdBlue level^[1]
- **TPMS** - checking the tyre pressure
- **Appointments** - appointment information and car information^[2]

^[1] AdBlue Applies to cars with diesel engines.

^[2] Applies to certain markets.

13.4.1.15. Download Center

Use the Download Centre app in the car's centre display to handle software^[1] such as apps and maps.

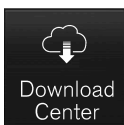
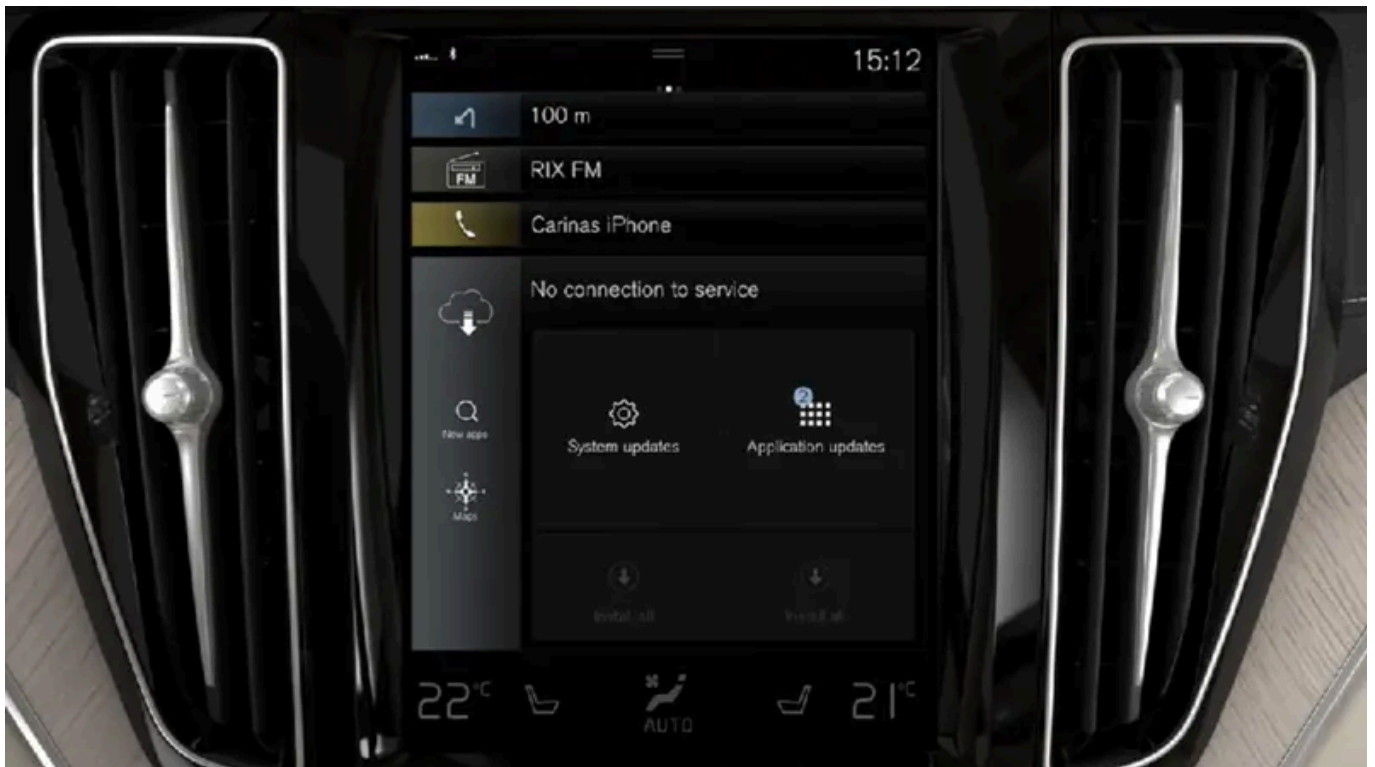

Download Centre is started from the app view in the centre display and enables:

- searching for and updating specific software

- updating map data for Sensus Navigation *
- downloading, updating and uninstalling apps.

^[1] Data is transferred (data traffic) when using the Internet, and this may involve a cost.

* Option/accessory.

13.4.2. Apps

The app view contains apps that give access to some of the car's services.

Swipe from right to left^[1] across the centre display's screen in order to access the app view from the home view. Apps that

have been downloaded (third-party apps) and apps for embedded functions, such as FM radio, are found here.

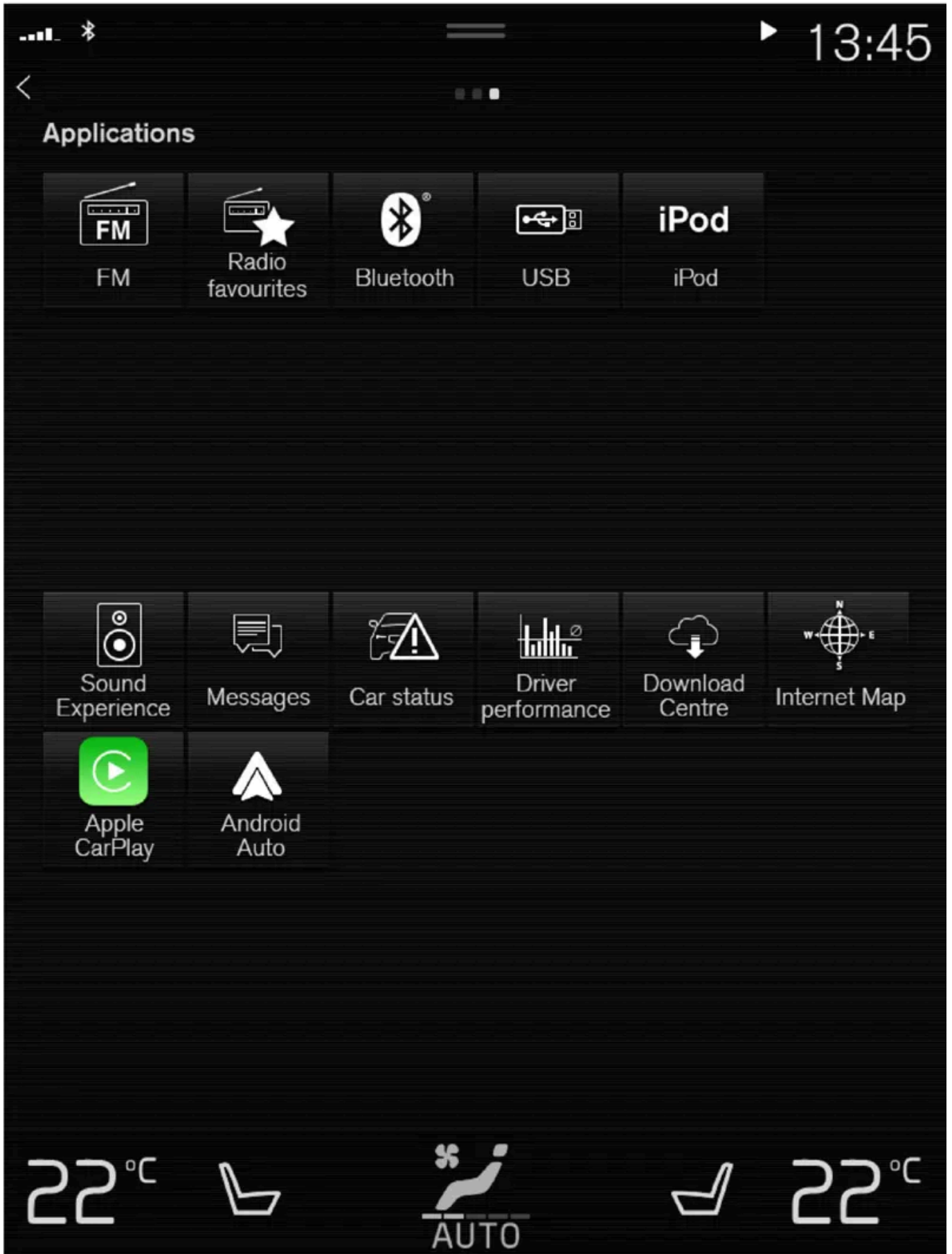

App view (schematic image, basic apps vary by market and model)

Some basic apps are always available. More apps such as web radio and music services can be downloaded when the car is connected to the Internet.

Certain apps are only available for use if the car is connected to the Internet.

Start an app by tapping on it.

All the apps used should be updated to the latest version.

^[1] Applies to left-hand drive cars. For right-hand drive cars - swipe in the opposite direction.

13.4.3. Downloading apps

New apps can be downloaded when the car is connected to the Internet.

Note

Data download may affect other services that transmit data, e.g. Internet radio. If the effect on other services is experienced as disruptive then the download can be interrupted. Alternatively, it may be appropriate to switch off or interrupt other services.

Note

When downloading using a phone, pay extra attention to the data traffic costs.

- 1 Open the **Download Centre** app in the app view.



- 2 Select **New apps** in order to open a list of apps that are available but not installed in the car.
 - 3 Tap on the row for an app in order to expand in the list and get more information about the app.
 - 4 Select **Install** in order to start the download and installation of the desired app.
- The status of the download and installation is shown while it is in progress.
A message is shown if a download cannot be started for the moment. The app will remain in the list and it is possible to try to start a download again.

Cancelling the download

- 1 Tap on **Abort** to cancel a download in progress.

Note that only the download can be cancelled, when the installation phase has started, this cannot be cancelled.

13.4.4. Deleting apps

Apps can be uninstalled when the car is connected to the Internet.

An app that is being used must be closed in order for the uninstallation to be completed.

- 1 Open the **Download Centre** app in the app view.



- 2 Select **Application updates** in order to open a list of all installed apps.
- 3 Locate the desired app and select **Uninstall** in order to start the uninstallation of the app.
 - > When the app has been uninstalled, it disappears from the list.

13.4.5. Updating apps

The apps can be updated when the car is connected to the Internet.

i Note

Data download may affect other services that transmit data, e.g. Internet radio. If the effect on other services is experienced as disruptive then the download can be interrupted. Alternatively, it may be appropriate to switch off or interrupt other services.

i Note

When downloading using a phone, pay extra attention to the data traffic costs.

If an app is being used during an ongoing update, it will be restarted in order for the installation to be completed.

Update all

- 1 Open the **Download Centre** app in the app view.



- 2 Select **Install all**.
 - > Updating is started.

Update some

- 1 Open the **Download Centre** app in the app view.
- 2 Select **Application updates** in order to open a list of all available updates.
- 3 Locate the desired app and select **Install**.
 - > Updating is started.

13.4.6. Volvo ID

Volvo ID is a personal ID that gives access to a wide range of services via a single username and password.

Note

The services available may vary over time and depend on equipment level and market.

One example of a service when Volvo ID is needed is when checking the car on your phone using the Volvo Cars app^[1].

Note

If the username/password for a service (e.g. Volvo On Call) is changed, then it is also changed automatically for other services.

Volvo ID is created from the car, volvoid.eu.volvocars.com/Account [https://volvoid.eu.volvocars.com/Account/] or the Volvo Cars app.

When a Volvo ID is registered in the car, several services will be made available. Several Volvo IDs can be used for the same car and several cars can even be connected to the same Volvo ID.

* Option/accessory.

The content of this manual represents the status of the user manual at the time of printing and may not be completely valid in future instances. For more information, refer to the first page for the complete disclaimer note.

[1] If you have Volvo On Call*.

13.4.7. Creating a Volvo ID

It is possible to create a Volvo ID in different ways. If the Volvo ID is created at [volvoid.eu.volvocars.com/Account \[https://volvoid.eu.volvocars.com/Account/\]](https://volvoid.eu.volvocars.com/Account/) or with the Volvo Cars app, the Volvo ID must also be registered to the car in order to enable use of the various Volvo ID services.

Create a Volvo ID with the Volvo ID app

- 1 Download the Volvo ID app from **Download Centre** in the centre display's app view.
- 2 Start the app and register a personal email address or mobile number.
- 3 Follow the instructions that are automatically sent to the specified email address/mobile number.
 - A Volvo ID has now been created and automatically registered to the car. Volvo ID services can now be used.

Create a Volvo ID with the Volvo Cars app

- 1 Download the latest version of the Volvo Cars app to the phone^[1].
- 2 Select to create Volvo ID.
- 3 The web page for creating a Volvo ID is shown.
- 4 Enter a personal email address or mobile number.
- 5 Follow the instructions that are automatically sent to the specified email address/mobile number.
 - A Volvo ID has now been created and is ready for use.

Create a Volvo ID via the Volvo Cars website

- 1 Go to [volvoid.eu.volvocars.com/Account \[https://volvoid.eu.volvocars.com/Account/\]](https://volvoid.eu.volvocars.com/Account/). Select to create a Volvo ID.
- 2 Enter a personal email address or mobile number.
- 3 Follow the instructions that are automatically sent to the specified email address/mobile number.
 - A Volvo ID has now been created and is ready for use.

Registering your Volvo ID to the car

If your Volvo ID was created online or using the Volvo Cars app, register it to your car:

- 1 If not done already, download the Volvo ID app from **Download Centre** in the centre display's app view.

 **Note**

To download apps, the car must be connected to the Internet.

- 2 Start the app and enter your Volvo ID.
 - 3 Follow the instructions that are automatically sent to the email address/mobile number linked to your Volvo ID.
- Your Volvo ID is now registered to the car. Volvo ID services can now be used.

^[1] Available to download via e.g. Apple App Store or Google Play.

13.5. Internet connection

13.5.1. Online services

13.5.1.1. Connected Safety

Connected Safety^[1] communicates information between your own car and other vehicles via the Internet^[2]. The function is intended to make a driver aware that there may be a potentially dangerous traffic situation further ahead on the same road.

The function can inform the driver whether another vehicle further ahead on the same road has activated its hazard warning flashers or detected slippery driving conditions. Information about slippery driving conditions is also given if your own car detects slippery surfaces.

Connected Safety can help the driver with the following:

- Alarm on hazard warning flashers
- Alarm on slippery driving conditions

Connected Safety communication between vehicles only works for vehicles equipped with the function and which have it activated.

Alarm on hazard warning flashers

The content of this manual represents the status of the user manual at the time of printing and may not be completely valid in future instances. For more information, refer to the first page for the complete disclaimer note.

If your own car's hazard warning flashers are activated, information about this can be sent to vehicles approaching your own car's position.



When your own car is approaching a vehicle with flashing hazard warning flashers, this symbol is shown on the driver display.

In vehicles with head-up display, the warning symbols for Connected Safety are also shown there.

Alarm on slippery driving conditions

If your own car detects reduced friction between your tyres and the road, information on this can be sent to vehicles approaching your own car's position.



If an ice alert is triggered, this symbol is displayed on the Driver display when a vehicle approaches the slippery road section, both in your own car and in other vehicles that have received the information via Connected Safety.

In vehicles with head-up display, the warning symbols for Connected Safety are also shown there.

Warning

- The function is supplementary driver support intended to facilitate driving and make it safer – it cannot handle all situations in all traffic, weather and road conditions.
- The driver is advised to read all sections in the Owner's Manual that relate to this function to learn about factors such as its limitations and what the driver should be aware of before using the system.
- Driver support functions are not a substitute for the driver's attention and judgement. The driver is always responsible for ensuring the car is driven in a safe manner, at the appropriate speed, with an appropriate distance to other vehicles, and in accordance with current traffic rules and regulations.

^[1] Not available on all markets.

^[2] Data is transferred (data traffic) when using the Internet, and this may involve a cost.

13.5.1.2. Apps

The app view contains apps that give access to some of the car's services.

Swipe from right to left^[1] across the centre display's screen in order to access the app view from the home view. Apps that

have been downloaded (third-party apps) and apps for embedded functions, such as FM radio, are found here.

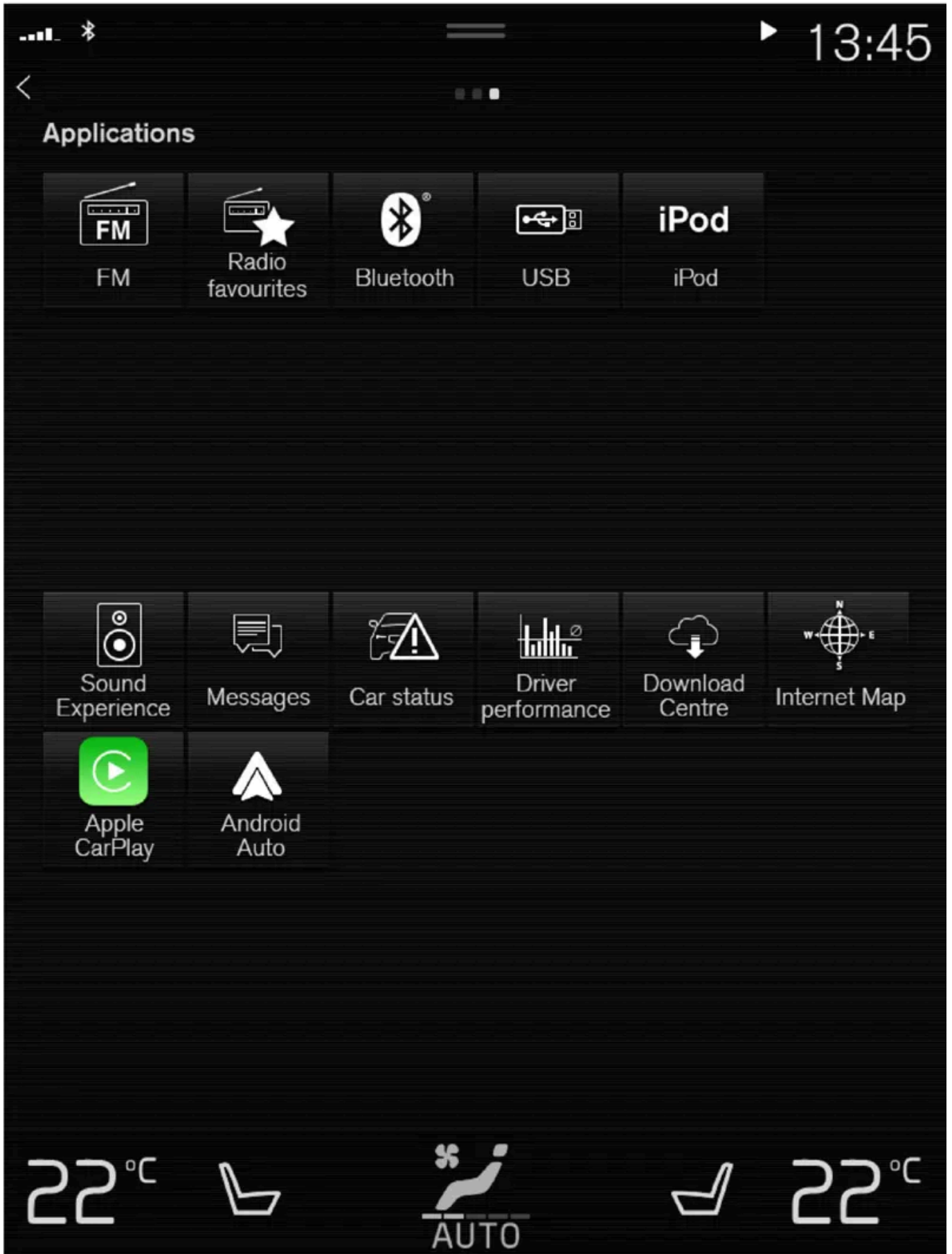

App view (schematic image, basic apps vary by market and model)

Some basic apps are always available. More apps such as web radio and music services can be downloaded when the car is connected to the Internet.

Certain apps are only available for use if the car is connected to the Internet.

Start an app by tapping on it.

All the apps used should be updated to the latest version.

^[1] Applies to left-hand drive cars. For right-hand drive cars - swipe in the opposite direction.

13.5.1.3. User terms and conditions and data sharing

The first time certain services and apps are started, a pop-up window with the headings **Terms and conditions** and **Data sharing** may be shown.

The purpose is to inform about Volvo's user terms and conditions and policy for data sharing. By accepting data sharing, the user accepts that certain information is sent from the car. This is required so that certain services and apps can have full functionality.

The data sharing function for online services and apps is deactivated as default^[1]. Data sharing needs to be activated so that certain online services and apps in the car can be used. Data sharing can be set from the centre display's settings menu or in connection with the services or apps being started in the centre display.

Privacy and data sharing

With the software update made available November 2017, privacy and data sharing settings were introduced for online services and downloaded apps. The settings can be found under **Privacy and data** in the settings menu in the car's centre display.

There you can select the online services which are allowed to share data. Data sharing for downloaded apps can also be deactivated there. Note that services and apps cannot be used as intended if data sharing is deactivated.

After a factory reset or e.g. a workshop visit or software update, the data sharing settings may have been reset to their default settings. In which case, reactivate data sharing for online services and for downloaded apps.

 **Note**

Privacy and data sharing settings are unique for every driver profile.

* Option/accessory.

^[1] Does not apply to Volvo On Call*.

13.5.1.4. Activating and deactivating data sharing

The content of this manual represents the status of the user manual at the time of printing and may not be completely valid in future instances. For more information, refer to the first page for the complete disclaimer note.

Data sharing for services and apps required can be set in the centre display's settings menu.

- 1 Tap on **Settings** in the centre display's top view.
- 2 Press **System** → **Privacy and data**.
- 3 Select activation or deactivation of data sharing for individual services and all apps.

If data sharing has not been activated for an online service or downloaded apps, this can be done when they are started in the centre display. If this is the first time a service is started, or e.g. after a factory reset or certain software updates, Volvo's terms and conditions for online services need to be approved. Note that data sharing will then also be activated for other services or apps for which sharing has already been approved.

 **Note**

After a visit to a Volvo workshop, you may need to reactivate data sharing so that the online services and apps shall work again.

13.5.1.5. Data sharing for Volvo On Call

Data sharing for the Volvo On Call service is activated as standard. This means that you do not need to activate data sharing for this service yourself when you buy a new car or after e.g. a factory reset.

You can choose yourself to deactivate data sharing for Volvo On Call. Note that most of the Volvo On Call functions need to be able to share data for you to be able to use them. If you have paired the Volvo Cars app with your car, a notification is shown in the app if the data sharing function is deactivated for Volvo On Call.

The data sharing settings are only activated as standard for your Volvo On Call services. Sharing of data for your other online services and downloaded apps will continue to be deactivated and will need to be selected for activation in order to enable their use.

13.5.1.6. Data sharing for driver profile

When you start to use a new driver profile, the data sharing settings for the profile will be set to the car's standard settings and deactivated.

If you choose to start to use a new driver profile, data sharing needs to be activated for the online services to be used by the profile. This also applies if you have previously activated data sharing for online services in other driver profiles.

On some occasions, after a workshop visit or after a software update, some settings in your car may have been reset to their standard settings. Since the data sharing settings are unique to each driver profile, data sharing needs to be reactivated individually for each profile.

The content of this manual represents the status of the user manual at the time of printing and may not be completely valid in future instances. For more information, refer to the first page for the complete disclaimer note.

 **Note**

When you buy a Volvo, the dealer can often provide assistance with settings in the car and go through the various setting options with you as customer. Among other things, this could mean that data sharing was already activated for connected services in the new car at the time of delivery.

If you then start to use a new driver profile, the data sharing settings for the new profile will be deactivated and need to be activated for the connected services that shall be used. This also applies to data sharing settings for downloaded apps.

Check which driver profile is in use

The data sharing settings may have different appearances in different driver profiles in your car. For example, a profile may have data sharing activated for only one online service, while another has the function activated for all services and downloaded apps.

If you notice that some apps or online services do not seem to work properly in your car, e.g. if you are repeatedly prompted to allow data sharing for certain functions, check which driver profile is active and the services for which the profile has activated data sharing.

You can change driver profile under **Profile** in the top view in your centre display.

You can always choose to activate data sharing for the online services you want available to use in a driver profile, but if the profile's settings are protected and saved then all changes you make will be temporary. This is because all settings for a protected driver profile will return to the last saved value when the car is switched off and locked.

To save changes made in a protected driver profile, go to **Settings** → **System** → **Driver Profiles** → **Edit Profile** in your centre display and tap to save changes for the profile at the bottom of the screen.

13.5.1.7. Data sharing for services

If you have not activated data sharing for an online service or for downloaded apps, you can do this in connection with starting them in your centre display. If this is the first time you are starting a service, or e.g. after a factory reset or certain software updates, you also need to approve Volvo's terms and conditions for online services.

Activate data sharing when you start a service

- 1** Select the function or service to be activated.
 - If this is the first time you are using the service and also after e.g. a factory reset or certain software updates, you first

need to approve Volvo's terms and conditions for online services in order to continue.

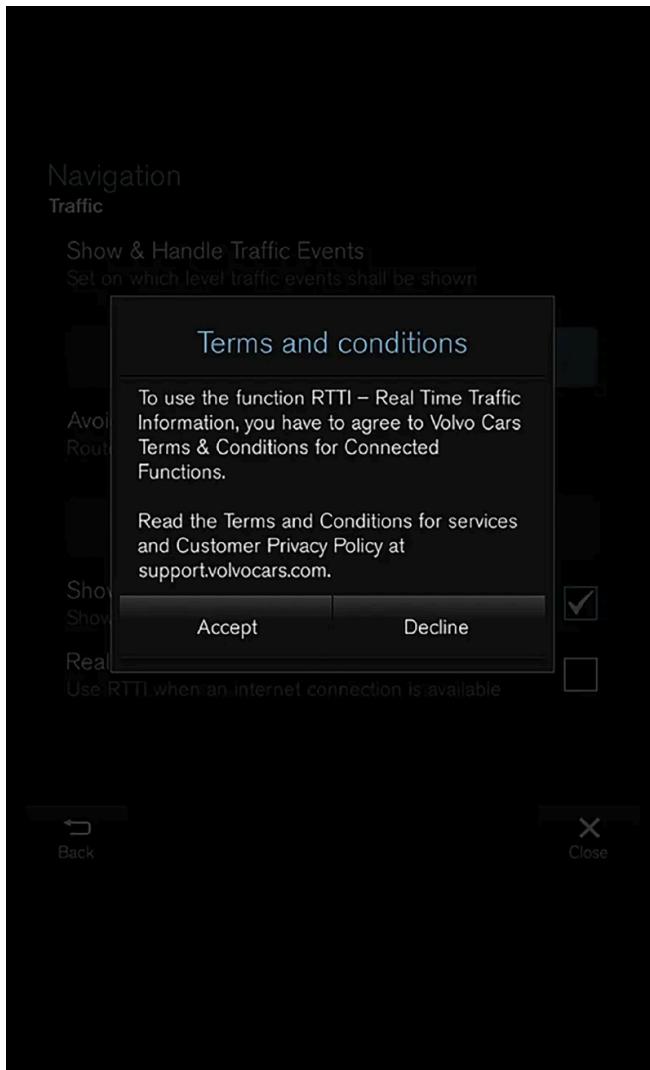

- 2 Select to approve data sharing for the service or to cancel.

If you select to approve, data sharing is activated and you can start to use the service.

Activate data sharing when you start an app

To approve data sharing for an app that needs the function, start the app and tap on **Allow** in the pop-up window.

You can deactivate data sharing for services and apps in the settings menu under **System** → **Privacy and data** → **Data Sharing**.

13.5.1.8. Volvo ID

Volvo ID is a personal ID that gives access to a wide range of services via a single username and password.

i Note

The services available may vary over time and depend on equipment level and market.

One example of a service when Volvo ID is needed is when checking the car on your phone using the Volvo Cars app^[1].

i Note

If the username/password for a service (e.g. Volvo On Call) is changed, then it is also changed automatically for other services.

Volvo ID is created from the car, volvoid.eu.volvocars.com/Account [https://volvoid.eu.volvocars.com/Account/] or the Volvo Cars app.

When a Volvo ID is registered in the car, several services will be made available. Several Volvo IDs can be used for the same car and several cars can even be connected to the same Volvo ID.

* Option/accessory.

^[1] If you have Volvo On Call*.

13.5.1.9. Creating a Volvo ID

It is possible to create a Volvo ID in different ways. If the Volvo ID is created at volvoid.eu.volvocars.com/Account [https://volvoid.eu.volvocars.com/Account/] or with the Volvo Cars app, the Volvo ID must also be registered to the car in order to enable use of the various Volvo ID services.

Create a Volvo ID with the Volvo ID app

- 1 Download the Volvo ID app from **Download Centre** in the centre display's app view.
 - 2 Start the app and register a personal email address or mobile number.
 - 3 Follow the instructions that are automatically sent to the specified email address/mobile number.
- A Volvo ID has now been created and automatically registered to the car. Volvo ID services can now be used.

Create a Volvo ID with the Volvo Cars app

- 1 Download the latest version of the Volvo Cars app to the phone^[1].
- 2 Select to create Volvo ID.

The content of this manual represents the status of the user manual at the time of printing and may not be completely valid in future instances. For more information, refer to the first page for the complete disclaimer note.

- 3 The web page for creating a Volvo ID is shown.
 - 4 Enter a personal email address or mobile number.
 - 5 Follow the instructions that are automatically sent to the specified email address/mobile number.
- A Volvo ID has now been created and is ready for use.

Create a Volvo ID via the Volvo Cars website

- 1 Go to volvoid.eu.volvocars.com/Account [<https://volvoid.eu.volvocars.com/Account/>]. Select to create a Volvo ID.
 - 2 Enter a personal email address or mobile number.
 - 3 Follow the instructions that are automatically sent to the specified email address/mobile number.
- A Volvo ID has now been created and is ready for use.

Registering your Volvo ID to the car

If your Volvo ID was created online or using the Volvo Cars app, register it to your car:

- 1 If not done already, download the Volvo ID app from **Download Centre** in the centre display's app view.

 **Note**

To download apps, the car must be connected to the Internet.

- 2 Start the app and enter your Volvo ID.
 - 3 Follow the instructions that are automatically sent to the email address/mobile number linked to your Volvo ID.
- Your Volvo ID is now registered to the car. Volvo ID services can now be used.

^[1] Available to download via e.g. Apple App Store or Google Play.

13.5.1.10. Real Time Traffic Information

When the car is connected to the Internet, the driver can access extended traffic information^[1] (RTTI^[2]) concerning congestion, closed roads and anything else that may affect the travelling time.

The content of this manual represents the status of the user manual at the time of printing and may not be completely valid in future instances. For more information, refer to the first page for the complete disclaimer note.

If the RTTI service has been activated, information on traffic incidents and traffic flow will be retrieved constantly from an Internet service. When a car requests traffic flow information, anonymous data about the traffic flow at the car's position is provided at the same time, which contributes to the function of the service. The anonymous data is only sent when RTTI is activated. No data is provided if this service is not activated.

The service may need to be activated again, e.g. after certain software updates, after workshop visits or when creating a new driver profile.

Current traffic conditions are shown in the navigation system* for motorways, major roads and extra-urban roads, as well as certain intercity routes.

The amount of traffic information shown on the map depends on the distance to the car and is only shown within approximately 120 km (75 miles) from the car's position.

Text and symbols on the map are shown as usual and the traffic flow shows how quickly the traffic is moving on a road compared with the road's speed limit. The traffic flow is shown on the map on each side of the road with one coloured line per travel direction:

- Green - no disruptions.
- Orange - slow traffic.
- Red - congestion/traffic jam/accident.
- Black - road closed.

 **Note**

Traffic information is not available in all areas/countries.

Coverage areas for traffic information are being increased continuously.

^[1] Applies to certain markets.

^[2] Real Time Traffic Information

* Option/accessory.

13.5.1.11. Volvo On Call*

Volvo On Call^[1] provides direct contact to the car as well as extra comfort and assistance 24 hours a day.

The functions are available via the Volvo Cars app^[2] as well as the ON CALL button and the SOS button in the roof of the car:



For example, you can lock and unlock the car directly from a phone via the Volvo Cars app. If an accident occurs, emergency assistance can be sent to the car, e.g. ambulance or police. Roadside assistance can be called for less urgent problems, such as a puncture.

i Note

The SOS button must only be used in the event of accident, illness or an external threat against the car and its passengers. The SOS function is only intended for emergency situations. Abuse may lead to supplementary charges.

The Volvo Cars app and ON CALL button can be used for all other services^[3], including roadside assistance.

Volvo On Call system

Volvo On Call is linked to the car's safety and alarm systems as well as other systems in the car, such as locking and climate control. The car has a built-in modem for communication with a Volvo On Call service centre and the Volvo Cars app. GNSS (Global Navigation Satellite System) is used to locate the car.

Processing of personal data

Certain information, including personal data, will need to be processed in order to be able to make use of all the functions in connection with the Volvo On Call service. Read more about terms and conditions and privacy at [volvocars.com/intl/legal](https://www.volvocars.com/intl/legal) [<https://www.volvocars.com/intl/legal>].

Contact service centre

Use the car's ON CALL button or the Volvo Cars app to contact the Volvo On Call service centre.

i Note

All calls with the Volvo On Call service centre may be recorded.

* Option/accessory.

^[1] Availability depends on market.

The content of this manual represents the status of the user manual at the time of printing and may not be completely valid in future instances. For more information, refer to the first page for the complete disclaimer note.

[2] Available functions vary depending on the market.

[3] Available services vary depending on the market.

13.5.2. Tips for using the Bluetooth connection

If you find that the connection or functionality between your car and the Bluetooth device does not work as expected, the following tips may be of assistance.

When connecting a mobile device to the car via Bluetooth

If you experience difficulties when connecting a mobile device to the car via Bluetooth:

- Check that the device's battery is sufficiently charged (a good idea can be to check that the device is charged to at least 50%)
- Check that you have Bluetooth switched on in your device and in the car
- Check that you have established a Bluetooth connection and have connected the car to the device to be used
- If possible, try to connect another device to the car via Bluetooth in order to check whether the problem is in the device or in the car

If the problem persists:

1. Clear all previously added devices in the Bluetooth settings in the car
2. Restart the device you want to connect
3. Try to connect the device again

Playback of media via Bluetooth

If you have problems with the playback of media in the car via a mobile device:

- Try restarting the app or the source from which you want to play back media
- By playing back media from another source on the mobile device, you can check whether the problem is in the source or in the device
- Change the position of the device and check whether the playback works better
- Close apps that are open in the background
- Restart the device from which you want to play back media

If none of the above seems to help, check the Bluetooth connection between the mobile device and the car. See the section "When connecting a mobile device to the car via Bluetooth".

Audio volume

If you find that the volume is lower than expected when you use the handsfree function via Bluetooth, first check whether it is the sound settings on the mobile device that need to be adjusted up before increasing the audio volume in the car.

Note

Some phones require that the phone's Bluetooth volume is manually set to 100% in order for the audio volume in the car to be sufficiently high. This setting needs to be made for each phone connected. The setting is made once for phone calls and once for streaming media. The system will then remember the setting and it does not need to be repeated next time the phone is connected.

13.5.3. Connect the car to the Internet via a Bluetooth-enabled phone

Create an Internet connection via Bluetooth by sharing your phone's Internet access and access several online services in the car.

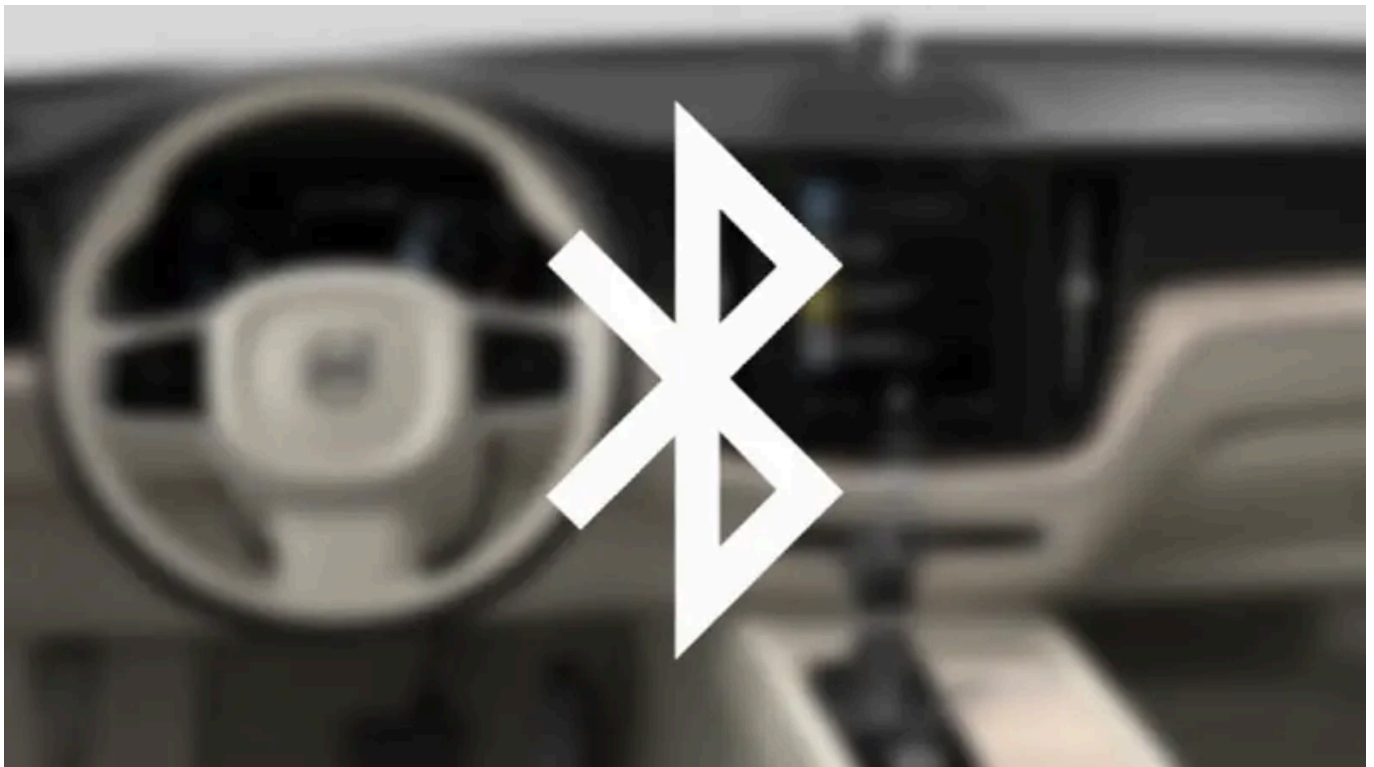

- 1 To be able to connect the car to the Internet via a Bluetooth-connected phone, the phone has to have already been connected to the car via Bluetooth for a first time.
- 2 Make sure that your phone supports tethering and that this function is activated. On an iPhone, this function is known as "tethering". On Android phones, this function may have different names but is frequently known as "hotspot". For iPhones, the menu page "tethering" must also be open until the Internet connection has been established.
- 3 If the phone has been connected via Bluetooth previously, press **Settings** in the centre display top view.
- 4 Press **Communication** → **Bluetooth Devices**.
- 5 Tick the box for **Bluetooth Internet connection** under the heading **Internet connection**.

The content of this manual represents the status of the user manual at the time of printing and may not be completely valid in future instances. For more information, refer to the first page for the complete disclaimer note.

6 If another connection source has been used, confirm the option to change connection.

> Your car is now connected to the Internet via the Bluetooth-connected phone.

Note

The telephone and network provider must support tethering (Internet connection sharing), and the subscription must include data.

Note

When using Apple CarPlay, it is only possible to connect the car to the Internet using Wi-Fi or the car modem*.

* Option/accessory.

13.5.4. Internet-connected car*

When the car is connected to the Internet, it is possible – for example – to use web radio and music services via apps, download software and contact your retailer from the car.

The car is connected via Bluetooth, Wi-Fi or with the car's built-in modem* (SIM card).

When the car is connected to the Internet, it is possible to share the car's Internet connection (Wi-Fi hotspot) so that other devices such as tablets can access the Internet^[1].

The Internet status is indicated by a symbol in the centre display's status bar.



i Note

Data is transferred when using the internet (data traffic), which can have a cost.

Activation of data roaming can result in further charges.

Contact your network operator about the cost for data traffic.

i Note

When using Apple CarPlay, it is only possible to connect the car to the Internet using Wi-Fi or the car modem*.

i Note

When using Android Auto, it is possible to connect the car to the Internet using Wi-Fi, Bluetooth or the car modem*.

Before connecting the car to the Internet, search support information on terms and conditions for services and privacy policy for customers at [volvocars.com \[https://www.volvocars.com/\]](https://www.volvocars.com/).

* Option/accessory.

^[1] This does not apply in the case of connection with Wi-Fi.

13.5.5. Tips in the event of problems with Internet connection

Here you can find tips that may be useful if you encounter problems when you try to connect the car to the Internet.

- If the clock has been reset, e.g. after the current to the battery has been disconnected during a visit to a service workshop, you need to set it again before you can connect to the Internet.
- Certain phones deactivate tethering after contact with the car has been disconnected, e.g. if the phone sharing the Wi-Fi network is taken out of the car. To reconnect to the Internet, activate tethering (portable/personal hotspot) in the phone.
- Volvo On Call*-connected cars can connect to the Internet via car modem (P-SIM). If the connection is interrupted, the car will automatically attempt to reconnect to the Internet.

* Option/accessory.

13.5.6. Sharing Internet access from the car via a Wi-Fi hotspot

When the car is online, its Internet connection can be shared to allow other devices to use it^[1].

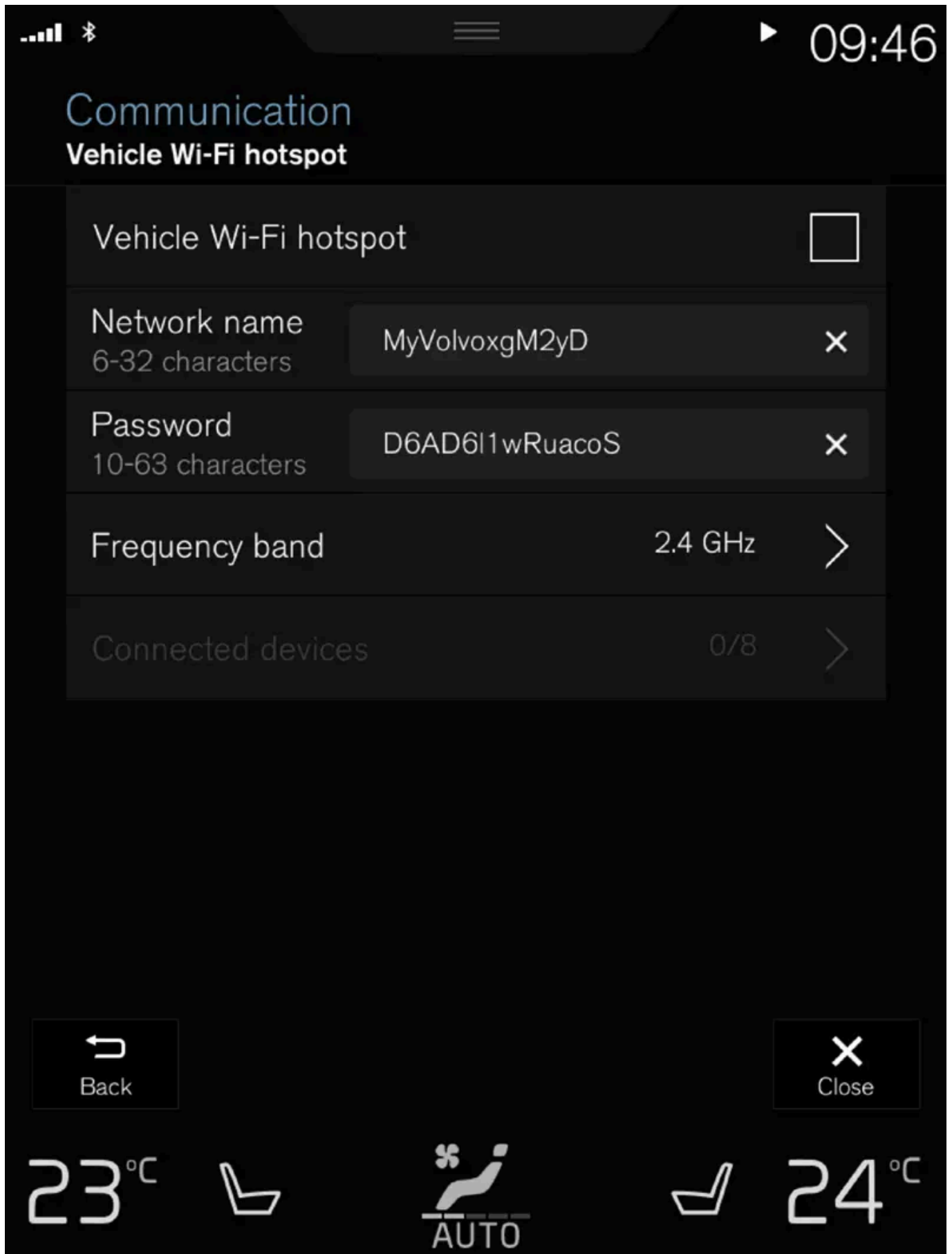

The network operator (SIM card) must support tethering (sharing of the Internet connection).

- 1 Press **Settings** in the top view.
 - 2 Press **Communication** → **Car Wi-Fi Hotspot**.
 - 3 Tap on **Network name** and name the shared connection.
 - 4 Tap on **Password** and select a password to be entered on connecting devices.
 - 5 Tap on **Frequency band** and select the frequency on which the hotspot is to transmit data. Note that selection of frequency band is not available in all markets.
 - 6 Activate/deactivate by ticking/unticking the box for **Car Wi-Fi Hotspot**.
 - 7 If Wi-Fi has been used as a connection source, confirm the option to change connection.
- It is now possible for external devices to connect to the car's tethering (Wi-Fi hotspot).

 **Note**

Activation of Wi-Fi-hotspot can result in further charges from your network operator.

Contact your network operator about the cost for data traffic.

Connection status is indicated by the symbol in the centre display's status bar.

Press **Connected devices** to see a list of the currently connected devices.

^[1] Does not apply when the car is online via Wi-Fi.

13.5.7. Connect the car to the Internet via a phone (Wi-Fi)

Create an Internet connection via Wi-Fi by tethering your phone and access online services in the car.



- 1 Make sure that your phone supports tethering and that this function is activated. On an iPhone, this function is known as "tethering". On Android phones, this function may have different names but is frequently known as "hotspot". For iPhones, the menu page "tethering" must also be open until the Internet connection has been established.
 - 2 Press **Settings** in the top view.
 - 3 Continue to **Communication** → **Wi-Fi**.
 - 4 Activate/deactivate by ticking/unticking the box for Wi-Fi.
 - 5 If another connection source has been used, confirm the option to change connection.
 - 6 Tap on the network name of the network to be connected.
 - 7 Enter the network password.
- The car connects to the network.

Note that certain phones switch off tethering after the contact with the car has been disconnected, e.g. when leaving the car and until the next time it is used. The tethering in the phone therefore needs to be reactivated the next time it is used.

When a phone is connected to the car, it is saved for future use. To show a list of saved networks or manually delete saved networks, go to **Settings** → **Communication** → **Wi-Fi** → **Saved networks**.

Note

The telephone and network provider must support tethering (Internet connection sharing), and the subscription must include data.



Technical and safety requirements for Wi-Fi connection, are described in a separate section.

13.5.8. Connect the car to the Internet via car modem (SIM card)

It is possible to establish an Internet connection via the car modem and a personal SIM card (P-SIM)*.



Cars equipped with Volvo On Call will use the Internet connection with car modem for the services.



1 Fit a personal SIM card into the holder.

Note that a **mini SIM** is required to fit the car's card reader.

- 2 Press **Settings** in the top view.
 - 3 Press **Communication** → **Car Modem Internet**.
 - 4 Activate/deactivate by ticking/unticking the box for **Car modem Internet**.
 - 5 If another connection source has been used, confirm the option to change connection.
 - 6 Enter the SIM card's PIN code.
- The car connects to the network.

i Note

Note that the SIM card used for Internet connection via P-SIM cannot have the same telephone number as the SIM card that the phone uses. If this is disregarded, it will not be possible to route calls correctly to the telephone. Therefore, use a SIM card with a separate telephone number for the Internet connection, or a data card that does not handle telephone calls and is therefore unable to disrupt the function of the telephone.

* Option/accessory.

13.5.9. Settings for car modem*

The car is equipped with a modem that can be used to connect the car to the Internet. It is also possible to share the Internet connection via Wi-Fi.

- 1 Press **Settings** in the top view.
- 2 Press **Communication** → **Car Modem Internet** and select settings:

- **Car modem Internet** - select whether to use the car modem as Internet connection.
- **Data usage** - tap on **Reset** resets the counters for received and sent data volume.
- **Network**

Select network operator - automatic or manual selection of network operator.

Data roaming - if the box is ticked, the car modem will attempt to connect to the Internet when the car is abroad and outside its home network. Note that this may result in heavy costs. Check your roaming agreement for data traffic abroad with your network provider in your home country.

- **SIM card PIN**

Change PIN - a maximum of 4 digits can be entered.

Disable PIN - select whether the PIN code shall be required for access to the SIM card.

- **Send request code** — used e.g. to top up or check the balance on a prepaid card. Functionality depends on the provider.

 **Note**

Note that the SIM card used for Internet connection via P-SIM cannot have the same telephone number as the SIM card that the phone uses. If this is disregarded, it will not be possible to route calls correctly to the telephone. Therefore, use a SIM card with a separate telephone number for the Internet connection, or a data card that does not handle telephone calls and is therefore unable to disrupt the function of the telephone.

* Option/accessory.

13.5.10. No or poor Internet connection

Factors that affect the Internet connection.

The amount of data transferred is dependent on the services or apps in use in the car. For example, streaming audio can require large amounts of data which requires a good connection and good signal strength.

Phone to car

The speed of the Internet connection may vary depending on the location of the phone in the car. Move the phone closer to the centre display in order to increase the signal strength. Ensure that there is no source of interference in between.

Phone to network operator

The content of this manual represents the status of the user manual at the time of printing and may not be completely valid in future instances. For more information, refer to the first page for the complete disclaimer note.

The speed of the mobile network varies depending on the coverage in the present location. Poor network coverage may occur, for example in tunnels, in mountainous country, in deep valleys or indoors. The speed also depends on the agreement you have with your network.

Note

In the event of problems with data traffic, contact your network operator.

Restarting the phone

If there are problems with the Internet connection then it may help to restart the phone.

13.5.11. Remove Wi-Fi network

Removing a network that is not to be used.

- 1 Press **Settings** in the top view.
 - 2 Continue to **Communication** → **Wi-Fi** → **Saved networks**.
 - 3 Tap on **Forget** alongside the network to be removed.
 - 4 Confirm the selection.
- The car will no longer connect to the network in future.

Remove all networks

All networks can be removed simultaneously by restoring factory settings. Please note that all user data and system settings are reset to original factory settings.

13.5.12. Wi-Fi technologies and security

Possible network types to connect to.

It is only possible to connect to the following types of network:

- Frequency — 2.4 or 5 GHz^[1].
- Standards — 802.11 a/b/g/n.
- Security type — WPA2-AES-CCMP.

The content of this manual represents the status of the user manual at the time of printing and may not be completely valid in future instances. For more information, refer to the first page for the complete disclaimer note.

The car's Wi-Fi system is designed to handle Wi-Fi devices inside the car.

If several devices operate on the frequency at the same time then it may result in reduced performance.

[1] Selection of frequency is not available on all markets.

13.6. Sound, media and Internet

The audio and media system consists of media player and radio. You can also connect a phone via Bluetooth to use handsfree functions or play music wirelessly in the car. When the car is connected to the Internet you can also use apps for media playback.



Overview of audio and media

Control the functions with your voice, steering wheel keypad or the centre display. The number of speakers and amplifiers depends on which audio system the car is equipped with.

System updating

The audio and media system is continuously improved. It is recommended to download system updates when new ones are available.

13.7. License agreement for audio and media

A license is an agreement for the right to operate a certain activity or the right to use someone else's entitlement according to the terms and conditions in the agreement. The following texts are Volvo's agreements with manufacturers/developers.

Bowers & Wilkins



Bowers & Wilkins and B&W are trademarks of the B&W Group Ltd. Nautilus is a trademark of B&W Group Ltd. Continuum is a trademark of Bowers & Wilkins. Trademarks of Bowers & Wilkins applicable in selected markets.

Dirac Unison®



Dirac Unison co-optimises the loudspeakers in frequency, time and space for the best possible bass integration and clarity. It enables a faithful reproduction of the acoustic characteristics of specific performance venues. Using advanced algorithms, Dirac Unison controls all loudspeakers digitally based on acoustic high-precision measurements. Like a conductor of an orchestra, it guarantees that the loudspeakers perform in perfect unison.

DivX®



DivX®, DivX Certified® and associated logotypes are trademarks belonging to DivX, LLC and are used under licence.

This DivX Certified® device can play back DivX® Home Theater video files up to 576p (including .avi, .divx). Download free software on www.divx.com to create, play back and stream digital video.

ABOUT DIVX VIDEO-ON-DEMAND: This DivX Certified® device must be registered in order to play back purchased DivX Video-on-Demand (VOD) films. Get the registration code by locating the DivX VOD section in the device's settings menu. Go to vod.divx.com for more information on how to complete the registration.

Patent numbers

Protected by one or more of the following US patents. 7,295,673; 7,460,668; 7,515,710; 8,656,183; 8,731,369; RE45,052.

Gracenote®



Portions of the content are copyright © of Gracenote or its suppliers.

The content of this manual represents the status of the user manual at the time of printing and may not be completely valid in future instances. For more information, refer to the first page for the complete disclaimer note.

Gracenote, the Gracenote logo and logotype, "Powered by Gracenote" and Gracenote MusicID are either registered trademarks or trademarks of Gracenote, Inc. in the United States and/or other countries.

Gracenote® End User License Agreement

This program or device contains software from Gracenote, Inc. of Emeryville, California, USA ("Gracenote"). The software from Gracenote ("Gracenote software") activates this program to perform disc and/or file identification and obtain music-related information, including name, artist, track and title ("Gracenote data") from online servers or embedded databases (together called "Gracenote servers") and in order to perform other actions. You may only use Gracenote data in accordance with the intended end-user functions for this program or this device.

You agree to only use Gracenote data, Gracenote software and Gracenote servers for your own personal non-commercial use. You agree not to assign, copy, transfer or transmit this Gracenote software or any Gracenote data to any third party. YOU AGREE NOT TO USE OR EXPLOIT GRACENOTE DATA, GRACENOTE SOFTWARE OR GRACENOTE SERVERS, EXCEPT AS EXPRESSLY PERMITTED IN THIS AGREEMENT.

You agree that your non-exclusive right to use Gracenote data, Gracenote software and Gracenote servers will be terminated if you violate these restrictions. If your license is terminated you agree to cease all use of Gracenote data, Gracenote software and Gracenote servers. Gracenote holds exclusive rights to all Gracenote data, all Gracenote software and all Gracenote servers, including all ownership rights. Gracenote will under no circumstances have any obligation to pay you for any information you provide. You agree that Gracenote, Inc. may enforce the company's rights under this agreement against you directly in its own name.

The Gracenote service uses a unique identifier to track enquiries for statistical purposes. The purpose of a randomly assigned numeric identifier is to enable the Gracenote service to count enquiries without knowing anything about who you are. Additional information is available on the web page for Gracenote's privacy policy for the Gracenote service.

The Gracenote software and everything included in Gracenote data are licensed to you "as is". Gracenote provides no undertakings or warranties, express or implied, as to the accuracy of the Gracenote data contained in the Gracenote servers. Gracenote reserves the right to delete data from the Gracenote servers or to change data categories for any reason that Gracenote deems sufficient. No warranty is provided that the Gracenote software or Gracenote servers are fault-free or that the Gracenote software or Gracenote servers will operate without interruption. Gracenote has no obligation to provide you with new, improved or additional data types or categories that Gracenote may provide in the future, and the company reserves the right to discontinue its services at any time.

GRACENOTE DISCLAIMS ALL WARRANTIES, EITHER EXPRESS OR IMPLIED, INCLUDING, BUT NOT LIMITED TO, THE IMPLIED WARRANTIES OF MERCHANTABILITY, FITNESS FOR A PARTICULAR PURPOSE, TITLE AND NON-INFRINGEMENT OF INTELLECTUAL PROPERTY RIGHTS. GRACENOTE DOES NOT GUARANTEE THE RESULTS OBTAINED THROUGH YOUR USE OF THE GRACENOTE SOFTWARE OR A GRACENOTE SERVER. GRACENOTE WILL IN NO EVENT BE LIABLE FOR ANY CONSEQUENTIAL DAMAGE OR FOR ANY LOST PROFITS OR REVENUES.

© Gracenote, Inc. 2009

Sensus software

This software uses parts of sources from clib2 and Prex Embedded Real-time OS - Source (Copyright (c) 1982, 1986, 1991, 1993, 1994), and Quercus Robusta (Copyright (c) 1990, 1993), The Regents of the University of California. All or some portions are derived from material licensed to the University of California by American Telephone and Telegraph Co. or Unix System Laboratories, Inc. and are reproduced herein with the permission of UNIX System Laboratories, Inc. Redistribution and use in source and binary forms, with or without modification, are permitted provided that the following conditions are met: Redistributions of source code must retain the above copyright notice, this list of conditions and the following disclaimer. Redistributions in binary form must reproduce the above copyright notice, this list of conditions and the following disclaimer in the documentation and/or other materials provided with the distribution. Neither the name of the <ORGANIZATION> nor the names of its contributors may be used to endorse or promote products derived from this software without specific prior writ-

The content of this manual represents the status of the user manual at the time of printing and may not be completely valid in future instances. For more information, refer to the first page for the complete disclaimer note.

ten permission. THIS SOFTWARE IS PROVIDED BY THE COPYRIGHT HOLDERS AND CONTRIBUTORS "AS IS" AND ANY EXPRESS OR IMPLIED WARRANTIES, INCLUDING, BUT NOT LIMITED TO, THE IMPLIED WARRANTIES OF MERCHANTABILITY AND FITNESS FOR A PARTICULAR PURPOSE ARE DISCLAIMED. IN NO EVENT SHALL THE COPYRIGHT OWNER OR CONTRIBUTORS BE LIABLE FOR ANY DIRECT, INDIRECT, INCIDENTAL, SPECIAL, EXEMPLARY, OR CONSEQUENTIAL DAMAGES (INCLUDING, BUT NOT LIMITED TO, PROCUREMENT OF SUBSTITUTE GOODS OR SERVICES; LOSS OF USE, DATA, OR PROFITS; OR BUSINESS INTERRUPTION) HOWEVER CAUSED AND ON ANY THEORY OF LIABILITY, WHETHER IN CONTRACT, STRICT LIABILITY, OR TORT (INCLUDING NEGLIGENCE OR OTHERWISE) ARISING IN ANY WAY OUT OF THE USE OF THIS SOFTWARE, EVEN IF ADVISED OF THE POSSIBILITY OF SUCH DAMAGE.

This software is based in part on the work of the Independent JPEG Group.

This software uses parts of sources from "libtess". The Original Code is: OpenGL Sample Implementation, Version 1.2.1, released January 26, 2000, developed by Silicon Graphics, Inc. The Original Code is Copyright (c) 1991-2000 Silicon Graphics, Inc. Copyright in any portions created by third parties is as indicated elsewhere herein. All Rights Reserved. Copyright (C) [1991-2000] Silicon Graphics, Inc. All Rights Reserved. Permission is hereby granted, free of charge, to any person obtaining a copy of this software and associated documentation files (the "Software"), to deal in the Software without restriction, including without limitation the rights to use, copy, modify, merge, publish, distribute, sublicense, and/or sell copies of the Software, and to permit persons to whom the Software is furnished to do so, subject to the following conditions: The above copyright notice including the dates of first publication and either this permission notice or a reference to <http://oss.sgi.com/projects/FreeB/> shall be included in all copies or substantial portions of the Software. THE SOFTWARE IS PROVIDED "AS IS", WITHOUT WARRANTY OF ANY KIND, EXPRESS OR IMPLIED, INCLUDING BUT NOT LIMITED TO THE WARRANTIES OF MERCHANTABILITY, FITNESS FOR A PARTICULAR PURPOSE AND NONINFRINGEMENT. IN NO EVENT SHALL SILICON GRAPHICS, INC. BE LIABLE FOR ANY CLAIM, DAMAGES OR OTHER LIABILITY, WHETHER IN AN ACTION OF CONTRACT, TORT OR OTHERWISE, ARISING FROM, OUT OF OR IN CONNECTION WITH THE SOFTWARE OR THE USE OR OTHER DEALINGS IN THE SOFTWARE. Except as contained in this notice, the name of Silicon Graphics, Inc. shall not be used in advertising or otherwise to promote the sale, use or other dealings in this Software without prior written authorization from Silicon Graphics, Inc.

This software is based in parts on the work of the FreeType Team.

This software uses parts of SSLeay Library: Copyright (C) 1995-1998 Eric Young (eay@cryptsoft.com). All rights reserved

Linux software

This product contains software licensed under GNU General Public License (GPL) or GNU Lesser General Public License (LGPL), etc.

You have the right of acquisition, modification, and distribution of the source code of the GPL/LGPL software.

You may download Source Code from the following website at no charge: http://www.embedded-carmultimedia.jp/linux/oss/download/TVM_8351_013

The website provides the Source Code "As Is" and without warranty of any kind.

By downloading Source Code, you expressly assume all risk and liability associated with downloading and using the Source Code and complying with the user agreements that accompany each Source Code.

Please note that we cannot respond to any inquiries regarding the source code.

camellia:1.2.0

Copyright (c) 2006, 2007

NTT (Nippon Telegraph and Telephone Corporation). All rights reserved.

The content of this manual represents the status of the user manual at the time of printing and may not be completely valid in future instances. For more information, refer to the first page for the complete disclaimer note.

Redistribution and use in source and binary forms, with or without modification, are permitted provided that the following conditions are met:

1. Redistributions of source code must retain the above copyright notice, this list of conditions and the following disclaimer as the first lines of this file unmodified.
2. Redistributions in binary form must reproduce the above copyright notice, this list of conditions and the following disclaimer in the documentation and/or other materials provided with the distribution.

THIS SOFTWARE IS PROVIDED BY NTT "AS IS" AND ANY EXPRESS OR IMPLIED WARRANTIES, INCLUDING, BUT NOT LIMITED TO, THE IMPLIED WARRANTIES OF MERCHANTABILITY AND FITNESS FOR A PARTICULAR PURPOSE ARE DISCLAIMED. IN NO EVENT SHALL NTT BE LIABLE FOR ANY DIRECT, INDIRECT, INCIDENTAL, SPECIAL, EXEMPLARY, OR CONSEQUENTIAL DAMAGES (INCLUDING, BUT NOT LIMITED TO, PROCUREMENT OF SUBSTITUTE GOODS OR SERVICES; LOSS OF USE, DATA, OR PROFITS; OR BUSINESS INTERRUPTION) HOWEVER CAUSED AND ON ANY THEORY OF LIABILITY, WHETHER IN CONTRACT, STRICT LIABILITY, OR TORT (INCLUDING NEGLIGENCE OR OTHERWISE) ARISING IN ANY WAY OUT OF THE USE OF THIS SOFTWARE, EVEN IF ADVISED OF THE POSSIBILITY OF SUCH DAMAGE.

Unicode: 5.1.0

COPYRIGHT AND PERMISSION NOTICE



Copyright c 1991-2013 Unicode, Inc. All rights reserved. Distributed under the Terms of Use in <http://www.unicode.org/copyright.html>.



Permission is hereby granted, free of charge, to any person obtaining a copy of the Unicode data files and any associated documentation (the "Data Files") or Unicode software and any associated documentation (the "Software") to deal in the Data Files or Software without restriction, including without limitation the rights to use, copy, modify, merge, publish, distribute, and/or sell copies of the Data Files or Software, and to permit persons to whom the Data Files or Software are furnished to do so, provided that (a) the above copyright notice(s) and this permission notice appear with all copies of the Data Files or Software, (b) both the above copyright notice(s) and this permission notice appear in associated documentation, and (c) there is clear notice in each modified Data File or in the Software as well as in the documentation associated with the Data File(s) or Software that the data or software has been modified.

THE DATA FILES AND SOFTWARE ARE PROVIDED "AS IS", WITHOUT WARRANTY OF ANY KIND, EXPRESS OR IMPLIED, INCLUDING BUT NOT LIMITED TO THE WARRANTIES OF MERCHANTABILITY, FITNESS FOR A PARTICULAR PURPOSE AND NONINFRINGEMENT OF THIRD PARTY RIGHTS. IN NO EVENT SHALL THE COPYRIGHT HOLDER OR HOLDERS INCLUDED IN THIS NOTICE BE LIABLE FOR ANY CLAIM, OR ANY SPECIAL INDIRECT OR CONSEQUENTIAL DAMAGES, OR ANY DAMAGES WHATSOEVER RESULTING FROM LOSS OF USE, DATA OR PROFITS, WHETHER IN AN ACTION OF CONTRACT, NEGLIGENCE OR OTHER TORTIOUS ACTION, ARISING OUT OF OR IN CONNECTION WITH THE USE OR PERFORMANCE OF THE DATA FILES OR SOFTWARE.

Except as contained in this notice, the name of a copyright holder shall not be used in advertising or otherwise to promote the sale, use or other dealings in these Data Files or Software without prior written authorization of the copyright holder.

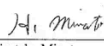
Declaration of Conformity

 MITSUBISHI ELECTRIC CORPORATION SANDA WORKS <small>2-3-33, Miwa, Sanda-City, Hyogo 669-1513, Japan Phone: +81-79-559-3652</small>	
DECLARATION of CONFORMITY For	
	Product: Audio Navigation Unit Model: NR-0V
Supplied by Mitsubishi Electric Corporation Sanda Works 2-3-33, Miwa, Sanda-city, Hyogo, 669-1513, Japan	Technical File held by Mitsubishi Electric Corporation Sanda Works 2-3-33, Miwa, Sanda-city, Hyogo, 669-1513, Japan
R&TTE Directive (Safety) RE Directive (EMC) RE Directive (Spectrum)	Standard used for comply EN 60950-1: 2006 + Amd.11: 2009 + Amd.1: 2010 + Amd.12: 2011 + Amd.2: 2013 EN 62479: 2011 EN 301 489-1 V2.1.1: 2017-02 EN 301 489-17 V3.3.1: 2017-02 EN 300 328 V2.2.1: 2016-11 EN 303 345 V1.1.7: 2017-03(Final Draft)
Means of Conformity We declare under our sole responsibility that the Product (s) is conformity with the essential requirements and other relevant requirements of the Radio Equipment (RE) Directive (2014/53/EU).	
Date of issue: May 30, 2017	
Signature of Responsible Person:	 Hirotaka Minato Senior Manager Design B Car Multimedia Manufacturing-A Dept. MITSUBISHI ELECTRIC CORPORATION SANDA WORKS Minato.Hirotaka@ap.MitsubishiElectric.co.jp

Country/Area	
Brazil:	 Este equipamento opera em caráter secundário isto e, não tem direito a proteção contra interferência prejudicial, mesmo tipo, e não pode causar interferência a sistemas operando em caráter primário. Para consultas, visite: www.anatel.gov.br
The United Arab Emirates:	 TRA REGISTERED No. ERO13275/14 DEALER No. DA008122/12
Kazakhstan:	 Model name: NR 0V Manufacturer: Mitsubishi Electric Corporation Exporting country: Japan

VC-1:

THIS PRODUCT IS LICENSED UNDER THE VC-1 PATENT PORTFOLIO LICENSE FOR THE PERSONAL AND NON-COMMERCIAL USE OF A CONSUMER TO (i) ENCODE VIDEO IN COMPLIANCE WITH THE VC-1 STANDARD (“VC-1 VIDEO”) AND/OR (ii) DECODE VC-1 VIDEO THAT WAS ENCODED BY A CONSUMER ENGAGED IN A PERSONAL AND NON-COMMERCIAL ACTIVITY AND/OR WAS OBTAINED FROM A VIDEO PROVIDER LICENSED TO PROVIDE VC-1 VIDEO. NO LICENSE IS GRANTED OR SHALL BE IMPLIED FOR ANY OTHER USE. ADDITIONAL INFORMATION MAY BE OBTAINED FROM MPEG LA, L.L.C. SEE [HTTP://WWW.MPEGLA.COM](http://www.mpegla.com)

MPEG-4 VISUAL:

USE OF THE PRODUCT IN ANY MANNER THAT COMPLIES WITH THE MPEG-4 VISUAL STANDARD IS PROHIBITED, EXCEPT FOR USE BY A CONSUMER ENGAGING IN PERSONAL AND NON-COMMERCIAL ACTIVITIES.

13.8. Storage space on hard disk

It is possible to view how much free space there is on the car's hard disk.

Storage information for the car's hard disk, including total capacity, available capacity and how much space is used for installed apps can be shown. The information is available under **Settings** → **System** → **System Information** → **Storage**.

13.9. Sound settings

The sound reproduction quality is preset, but it can be adjusted as well.

The volume is normally adjusted with the volume control below the centre display or with the right-hand steering wheel keypad. This applies, for example, during playback of music, radio, ongoing phone calls and active traffic messages.

Note

Some phones require that the phone's Bluetooth volume is manually set to 100% in order for the audio volume in the car to be sufficiently high. This setting needs to be made for each phone connected. The setting is made once for phone calls and once for streaming media. The system will then remember the setting and it does not need to be repeated next time the phone is connected.

Sound reproduction

The sound system is pre-calibrated by means of digital signal processing. This calibration takes into account loudspeakers, amplifiers, passenger compartment acoustics, listener position, etc., for each combination of car model and audio system. There is also a dynamic calibration that takes into account the setting of the volume control and vehicle speed.

Personal preferences

Various settings are available in the top view under **Settings** → **Sound** depending on the car's audio system.

Premium Sound* (Bowers & Wilkins)

- **Tone** – settings for bass, treble, equalizer, etc.
- **Balance** – balance between right/left loudspeakers and balance between front/rear loudspeakers.
- **System Volumes** – adjusts volume in the various systems of the car, e.g. **Voice Control**, **Park Assist** and **Phone Ringtone**.

High Performance Pro* (Harman Kardon)

- **Equaliser** – equalizer setting.
- **Balance** – balance between right/left loudspeakers and balance between front/rear loudspeakers.
- **System Volumes** – adjusts volume in the various systems of the car, e.g. **Voice Control**, **Park Assist** and **Phone Ringtone**.

High Performance

- **Tone** – settings for bass, treble, equalizer, etc.
- **Balance** – balance between right/left loudspeakers and balance between front/rear loudspeakers.
- **System Volumes** – adjusts volume in the various systems of the car, e.g. **Voice Control**, **Park Assist** and **Phone Ringtone**.

* Option/accessory.

13.10. Sound experience*

Sound experience is an app that provides access to further sound settings.

Sound Experience is opened from the app view in the centre display. The following settings can be defined, depending on the audio system fitted to the car:

Premium Sound* (Bowers & Wilkins)

- **Studio** – the sound can be adjusted so that it can primarily be adapted for **Driver**, **All** and **Rear**.
- **Individual stage** – surround sound mode with settings for intensity and enclosure.
- **Concert hall** – reproduces the acoustics from Gothenburg's Concert Hall.

- **Jazz club** – reproduces the acoustics from the Nefertiti Jazz Club.



Recreate the acoustics from Nefertiti Jazz Club.

High Performance Pro* (Harman Kardon)

- **Seat Optimisation** – the sound can be adjusted so that it can primarily be adapted for **Driver, All** and **Rear**.
- **Surround** – surround sound mode with level settings.
- **Tone** – settings for bass, treble, equalizer, etc.

* Option/accessory.

13.11. Customer Privacy Policy

Volvo respects and safeguards the personal integrity of everyone visiting our website.

This policy regards to the handling of customer data and personal information. The purpose is to give current, past and potential customers a general understanding of:

- The circumstances in which we gather and process your personal data.
- The types of personal data we gather.
- The reason we gather your personal data.
- How we handle your personal data.

For more information on the policy, search support information at [volvocars.com](https://www.volvocars.com/) [<https://www.volvocars.com/>].

13.12. Sensus - online connectivity and entertainment

Sensus makes it possible to use different types of apps and turn the car into a Wi-Fi hotspot.

This is Sensus

SENSUS

Sensus offers an intelligent interface and online connectivity with the digital world. An intuitive navigation structure makes it possible to receive relevant support, information and entertainment when it is necessary, without distracting the driver.

Sensus covers all solutions in the car that are connected with entertainment, online connectivity, navigation* and the user interface between driver and car. It is Sensus that makes communication possible between you, the car and the outside world.

Information when it is needed, where it is needed

The different displays in the car provide information at the right time. The information is shown in different locations based on how it should be prioritised by the driver.



Different types of information are shown in different displays depending on how the information should be prioritised.

Head-up display*

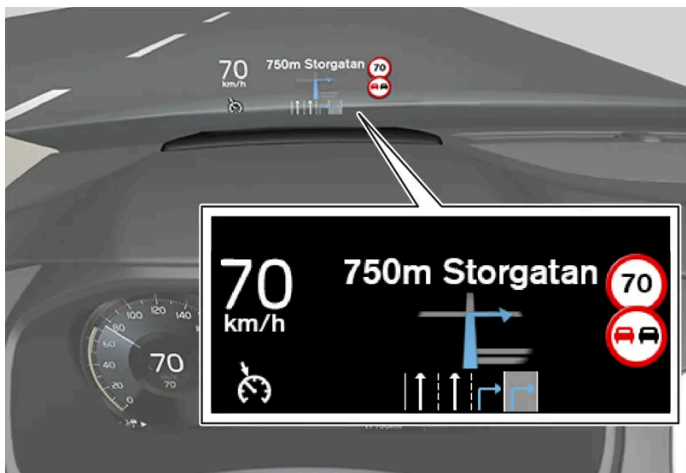

The head-up display shows selected information that the driver should deal with as soon as possible. Such information may, for example, include traffic warnings, speed information and navigation* information. Road Sign Information and incoming phone calls are also shown in the head-up display. The display is operated via the right-hand steering wheel keypad and via the centre display.

Driver display



The driver display shows information on speed and e.g. incoming calls or song tracks being played. The display is operated via the two steering wheel keypads.

Centre display



Many of the main functions of the car are controlled from the centre display, a touch screen which reacts to touch. The number of physical buttons and controls in the car is therefore minimal. The screen can even be operated while wearing gloves.

From here, for example, you can control the climate control system, the entertainment system and seat position*. The information that is shown in the centre display can be acted on by the driver or someone else in the car when the opportunity arises.

Voice recognition system



The voice recognition system can be used without the driver needing to take his/her hands off the steering wheel. The system can understand natural speech. Use voice recognition to, for example, play back a song, call someone, increase the temperature or read out a text message.

* Option/accessory.

13.13. Terms & Conditions for Services

Volvo offers services that help to enhance car safety and comfort.

These services include everything from assistance in emergencies to navigation and various maintenance services.

Before using the services, it is important for you to read the support information relating to the Terms & Conditions for Services at [volvocars.com](https://www.volvocars.com/) [<https://www.volvocars.com/>].

14. Volvo On Call

14.1. Volvo On Call services

14.1.1. Help with Volvo On Call*

Volvo On Call can provide extra security and assistance if you have a puncture, your engine breaks down or you have an accident.

Volvo On Call not only offers additional comfort and control via the Volvo Cars app, but also a range of auxiliary services via the SOS and ON CALL buttons on the roof, such as emergency assistance in the event of an accident, theft notification, roadside assistance and remote unlocking.

* Option/accessory.

14.1.2. Emergency assistance with Volvo On Call*

Press the SOS button to contact a Volvo On Call service centre, or an emergency call centre, in an emergency situation.

Volvo On Call Service Centre^[1]

To summon help in case of illness, external threats to the car or passengers, a Volvo On Call service centre can be alerted manually by depressing the SOS button for at least 2 seconds. The car calls the Volvo On Call service centre and a message is sent containing the car's position, among other things.

1. The Volvo On Call service centre tries to establish verbal contact with the car's driver and to find out the extent of the emergency situation and the need for help.
2. The Volvo On Call Service Centre then contacts the necessary assistance (police, ambulance, towing, etc.).

If verbal contact cannot be established, the Volvo On Call Service Centre contacts the relevant authorities that assist with appropriate action.

Prioritise public emergency number^[1]

It is possible to set up the system so that the car phones a public emergency call centre instead of a Volvo On Call service centre. See the separate instructions.

Emergency call centre ^[2]

To summon help in case of illness, external threats to the car or passengers, an emergency call centre can be alerted manually by depressing the SOS button for at least 2 seconds.

1. The emergency call centre tries to establish verbal contact with the car's driver and to find out the extent of the emergency situation and the need for help.
2. The emergency call centre sends the necessary assistance (police, ambulance, towing, etc.).

Note

The SOS button must only be used in the event of accident, illness or an external threat against the car and its passengers. The SOS function is only intended for emergency situations. Abuse may lead to supplementary charges.

The Volvo Cars app and ON CALL button can be used for all other services ^[3], including roadside assistance.

Emergency number

When the collision alarm is activated the system attempts to establish contact with the country's Volvo On Call service centre. If this is not possible, then the call is routed to the designated emergency number for the area where the car is located.

The ON CALL - and SOS buttons can be deactivated when the car's electrical system is in ignition position I, II or if the engine is running:

- 1 Press **Settings**.
- 2 Press **Communication** → **Volvo On Call**.
- 3 Select **SOS/On Call button lock** to deactivate.

* Option/accessory.

^[1] Available services vary depending on market.

^[2] Applies to markets where a Volvo On Call service centre is not offered.

^[3] Available services vary depending on the market.

14.1.3. Automatic collision alarm with Volvo On Call *

If a collision occurs, the car reports this automatically to a Volvo On Call service centre, or an emergency call centre, which can send out emergency assistance.

Volvo On Call Service Centre ^[1]

The content of this manual represents the status of the user manual at the time of printing and may not be completely valid in future instances. For more information, refer to the first page for the complete disclaimer note.

When the car's safety system is triggered, e.g. in an accident in which the activation level is reached for seatbelt tensioners or airbags, the car automatically calls a Volvo On Call service centre and a message is sent containing the position of the car, among other things.

1. The Volvo On Call service centre tries to establish verbal contact with the car's driver and to find out the extent of the collision and the need for help.
2. The Volvo On Call Service Centre then contacts the necessary assistance (police, ambulance, towing, etc.).

If verbal contact cannot be established, the Volvo On Call Service Centre contacts the relevant authorities that assist with appropriate action.

Prioritise public emergency number^[1]

It is possible to set up the system so that the car phones a public emergency call centre instead of a Volvo On Call service centre. See the separate instructions.

Emergency call centre^[2]

When the car's safety system is triggered, e.g. in an accident in which the activation level is reached for seatbelt tensioners or airbags, a signal will be automatically sent directly to an emergency call centre.

1. The emergency call centre tries to establish verbal contact with the car's driver and to find out the extent of the collision and the need for help.
2. The emergency call centre sends the necessary assistance (police, ambulance, towing, etc.).

Emergency number

When the collision alarm is activated the system attempts to establish contact with the country's Volvo On Call service centre. If this is not possible, then the call is routed to the designated emergency number for the area where the car is located.

* Option/accessory.

^[1] Available services vary depending on market.

^[2] Applies to markets where a Volvo On Call service centre is not offered.

14.1.4. Send destinations to the car's navigation system via a Volvo On Call* service centre

Contact a Volvo On Call service centre to have destinations sent directly to the car's navigation system.^[1]

Press the ON CALL button in the car's roof for help with finding e.g. a restaurant, a hotel, a workshop, a tourist attraction or another destination. An operator sends the destination to the car, and the destination can be added as an intermediate destination or destination in the centre display.

It is possible to ask the operator at the Volvo On Call service centre for several destinations during the same call. However, they will be sent to the car one at a time.

* Option/accessory.

^[1] Applies to certain markets and cars with Sensus Navigation*.

14.1.5. Remote Vehicle Immobiliser (RVI) with Volvo On Call*

If the car is stolen, an immobiliser can be activated remotely. ^[1], ^[2]

If the car has been stolen then the owner can contact a Volvo On Call service centre via the Volvo Cars app or the authorities.

 **Note**

This also applies if the car was opened and stolen with the associated key.

After having been in contact with the authorities, the Volvo On Call service centre deactivates the keys in order to prevent the car from being started. A deactivated car can only be restarted by contacting a Volvo On Call service centre and PIN code verification. Following which, the Volvo On Call Service Centre performs activation of the car.

* Option/accessory.

^[1] Only where legislation permits and in cooperation with the proper authorities.

^[2] Available services vary depending on market.

14.1.6. Remote Door Unlock (RDU) with Volvo On Call*

If the car key has been lost or locked in the car, it is possible to remotely unlock the car within the next 5 days assisted by the Volvo On Call service centre. ^[1]

- 1 Contact a Volvo On Call service centre via the Volvo Cars app.
 - 2 When the Volvo On Call Service Centre has verified the car's owner or other authorised individual using the PIN code, an unlocking signal is sent to the car according to agreement.
 - 3 Press gently once on the rubberised pressure plate underneath the tailgate handle to unlock the car.
- > Now all doors can be opened as normal.

 **Note**

If the rubberised pressure plate on the tailgate is not depressed within a certain time, predetermined by a Volvo On Call service centre, the car will be locked again.

 **Note**

If, for example, the car is parked in a parking garage, the remote unlocking function may possibly be limited due to poor reception.

* Option/accessory.

^[1] Available services vary depending on market.

14.1.7. Stolen Vehicle Tracking (SVT) with Volvo On Call*

If car theft is suspected, contact a Volvo On Call service centre via the Volvo Cars app to attempt to locate the car. ^[1]

If theft or other unauthorised use of the car has been discovered, then the car's owner along with the police and Volvo On Call service centre may agree that the car is traced.

 **Note**

This also applies if the car was opened and stolen with the associated key.

The following needs to be done:

- 1 Contact Volvo On Call service centre and tell them you want help tracking the car. The tracking starts.
- 2 Make a police report.
- 3 Contact Volvo On Call service centre again and notify them of the police case number.
- 4 Volvo On Call service centre informs the police of the car's position.

 **Note**

A condition for the car to be tracked is that the matter is reported to the police. Volvo On Call will only give information to the police.

* Option/accessory.

^[1] Available services vary depending on market.

14.1.8. Theft Notification (TN) with Volvo On Call*

When the car's alarm is activated, the car owner receives a message to the phone number registered with the dealer and then a push notification in the Volvo Cars app. ^[1]

If you have lost track of where your car is located, you can contact a Volvo On Call service centre via the Volvo Cars app. If it turns out that an unauthorised person is using the car, tracking can be started. The police are then linked in.

If the alarm is switched off using the key, the service is cancelled.

* Option/accessory.

^[1] Available services vary depending on market.

14.1.9. Help during a trip with Volvo On Call*

If you have a puncture, run out of fuel or your battery is discharged, for example, you can summon assistance with the ON CALL button or the Volvo Cars app.

If you hold down the ON CALL button in the roof for at least 2 seconds, verbal contact will be established between the Volvo On Call service centre and the driver. The aim of this is to agree on what assistance is required.

You can also phone the Volvo On Call service centre, but the car has to be online for the operator to be able to view the car's status and position.

 **Note**

The SOS button must only be used in the event of accident, illness or an external threat against the car and its passengers. The SOS function is only intended for emergency situations. Abuse may lead to supplementary charges.

The Volvo Cars app and ON CALL button can be used for all other services ^[1], including roadside assistance.

The ON CALL - and SOS buttons can be deactivated when the car's electrical system is in ignition position I, II or if the engine is running:

- 1 Press **Settings**.
- 2 Press **Communication** → **Volvo On Call**.
- 3 Select **SOS/On Call button lock** to deactivate.

A separate subscription may need to be taken out for the roadside assistance service.

* Option/accessory.

[1] Available services vary depending on the market.

14.1.10. Customer service via Volvo On Call*

For questions on using the car, the **ON CALL** button can be used to make contact with a Volvo On Call service centre. [1] An operator is available to answer 24 hours a day.

You can also reach a Volvo On Call service centre via the Volvo Cars app's  tab.

* Option/accessory.

[1] Available services vary depending on market.

14.2. Practical information on Volvo On Call

14.2.1. Getting started with Volvo On Call*

There are certain preparations you need to complete in order to get started with Volvo On Call.

Activation of Volvo On Call

When the car is collected, the retailer activates the Volvo On Call system and the owner receives an automatically generated PIN code for Volvo On Call. This PIN code is used for security reasons to identify the owner (or another approved person such as a family member) and works like a car key.

Volvo On Call subscription

For the functions to work, the car must have an active Volvo On Call subscription.

The content of this manual represents the status of the user manual at the time of printing and may not be completely valid in future instances. For more information, refer to the first page for the complete disclaimer note.

The subscription is initiated in connection with the purchase of the car when the system is activated. The subscription has a time limit but can be extended, and validity is market dependent. Among other things, the subscription can be extended in the Volvo Cars app. Make sure that everybody has access to the car's vehicle identification number (VIN).

Note

Automatic Crash Notification, the SOS button and roadside assistance via the ON CALL button also work without a subscription.

Volvo ID and linking the Volvo Cars app to the car

In order to use the Volvo Cars app, you need a Volvo ID. When a Volvo ID has been created, the app needs to be paired with the car. Read more about this at [volvocars.com/intl/support](https://www.volvocars.com/intl/support) [<https://www.volvocars.com/intl/support>].

Note

To be able to use the Volvo Cars app services, the car is required to have a valid Volvo On Call Subscription and the app needs to be paired with the car.

Buying a used car with Volvo On Call

When buying a used car with Volvo On Call, it is important to delete data from the previous owner and add your own details to make the service work. Visit a Volvo dealer for assistance.

* Option/accessory.

14.2.2. Prioritising between Volvo On Call* service centre and emergency call centre

Choose whether the car should phone Volvo On Call service centre or the emergency call centre in an emergency situation. ^[1], ^[2]

In cars with Volvo On Call, it is possible to set whether the car should contact a Volvo On Call service centre or the public emergency call centre when the automatic collision alarm is triggered or when the SOS button is pressed.

The car's factory setting is to primarily contact a Volvo On Call service centre.

To change this:

- 1 Press **Settings** in the top view in the centre display.
- 2 Press **Communication** → **Volvo On Call**.

3 Select **Prioritise public call center over Volvo call center** if you want to contact the public emergency call centre directly.

Note

When contact with a Volvo On Call service centre is given priority, more information is transmitted from the car and more extensive help can be given than if the public emergency call centre is the primary contact. If contact with the service centre cannot be established, the car contacts the public emergency call centre instead.

If, on the other hand, the public emergency call centre is given priority and it is not possible to establish contact, no attempt is made to reach the Volvo On Call service centre instead.

* Option/accessory.

^[1] Applies to the S60, S60 Recharge, V60, V60 Recharge and V60 Cross Country.

^[2] Available services vary depending on market.

14.2.3. PIN code for Volvo On Call*

For security reasons, a PIN code is used to verify that a person is authorised to perform Volvo On Call services in a certain car.

The four-digit PIN code is automatically generated by the Volvo On Call service centre or by an authorised Volvo dealer and is sent to the car owner. The PIN code proves that the user is authorised.

Using a PIN code

The Volvo On Call PIN code is required for the following services, for security reasons:

- Create a link between the Volvo Cars app and the car.
- Remote unlocking of the car via a Volvo On Call service centre.^[1]
- When you start stolen car tracking via a Volvo On Call service centre.^[1]
- When you create new app users for your car.
- When you cancel your Volvo On Call subscription via the app, e.g. when the car changes owners.

Forgotten or change of PIN code

If you forget or need to change PIN code (e.g. when buying a used car with Volvo On Call), contact

- a dealer or
- Volvo On Call service centre^[1] via the ON CALL button or the Volvo Cars app.

The new code is sent to the car owner.

Incorrect PIN code has been entered for the Volvo Cars app repeatedly

If an incorrect PIN code has been entered ten times in a row, the account will be locked. A new PIN code must be selected in order to be able to use the app again and a new app account created by following the same process as when the previous app account was created.

* Option/accessory.

[1] Available services vary depending on market.

14.2.4. Standby battery for Volvo On Call*

If the main battery is de-energised then the standby battery for Volvo On Call is used so that the system can still be used.

The standby battery has a limited service life. When the battery needs service or replacement, a message, **Volvo On Call Service required**, is shown in the driver display.

If the message remains, contact an authorised Volvo workshop.

* Option/accessory.

14.2.5. Volvo On Call* abroad

Volvo On Call services may vary when driving between countries.

When you press the SOS button you are always connected to a Volvo On Call service centre in the market where the car is located. If there is no Volvo On Call service centre, an emergency call centre is contacted.

When you press the ON CALL button you are always connected to your home country's Volvo On Call service centre.

For more information, contact a Volvo dealer.

* Option/accessory.

14.2.6. Volvo On Call* availability

To save the battery, the Volvo On Call system is programmed to shut down when the car is not used for long periods.

Volvo On Call is fully available for 5 full days. For days 6-21, services such as, for example, remote control immobiliser and stolen vehicle tracking are initiated via Volvo On Call service centre.^[1] After 22 full days, the system is disconnected to save the battery and is fully available again as soon as the car is started.

 **Warning**

The system's services only work in areas where Volvo On Call partners have mobile coverage and on markets where Volvo On Call is available.

Just as with mobile phones, atmospheric disturbances or sparse transmitter coverage may lead to connection being impossible, e.g. in sparsely populated areas.

* Option/accessory.

^[1] Availability of the functions may vary.

14.2.7. Change of ownership with Volvo On Call*

In the event of a change of ownership, there are some steps that need to be taken to unlink the previous owner and give the new owner access to Volvo On Call.

Selling a car equipped with Volvo On Call

The previous owner should take the following steps:

- 1 Deactivate the connection between the car and the Volvo Cars app.
- 2 Reset the settings in the centre display – select factory reset.

Buying a car equipped with Volvo On Call

The new owner needs to take the following steps:

- 1 Contact a Volvo dealer for assistance to transfer remaining time from the previous owner's Volvo On Call subscription. An extension will need to be purchased if the subscription has expired. The Volvo dealer automatically generates a PIN code via email or SMS. Keep the PIN code in a safe place.
- 2 Pair the Volvo Cars app with the car.

Change of owner when changing country

The content of this manual represents the status of the user manual at the time of printing and may not be completely valid in future instances. For more information, refer to the first page for the complete disclaimer note.

When a car is purchased and imported to a different country, the owner should take care to visit a dealer in the country in which the car is purchased. The dealer should then delete all customer data in their systems. In the country to which the car is imported, the owner should contact a dealer for help with starting the Volvo On Call service.

* Option/accessory.

14.3. Volvo On Call app

14.3.1. The Volvo Cars-app*

The Volvo Cars app^[1] allows you to control certain functions and interact with the car via your phone.^[2]

The Volvo Cars app is available for iPhone and Android phones. You can download it for free from your phone's app store. The app is updated regularly, so ensure that the latest version is installed on your phone.

Here are some of the things you can do in the app:^[3]

- Checking fuel and battery level^[4], lock status and other car statuses
- Locking and unlocking doors
- Starting and stopping parking climate control
- Contact Volvo for more information
- Displaying your account information

Up-to-date information on the Volvo Cars app can be found at [volvocars.com/intl/support](https://www.volvocars.com/intl/support) [<https://www.volvocars.com/intl/support>].

Internet connection required

When you use the Volvo Cars app, your mobile device will send and receive data via the Internet. If you do not have a data plan, then your mobile network operator may charge you for that data. If you use the app abroad, you may be charged for data roaming. For more information, contact your mobile service provider.

* Option/accessory.

^[1] Availability depends on market.

^[2] Certain functions require that both car and mobile device have mobile coverage or other Internet connection.

^[3] The functions available vary depending on the market and can vary over time.

^[4] Applies to Twin Engine and Recharge models.

14.4. Data sharing for Volvo On Call

Data sharing for the Volvo On Call service is activated as standard. This means that you do not need to activate data sharing for this service yourself when you buy a new car or after e.g. a factory reset.

You can choose yourself to deactivate data sharing for Volvo On Call. Note that most of the Volvo On Call functions need to be able to share data for you to be able to use them. If you have paired the Volvo Cars app with your car, a notification is shown in the app if the data sharing function is deactivated for Volvo On Call.

The data sharing settings are only activated as standard for your Volvo On Call services. Sharing of data for your other online services and downloaded apps will continue to be deactivated and will need to be selected for activation in order to enable their use.

14.5. Volvo On Call*

Volvo On Call^[1] provides direct contact to the car as well as extra comfort and assistance 24 hours a day.

The functions are available via the Volvo Cars app^[2] as well as the ON CALL button and the SOS button in the roof of the car:



For example, you can lock and unlock the car directly from a phone via the Volvo Cars app. If an accident occurs, emergency assistance can be sent to the car, e.g. ambulance or police. Roadside assistance can be called for less urgent problems, such as a puncture.

i Note

The SOS button must only be used in the event of accident, illness or an external threat against the car and its passengers. The SOS function is only intended for emergency situations. Abuse may lead to supplementary charges.

The Volvo Cars app and ON CALL button can be used for all other services^[3], including roadside assistance.

Volvo On Call system

Volvo On Call is linked to the car's safety and alarm systems as well as other systems in the car, such as locking and climate control. The car has a built-in modem for communication with a Volvo On Call service centre and the Volvo Cars app. GNSS (Global Navigation Satellite System) is used to locate the car.

Processing of personal data

Certain information, including personal data, will need to be processed in order to be able to make use of all the functions in connection with the Volvo On Call service. Read more about terms and conditions and privacy at [volvocars.com/intl/legal](https://www.volvocars.com/intl/legal) [<https://www.volvocars.com/intl/legal>].

Contact service centre

Use the car's ON CALL button or the Volvo Cars app to contact the Volvo On Call service centre.

i Note

All calls with the Volvo On Call service centre may be recorded.

* Option/accessory.

^[1] Availability depends on market.

^[2] Available functions vary depending on the market.

^[3] Available services vary depending on the market.

14.6. Volvo On Call* subscription

Volvo On Call is a subscription service. Your subscription includes emergency assistance and security services as well as app services.

Status of Volvo On Call subscription

The status of your Volvo On Call subscription is shown in the Volvo Cars app under **Vehicle information** in the  tab. The subscription can also be extended from here.

If you do not have access to the Volvo Cars app, contact your dealer who will help you to find information on the expiry date of the subscription. You then need to state the car's vehicle identification number^[1].

Message to indicate that your Volvo On Call subscription will soon be expiring

45 days before your Volvo On Call subscription is set to expire, the message **Volvo On Call subscription expires soon** will be shown in the car's display. If you are using the Android or iOS version of the Volvo Cars app, you will also receive reminders in the app.

Disabled Volvo On Call subscription

When the subscription period has expired you will be alerted via a message in the car's display showing the text **On Call deactivated**. This message disappears when the subscription is reactivated.

You will not be able to use the Volvo On Call services when your subscription has expired. That said, the emergency services via the SOS button and automatic collision alert will continue to function. You have to renew your subscription if you want to use Volvo On Call again.

Roadside assistance costs

Roadside assistance costs are included for the first X^[2] years when you buy a new Volvo. After this time has passed, in most of the markets, Roadside Assistance is offered free of charge providing the car has been serviced regularly at an authorised Volvo workshop. An authorised Volvo dealer can inform you about the status of your roadside assistance agreement.

Volvo On Call can help you get back on the road even if your Roadside Assistance agreement has expired. In this case, you will be asked to pay the cost for the service that is sent out to you.

 **Note**

If you do not have a valid road assistance agreement, additional recovery costs may apply.

* Option/accessory.

^[1] Vehicle Identification Number(VIN)

^[2] Varies depending on market.

14.7. Extend your Volvo On Call* subscription

You can choose between different time periods^[1] when you extend or reactivate your Volvo On Call subscription.

The extension can be purchased^[1]

- in the Volvo Cars app
- via an authorised Volvo dealer
- online via the link store.volvocars.com. Make sure you have access to the vehicle identification number^[2].

Extend your subscription using the Volvo Cars app

- 1 Go to the  tab.
- 2 Select **Vehicle information**.
- 3 Press **Renew** under **Volvo On Call subscription**.
- 4 You will be forwarded to a page where you can renew the subscription.

 **Note**

If you would like to purchase an extension **after** your subscription has expired, you must do this through your dealer since Volvo On Call must be reactivated by the dealer before you can continue using the services. This may cost extra. Therefore, it is a good idea to extend your subscription before it expires so that you can use the services without interruption. The subscription is extended from the date on which it should have expired.

* Option/accessory.

^[1] Available options may vary depending on market.

^[2] Vehicle Identification Number (VIN)

14.8. Right to cancel purchase of Volvo On Call* subscription extension

As a consumer, you have the right to cancel the contract within 14 days without having to provide a reason. The cancellation period expires 14 days from the day when the order was placed.

Cancellation

To utilise the right to cancel the contract, Volvo must be informed with a clear statement. This can be done in the following way:

- The easiest way is to contact customer support by phone or e-mail. If you choose to send e-mail, enter the order (including order number). Cancellation applies from the date the e-mail message was sent or the date that the phone call was received and is confirmed with an e-mail message from Volvo.
- It is also possible to send the notice of cancellation by post to Volvo's registered address. In this case, it applies from the date the cancellation form or letter was sent and is confirmed with an e-mail message from Volvo. If you choose to send the notice of cancellation by post, we recommend that you keep the receipt or other proof that you sent the letter.

Reimbursement

In the event of cancellation you are reimbursed without delay for all payments made in relation to the contract. However, Volvo may make a reasonable deduction for the time period the extended Volvo On Call subscription was active. In the event of reimbursement, the same payment method is used as for the original transaction. Any fees related to the repayment are not compensated.

Note

For help or more information, go to [volvocars.com/support \[https://www.volvocars.com/intl/support/\]](https://www.volvocars.com/support/), select the market in question and click on **Contact us**.

* Option/accessory.

14.9. Messages for Volvo On Call*

Examples of information messages that may appear when Volvo On Call is inoperative are provided here.

Discharged battery

If you receive a message indicating that the car has a discharged battery and is waiting for the Volvo On Call system to wake up, this may be because the car has not been used for a while.

To save the battery when the car is not used for any length of time, set the Volvo On Call system to standby.

Your Volvo On Call subscription is set to expire soon

45 days before your Volvo On Call subscription is set to expire, the message **Volvo On Call subscription expires soon** will be shown in the car's display. If you are using the Android or iOS version of the Volvo Cars app, you will also receive reminders in the app.

Volvo On Call has been disabled

If the Volvo On Call subscription has expired and the Volvo On Call system has been disabled, a message will be shown in the car's display which states **Volvo On Call subscription has expired**.

* Option/accessory.

15. Navigation

15.1. Enter destination

15.1.1. Enter destination directly on map

A destination can be specified in different ways in the navigation system* – marking a point on the map with your finger is one of them.

In many cases it is simplest to scroll to the desired position on the map and tap it with your finger.

1. Check that the map view is in max mode.
2. Scroll the map until the desired position is in view.
3. Press and hold the position - an icon is created and a menu opens.
4. Select **Go here** - guidance starts.

Delete the icon.

To erase the icon from the position:

- Select **Delete**

Adjust the position of the icon

To adjust the position of the icon:

- Tap and hold the icon, drag it to the desired position, and release.

* Option/accessory.

15.1.2. Specifying a destination with an address

A destination can be specified in different ways in the navigation system* - selecting an address is one of them.

- 1 When the map is shown, expand the tools field using the down arrow on the left-hand side and press **Set dest.**



- The map image changes to free text searching.
- 2 Press **Address**.
 - 3 All fields do not need to be filled in. For a journey to a city, for example, it is sufficient to enter just the country and city. Guidance is then given to the city's centre.
 - 4 Select one of the available text field options and type using the centre display keyboard:
 - **Country/State/Province**
 - **City/Territory/Postcode**
 - **Address**
 - **Number**
 - **Junction**

For cars with Volvo On Call* it is also possible to send addresses and destinations to the car's navigation system via the Volvo Cars app and a Volvo On Call service centre^[1].

* Option/accessory.

^[1] Only applies to certain markets.

15.1.3. Specify destination with free text searching

A destination can be set in different ways in the navigation system* - with free text searching, for example, a search can be made using phone numbers, postcodes, streets, cities, coordinates and points of interest (POI^[1]).

The keyboard in the centre display can be used to type most characters and to search for destinations.

- 1 When the map is shown, expand the tools field using the down arrow on the left-hand side and press **Set dest.**



- The map image changes to free text searching.
- 2 Enter a search term in the search box or first limit the hits by selecting a filter.
- Search hits are shown while characters are being entered.

3 If the search gives the desired result – tap on a search hit to show its information card and select to continue to use the search hit.

If the search gives too many results – tap on **Advanced filter** and select position to search around, and then select to continue to use the search hit:

- **Around car**
- **Around destination** - only shown if a destination is entered.
- **Along route** - only shown if a destination is entered.
- **Around point on map**

Coordinates

A destination can also be specified with map coordinates.

- Type, for example, “N 58.1234 E 12.5678” and tap **Search**.

The points of the compass N , E , S and W can be entered in different ways, e.g. in accordance with the following:
N 58,1234 E 12,5678 (with spaces)
N 58,1234 E 12,5678 (without spaces)
58,1234 N 12,5678 E (with the point of the compass after the coordinate)
58,1234-12,5678 (with hyphen without point of the compass)

You can use a comma **,** instead of a full stop **.** if you prefer.

* Option/accessory.

^[1] Point of Interest

15.1.4. Specify destination with point of interest

A destination can be specified in different ways in the navigation system* - selecting a point of interest (POI^[1]) is one of them.

1 When the map is shown, expand the tools field using the down arrow on the left-hand side and press **Set dest.**



➤ The map image changes to free text searching.

2 Press **POI**.

3 Tap on the desired filter (some options only show a set destination or intermediate destination):

The content of this manual represents the status of the user manual at the time of printing and may not be completely valid in future instances. For more information, refer to the first page for the complete disclaimer note.

- Near the car
- Near the destination
- Close intermediate destinations
- Along route
- Around point on map

4 Search for and select desired point of interest.

➤ The information card is displayed.

5 Select **Start navigation** or **Add as waypoint**.

Many POIs (e.g. restaurants) have subcategories (e.g. fast food).

In the settings for the map you can change which POIs should be shown on the map. That setting does not affect searching for POI as destination - even excluded POIs are shown as alternative destinations.

Certain POIs are first shown on the map when the scale is 1 km (1 mile).

i Note

- The symbol for a POI and the number of POIs varies between different markets.
- New symbols may appear and others disappear after a map data update. You can browse the menu system to find all the symbols used in the current map system.

* Option/accessory.

^[1] Point of Interest

15.1.5. Specifying a destination with latest/favourites/library

A destination can be specified in different ways in the navigation system* - selecting from a list is one of them.

1 When the map is shown, expand the tools field using the down arrow on the left-hand side and press **Set dest.**



➤ The map image changes to free text searching.

2 Then select one of the following lists, at the top of the screen:

- **Recent**

- **Favourites**
- **Library**

After one alternative in a list has been marked, it is added as a destination by using either the **Start navigation** button or the **Add as waypoint** button.

Last

Previous searches are listed here. Scroll and select.

Also available as a menu option in the driver display and can be viewed using the right-hand keypad on the steering wheel.

Using **Edit**, one or more items in the list can be deleted.

Favourites

The positions from **Library** that are flagged as favourites are collected in this list. Scroll and select.

A position erased from **Favourites** remains in the **Library**, but then with an "extinguished" star. To add a position in **Favourites**, go to **Library** and select the relevant position's asterisk again.

A frequently used destination can be programmed and used with **Set Home address**. An entered **Home** destination is also available as a menu option in the driver display and can be viewed using the right-hand keypad on the steering wheel.

Using **Edit**, one or more items in the list can be deleted.

Library

Saved positions and itineraries are collected here. The most recently saved appear uppermost on the list.

Tap on a position's star to select/deselect it as a favourite. A position with a highlighted/filled star is also listed under the **Favourites** heading.

Deleting a position in **Library** will also remove it from **Favourites**.

The library can be sorted in various ways:

- **Added** - sorts in chronological order.
- **Name** - sorts in alphabetical order.
- **Distance** - sorts in distance from current position.
- **Received** - positions sent to the car using Send to Car are filtered out. New positions that have not been read have a BLUE cursor which is extinguished when the positions have been read.

Using **Edit**, one or more items in the list can be deleted.

To edit a saved position in **Library**, highlight the position in the list and select **Edit position**. For example, it is possible to change the name of the position, move it on the map by dragging and dropping, and add phone number or email address.

* Option/accessory.

15.1.6. Specify destination with Send to Car

A destination can be specified in different ways in the navigation system* – using the Send to Car function is one of them.

Send destination to car

Send to Car is a function that makes it possible to send a destination/position to the car's navigation system via the Volvo Cars app*.

To use Send to Car requires a Volvo ID to be registered to the car.

Receiving and using a destination in the car

For the car to be able to receive data it must be connected to the Internet.

- 1 When a destination has been received by the car a notification is shown in the centre display. Tap on the notification/symbol.
 - > An information card is opened.
- 2 Select the desired use of the destination.

Using saved destination

Destinations received are saved to the navigation system's library and can be used later.

* Option/accessory.

15.1.7. Select a detour in the navigation system*

If the driver wants to avoid the nearest segment of a route, e.g. because the road is closed, a detour can be selected.

- 1 Expand the tools field on the left-hand side with the down arrow and then with the three points.



Press the symbol for **Detour** to show an alternative route with information about its longest/shortest route as well as calculated journey time. Normally only a short detour is proposed which quickly rejoins the original itinerary.

- 3 If the suggestion is **accepted**: Tap on the sign with detour information. The route is accepted even if you are driving on the road suggested. After the proposal is accepted, guidance is resumed - now with the detour selected as the route. If the suggestion is **not accepted** continue to drive on the original route.

An alternative to the **Detour** function is to diverge from the itinerary's route - the system then updates the route automatically and continues guidance to the destination along the most suitable route.

It is also possible to show an alternative route while driving continues.

* Option/accessory.

15.1.8. Energy distribution using map data *

In the driving position **Hybrid** the car is powered by both the electric motor and the internal combustion engine. If a destination has been selected in the navigation system*, the Predictive Efficiency^[1] function distributes the electric energy consumption along the whole driving distance using the map data.

In addition to the map data, the function also takes into account speed limits, traffic and elevation differences.

The electric motor is used primarily when driving at low speeds e.g. during city driving with more stops and starts. The combustion engine is used primarily when driving at high speeds and can, in good conditions, generate power for the electric motor.

Conditions for the function

For the function to work requires that a number of conditions are met:

- A destination is set in the navigation system and the driving distance to the destination is longer than the range possible only on electric drive.
- **Hybrid** drive mode is selected.
- The **Hold** and **Charge** functions are deactivated.

Tips for use

If the car is used for commuting to work and it is not possible to charge the car at the place of work, specify the place of work as an intermediate destination and your home as the final destination. The discharging of the hybrid battery will then take place over your runs both to and from work.

Add similar commuting routes, i.e. the route between two charging points, as **Favourites** in the navigation system to facilitate arrival.

* Option/accessory.

^[1] Certain markets only.

15.1.9. Send destinations to the car's navigation system via a Volvo On Call* service centre

Contact a Volvo On Call service centre to have destinations sent directly to the car's navigation system.^[1]

Press the ON CALL button in the car's roof for help with finding e.g. a restaurant, a hotel, a workshop, a tourist attraction or another destination. An operator sends the destination to the car, and the destination can be added as an intermediate destination or destination in the centre display.

It is possible to ask the operator at the Volvo On Call service centre for several destinations during the same call. However, they will be sent to the car one at a time.

* Option/accessory.

^[1] Applies to certain markets and cars with Sensus Navigation*.

15.2. Itinerary and route

15.2.1. Information card in navigation system *

All map icons, such as destination, interim destination and saved favourites, have an information card that opens after tapping the icon.

Pressing on the information card shows a small card, two presses show a larger card with more information. The information card's content and options vary depending on the type of icon.

With, for example a marked point of interest (POI^[1]), the driver can select:

- **Start navigation** - the position is saved as a destination
- **Add as waypoint** - the position is saved as an intermediate destination (only displayed at the specified destination)
- **Save** - the position is saved in the library
- **Remove from itinerary** - the position is removed if it is included in the itinerary
- **Nearby POI** - points of interest when the car's position appears

* Option/accessory.

^[1] Point of Interest

15.2.2. Showing POIs along a route

A list of points of interest (POI^[1]) along the route can be presented in the navigation system*.



Press Ahead.

2 Press POI.

> POIs along the route are shown based on distance.

3 When several POIs are in the same location they are shown as a group. Tap on the group to list POIs.

4 Select a POI.

5 Select one of the information cards alternatives and follow the instructions.

^[1] Point of Interest

* Option/accessory.

15.2.3. Itinerary

The itinerary is the route suggested in the navigation system* when the user has entered a destination.

The first defined position will be the itinerary's **destination**.

The subsequent positions will be the itinerary's **intermediate destinations**.

An itinerary, its destination and intermediate destinations can easily be edited afterwards.

* Option/accessory.

15.2.4. Show an alternative route

It is possible to search for alternative routes in the navigation system* while guidance is in progress.

1 Expand the tools field with the down arrow first and then with the three points.



Tap on the symbol for **Itinerary** to open the itinerary.

3 Press **Alternative routes**.

4 Select an alternative route:

- Eco
- Fast
- Scenic

5 Tap on the map.

➤ The updated route is then shown on the map and guidance resumes.

* Option/accessory.

15.2.5. Edit or delete the itinerary

It is possible to remove intermediate destinations or the entire itinerary in the navigation system* while guidance is in progress.

1 Expand the tools field with the down arrow first and then with the three points.



Tap on the symbol for **Itinerary** to open the itinerary.

3 Tap on the recycle bin to delete an intermediate destination in the itinerary, or tap on **Clear itinerary** to delete the whole itinerary.

* Option/accessory.

15.2.6. Show itinerary

The content of this manual represents the status of the user manual at the time of printing and may not be completely valid in future instances. For more information, refer to the first page for the complete disclaimer note.

It is possible to show the itinerary in the navigation system* during road navigation.

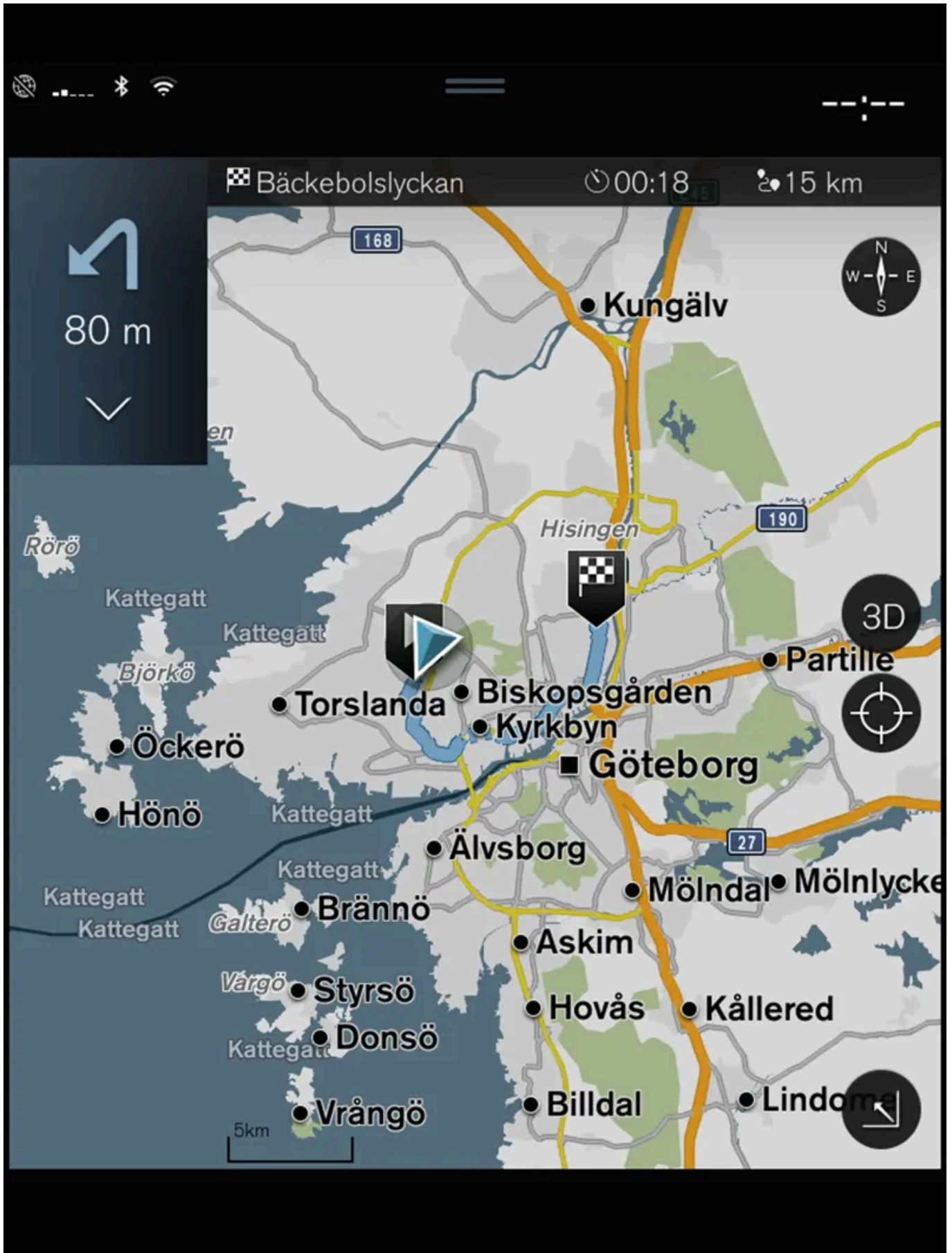

1 During guidance, expand the tools field with the down arrow and then the three points.



Tap on the symbol for **Itinerary** to open the itinerary.

* Option/accessory.

15.2.7. Showing guidance points in the itinerary

A list of the itinerary's future guidance points helps the driver to plan upcoming manoeuvres in good time.

Show a list of turns ahead in the itinerary in the navigation system * by:

- 1 Expanding the tools field using the down arrow on the left-hand side.
- 2 Expanding the tools field further with the three points.
- 3 Tap on the symbol for **Turn-by-Turn** (see illustration).



A list of the itinerary's guidance points is shown instead of the tools field (the list can be scrolled through). Pressing the arrow pointing left minimises the list.

The next guidance point is always placed at the top of the list.



The position is shown on the map by pressing one of the list's guidance points. A subsequent tap on the crosshairs symbol (see illustration) resets the map to the guidance view, where the map follows the car.

* Option/accessory.

15.2.8. Select a detour in the navigation system *

If the driver wants to avoid the nearest segment of a route, e.g. because the road is closed, a detour can be selected.

1 Expand the tools field on the left-hand side with the down arrow and then with the three points.



Press the symbol for **Detour** to show an alternative route with information about its longest/shortest route as well as calculated journey time. Normally only a short detour is proposed which quickly rejoins the original itinerary.

3 If the suggestion is **accepted**: Tap on the sign with detour information. The route is accepted even if you are driving on the road suggested. After the proposal is accepted, guidance is resumed - now with the detour selected as the route. If the suggestion is **not accepted** continue to drive on the original route.

An alternative to the **Detour** function is to diverge from the itinerary's route - the system then updates the route automatically and continues guidance to the destination along the most suitable route.

It is also possible to show an alternative route while driving continues.

* Option/accessory.

15.3. Traffic information

15.3.1. Information card in navigation system *

All map icons, such as destination, interim destination and saved favourites, have an information card that opens after tapping the icon.

Pressing on the information card shows a small card, two presses show a larger card with more information. The information card's content and options vary depending on the type of icon.

With, for example a marked point of interest (POI^[1]), the driver can select:

- **Start navigation** - the position is saved as a destination
- **Add as waypoint** - the position is saved as an intermediate destination (only displayed at the specified destination)
- **Save** - the position is saved in the library
- **Remove from itinerary** - the position is removed if it is included in the itinerary
- **Nearby POI** - points of interest when the car's position appears

* Option/accessory.

[1] Point of Interest

15.3.2. Select a detour in the navigation system*

If the driver wants to avoid the nearest segment of a route, e.g. because the road is closed, a detour can be selected.

1 Expand the tools field on the left-hand side with the down arrow and then with the three points.



Press the symbol for **Detour** to show an alternative route with information about its longest/shortest route as well as calculated journey time. Normally only a short detour is proposed which quickly rejoins the original itinerary.

3 If the suggestion is **accepted**: Tap on the sign with detour information. The route is accepted even if you are driving on the road suggested. After the proposal is accepted, guidance is resumed - now with the detour selected as the route. If the suggestion is **not accepted** continue to drive on the original route.

An alternative to the **Detour** function is to diverge from the itinerary's route - the system then updates the route automatically and continues guidance to the destination along the most suitable route.

It is also possible to show an alternative route while driving continues.

* Option/accessory.

15.3.3. Traffic disruptions on the map

The navigation system* receives information about traffic events and traffic congestion and shows them on the map.

 **Note**

Traffic information is not available in all areas/countries.

Coverage areas for traffic information are being increased continuously.

You can set which traffic-related information should be shown on the map.

Traffic disruptions, such as heavy and slow-moving traffic, roadworks and accidents, are indicated by different symbols if the map has been zoomed in enough.



Roadworks appear as follows. When disturbances are more severe, their extent is also shown with a red line along the side of the road. The line indicates at the same time in which travel direction the disturbance applies - if the disturbance is in both directions the road section is marked with a line on both sides.

Information on traffic disruptions

- 1 Tap on the symbol for traffic disruptions.
 - > An information card is shown. The information can describe for example the position of the disturbance with the street name or road number, and the disturbance's nature, extent or duration.

Avoid traffic disruptions

If there is traffic congestion along the route, the alternative **Avoid** can be selected. The system then calculates an alternative route.

Real Time Traffic Information^[1]

If the car is connected to the Internet, Real Time Traffic Information can also be received with RTTI^[2].

* Option/accessory.

^[1] Only applies to certain markets.

^[2] Real Time Traffic Information

15.3.4. Showing traffic congestion along route

A list of traffic disruptions along the route can be produced when a destination is set in the navigation system*.

- 1 When the map is shown, expand the tools field on the left-hand side with the down arrow and then with the three points.



Press **Ahead**.

- 3 Press **Traffic**. The Traffic button is grey if there is no traffic event on the route.

- > Any traffic events along the route are shown based on distance.

- 4 If more information about the traffic disruption is required, tap on the row and an information card is opened. Select one of the information cards alternatives and follow the instructions.
- 5 Tap on **Avoid** to avoid the traffic disruption.
 - > The route is recalculated and guidance is given via the alternative route.

* Option/accessory.

15.3.5. Real Time Traffic Information

When the car is connected to the Internet, the driver can access extended traffic information^[1] (RTTI^[2]) concerning congestion, closed roads and anything else that may affect the travelling time.

If the RTTI service has been activated, information on traffic incidents and traffic flow will be retrieved constantly from an Internet service. When a car requests traffic flow information, anonymous data about the traffic flow at the car's position is provided at the same time, which contributes to the function of the service. The anonymous data is only sent when RTTI is activated. No data is provided if this service is not activated.

The service may need to be activated again, e.g. after certain software updates, after workshop visits or when creating a new driver profile.

Current traffic conditions are shown in the navigation system * for motorways, major roads and extra-urban roads, as well as certain intercity routes.

The amount of traffic information shown on the map depends on the distance to the car and is only shown within approximately 120 km (75 miles) from the car's position.

Text and symbols on the map are shown as usual and the traffic flow shows how quickly the traffic is moving on a road compared with the road's speed limit. The traffic flow is shown on the map on each side of the road with one coloured line per travel direction:

- Green - no disruptions.
- Orange - slow traffic.
- Red - congestion/traffic jam/accident.
- Black - road closed.

Note

Traffic information is not available in all areas/countries.

Coverage areas for traffic information are being increased continuously.

^[1] Applies to certain markets.

^[2] Real Time Traffic Information

* Option/accessory.

15.3.6. Activating and deactivating Real Time Traffic Information

With the car connected to the Internet, the driver can access real time traffic information^[1] (RTTI^[2]) in the navigation system*.

RTTI is activated and deactivated as follows:

- 1 Tap on **Settings** in the centre display's top view.
- 2 Press **Navigation** → **Traffic**.
- 3 Select **Real Time Traffic Information** to activate (replaces normal traffic information with RTTI) or deactivate RTTI.
- 4 One pop-up window with the heading **Terms and conditions** and one with the heading **Data sharing** are shown if it is the first time RTTI is used.

If the car's Internet connection is disconnected when RTTI is activated then the normal traffic information will be activated automatically. RTTI is reactivated when the Internet connection is reconnected.

Deactivate the green line

To stop displaying the green lines that show that traffic is flowing with no problems:

- 1 Press **Settings** in the top view.
- 2 Press **Navigation** → **Traffic** and uncheck **Show Free Flowing Traffic**.

^[1] Applies to certain markets.

^[2] Real Time Traffic Information

* Option/accessory.

15.4. Settings for navigation

15.4.1. Map settings

Settings are selected here to define how the map is to be displayed in the navigation system*.

Settings → Navigation → Map

Settings can be made within the following areas:

- Position Format
- Map Display Format
- Show Speed Cameras
- Show Favourites
- Point of Interest (POI)

Position format

Position Format is used to choose whether the current position should be named/shown with its address or its coordinates:

- Address
- Coordinates and altitude

Map design

Map Display Format is used to choose how the map's colours should be shown:

- Day - bright colours.
- Night - dark colours so as not to interfere with night vision.
- Auto - the system switches between Day and Night depending on the light in the passenger compartment.

Speed cameras^[1]

Show Speed Cameras - indicate whether speed cameras should be shown on the map.

Favourites

Choose whether or not Favourites shall be shown on the map.

Point of interest (POI)^[2]

The POIs to be shown on the map are indicated under Point of Interest (POI). Tap the desired category, e.g. "Transportation", and then select to show all or specific sub categories. Exit the menu by pressing Back or Close.

* Option/accessory.

^[1] The function is not available in all markets.

^[2] Point of Interest

15.4.2. Navigation system settings*

Settings are selected here to define how the route and other information should be presented in the navigation system.

Settings → Navigation

Settings can be made within the following areas:

- **Map** - manage map content and appearance.
- **Route and Guidance** - manage guidance and route display and calculation.
- **Traffic** - manage information about traffic disruptions.

* Option/accessory.

15.4.3. Settings for route and road navigation

Settings are selected here to define how the route is to be calculated and the road navigation presented in the navigation system*.

Adjust the volume by turning the volume knob while the voice is talking.

Settings → Navigation → Route and Guidance

Settings can be made within the following areas:

- **Arrival Time Format**
- **Voice Guidance Level**
- **Choose Default Route Type**
- **Route Learning**
- **Avoidance Settings**
- **Suggest Petrol Station**

Time format

Select how arrival time should be specified:

- **ETA**^[1] (estimated time of arrival at destination)
- **RTA**^[2] (remaining time to arrival)

The times shown apply to the time zone of the destination.

Level for voice guidance

1 Press **Voice Guidance Level**.

2 Tap on the voice guidance required:

- **None** (no automatic voice guidance but the possibility of manually requesting current voice guidance once)
- **Low** (only one message per guidance point)
- **Medium** (up to 3 messages per guidance point, with limited information)
- **Full** (up to 4 messages per guidance point and all available information)

Standard route types

Select the standard type of route preferred:

- **Fast**
- **Eco**
- **Scenic** (motorways are avoided as far as possible, so the journey time may be long)

It is also possible to show an alternative route while driving continues.

Route learning

Select **Route Learning** if data collection to optimise route calculation should be permitted.

Avoid

Press **Avoidance Settings** to open a menu with different options that can be avoided automatically, if possible, when calculating route. For example, select tunnels, areas with congestion charge and ferries.

Suggestions for petrol stations

Press **Suggest Petrol Station** to activate or deactivate suggestions for nearby petrol stations in the driver display when the fuel level is low.

* Option/accessory.

[1] Estimated Time of Arrival

[2] Remaining Time to Arrival

15.4.4. Traffic settings

Settings are selected here to define how traffic information is displayed in the navigation system*.

Settings → Navigation → Traffic

The content of this manual represents the status of the user manual at the time of printing and may not be completely valid in future instances. For more information, refer to the first page for the complete disclaimer note.

Settings can be made within the following areas:

- **Show and Handle Traffic Events**
- **Avoid Traffic Events**
- **Show Free Flowing Traffic**
- **Real Time Traffic Information**

Show traffic events

Select whether traffic events should be shown on the map and used for route calculation:

- **None**
- **Major**
- **All**

Avoid traffic incidents

Select whether traffic incidents should be avoided when calculating a route:

- **Never**
- **Ask** (any suggestions for route changes are given during the journey)
- **Always**

Show free flowing traffic

Select **Show Free Flowing Traffic** to show this on the map.

Used Real Time Traffic Information^[1]

Select **Real Time Traffic Information** to use Real Time Traffic Information via the Internet (RTTI).

* Option/accessory.

^[1] Applies to certain markets.

15.5. Map update

15.5.1. Updating maps from an online car

When the car is connected to the Internet, the navigation system* maps can be updated^[1].

The home region must be selected in order to avoid downloading an unnecessarily large amount of data. This also reduces the number of notifications since updates for other regions are excluded. A useful method for large map updates is via a computer to a USB memory stick for subsequent transfer to the car.

Select home region by tapping on **Download Centre** → **Maps**. Select your region and then tap on **Set as home region**.

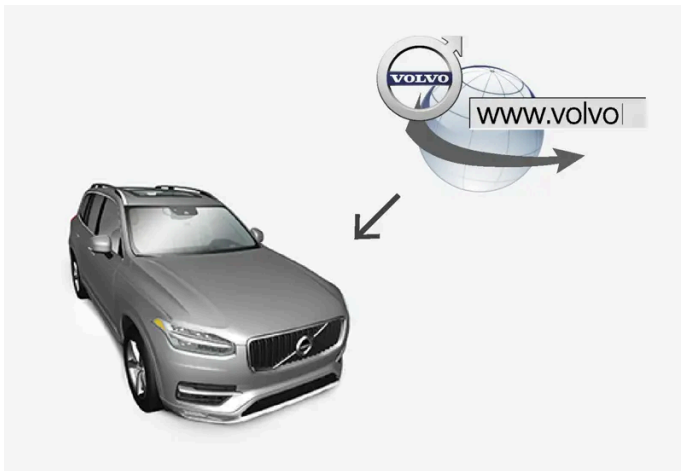

The principle of remote updating.



Tap on **Download Centre** in the app view.

➤ The app starts, and at **Maps**, you'll see a number indicating that updates are available for the specified home region. The figure remains visible until a new search for updates has been performed or until updates have been installed.

2 Press **Maps**.

3 Press **Install** and then **Confirm**.

➤ Installation of selected map/map update is started.

For further information, search support information at [volvocars.com](https://www.volvocars.com/) [https://www.volvocars.com/] or contact a Volvo dealer.

Automatic updating of map data

Automatic updating of the home region can be selected in the **Download centre**.

1 Tap on **Download Centre** in the app view.

2 Press **Maps**.

3 Automatic updating of map data can only be selected for the home region. If the home region is not already selected, press the down arrow to expand the region.

➤ Detailed map information is shown.

- 4 Press **Set as home region**.
- 5 Then scroll to the top of the list of regions, where you will find the currently selected home region.
- 6 Press the down arrow to expand the home region.
- 7 Tick the box for **Auto update**:
 - When the car is connected to the Internet and a map update is available, this will now be downloaded automatically to the car.

When a map download in progress is cancelled

If a map download has begun but the car is switched off before the download is complete, the process is paused and then resumed automatically when the car is started again and is reconnected to the Internet.

If one or more updates have been deselected or missed, the update files may be too large to be downloaded directly to the car. If this is the case, you can download the files from the [volvocars.com](https://www.volvocars.com) [<https://www.volvocars.com>] to a USB drive and then install the map in the car.

* Option/accessory.

[1] Only applies to certain countries.

15.5.2. Updating maps via computer and USB

New maps can be downloaded from an Internet-connected computer to a USB memory and then transferred from the USB memory to the car's navigation system*.

Preparations

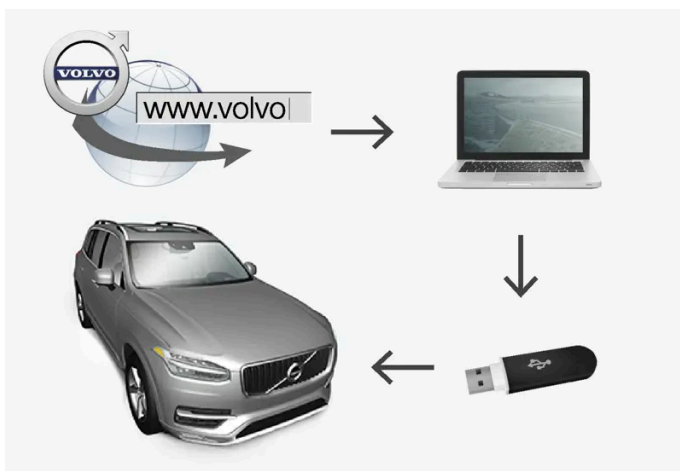

Updating via computer and USB memory

USB memory

The content of this manual represents the status of the user manual at the time of printing and may not be completely valid in future instances. For more information, refer to the first page for the complete disclaimer note.

The following requirements apply if a USB memory is to manage an update:

Parameter	Requirements
USB standard:	At least 2.0
File system:	FAT32, exFAT or NTFS
Capacity:	Up to 128 GB This depends on the market. Detailed information is provided for each market's map under the support information at volvocars.com [https://www.volvocars.com/].

Note current map version



Tap on **Download Centre** in the app view.

2 Press **Maps**

> Available map regions are shown.



Tap on the arrow to expand the selected region.

> Detailed map information is shown.

4 Note the map information under the map image.

Downloading of map data from the Internet to a USB memory

Have the USB memory and noted map information readily available.

- 1 Go to Volvo Cars support site ([volvocars.com/support](https://www.volvocars.com/support) [<https://www.volvocars.com/intl/support>]) on a computer with Internet connection and then, under **Downloads**, select map downloads.
- 2 Select the type of maps to be updated.
- 3 Click on the region to be updated.
 - > A map image with information on the latest map data for the region is shown.
- 4 Verify that the map version is newer than the one in the car.
- 5 Depending on which system you have, select the download link for either Windows or Mac.
- 6 Select "Run" to install the download program.

The content of this manual represents the status of the user manual at the time of printing and may not be completely valid in future instances. For more information, refer to the first page for the complete disclaimer note.

- 7 Click on "New download" to download the map to a USB memory stick or the computer's hard disk.
- 8 You can verify that the download/copying to the USB memory stick has worked correctly before you install the map in the car by repeating steps 1-2 and then pressing on "Check download" in the download program.

Download times can vary depending on the size of the map and the bandwidth of the connection. Verification of correct download to the USB memory stick before map installation in the car can be made by selecting to check the download in the download program.

Mobile connections via mobile devices or situations where the subscription used may have a monthly data limit are not suitable for use when downloading.

Transferring map data from a USB to the car

The time taken to transfer from USB memory to the car varies depending on map data size. The update can be performed while driving. The navigation system can be used to update a map region, but to update a whole map market, e.g. the EU, the navigation system cannot be used during the update. If installation is not finished when the car is switched off then the update continues when next driving. It is not necessary to perform the update while driving, but the ignition must be switched on. Battery support is recommended if the car is not driven during the update.

Updating

- 1 Activate the navigation system.
- 2 Connect the USB memory to the car's USB port. If there are two USB ports then the other one must not be used at the same time.
- 3 The navigation system automatically detects that an update is available and, during the update of the whole map database, shows on the screen what percentage of the process is complete.
 - For the update of an individual map region, the update starts immediately.
To start the update of the whole map database, the user must tap on **Confirm** - or on **Cancel** in order to cancel the installation.
- 4 Tap on **Confirm** - The update of the whole map database starts and information about how the process is proceeding is shown on the centre display.
- 5 The centre display shows when the transfer is complete - at which point, remove the USB memory.
- 6 Restart the infotainment system.
- 7 Verify that the correct map data have been transferred to the car by repeating the steps described under the previous heading "Note current map version".

Note

For the installation to start, the following criteria must be met:

- Selected area is included on the system's map. It is only possible to download the Scandinavia area if the system already has a Europe map. If a whole new map is downloaded then it overwrites the previous map.
- The version for the selected area is later than the one in the car.
- Selected area is compatible with the car's software. If the update is not compatible then new software will need to be downloaded.
- Selected area is compatible with the existing map. If the area is not compatible then the map will need to be replaced.

Interruptions

If there is an interruption during an update an explanatory text message is always shown on the centre display.

What happens if...	Answer
the Infotainment system is switched off during the update?	The process pauses and resumes automatically from where it stopped when the system is reactivated, e.g. when the engine is started.
the USB memory is pulled out before the update is complete?	The process pauses and resumes automatically from where it stopped when the USB memory is reconnected to the car.

For further information, search support information at [volvocars.com \[https://www.volvocars.com/\]](https://www.volvocars.com/) or contact a Volvo dealer.

* Option/accessory.

15.5.3. Map updates

MapCare is a free-of-charge map update service for Volvo cars equipped with Sensus Navigation*.

General information about updating

Maps may be updated 2-12 times a year (depending on market).

There are two ways to update maps. Either via a computer and a USB memory, or directly from the car^[1] (if the car is connected to the Internet).

The car's map is divided up into a number of predefined regions. When updating map data it is not necessary to update all the regions - the driver can choose to only update one or more specific regions.

One or several regions can be updated when the car is connected to the Internet. If a large number of regions - or the whole map - is to be updated, the total quantity of map data can be so large that it is much easier to update via a computer using a USB memory.

Note

If an itinerary stretches over several regions, they should all have the same version number. Otherwise there is the possibility that a calculated route may include an unexpected section of road.

Updating of the map structure

Sometimes the map structure must be changed - this occurs if a region has to be added or when a large region needs to be divided into smaller regions. When this occurs any attempt to update individual regions using a normal procedure will fail and a message will indicate the reason.

Instead, the whole map must be reinstalled using a USB memory stick. For further information, search support information at www.volvocars.com [<https://www.volvocars.com/>] or contact a Volvo dealer.

Updating of the navigation system software

Besides the map data, the navigation system's own software, which is subject to constant development, requires updating now and then. A situation can then arise where the latest updates of map data cannot be supported by the existing software of the navigation system. In which case, a message is shown to inform that the navigation system software must also be updated. This can be done at a Volvo dealer. It is also possible to get help with the map update itself at a Volvo dealer. However, note that even if the map update itself is free-of-charge, the workshop time for performing the update may involve charges.

Frequently asked questions

Question	Answer
Is it possible to change the platform for map data, e.g. from Europe to North America?	Yes, with some exceptions. Contact a Volvo dealer for up-to-date information.
How long does it take to download a map update?	It depends on the map file size and the connection bandwidth. Information about the update's size (MB) is shown on the screen.
How large is an update?	This depends on the market. Detailed information is provided for each market's map under the support information at volvocars.com [https://www.volvocars.com/].
None of this updating works - what should I do?	Search further support information at volvocars.com [https://www.volvocars.com/] or contact a Volvo dealer.
Unnecessary notifications for map updates are shown – what should you do?	Set the home region in order to reduce the number of notifications since this excludes updates for other areas. Tap on Download Centre → Maps and select your region, and then tap on Set as home region.

* Option/accessory.

[1] Only applies to certain countries.

15.6. Command list for voice control of the navigation system *

Several navigation system functions can be activated with voice commands. A list of them follows below.

Press  on the right-hand keypad on the steering wheel and say one of the following commands:

- **"Navigation"** - Initiates a navigation dialogue and shows examples of commands.
- **"Take me home"** - Guidance is given to the **Home** position.
- **"Go to [City]"** - Specifies a city as a destination. Example "Drive to London".
- **"Go to [Address]"** - Specifies an address as a destination. An address must contain city and street. Example "Drive to 5 King's Road, London".
- **"Add intersection"** - Starts a dialogue where two streets must be specified. The intersection point of the specified streets then becomes the destination.
- **"Go to [Post code]"** - Specifies a post code as a destination. Example "Drive to 1 2 3 4 5".
- **"Go to [contact]"** - Specifies an address from the phone book as a destination. Example "Drive to Robyn Smith"^[1].
- **"Search [POI category]"** - Searches for adjacent points of interest (POI) within a certain category (e.g. restaurants)^[2]. To have the list sorted along the route - say **"Along the route"** when the results list is shown.
- **"Search [POI category] in [City]"** - Searches for points of interest (POI) within a certain category and city. The list of results is sorted according to the city's central point. Example "Search for restaurant in London".
- **"Search [POI name]"**. Example "Search Kielder Forest".
- **"Change country/Change state"**^{[3],[4]} - Changes the search area for navigation.
- **"Show favourites"** – Shows saved positions in the driver display.
- **"Clear itinerary"** - Erases all the stored intermediate destinations and final destination in an itinerary.
- **"Repeat voice guidance"** - Repeats the last spoken guidance.
- **"Turn off voice guidance"** - Switches off voice guidance.
- **"Turn on voice guidance"** - Starts the switched-off voice guidance.

The following commands can generally be used, regardless of the situation:

- **"Repeat"** - repeats the last voice instruction in the ongoing dialogue.
- **"Help"** - starts a help dialogue. The system replies with the commands available in the current situation, a prompt or an example.
- It is possible to stop voice control both when the system is silent and when it is speaking.
 - **"Cancel"** – stops the dialogue when the system is silent.
 - Give a long press on  until two beep tones are heard – the dialogue stops, even if the system is speaking.

Addresses

When an address is entered, the search area is defined as the search area preset in the navigation system. It is possible to switch to a different search area. If the new search area uses a different language to the selected system language, the system will automatically switch to a different recognition engine. Therefore, state the address in the language used in the new search area.

Note

Note that addresses can only be searched for the country or state that the navigation system is preset for. To search for addresses in another country or state you first need to change search area.

 **Note**

Not all system languages support voice recognition. The ones that do are highlighted with the  symbol in the list of available system languages. Read more about where the information can be found in the section on settings for voice recognition.

* Option/accessory.

[1] In order to find addresses in the map database, they must have been entered correctly in the phone book, e.g. without spelling mistakes and abbreviations. Go to wego.here.com [<https://wego.here.com>] for spell checking.

[2] The user has the option of calling the POI or specifying it as a destination.

[3] In European countries, "Country" is used instead of "State".

[4] For Brazil and India, the search area is changed via the centre display.

15.7. Sensus Navigation *

Sensus Navigation is a satellite-based traffic information and navigation system.

The system provides guidance to a destination and provides information along the route, such as alternative routes in the event of accidents and roadworks.

You can arrange an itinerary, search for points of interest (POI ^[1]) along the route, save your own locations, etc.

The car's precise position is shown, and you will be guided to your destination if you take any wrong turns.

Apart from the practical advantages, Sensus Navigation can also contribute to a better environment by improving traffic flow and by selecting the best route based on the driver's settings.

* Option/accessory.

[1] Point of Interest

15.8. Activating and deactivating the navigation system *

The navigation system is activated automatically when the driver's door is opened and is deactivated only when the driver leaves the car and locks it.

Activating navigation



1 Navigation system tile

2 Home button

Show the map image in the centre display by tapping on the top tile (1) on the home view.

If the centre display does not show the navigation system tile – press briefly once on the home button (2) and then tap on the navigation system (1) tile.

Then a map of the current area is shown with the car symbolised by a blue triangle.



Press on this symbol to show the map image across the entire centre display.

Warning

Observe the following.

- Direct all your attention to the road and make sure that all your concentration is on driving.
- Follow applicable traffic legislation and drive with good judgment.
- Due to weather conditions or time of year affecting the road conditions, some recommendations may be less reliable.

Deactivating navigation

The navigation system cannot be switched off but always works in the background - it is only switched off when the driver locks and leaves the car.

Note

The navigation system is also available when the engine is switched off. When the battery level gets too low the system switches off.

* Option/accessory.

15.9. Control the navigation system* with voice recognition

If your car is equipped with Sensus Navigation you can use voice control to give spoken commands in order to control parts of your navigation system.

Start navigation

Here you can find an introduction on how to start to use voice control in order to control the navigation system in the car.



To activate a navigation command

- 1 Press the voice recognition button on the steering wheel  .
 - > You can now give commands, e.g. "Navigation" that start a navigation dialogue and show examples of commands.

Note

Not all system languages support voice recognition. The ones that do are highlighted with the  symbol in the list of available system languages. Read more about where the information can be found in the section on settings for voice recognition.

Use voice control to get directions to an address

To get directions to a specific address, use the spoken command **Go to** followed by the address. The order in which the address is given is important. To get directions to an address via voice control, the address must be given in the following order: (1) street address; (2) street number; (3) city; according to the following example:

- 1 Give the **Go to** command.
 - > Now you can give the address you want directions to.

2 Give the street address, e.g. "King Street"

3 Give the street number, e.g. "Five"

4 Give the city, e.g. "Gothenburg"

➤ In this case, the combined command will then be: "Go to King Street Five, Gothenburg". Provided the address is found in the system, you will now get directions to the address via your navigation system.

Use voice control to get directions to an address in another country or another county

Your navigation system installs sets of maps for the country or county where the car recognises its location. This means that in order to get correct directions across country or county borders, you need to first tell the system the country or county in which your desired destination address is located. You do this by using the **Change country** or **Change state** command. (The **Change state** command is primarily used in USA. The **Change country** command is used in the example below.)

1 Give the **Change country** command.

➤ Now you can give the country for the address to which you want directions, e.g. "Norway".

2 Now give the address to which you want directions by following the same procedure as in "Use voice control to get directions to an address".

➤ In this scenario, the combined command will be divided into 2 subcommands:

1. "Change country, Norway"

2. "Go to Karl Johans gate twenty two, Oslo"

Provided the address is found in the system, you will now get directions to Karl Johans gate 22, Oslo, Norway via your navigation system

Note

After changing country, try to pronounce the address you want directions to in the language of the destination country. This is necessary since the system's recognition changes automatically to the language of the selected country.

Use voice control to get directions to an address given as Home position

If you have given an address in your navigation system as a **Home** position, you can use a spoken command to get directions to the position.

1 Give the **Take me home** command.

➤ If the navigation system has a home position saved, you will now get directions to the position.

Use voice control to get directions to a place, shop or other specific business without giving an exact address

You can use your navigation system to get directions to special places or a specific type of business, so-called points of interest (POI ^[1]). Examples of points of interest are, for example, restaurants, hotels, petrol stations, museums or sights and landmarks.

You use the **Search** command to search for a point of interest. You can search for both a specific point of interest as well as point of interest categories.

Note

It is important which command you choose to use for obtaining directions to different alternatives. Please note that when you want directions to a point of interest, use the **Search** command. This is different from when you want directions to specific addresses. Then the **Go to** command must be used instead.

Search for a specific place or business

[**POI name**] here refers to a specific place or business, a so-called point of interest, e.g. a hotel, a restaurant, a municipal park, etc.

- 1 Give the **Search** command.
 - Now you can specify a specific point of interest you want directions to.
- 2 State [**POI name**], e.g. "Castle Forest"
 - In this case, the combined command will then be: "**Search** Castle Forest". Provided the place is found in the system, you will now get directions to the place via your navigation system.

Search for a point of interest category e.g. shops, hotels, restaurants, museums or other sights and landmarks or businesses

[**POI category**] here refers to specific types of place or business, so-called points of interest, e.g. hotels, restaurants, museums, etc.

- 1 Give the **Search** command.
 - Now you can specify the type of point of interest you want to find and get directions to.
- 2 State [**POI category**], e.g. "restaurant"
 - In this case, the combined command will then be: "**Search** restaurant". The navigation system will now search for restaurants located near and around the car, which results in a list in your driver display. The list that appears consists of suggestions the system has produced based on your command. Categories and close results are at the top, and the lower the relevance a suggestion is deemed to have, the lower down the list it appears.
Since you are looking for a category in this example, it may be a good idea to choose the category option closest to your search.
- 3 Select the category most appropriate for your search target in the list, in this case "restaurant(s)", by speaking the number of the row in which the option appears in the driver display.

The content of this manual represents the status of the user manual at the time of printing and may not be completely valid in future instances. For more information, refer to the first page for the complete disclaimer note.

➤ Now you can see your search results and select an option that suits you.

Use voice control to stop directions

If you want to stop directions and all of the intermediate destinations and the final destination, this can be done with a spoken command.

1 Give the **Clear itinerary** command.

➤ The navigation system stops the directions and deletes all of the intermediate destinations and the final destination along the travel itinerary.

How to give postcode and house number

The number commands are stated differently depending on the function to be controlled:

- **Postcodes** must be spoken individually, number by number, e.g. zero three one two two four four three (03122443).
- **House numbers** can be spoken individually or in groups, e.g. two two or twenty-two (22). For some languages, it is also possible to state them with hundreds, e.g. 19 hundred 22 (1922). For English and Dutch, several groups can be said in sequence, e.g. twenty-two twenty-two (22 22). For English, double or triple can be used, e.g. double zero (00). Numbers can be given within the range 0-2300.

Set destination using the phone book's contact list

If you want to set the address for a contact in the phone's phone book as destination then you can do this with the "**Go to[contact]**" command. However, for the address to be found in the database requires that the address is entered with the correct spelling and without abbreviations.

To spell check addresses in HERE's database, go to wego.here.com [<https://wego.here.com>]

* Option/accessory.

[1] Point Of Interest

15.10. Frequently asked questions about the navigation system *

The following are some frequently asked questions concerning the navigation system Sensus Navigation.

The system does not always calculate the fastest/shortest route

When calculating a route, several factors are taken into account to determine the theoretically best solution. Factors include route distance, road width, road classification, traffic intensity and speed limits. However, an experienced driver with local knowledge can quite possibly select a better route.

The system may for example use toll roads or ferries while the driver has chosen to avoid them

For technical reasons, the system can only use larger roads when calculating a route extending over a long distance.

If you selected to avoid toll roads and motorways, then they are avoided to the greatest possible extent and are only used if there is no other reasonable alternative available.

The position of the car on the map is wrong

The navigation system shows the position of the car to an accuracy of about 20 metres (65 ft).

There is a greater risk of error when driving on roads lying parallel to another road, on winding roads, on roads with several levels and after driving a long distance without making any distinctive turns.

High mountains, buildings, tunnels, viaducts, over/underpasses etc. also have a negative effect on the reception of satellite signals, which means that accuracy in calculating the position of the car may decrease.

Calibrating

Calibration takes place when you lock the car and allow it to remain locked for 15-30 seconds. If the problem with incorrect position persists following calibration, contact a workshop to check/calibrate the antenna unit.

The position of the car on the map is incorrect after transportation

If the car is transported, for example by ferry or train, or in such a way as to impede the reception of satellite signals, it can take up to 5 minutes before the position of the car is correctly calculated.

The car symbol on the screen behaves illogically after the tyres have been changed

In addition to the satellite receiver, the car's speed sensor and a gyroscope assist in calculating the current position, speed and direction of travel of the car. After fitting the spare wheel or changing between summer and winter tyres the system needs to "learn" the size of the new wheels.

In order that the system shall function optimally it is therefore recommended that the car is driven for a while on roads with good satellite reception (good visibility).

The map image does not correspond with the real situation

Factors such as the constant expansion and rebuilding of the road network, new traffic regulations constantly being introduced etc. mean that the map database is not always, in every situation, complete.

Because of this the map data is being constantly developed and updated - check now and again to see if there are any updates.

The car symbol on screen jumps forwards or spins

The system may need a few seconds to sense the position and movement of the car before driving off.

Switch off both the system and the engine. Start again, but remain stationary for a while before starting to drive.

The map information is not up to date

See the answer under the next heading.

Is the latest map information installed?

Map data are updated and improved continuously. In connection with map updates via computer and USB, the current map version in the car can be shown. Check the map version in the car and compare with the available map version in the support information on [volvocars.com](https://www.volvocars.com/) [<https://www.volvocars.com/>].

Current traffic information is not shown.

Activate Real Time Traffic Information (RTTI^[1]) in order to continuously retrieve information on traffic congestion, road closures and other events that may affect journey time. The car must be connected to the Internet where there is coverage in order to continuously retrieve traffic information.

* Option/accessory.

^[1] Real Time Traffic Information

15.11. Symbols and buttons in the navigation system *

The map in the centre display shows symbols and colours providing information about various roads and the area around the car and the route. A tool bar with different buttons for different settings is to the left.

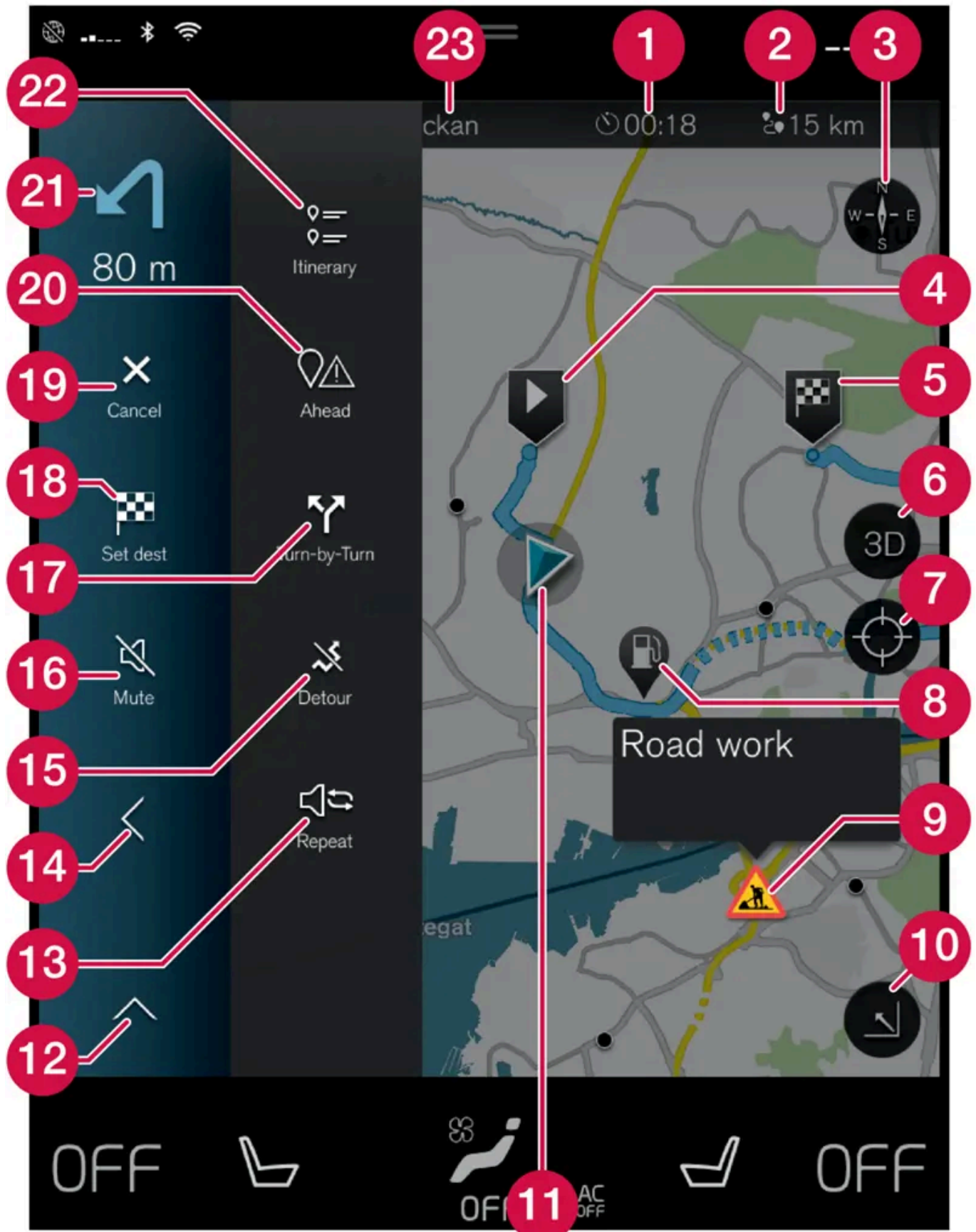

Symbols and buttons on the map

1	Arrival time/remaining travel time
2	Distance to destination
3	Compass/changes between north and travel direction up
4	Starting
5	Destination/final destination
6	Changes map display between 2D and 3D
7	Reset the map to follow the car
8	Point of interest (POI ^[1])
9	Traffic information
10	Minimises (expanded view) or maximises the map image (full screen)
11	Car on planned route
12	Minimises the tools field
13	Repeat the current voice guidance
14	Minimises the tools field
15	Calculate detour
16	Voice guidance temporarily On/Off
17	Shows list with the itinerary's guidance points
18	Specifying destinations/intermediate destinations
19	Cancels guidance
20	Shows list of the itinerary's points of interest (POI ^[1]) and traffic information
21	Next manoeuvre
22	Itinerary and Alternative route
23	Destination/final destination

* Option/accessory.

^[1] Point of Interest

15.12. Navigation license agreements*

A license^[1] is an agreement granting a right to conduct some activity or to make use of another person's right under the terms and conditions of the agreement.

END USER LICENSE AGREEMENT

PLEASE READ THIS END USER LICENSE AGREEMENT CAREFULLY BEFORE USING THE HERE DATABASE.

NOTICE TO THE USER

THIS IS A LICENSE AGREEMENT - AND NOT AN AGREEMENT FOR SALE – BETWEEN YOU AND HERE EUROPE B.V. ("HERE") FOR YOUR COPY OF THE HERE NAVIGABLE MAP DATABASE, INCLUDING ASSOCIATED COMPUTER SOFTWARE, MEDIA AND EXPLANATORY PRINTED DOCUMENTATION PUBLISHED BY HERE (JOINTLY "THE DATABASE"). BY USING THE DATABASE, YOU ACCEPT AND AGREE TO ALL TERMS AND CONDITIONS OF THIS END USER LICENSE AGREEMENT ("AGREEMENT"). IF YOU DO NOT AGREE TO THE TERMS OF THIS AGREEMENT, PROMPTLY RETURN THE DATABASE, ALONG WITH ALL OTHER ACCOMPANYING ITEMS, TO YOUR SUPPLIER FOR A REFUND.

OWNERSHIP

The Database and the copyrights and intellectual property or neighboring rights therein are owned by HERE and its licensors. Ownership of the media on which the Database is contained is retained by HERE and/or your supplier until you have paid in full any amounts due to HERE and/or your supplier pursuant to this Agreement or similar agreement(s) under which the Database is provided to you.

LICENSE GRANT

HERE grants you a non-exclusive license to use the Database for your personal use or, if applicable, for use in your business' internal operations. This license does not include the right to grant sub-licenses.

LIMITATIONS ON USE

The Database is restricted for use in the specific system for which it was created. Except to the extent explicitly permitted by mandatory laws (e.g. national laws based on the European Software Directive (91/250) and the Database Directive (96/9)), you may not extract or reutilize substantial parts of the contents of the Database nor reproduce, copy, modify, adapt, translate, disassemble, decompile, reverse engineer any portion of the Database. If you wish to obtain interoperability information as meant in (the national laws based on) the European Software Directive, you shall grant HERE reasonable opportunity to provide said information on reasonable terms, including costs, to be determined by HERE.

The Database includes information provided under license to HERE from third parties and is subject to the supplier terms and copyright notices set forth at the following URL:

Here.com/supplierterms

TRANSFER OF LICENSE

You may not transfer the Database to third parties, except when installed in the system for which it was created or when you do not retain any copy of the Database, and provided that the transferee agrees to all terms and conditions of this Agreement and confirms this in writing to HERE. Multi-disc sets may only be transferred or sold as a complete set as provided by HERE and not as subset thereof.

LIMITED WARRANTY

HERE warrants that, subject to the warnings set out below, for a period of 12 months after acquisition of your copy of the Database, it will perform substantially in accordance with HERE's Criteria for Accuracy and Completeness existing on the date you acquired the Database; these criteria are available from HERE at your request. If the Database does not perform in accordance with this limited warranty, HERE will use reasonable efforts to repair or replace your non-conforming copy of the Database. If these efforts do not lead to performance of the Database in accordance with the warranties set out herein, you will have the option to either receive a reasonable refund of the price you paid for the Database or to rescind this Agreement. This shall be HERE's entire liability and your sole remedy against HERE. Except as expressly provided in this section, HERE does not warrant nor make any representations regarding the use of results of the use of the Database in terms of its correctness, accuracy, reliability, or otherwise. HERE does not warrant that the Database is or will be error free. No oral or written information or advice provided by HERE, your supplier or any other person shall create a warranty or in any way increase the scope of the limited warranty described above. The limited warranty set forth in this Agreement does not affect or prejudice any statutory legal rights that you may have under the legal warranty against hidden defects.

If you did not acquire the Database from HERE directly, you may have statutory rights against the person from whom you have acquired the Database in addition to the rights granted by HERE hereunder according to the law of your jurisdiction. The above warranty of HERE shall not affect such statutory rights and you may assert such rights in addition to the warranty rights granted herein.

LIMITATION OF LIABILITY

The content of this manual represents the status of the user manual at the time of printing and may not be completely valid in future instances. For more information, refer to the first page for the complete disclaimer note.

The price of the Database does not include any consideration for assumption of risk of consequential, indirect or unlimited direct damages which may arise in connection with your use of the Database. Accordingly, in no event shall HERE be liable for any consequential or indirect damages, including without limitation, loss of revenue, data, or use, incurred by you or any third party arising out of your use of the Database, whether in an action in contract or tort or based on a warranty, even if HERE has been advised of the possibility of such damages. In any event HERE's liability for direct damages is limited to the price of your copy of the Database.

THE LIMITED WARRANTY AND LIMITATION OF LIABILITY, SET FORTH IN THIS AGREEMENT, DO NOT AFFECT OR PREJUDICE YOUR STATUTORY RIGHTS WHERE YOU HAVE ACQUIRED THE DATABASE OTHERWISE THAN IN THE COURSE OF A BUSINESS.

WARNINGS

The Database may contain inaccurate or incomplete information due to the passage of time, changing circumstances, sources used and the nature of collecting comprehensive geographic data, any of which may lead to incorrect results. The Database does not include or reflect information on - inter alia - travel time and may not include neighborhood safety; law enforcement; emergency assistance; construction work; road or lane closures; road slope or grade; bridge height, weight or other limits; road conditions; special events depending on the navigation system brand you possess.

GOVERNING LAW

This Agreement shall be governed by the laws of the jurisdiction, in which you reside at the date of acquisition of the Database. Should you at that moment reside outside the European Union or Switzerland, the law of the jurisdiction within the European Union or Switzerland where you acquired the Database shall apply. In all other cases, or if the jurisdiction where you acquired the Database cannot be defined, the laws of the Netherlands shall apply. The courts competent at your place of residence at the time you acquired the Database shall have jurisdiction over any dispute arising out of, or relating to this Agreement, without prejudice to HERE' right to bring claims at your then current place of residence.

* Option/accessory.

[1] EULA = End User License Agreement

15.13. Navigation system* in centre display

The navigation system is presented and operated in several different ways, e.g. via the centre display.

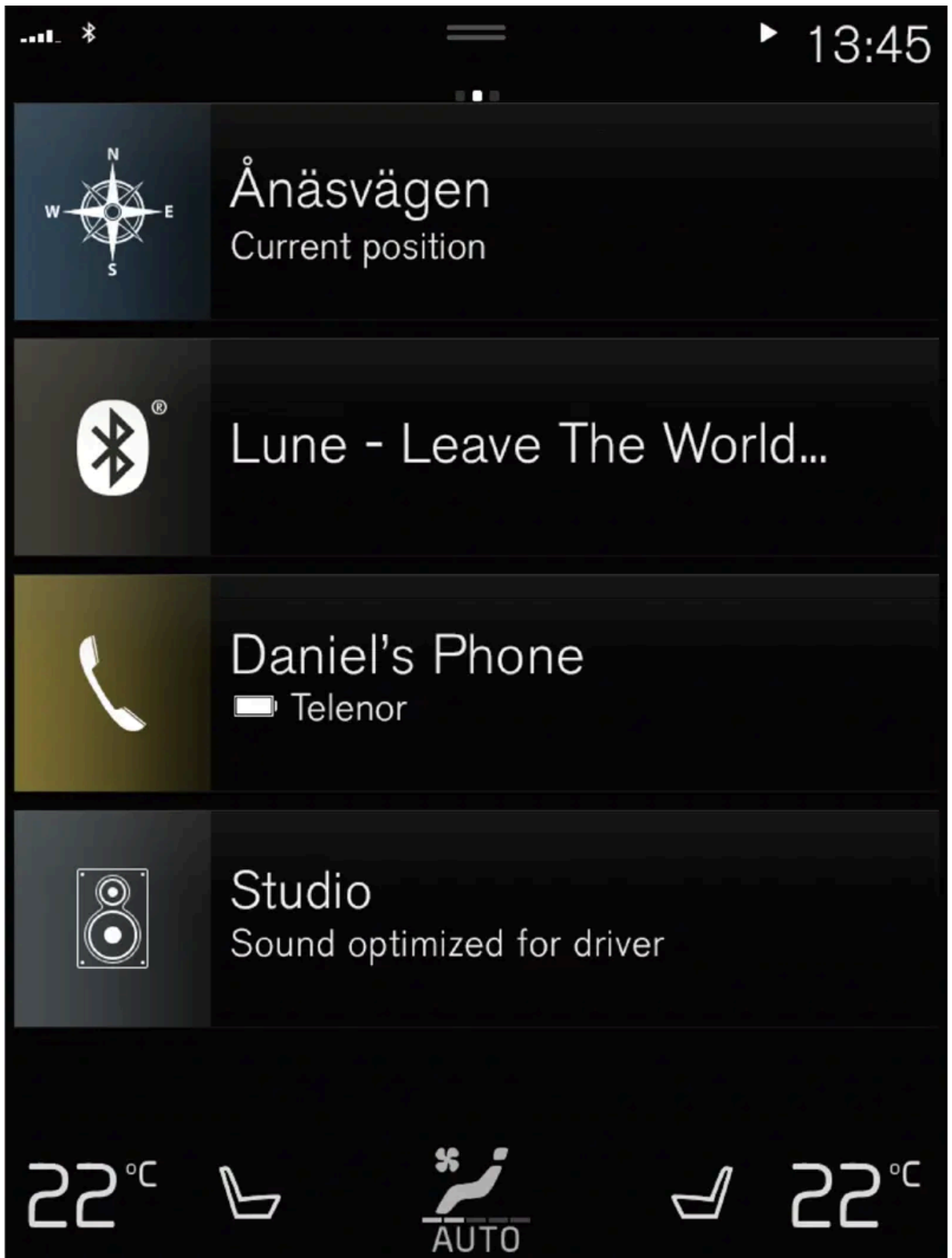

All settings for the navigation system are defined via the centre display. Here, the driver sets how the map is to be displayed or enters a destination.

If the map image is not shown in the centre display – tap on the top tile (for the navigation system).

Where am I?

What geographic position does the car have now?

- Press the map's car symbol (blue triangle) - the information is shown directly on the map.

Find the car symbol on the map



After zooming in and out and moving around on the map, it can sometimes be hard to find your way back to the position of the car. Press the crosshairs to reset the map to follow the car symbol.

North or direction of travel upwards on the map



There are two ways of showing the car's movement in relation to the map. Press the symbols to switch between having north or the direction of travel upwards on the map.

When the map is shown with north upwards, the car symbol moves in the current compass direction on the map.



If the car symbol moves to the left on the map, the car is driving westwards.

When the car symbol is pointing upwards, the map rotates under the car symbol, depending on how the car is turning. The compass symbol points towards north (N) on the map, and the centre of the compass shows the direction in which the car is pointing:

Compass symbols	Compass direction
N	North
NE	Northeast
E	East
SE	Southeast
S	South
SW	Southwest
W	West
NW	Northwest

2D or 3D display



Tap on the symbols to shift between 2D and 3D display.



For 3D display, the car's direction of travel is always shown upwards. The map rotates under the car symbol, depending on how the car is turning. The compass symbol indicates which direction north is (N) on the map, and the centre of the compass shows the direction in which the front of the car is pointing. The map scale is not shown in 3D mode.

For 2D display, the map is shown with north upwards, and the car symbol moves in the current compass direction on the map.

Zoom in

Make the map larger by tapping the centre display twice in quick succession or by placing two fingers on the centre display and separating them outwards.

Zoom out

Zoom out from the map by tapping once with two fingers on the centre display or dragging two fingers together on the centre display.

Scroll

Place one finger on the map, swipe in the desired direction, and release. The scroll function is only possible with the map maximised, not minimised.

Switching heading display

Maximise the map and press on the map heading at the top of the centre display. Choose between the following displays as the heading on the map:

1. Destination Destination, arrival time (ETA) or remaining travel time (RTA) and distance to destination (Distance). To select ETA or RTA, see the section "Settings for route and road navigation".
2. Current position as address (Address) or as coordinates (Coordinates). When coordinates are shown, altitude is also shown (Altitude). To choose between address and coordinates, see section "Map settings".

* Option/accessory.

15.14. Navigation system* in driver display

The navigation system is presented and operated in several different ways, e.g. via the driver display.



The map is only shown in the 12" driver display.

During driving the driver is guided by voice guidance and instructions on the driver display. Map display in the driver display can also be activated without a set destination.

The right-hand steering wheel keypad and the driver display

The right-hand steering wheel buttons can be used to manage some of the functions in the navigation system, e.g. **Take me home** and **Cancel guidance**. If a message is shown the driver display, it must first be acknowledged or dismissed for the menu to be shown.



- ❶ Opening/closing the menu. The menu is closed automatically after a period of inactivity or with certain options.
- ❷ Browsing between menus.
- ❸ Browsing between menu options.
- ❹ Confirm or highlight an option.

* Option/accessory.

15.15. Activating and deactivating the navigation system* in the driver display

The navigation system is shown automatically in the driver display when a destination is set. The navigation system can also be shown without specifying a destination.

- 1 Drag down the centre display's top view.
- 2 Press **Settings**.
- 3 Press **My Car** → **Displays** → **Driver Display Information**.
- 4 Press the radio button **Show Map** to show the navigation system in the driver display without an entered destination.

* Option/accessory.

15.16. Navigation system* in head-up display*

The navigation system is presented and operated in several different ways, e.g. via the head-up display.

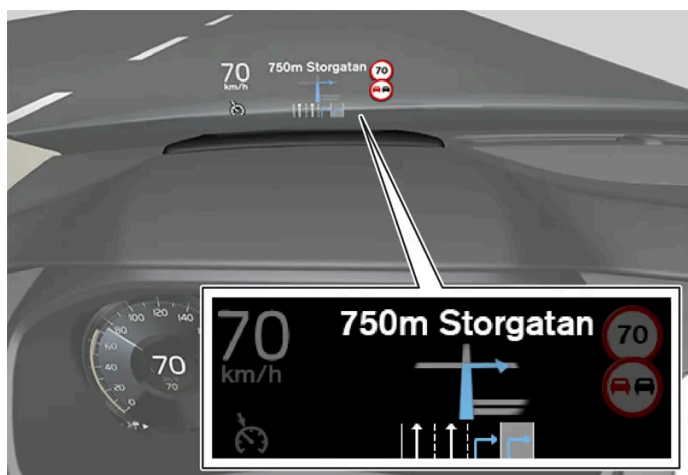

Navigation system on windscreen.

The driver can receive guidance and information from the navigation system in the head-up display at the bottom of the windscreen.

Whether or not the navigation system should be shown in the head-up display can be set, as well as the position of the information field.

* Option/accessory.

15.17. Suggest new map information with Map Creator

If your Volvo is equipped with Sensus Navigation, maps from the Here map supplier are shown. If you find that any information is missing from a map, or want to suggest changes, you can do this at Here's Map Creator service. Such information can include new addresses or rerouted roads.

On Here's [Map Creator \[https://mapcreator.here.com/?site=volvo-com-consumers\]](https://mapcreator.here.com/?site=volvo-com-consumers) service, you can create an account to log in and suggest map changes. Instructions for how to do this are also found there.

The changes you suggest are sent to Here for review. Once the information has been verified and approved, the information you suggested is added to their maps. The changes will be available in your Volvo after your suggestion has been approved by Here and implemented in a map update that you then install in your navigation system.

Suggestions for changes that are reported are reviewed and checked thoroughly before Here approves them and adds them to their maps. It can take up to twelve months before the changes reach the maps in your car.

 **Note**

Volvo does not have the opportunity to verify, approve or implement the requests for map changes you send to Here.

15.18. Traffic information providers

Information on which companies deliver traffic information to your car and its systems in different countries is found below.

Region	Country	RTTI ^[1]	RDS-TMC ^[2]	Sirius XM ^[3]	VICS	T-DMB
Africa	South Africa	INRIX				
Asia	China	INRIX				
	Indonesia	INRIX				
	Japan				VICS	
	Korea					KBS
	Singapore	INRIX				
	Thailand	INRIX				

Region	Country	RTTI ^[1]	RDS-TMC ^[2]	Sirius XM ^[3]	VICS	T-DMB
Europe	Austria	INRIX	[4]			
	Belgium	INRIX				
	Czech Republic	INRIX	[4]			
	Denmark	INRIX	[4]			
	Finland	INRIX				
	France	INRIX				
	Germany	INRIX	[4]			
	Hungary	INRIX				
	Italy	INRIX				
	Luxembourg	INRIX				
	Netherlands	INRIX				
	Norway	INRIX				
	Poland	INRIX				
	Portugal	INRIX				
	Russia	INRIX				
	Slovakia	INRIX				
	Slovenia	INRIX				
	Spain	INRIX	[4]			
	Sweden	INRIX	[4]			
	Switzerland	INRIX	[4]			
Turkey	INRIX					
UK	INRIX	ITIS				
Middle East	Bahrain	INRIX				
	Kuwait	INRIX				
	Oman	INRIX				
	Qatar	INRIX				
	Saudi Arabia	INRIX				
	The United Arab Emirates	INRIX				
North America and Central America	Canada	INRIX				
	Mexico	INRIX				
	USA	INRIX				
Oceania and Pacific Ocean	Australia	INRIX				
	New Zealand	INRIX				
South America	Brazil		HERE			



[1] Traffic information via the internet (requires internet connection)

[2] Traffic information via the FM band.

[3] Traffic information via Sirius satellite radio.

[4] Free service only.

16. Wheels and tyres

16.1. Changing wheels

16.1.1. Changing wheel

Wheel changes must always be performed correctly. Instructions on how a wheel is removed and mounted and what is important to remember are provided below. Check that the tyre dimension is approved for use on the car.

 **Warning**

- If a wheel must be changed in a trafficked environment, passengers must stand in a safe place.
- Use a jack designed for the car when changing tyres. Use supports to secure the car for all other work.
- Never crawl under the car or reach under with a part of your body when it is raised on a jack.
- Passengers must leave the car when it is raised on the jack.

 **Important**

The jack* included with the car is only designed for occasional, short-term use, such as when changing a wheel after a puncture. Only the jack belonging to the specific model is to be used to jack up the car. If the car is to be jacked up more often, or for a longer time than is required just to change a wheel, use of a garage jack is recommended. In this instance, follow the instructions for use that come with the equipment.

When the jack is not in use it must be stored in its storage space under the cargo area floor. The jack needs to be cranked together to the correct position in order to have space.

Removing a wheel

Read through all instructions before beginning. Take out the tools needed before jacking up the car.

- 1 Activate the hazard warning flashers and set out a warning triangle if a wheel shall be changed in a trafficked location.
- 2 Make sure that the parking brake is activated and engage gear position P.
- 3 Chock in front of and behind the wheels that remain on the ground. Use, for example, heavy wooden blocks or large stones.

- 4 Screw together the towing eye with the wheel wrench to the stop position.

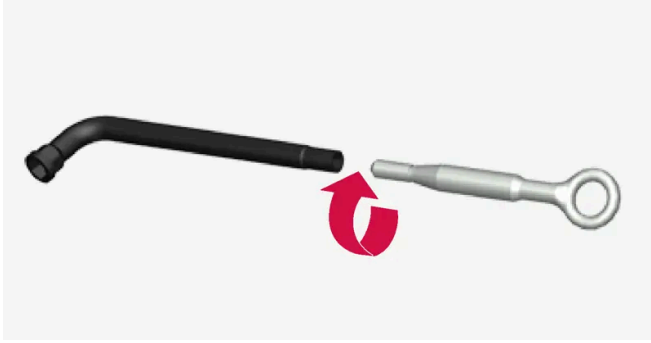

- 5 Remove the plastic caps from the wheel bolts with the intended tool.
- 6 With the car still on the ground, use the wheel bolt wrench/towing eye to undo the wheel bolts $\frac{1}{2}$ -1 turn by pressing downwards (anticlockwise). Always start with the lockable wheel bolts*.
- 7 Follow the instructions for how to safely raise the car with the jack.
- 8 Raise the car high enough to allow the wheel to be removed to move freely. Remove the wheel bolts and lift off the wheel.

Mounting a wheel

- 1 Clean the surfaces between wheel and hub.
- 2 Put on the wheel. Ensure that the correct dimension is fitted in the correct position for cars with different front and rear tyre or wheel dimensions. Tighten the wheel bolts thoroughly.
Do **not** use lubricant on the threads of the wheel bolts.
- 3 Lower the car so that the wheels cannot rotate.
- 4 Tighten the wheel bolts crosswise. It is important that the wheel bolts are tightened properly. Tighten to 140 Nm (103 foot-pound). Check the tightening torque with a torque wrench.



- 5 Refit the plastic caps over the wheel bolts.
- 6 Check the tyre pressure and save the new tyre pressure in the system for tyre pressure monitoring*.

 **Warning**

The wheel bolts may need to be re-tightened several days after the wheel change. Temperature differences and vibration may mean that they are not attached equally as tightly.

 **Note**

- After a tyre has been inflated, always refit the dust cap in order to avoid damage to the valve from gravel, dirt, etc.
- Only use plastic dust caps. Metal dust caps can rust and become difficult to unscrew.

* Option/accessory.

16.1.2. Jack*

The jack can be used to raise the car, for example, to change to a wheel.



 **Important**

The jack* included with the car is only designed for occasional, short-term use, such as when changing a wheel after a puncture. Only the jack belonging to the specific model is to be used to jack up the car. If the car is to be jacked up more often, or for a longer time than is required just to change a wheel, use of a garage jack is recommended. In this instance, follow the instructions for use that come with the equipment.

When the jack is not in use it must be stored in its storage space under the cargo area floor. The jack needs to be cranked together to the correct position in order to have space.

The jack needs to be cranked together to the correct position in order to have space.

 **Note**

Applies to cars with level control*: If the car is equipped with air suspension, this must be disabled before the car is raised.

* Option/accessory.

16.1.3. Wheel bolts

Wheel bolts are used to attach the wheels to the hubs.

Only use rims that are tested and approved by Volvo and which are Volvo genuine accessories.

Check the tightening torque of the wheel bolts with a torque wrench.

Do **not** use lubricant on the threads of the wheel bolts.

 **Warning**

The wheel bolts may need to be re-tightened several days after the wheel change. Temperature differences and vibration may mean that they are not attached equally as tightly.

 **Important**

The wheel bolts must be tightened to 140 Nm. (103 foot-pound). Overtightening or loose tightening may damage the nuts and the bolts.

Lockable wheel bolt kit*

To loosen or tighten the lockable wheel bolts – turn the wrench in the lock bolt until it fully engages in the code grooves. Always start with the lockable wheel bolts if the wheel shall be removed. When fitting the wheel, finish with the lock screw.

 **Important**

Remember not to use bending force when you loosen/tighten the wheel bolts. This could damage the code groove in the lock bolt and the wheel wrench and so make it impossible to fit/remove the wheel.

When the wheel wrench is not in use it must be stored in its place in the foam block under the cargo area floor. It is important to remember this if the car is due to visit a workshop in order to have the tool available. If you lose the wrench, contact your Volvo dealer.

* Option/accessory.

16.1.4. Spare wheel*

The spare wheel, the Temporary Spare type, can be used to temporarily replace a punctured normal wheel.

The spare wheel is only designed for temporary use. Replace it with a normal wheel as soon as possible.

The car's driving characteristics can be changed when the spare wheel is used and the ground clearance is reduced. Do not wash the car in an automatic car wash if the Temporary Spare is being used.

Recommended tyre pressure must be maintained regardless of the position of the temporary spare wheel on the car.

If the spare wheel is damaged, a new one can be purchased from a Volvo dealer.

Warning

- Never drive faster than 80 km/h (50 mph) with a spare wheel fitted on the car.
- The car must never be driven fitted with more than one "Temporary Spare" wheel.
- The car may have different driving characteristics while driving with the spare wheel. The spare wheel must be replaced with a normal wheel as soon as possible.
- The spare wheel is smaller than the normal wheel, which affects the car's ground clearance. Look out for high kerbs and do not machine-wash the car.
- Follow the manufacturer's recommended tyre pressure for the spare wheel.
- On all-wheel drive cars, the drive on the rear axle can be disengaged.
- If the spare wheel is fitted to the front axle then it is not possible to use snow chains at the same time.
- The spare wheel must not be repaired.

Important

The car must not be driven with tyres of different dimensions or with a spare tyre other than the one the car is approved for. Using tyres of different dimensions can cause serious damage to the car's transmission due to the different rolling circumferences.

Cars designed for different front and rear tyre or wheel dimensions must have the same type and make of tyres on the front and rear axles.

* Option/accessory.

16.1.5. Handling the spare wheel*

Follow these instructions for handling the spare wheel.

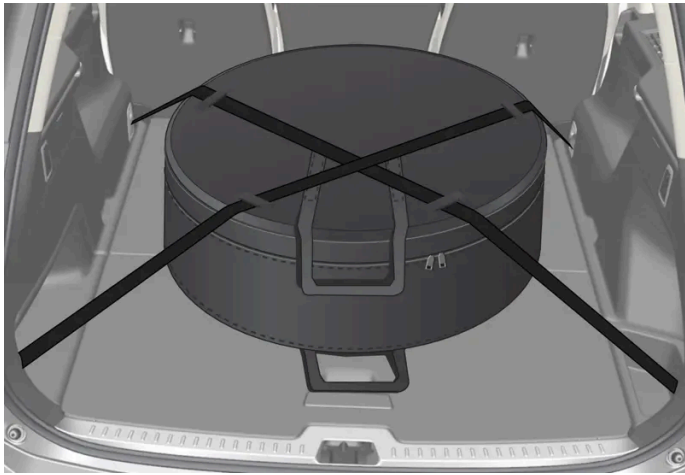

The illustration is generic and appearance may differ.

The spare wheel is stored in a bag and must be secured with two straps on the floor of the cargo area while driving^[1]. The straps must be tensioned crosswise over the wheel and attached in the car's four load retaining eyelets.

Tools for changing wheels are located under the cargo area floor.

* Option/accessory.

^[1] The backrests in the third seat row* must be lowered.

16.1.6. Snow chains

Use of snow chains and/or winter tyres can help to improve the traction in winter conditions.

Volvo recommends that snow chains are not used on wheel dimensions greater than 19 inches

Warning

Use Volvo genuine snow chains or equivalent chains designed for the car model, and tyre and rim dimensions. Only **single-sided** snow chains are permitted.

In the event of uncertainty about the snow chain, Volvo recommends that an authorised Volvo workshop should be contacted. The wrong snow chains may cause serious damage to the car and lead to an accident.

Using snow chains may result in malfunction of the tyre pressure monitoring system*^[1].

 **Important**

Snow chains can be used on the car with the following restrictions:

- Always follow the mounting instructions from the manufacturer carefully. Fit the chains as tensioned as possible and tension them at regular intervals.
- Snow chains must only be used on the front wheels (also applies to all-wheel drive cars).
- In some cases, snow chains must NOT be used, such as if accessory, aftermarket or "special" tyres and wheels are fitted that have a different size to the original tyres and wheels. Sufficient distance must be maintained between the chains and brakes, suspension and body components.
- Check local regulations with regard to using snow chains before fitting them.
- Never exceed the chain manufacturer's specified maximum speed. You must never exceed 50 km/h (30 mph) under any circumstances.
- Avoid bumps, holes or sharp turns when driving with snow chains.
- Avoid driving on bare ground as this wears out both the snow chains and tyres.
- Driving with snow chains may have a negative effect on the car's driving characteristics. Avoid fast or sharp turns, as well as braking with locked wheels.
- Some types of chain that are firmly tensioned affect brake components and must therefore NOT be used.

You can obtain more information on snow chains from a Volvo dealer.

* Option/accessory.

^[1] Indirect Tyre Pressure Monitoring System (ITPMS)

16.1.7. Winter tyres

Winter tyres are adapted for winter road conditions.

Volvo recommends winter tyres with particular dimensions. Tyre dimensions are dependent on engine variant. When driving on winter tyres, the correct type of tyres must be fitted to all four wheels.

Tips for changing to winter tyres

When summer and winter wheels are changed, mark which side of the car they were mounted on, for example **L** for left and **R** for right.

Contact a Volvo dealer for advice on which rim and tyre type suit your car best.

Studded tyres

Studded winter tyres should be run in gently for 500-1000 km (300-600 miles), so the studs settle properly into the tyres. This gives the tyre, and especially the studs, a longer service life.

Note

Laws regarding the use of studded tyres may vary. Always follow local laws and regulations.

Tread depth

Road conditions with ice, slush and low temperatures place considerably higher demands on tyres than summer conditions. Volvo therefore recommends not to drive on winter tyres that have a tread depth of less than 4 mm (0.15 inches).

16.1.8. Punctures

Activate the hazard warning flashers if the car has a puncture in a trafficked environment.

Think about safety. If possible, move the car out of danger from traffic. Call roadside assistance if necessary.

If possible, exit the car from the side with least traffic.

Put on a reflective vest and then position the warning triangle so that other road users are warned in good time.

Dealing with a puncture

The car is equipped with either a puncture repair kit for temporary tyre repair or a spare wheel*, see the respective section for user instructions.

* Option/accessory.

16.1.9. Tool kit

Tools that can be useful during towing, wheel changes or similar are found in the car's cargo area.



Examples of tools.

- 1 Jack*
- 2 Tool for removing the plastic caps from the wheel bolts
- 3 Funnel for filling fluids
- 4 Wheel wrench* and towing eye

If the car is fitted with a spare wheel*, there is a jack and a wheel bolt wrench instead of emergency puncture repair kit.

* Option/accessory.

16.2. Tyres

16.2.1. Dimension designation for tyre

Designations for tyre dimension, load index and speed rating.

The car has an approval for the complete vehicle with certain combinations of wheel rims and tyres.

Designation of dimensions

All tyres have a dimension designation, such as 235/60 R18 103 H.

235	Tyre width (mm)
60	Ratio between tyre wall height and tyre width (%)
R	Radial ply
	Rim diameter in inches
103	Codes for the maximum permitted tyre load, tyre load index (LI)
H	Speed rating for maximum permitted speed, speed rating (SS). (In this case 210 km/h (130 mph).)

Load index

Each tyre has a certain capacity to carry a load, a load index (LI). The car's weight determines the load capacity required of the tyres.

Speed rating

Each tyre can withstand a certain maximum speed. Tyre speed rating, SS (Speed Symbol), must at least correspond with the car's top speed. The table below shows the maximum permitted speed for each speed rating (SS). The only exception to these regulations is winter tyres^[1], where a lower speed rating may be used. If such a tyre is selected, the car must not be driven more quickly than the tyre is rated for. For example, cars with Q rating tyres must be driven at speeds not exceeding 160 km/h (100 mph). The road conditions and applicable road traffic rules determine how quickly the car can be driven, not the speed rating of the tyres.

The content of this manual represents the status of the user manual at the time of printing and may not be completely valid in future instances. For more information, refer to the first page for the complete disclaimer note.

Note

The maximum permitted speed is specified in the table.

Q	160 km/h (100 mph) (used only on winter tyres)
T	190 km/h (118 mph)
H	210 km/h (130 mph)
V	240 km/h (149 mph)
W	270 km/h (168 mph)
Y	300 km/h (186 mph)

Warning

The lowest permitted tyre load index (LI) and speed rating (SS) for the tyres for each respective engine variant are shown in the specifications, which can be found in the printed owner's manual. If a tyre with too low a load index or speed rating is used, it may overheat and be damaged.

^[1] Both those with metal studs and those without.

16.2.2. Approved tyre pressures

Approved tyre pressures for each engine alternative can be found in the table.

Note

All engines, tyres or combinations of these are not always available in all markets.

Engine	Tyre size	Speed	Load, 1-3 persons		Max. load		ECO pressure ^[1]
			Front kPa (psi) ^[2]	Rear kPa (psi)	Front kPa (psi)	Rear kPa (psi)	Front/rear kPa (psi)
All engines	235/55 R19 275/45 R20 275/40 R21 275/35 R22	0-160 km/h (0-100 mph)	260 (38)	260 (38)	290 (42)	290 (42)	290 (42)
		160+ km/h (100+ mph)	280 (41)	280 (41)	310 (45)	310 (45)	–

^[1] Economical driving.

^[2] In certain countries the "bar" unit is used alongside the SI unit "Pascal": 1 bar = 100 kPa.

16.2.3. Tyres' rotation direction

Tyres with a tread pattern which are designed to only turn in one direction have the direction of rotation marked with an arrow.

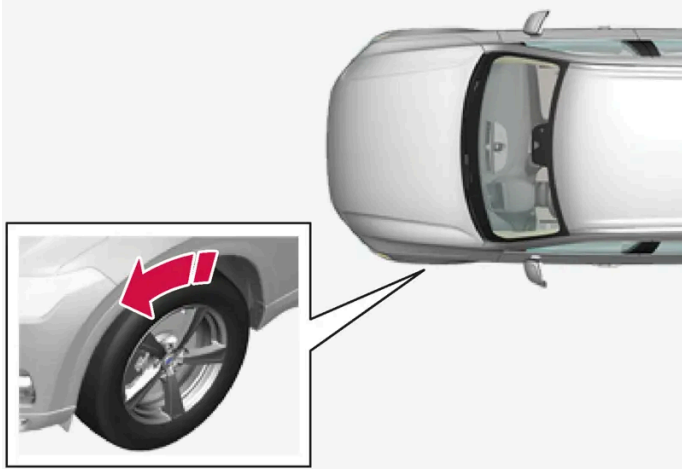

The arrow shows the tyre's direction of rotation.

- Tyres must rotate in the same direction during their entire service life.
- Tyres should only be switched between front and rear positions, never between left and right-hand sides, or vice versa.
- If the tyres are fitted incorrectly, the car's braking characteristics and capacity to force rain and slush out of the way are adversely affected.
- The tyres with the deepest tread depth should always be fitted to the rear of the car in order to reduce the risk of oversteer skidding.
- On cars with different front and rear tyre or wheel dimensions, it is not permitted to change position between front and rear wheels.
- Volvo recommends that the rear tyres do not have substantially less tread depth than the front tyres in order to reduce the risk of oversteer skidding when driving on wet roads.

i Note

Make sure that the front and rear axles have the same type, dimension and make of tyres.

Cars with different front and rear tyre dimensions must have the same type and make of tyres on the front and rear axles.

16.2.4. Tread wear indicators on the tyres

Tread wear indicators show the status of the tyre's tread depth.

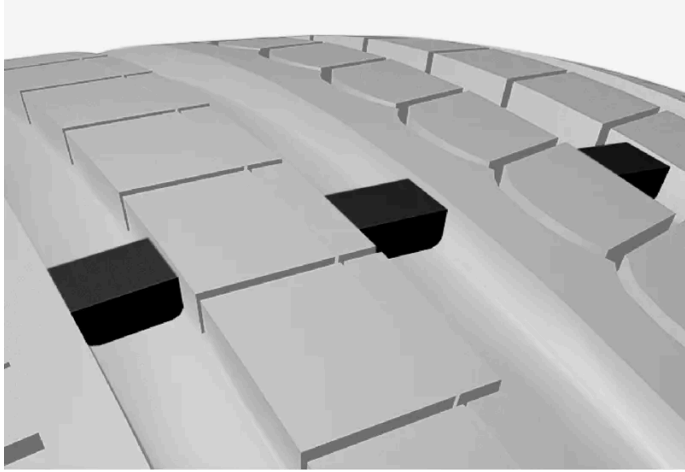

A tread wear indicator is a narrow elevation across the longitudinal grooves of the tyre's tread pattern. On the side of the tyre are the letters TWI (Tread Wear Indicator). When the tyre's tread depth is down to 1.6 mm (1/16 inch), the tread will be level in height with the tread wear indicators. Change to new tyres as soon as possible. Remember that tyres with little tread depth provide very poor grip in rain and snow.

16.2.5. Dimension designation for wheel rim

Wheel and rim dimensions are designated in accordance with the examples in the table below.

The car has an approval for the complete vehicle with certain combinations of wheel rims and tyres.

All wheel rims have a dimension designation, for example: 8Jx18x42.5.

8	Rim width in inches
J	Rim flange profile
18	Rim diameter in inches
42,5	Off-set in mm (distance from wheel centre to wheel contact surface against the hub)

16.2.6. Minimum permitted tyre load index and speed rating for tyres

The table below shows minimum permitted load index (LI) and speed rating (SS).

Engine	man/ aut	Minimum permitted load index (LI) ^[1]	Minimum permitted speed rating (SS) ^[2]
All engines	aut	103	H

^[1] The tyre's load index must be at least equal to or greater than indicated in the table.

^[2] The tyre's speed rating must be at least equal to or greater than indicated in the table.

16.3. Tyre pressure

16.3.1. Tyre pressure monitoring

16.3.1.1. Tyre pressure monitoring system *

The tyre pressure monitoring system ^[1] gives a warning with an indicator symbol in the driver display when the pressure in one or more of the car's tyres is too low.



This symbol illuminates to indicate low tyre pressure. Check the tyre pressure in the **Car Status** app in the centre display.

If there is a fault in the system the tyre pressure warning symbol flashes for approximately one minute and then remains illuminated.

System description

The tyre pressure monitoring system measures differences in rotation speed between the different wheels via the ABS system in order to be able to determine whether they have the correct tyre pressure. If the tyre pressure is too low, the tyre's diameter is changed and, as a result, so is its rotation speed. By comparing the tyres with each other the system can determine whether one or more tyres have pressure that is too low.

General information on the tyre monitoring system

In the information below, the tyre monitoring system is referred to generically as TPMS.

Each tyre, including the spare tyre*, should be checked once a month. When checking, the tyre should be cold and have the air pressure recommended by the car manufacturer specified on the tyre pressure label or in the tyre pressure table. If the car has tyres of a different size than that recommended by the manufacturer, find out what the correct air pressure level is for these.

As an extra safety feature, the car is equipped with a tyre pressure monitoring system (TPMS), which shows when the air pressure in one or more tyres is too low. When the indicator symbol for low air pressure is lit, stop and check the tyres as soon as possible and inflate to the correct air pressure.

Driving with tyres that have tyre pressure that is too low may cause the tyre to overheat, which can cause a tyre failure. Low tyre pressure also reduces fuel efficiency as well as tyre service life, and can affect car handling and stopping ability. Note that TPMS does not replace regular tyre maintenance. It is the driver's responsibility to maintain correct tyre pressure, even if the limit for low tyre pressure has not been reached so that the indicator symbol illuminates.

The car is also equipped with a TPMS system fault indicator, which indicates when the system is not functioning correctly. The TPMS system fault indicator is combined with the indicator symbol for low tyre pressure. When the system detects a fault, the symbol in the driver display will flash for about one minute and then remain illuminated. This procedure will be repeated when

The content of this manual represents the status of the user manual at the time of printing and may not be completely valid in future instances. For more information, refer to the first page for the complete disclaimer note.

the car is started until the fault has been rectified. When the symbol is illuminated, the system's ability to detect or warn of low tyre pressure may be affected.

A TPMS system fault can occur for several reasons, such as after changing to a spare tyre, or changing tyres or wheels that prevent TPMS from functioning correctly.

Always check the indicator symbol for TPMS after changing one or more tyres in order to ensure the new tyre or wheel is working correctly with TPMS.

To bear in mind

- Always save a new tyre pressure in the system after changing a wheel or adjusting tyre pressure.
- The use of snow chains may affect the tyre pressure monitoring system. This is indicated by a symbol and message in the driver display. When the snow chains are removed, all tyres should be checked and adjusted to the recommended tyre pressure. After that, the new tyre pressure needs to be saved in the tyre pressure monitoring system.
- If you change to tyres of a different size to the ones fitted at the factory, the system must be reset by storing a new tyre pressure for these tyres to avoid false warnings.
- If a spare wheel* is used, it is possible that the tyre pressure monitoring system will not work correctly due to the differences between the wheels.
- The system does not replace the need for regular tyre inspection and maintenance.
- It is not possible to switch off the tyre pressure monitoring system.

Warning

- Incorrect tyre pressure may lead to tyre failure, which could result in the driver losing control of the car.
- The system cannot indicate sudden tyre damage in advance.

* Option/accessory.

^[1] Indirect Tyre Pressure Monitoring System (ITPMS)

16.3.1.2. See tyre pressure status in the centre display*

With the system for tyre pressure monitoring^[1], tyre pressure status can be viewed in the centre display.

Checking status

Several minutes driving above 35 km/h (22 mph) are required for the system to become active.

- 1 Open the **Car Status** app in the app view.

- 2 Tap on **TPMS** to show the status of the tyres.

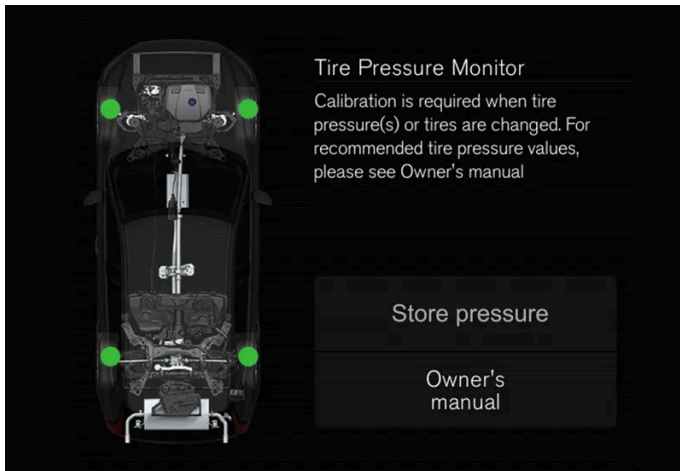

The figure is schematic. Layout may vary depending on car model or updated software.

* Option/accessory.

^[1] Indirect Tyre Pressure Monitoring System (ITPMS)

16.3.1.3. Action in the event of warning for low tyre pressure

When the system for tyre pressure^[1] warns that tyre pressure is too low, action is required.



Check and rectify the tyre pressure when the indicator symbol for the system is illuminated and the message for low tyre pressure message is shown.

- 1 Switch off the car.
- 2 Check the tyre pressure in all four tyres with a tyre pressure gauge.
- 3 Inflate the tyres to the correct pressure, see the decal on the door pillar on the driver's side showing the recommended pressure for factory fitted tyres.
- 4 Always save a new tyre pressure in the system via the centre display after the tyre pressure has been adjusted.
Note that the indicator symbol does not extinguish until the low tyre pressure has been rectified and storing a new tyre pressure has been started.

Several minutes driving above 35 km/h (22 mph) are required for the system to become active.

 **Note**

To avoid incorrect tyre pressure, the pressure should be checked on cold tyres. "Cold tyres" means the tyres are the same temperature as the ambient temperature (approx. 3 hours after the car has been driven). After a few kilometres of driving, the tyres warm up and the pressure increases.

 **Note**

- After a tyre has been inflated, always refit the dust cap in order to avoid damage to the valve from gravel, dirt, etc.
- Only use plastic dust caps. Metal dust caps can rust and become difficult to unscrew.

 **Warning**

- Incorrect tyre pressure may lead to tyre failure, which could result in the driver losing control of the car.
- The system cannot indicate sudden tyre damage in advance.

^[1] Indirect Tyre Pressure Monitoring System (ITPMS)

16.3.1.4. Saving a new reference value for tyre pressure monitoring*

In order for the system for tyre pressure monitoring^[1] to work correctly, a reference value for the tyre pressure must be saved. This must take place every time the tyres are changed or the tyre pressure is changed so that the system can warn about low pressure correctly.

For example, when driving with a heavy load or at high speed above 160 km/h (100 mph), the tyre pressure should be adjusted in accordance with Volvo's recommended tyre pressure values. The system is then reset by saving a new tyre pressure.

Perform the following procedure to store a new tyre pressure as a reference value in the system:

- 1 Switch off the car.
- 2 Inflate the tyres to the correct pressure, see the decal on the door pillar on the driver's side showing the recommended pressure for factory fitted tyres.
- 3 Start the car.
- 4 Open the **Car Status** app in the app view.
- 5 Press **TPMS**.

6

 **Note**

The car must be stationary for the **Store Pressure** button to be selectable.

Press **Store Pressure**.

- 7 Tap on **OK** to confirm that the tyre pressure in all four tyres has been checked and adjusted.
- 8 Drive the car until the new tyre pressure has been saved. The new tyre pressure is stored when the car is driven at a speed above 35 km/h (22 mph).
 - When sufficient data has been collected for the system to be able to detect low tyre pressure, the animation showing storage progress disappears from the centre display. The system does not provide additional confirmation that a new tyre pressure has been saved.

If storing fails, a message is shown.

 **Warning**

The exhaust gases contain carbon monoxide, which is invisible and odourless, but highly toxic. The procedure to save a new tyre pressure must therefore always be performed outdoors or in a workshop with exhaust extraction.

* Option/accessory.

^[1] Indirect Tyre Pressure Monitoring System (ITPMS)

16.3.1.5. Messages for tyre pressure monitoring*

A number of messages for the tyre pressure monitoring system^[1] can be shown. Here are some examples.

Driver display: Tyre pressure low Check Car Status app in center display	The indicator symbol switches on to indicate that there is low tyre pressure in one or more tyres. See the Car Status app in the centre display for more information.
Driver display: Tyre pressure system Temporarily unavailable	The indicator symbol flashes and changes to constant glow after approx. 1 minute. The system is currently unavailable, activated shortly.
Driver display: Tyre pressure system Service required	The indicator symbol flashes and changes to constant glow after approx. 1 minute. The system is not working correctly, contact a workshop ^[2] .

* Option/accessory.

^[1] Indirect Tyre Pressure Monitoring System (ITPMS)

^[2] An authorised Volvo workshop is recommended.

16.3.2. Checking tyre pressure

Correct tyre pressure helps to improve driving stability, save fuel and extend the service life of the tyres.

Tyre pressure decreases over time, this is a natural phenomenon. Tyre pressure also varies depending on ambient temperature. Driving on tyres with tyre pressure that is too low could result in the tyres overheating and being damaged. Tyre pressure affects travelling comfort, road noise and driving characteristics.

Check the tyre pressures monthly. Use the recommended tyre pressure for cold tyres in order to maintain good tyre performance. Tyre pressure that is too low or too high may cause uneven wear on the tyres.

Warning

- Tyre pressure that is too low is the most common cause of tyre failure and may result in serious cracks in the tyre, the tread loosening or the tyre exploding, with unexpected loss of control of the car and increased risk of personal injury.
- Tyres with pressure that is too low reduce the load capacity of the car.

Cold tyres

The tyre pressure must be checked when the tyres are cold. Tyres are considered cold when they have the same temperature as the surrounding air. This temperature is normally reached when the car has been parked for at least three hours.

After having driven approximately 1.6 km (1 mile) these tyres are considered as warm. If you have to drive further than this to inflate the tyres, first check and record the tyre pressure and inflate to a suitable tyre pressure when you arrive at the pump.

When the outside temperature changes, the tyre pressure also changes. A decrease in temperature of 10 degrees causes the tyre pressure to decrease 1 psi (7 kPa). Check the tyre pressure regularly and adjust to the correct pressure, which is specified on the car's tyre information decal or certification label.

If you check the tyre pressure when the tyres are warm then you must never release any air. The tyres are warm due to driving and it is normal for the pressure to increase above the recommended pressure for cold tyres. A warm tyre with tyre pressure equal to or below the recommendation for cold tyres may have a pressure that is far too low.

16.3.3. Adjusting tyre pressure

Tyre pressure decreases over time, this is a natural phenomenon. The tyre pressure must therefore sometimes be adjusted in order to maintain the recommended tyre pressure.

Use the recommended tyre pressure for cold tyres in order to maintain good tyre performance and even tread wear.

Note

To avoid incorrect tyre pressure, the pressure should be checked on cold tyres. "Cold tyres" means the tyres are the same temperature as the ambient temperature (approx. 3 hours after the car has been driven). After a few kilometres of driving, the tyres warm up and the pressure increases.

- 1 Remove the cap from the valve on one tyre and then press down the tyre pressure gauge firmly onto the valve.
- 2 Inflate the tyres to the correct pressure, see the decal on the door pillar on the driver's side showing the recommended pressure for factory fitted tyres.
- 3 Refit the dust cap.

i Note

- After a tyre has been inflated, always refit the dust cap in order to avoid damage to the valve from gravel, dirt, etc.
- Only use plastic dust caps. Metal dust caps can rust and become difficult to unscrew.

- 4 Check the tyres visually for any implanted nails or other objects that could puncture the tyre and cause leakage.
- 5 Check the sidewalls for any cavities, cuts, bumps or other irregularities.
- 6 Repeat this for all tyres, including the spare tyre*.

i Note

If you have over-inflated, release air by pressing in the metal pin in the centre of the valve. Then check the pressure again using the tyre pressure gauge.

Some spare tyres require a higher tyre pressure than other tyres. Check in the tyre pressure table or on the tyre pressure label.

* Option/accessory.

16.3.4. Location of tyre pressure label

The tyre pressure label on the driver's side door pillar (between frame and rear door) shows which pressures the tyres should have at different loads and speed conditions.



Tyre pressure label location

The decal displays the designation for the factory-fitted tyres on the car, as well as load limits and tyre pressure.

Note

It is not intended that the decals illustrated in the owner's manual should be exact replicas of those in the car. They are included to show their approximate appearance and locations in the car. The information that applies to your particular car can be found on the decal on the car.

Improved fuel economy with ECO pressure

For a light load (max. 3 people) and a speed of up to 160 km/h (100 mph), the ECO pressures can be chosen for good fuel economy. However, the lower comfort pressures are recommended instead if improved noise and travelling comfort are desired.

16.4. Emergency puncture repair

16.4.1. Emergency puncture repair kit

The emergency puncture repair kit (TMK^[1]) is used to seal a puncture as well as to check and adjust the air pressure in the tyre.

Cars equipped with spare tyre* do not have the puncture repair kit.

The puncture repair kit consists of a compressor and a bottle with sealing fluid. The sealing works as a temporary repair.

i Note

The sealing fluid is effective at sealing tyres with tread punctures but has limited ability to seal tyres with sidewall punctures. Do not use the emergency puncture repair kit on tyres displaying larger slits, cracks or similar damage.

i Note

The compressor is intended for temporary emergency puncture repair and is approved by Volvo.

Location

The puncture repair kit is located in the foam block under the cargo area floor.



Sealing fluid expiry date

The bottle of sealing fluid must be replaced if the bottle's expiry date has passed (see the decal on the bottle). Treat the old bottle as environmentally hazardous waste.

^[1] Temporary Mobility Kit

* Option/accessory.

16.4.2. Inflating tyres with the compressor from the puncture repair kit

The car's original tyres can be inflated using the compressor in the emergency puncture repair kit.

- 1 The compressor must be switched off. Make sure that the switch is in position 0 (Off), and take out the electrical cable and the air hose.

- 2 Unscrew the tyre's dust cap and screw in the air hose's valve connection to the bottom of the thread on the tyre's air valve.

Check that the pressure reducing valve on the air hose is fully screwed in.

- 3 Connect the electrical cable to the closest 12 V socket and start the car.

 **Warning**

Inhaling car exhaust fumes could result in danger to life. Never leave the engine running in sealed areas or areas that lack sufficient ventilation.

 **Warning**

Do not leave children in the car without supervision when the engine is running.

- 4 Start the compressor by flicking the switch to position I (On).

5  **Important**

Risk of overheating. The compressor must not run for more than 10 minutes.

Inflate the tyre to the pressure specified on the tyre pressure label on the driver side door pillar. Release air using the pressure reducing valve if the tyre pressure is too high.

- 6 Switch off the compressor. Detach the air hose and the electrical cable.
- 7 Refit the dust cap on the tyre.

 **Note**

- After a tyre has been inflated, always refit the dust cap in order to avoid damage to the valve from gravel, dirt, etc.
- Only use plastic dust caps. Metal dust caps can rust and become difficult to unscrew.

 **Note**

The compressor is an electrical device. Follow local regulations related to waste management.

16.4.3. Using a puncture repair kit

The emergency puncture repair kit (TMK^[1]) can be used to seal a puncture. Read through all instructions before use.

The content of this manual represents the status of the user manual at the time of printing and may not be completely valid in future instances. For more information, refer to the first page for the complete disclaimer note.

Overview



- 1 Electrical cable
- 2 Air hose
- 3 Pressure reducing valve
- 4 Protective cap
- 5 Label, maximum permitted speed
- 6 Bottle holder (orange cap)
- 7 Pressure gauge
- 8 Sealing fluid bottle
- 9 Switch

Connecting

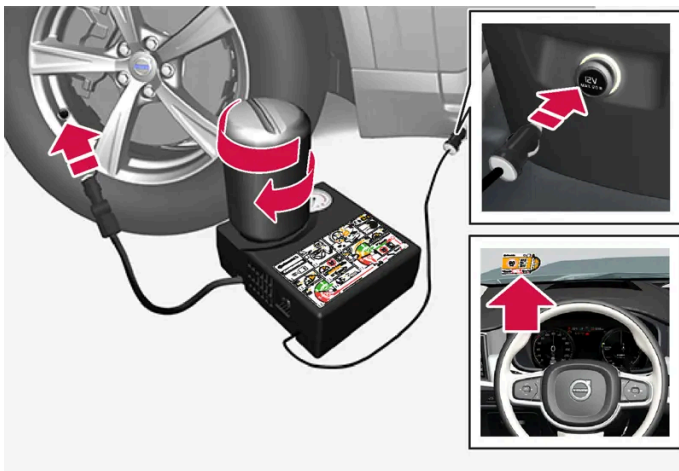

i Note

Do not break the bottle's seal before use. The seal is broken automatically when the bottle is screwed in.

 **Warning**

Please keep the following points in mind when using the tyre sealing system:

- The sealing fluid bottle contains 1) rubber latex, natural and 2) ethanediol. These substances are harmful if swallowed.
- The contents of this bottle may cause allergic skin reactions or otherwise be potentially harmful to the respiratory tract, the skin, the central nervous system, and the eyes.

Precautions:

- Store out of the reach of children.
- Harmful if ingested.
- Avoid prolonged or repeated contact with the skin. If sealing fluid has come into contact with your clothes, remove them.
- Wash thoroughly after handling.

First aid:

- Skin: Wash affected areas of skin with soap and water. Get medical attention if symptoms occur.
- Eyes: Flush with plenty of water for least 15 minutes, occasionally lifting the upper and lower eyelids. Get medical attention if symptoms occur.
- Inhalation: Move the exposed person to fresh air. If irritation persists, get medical attention.
- Ingestion: Do NOT induce vomiting unless directed to do so by medical personnel. Get medical attention.
- Disposal: Dispose of this material and its container at a hazardous or special waste collection point.

 **Warning**

Do not remove the bottle or air hose while the puncture repair kit is being used.

1 Preparations

Set up the warning triangle and activate the hazard warning lights if a tyre is being sealed in a trafficked location.

If the puncture was caused by a nail or similar, allow this to remain in the tyre. It helps to seal the hole.

- 2 Detach the decal for maximum permitted speed that is affixed on one side of the compressor. Affix it visibly on the wind-screen as a reminder to observe the speed limit. You should not drive faster than 80 km/h (50 mph) after the emergency tyre repair kit has been used.
- 3 Check that the switch is in position 0 (Off), and locate the electrical cable and the air hose.
- 4 Unscrew the orange-coloured cap from the compressor, and unscrew the cork from the sealing fluid bottle.
- 5 Screw in the bottle to the bottom of the bottle holder.

The bottle and the bottle holder are equipped with a reverse catch to prevent sealant leakage. When the bottle is screwed in it cannot be unscrewed from the bottle holder again. The bottle must be removed at a workshop ^[2].

 **Warning**

Do not unscrew the bottle, it is equipped with a reverse catch to prevent leakage.

- 6** Unscrew the tyre's dust cap and screw in the air hose's valve connection to the bottom of the thread on the tyre's air valve.

Check that the pressure reducing valve on the air hose is fully screwed in.

7 Begin puncture repair

Connect the electrical cable to the closest 12 V socket and start the car.

 **Note**

Make sure that none of the other 12 V sockets is in use when the compressor is operating.

 **Warning**

Do not leave children in the car without supervision when the engine is running.

 **Warning**

Inhaling car exhaust fumes could result in danger to life. Never leave the engine running in sealed areas or areas that lack sufficient ventilation.

- 8** Start the compressor by flicking the switch to position I (On).

When the compressor starts, the pressure can increase up to 6 bar (88 psi), but the pressure drops after about 30 seconds.

 **Warning**

Never stand next to the tyre when the compressor is running. If cracks or unevenness arise then the compressor must be switched off immediately. The journey should not be continued. Call roadside assistance for recovery to a tyre centre. Volvo recommends an authorised tyre centre.

- 9** Inflate the tyre for 7 minutes.

 **Important**

The compressor must not be operated for longer than 10 minutes - risk of overheating.

- 10** Switch off the compressor to check the pressure on the pressure gauge. Minimum pressure is 1.8 bar (26 psi) and maximum is 3.5 bar (51 psi). Release air by pressing the pressure reducing valve if the tyre pressure is too high.

 **Warning**

If the pressure is below 1.8 bar (26 psi) then the hole in the tyre is too big. The journey should not be continued. Call roadside assistance for recovery to a tyre centre. Volvo recommends an authorised tyre centre.

- 11 Switch off the compressor and detach the electrical cable.
- 12 Unscrew the air hose from the tyre valve and refit the dust cap on the tyre.

 **Note**

- After a tyre has been inflated, always refit the dust cap in order to avoid damage to the valve from gravel, dirt, etc.
- Only use plastic dust caps. Metal dust caps can rust and become difficult to unscrew.

- 13 Fit the protective cap on the air hose in order to avoid leakage of the remaining sealing fluid. Place the equipment in the cargo area.
- 14 As soon as possible, drive at least 3 km (2 miles) at a maximum speed of 80 km/h(50 mph) so that the sealing fluid can seal the tyre, and then perform a follow-up check.

 **Warning**

Sealant will spurt out of the puncture during the first few rotations of the tyre. Make sure that nobody is standing near the car and gets the sealing fluid splashed onto them when the car is driven away. The distance should be at least 2 metres (7 feet).

15 Follow-up inspection

Connect the air hose on the tyre valve and screw in the valve connection to the bottom of the tyre valve's thread. The compressor must be switched off.

- 16 Read the tyre pressure on the pressure gauge.
 - If it is below 1.3 bar (19 psi) then the tyre is insufficiently sealed. The journey should not be continued. Call roadside assistance for recovery.
 - If the tyre pressure is higher than 1.3 bar (19 psi), the tyre must be inflated to the pressure specified in accordance with the tyre pressure label on the driver's side door pillar (1 bar = 100 kPa = 14.5 psi). Release air using the pressure reducing valve if the tyre pressure is too high.

 **Warning**

Check the tyre pressure regularly.

Volvo recommends that the car is driven to the nearest authorised Volvo workshop for the replacement/repair of the damaged tyre. Advise the workshop that the tyre contains sealing fluid.

The sealing fluid bottle and hose must be replaced after use. Volvo recommends that these replacements be performed by an authorised Volvo workshop.

 **Warning**

Maximum mileage with tyres containing sealing fluid is 200 km (120 miles).

 **Note**

The compressor is an electrical device. Follow local regulations related to waste management.

^[1] Temporary Mobility Kit

^[2] An authorised Volvo workshop is recommended.

16.5. Winter driving

16.5.1. Snow chains

Use of snow chains and/or winter tyres can help to improve the traction in winter conditions.

Volvo recommends that snow chains are not used on wheel dimensions greater than 19 inches

 **Warning**

Use Volvo genuine snow chains or equivalent chains designed for the car model, and tyre and rim dimensions. Only **single-sided** snow chains are permitted.

In the event of uncertainty about the snow chain, Volvo recommends that an authorised Volvo workshop should be contacted. The wrong snow chains may cause serious damage to the car and lead to an accident.

Using snow chains may result in malfunction of the tyre pressure monitoring system * ^[1].

 **Important**

Snow chains can be used on the car with the following restrictions:

- Always follow the mounting instructions from the manufacturer carefully. Fit the chains as tensioned as possible and tension them at regular intervals.
- Snow chains must only be used on the front wheels (also applies to all-wheel drive cars).
- In some cases, snow chains must NOT be used, such as if accessory, aftermarket or "special" tyres and wheels are fitted that have a different size to the original tyres and wheels. Sufficient distance must be maintained between the chains and brakes, suspension and body components.
- Check local regulations with regard to using snow chains before fitting them.
- Never exceed the chain manufacturer's specified maximum speed. You must never exceed 50 km/h (30 mph) under any circumstances.
- Avoid bumps, holes or sharp turns when driving with snow chains.
- Avoid driving on bare ground as this wears out both the snow chains and tyres.
- Driving with snow chains may have a negative effect on the car's driving characteristics. Avoid fast or sharp turns, as well as braking with locked wheels.
- Some types of chain that are firmly tensioned affect brake components and must therefore NOT be used.

You can obtain more information on snow chains from a Volvo dealer.

* Option/accessory.

^[1] Indirect Tyre Pressure Monitoring System (ITPMS)

16.5.2. Winter tyres

Winter tyres are adapted for winter road conditions.

Volvo recommends winter tyres with particular dimensions. Tyre dimensions are dependent on engine variant. When driving on winter tyres, the correct type of tyres must be fitted to all four wheels.

Tips for changing to winter tyres

When summer and winter wheels are changed, mark which side of the car they were mounted on, for example **L** for left and **R** for right.

Contact a Volvo dealer for advice on which rim and tyre type suit your car best.

Studded tyres

Studded winter tyres should be run in gently for 500-1000 km (300-600 miles), so the studs settle properly into the tyres. This gives the tyre, and especially the studs, a longer service life.

 **Note**

Laws regarding the use of studded tyres may vary. Always follow local laws and regulations.

Tread depth

Road conditions with ice, slush and low temperatures place considerably higher demands on tyres than summer conditions. Volvo therefore recommends not to drive on winter tyres that have a tread depth of less than 4 mm (0.15 inches).

16.5.3. Preparations for a long trip

Before a driving holiday or some other type of long journey, it is important to check the car's functions and equipment particularly carefully.

Check that

- the engine is working normally and that fuel consumption is normal
- there are no leaks (fuel, oil or other fluid)
- braking effect on braking works as intended
- the tyres have sufficient tread depth and pressure. Change to winter tyres when driving to areas where there is a risk of snowy or icy road surfaces
- starter battery charging is good
- the wiper blades are in good condition
- a warning triangle and high-visibility vest are located in the car - legally required in certain countries

It may also be advisable to make sure that the maps in the navigation system* are updated, and to check the regulations for loading and for travelling on a car ferry or train, if appropriate.

Note that additional data roaming costs may be charged when the car is online abroad.

* Option/accessory.

16.5.4. Winter driving

For winter driving it is important to perform certain checks of the car in order to ensure that it can be driven safely.

Check the following in particular before a cold season:

- The engine coolant must contain 50% glycol. This mixture protects the engine against frost down to approx. -35°C (-31°F). To avoid health risks, different types of glycol must not be mixed.

The content of this manual represents the status of the user manual at the time of printing and may not be completely valid in future instances. For more information, refer to the first page for the complete disclaimer note.

- The fuel tank must be kept filled to prevent condensation.
- Engine oil viscosity is important. Oils with lower viscosity (thinner oils) facilitate starting in cold weather and also reduce fuel consumption while the engine is cold.
- The condition of the starter battery and charge level must be inspected. Cold weather places great demands on the starter battery and its capacity is reduced by the cold.
- The condition of the battery and its charge level must be inspected. Cold weather places higher demands on the battery and its capacity is reduced by the cold.
- Use washer fluid with antifreeze to avoid ice forming in the washer fluid reservoir.

See the separate section for engine oil recommendations.

Slippery driving conditions

To achieve optimum roadholding Volvo recommends using winter tyres on all wheels if there is a risk of snow or ice.

Note

The use of winter tyres is a legal requirement in certain countries. Studded tyres are not permitted in all countries.

Practise driving on slippery surfaces under controlled conditions to learn how the car reacts.

16.6. Tyres

The function of the tyres is to carry load, provide grip on the road surface, dampen vibration and protect the wheel from wear.

The tyres greatly affect the car's driving characteristics. The type of tyre, dimensions, tyre pressure and speed rating are important for how the car performs.

The car is fitted with tyres according to the tyre information sticker found on the driver's side door pillar (between the front door and the rear door).

Warning

A damaged tyre may lead to loss of control over the car.

Recommended tyres

On delivery, the car is equipped with Volvo original tyres that have the VOL^[1] marking on the side of the tyres. These tyres are carefully adapted to the car. In the event of changing tyres, it is therefore important that the new tyres also have this marking in order for the car's driving characteristics, comfort and fuel consumption to be maintained.

New tyres

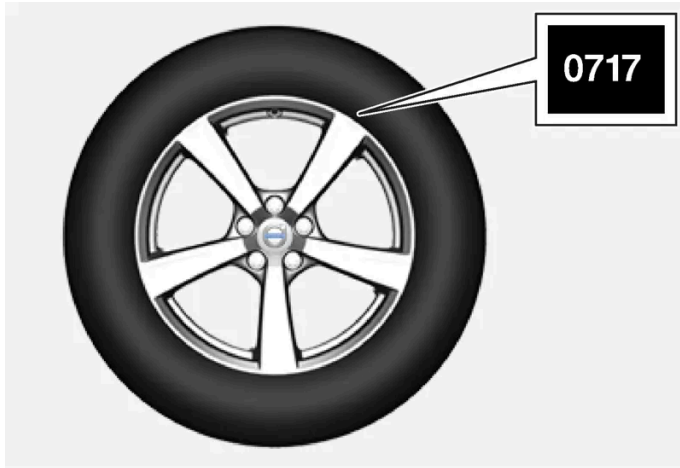

Tyres are perishable. After a few years they begin to harden at the same time as the friction capacity/characteristics gradually deteriorate. For this reason, aim to get as fresh tyres as possible when you replace them. This is especially important with regard to winter tyres. The last four digits in the sequence mean the week and year of manufacture. This is the tyre's DOT marking (Department of Transportation), and this is stated with four digits, for example 0717. The tyre is then manufactured in week 07, year 2017.

Tyre age

All tyres older than 6 years old should be checked by an expert even if they seem undamaged. Tyres age and decompose, even if they are hardly ever or never used. The function can therefore be affected. This applies to all tyres that are stored for future use. Examples of external signs which indicate that the tyre is unsuitable for use are cracks or discolouration.

Tyre economy

- Maintain the correct tyre pressure.
- Avoid fast starts, heavy braking and squealing tyres.
- Tyre wear increases with speed.
- Correct wheel alignment is very important.
- Unbalanced wheels worsen tyre economy and travelling comfort.
- The tyres should rotate in the same direction during their entire service life.
- When you change tyres, the tyres with the deepest tyre tread can be fitted on the rear axle in order to reduce the risk of oversteer skidding during aquaplaning, cornering or sudden braking on wet roads.
- If you drive over kerbstones or deep holes you can damage the tyres and/or wheel rims permanently.
- On cars with different front and rear tyre or wheel dimensions, it is not permitted to change position between front and rear wheels.

Tyre rotation

Driving style, tyre pressure, climate and road condition affect how quickly the tyres age and wear. Correct tyre pressure results in more even wear.

To avoid major differences in tread depth, and to prevent wear patterns forming on the tyres, the front and rear wheels can be switched with each other. A suitable distance for the first change is approx. 5000 km (approx. 3100 miles) and then at

10000 km (approx. 6200 miles) intervals.

Volvo recommends the an authorised Volvo workshop is contacted for checking if you are uncertain about tread depth. If significant differences in wear (> 1 mm difference in tread depth) between tyres have already occurred, then the least worn tyres should be fitted on the rear. Understeer skidding is normally easier to correct than oversteer skidding. This is why it is important for the rear wheels not to lose grip before the front wheels.

 **Important**

Cars with different tyre or wheel dimensions on the front and rear axles must always have the wider tyres and/or wheels on the rear axle. It is therefore not permitted to change between front and rear wheels in order to obtain a more even tyre wear between front and rear tyres, for example.

Storing wheels and tyres

When you store complete wheels (tyres fitted on wheel rims) they should be hung up or positioned lying on their sides on the floor.

Tyres not fitted on rims must be stored lying on their sides or standing upright, but not hung up.

 **Important**

Tyres should be stored in a cool, dry and dark place, and should never be stored close to solvents, petrol, oils, etc.

 **Warning**

- Wheel rim size and tyre size for your Volvo are specified to meet stringent requirements for stability and driving characteristics. Unapproved combinations of wheel rim size and tyre size may have a negative effect on the car's stability and driving characteristics.
- Any damage caused by the fitting of unapproved combinations of wheel rim size and tyre size is not covered by the new car warranty. Volvo accepts no liability for death, personal injury or any costs caused by such installations.

^[1] There may be deviations for certain tyre dimensions.

16.7. Approved wheel and tyre sizes

In certain countries not all approved sizes are indicated by the registration document or other documents. The following table shows all approved combinations of wheel rims and tyres.

✓ = Approved

Engine	man/ aut	235/55 R 19 8x19x42.5	275/45 R 20 ^[1] 9x20x38.5	275/40 R 21 ^[1] 9x21x38.5	275/35 R 22 ^[1] 9x22x38.5
All engines	aut	✓	✓	✓	✓

[1] Only in combination with wheel arch extension.

17. Loading, storage and passenger compartment

17.1. Loading

17.1.1. Recommendations for loading

There are a number of things that are important to bear in mind when loading the car.

Payload depends on the car's kerb weight. The total of the weight of the passengers and all accessories reduces the car's payload by a corresponding weight.



Warning

The car's driving properties change depending on the weight and positioning of the load.

Loading in the cargo area

Good things to remember when loading:

- Position the load firmly against the rear seat's backrest.
- Heavy objects should be placed as low as possible. Avoid placing heavy loads on lowered backrests.
- Cover sharp edges with something soft to avoid damaging the upholstery.
- Secure all loads to the load retaining eyelets with straps or web lashings.



Warning

A loose object weighing 20 kg (44 pounds) can, in a frontal collision at a speed of 50 km/h (30 mph) carry the impact of an item weighing 1000 kg (2200 pounds).



Warning

Leave 10 cm (4 inches) space between the load and the side windows if the car is loaded to above the top edge of the door windows. Otherwise, the intended protection of the inflatable curtain, which is concealed in the headlining, may be compromised.

 **Warning**

Always secure the load. During heavy braking the load may otherwise shift, causing injury to the car's occupants.

Cover sharp edges and sharp corners with something soft.

Switch off the engine and apply the parking brake when loading/unloading long items. Otherwise you may accidentally knock the gear lever or gear selector with the load into a drive position - and the car could then move off.

Increasing the space in the cargo area

To expand the cargo area and simplify loading, the rear seat's backrest can be lowered. Note that objects must not prevent the function of the WHIPS system for the front seats if any of the rear seat's backrests is folded down.

Level control of the car's rear section *

The car's rear section can be lowered/raised in order to create a better working height for the car's cargo area or to assist when a trailer shall be coupled/uncoupled to/from the towbar*.

Level control is performed via a control at the rear on the right-hand side in the cargo area's side panel.



Controls for raising/lowering the car's rear section.

The control consists of two buttons - one button that lowers and one button that raises the rear section of the car. For raising or lowering, each button must be held depressed until the rear section has reached the desired level.

It is not possible to raise the car's rear section higher than its normal level.

During driving, the rear section height will return to the normal level.

 **Note**

It is not possible to adjust the height of the rear section when one or more of the doors or the bonnet is open. This does not apply to the tailgate.

 **Warning**

Pay attention to ensure that there is no person, animal or object under the car when lowering. This would involve danger to life and damage to the car or object.

* Option/accessory.

17.1.2. Bag hooks

Bag hooks keep carrier bags in place and prevent them from overturning and spreading their contents across the cargo area.

Along the sides



There are two extensible bag hooks in the side panels - one on each side of the cargo area.

 **Important**

The bag hooks may be loaded with a maximum of 5 kg (11 lbs).

17.1.3. Operating cargo cover*

There are two extended positions for the cargo cover - a full-cover position and a loading position, where it is partially extended to make it easier to reach further into the cargo area.

Full-cover position

For 7-seat car



Hang up the locking tabs of the seatbelts for the third seat row on the designated hooks in the side panels.

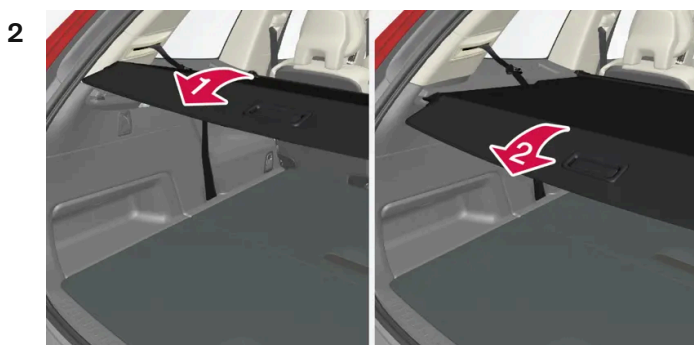

1 Grip the handle and pull out the cargo cover so that it slides over the side panels in the cargo area. Pull to the end position.

3 **2** When the cargo cover is extended so that it covers the cargo area - guide the cover's attachment pins into the grooves in the side panels and release, while at the same time angling the handle with a light downward pressure.

➤ The cargo cover is locked in the full-cover position.

For 5-seat car

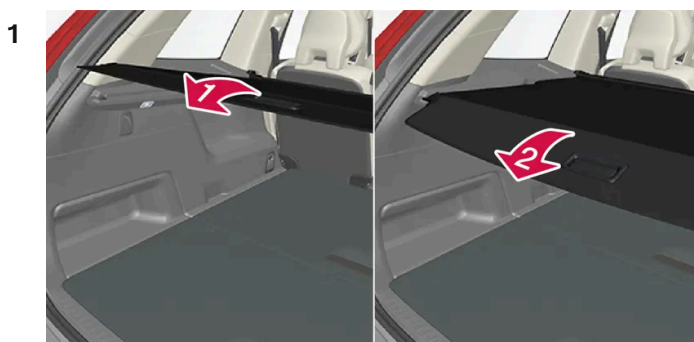



Grip the handle and pull out the cargo cover so that it slides over the side panels in the cargo area. Pull to the end position.



When the cargo cover is extended so that it covers the cargo area - guide the cover's attachment pins into the grooves in the side panels and release, while at the same time angling the handle with a light downward pressure.

➤ The cargo cover is locked in the full-cover position.

 **Important**

Do not load objects on top of the cargo cover.

 **Warning**

In a 7-seat car, never have the cargo cover fitted when there are passengers in the rear seats. This may lead to serious injury in the event of a collision.

Loading mode

1

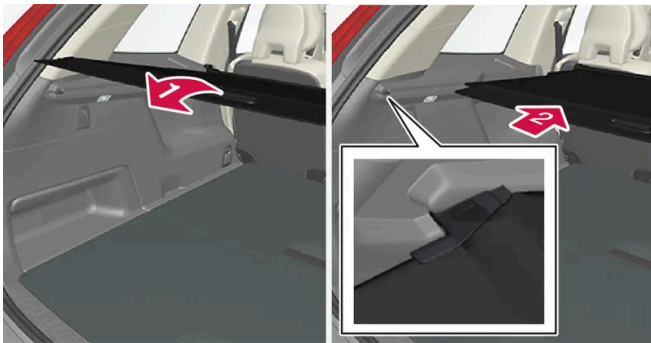

From retracted position - grip the handle and pull out the cover so it slides over the side panels in the cargo area - pull to the end position and guide the cargo cover's attachment pins into the grooves in the side panels. (If the cover is already in the full-cover position - see the next point)



From full-cover position - grip the handle and guide the cargo cover's attachment pins into the grooves in the side panels and release.

➤ Retract the cover until it stops in the loading position.

In the event that your hands are occupied:

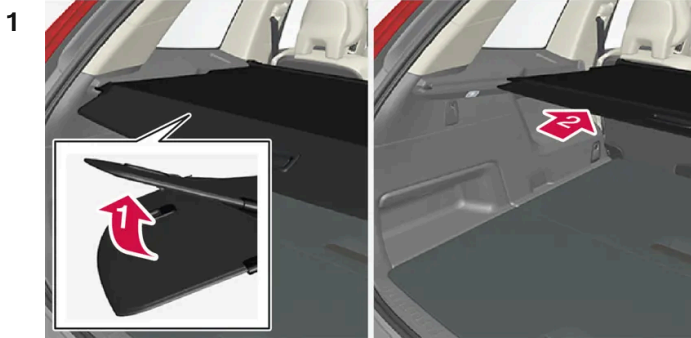

In the extended full-cover position - lightly push the handle part of the cargo cover upward, e.g. with an elbow.

- > 2 The cover retracts until it stops in the loading position.

To return to full-cover position from loading position:

- 1 Grip the handle and pull the cargo cover out to the end position.
 - 2 Release slightly and angle the handle by means of a light downward pressure.
- > The cover is locked in the full-cover position.

Retracting

- 1 From the full-cover position:
Lift up the handle and pull it backward to disengage the cargo cover's attachment pins and then release.
From loading position:
Grip the handle and pull out the cargo cover in the grooves - pull to the full-cover position. Lift up the handle and pull it backward to disengage the attachment pins and then release.
- 2 Retract the cover with its attachment pins outside of the side panels until it stops in the retracted position.

* Option/accessory.



17.1.4. Fitting and removing cargo cover*

The content of this manual represents the status of the user manual at the time of printing and may not be completely valid in future instances. For more information, refer to the first page for the complete disclaimer note.

In the extended position, the cargo cover prevents visual access to the cargo area.

Fitting cargo cover



- 1  Insert one of the cargo cover's end pieces in the recess in the side panel in the cargo area.
 - 2  Then insert the other end piece in the recess in the side panel on the opposite side.
 - 3  Press down the end pieces on both sides - one by one.
- When a "click" is heard and the red marking on each end piece has disappeared, the cargo cover is attached - check that it is affixed securely.

Removing cargo cover

In retracted position:

- 1 Depress the button on one of the retracted cargo cover's end pieces and lift out that end.
In a 7-seat car - release the third seat row's seatbelt locking tabs from the hooks above the side panels.
 - 2 Angle the cover up/out carefully.
- The other end piece loosens automatically and the cover can be lifted out of the cargo area.

* Option/accessory.

17.1.5. Load retaining eyelets

Use the load retaining eyelets to attach straps in order to anchor items in the cargo area.

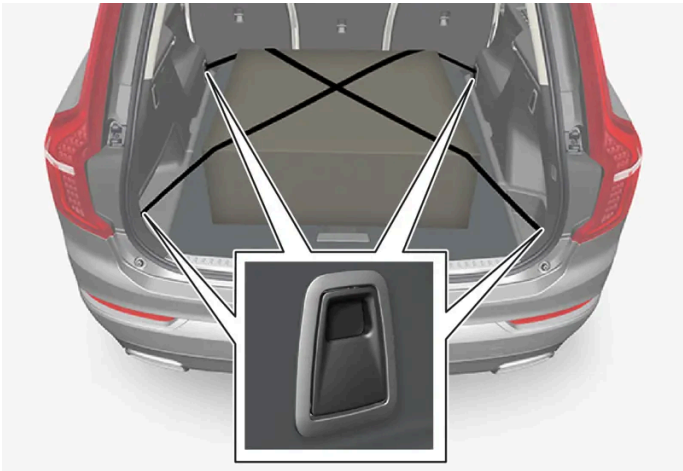

Warning

Hard, sharp and/or heavy objects which protrude may cause injury under violent braking.

Always secure large and heavy objects with a seatbelt or cargo retaining straps.

17.1.6. Fitting and removing safety grilles *

The safety grille prevents loads or pets in the cargo area from being thrown forward in the passenger compartment under heavy braking.

The safety grille is crash-tested in accordance with the ECE R17 legal requirement and fulfils Volvo's strength requirements.



For safety reasons, the safety grille must always be attached and anchored correctly.

 **Warning**

Under no circumstances may anybody remain in the cargo area while the car is moving. This is to avoid injury in the event of heavy braking or an accident.

The safety grille's parts consist of the grille and two loose attaching braces. The attaching braces each come with a screw cap and there are two plastic sleeves for the safety grille.

 **Warning**

The safety grille must only be used in the rear position described here. The roof mountings behind the front seats are not intended for the safety grille.

 **Warning**

For safety reasons, the third seat row^[1] must be lowered when the safety grille is fitted in the car.

 **Important**

It is not possible to have the protective grille fitted at the same time as the cargo cover.

Installation

- 1 Lower the rear seat and then lift the safety grille in through one of the rear side doors or via the tailgate - the arched/convex side of the grille should face the cargo area while the hooks on each side point up. The attaching braces and plastic sleeves are not used in this stage.

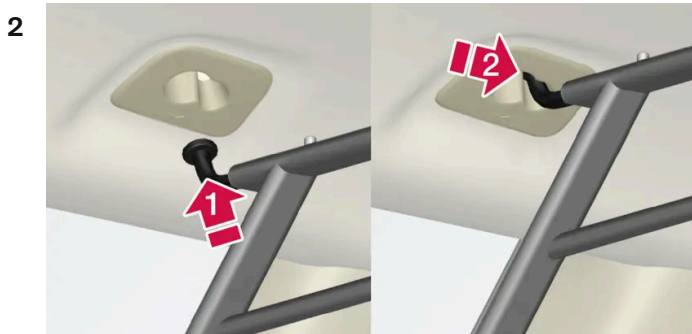

Guide one of the safety grille's hooks into the larger opening in the roof mounting (1).

Grasp the grille near the hook and pull/slide it towards the smaller opening (2).

➤ The hook is now secured in the roof mounting's end position.

- 3 Repeat the steps in point 2 above to secure the other hook in the mounting on the other side.

 **Warning**

Make sure the hooks of the safety grille are securely fitted in the roof mountings so there is no risk of the grille coming loose.

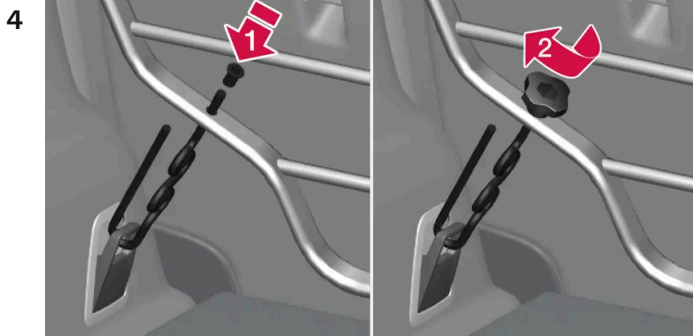

Hook the attaching brace's hook through the load securing eyelet at the cargo floor from underneath, and guide the threaded part through the cargo grille's lower attachment hole from underneath (1).

Slide a plastic sleeve on the threaded part of the attaching brace - the sleeve flange should face up - and guide it down through the hole. Then screw on the screw cap until its lower edge is approx. 5 mm from the grille (2).

- 5 Repeat the steps in point 4 on the other side.
- 6 Centre the safety grille and then tighten the two attaching braces alternately until the grille is properly secured.

Removal

Remove the safety grille by performing the above steps in reverse order.

Note that the attaching braces can be removed before the plastic sleeves are removed from the holes in the grille.

* Option/accessory.

[1] Applies to 7-seat cars.

17.1.7. Fitting and removing the safety net *

The safety net prevents loads from being thrown forward in the passenger compartment in the event of sudden braking.

The safety net is fitted into four mounting points.



For reasons of safety, the safety net must always be fastened and anchored as described below.

The net is made of a strong nylon fabric and can be secured two different locations in the car:

- Rear fitting - behind second seat row.
- Front fitting - behind the front seats.

 **Warning**

Loads in the luggage compartment must be anchored well, and also using a correctly fitted safety net.

Fitting the safety net

 **Warning**

It is necessary to ensure that the upper securing points of the safety net are fitted correctly and that the puller-straps are hooked in properly.

Damaged safety nets must not be used.

 **Note**

With forward mounting, the safety net is most easily mounted via the rear doors.

- 1 Unfold the safety net and make sure that the split upper rod in the net is locked in its extended position.
- 2 Hook one retaining hook of the net into the front or rear roof mounting with the anchoring strap locks turned towards you.
- 3 Hook the net's second attachment hook to the roof bracket on the opposite side.

The telescopically sprung attachment hooks make it easier to fit.

The content of this manual represents the status of the user manual at the time of printing and may not be completely valid in future instances. For more information, refer to the first page for the complete disclaimer note.

Take care to press forward the net's retaining hooks for each respective roof mounting's front end position.

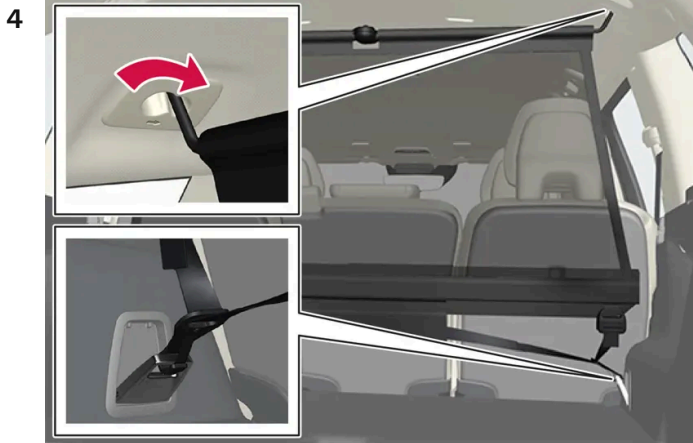

Rear fitting.

For rear fitting:

With the net fitted in the rear roof mountings, hook the safety net's puller-straps into the front load retaining eyelets in the cargo area.



Front fitting.

For front fitting:

With the net fitted in the front roof mountings, hook the puller-straps into the outer eyes on the rear of all seat slide rails. The procedure is facilitated if the backrests are straightened and the seats are moved forward slightly.

Pay attention to make sure that you do not exert hard pressure on the net when the seat and backrest are moved back again. Only adjust until the seat or backrest makes contact with the net.

 **Important**

If a seat or backrest is pushed backwards hard into the safety net, the net and roof mounts may be damaged.

5 Tension the safety net with the anchoring straps.

Removing the safety net

The safety net can be easily removed and folded up.

- 1 Reduce safety net tension by pressing the button in the anchoring strap lock and feeding out a little of the anchoring strap on each side.
- 2 Press in the catches and detach both of the anchoring strap's hooks.
- 3 Undo the upper attachments and release the net from the roof mountings.
- 4 Press the red button on the rod to enable folding and then roll up the net. Store the net in its case.

* Option/accessory.

17.1.8. Roof load and loading on load carriers

For loading on the car's roof, the load carriers that Volvo have developed are recommended.

This is to reduce the risk of damage to the car. Volvo's load carriers are available for purchase at authorised Volvo retailers.

Carefully follow the installation instructions supplied with the carriers.

- Distribute the load evenly over the load carriers. Put the heaviest objects at the bottom.
- Check periodically that the load carriers and load are properly secured. Lash the load securely with retaining straps.
- If the load is longer than the car at the front, e.g. a canoe or kayak, fit the towing eye to its front socket and attach the bungee to this.
- The size of the area exposed to the wind, and therefore fuel consumption, increase with the size of the load.
- Drive gently. Avoid quick acceleration, heavy braking and hard cornering.

Warning

The car's centre of gravity and driving characteristics are altered by roof loads.

Follow the car's specifications with regard to weights and maximum permitted load.

17.1.9. Towbar-mounted bicycle rack*

When using a bicycle rack, the bicycle racks that Volvo has developed are recommended.

This is in order to avoid damage to the car and in order to achieve the maximum possible safety during a journey. Volvo's bicycle racks are available for purchase at authorised Volvo dealers.

Carefully follow the instructions enclosed with the bicycle rack.

- Bicycle rack including load must weigh a maximum of 75 kg (165 pounds).
- The bicycle rack may be designed for a maximum of three bicycles.

 **Warning**

Incorrect use of the bicycle rack may cause damage to the towbar and car.

The bicycle rack can loosen from the towbar if it

- is incorrectly fitted on the towball
- is overloaded, see the bicycle rack's instructions for maximum load weight
- is used for carrying something other than bicycles.

The car's driving characteristics are affected when a bicycle rack is fitted on the towbar. For example due to:

- increased weight
- reduced acceleration capacity
- reduced ground clearance
- changed braking capacity.

Recommendations for loading bicycles on the bicycle rack

The larger the distance between the load's centre of gravity and the towball, the greater the load on the towbar.

Load according to the following recommendations:

- Fit the heaviest bicycle furthest in, closest to the car.
- Keep the load symmetrical and as close to the centre of the car as possible e.g. by loading the bicycles facing alternately if several bicycles are loaded.
- Remove loose objects from the bicycle for transportation, e.g. bicycle basket, battery, child seat. Partly to reduce the load on the towbar and bicycle rack, and partly to reduce the wind resistance, which affects fuel consumption.
- Do not use protective covers on the bicycles. This may affect manoeuvrability, impair visibility and increase fuel consumption. It may also lead to an increased load on the towbar.

* Option/accessory.

17.1.10. Driving with a trailer

When driving with a trailer, there are a number of points that are important to think about regarding the towbar, the trailer and how the load is positioned in the trailer.

Payload depends on the car's kerb weight. The total of the weight of the passengers and all accessories, e.g. towbar, reduces the car's payload by a corresponding weight.

The car is supplied with the necessary equipment for towing a trailer.

- The car's towbar must be of an approved type.
- Distribute the load on the trailer so that the weight on the towbar complies with the specified maximum towball load. Towball load is calculated as part of the car's payload.
- Increase the tyre pressure to the recommended pressure for a full load.
- The engine is loaded more heavily than usual when driving with a trailer.
- Do not tow a heavy trailer when the car is brand new. Wait until it has been driven at least 1000 km (620 miles).
- The brakes are loaded much more than usual on long and steep downhill slopes. Downshift to a lower gear when shifting manually and adjust your speed.
- Follow the regulations in force for the permitted speeds and weights.
- Maintain a low speed when driving with a trailer up long, steep ascents.
- The maximum indicated trailer weight only applies to heights up to 1000 metres above sea level (3280 ft). At higher elevations, the engine output and the vehicle's climbing ability are reduced due to the reduced air density, and the maximum trailer load must therefore be reduced. The weight of the car and trailer must be decreased by 10% for each additional 1000 m (3280 ft) or part thereof.
- Avoid driving with a trailer on inclines of more than 12%.

 **Important**

When driving with a trailer in a car with air suspension*, use the **Suspension Control** → **Dynamic** setting in Individual drive mode.

 **Note**

Extreme weather conditions, driving with a trailer or driving at high altitudes, in combination with poorer fuel quality than recommended, are factors that considerably increase the car's fuel consumption.

Trailer weights

 **Warning**

Follow the stated recommendations for trailer weights. Otherwise, the car and trailer may be difficult to control in the event of sudden movement and braking.

 **Note**

The stated maximum permitted trailer weights are those permitted by Volvo. National vehicle regulations can further limit trailer weights and speeds. Towbars can be certified for higher towing weights than the car can actually tow.

Level control*

The content of this manual represents the status of the user manual at the time of printing and may not be completely valid in future instances. For more information, refer to the first page for the complete disclaimer note.

The car's system for level control endeavours to maintain a constant height regardless of load (up to the maximum permissible weight). When the car is stationary the rear of the car lowers slightly, which is normal.

When driving in hilly terrain

Under certain circumstances, there may be a risk of overheating when towing a trailer. If the engine and drive system overheats, a warning symbol comes on in the driver display and a message is displayed.

The automatic gearbox adapts the gears depending on load and engine speed.

Steep inclines

Do not lock the automatic gearbox in a higher gear than the engine "can cope with" - it is not always a good idea to drive at a high gear with low engine speed.

Parking on a hill

- 1 Depress the brake pedal fully.
- 2 Activate the parking brake.
- 3 Select gear position P.
- 4 Release the brake pedal.

Block the wheels with chocks when parking a car with hitched trailer on a hill.

Starting on a hill

- 1 Depress the brake pedal fully.
- 2 Select gear position D.
- 3 Releasing the parking brake.
- 4 Release the brake pedal and start driving off.

* Option/accessory.

17.2. Cargo area

17.2.1. Safety net, safety grille and cargo cover

17.2.1.1. Operating cargo cover*

There are two extended positions for the cargo cover - a full-cover position and a loading position, where it is partially extended to make it easier to reach further into the cargo area.

Full-cover position

For 7-seat car



Hang up the locking tabs of the seatbelts for the third seat row on the designated hooks in the side panels.

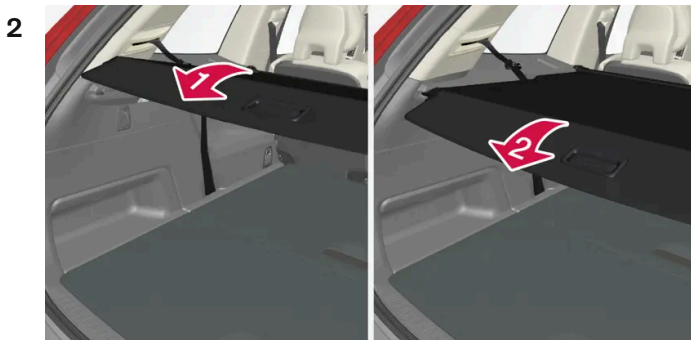

1

Grip the handle and pull out the cargo cover so that it slides over the side panels in the cargo area. Pull to the end position.

3 2

When the cargo cover is extended so that it covers the cargo area - guide the cover's attachment pins into the grooves in the side panels and release, while at the same time angling the handle with a light downward pressure.

> The cargo cover is locked in the full-cover position.

For 5-seat car

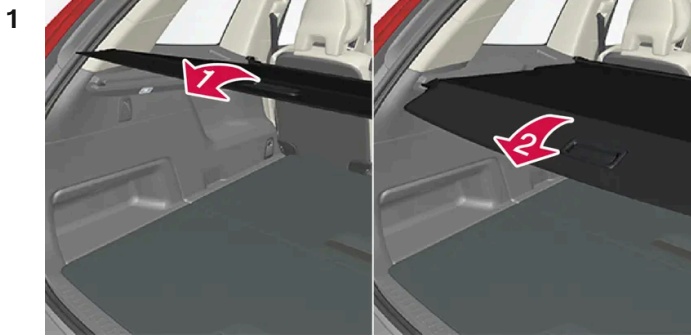

Grip the handle and pull out the cargo cover so that it slides over the side panels in the cargo area. Pull to the end position.



When the cargo cover is extended so that it covers the cargo area - guide the cover's attachment pins into the grooves in the side panels and release, while at the same time angling the handle with a light downward pressure.

➤ The cargo cover is locked in the full-cover position.

! Important

Do not load objects on top of the cargo cover.

! Warning

In a 7-seat car, never have the cargo cover fitted when there are passengers in the rear seats. This may lead to serious injury in the event of a collision.

Loading mode

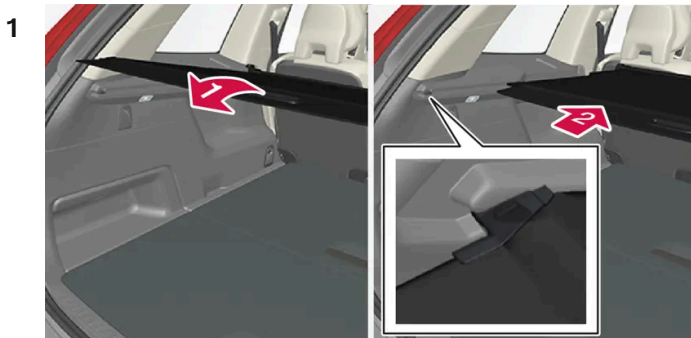

The content of this manual represents the status of the user manual at the time of printing and may not be completely valid in future instances. For more information, refer to the first page for the complete disclaimer note.

From retracted position - grip the handle and pull out the cover so it slides over the side panels in the cargo area - pull to the end position and guide the cargo cover's attachment pins into the grooves in the side panels. (If the cover is already in the full-cover position - see the next point)

2 

From full-cover position - grip the handle and guide the cargo cover's attachment pins into the grooves in the side panels and release.

> Retract the cover until it stops in the loading position.

In the event that your hands are occupied:

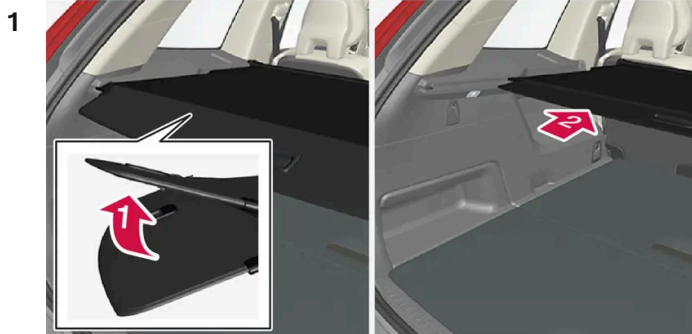

1 

In the extended full-cover position - lightly push the handle part of the cargo cover upward, e.g. with an elbow.

> **2**  The cover retracts until it stops in the loading position.

To return to full-cover position from loading position:

- 1** Grip the handle and pull the cargo cover out to the end position.
 - 2** Release slightly and angle the handle by means of a light downward pressure.
- > The cover is locked in the full-cover position.

Retracting

- 1** From the full-cover position:

Lift up the handle and pull it backward to disengage the cargo cover's attachment pins and then release.

From loading position:

Grip the handle and pull out the cargo cover in the grooves - pull to the full-cover position. Lift up the handle and pull it backward to disengage the attachment pins and then release.

- 2 Retract the cover with its attachment pins outside of the side panels until it stops in the retracted position.

* Option/accessory.

17.2.1.2. Fitting and removing cargo cover*

In the extended position, the cargo cover prevents visual access to the cargo area.

Fitting cargo cover



- 1 **1** → Insert one of the cargo cover's end pieces in the recess in the side panel in the cargo area.
 - 2 **2** → Then insert the other end piece in the recess in the side panel on the opposite side.
 - 3 **3** → Press down the end pieces on both sides - one by one.
- When a "click" is heard and the red marking on each end piece has disappeared, the cargo cover is attached - check that it is affixed securely.

Removing cargo cover

In retracted position:

- 1 Depress the button on one of the retracted cargo cover's end pieces and lift out that end.
In a 7-seat car - release the third seat row's seatbelt locking tabs from the hooks above the side panels.
- 2 Angle the cover up/out carefully.
 - The other end piece loosens automatically and the cover can be lifted out of the cargo area.

* Option/accessory.

17.2.1.3. Fitting and removing safety grilles *

The safety grille prevents loads or pets in the cargo area from being thrown forward in the passenger compartment under heavy braking.

The safety grille is crash-tested in accordance with the ECE R17 legal requirement and fulfils Volvo's strength requirements.



For safety reasons, the safety grille must always be attached and anchored correctly.

 **Warning**

Under no circumstances may anybody remain in the cargo area while the car is moving. This is to avoid injury in the event of heavy braking or an accident.

The safety grille's parts consist of the grille and two loose attaching braces. The attaching braces each come with a screw cap and there are two plastic sleeves for the safety grille.

 **Warning**

The safety grille must only be used in the rear position described here. The roof mountings behind the front seats are not intended for the safety grille.

 **Warning**

For safety reasons, the third seat row^[1] must be lowered when the safety grille is fitted in the car.

 **Important**

It is not possible to have the protective grille fitted at the same time as the cargo cover.

Installation

- 1 Lower the rear seat and then lift the safety grille in through one of the rear side doors or via the tailgate - the arched/convex side of the grille should face the cargo area while the hooks on each side point up. The attaching braces and plastic sleeves are not used in this stage.

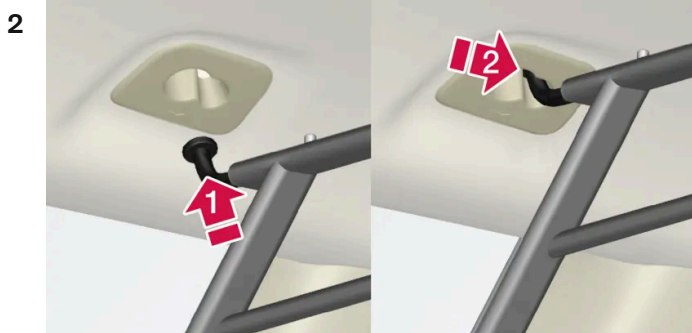

Guide one of the safety grille's hooks into the larger opening in the roof mounting (1).

Grasp the grille near the hook and pull/slide it towards the smaller opening (2).

> The hook is now secured in the roof mounting's end position.

- 3 Repeat the steps in point 2 above to secure the other hook in the mounting on the other side.

 **Warning**

Make sure the hooks of the safety grille are securely fitted in the roof mountings so there is no risk of the grille coming loose.

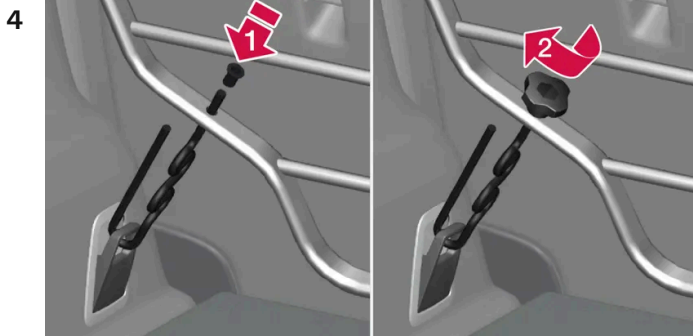

Hook the attaching brace's hook through the load securing eyelet at the cargo floor from underneath, and guide the threaded part through the cargo grille's lower attachment hole from underneath (1).

Slide a plastic sleeve on the threaded part of the attaching brace - the sleeve flange should face up - and guide it down through the hole. Then screw on the screw cap until its lower edge is approx. 5 mm from the grille (2).

- 5 Repeat the steps in point 4 on the other side.
- 6 Centre the safety grille and then tighten the two attaching braces alternately until the grille is properly secured.

Removal

Remove the safety grille by performing the above steps in reverse order.

Note that the attaching braces can be removed before the plastic sleeves are removed from the holes in the grille.

* Option/accessory.

[1] Applies to 7-seat cars.

17.2.1.4. Fitting and removing the safety net*

The safety net prevents loads from being thrown forward in the passenger compartment in the event of sudden braking.

The safety net is fitted into four mounting points.



For reasons of safety, the safety net must always be fastened and anchored as described below.

The net is made of a strong nylon fabric and can be secured two different locations in the car:

- Rear fitting - behind second seat row.
- Front fitting - behind the front seats.

 **Warning**

Loads in the luggage compartment must be anchored well, and also using a correctly fitted safety net.

Fitting the safety net

 **Warning**

It is necessary to ensure that the upper securing points of the safety net are fitted correctly and that the puller-straps are hooked in properly.

Damaged safety nets must not be used.

 **Note**

With forward mounting, the safety net is most easily mounted via the rear doors.

- 1 Unfold the safety net and make sure that the split upper rod in the net is locked in its extended position.
- 2 Hook one retaining hook of the net into the front or rear roof mounting with the anchoring strap locks turned towards you.
- 3 Hook the net's second attachment hook to the roof bracket on the opposite side.

The telescopically sprung attachment hooks make it easier to fit.

The content of this manual represents the status of the user manual at the time of printing and may not be completely valid in future instances. For more information, refer to the first page for the complete disclaimer note.

Take care to press forward the net's retaining hooks for each respective roof mounting's front end position.

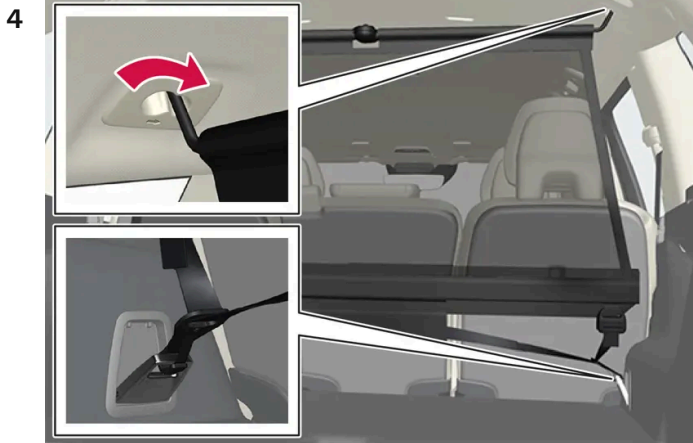

Rear fitting.

For rear fitting:

With the net fitted in the rear roof mountings, hook the safety net's puller-straps into the front load retaining eyelets in the cargo area.



Front fitting.

For front fitting:

With the net fitted in the front roof mountings, hook the puller-straps into the outer eyes on the rear of all seat slide rails. The procedure is facilitated if the backrests are straightened and the seats are moved forward slightly.

Pay attention to make sure that you do not exert hard pressure on the net when the seat and backrest are moved back again. Only adjust until the seat or backrest makes contact with the net.

! Important

If a seat or backrest is pushed backwards hard into the safety net, the net and roof mounts may be damaged.

5 Tension the safety net with the anchoring straps.

Removing the safety net

The safety net can be easily removed and folded up.

- 1** Reduce safety net tension by pressing the button in the anchoring strap lock and feeding out a little of the anchoring strap on each side.
- 2** Press in the catches and detach both of the anchoring strap's hooks.
- 3** Undo the upper attachments and release the net from the roof mountings.
- 4** Press the red button on the rod to enable folding and then roll up the net. Store the net in its case.

* Option/accessory.

17.2.2. Cargo area

The car has a flexible cargo area that makes it possible to transport and secure large objects.

By folding down the backrests in the second and third* rows of seats, the cargo area becomes quite spacious. To facilitate loading and unloading, the rear section of the car can be lowered with the level control function*. Use load retaining eyelets or bag holders to secure the load, and the extendable cargo cover* to conceal the load if desired.

If the car is equipped with a spare wheel then this is attached on the cargo area floor. The car's towing eye and puncture repair kit are stored under the cargo area floor.

* Option/accessory.

17.2.3. Bag hooks

Bag hooks keep carrier bags in place and prevent them from overturning and spreading their contents across the cargo area.

Along the sides



There are two extensible bag hooks in the side panels - one on each side of the cargo area.

Important

The bag hooks may be loaded with a maximum of 5 kg (11 lbs).

17.2.4. First aid kit *

The first aid kit contains first aid equipment.

Store the first aid kit behind the elastic strap, if the car is equipped with one of these.



* Option/accessory.

17.2.5. Load retaining eyelets

Use the load retaining eyelets to attach straps in order to anchor items in the cargo area.

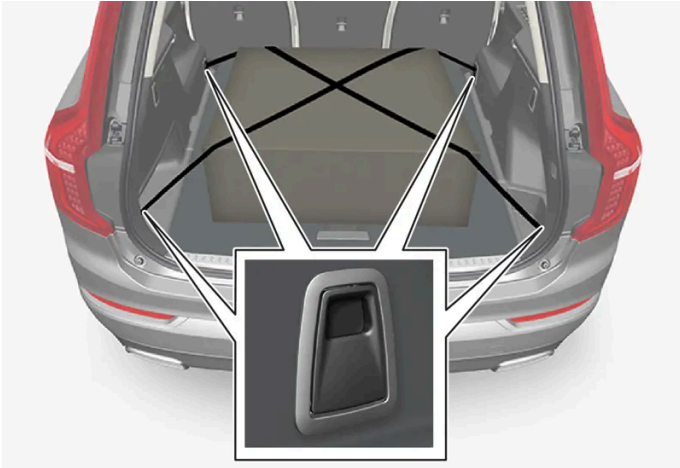

Warning

Hard, sharp and/or heavy objects which protrude may cause injury under violent braking.

Always secure large and heavy objects with a seatbelt or cargo retaining straps.

17.2.6. Warning triangle

Use the warning triangle to warn other road users if the car is stationary in traffic.

Also activate the hazard warning flashers.

Storage spaces

The warning triangle is located in the compartment on the inside of the tailgate.

Folding up the warning triangle

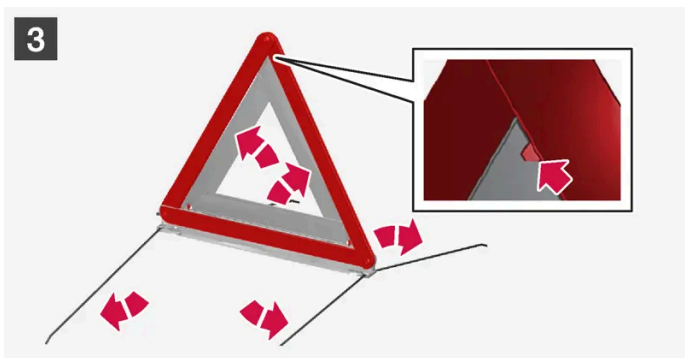
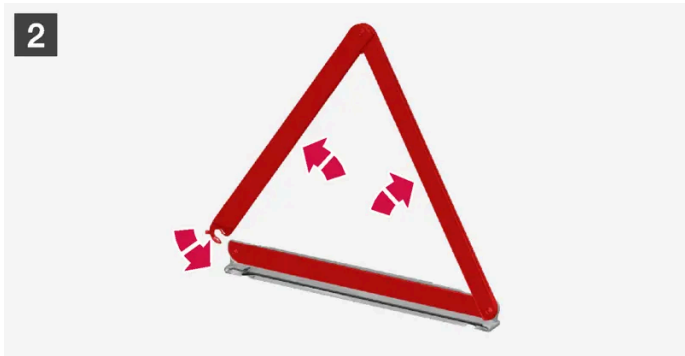
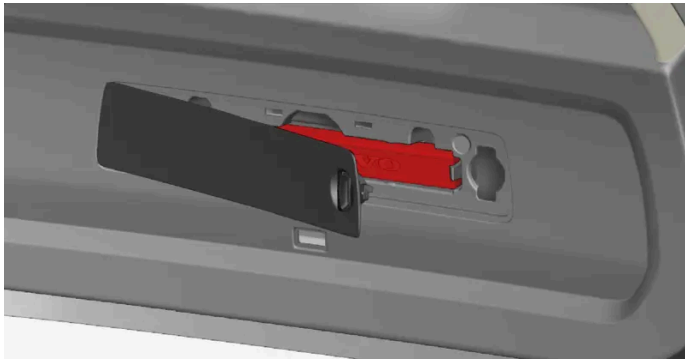

- 1** **1**
Open the hatch by first turning the knob a quarter turn and then pulling the hatch from its brackets in the top and bottom edges.
Press the latch that secures the warning triangle slightly to the right and remove the case.
- 2** **2**
Remove the warning triangle from the case, unfold it and put the ends together.
- 3** **3**
Fold out the warning triangle's support legs.



Follow the regulations for the use of a warning triangle. Position the warning triangle in a suitable place with regard to traffic.

Make sure that the warning triangle and case are properly secured in their storage space and that the hatch is fully closed after use.

17.2.7. Unlocking the tailgate with the remote control key

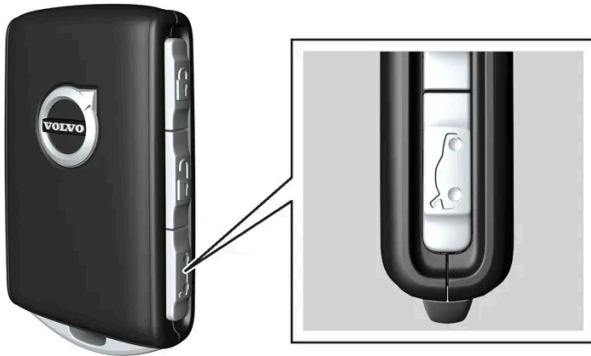
It is possible to unlock just the tailgate by pressing a button on the remote control key.



- 1 Press the remote control key's  button.
 - The tailgate is unlocked but remains closed.
The side doors are still locked and the alarm is armed*. The lock and alarm indicator on the instrument panel extinguishes in order to show that the entire car is not locked.
Lightly grasp the rubberised pressure plate beneath the tailgate handle to open the tailgate. If the tailgate is not opened within 2 minutes then it is relocked and the alarm is re-armed.
- 2 With the power operated tailgate option* -
Long press (approx. 1.5 seconds) on the remote control key's  button
 - The tailgate is unlocked and opened, while the side doors remain locked and their alarm functions armed.

* Option/accessory.

17.2.8. Setting the max. opening for electrically operated tailgate*

Adjust the max opening of the tailgate, e.g. to make it easier if the car is in a garage with limited space.

To adjust max. opening

- 1 Open the tailgate manually - and stop it in the desired opening position.
 - 2 Press and hold * button on the bottom of the tailgate for approx. 3 seconds.
- Two acoustic signals sound to indicate that the set position has been saved.

Note

It is not possible to program an opening position lower than half-open tailgate.

Reset max. opening

- 1 Open the tailgate manually to the fully open position.
 - 2 Press and hold the * button on the underside of the tailgate for approx. 3 seconds.
- Two acoustic signals sound to indicate that the set position has been cleared.

Note

- If the system has been operating continuously for a long time, it is switched off to avoid overload. It can be used again after about 2 minutes.

* Option/accessory.

17.2.9. Operating the tailgate with foot movement*

A function which allows the tailgate to open and close by moving a foot under the rear bumper makes life easier when your hands are full.



If the car is equipped with keyless locking and unlocking* then you can unlock the tailgate with a foot movement.

The function with both opening and closing of the tailgate is also available when the car is equipped with power operated tailgate*.

i Note

The foot-operated tailgate function is available in two versions:

- Opening and closing with foot movement
- Only unlocking with foot movement (lift up the tailgate manually to open it)

Note that the function for opening and closing with foot movement requires power operated tailgate*.



The sensor is located on left of centre in the bumper^[1].

One of the car's remote control keys must be within range behind the car, approx. 1 metre (3 feet), for opening and closing to be possible. This also applies to an already unlocked car in order to avoid accidental opening e.g. in a car wash.

Opening and closing with foot movement



1 Kicking motion within the detector's activation area.

Make **one** forward kicking motion under the left part of the rear bumper. Then take a step back. The bumper must not be touched.

➤ A short acoustic signal sounds when opening or closing is activated - the tailgate is opened/closed.

If several kicking motions take place without an approved remote control key being located behind the car, opening will not be possible until after a certain delay.

Do not leave your foot positioned under the car during the kicking motion. This could cause activation to fail.

Cancelling opening or closing with foot movement

1 Make **one** forward kicking motion while opening or closing is in progress in order to stop the movement of the tailgate.

The remote control key does not have to be in the vicinity of the car to cancel opening or closing of the tailgate.

If the tailgate is stopped close to closed position, the next activation will open the tailgate.

Note

There is a risk of reduced function, or no function, if the rear bumper is loaded with large amounts of ice, snow, dirt or similar. For this reason, make sure you keep it clean.

Note

Pay attention to the possibility that the system may be activated in a car wash or similar if the remote key is within range.

Cars with the skid plate* accessory

If the car is equipped with skid plate the sensor is located out on the left-hand corner of the bumper.



To activate opening or closing with a foot movement on a car equipped with skid plate, the kicking motion is made from the side of the car. One of the car's remote control keys must be within range (approx. 1 metre (3 feet)) for opening and closing to be possible.

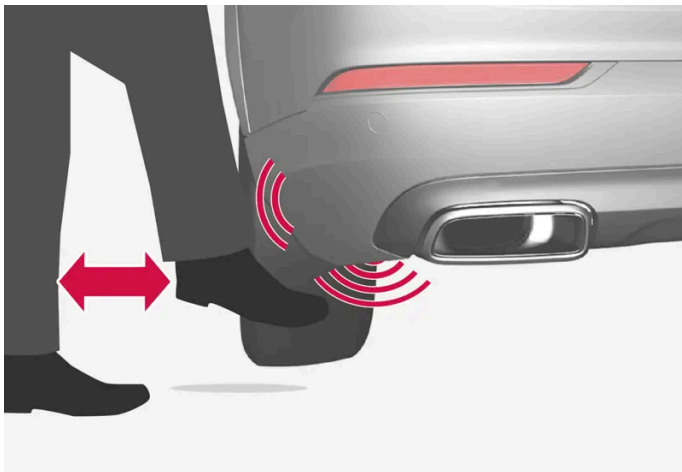

Kicking motion within the detector's valid activation area.

* Option/accessory.

[1] If the car is equipped with skid plate* the sensor is located out on the left-hand corner of the bumper.

17.2.10. Unlocking the tailgate from the inside of the car

The tailgate can be unlocked from inside by pressing the button on the instrument panel.



- 1 Brief press on the  button on the instrument panel.
 - > The tailgate can be unlocked and opened from the outside by grasping the rubberised pressure plate.

With the power operated tailgate option*:

- 1 Long press on the  button on the instrument panel.
 - > The tailgate is opened.

* Option/accessory.

17.2.11. Keyless unlocking of the tailgate *

With keyless locking and unlocking, it is sufficient to press lightly on the rubberized pressure plate on the tailgate handle to unlock.

i Note

One of the car's remote control keys must be within range behind the car for unlocking to work.



The tailgate is held closed by an electrical lock.

To open:

- 1 Press gently on the rubberised pressure plate beneath the tailgate handle.
➤ The lock is released.
- 2 Lift by the outside handle in order to open the tailgate.

! Important

- Minimal force is required to release the rear hatch lock - just gently press the rubberised panel.
- Do not place the lift force on the rubber panel when opening the rear hatch - lift the handle. Using too much force may damage the electrical contacts on the rubber panel.

It is also possible to unlock the tailgate hands-free with a foot movement under the rear bumper, see separate section.

! Warning

Do not drive with an open tailgate! Toxic exhaust fumes could be drawn into the car through the cargo area.

* Option/accessory.

17.2.12. Fuses in cargo area

Fuses in the cargo area protect, amongst other things, power seats*, airbags and seatbelt tensioners.

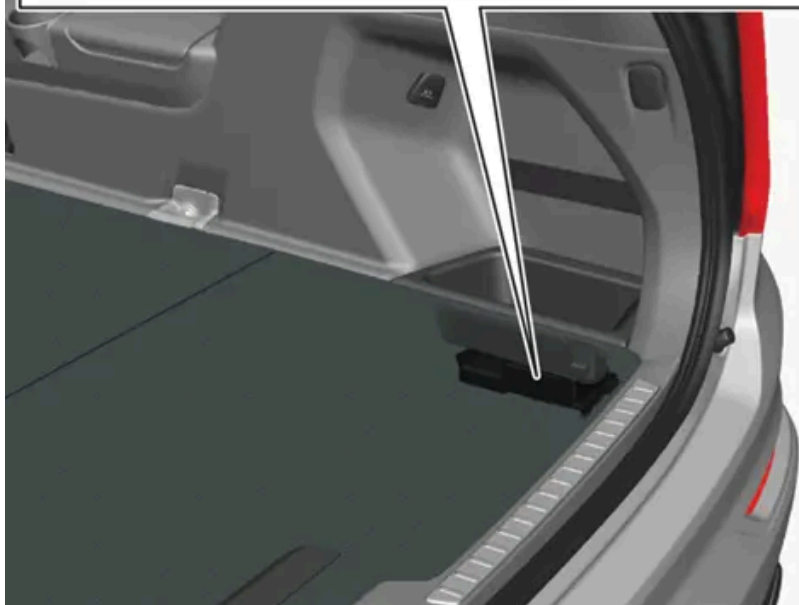
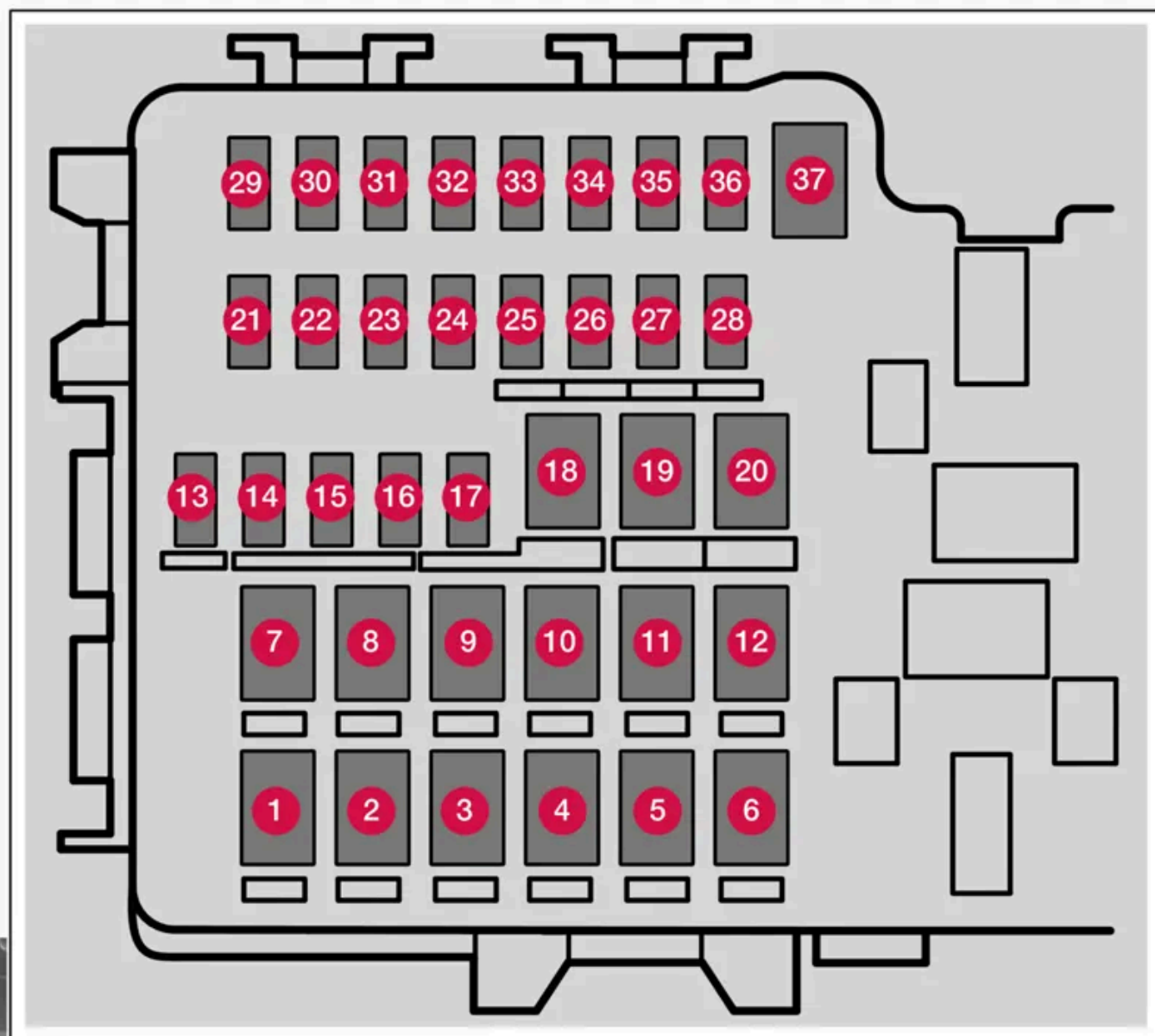

The central electrical unit is located under the storage compartment on the right-hand side.

On the inside of the cover there are tweezers that facilitate the procedure for the removal and fitting of fuses.

The **fuse box in the engine compartment** also provides space for several spare fuses.

Positions

Functions and components in the fuse table cover several models and engine alternatives. An fuse description can therefore apply to fewer or none of the components in the car, depending on how it is equipped.

	Function	Ampere	Type
1	Rear window defroster	30	MCASE ^[1]
2	Central electronic module	40	MCASE ^[1]
3	Compressor, air suspension*	40	MCASE ^[1]
4	Electric additional heater, right rear*	30	MCASE ^[1]
5	–	–	MCASE ^[1]
6	Electric additional heater, left rear*	30	MCASE ^[1]
7	Door module, right rear	20	MCASE ^[1]
8	Control module for reduction of nitrous oxides (only diesel)	30	MCASE ^[1]
	–	–	
9	Power operated tailgate *	25	MCASE ^[1]
10	Door module, right front	20	MCASE ^[1]
11	Towbar control module*	40	MCASE ^[1]
12	Seatbelt pretensioner, right	40	MCASE ^[1]
13	Internal relay coils	5	Micro
14	Control module for reduction of nitrous oxides (diesel)	15	Micro
15	Door module, left rear	20	Micro
16	Alcohol lock *	5	Micro
17	–	–	Micro
18	Towbar control module*	25	MCASE ^[1]
	Accessory module	40	
19	Door module, left front	20	MCASE ^[1]
20	Seatbelt pretensioner, left-hand side	40	MCASE ^[1]
21	Parking camera *	5	Micro
22	–	–	Micro
23	–	–	Micro
24	–	–	Micro
25	Supply when the ignition is switched on	10	Micro
26	–	–	Micro
27	–	–	Micro
28	Seat heating, left rear*	15	Micro
29	–	–	Micro

	Function	Ampere	Type
30	Blind Spot Information (BLIS)*	5	Micro
31	–	–	Micro
32	Seatbelt pretensioner, left	5	Micro
33	Actuator, exhaust system (petrol)	5	Micro
34	–	–	Micro
35	Control module All Wheel Drive (AWD)*	15	Micro
36	Seat heating, right rear*	15	Micro
37	–	–	MCase ^[1]

* Option/accessory.

^[1] This type of fuse should be replaced by a workshop. An authorised Volvo workshop is recommended.

17.3. Storage and passenger compartment

17.3.1. Passenger compartment interior

Overview of the passenger compartment's interior and storage locations.

Front seat

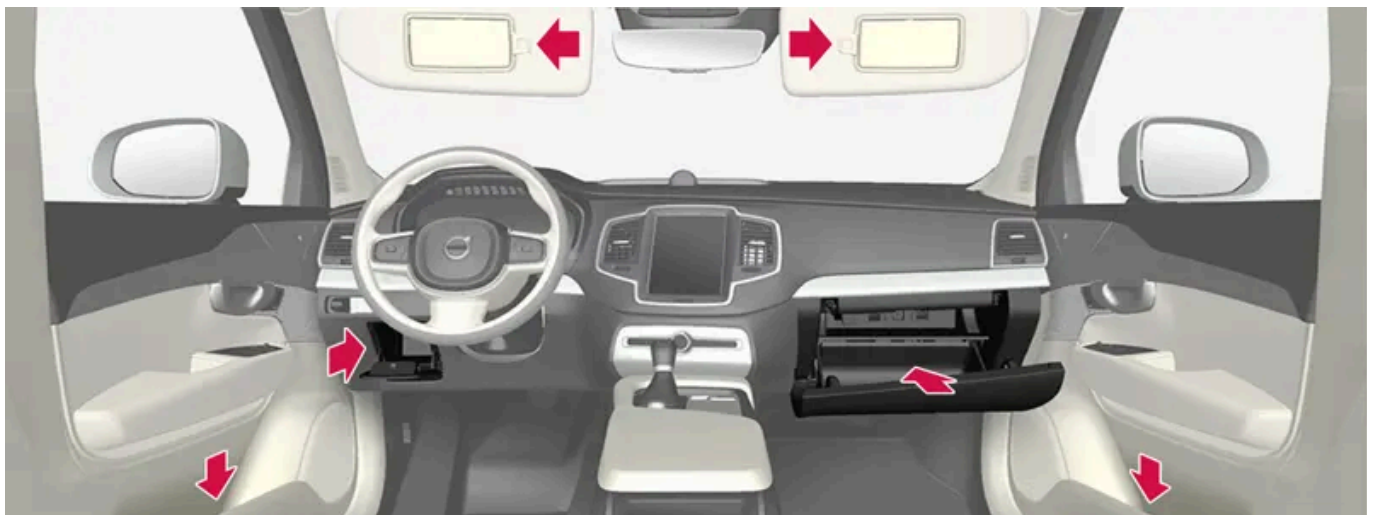

Storage compartment in the door panel and by the steering wheel, glovebox and sun visors.



Storage spaces with cup holder, wireless phone charger*, electrical socket, as well as USB ports in the tunnel console.

Second seat row

In cars with six* seats

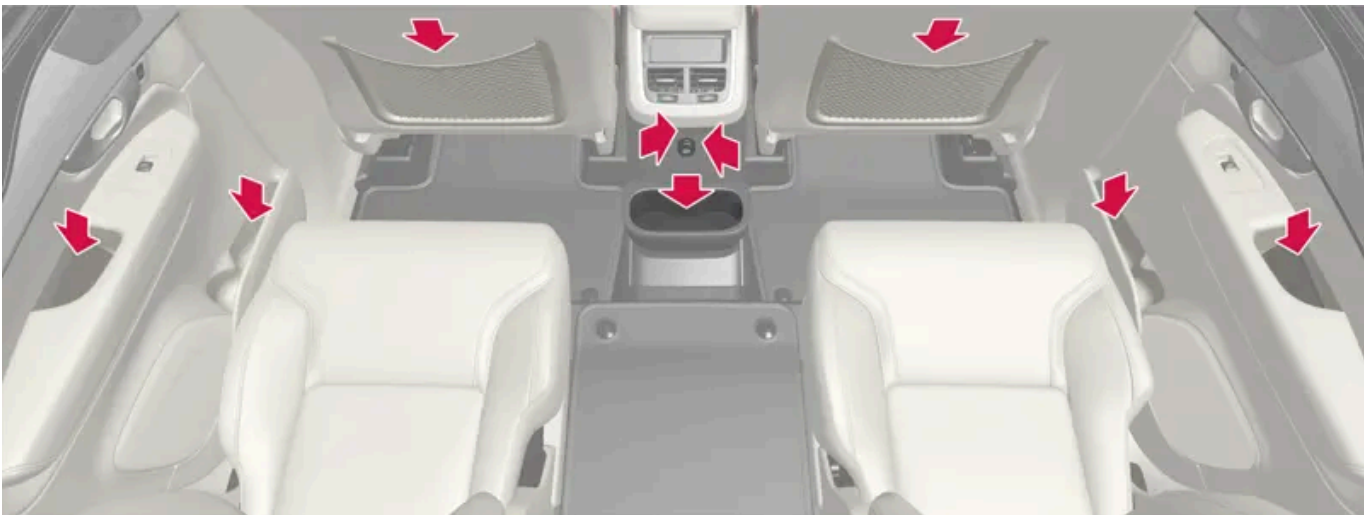

Storage compartment in the door panel, cup holder on the tunnel console's floor, in the centre seat backrest, storage pocket* on the front seat backrest, as well as USB ports in the tunnel console.

In cars with seven* seats

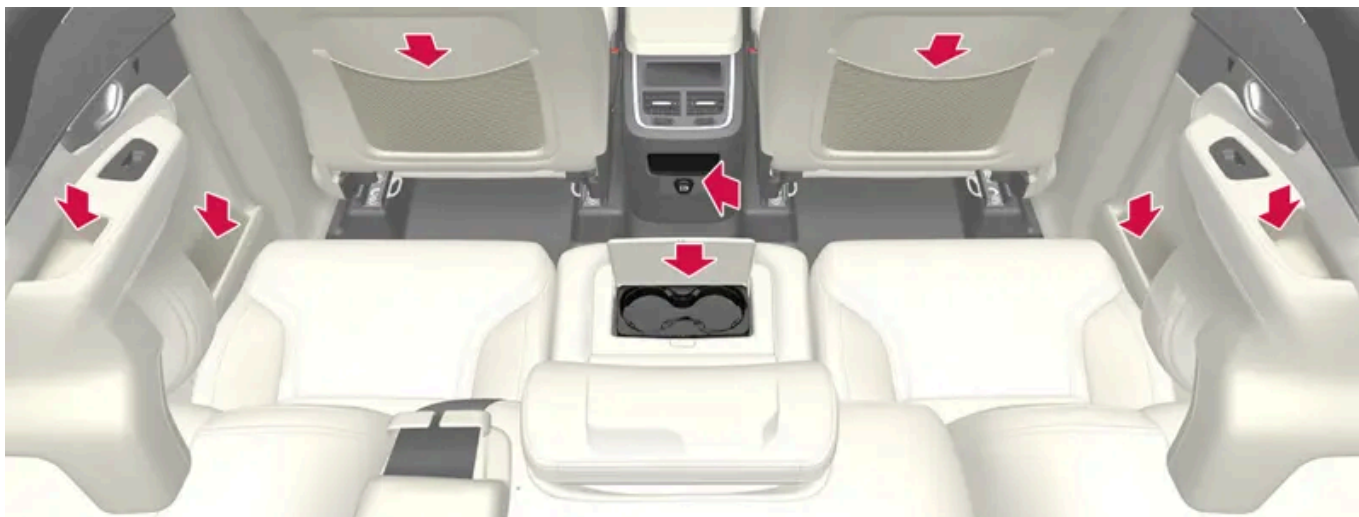

Storage compartment in the door panel, cup holder* in the centre seat backrest, storage pocket* on the front seat backrest, as well as USB ports in the tunnel console.

Third seat row*



Storage compartment and cup holder in the side panel and storage space between the seats.

Warning

Keep loose objects such as phones, cameras, remote controls for accessories, etc. in the glove compartment or other compartments. Otherwise they may injure people in the car in the event of sudden braking or a collision.

Important

Keep in mind that high gloss surfaces, for example, are easily scratched by metal objects. Do not place keys, phones and other items on sensitive surfaces.

* Option/accessory.

17.3.2. Electrical sockets

There is one 12V electrical socket in the tunnel console and one 12V electrical socket* in the luggage compartment/cargo area.

If a problem occurs with an electrical socket, contact a workshop - an authorised Volvo workshop is recommended.

12 V electrical socket

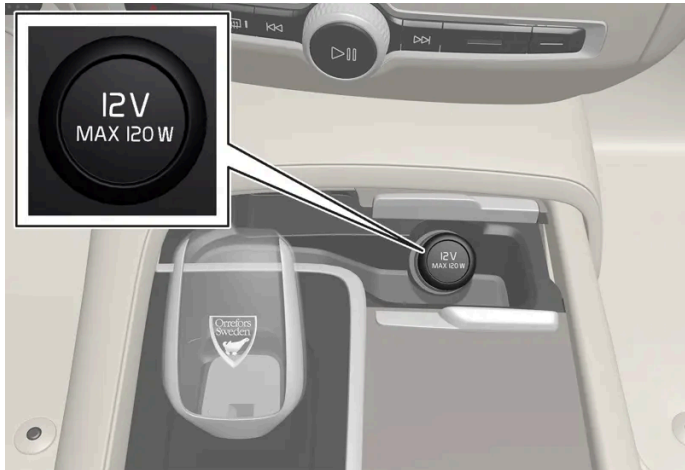

The tunnel console's front electrical socket for cars with wireless phone charger*.



The tunnel console's front electrical socket for cars without wireless phone charger*.

The 12 V sockets can be used for various accessories designed for this, such as music players, cooler boxes and mobile phones.



12 V electrical socket in cargo area*.

* Option/accessory.

17.3.3. Using electrical sockets

12 V sockets can be used for various accessories designed for this, such as music players, cooler boxes and mobile phones.

For the sockets to supply current, the car's electrical system must be set in the lowest ignition position I. The sockets are then active as long as the starter battery level does not become too low.

If the engine is switched off and the car is locked, the sockets are deactivated. If the engine is switched off and the car is not locked, or is locked with double lock temporarily deactivated, then the sockets continue to be active for a further seven minutes.

i Note

Remember that use of the electrical socket with the engine switched off entails a risk of discharging the starter battery, which can limit functionality.

Accessories that are connected to the electrical sockets may be activated even when the car's electrical system is disconnected or if preconditioning is used. For this reason, disconnect the connectors when they are not in use in order to avoid the starter battery being discharged.

Warning

- Do not use accessories with large or heavy connectors - they can damage the socket or come loose when driving.
- Do not use accessories that can cause interference to the car's radio receiver or electrical system for example.
- Position the accessory so that it is not at risk of injuring the driver or passengers in the event of heavy braking or collision.
- Keep an eye on connected accessories as they can generate heat that can burn passengers or the interior.

Using 12 V sockets

- 1 Remove the blanking plug (tunnel console) or fold down the cover (cargo area) in front of the socket and plug in the accessory's connector.
- 2 Unplug the accessory's connector and refit the blanking plug (tunnel console) or fold up the cover (cargo area) when the socket is not in use or if the socket is left unattended.

Important

Maximum socket output is 120 W (10 A) per socket.

17.3.4. Using the glovebox

The glovebox is located on the passenger side. Among other things, the car's printed owner's information can be stored in the glovebox. There is also space for a pen and card holder.



The glovebox is opened by pressing on the opening button in the centre console.

Locking and unlocking the glovebox

The glovebox can be locked, so-called private locking, e.g. when the car is taken in for service, left at a hotel or similar. Private locking also locks the tailgate.

17.3.5. Sun visors

There are sun visors in the roof in front of the driver seat and the front seat passenger seat which can be folded down and angled out to the side when necessary.



The figure is schematic - the design may vary.

The mirror lighting* is switched on automatically when the guard is lifted up.

The mirror frame incorporates a holder for e.g. cards or tickets.

* Option/accessory.

17.3.6. Tunnel console

The tunnel console is located between the front seats.

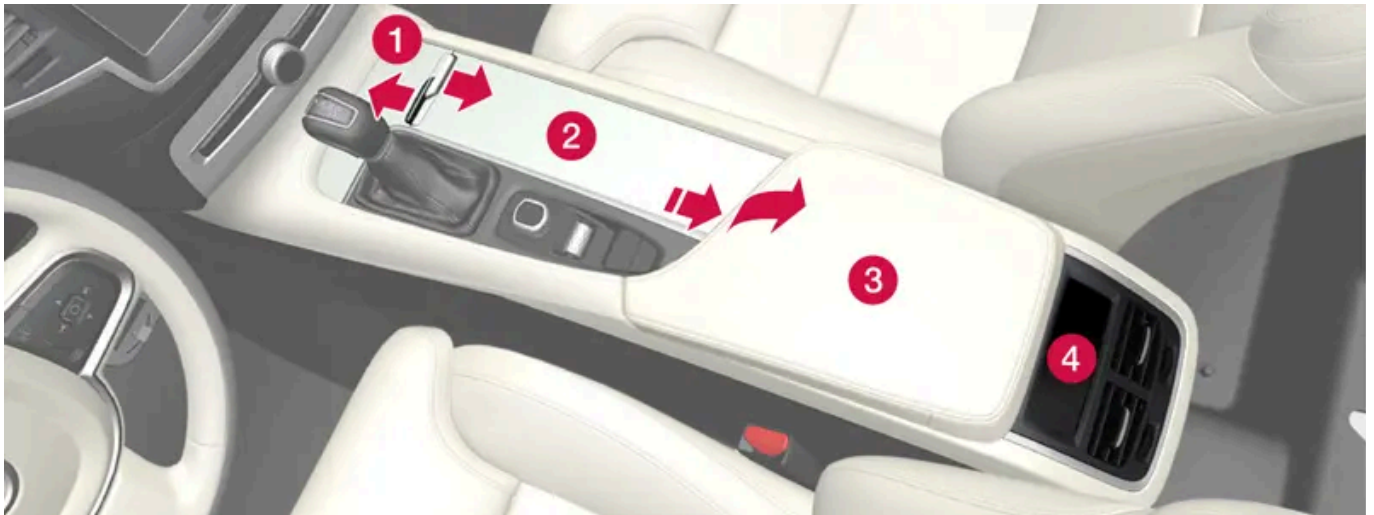

- 1 Storage compartment with hatch* and 12V socket^[1]. The hatch is opened/closed with a push on the handle.
- 2 Storage compartment with cup holder and wireless phone charger*.
- 3 Storage compartment and USB ports under the armrest.
- 4 Climate controls for the rear seat climate functions* or storage compartment. There are also USB ports underneath.

 **Warning**

Keep loose objects such as phones, cameras, remote controls for accessories, etc. in the glove compartment or other compartments. Otherwise they may injure people in the car in the event of sudden braking or a collision.

 **Important**

Keep in mind that high gloss surfaces, for example, are easily scratched by metal objects. Do not place keys, phones and other items on sensitive surfaces.

 **Note**

One of the detectors for the alarm* is located under the tunnel console's cup holder. Avoid leaving coins, keys and other metal objects in the cup holder, since this may trigger the alarm.

 **Note**

The USB ports can be used for charging a phone or tablet, for example. Only the front USB port can be used to play media in the car's audio system.

* Option/accessory.

^[1] If the car does not have wireless phone charger, the 12V socket is in the centre storage compartment.

17.3.7. Fuses under glovebox

Fuses under the glovebox protect, amongst other things, electrical sockets, displays and door modules.

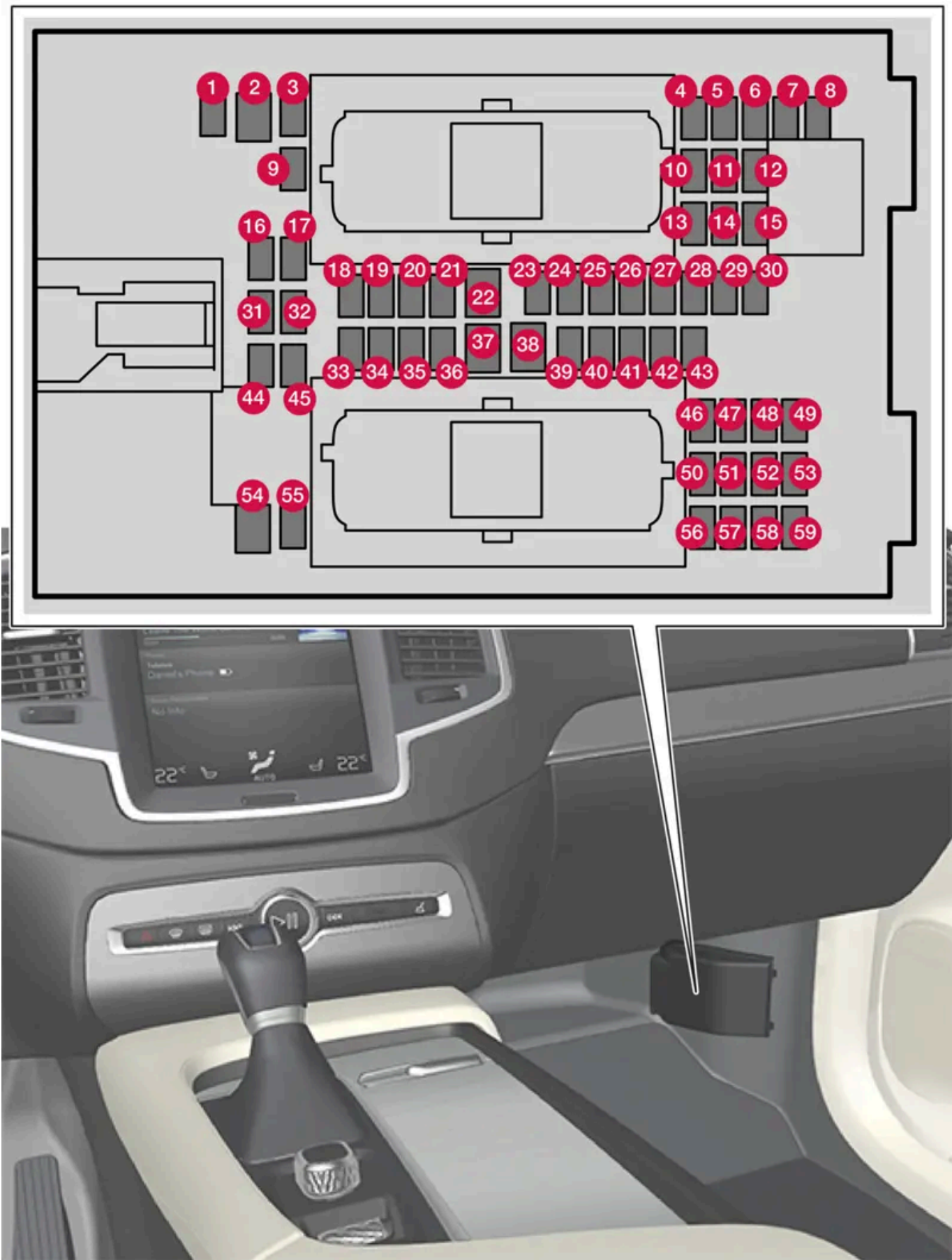

The central electrical unit is located behind the floor mat/side panel.

On the inside of the cover there are tweezers that facilitate the procedure for the removal and fitting of fuses.

The **fuse box in the engine compartment** also provides space for several spare fuses.

Positions

On the inside of the cover is a label that shows the location of the fuses. Functions and components in the fuse table cover several models and engine alternatives. An fuse description can therefore apply to fewer or none of the components in the car, depending on how it is equipped.

	Function	Ampere	Type
1	Control module, 48 V battery ^[1]	10	Micro
2	–	–	MCase ^[2]
3	–	–	Micro
4	Movement detector*	5	Micro
5	–	–	Micro
6	Driver display	5	Micro
7	Keypad, centre console	5	Micro
8	Sun sensor	5	Micro
9	–	–	Micro
10	–	–	Micro
11	Steering wheel module	5	Micro
12	Control module, start knob and parking brake	5	Micro
13	Heated steering wheel*	15	Micro
14	–	–	Micro
15	–	–	Micro
16	–	–	Micro
17	–	–	Micro
18	Control module, climate control	10	Micro
19	Steering lock	7,5	Micro
20	Diagnostic port	10	Micro
21	Centre display	5	Micro
22	Fan module, climate control, front	40	MCase ^[2]
23	USB hub	5	Micro
24	Controls lighting Passenger compartment lighting Dimming, interior rearview mirror* Rain and light sensors* Power front seats* Control panels, rear doors Fan module, climate control Keypad, tunnel console at legroom second row of seats*	7,5	Micro
25	Control module, driver support functions	5	Micro
26	Roof console	20	Micro
27	Head-up display*	5	Micro
28	Passenger compartment lighting	5	Micro

	Function	Ampere	Type
29	Wireless charging plate	5	Micro
30	Display roof console	5	Micro
31	–	–	Micro
32	–	–	Micro
33	–	–	Micro
34	–	–	Micro
35	Control module, online car Control module Volvo On Call	5	Micro
36	–	–	Micro
37	Audio control device (amplifier)	40	MCase ^[2]
38	Fan module, climate control, rear*	40	MCase ^[2]
39	Multi-band antenna	5	Micro
40	Control module, seat comfort, front*	5	Micro
41	Alcohol lock*	5	Micro
42	Rear window wiper	15	Micro
43	Control module, fuel pump	15	Micro
44	Relay coil, transmission oil pump	5	Micro
45	Opening the boot lid/tailgate with foot motion*	–	Micro
46	Seat heating, driver's side front	15	Micro
47	Seat heating, passenger side front	15	Micro
48	Coolant pump	7,5	Micro
49	–	–	Micro
50	Power driver's seat*	20	Micro
51	Module, active damping*	20	Micro
52	–	5	Micro
53	Infotainment module	10	Micro
54	–	–	MCase ^[2]
55	–	–	Micro
56	Electrically operated front passenger seat*	20	Micro
57	–	–	Micro
58	TV* (certain markets)	5	Micro
59	Primary fuse for fuses 52, 53, 57 and 58	15	Micro

^[1] Only applies to cars of the mild hybrid type.

^[2] This type of fuse should be replaced by a workshop. An authorised Volvo workshop is recommended.

* Option/accessory.

18. Maintenance and service

18.1. Car care

18.1.1. Interior cleaning

18.1.1.1. Cleaning the centre display

Dirt, stains and grease from fingers can affect the centre display's performance and readability. Clean the screen frequently with a microfibre cloth.



- 1 Turn off the centre display with a long press on the home button.
- 2 Wipe the screen with a clean and dry microfibre cloth using small circular movements. If necessary, lightly moisten the microfibre cloth with clean water.
- 3 Activate the display with a short press on the home button.

 **Important**

The microfibre cloth used to clean the centre display must be free from sand and dirt.

 **Important**

When cleaning the centre display, only use gentle pressure on the screen. Heavy pressure can damage the screen.

 **Important**

Do not spray any liquid or caustic chemicals directly on the centre display. Do not use window cleaning agent, other cleaning agents, aerosol spray, solvents, alcohol, ammonia or cleaning agent containing abrasive.

Never use abrasive cloths, paper towels or tissue paper, since they may scratch the centre display.

18.1.1.2. Cleaning the driver display

Gently wipe the display's cover glass with a clean and dry microfibre cloth. If necessary, lightly moisten the microfibre cloth.

Never use cleaning agent. A special cleaning agent available from Volvo dealers can be used for more difficult cleaning.

18.1.1.3. Cleaning the Head-up display*

Gently wipe the display's cover glass with a clean and dry microfibre cloth. If necessary, lightly moisten the microfibre cloth.

Never use strong stain removers. A special cleaning agent available from Volvo dealers can be used for more difficult cleaning.

* Option/accessory.

18.1.1.4. Cleaning the leather steering wheel

Use cleaning agents and car care products recommended by Volvo. Clean regularly, and deal with stains straight away. Vacuuming is important prior to using cleaning agents.

Leather needs to breathe. Never cover the leather steering wheel with protective plastic. We recommend Volvo Leather Care Kit/Wipes for cleaning the leather steering wheel. First remove dirt, dust, etc. with a damp sponge or cloth.

 **Important**

Sharp objects, e.g. rings, can damage the leather on the steering wheel.

18.1.1.5. Cleaning the seatbelts

Use cleaning agents and car care products recommended by Volvo. Clean regularly, and deal with stains straight away. Vacuuming is important prior to using cleaning agents.

Use water and a synthetic detergent. A special textile cleaning agent is available from Volvo retailers. Ensure that the seatbelt is dry before allowing it to retract.

18.1.1.6. Cleaning the interior

Use cleaning agents and car care products recommended by Volvo. Clean regularly, and deal with stains straight away. Vacuuming is important prior to using cleaning agents.

 **Important**

- Certain items of coloured clothing (e.g. dark jeans and suede garments) may stain the upholstery. If this occurs, it is important to clean and treat these parts of the upholstery as soon as possible.
- Never use strong solvents such as washer fluid, pure petrol or white spirit or concentrated alcohol to clean the interior, since this may damage the upholstery as well as other interior materials.
- Never spray the cleaning agent directly onto components that have electrical buttons and controls. Wipe them instead using a moistened cloth containing the cleaning agent.
- Sharp objects and Velcro may damage the fabric upholstery.
- Only use cleaning agents on the type of material for which they were intended.

18.1.1.7. Cleaning textile floor and entrance mats

It is recommended to use a fabric cleaning agent when cleaning mats. Clean regularly, and deal with stains straight away. Vacuuming is important prior to using cleaning agents.

Remove inlaid carpets for separate cleaning of the floor carpet and the inlaid carpets. Each inlay mat is secured with pins.

- 1 Remove the inlay mat by taking hold of the inlay mat at each pin and lifting the mat straight up.
- 2 Use a vacuum cleaner to remove dust and dirt.

 **Note**

The inlay mats must not be swung around without care or hit against objects to remove dirt since this can crack the inlay mats.

- 3 A textile cleaner is recommended for stains on the floor mat, after vacuuming.
- 4 After cleaning, fit the inlay mat in place by pressing it in at each pin.

 **Warning**

Only use one inlaid mat at each seat, and check before setting off that the mat by the driver's seat is firmly affixed and secured in the pins so that it does not get caught adjacent to and under the pedals.

18.1.1.8. Cleaning interior plastic, metal and wood parts

Use cleaning agents and car care products recommended by Volvo. Clean regularly, and deal with stains straight away.

A fibrillated fibre or microfibre cloth, lightly moistened with water, available from Volvo dealers, is recommended for cleaning interior parts and surfaces.

Do not scrape or rub stains. Never use strong stain removers, either.

 **Important**

Do not use solvent that contains alcohol when cleaning the glass for the driver display.

 **Important**

Keep in mind that high gloss surfaces are easily scratched. Clean these surfaces with a clean, dry microfibre cloth using small, circular motions. If needed, dampen the microfibre cloth with a little clean water.

18.1.1.9. Cleaning leather upholstery*

Use cleaning agents and car care products recommended by Volvo. Clean regularly, and deal with stains straight away. Vacuuming is important prior to using cleaning agents.

Volvo's leather upholstery* is treated to preserve its original appearance.

Leather upholstery* is a natural product that changes and acquires a beautiful patina over time. Regular cleaning and treatment are required in order that the properties and colours of the leather shall be preserved. Volvo offers a comprehensive product, Volvo Leather Care Kit/Wipes, for cleaning and treatment of leather upholstery. The protective outer layer of the leather is preserved when this is used according to the instructions.

To achieve results that are as good as possible, Volvo recommends cleaning and application of the protective cream one to four times per year (or more frequently if required). Volvo Leather Care Kit/Wipes is available from Volvo dealers.

Cleaning the leather upholstery

- 1 Apply the leather cleaner to a damp sponge and squeeze until a foam is created.
- 2 Use the sponge on the stain in a circular motion.
- 3 Thoroughly dampen the stain using the sponge, allow the sponge to absorb the stain without scrubbing.
- 4 Wipe the stain with a soft cloth and allow the leather to dry thoroughly.

Protecting the leather upholstery

- 1 Apply a small amount of leather protective agent to a cloth and then apply it to the leather in light circular motions.
 - 2 Allow to dry for about 20 minutes.
- Protecting the leather upholstery makes it more resistant to the stresses from the sun's UV radiation.

* Option/accessory.

18.1.1.10. Cleaning fabric upholstery and headlining

It is recommended to use fabric cleaning agent when cleaning textile fabric and Nubuck textile. Clean if necessary, and treat stains straight away.

 **Important**

Never scrape or rub a stain since this may damage the upholstery.

 **Important**

Never use stain removing agent or strong solvents, they could damage the upholstery.

Cleaning fabric upholstery

1. Start by vacuum cleaning the upholstery.
2. Follow the instructions for the fabric cleaning agent.
3. When cleaning fabric, a spray extraction cleaner is recommended for suction of the washing fluid and subsequent water rinsing.

 **Important**

Some coloured clothing (such as jeans and suede garments) may stain the fabric upholstery. Heavy stains such as oil may be difficult to remove.

 **Important**

Always clean the entire upholstery, even there are only individual stains. This is to avoid water rings.

 **Note**

Do not remove the upholstery for cleaning.

Cleaning the headlining

1. Brush the headlining carefully using a soft brush.
2. Follow the instructions for the fabric cleaning agent.
3. Then use a soft and lint-free cloth to wipe the headlining.

 **Important**

Careless cleaning can damage the headlining.

18.1.2. Exterior cleaning

18.1.2.1. Cleaning the exterior lamps

Dirty lamps have impaired functionality. Clean them regularly, e.g. when refuelling.

Clean the exterior lamps, such as headlamps and rear lamps, with a soft and clean sponge together with mild soap and lukewarm water.

Temporary condensation on the inside of the lens in connection with cleaning is quite normal. All exterior lamps are designed to withstand this. Condensation is normally vented out from the lamp housing after the lamp has been illuminated for a while.

Important

Do not use any strong cleaning agent or chemicals for cleaning the lamps. Such products, e.g. cleaning agents with alcohol content, may cause the lens to crack.

Important

Do not rub with a dry sponge or rag as it may cause electric discharges that damage components in the lamp.

18.1.2.2. Cleaning the wiper blades

The car should be washed as soon as it becomes dirty. The longer the car is left dirty, the more difficult it will be to get it completely clean and there is a risk of scratching the paintwork. Wash the car in a car wash with oil separator. Use car shampoo that is recommended by Volvo.

Asphalt, dust and salt residue on wiper blades, as well as insects, ice etc. on the windscreen, impair the service life of wiper blades.

When cleaning, set the wiper blades in service position.

Note

Wash the wiper blades and windscreen regularly with a lukewarm soap solution or car shampoo. Do not use any strong solvents.

18.1.2.3. Car paintwork

The paintwork consists of several layers and is an important part of the car's rustproofing, and should therefore be checked regularly.

The most common types of paintwork damage are stone chips, scratches, and marks on the edges of wings, doors and bumpers. To avoid the onset of rust, damaged paintwork should be rectified immediately.

18.1.2.4. Colour codes

The decal for the colour code is positioned on the car's right-hand door pillar between the front and rear door and will be visible when the right-hand rear door is opened.

Colour code

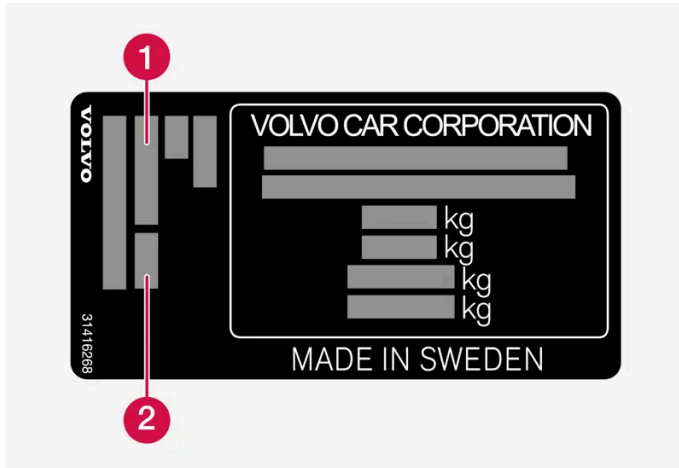

1 Exterior colour code

2 Any secondary exterior colour code

18.1.2.5. Touching up minor paintwork damage

Paint is an important part of the car's rustproofing and should therefore be checked regularly. The most common types of paintwork damage are stone chips, scratches, and marks on e.g. the edges of wings, doors and bumpers.

To avoid the onset of rust, damaged paintwork should be rectified immediately.

Note

When paint is repaired the surface must be clean and dry. The temperature of the surface should be at least 15 °C (59 °F).

Materials that may be needed

- Primer – a special adhesive primer in a spray can is available for e.g. plastic-coated bumpers.
- Basecoat and clearcoat - available in spray cans or as touch-up pens/sticks^[1].
- Masking tape.
- Fine sand paper.

Applying touch-up paint to the damaged surface

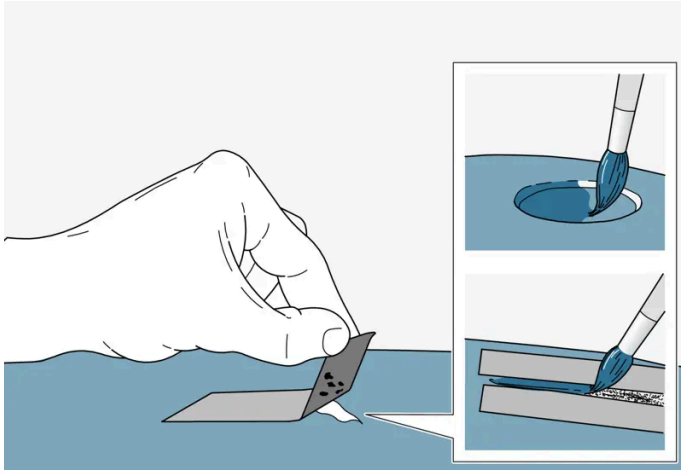

If the damage has not reached down to the metal, the touch-up paint can be applied directly after the surface has been cleaned.

- 1** Apply a piece of masking tape over the damaged surface. Then remove the tape to remove any loose paint.
If the damage is down to the metal, use of a primer is appropriate. In the event of damage to a plastic surface, an adhesive primer should be used to give better results - spray into the lid of the spray can and brush on thinly.
- 2** Before painting, gentle polishing using a very fine polishing agent may be carried out locally if required (e.g. if there are any uneven edges). The surface is thoroughly cleaned (grease and salt should be removed) and left to dry.
- 3** Stir the primer well and apply using a fine brush, a matchstick or similar. Finish off with a basecoat and clearcoat once the primer has dried.

For scratches, implement the same procedure but mask around the damaged area to protect the undamaged paintwork.

Touch-up pens and spray paints for touching up paintwork are available from Volvo dealers.

i Note

If the stone chip has not penetrated down to the metal and an undamaged layer of paint remains in place, fill in with base coat and clear coat as soon as the surface has been cleaned.

^[1] Follow the instructions that are included with the package for the touch-up pen/stick.

18.1.2.6. Cleaning the exterior

The car should be washed as soon as it becomes dirty. This means that the car is easier to clean since the dirt does not attach as firmly. It also reduces the risk of scratches and keeps the car fresh. Perform the cleaning in a car wash with oil separator. Use car care products recommended by Volvo.

18.1.2.7. Rustproofing

The car has protection against corrosion.

Anti-corrosion protection for the body consists of metallic protective coatings on the sheet metal, a high-quality painting process, corrosion-protected and minimised metal overlap, and shielding plastic components, abrasion protection and supplemental rust inhibitor on exposed areas. In the chassis, exposed components of the wheel suspension are made of corrosion-resistant cast aluminium.

Inspection and maintenance

The car's anti-corrosion protection normally requires no maintenance, but a good way to reduce the risk of corrosion is to keep the car clean. Strong alkaline or acidic cleaning solutions must be avoided on glossy trim components. Any stone chips should be rectified as soon as they are discovered.

18.1.2.8. Automatic car wash

It is important to prepare the car if it shall be washed in an automatic car wash. Follow the instructions carefully for how to handle the car before and during washing.

An automatic car wash may be a quick and easy way to clean the car, but will not reach all the parts of the car that need to be cleaned on a regular basis. Volvo recommends supplementing automatic car washing with hand washing.

Note

Avoid washing a brand new car in an automatic car wash during the first few months. This would allow the paintwork to fully harden.

Preparations before washing

In an automatic car wash where the car is pulled through the car wash, it is important to switch off functions that prevent the car from rolling freely.

- Secure or remove protruding exterior parts such as retrofitted auxiliary lamps and antennas.
- Make sure that the automatic rain sensor function is deactivated. The windscreen wipers must be switched off the whole time the car is being washed to avoid the risk of damage.
- Deactivate the automatic braking at standstill function using the button  on the tunnel console.
- Deactivate the automatic activation of parking brake function via settings in the centre display.

During washing

 **Important**

Keep the windows, doors and tailgate closed the whole time the car is being washed.

If the car is equipped with keyless locking and unlocking*:

Take out the key and store it openly in the front part of the car while the car is being washed. This minimises the risk of opening the tailgate unintentionally by pressing a button, or that the key is incorrectly detected outside the car.

- 1 Drive into the car wash and stop at the designated location.
- 2 Select gear position N.
- 3 Set the car in ignition position 0 by turning the start knob in the tunnel console clockwise for several seconds.
 - > The engine is switched off, and at the same time the car can roll freely.
- 4 The car travels through the automatic car wash.
 - Keep the seatbelt fastened the whole time the car is being washed.
 - > Do not forget to restore the adjustments that were made before the car wash.

After washing

Press the brake pedal gently for a short time while driving after the brake linings have been exposed to the wetness. This heats the brakes with friction so that they dry more quickly and reduces the risk of corrosion.

 **Warning**

Always test the foot brake and parking brake after washing the car in order to restore their function.

* Option/accessory.

18.1.2.9. Cleaning exterior plastic, rubber and trim components

The car should be washed as soon as it becomes dirty. The longer the car is left dirty, the more difficult it will be to get it completely clean and there is a risk of scratching the paintwork. Use car shampoo that is recommended by Volvo.

A special cleaning agent available from Volvo dealers is recommended for the cleaning and care of coloured plastic parts, rubber and trim components, e.g. glossy trim mouldings. When using such a cleaning agent the instructions must be followed carefully.

Avoid washing the car with detergent with a pH value below 3.5 or above 11.5. This can cause discolouration of anodised aluminium components*, as illustrated. We advise against use of abrasive polishing agents, as illustrated.



Parts that should be washed using a cleaning agent with a pH value between 3.5 and 11.5.

! Important

Avoid waxing and polishing on plastic and rubber.

When using degreasant on plastic and rubber, only rub with light pressure if it is necessary. Use a soft washing sponge.

Polishing glossy trim mouldings could wear away or damage the glossy surface layer.

Polishing agent that contains abrasive must not be used.

! Important

Avoid washing the car with cleaning agent with a pH value lower than 3.5 or higher than 11.5. This may result in discolouration of anodised aluminium parts such as roof rack and around the side windows.

Never use metal polishing agent on anodised aluminium parts, this can result in discolouration and destroy the surface treatment.

* Option/accessory.

18.1.2.10. Cleaning wheel rims

The car should be washed as soon as it becomes dirty. The longer the car is left dirty, the more difficult it will be to get it completely clean and there is a risk of scratching the paintwork. Perform the cleaning in a car wash with oil separator. Use car shampoo that is recommended by Volvo.

Use rim cleaning agent recommended by Volvo.

Strong rim cleaning agents can damage the surface and cause stains on chrome-plated aluminium rims.

18.1.2.11. Handwashing

The car should be washed as soon as it becomes dirty. This means that the car is easier to clean since the dirt does not attach as firmly. It also reduces the risk of scratches and keeps the car fresh. Carry out cleaning in a cleaning area with an oil separator, and use car shampoo. Use cleaning agents and car care products recommended by Volvo.

Important points to remember when handwashing the car

- Avoid washing the car in direct sunlight. This can cause the detergent or wax to dry and have an abrasive effect.
- Remove bird droppings from the paintwork as soon as possible. They contain substances that damage and discolour paintwork very quickly. For example, use soft paper or sponge soaked in plenty of water. An authorised Volvo workshop is recommended for the removal of any discolouration.
- Wash the underbody, including wheel housings and bumpers.
- Rinse the entire car until the dissolved dirt has been removed so as to reduce the risk of scratches from washing. Do not spray directly onto the locks.
- If necessary, use cold degreasing agent on very dirty surfaces. Note that in this case, the surfaces must not be hot from the sun.
- Wash using a sponge, car shampoo and plenty of lukewarm water. Ensure that the sponge is dirt-free. Dirt on the sponge may cause you to scratch the car during washing.
- Clean the wiper blades with a lukewarm soap solution or car shampoo.
- Dry the car using a clean, soft chamois or a water scraper. If you avoid allowing drops of water to dry in strong sunlight, you reduce the risk of water drying stains which may need to be polished out.
- After the car has been washed, tar from asphalt may remain. Use tar remover that is recommended by Volvo to get rid of the last spots.

 **Warning**

Always have the engine cleaned by a workshop. There is a risk of fire if the engine is hot.

 **Important**

Dirty headlamps have impaired functionality. Clean them regularly, e.g. when refuelling.

Do not use any corrosive cleaning agents but use water and a non-scratching sponge instead. See separate section for more information.

 **Note**

Outside lighting such as headlamps and rear lamps may temporarily have condensation on the inside of the lens. This is normal, all exterior lighting is designed to withstand this. Condensation is normally vented out of the lamp housing when the lamp has been switched on for a time.

 **Important**

- Make sure that the panoramic roof* and sun visor are closed before washing the car.
- Never use polishing agent with abrasive properties on the panoramic roof.
- Never use wax on the rubber mouldings around the panoramic roof.

 **Important**

Remember to remove dirt from the drain holes in the doors and in the sills after washing the car.

* Option/accessory.

18.1.2.12. High-pressure washing

The car should be washed as soon as it becomes dirty. The longer the car is left dirty, the more difficult it will be to get it completely clean and there is a risk of scratching the paintwork. Wash the car in a car wash with oil separator. Use car shampoo that is recommended by Volvo.

When using high-pressure washing, use sweeping movements and make sure that the nozzle does not come closer than 30 cm (13 in.) to the surface of the car. Do not spray directly onto the locks.

 **Important**

Do not rinse water hotter than 60 °C onto the exterior lamps, such as headlamps and rear lamps. See separate section for more information.

18.1.2.13. Polishing and waxing

Polish and wax the car if the paintwork is dull or to give the paintwork extra protection. The car does not need to be polished until it is at least one year old. However, the car can be waxed during this time. Do not polish or wax the car in direct sunlight, the surface being polished should be a maximum of 45 °C (113 °F).

- Wash and dry the car thoroughly before you begin polishing or waxing. Clean off asphalt and tar stains using tar remover or white spirit. More stubborn stains can be removed using fine rubbing paste designed for car paintwork. Use cleaning agent recommended by Volvo.
- Polish first with a polish and then wax with liquid or solid wax. Follow the instructions on the packaging carefully. Many preparations contain both polish and wax.

 **Important**

Never polish or wax any matt details on the car. This can destroy the matt effect and give the surface a permanent shine.

 **Important**

Avoid waxing and polishing on plastic and rubber.

When using degreasant on plastic and rubber, only rub with light pressure if it is necessary. Use a soft washing sponge.

Polishing glossy trim mouldings could wear away or damage the glossy surface layer.

Polishing agent that contains abrasive must not be used.

 **Important**

Use cleaning agent recommended by Volvo. Other treatment such as preserving, sealing, protection, lustre sealing or similar could damage the paintwork. Paintwork damage caused by such treatments is not covered by Volvo warranty.

18.2. Wiper blades and washer fluid

18.2.1. Wiper blades and washer fluid

Together with the washer fluid, the wipers aim to improve visibility as well as headlamp pattern.

The washer nozzles are heated* automatically in cold weather to prevent the washer fluid from freezing.

Information indicating that the washer fluid needs topping up appears in the driver display when there is approx. 1 litre (1 qt) of washer fluid remaining.

* Option/accessory.

18.2.2. Setting the wiper blades in service position

In some situations, the windscreen's wiper blades must be set in service position (vertical position), e.g. when they shall be replaced.



Wiper blades in service position.

In order to change, clean or lift the wiper blades (e.g. for scraping off ice from the windscreen) they must be in service position.

 **Important**

Before placing the wiper blades in the service position, make sure that they are not frozen down.

Activating/deactivating service mode

Service mode can be activated/deactivated when the car is stationary and the windscreen wipers are not on. Service mode is activated/deactivated via the function view in the centre display:



Press the **Wiper Service Position** button. The light indicator in the button illuminates when service mode is activated. When activated, the wipers move to the service position. To deactivate the service mode, press **Wiper Service Position** again. The light indicator in the button extinguishes when service mode is deactivated.

The wiper blades also exit the service position if:

- Windscreen wiping is activated.
- Windscreen washing is activated.
- The rain sensor is activated.
- The car is driven away.

 **Important**

If the wiper arms in service position have been folded up from the windscreen, they must be folded back down onto the windscreen before the activation of wiping, washing or the rain sensor, as well as before driving. This is to avoid scraping the paint on the bonnet.

18.2.3. Topping up washer fluid

Washer fluid is used for cleaning the headlamps as well as the windscreen and rear window. Washer fluid with antifreeze must be used when the temperature is under the freezing point.

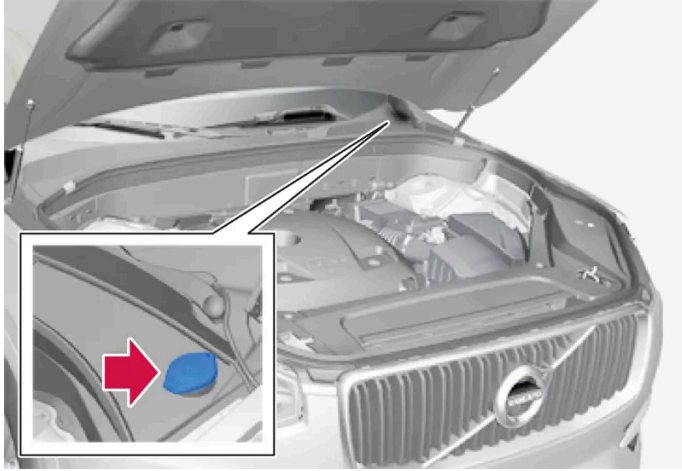

Washer fluid is filled into the reservoir with the blue cap. The reservoir is used for windscreen washer, rear window washer and headlamp washers*.

Note

When approx. 1 litre (1 qt) of washer fluid remains in the reservoir, the message **Washer fluid Level low, refill** is shown in the driver display, together with the  symbol.

Prescribed grade: Washer fluid recommended by Volvo – with frost protection during cold weather and for temperatures below freezing point.

Important

Use Volvo genuine washer fluid or equivalent with a recommended pH of between 6 and 8, in working dilution (e.g. 1:1 with neutral water).

Important

Use washer fluid with antifreeze when the temperature is below freezing to avoid the fluid freezing inside the pump, reservoir and hoses.

Volume:

- Cars **with** headlamp washing: 5.5 litres (5.8 qts).
- Cars **without** headlamp washing: 3.5 litres (3.7 qts).

* Option/accessory.

18.2.4. Replacing the wiper blade, rear window

The wiper blades sweep water away from the windscreen and rear window. Together with washer fluid, they aim to clean the windows and ensure visibility while driving. Windscreen and rear window wiper blades can be replaced.

Replacing the wiper blade, rear window

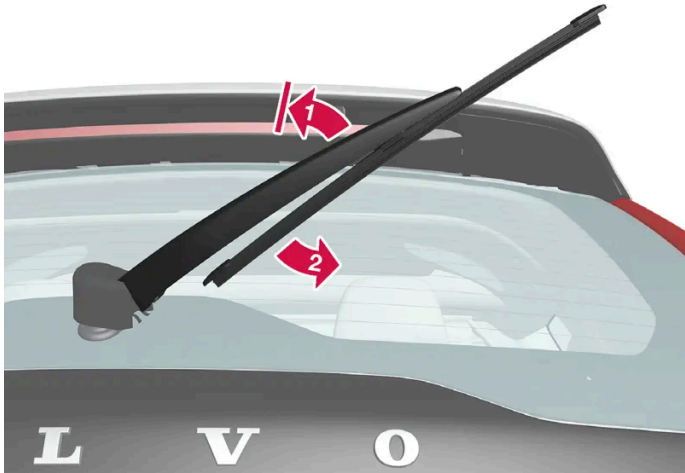

Lift the wiper arm from the window and pull the lower section of the blade to the right.

- 1**  Grip the centre of the wiper arm and lift it from the windscreen to lock position.

 **Note**

There is a lock position at half extension angle that may feel like resistance. This lock prevents the arm from falling back against the windscreen. The wiper arm must be pulled past the lock for wiper blade replacement.

- 2**  Grip the lower part of the blade and pull to the right until the blade loosens from the arm.
- 3** Press the new wiper blade into place. You should be able to hear a click. Check that it is firmly installed.
- 4** Lower the wiper arm.

 **Important**

Check the blades regularly. Neglected maintenance shortens the service life of the wiper blades.

18.2.5. Replacing windscreen wiper blades

The wiper blades sweep water away from the windscreen and rear window. Together with washer fluid, they aim to clean the windows and ensure visibility while driving. Windscreen and rear window wiper blades can be replaced.

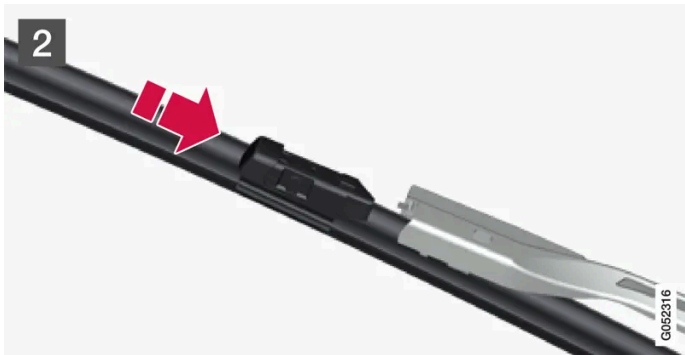
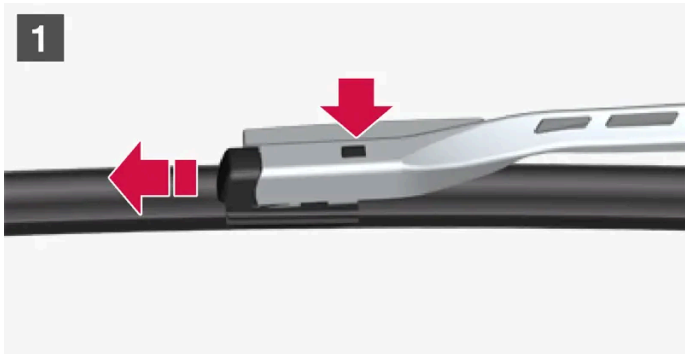

- 1** **1**
Fold up the wiper arm when it is in service position. Service position is activated/deactivated via the function view in the centre display when the car is stationary and the windscreen wipers are not on. Press the button located on the wiper blade mounting and pull straight out parallel with the wiper arm.
- 2** **2**
Slide in the new wiper blade until a "click" is heard.
- 3** Check that the blade is firmly installed.
- 4** Fold the wiper arm back towards the windscreen.

The wiper blades are different lengths

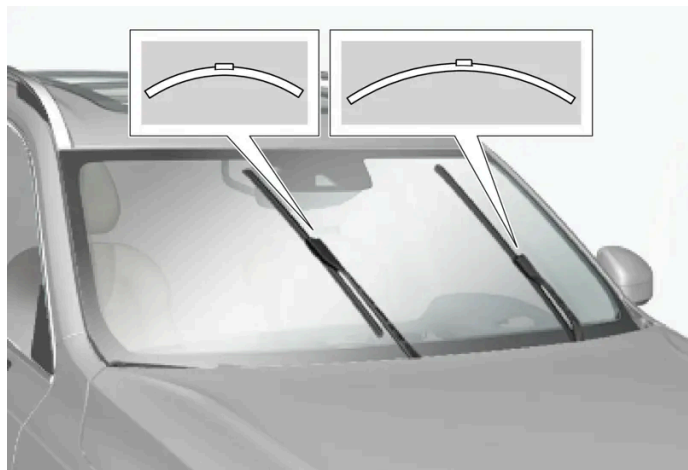

i Note

When replacing the wiper blades, note that they have different lengths. The blade on the driver's side is longer than on the passenger side.

18.3. Bulb replacement

18.3.1. Bulb replacement

This car is equipped only with LED^[1] lamps and therefore no replaceable bulbs. Contact a workshop^[2] if a fault occurs in the lighting.

If a fault occurs in LED^[1] lamps, the entire lamp unit usually must be replaced.

i Note

For information about bulbs not covered in this Owner's Manual, contact a Volvo dealer or an authorised Volvo workshop.

i Note

Outside lighting such as headlamps and rear lamps may temporarily have condensation on the inside of the lens. This is normal, all exterior lighting is designed to withstand this. Condensation is normally vented out of the lamp housing when the lamp has been switched on for a time.

^[1] LED (Light Emitting Diode)

[2] An authorised Volvo workshop is recommended.

18.3.2. Checking trailer lamps

When connecting a trailer – check that the trailer lamps work before departure.

Checking trailer lamps *

Automatic checking

After a trailer is connected electrically, it is possible to check that the trailer lamps are working via an automatic lamp activation. The function helps the driver check that the trailer lamps are working before starting off.

The car must be switched off to perform the check.

- 1 When a trailer is connected to the towbar, the **Automatic Trailer Lamp Check** message is shown in the driver display.
- 2 Confirm the message by pressing the right-hand steering wheel keypad's **O** button.
 - The lamp check starts.
- 3 Exit the car to check lamp functionality.
 - All trailer lamps start to flash - then the lamps are switched on one at a time.
- 4 Visually check that all lamps available on the trailer are operational.
- 5 After a moment, all lamps on the trailer flash again.
 - The check is complete.

Switching off automatic checking

The automatic checking function can be switched off in the centre display.

- 1 Press **Settings** in the top view.
- 2 Press **My Car** → **Lights and Lighting**.
- 3 Deselect **Automatic Trailer Lamp Check**.

Manual checking

If the automatic checking is switched off then it is possible to start the check manually.

- 1 Press **Settings** in the top view.
 - 2 Press **My Car** → **Lights and Lighting**.
 - 3 Select **Manual Trailer Lamp Check**.
- The lamp check starts. Exit the car to check lamp functionality.

Rear fog lamp on trailer

When connecting the trailer, the rear fog lamp may not light up on the car. In such cases, the rear fog lamp function switches to the trailer. Upon activation of the rear fog lamp, check therefore that the trailer is equipped with a rear fog lamp to travel safely.

Symbols and messages in the driver display

If one or more of the trailer's direction indicators or brake light bulbs is broken, the driver display shows a symbol and a message. Other lights on the trailer must be checked manually by the driver before setting off.

Symbol	Message
	<ul style="list-style-type: none"> • Trailer turn indicator Right turn indicator malfunction • Trailer turn indicator Left turn indicator malfunction
	<ul style="list-style-type: none"> • Trailer brake light Malfunction

If any lamp for the trailer's direction indicators is broken, the driver display symbol for direction indicators will also flash more quickly than normal.

* Option/accessory.

18.4. Engine compartment

18.4.1. Topping up washer fluid

Washer fluid is used for cleaning the headlamps as well as the windscreen and rear window. Washer fluid with antifreeze must be used when the temperature is under the freezing point.

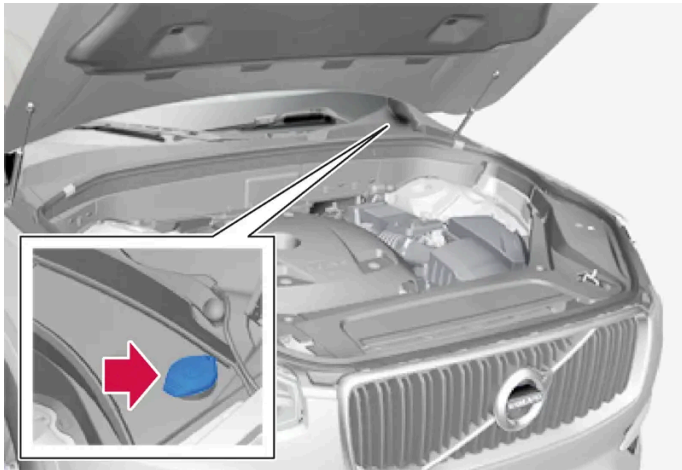

Washer fluid is filled into the reservoir with the blue cap. The reservoir is used for windscreen washer, rear window washer and headlamp washers*.

Note

When approx. 1 litre (1 qt) of washer fluid remains in the reservoir, the message **Washer fluid Level low, refill** is shown in the driver display, together with the  symbol.

Prescribed grade: Washer fluid recommended by Volvo – with frost protection during cold weather and for temperatures below freezing point.

Important

Use Volvo genuine washer fluid or equivalent with a recommended pH of between 6 and 8, in working dilution (e.g. 1:1 with neutral water).

Important

Use washer fluid with antifreeze when the temperature is below freezing to avoid the fluid freezing inside the pump, reservoir and hoses.

Volume:

- Cars **with** headlamp washing: 5.5 litres (5.8 qts).
- Cars **without** headlamp washing: 3.5 litres (3.7 qts).

* Option/accessory.

18.4.2. Brake fluid – specifications

Brake fluid is the medium in a hydraulic brake system that is used to transfer pressure from e.g. a brake pedal via a master brake cylinder, which in turn acts on the brake callipers.

Prescribed grade: Volvo Original or equivalent fluid compliant with a combination of Dot 4, 5.1 and ISO 4925 class 6.

Note

It is recommended that brake fluid is changed or filled by an authorised Volvo workshop.

18.4.3. Opening and closing the bonnet

The bonnet can be opened using the handle in the passenger compartment and a handle under the bonnet.

Open the bonnet

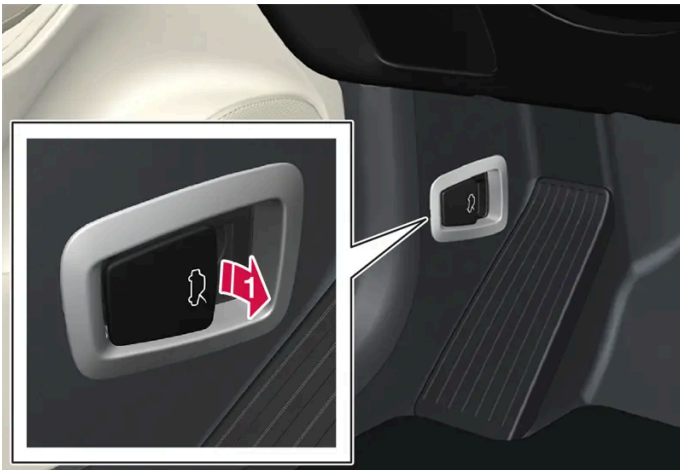

 Pull the handle on the left of the brake pedal in order to release the bonnet from fully closed position.



➔ Turn the handle under the bonnet anticlockwise to release the bonnet from the lock catches and lift the bonnet.

Warning - bonnet not closed



When the bonnet is released, a warning symbol and graphics in the driver display will light up and an acoustic reminder will sound. If the car starts rolling, an acoustic warning signal will repeat.

Note

If the warning symbol is lit or the warning signal is heard despite the bonnet being closed properly, contact an authorised Volvo workshop.

Close the bonnet

- 1 Push the bonnet down until it starts to fall from its own weight.
- 2 When the bonnet stops against the lock catch, push the bonnet to close it completely.

Warning

Risk of crushing! Ensure that the closing path under the bonnet is not obstructed, otherwise there is a risk of personal injury.

Warning

Check that the bonnet locks properly when closed. The bonnet must engage at both sides audibly.



Bonnet not completely closed.



Bonnet completely closed.

 **Warning**



Never drive with an open bonnet!

If this symbol is visible – or something else indicates that the bonnet is not fully closed while driving – stop immediately and close it properly.

18.4.4. Engine compartment overview

The overview shows some service-related components.

Some of the components included in the car's electric drive system are located under the bonnet. Exercise caution in this area and only touch anything that is related to normal maintenance.

 **Warning**

Orange-coloured cables must only be handled by qualified personnel.

 **Warning**

Several components in the car work with high-voltage current that could be dangerous in the event of incorrect intervention.

- Do not touch anything that is not clearly described in the owner's manual.
- Exercise caution when checking/refilling fluids in the engine compartment.

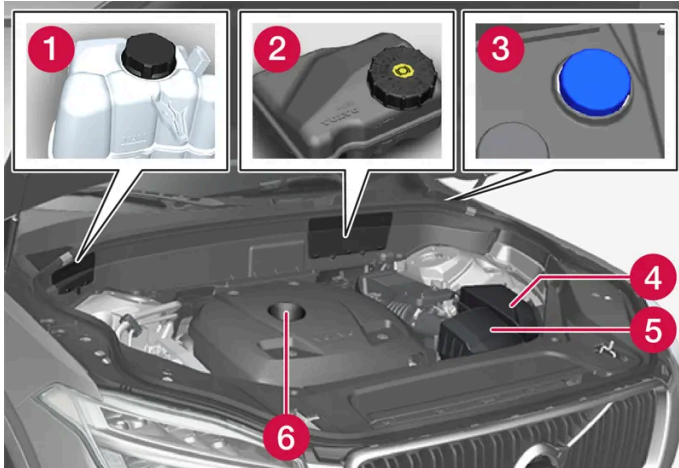

The appearance of the engine compartment may differ depending on model and engine variant.

- 1 Coolant expansion tank
- 2 Reservoir for brake fluid (located on the driver's side)
- 3 Washer fluid filler pipe
- 4 Central electrical unit
- 5 Air filter
- 6 Engine oil filler pipe

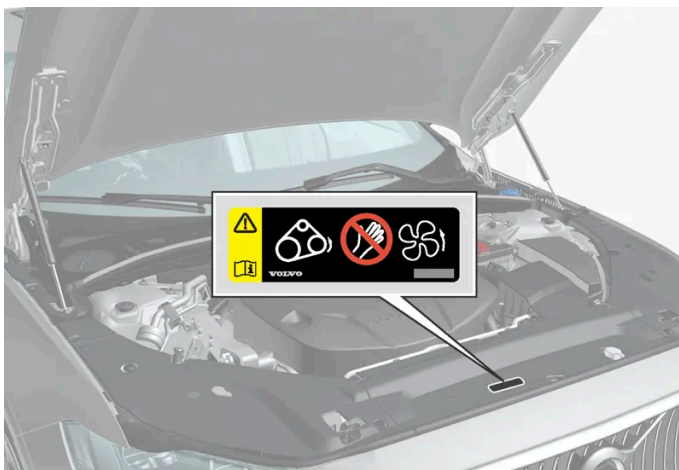

Location of warning decal for the engine compartment. The appearance of the engine compartment may differ depending on model and engine variant.

 **Note**

It is not intended that the decals illustrated in the owner's manual should be exact replicas of those in the car. They are included to show their approximate appearance and locations in the car. The information that applies to your particular car can be found on the decal on the car.

 **Warning**

Remember that the radiator fan (located at the front of the engine compartment, behind the radiator) may start or continue to operate automatically for up to approx. 6 minutes after the engine has been switched off.

Always have the engine cleaned by a workshop - an authorised Volvo workshop is recommended. There is a risk of fire if the engine is hot.

 **Warning**

The ignition system works at a very high and hazardous voltage. The car's electrical system must always be in ignition position 0 when work is being performed in the engine compartment.

Do not touch the spark plugs or ignition coil when the car's electrical system is in ignition position II or when the engine is hot.

18.4.5. Coolant

The coolant cools the internal combustion engine to the correct operating temperature. The surplus heat can be used to heat the passenger compartment.

Prescribed grade: Ready-mixed coolant approved by Volvo. If concentrated coolant is used, mix with 50% water (of approved water quality, not salt water, etc.). Consult a Volvo dealer if unsure.

In order to prevent deterioration of cooling system function, which may lead to engine malfunction among other things, only coolant approved by Volvo should be used.

 **Warning**

Swallowing coolant is hazardous, it may cause damage to organs (kidneys). The product contains ethylene glycol, inhibitor, water, etc.

18.4.6. Topping up coolant

When topping up the coolant, follow the instructions on the packaging. Never top up with water only. The risk of freezing increases with both too little and too much coolant concentrate.

If there is coolant under the car, if there is coolant smoke, or if more than 2 litres (approx. 2 quarts) have been filled, always call for recovery to avoid the risk of engine damage due to a defective cooling system when attempting to start the car.

 **Warning**

The coolant may be very hot. Never open the cap when the coolant is hot. If a top-up is required, unscrew the expansion tank cap slowly to allow any overpressure to disappear.



Coolant expansion tank

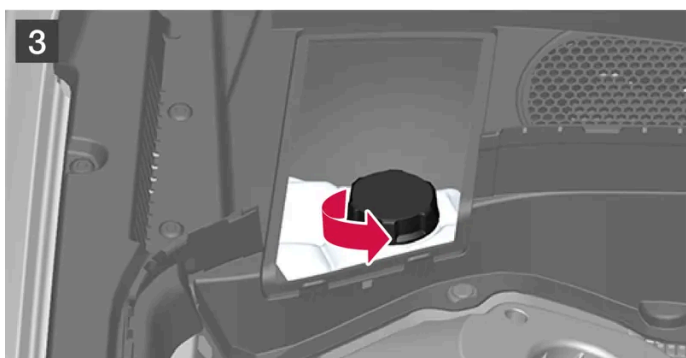
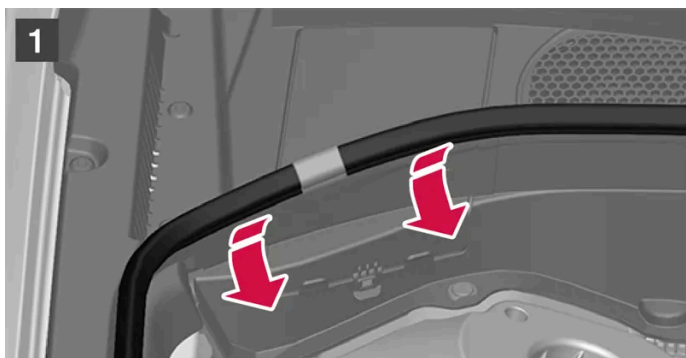

- 1** **1**
Lift off the rubber strip by pressing it inward in the engine compartment.
- 2** **2**
Detach the flap in the plastic cover by folding out the release catch and turning the flap upward.
- 3** **3**
Screw off the cap and top up with coolant if necessary. The coolant level must lie between the MIN and MAX marks on the expansion tank.

! Important

- Harmful if ingested. May cause organ (kidney) damage.
- Use ready-mixed coolant as recommended by Volvo. If concentrated liquid is used, make sure that the ratio is 50 % coolant to 50 % water of an approved quality.
- Do not mix different coolants.
- Only new coolant should be used when replacing major cooling system components to ensure the system has sufficient corrosion protection.
- The engine must only be run with a well-filled cooling system. Otherwise, temperatures that are too high may occur resulting in the risk of damage (cracks) in the cylinder head.
- A high content of chlorine, chlorides and other salts may cause corrosion in the cooling system.

18.4.7. Engine oil

An approved engine oil must be used in order that the recommended service intervals and warranty can be applied.

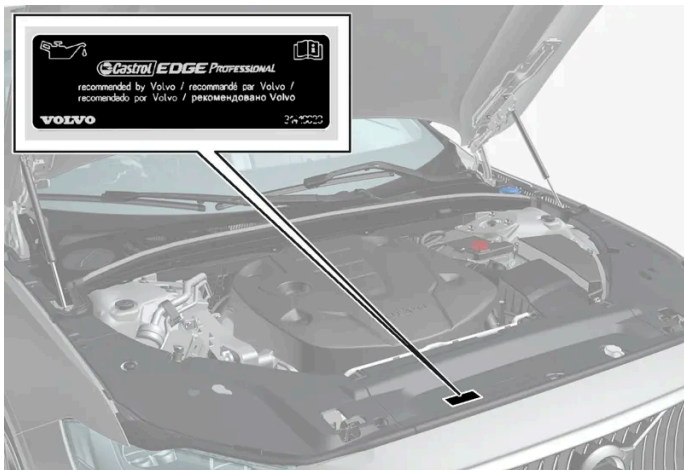

Location of warning decal for the engine compartment. The appearance of the engine compartment may differ depending on model and engine variant.

Volvo recommends:



If the engine oil cannot be checked on a regular basis and the level falls too low, there is a risk that this will cause serious damage to the engine.

i Note

It is not intended that the decals illustrated in the owner's manual should be exact replicas of those in the car. They are included to show their approximate appearance and locations in the car. The information that applies to your particular car can be found on the decal on the car.

! Important



In order to fulfil the requirements for the engine's service intervals all engines are filled with a specially adapted synthetic engine oil at the factory. The choice of oil has been made very carefully with regard to service life, starting characteristics, fuel consumption and environmental impact.

An approved engine oil must be used in order that the recommended service intervals can be applied. Only use a prescribed grade of oil for both filling and oil change, otherwise there is a risk of the service life, starting characteristics, fuel consumption and environmental impact of the car being affected.

If engine oil of the prescribed grade and viscosity is not used, engine related components may become damaged. Volvo disclaims any liability for any such damage.

Volvo recommends that oil changes are carried out at an authorised Volvo workshop.

Symbols for low oil level

Volvo uses different systems to warn about the oil level if it is too low/high, or in the event of low oil pressure. The driver display's warning symbol for low oil pressure is used for the oil pressure sensor . For oil level sensor, the driver is informed via the driver display's warning symbol  and display texts. Certain variants have both systems. Contact a Volvo dealer for more information.

Change the engine oil and oil filter in accordance with the intervals specified in the Service and Warranty Booklet. Using oil of a higher than specified grade is permitted. If the car is driven in adverse conditions, Volvo recommends using an oil of a higher grade than the one specified.

18.4.8. Checking and filling with engine oil

The oil level is detected with the electronic oil level sensor.

See oil level in the centre display

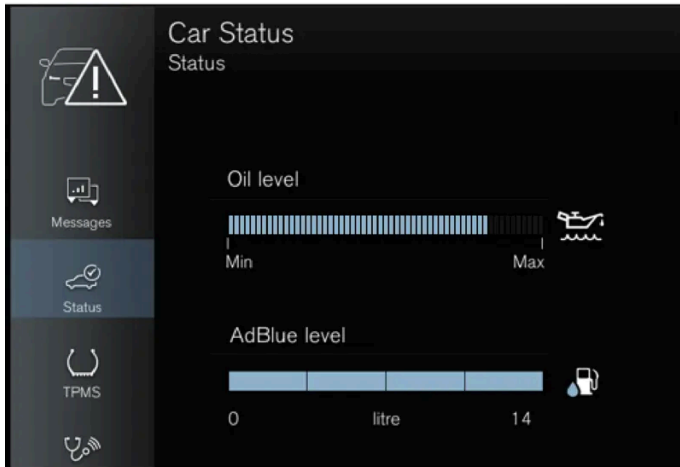

Example of graphic for oil level in the centre display

The oil level is visualised using the electronic oil level gauge in the centre display when the car has been started. The oil level should be checked regularly.

- 1 Open the **Car Status** app from the app view in the centre display.
- 2 Press **Status** to show the oil level.

Note

The system cannot directly detect changes when oil is filled or drained out. The car must have been driven approx. 30 km (approx. 20 miles) and have been stationary for 5 minutes with the engine switched off and on level ground before the oil level indication is correct.

Note

If the right conditions for measuring the oil level (time after engine shutdown, the car's inclination, outside temperature, etc.) are not met, then the message **No value available** will be shown in the centre display. This does **not** mean that there is something wrong in the car's systems.

Important



If this symbol is shown then the oil pressure may be too low. Stop the car as quickly as possible and have the car recovered to a workshop – an authorised Volvo workshop is recommended.

Fill the engine oil



Filler pipe^{[1], [2]}

In some cases, oil may need to be topped up between service intervals. No action with regard to engine oil level needs to be taken until a message is shown in the driver display.

Warning

If the **Engine oil level Service required** message is shown, visit a workshop – an authorised Volvo workshop is recommended. The oil level may be too high.

Warning

Do not spill oil onto the hot exhaust manifold due to the risk of fire.

Important

If the **Engine oil level low Refill 1 litre** message is shown, fill only with the specified volume, e.g. 1 litre (1 quart).

^[1] Engines with electronic oil level sensor do not have a dipstick.

^[2] The appearance of the engine compartment may differ depending on model and engine variant.

18.4.9. Engine oil — specifications

Engine oil grade and volume for each respective engine alternative can be read in the table.

Volvo recommends:



Engine	Engine code ^[1]	Oil grade	Volume, incl. oil filter (litres, approx.)
T8 Recharge	B4204T34	Castrol Edge Professional V 0W-20 or VCC RBS0-2AE 0W-20	5.6
T8 Recharge	B4204T35		5.6
T8 Recharge	B4204T28		5.6

^[1] The engine code, component number and serial number can be found on the engine.

18.4.10. Fuses in engine compartment

Fuses in the engine compartment protect engine and brake functions, amongst other things.

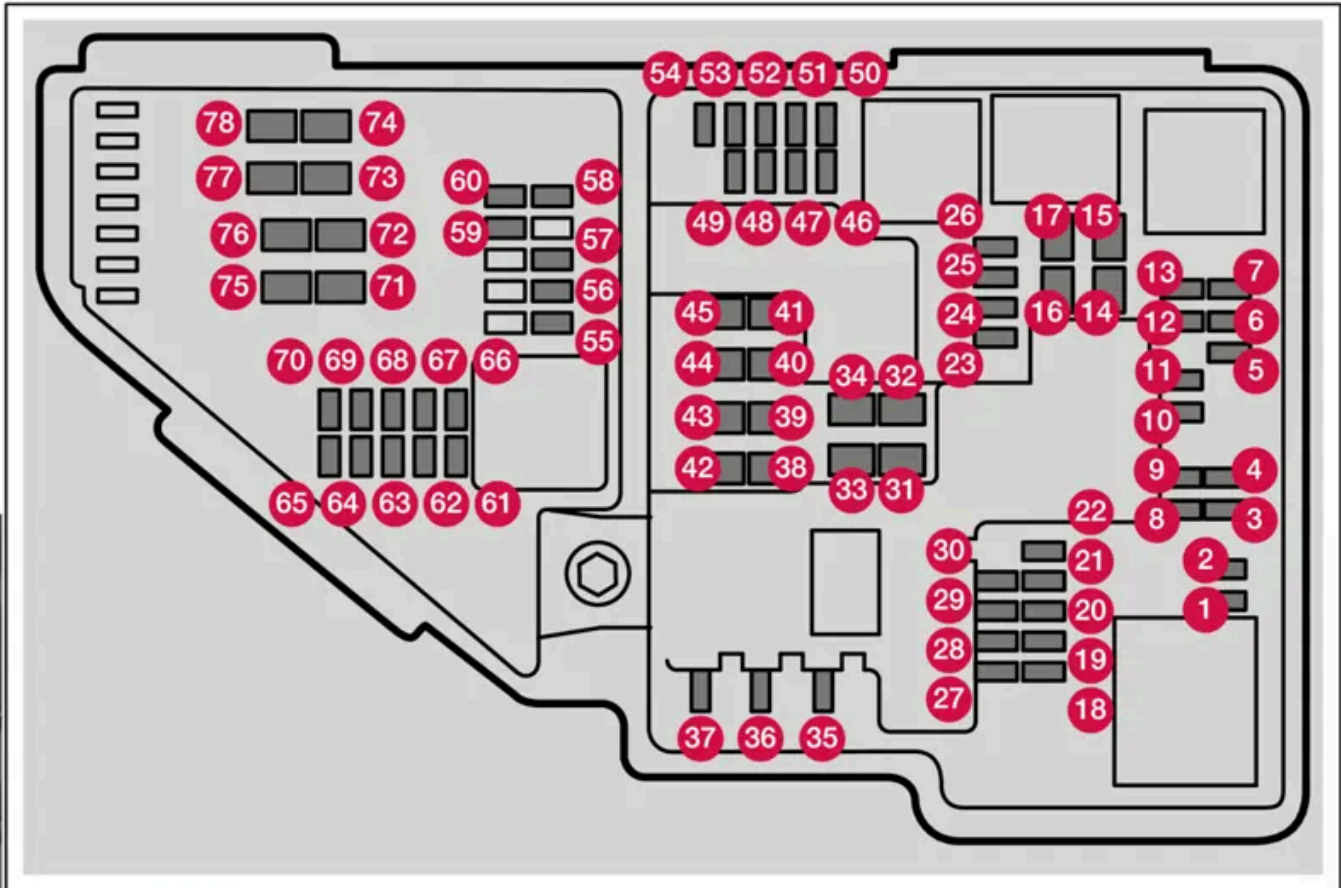

On the inside of the cover there are tweezers that facilitate the procedure for the removal and fitting of fuses.

The fuse box also provides space for several spare fuses.

Positions

On the inside of the cover is a label that shows the location of the fuses. Functions and components in the fuse table cover several models and engine alternatives. An fuse description can therefore apply to fewer or none of the components in the car, depending on how it is equipped.

Function	Ampere	Type
1 –	–	Micro
2 –	–	Micro
3 –	–	Micro
4 Control module, transmission actuator	5	Micro
5 Control module, coolant heating	5	Micro
6 Air conditioning	5	Micro
7 Control module, hybrid battery High voltage converter, high-voltage generator/starter motor	5	Micro
8 –	–	Micro
9 –	–	Micro
10 Control module, hybrid battery High voltage converter, high-voltage generator/starter motor	10	Micro
11 Charging unit	5	Micro
12 Shut-off valve, hybrid battery cooling Coolant pump, hybrid battery	15	Micro
13 Coolant pump, electric drive system	15	Micro
14 Cooling fan, hybrid components	25	MCase ^[1]
15 –	–	MCase ^[1]
16 –	–	MCase ^[1]
17 –	–	MCase ^[1]
18 Calculation unit	5	Micro
19 –	–	Micro
20 –	–	Micro
21 –	–	Micro
22 –	–	Micro
23 USB port, tunnel console, rear*	7,5	Micro
24 12 V socket, tunnel console, front	15	Micro
25 –	–	Micro
26 12 V socket cargo area *	15	Micro
27 –	–	Micro
28 Headlamp, left	15	Micro
29 Headlamp, right	15	Micro
30 –	–	Micro
31 Heated windscreen *, left	Shunt	MCase ^[1]

Function	Ampere	Type
32 Heated windscreen*, left	40	MCase ^[1]
33 Headlamp washers*	25	MCase ^[1]
34 Windscreen washers	25	MCase ^[1]
35 –	–	Micro
36 Horn (honk)	20	Micro
37 Siren*	5	Micro
38 Control module, brake system (valves, parking brake)	30	MCase ^[1]
39 Windscreen wipers	30	MCase ^[1]
40 Rear window washer	25	MCase ^[1]
41 Heated windscreen* right-hand side	40	MCase ^[1]
42 Parking heater*	20	MCase ^[1]
43 –	–	MCase ^[1]
44 –	–	MCase ^[1]
45 Heated windscreen*, right	Shunt	MCase ^[1]
46 Supplied when the ignition is switched on: Engine control module, Transmission components, Electric steering servo, Central electronic module	5	Micro
47 Exterior car noise (certain markets)	5	Micro
48 Headlamp, right	15	Micro
49 Alcohol lock*	5	Micro
50 –	–	Micro
51 –	–	Micro
52 Collision module (SRS)	5	Micro
53 Headlamp, left	15	Micro
54 Accelerator pedal sensor	5	Micro
55 Transmission control module Control module, gear selector	15	Micro
56 Engine Control Module (ECM)	5	Micro
57 –	–	Micro
58 –	–	Micro
59 –	–	Micro
60 –	–	Micro
61 Engine Control Module (ECM) Throttle control module Actuator, switch, compressor	20	Micro
62 Engine component group 1 (components related to engine function, including turbo/compressor. Contents depend on engine alternative.)	10	Micro
63 Engine component group 2 (components related to engine function, including turbo. Contents depend on engine alternative.) Switching valve, air conditioning	7,5	Micro
64 Control module, spoiler damper Control module, radiator damper	5	Micro
65 –	–	Micro
66 Lambda probe	15	Micro

Function	Ampere	Type
67 Solenoid engine oil pump Lambda probes Solenoid air conditioning compressor	15	Micro
68 –	–	Micro
69 Engine Control Module (ECM)	20	Micro
70 Spark plugs/ignition coils	15	Micro
71 –	–	MCase ^[1]
72 –	–	MCase ^[1]
73 Control module, transmission oil pump	30	MCase ^[1]
74 –	–	MCase ^[1]
75 Actuator, transmission	25	MCase ^[1]
76 –	–	MCase ^[1]
77 –	–	MCase ^[1]
78 –	–	MCase ^[1]

^[1] This type of fuse should be replaced by a workshop. An authorised Volvo workshop is recommended.

* Option/accessory.

18.5. Tools and accessories

18.5.1. Jack*

The jack can be used to raise the car, for example, to change to a wheel.



 **Important**

The jack* included with the car is only designed for occasional, short-term use, such as when changing a wheel after a puncture. Only the jack belonging to the specific model is to be used to jack up the car. If the car is to be jacked up more often, or for a longer time than is required just to change a wheel, use of a garage jack is recommended. In this instance, follow the instructions for use that come with the equipment.

When the jack is not in use it must be stored in its storage space under the cargo area floor. The jack needs to be cranked together to the correct position in order to have space.

The jack needs to be cranked together to the correct position in order to have space.

 **Note**

Applies to cars with level control*: If the car is equipped with air suspension, this must be disabled before the car is raised.

* Option/accessory.

18.5.2. Emergency puncture repair kit

The emergency puncture repair kit (TMK^[1]) is used to seal a puncture as well as to check and adjust the air pressure in the tyre.

Cars equipped with spare tyre* do not have the puncture repair kit.

The puncture repair kit consists of a compressor and a bottle with sealing fluid. The sealing works as a temporary repair.

 **Note**

The sealing fluid is effective at sealing tyres with tread punctures but has limited ability to seal tyres with sidewall punctures. Do not use the emergency puncture repair kit on tyres displaying larger slits, cracks or similar damage.

 **Note**

The compressor is intended for temporary emergency puncture repair and is approved by Volvo.

Location

The puncture repair kit is located in the foam block under the cargo area floor.



Sealing fluid expiry date

The bottle of sealing fluid must be replaced if the bottle's expiry date has passed (see the decal on the bottle). Treat the old bottle as environmentally hazardous waste.

[1] Temporary Mobility Kit

* Option/accessory.

18.5.3. First aid kit *

The first aid kit contains first aid equipment.

Store the first aid kit behind the elastic strap, if the car is equipped with one of these.



* Option/accessory.

18.5.4. Warning triangle

Use the warning triangle to warn other road users if the car is stationary in traffic.

Also activate the hazard warning flashers.

Storage spaces

The warning triangle is located in the compartment on the inside of the tailgate.

Folding up the warning triangle

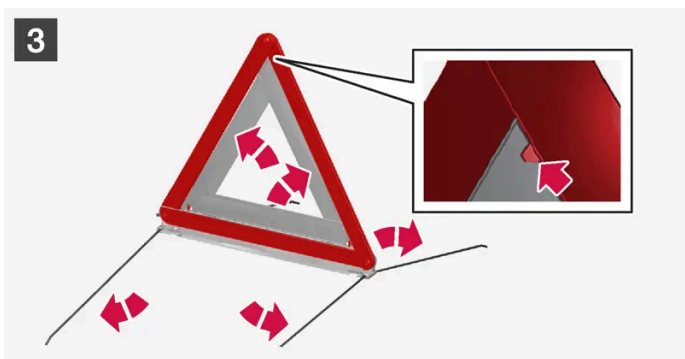
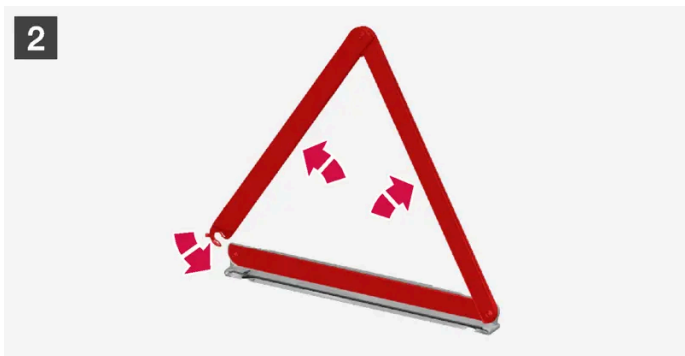
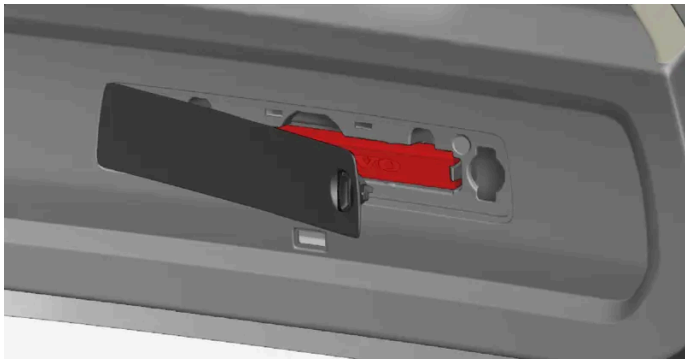

1 1

Open the hatch by first turning the knob a quarter turn and then pulling the hatch from its brackets in the top and bottom edges.

Press the latch that secures the warning triangle slightly to the right and remove the case.

2 **2**

Remove the warning triangle from the case, unfold it and put the ends together.

3 **3**

Fold out the warning triangle's support legs.

Follow the regulations for the use of a warning triangle. Position the warning triangle in a suitable place with regard to traffic.

Make sure that the warning triangle and case are properly secured in their storage space and that the hatch is fully closed after use.

18.5.5. Tool kit

Tools that can be useful during towing, wheel changes or similar are found in the car's cargo area.



Examples of tools.

- 1 Jack*
- 2 Tool for removing the plastic caps from the wheel bolts
- 3 Funnel for filling fluids
- 4 Wheel wrench* and towing eye

If the car is fitted with a spare wheel*, there is a jack and a wheel bolt wrench instead of emergency puncture repair kit.

* Option/accessory.

18.6. Fuses

18.6.1. Fuses and central electrical units

Electrical functions and components are protected by a number of fuses in order to protect the car's electrical system from damage by short circuiting or overloading.

Warning

Never use a foreign object or a fuse with an amperage higher than that specified when replacing a fuse. This could cause significant damage to the electrical system and possibly lead to fire.

Warning

Orange-coloured cables must only be handled by qualified personnel.

Warning

Several components in the car work with high-voltage current that could be dangerous in the event of incorrect intervention.

Do not touch anything that is not clearly described in the owner's manual for the car.



If an electrical component or function does not work, it may be because the component's fuse was overloaded and has blown. If the same fuse blows repeatedly then there is a fault in a component. Volvo recommends contacting an authorised Volvo workshop for checking.

Location of central electrical units



The figure is schematic - appearance may vary depending on car model.

Central electrical unit locations in a left-hand drive car – for a right-hand drive car, the central electrical units under the glovebox change sides.

-  Engine compartment
-  Under the glovebox
-  Cargo area

The content of this manual represents the status of the user manual at the time of printing and may not be completely valid in future instances. For more information, refer to the first page for the complete disclaimer note.

18.6.2. Replacing a fuse

Electrical functions and components are protected by a number of fuses in order to protect the car's electrical system from damage by short circuiting or overloading.

- 1 Look in the fuse diagram to locate the fuse.
- 2 Pull out the fuse and check from the side to see whether the curved wire has blown.
- 3 If this is the case, replace it with a new fuse of the same colour and amperage.

 **Warning**

Never use a foreign object or a fuse with an amperage higher than that specified when replacing a fuse. This could cause significant damage to the electrical system and possibly lead to fire.

 **Warning**

Contact an authorised Volvo workshop about the fuses not mentioned in the owner's manual. If replacing the fuse is not performed correctly, it can cause serious damage to the electrical systems.

18.6.3. Fuses under glovebox

Fuses under the glovebox protect, amongst other things, electrical sockets, displays and door modules.

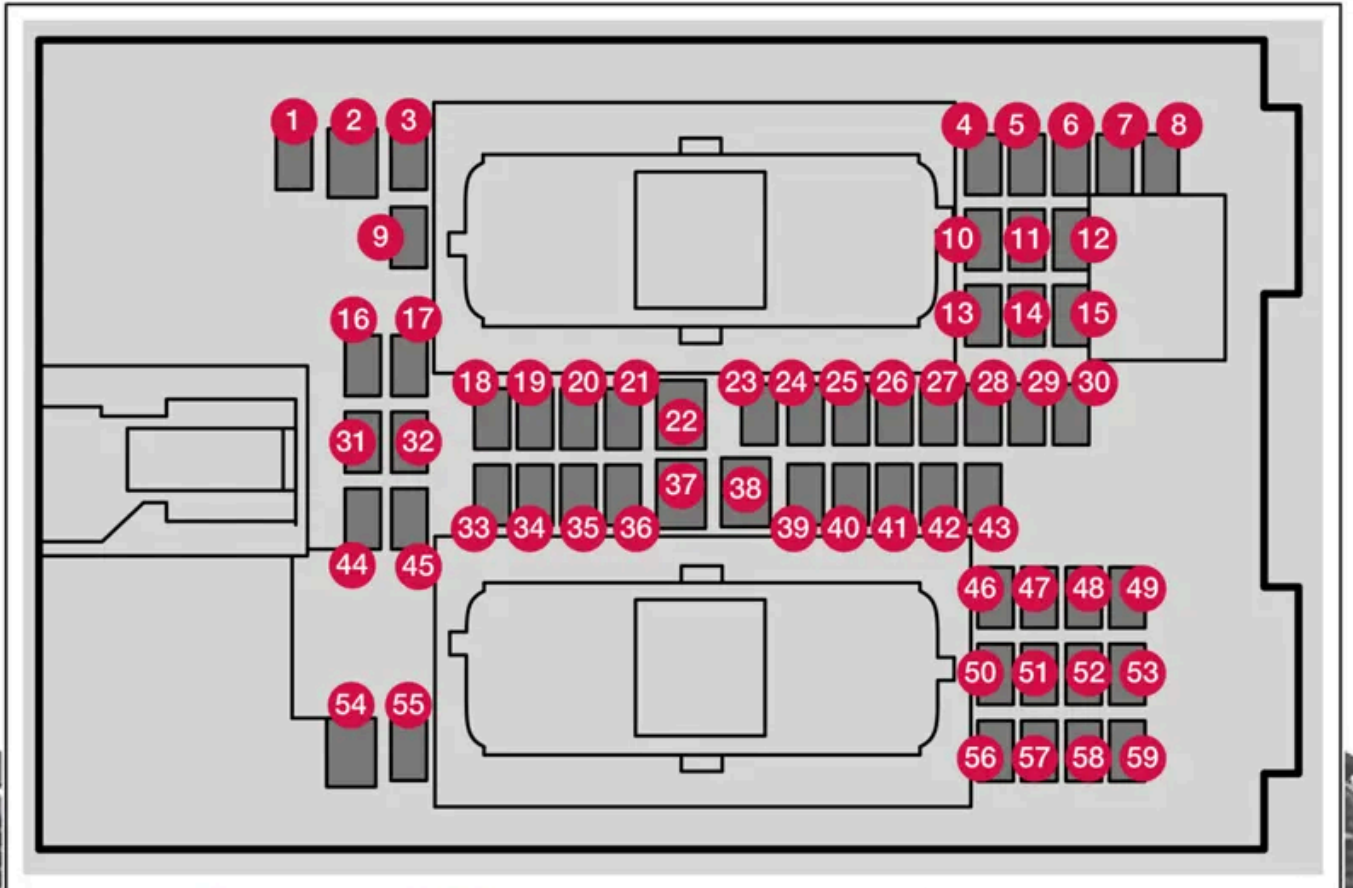

The central electrical unit is located behind the floor mat/side panel.

On the inside of the cover there are tweezers that facilitate the procedure for the removal and fitting of fuses.

The **fuse box in the engine compartment** also provides space for several spare fuses.

Positions

On the inside of the cover is a label that shows the location of the fuses. Functions and components in the fuse table cover several models and engine alternatives. An fuse description can therefore apply to fewer or none of the components in the car, depending on how it is equipped.

	Function	Ampere	Type
1	Control module, 48 V battery ^[1]	10	Micro
2	–	–	MCase ^[2]
3	–	–	Micro
4	Movement detector*	5	Micro
5	–	–	Micro
6	Driver display	5	Micro
7	Keypad, centre console	5	Micro
8	Sun sensor	5	Micro
9	–	–	Micro
10	–	–	Micro
11	Steering wheel module	5	Micro
12	Control module, start knob and parking brake	5	Micro
13	Heated steering wheel*	15	Micro
14	–	–	Micro
15	–	–	Micro
16	–	–	Micro
17	–	–	Micro
18	Control module, climate control	10	Micro
19	Steering lock	7,5	Micro
20	Diagnostic port	10	Micro
21	Centre display	5	Micro
22	Fan module, climate control, front	40	MCase ^[2]
23	USB hub	5	Micro
24	Controls lighting Passenger compartment lighting Dimming, interior rearview mirror* Rain and light sensors* Power front seats* Control panels, rear doors Fan module, climate control Keypad, tunnel console at legroom second row of seats*	7,5	Micro
25	Control module, driver support functions	5	Micro
26	Roof console	20	Micro
27	Head-up display*	5	Micro
28	Passenger compartment lighting	5	Micro

	Function	Ampere	Type
29	Wireless charging plate	5	Micro
30	Display roof console	5	Micro
31	–	–	Micro
32	–	–	Micro
33	–	–	Micro
34	–	–	Micro
35	Control module, online car Control module Volvo On Call	5	Micro
36	–	–	Micro
37	Audio control device (amplifier)	40	MCase ^[2]
38	Fan module, climate control, rear*	40	MCase ^[2]
39	Multi-band antenna	5	Micro
40	Control module, seat comfort, front*	5	Micro
41	Alcohol lock*	5	Micro
42	Rear window wiper	15	Micro
43	Control module, fuel pump	15	Micro
44	Relay coil, transmission oil pump	5	Micro
45	Opening the boot lid/tailgate with foot motion*	–	Micro
46	Seat heating, driver's side front	15	Micro
47	Seat heating, passenger side front	15	Micro
48	Coolant pump	7,5	Micro
49	–	–	Micro
50	Power driver's seat*	20	Micro
51	Module, active damping*	20	Micro
52	–	5	Micro
53	Infotainment module	10	Micro
54	–	–	MCase ^[2]
55	–	–	Micro
56	Electrically operated front passenger seat*	20	Micro
57	–	–	Micro
58	TV* (certain markets)	5	Micro
59	Primary fuse for fuses 52, 53, 57 and 58	15	Micro

^[1] Only applies to cars of the mild hybrid type.

^[2] This type of fuse should be replaced by a workshop. An authorised Volvo workshop is recommended.

* Option/accessory.

18.6.4. Fuses in cargo area

Fuses in the cargo area protect, amongst other things, power seats*, airbags and seatbelt tensioners.

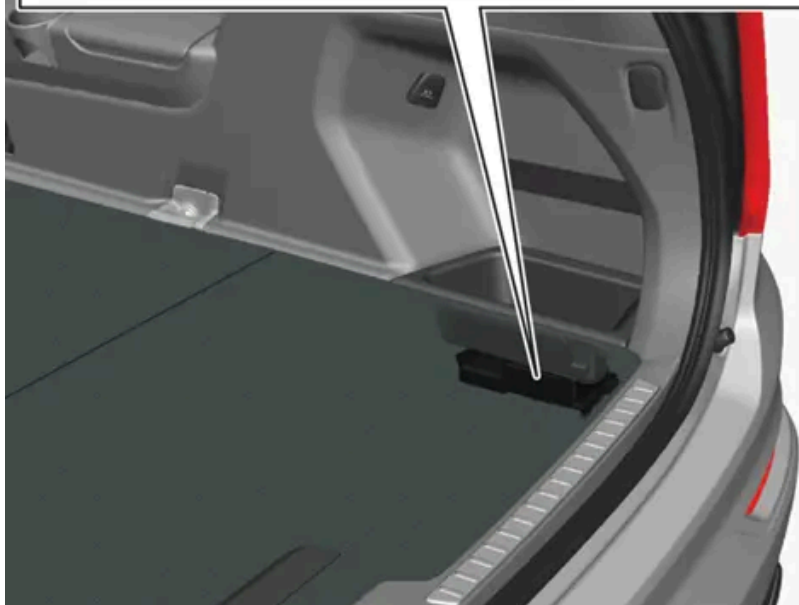
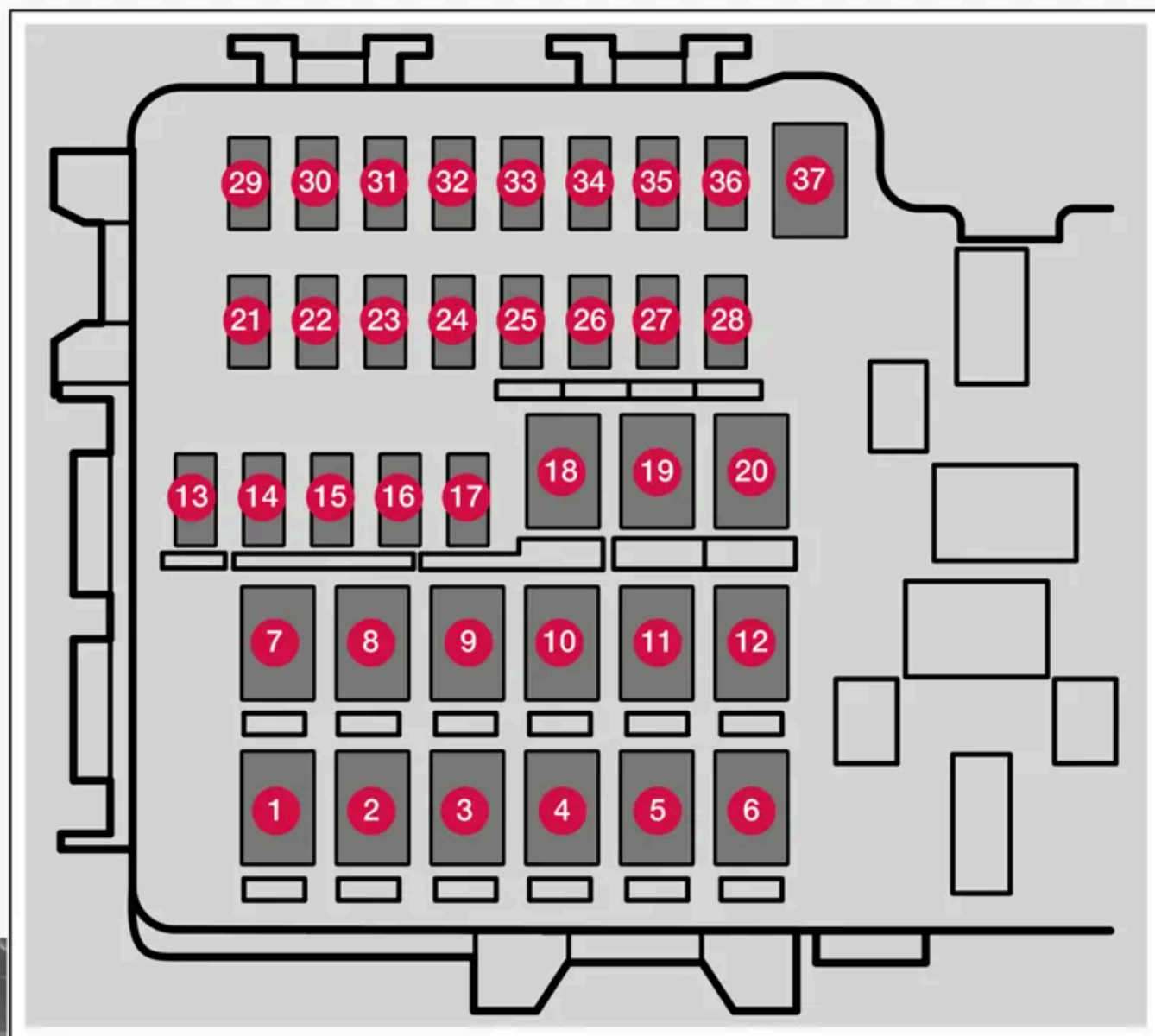

The central electrical unit is located under the storage compartment on the right-hand side.

On the inside of the cover there are tweezers that facilitate the procedure for the removal and fitting of fuses.

The **fuse box in the engine compartment** also provides space for several spare fuses.

Positions

Functions and components in the fuse table cover several models and engine alternatives. An fuse description can therefore apply to fewer or none of the components in the car, depending on how it is equipped.

	Function	Ampere	Type
1	Rear window defroster	30	MCASE ^[1]
2	Central electronic module	40	MCASE ^[1]
3	Compressor, air suspension*	40	MCASE ^[1]
4	Electric additional heater, right rear*	30	MCASE ^[1]
5	–	–	MCASE ^[1]
6	Electric additional heater, left rear*	30	MCASE ^[1]
7	Door module, right rear	20	MCASE ^[1]
8	Control module for reduction of nitrous oxides (only diesel)	30	MCASE ^[1]
	–	–	
9	Power operated tailgate *	25	MCASE ^[1]
10	Door module, right front	20	MCASE ^[1]
11	Towbar control module*	40	MCASE ^[1]
12	Seatbelt pretensioner, right	40	MCASE ^[1]
13	Internal relay coils	5	Micro
14	Control module for reduction of nitrous oxides (diesel)	15	Micro
15	Door module, left rear	20	Micro
16	Alcohol lock *	5	Micro
17	–	–	Micro
18	Towbar control module*	25	MCASE ^[1]
	Accessory module	40	
19	Door module, left front	20	MCASE ^[1]
20	Seatbelt pretensioner, left-hand side	40	MCASE ^[1]
21	Parking camera *	5	Micro
22	–	–	Micro
23	–	–	Micro
24	–	–	Micro
25	Supply when the ignition is switched on	10	Micro
26	–	–	Micro
27	–	–	Micro
28	Seat heating, left rear*	15	Micro
29	–	–	Micro

	Function	Ampere	Type
30	Blind Spot Information (BLIS)*	5	Micro
31	–	–	Micro
32	Seatbelt pretensioner, left	5	Micro
33	Actuator, exhaust system (petrol)	5	Micro
34	–	–	Micro
35	Control module All Wheel Drive (AWD)*	15	Micro
36	Seat heating, right rear*	15	Micro
37	–	–	MCase ^[1]

* Option/accessory.

^[1] This type of fuse should be replaced by a workshop. An authorised Volvo workshop is recommended.

18.6.5. Fuses in engine compartment

Fuses in the engine compartment protect engine and brake functions, amongst other things.

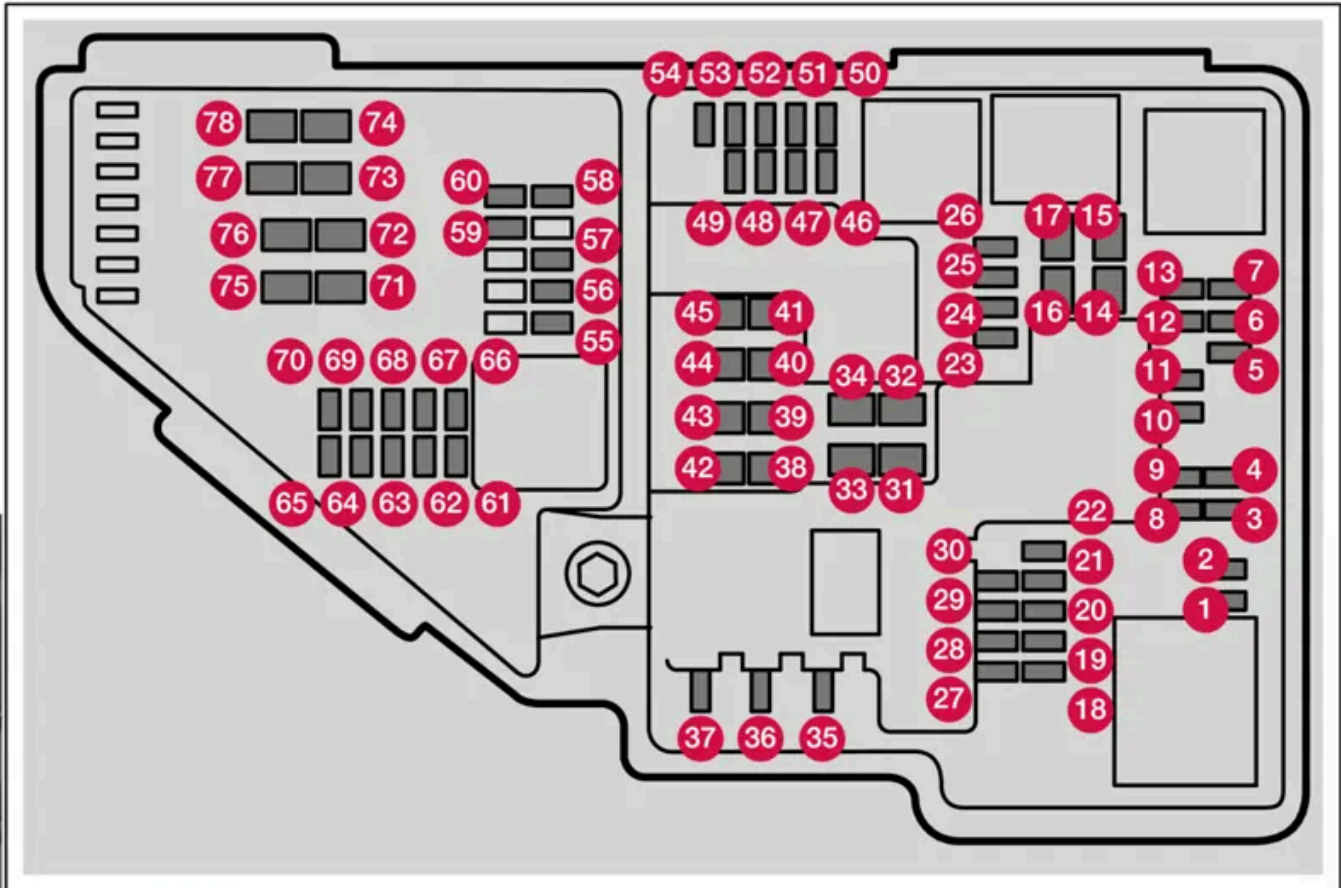

On the inside of the cover there are tweezers that facilitate the procedure for the removal and fitting of fuses.

The fuse box also provides space for several spare fuses.

Positions

On the inside of the cover is a label that shows the location of the fuses. Functions and components in the fuse table cover several models and engine alternatives. An fuse description can therefore apply to fewer or none of the components in the car, depending on how it is equipped.

Function	Ampere	Type
1 –	–	Micro
2 –	–	Micro
3 –	–	Micro
4 Control module, transmission actuator	5	Micro
5 Control module, coolant heating	5	Micro
6 Air conditioning	5	Micro
7 Control module, hybrid battery High voltage converter, high-voltage generator/starter motor	5	Micro
8 –	–	Micro
9 –	–	Micro
10 Control module, hybrid battery High voltage converter, high-voltage generator/starter motor	10	Micro
11 Charging unit	5	Micro
12 Shut-off valve, hybrid battery cooling Coolant pump, hybrid battery	15	Micro
13 Coolant pump, electric drive system	15	Micro
14 Cooling fan, hybrid components	25	MCase ^[1]
15 –	–	MCase ^[1]
16 –	–	MCase ^[1]
17 –	–	MCase ^[1]
18 Calculation unit	5	Micro
19 –	–	Micro
20 –	–	Micro
21 –	–	Micro
22 –	–	Micro
23 USB port, tunnel console, rear*	7,5	Micro
24 12 V socket, tunnel console, front	15	Micro
25 –	–	Micro
26 12 V socket cargo area *	15	Micro
27 –	–	Micro
28 Headlamp, left	15	Micro
29 Headlamp, right	15	Micro
30 –	–	Micro
31 Heated windscreen *, left	Shunt	MCase ^[1]

Function	Ampere	Type
32 Heated windscreen*, left	40	MCase ^[1]
33 Headlamp washers*	25	MCase ^[1]
34 Windscreen washers	25	MCase ^[1]
35 –	–	Micro
36 Horn (honk)	20	Micro
37 Siren*	5	Micro
38 Control module, brake system (valves, parking brake)	30	MCase ^[1]
39 Windscreen wipers	30	MCase ^[1]
40 Rear window washer	25	MCase ^[1]
41 Heated windscreen* right-hand side	40	MCase ^[1]
42 Parking heater*	20	MCase ^[1]
43 –	–	MCase ^[1]
44 –	–	MCase ^[1]
45 Heated windscreen*, right	Shunt	MCase ^[1]
46 Supplied when the ignition is switched on: Engine control module, Transmission components, Electric steering servo, Central electronic module	5	Micro
47 Exterior car noise (certain markets)	5	Micro
48 Headlamp, right	15	Micro
49 Alcohol lock*	5	Micro
50 –	–	Micro
51 –	–	Micro
52 Collision module (SRS)	5	Micro
53 Headlamp, left	15	Micro
54 Accelerator pedal sensor	5	Micro
55 Transmission control module Control module, gear selector	15	Micro
56 Engine Control Module (ECM)	5	Micro
57 –	–	Micro
58 –	–	Micro
59 –	–	Micro
60 –	–	Micro
61 Engine Control Module (ECM) Throttle control module Actuator, switch, compressor	20	Micro
62 Engine component group 1 (components related to engine function, including turbo/compressor. Contents depend on engine alternative.)	10	Micro
63 Engine component group 2 (components related to engine function, including turbo. Contents depend on engine alternative.) Switching valve, air conditioning	7,5	Micro
64 Control module, spoiler damper Control module, radiator damper	5	Micro
65 –	–	Micro
66 Lambda probe	15	Micro

Function	Ampere	Type
67 Solenoid engine oil pump Lambda probes Solenoid air conditioning compressor	15	Micro
68 –	–	Micro
69 Engine Control Module (ECM)	20	Micro
70 Spark plugs/ignition coils	15	Micro
71 –	–	MCase ^[1]
72 –	–	MCase ^[1]
73 Control module, transmission oil pump	30	MCase ^[1]
74 –	–	MCase ^[1]
75 Actuator, transmission	25	MCase ^[1]
76 –	–	MCase ^[1]
77 –	–	MCase ^[1]
78 –	–	MCase ^[1]

^[1] This type of fuse should be replaced by a workshop. An authorised Volvo workshop is recommended.

* Option/accessory.

18.7. Battery

18.7.1. Replacing the battery in the remote control key

The battery in the remote control key needs to be replaced when it has become discharged.

Note

All batteries have a limited service life and must eventually be replaced (does not apply to Key Tag). The service life of the battery varies depending on how often the vehicle/key is used.



The battery for the remote control key should be replaced if

- the information symbol illuminates and the message **Car key battery low** is shown in the driver display
- the locks repeatedly do not react to signals from the remote control key within 20 metres (65 feet) of the car.

Note

Always try moving closer to the car and making another unlock attempt.

The battery in the button-less key^[1] (Key Tag) cannot be replaced - a new key can be ordered from an authorised Volvo workshop.

Important

A discharged Key Tag must be handed over to an authorised Volvo workshop. The key must be deleted from the car since it is still possible to use it to start the car via back-up start.

Opening the key and changing the battery

1 **1**



1

1 Hold the remote control key with the front visible and the Volvo logo facing the right way - slide the button at bottom edge by the key ring to the right. Slide the front side's shell a few millimetres upwards.

2 The shell will then come free and can be lifted off the key.

2 **2**



2

1 Turn the key, move the button to the side and slide the back shell a few millimetres upwards.

2 The shell will then come free and can be lifted off the key.

3 3



3

Use a screwdriver or similar to turn the battery cover anticlockwise until the markings meet at the OPEN text.

Carefully lift away the battery cover by pressing e.g. a fingernail into the recess.

Then prize the battery cover upwards.

4 4



4

The battery (+) side is facing upwards. Then carefully prize loose the battery as illustrated.

 **Important**

Avoid touching new batteries and their contact surfaces with your fingers as this may impair their function.

5 5



5

Install a new battery with the (+) side up. Avoid touching the remote control key's battery contacts with your fingers.

1 Place the battery in the holder with the edge down. Then slide the battery forwards so that it fastens under the two plastic catches.

2 Press the battery down so that it fastens under the upper black plastic catch.

i Note

Use batteries with the designation CR2032, 3 V.

i Note

Volvo recommends that the batteries to be used in the remote control key fulfil UN Manual of Test and Criteria, Part III, sub-section 38.3. Batteries fitted in the factory or replaced by an authorised Volvo workshop fulfil the above criteria.

6



6

Refit the battery cover and turn it clockwise until the marking aligns with the CLOSE text.

7



7

1 Reposition the rear side's shell and press it down until a clicking sound can be heard.

2 Then slide the shell back.

► A further click will indicate that the shell is properly positioned and securely attached.

8



8

1 Turn the remote control key over and refit the front side's shell by pressing it down until a clicking sound can be heard.

2 Then slide the shell back.

> A further click will indicate that the shell is securely attached.

 **Warning**

Check that the battery is fitted correctly with the correct polarity. If the remote control key shall not been used for a long time, remove the battery to avoid battery leakage and damage. Batteries with damage or leaks may cause corrosive injury on contact with the skin. Therefore, use protective gloves when handling damaged batteries.

- Keep batteries out of the reach of children.
- Do not leave batteries lying around since they can be swallowed by children or pets.
- Batteries must not: be dismantled, short-circuited or thrown into open flames.
- Do not charge non-rechargeable batteries, this may cause an explosion.

Before use, the remote control key should be checked to avoid causing damage. If damage is discovered, e.g. if the battery cover cannot be closed properly, then the product should not be used. Keep defective products out of the reach of children.

 **Important**

Make sure that exhausted batteries are disposed of in a manner which is kind to the environment.

* Option/accessory.

[1] Supplied with cars equipped with keyless locking/unlocking*.

18.7.2. Overloading the starter battery

High power consumption without the car being able to charge the starter battery leads to low State of Charge (SoC) and some electric functions being reduced or switched off. If the State of Charge (SoC) decreases to below a certain limit, it is no longer possible to start the car without jump starting or charging with an external charger.

There are several measures that reduce power consumption. Avoid using the ignition position II when the car is switched off. Instead, use ignition position I - which consumes less power. Do not use functions which use a lot of power when the car is not being driven. Examples of such functions are:

- ventilation fan
- headlamps

The content of this manual represents the status of the user manual at the time of printing and may not be completely valid in future instances. For more information, refer to the first page for the complete disclaimer note.

- windscreen wiper
- audio system
- accessories that are activated in the car.

If the starter battery voltage is low, a message is shown in the driver display. The energy-saving function then shuts down certain functions or reduces certain functions such as the ventilation fan and audio system.

- 1 In which case, charge the starter battery by starting the car and then running it for at least 15 minutes - starter battery charging is more effective during driving than running the engine at idling speed while stationary.

If the battery's State of Charge (SoC) continues to be low or fully discharged after the measures have been taken, the car should be checked at a workshop – an authorised Volvo workshop is recommended.

 **Note**

High current take-off may lead to battery capacity falling below the lowest permitted level, which temporarily limits the start/stop function. The engine then starts automatically without the driver lifting his/her foot from the brake pedal.

18.7.3. Using jump starting with another battery

If the starter battery is discharged then the car can be started with current from another battery.

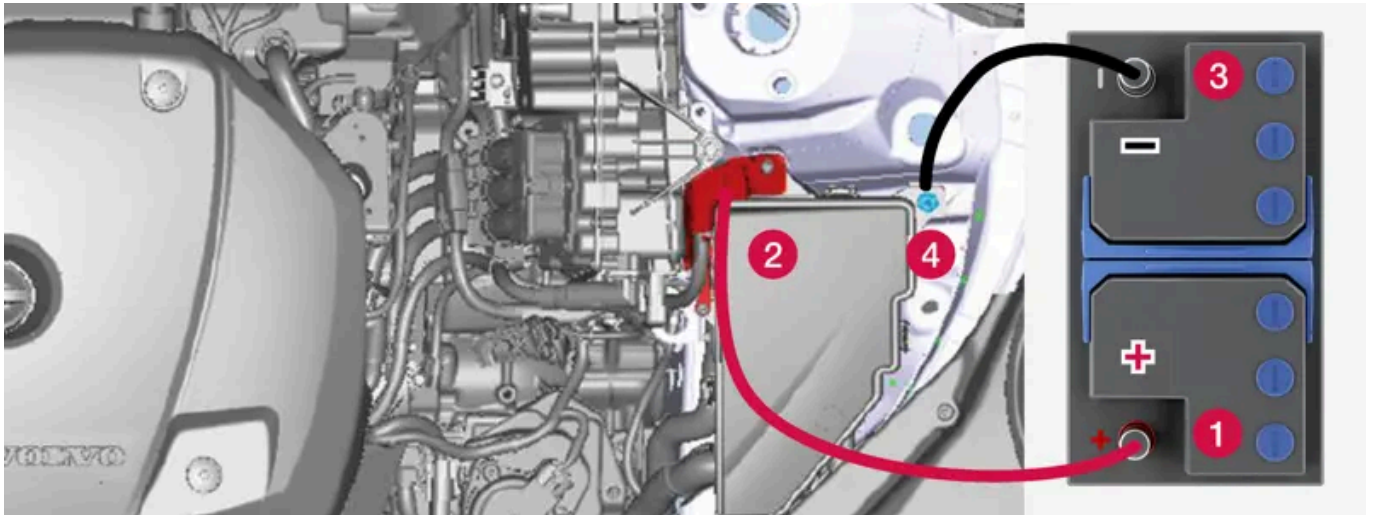

Charging point for jump-starting own car.

! Important

The car's charging point is only intended for jump-starting the car itself. The charging point is not intended for jump-starting another car. Using the charging point to jump start another car may cause a fuse to blow, which means the charging point will stop working.

If a fuse has blown, the message **12 V Battery Fuse failure Service required** is shown in the driver display. Volvo recommends that an authorised Volvo workshop is contacted.

When jump-starting the car, the following steps are recommended to avoid short circuits or other damage:

- 1 Set the car's electrical system in ignition position 0.
- 2 Check that the donor battery has a voltage of 12 V.
- 3 If the donor battery is installed in another car - switch off the donor car's engine and make sure that the two cars do not touch each other.
- 4 Connect one of the red jump lead's clamps to the donor battery's positive terminal (1).

! Important

Connect the start cable carefully to avoid short circuits with other components in the engine compartment.

- 5 Open the positive jump-starting point's cover (2).
- 6 Connect the red jump lead's other clamp onto the car's positive jump-starting point (2).
- 7 Connect one of the black jump lead's clamps to the donor battery's negative terminal (3).
- 8 Connect the black jump lead's other clamp onto the car's negative jump-starting point (4).

- 9 Check that the jump lead clamps are affixed securely so that there are no sparks during the starting attempt.
- 10 Start the engine of the "donor car" and allow it to run a few minutes at a speed slightly higher than idle approx. 1500 rpm.
- 11 Start your own car's engine. If the start attempt fails then extend the charging time to 10 minutes, and then make a new start attempt.

 **Note**

When starting the engine in normal conditions the car's electric drive motor is prioritised - the petrol engine remains switched off. This means that after the start knob has been turned clockwise, the electric motor has "started" and the car is ready to move. A started motor is indicated by the driver display's indicator lamps extinguishing and its preset theme illuminating.

 **Important**

Do not touch the connections between cable and car during the starting attempt. There is a risk of sparks forming.

- 12 Remove the jump leads in reverse order - first the black and then the red.

Make sure that none of the black jump lead's clamps comes into contact with the car's positive jump-starting point/donor battery's positive terminal or the clamp connected to the red jump lead.

 **Warning**

- The battery can generate oxyhydrogen gas, which is highly explosive. A spark can be formed if a jump lead is connected incorrectly, and this can be enough for the battery to explode.
- Do not connect the jump leads to any fuel system component or any moving part. Be careful of hot engine parts.
- The battery contains sulphuric acid, which can cause serious burns.
- If sulphuric acid comes into contact with eyes, skin or clothing, flush with large quantities of water. If acid splashes into the eyes - seek medical attention immediately.
- Never smoke near the battery.

 **Note**

The car cannot be started if the hybrid battery is discharged.

18.7.4. Power supply

The car's own power supply is connected to several different components and activates their electrical functions.

The car's primary electrical system operates with 12 V voltage and powers electrical equipment.

In addition to the primary electrical system, the car has a high voltage system for electrical propulsion.

 **Warning**

Several components in the car work with high-voltage current that could be dangerous in the event of incorrect intervention. Do not touch anything that is not clearly described in the owner's manual.

Batteries

In order to supply power to the various components, your car is equipped with the following:

- a 12 V starter battery that powers the car's primary electrical system
- a hybrid battery for electrical propulsion of the car.







18.7.5. Recycling the batteries

Used batteries must be recycled in an environmentally sound manner.

Consult a workshop in the event of uncertainty about how this type of waste should be discarded - an authorised Volvo workshop is recommended. The hybrid battery must only be handled by authorised workshop personnel.

18.7.6. Symbols on the batteries

There are information and warning symbols on the batteries.

	Use protective goggles.
	Further information in the owner's manual for the car.
	Store the battery out of the reach of children.
	The battery contains corrosive acid.
	Avoid sparks and naked flames.
	Risk of explosion.



Must be taken for recycling.

18.7.7. Hybrid battery

The car is equipped with a hybrid battery for electric motor operation - a maintenance-free rechargeable Lithium-ion type battery.

Note

The car cannot be started if the hybrid battery is discharged.

If both the starter battery and the hybrid battery are discharged then both batteries must be charged. In such a case, charging only the hybrid battery is not possible. In order for the hybrid battery to be charged, the starter battery must have a certain state of charge.

Warning

The hybrid battery must only be replaced by a workshop - an authorised Volvo workshop is recommended.

The service life and capacity of the hybrid battery

The capacity of the hybrid battery diminishes with age and use, which may result in increased use of the internal combustion engine and, as a consequence, reduced fuel economy and reduced range during electric operation.

Coolant

The hybrid battery's cooling system has a separate expansion tank.

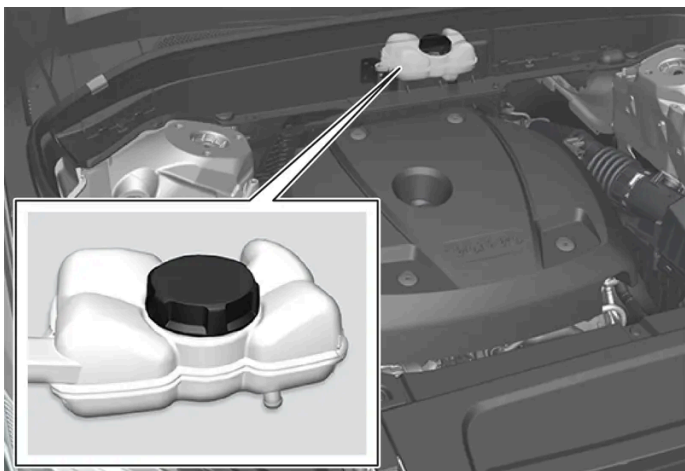

 **Important**

The hybrid battery's coolant must only be topped up by a workshop - an authorised Volvo workshop is recommended.

Specifications for hybrid battery

Type: Lithium-ion

Total amount of energy: 11.6 kWh.

18.7.8. Starter battery

This battery powers the car's primary electrical system, which includes most of the electrical equipment. The hybrid battery is used for starting the internal combustion engine.

The starter battery is a 12 V-battery that is dimensioned to power the car model's specific electrical system and functions.

- Never disconnect the starter battery when the engine is running.
- Check that the cables to the starter battery are correctly connected and properly tightened.

 **Important**

On certain models, the battery is attached with a retaining strap. Make sure the retaining strap is properly tightened.

 **Important**

If the battery is replaced, make sure you replace it with a battery with the same size, cold starting capacity and type as the original battery (see the decal on the battery). Volvo recommends that you use an authorised Volvo workshop for replacing the battery.

 **Warning**

If the starter battery is disconnected, the automatic opening and closing function must be reset to work properly. A reset must take place for pinch protection to work.

 **Warning**

- The battery can generate oxyhydrogen gas, which is highly explosive. A spark can be formed if a jump lead is connected incorrectly, and this can be enough for the battery to explode.
- Do not connect the jump leads to any fuel system component or any moving part. Be careful of hot engine parts.
- The battery contains sulphuric acid, which can cause serious burns.
- If sulphuric acid comes into contact with eyes, skin or clothing, flush with large quantities of water. If acid splashes into the eyes - seek medical attention immediately.
- Never smoke near the battery.

The service life and capacity of the starter battery

The service life of the starter battery is influenced by a number of factors, such as the number of starts, discharges, driving style, driving conditions, and climate conditions. The starting capacity of the battery gradually falls over time, and therefore it needs to be charged if the car is not used for any length of time or if it only travels short distances. Extreme cold further limits starting capacity. If the starter battery is discharged a large number of times, it will negatively affect the service life.

To keep the starter battery in good condition, at least 15 minutes of driving a week is recommended, or connecting the battery to a battery charger with automatic trickle charging. A starter battery that is kept fully charged has a maximum service life.

Location

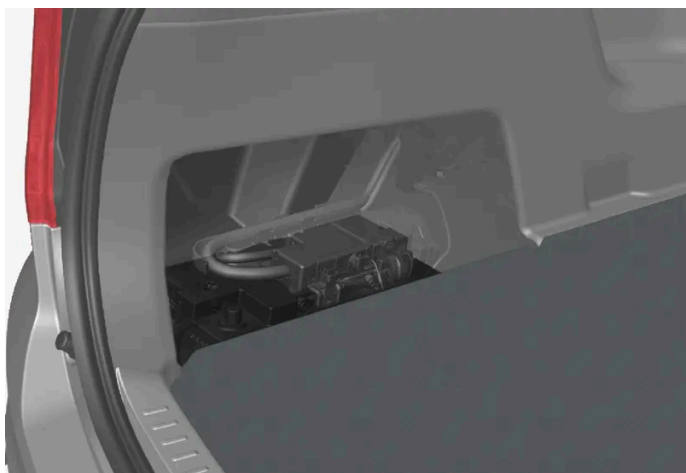

The starter battery is located in the cargo area.

Specifications for starter battery

Battery type	H8 AGM
Voltage (V)	12
Cold start capacity ^[1] - CCA ^[2] (A)	850
Size, L×B×H	353×175×190 mm (13.9×6.9×7.5 inches)
Capacity (Ah)	95

^[1] According to EN standard.

^[2] Cold Cranking Amperes.

18.8. Service

18.8.1. Servicing the climate control system

The air conditioning system must only be serviced and repaired by an authorised workshop.

Troubleshooting and repair

The air conditioning system contains fluorescent tracing agents. Ultraviolet light must be used during leak detection.

Volvo recommends that an authorised Volvo workshop is contacted.

The car's climate control system uses a freon-free refrigerant, either R1234yf or R134a depending on market. Information about which refrigerant the car's climate control system uses is printed on a decal located on the inside of the front bonnet.

 **Warning**

The air conditioning system contains pressurised refrigerant R134a. This system must only be serviced and repaired by an authorised workshop.

 **Warning**

The air conditioning system contains pressurised refrigerant R1234yf. In accordance with SAE J2845 (Technician Training for Safe Service and Containment of Refrigerants Used in Mobile A/C System), service and repair of the refrigerant system must only be performed by trained and certified technicians in order to ensure the safety of the system.

18.8.2. Volvo service programme

To keep the car as safe and reliable as possible, follow the Volvo service programme as specified in the Service and Warranty Booklet.

Volvo recommends engaging an authorised Volvo workshop to perform the service and maintenance work. Volvo workshops have the personnel, special tools and service literature that can provide the highest quality of service.

Important

For the Volvo warranty to apply, check and follow the instructions in the Service and Warranty Booklet.

Service and repair

Service the car regularly. Follow Volvo's recommended service intervals.

If inspection and repair are required then only an authorised Volvo workshop may carry out the work.

Warning

Do not carry out any repairs of your own on this vehicle. Electrical cables and/or components that have detached must only be rectified by an authorised workshop - an authorised Volvo workshop is recommended.

Charging cable with control unit

Important

Do not modify the control unit in any way.

18.9. Car status

18.9.1. Car status

The general status of the car can be shown in the centre display.



The **Car Status** app is started from app view in the centre display and has four tabs:

- **Messages** - status messages
- **Status** – checking engine oil level and AdBlue level^[1]

The content of this manual represents the status of the user manual at the time of printing and may not be completely valid in future instances. For more information, refer to the first page for the complete disclaimer note.

- **TPMS** - checking the tyre pressure
- **Appointments** - appointment information and car information^[2]

^[1] AdBlue Applies to cars with diesel engines.

^[2] Applies to certain markets.

18.9.2. Sending car information to a workshop

It is possible to send vehicle information from the car^[1] at any time, e.g. if you book a workshop appointment and want to help your workshop by providing them with better data so that your visit can be planned. Sending car information is not the same as booking a service appointment.

- 1 Open the **Car Status** app from the app view in the centre display.
 - 2 Press **Appointments**.
 - 3 Press **Send car data**.
- A message that vehicle data are being sent is shown at the top of the centre display. You can cancel data transmission by tapping the X in the activity indicator.
The information is sent via the car's Internet connection^[2].

This car information can be accessed by any retailer if they have the car's identification number (VIN^[3]).

Car information content

The data sent is the last information saved (the last time the car was running) and includes information in the following areas:

- service requirement
- time since last service
- function status
- fluid levels
- meter reading
- the car's vehicle identification number (VIN^[3])
- the car's software version
- the car's diagnostics data.

^[1] Applies to certain markets.

^[2] Data is transferred (data traffic) when using the Internet, and this may involve a cost.

^[3] Vehicle Identification Number.

The content of this manual represents the status of the user manual at the time of printing and may not be completely valid in future instances. For more information, refer to the first page for the complete disclaimer note.

18.10. Download Center

18.10.1. Download Center

Use the Download Centre app in the car's centre display to handle software^[1] such as apps and maps.

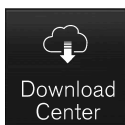
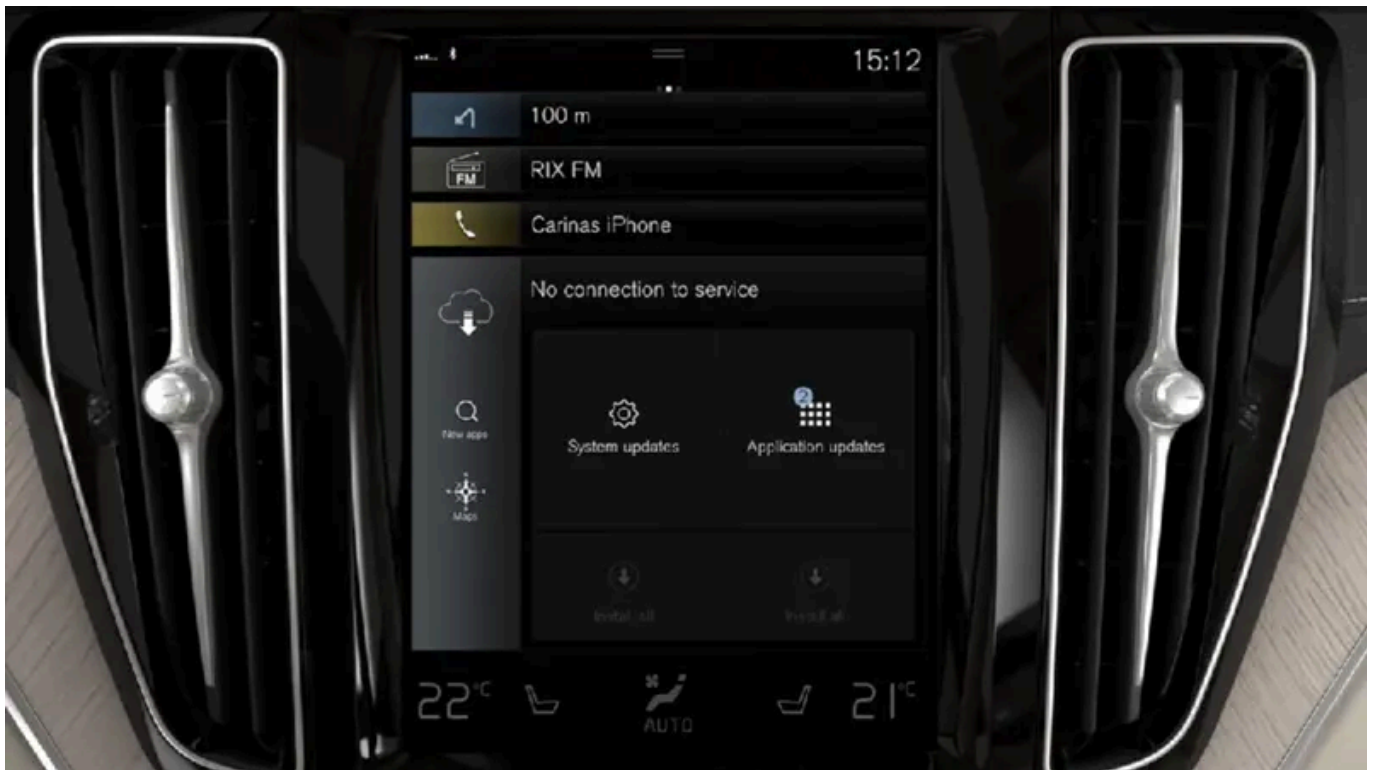

Download Centre is started from the app view in the centre display and enables:

- searching for and updating specific software
- updating map data for Sensus Navigation*
- downloading, updating and uninstalling apps.

^[1] Data is transferred (data traffic) when using the Internet, and this may involve a cost.

* Option/accessory.

18.10.2. Updating software via Download Centre

Some software, e.g. apps and maps, can be updated via Download Centre if the car is connected to the internet^[1].

The message **New software updates available See Download Center** is shown in the centre display's status bar when a new software update is available.

Search for updates



- 1 Go to **Download Centre** in the centre display's app view.
 - A search is started. If a new search has already been made since start-up, the system needs to be restarted before a new search can be made. If an installation is already in progress, no search is made.
Select software area to view which updates are available.

Starting an update

- 1 Select one of the installation options in the Download Centre's list of available updates.
 - Download of selected software starts.
The update can be cancelled during the download phase by pressing the cross next to the selected software. When the download is finished and the installation has started, it is no longer possible to cancel the update.

Note

The speed of other online services may be affected during the download. You can cancel the download and restart it later, or prioritise the update by switching off other online services, such as Internet radio.

Note

If you switch off the ignition and leave the car, the update resumes next time you use the car.

^[1] Data is transferred (data traffic) when using the Internet, and this may involve a cost.

18.10.3. Tips in the event of problems with updates via the Download Centre

When the car is connected to the Internet^[1] it is possible to update several of the car's systems directly from the centre display. Here are some frequently asked questions and answers.

No connection to the service

If the **No connection to service** message is shown then this means that the connection to the service is not working. There may be several reasons as to why the connection is not working. A number of possible causes and solutions are listed below.

Your car has no Internet connection

Make sure your car is connected to the Internet by means of one of the following options:

- Wi-Fi
- Bluetooth-connected phone
- Car modem (P-SIM)

Then restart the app by going back to home view, then press **Download Centre**.

The Internet connection is working, but the remote updates service is not available at the moment

Restart the app by going back to home view, then press **Download Centre**. A new search is triggered and the enquiry is sent to the remote updates function. If the error message is displayed repeatedly for more than 12 hours, the service may be temporarily out of action or down for maintenance. If the fault persists for more than 48 hours, contact your Volvo dealer or Volvo Cars Customer Service for more assistance.

The service has been inactive for 12 months

If the **Download Centre** service has not been used for 12 months, it will take longer to start the next time you use the service (approximately 60 seconds). The remote updates service will start more quickly the next time you start it, as long as the service has been used within 12 months.

The car loses its Internet connection while updating

If the car loses its Internet connection while an update is in progress, check the Internet connection and then restart the function.

If an update or download in progress stops responding despite restarting the car

If you experience that an update or download in progress stops responding despite having restarted the car, please visit a workshop^[2] to have this rectified.

Too many apps installed

The space for apps is a maximum of 10 GB. If the memory has been filled it is not possible to perform updates from the car. The memory may be full if you store a lot of music offline, for example. Free up memory by deleting an app or stored offline music lists, for example.

If the infotainment system restarts by itself during an ongoing installation/update

If the car's infotainment system restarts by itself during an ongoing installation of an app or a system update, try to reinstall the app or system update. If you find that this doesn't help, visit a workshop^[2] for further assistance.

If a map update stops in the message **Leave car with engine off to finalise**

If you have completed a map update and get the message **Leave car with engine off to finalise** and the message does not disappear after a restart, visit a workshop^[2] for further assistance. If possible, wait 14 days and the message will disappear by itself.

More help

If you have not received answers to your questions and need more help, contact your Volvo dealer or Volvo Cars Customer Service.

Note

An update may be interrupted when the ignition is switched off and the car left. However, the update does not need to be completed before the car is left as the update will be resumed the next time the car is used.

Note

Data downloading can affect other services such as transfer data, e.g. web radio. If the effect on other services is experienced as problematic, the download can be interrupted. Alternatively, it may be appropriate to switch off or cancel other services.

^[1] Data is transferred (data traffic) when using the Internet, and this may involve a cost.

^[2] An authorised Volvo workshop is recommended.

18.11. Recommended maintenance for camera and radar units

In order that the camera and radar units shall function correctly, they must be kept clear of dirt, ice and snow, and be cleaned regularly with water and car shampoo.

Note

Dirt, ice and snow covering the sensors may cause incorrect warning signals, reduced or no function.

The following illustrations mark out the surfaces to be kept clean – on both the left and right-hand sides of the car.

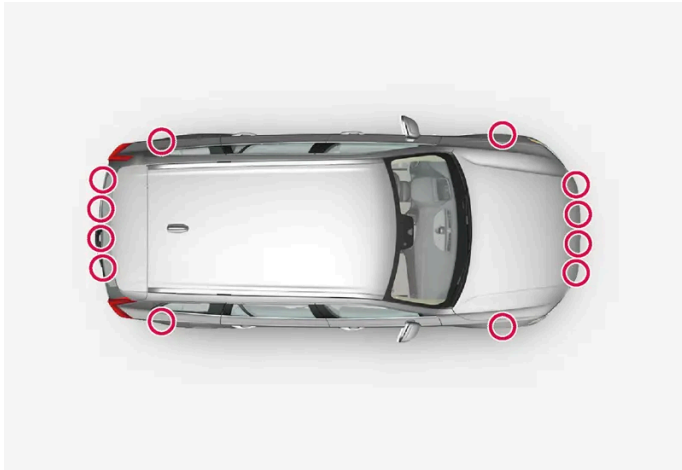

Location of the parking sensors around the car



Location of front camera and radar unit



Location of rear radar units

- To ensure best possible functionality, the surfaces in front of the sensors must be kept clean.
- Do not affix any objects, tape or labels in the area of the sensors.
- Clean camera lenses regularly with lukewarm water and car shampoo - be careful not to scratch the lenses.

 **Important**

Maintenance of driver support components must only be performed at a workshop – an authorised Volvo workshop is recommended.

18.12. Brake system maintenance

Check brake system components regularly for wear.

To keep the car as safe and reliable as possible, follow the Volvo service intervals as specified in the Service and Warranty Booklet. After replacing brake linings and brake discs, braking effect is only adapted after they have been "worn in" for a few hundred kilometres (miles). Compensate for the reduced braking effect by depressing the brake pedal harder. Volvo recommends only fitting brake linings that are approved for your Volvo.

 **Important**

The wear on the brake system's components must be checked regularly.

Contact a workshop for information about the procedure or engage a workshop to carry out the inspection - an authorised Volvo workshop is recommended.

18.13. Operational disruption

An operational disruption may have different causes and is not necessarily due to a direct fault.

Some functions have limitations in special situations and circumstances, or require that certain conditions are fulfilled in order to work. The driver display and centre display may show messages in order to inform about such events.

Find out more about fault-tracing and the limitations of various functions in related articles below.

If the car is not drivable

Activate the hazard warning flashers if the car has broken down or been forced to stop unexpectedly in a trafficked environment. Think about safety. If possible, move the car out of danger from traffic. Put on a reflective vest and then position the warning triangle so that other road users are warned in good time. Call roadside assistance.

18.14. Data transfer between car and workshop via Wi-Fi

Volvo's workshops have a specific Wi-Fi network for data transfer between your car and the workshop. Your workshop visit will be simpler and more efficient when the transfer of diagnostic information and software can take place via the workshop's network.

During a workshop visit, your service technician may want to connect your car to the workshop's network via Wi-Fi to perform fault-tracing and update software. For this type of communication, the car only connects to a workshop's network. It is not possible to connect the car to another Wi-Fi network, such as at home, in the same way as to a workshop's network.

Connection with the remote control key

Connection is normally handled by the service technician who then uses the remote control key buttons. That's why it's important to take a key with buttons with you for the workshop visit. Press three times on the lock button on the remote control key to connect the car to the workshop's network via Wi-Fi.

When the car is connected to a Wi-Fi network, the  symbol appears in the centre display.

Warning

The car must not be driven when connected to the workshop's networks and systems.

18.15. Raise the car

When raising the car, it is important that the jack is fitted in the intended points on the car's underbody.



The triangles in the plastic cover indicate the locations of the lifting points (marked in red).

Note

Volvo recommends only using the jack that belongs to the car model in question. If a jack is selected other than the one recommended by Volvo, follow the instructions supplied with the equipment.

The normal car jack is only designed for occasional, short-term use, such as when changing a wheel after a puncture. If the car is to be jacked up more often, or for a longer time than is required just to change a wheel, use of a garage jack is recommended. In this instance, follow the instructions for use that come with the equipment.

 **Warning**

- Apply the parking brake and set the gear selector in Park position (P).
- Chock the wheels standing on the ground using solid wood blocks or large stones.
- Check that the jack is not damaged, that the threads are thoroughly lubricated and that it is free from dirt.
- Check that the jack is resting on a firm, level surface that is not slippery and is not slanted.
- The jack must be correctly attached in the jack's bracket.
- Never position anything between the ground and the jack, nor between the jack and the car's jacking point.
- Passengers must leave the car when it is raised on the jack.
- If a wheel must be changed in a trafficked environment, passengers must stand in a safe place.
- Use a jack designed for the car when changing tyres. Use supports to secure the car for all other work.
- Never crawl under the car or reach under with a part of your body when it is raised on a jack.

 **Warning**

If the car is raised using a workshop jack, this must be placed beneath one of the four jacking points. Take care to position the workshop jack so that the car cannot slip off. Make sure that the jack plate is fitted with a rubber guard so that the car remains stable and is not damaged. Always use axle stands or similar.

When not in use, the jack* should be stored in its stowage space under the cargo area floor.

Read through all instructions before beginning. Take out the tools needed before jacking up the car.

- 1 Set up the warning triangle and activate the hazard warning lights if, for example, a tyre is being changed in a trafficked location.
- 2 Apply the parking brake and engage gear position P, or engage first gear if the car has a manual gearbox.

 **Note**

Applies to cars with level control*: If the car is equipped with air suspension, this must be disabled before the car is raised.

- 3 Chock in front of and behind the wheels that remain on the ground. Use, for example, heavy wooden blocks or large stones.
- 4 Position the jack or the lift arms at the designated spots of the car's undercarriage. The triangle markings in the plastic cover indicate the locations of the jacking/lifting points. There are two jacking points on each side of the car. There is a re-

cess for the jack at each point.



- 5 Position the jack on level, firm and non-slippery ground under the jacking point that will be used.
- 6 Crank up until it is correctly aligned and so that it makes contact with the car's jacking point. Check that the head of the jack (or lifting arms at a workshop) is correctly positioned in the jacking point so that the bump in the centre of the head fits into the jacking point hole, and check that the base of the jack is positioned vertically below the jacking point.
- 7 Turn the jack so that the crank is as far away from the side of the car as possible, at which point the jack's arms are perpendicular to the direction of the car.
- 8 Raise the car high enough to perform the intended measure.

* Option/accessory.

19. Specifications

19.1. Dimensions and weights

19.1.1. Towing capacity and towball load

Towing capacity and towball load for driving with a trailer can be read in the tables.

Max. weight braked trailer

 **Note**

Use of vibration dampers on the towbar is recommended for trailers heavier than 1800 kg.

Engine	Engine code ^[1]	Gearbox	Max. weight braked trailer (kg)	Max. towball load (kg)
T8 Recharge	B4204T34	Automatic	2400	110
T8 Recharge	B4204T35	Automatic	2400	110
T8 Recharge	B4204T28	Automatic	2400	110

 **Important**

When driving with a trailer, it is permitted to exceed the vehicle's gross vehicle weight (including towball load) by a maximum of 100 kg (220 lbs), provided that speed is limited to 100 km/h (62 mph). National legal requirements for the vehicle combination, such as speed, etc. must be observed.

 **Note**

If there is no weight data in the table, this is available in an enclosed supplement.

Max. weight unbraked trailer

Unbraked trailer	
Max. weight (kg)	750
Max. towball load (kg)	50

^[1] The engine code, component number and serial number can be found on the engine.

19.1.2. Dimensions

Measurement of car length, height, etc. can be read in the table.

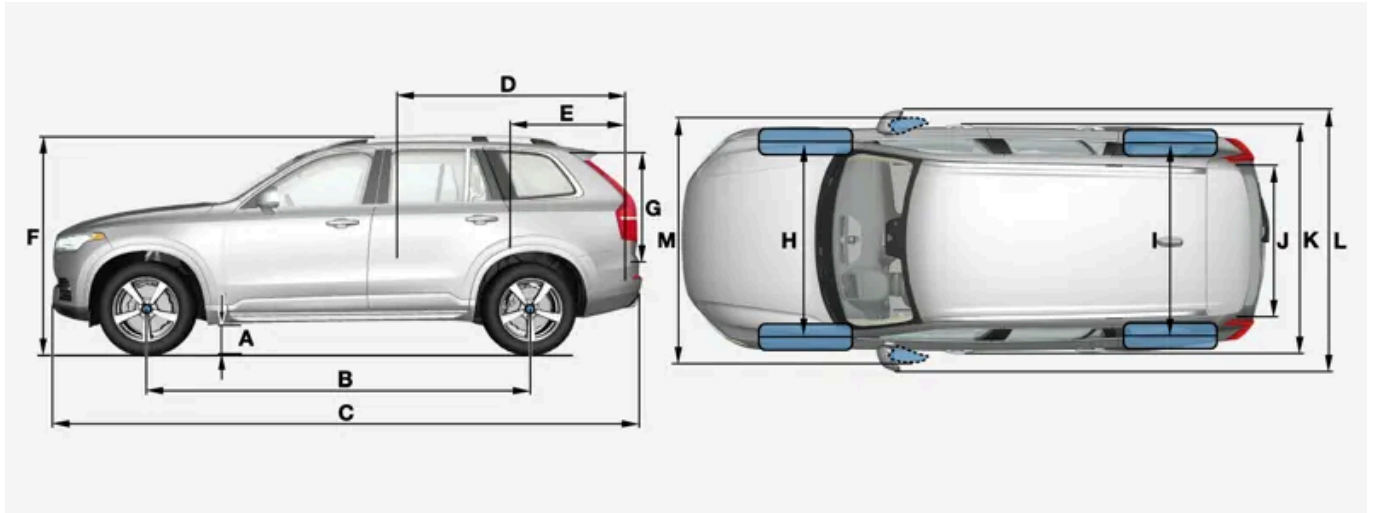

Dimensions		mm	inches
A	Ground clearance ^[1]	217 ^{[2],[3]}	8,5 ^{[2],[3]}
B	Wheelbase	2984	117,5
C	Length	4953	195,0
D	Load length, floor, folded seat	2040 1260 ^[4] 1260 ^[5]	80,3 49,6 ^[4] 49,6 ^[5]
E	Load length, floor	554 ^[3] 554 ^[2]	21,8 ^[3] 21,8 ^[2]
F	Height ^[6]	1776 ^{[2],[3]}	69,9 ^{[2],[3]}
G	Load height	816	32,1
H	Front track ^[7]	1665 ^[8] 1673 ^[9]	65,6 ^[8] 65,9 ^[9]
	Front track ^[10]	1668 ^[8] 1676 ^[9]	65,7 ^[8] 66,0 ^[9]
I	Rear track ^[7]	1667 ^[8] 1675 ^[9]	65,6 ^[8] 65,9 ^[9]
	Rear track ^[10]	1671 ^[8] 1679 ^[9]	65,8 ^[8] 66,1 ^[9]
J	Load width, floor	1192	46,9
K	Width	1923 ^[11]	75,7 ^[11]
		1931 ^[12]	76,0 ^[12]
		1958 ^[13]	77,1 ^[13]
L	Width including door mirrors	2140	84,3
M	Width including folded-in door mirrors	2008	79,1

[1] At kerb weight plus 1 person. (Varies slightly depending on tyre dimension, chassis option, etc.)

[2] Car with 7 seats.

[3] Car with 6 seats.

* Option/accessory.

[4] From the second seat row in a car with 6 seats*.

[5] From the second seat row in a car with 7 seats*.

[6] Including roof antenna, for kerb weight.

[7] Car without air suspension.

[8] Applies to cars with 19 inch wheels.

[9] Applies to cars with 20, 21 and 22 inch wheels.

[10] Car with air suspension.

[11] Body width.

[12] Width for car with 19-inch wheels.

[13] Width for car with 20-, 21- and 22-inch wheels.

19.1.3. Weights

Max. gross vehicle weight, etc. can be read on a label in the car.

Kerb weight includes the driver, the fuel tank 90% full, plus and all oils and fluids.

The weight of passengers and accessories, and towball load (when a trailer is hitched) influence the load capacity and are not included in the kerb weight.

Permitted max. load = Gross vehicle weight - Kerb weight.

Note

The documented kerb weight applies to cars in the standard version - i.e. a car without extra equipment or accessories. This means that for every accessory added the loading capacity of the car is reduced correspondingly by the weight of the accessory.

Examples of accessories that reduce load capacity are the different equipment levels (e.g. Kinetic, Momentum, Summum), as well as other accessories such as towbar, load carrier, space box, audio system, auxiliary lamps, GPS, fuel-driven heater, safety grille, carpets, cargo cover, power seats, etc.

Weighing the car is a certain way of ascertaining the kerb weight of your own particular car.

 **Warning**

The car's driving characteristics change depending on how heavily it is loaded and how the load is distributed.

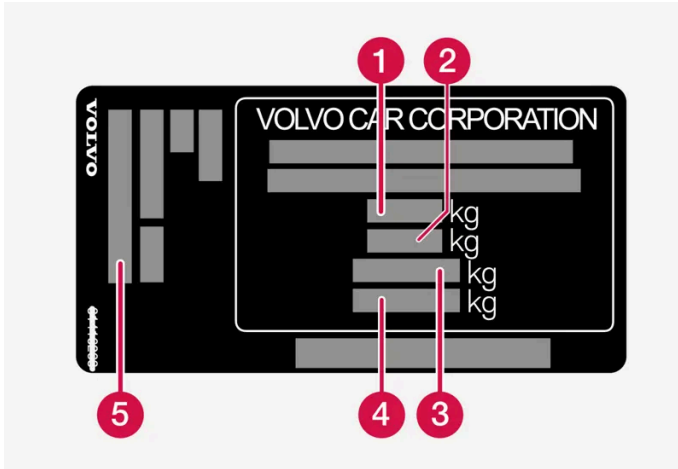

The decal is positioned on the door pillar, and will be visible when the right-hand rear door is opened.

- 1 Max. gross vehicle weight
- 2 Max. train weight (car+trailer)
- 3 Max. front axle load
- 4 Max. rear axle load
- 5 Equipment level

Max. load: See registration document.

Max. roof load: 100 kg.

19.1.4. Specifications for towbar*

Dimensions and mounting points for towbar.

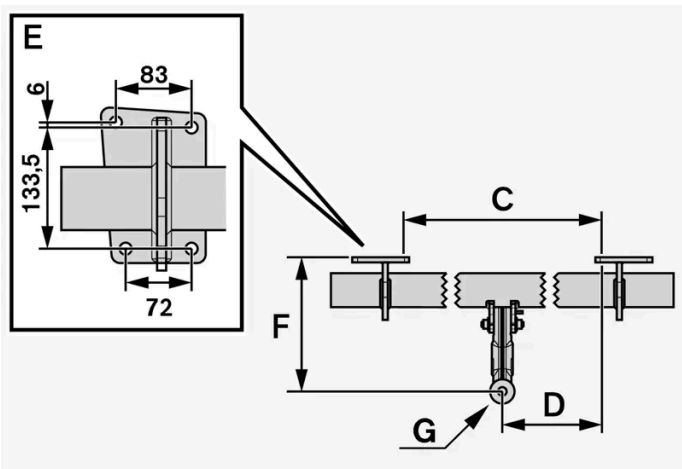
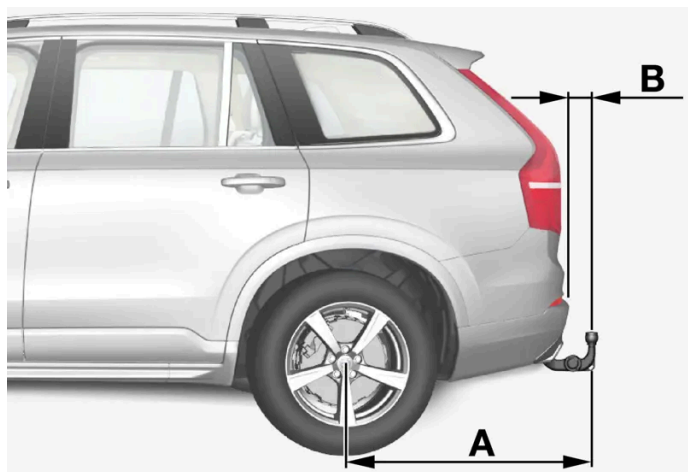

Dimensions, mounting points in mm (inches)	
A	1476 (58,1)
B	86 (3,4)
C	875 (34,4)
D	437,5 (17,2)
E	See the image above
F	273 (10,7)
G	Ball centre

* Option/accessory.

19.2. Specifications for engine

19.2.1. Engine specifications

Engine specifications (power, etc.) for each respective engine alternative can be found in the table below. The Recharge variant is driven both by a petrol engine and an electric drive motor (ERAD – Electric Rear Axle Drive).

Note

Not all engines are available in all markets.

Note

If there is no engine data in the table, this is available in an enclosed supplement.

Engine	Engine code ^[1]	Output (kW/rpm)	Output (hp/rpm)	Max. rated power (kW/rpm)	Max. rated power (hp/rpm)	Torque (Nm/rpm)	No. of cylinders
T8 Recharge	B4204T34	223/6000	303/6000	248/6000	337/6000	400/2200–4800	4
T8 Recharge	B4204T35	235/5700	320/5700	–	–	400/2200-5400	4
T8 Recharge	B4204T28	233/6000	318/6000	–	–	400/2200-5400	4

Electric drive motor

Max. power output: 65 kW (87 hp).

Torque: 240 Nm.

^[1] The engine code, component number and serial number can be found on the engine.

19.2.2. Adverse driving conditions for engine oil

Adverse driving conditions can lead to abnormally high oil temperature or oil consumption. Below are some examples of adverse driving conditions.

Check the oil level more frequently for long journeys:

- towing a caravan or trailer
- in mountainous regions
- at high speeds
- in temperatures colder than -30 °C (-22 °F) or hotter than +40 °C (+104 °F).

The above also apply to shorter driving distances at low temperatures.

Choose a fully synthetic engine oil for adverse driving conditions. It provides extra protection for the engine.

Volvo recommends:



! Important

In order to fulfil the requirements for the engine's service intervals all engines are filled with a specially adapted synthetic engine oil at the factory. The choice of oil has been made very carefully with regard to service life, starting characteristics, fuel consumption and environmental impact.

An approved engine oil must be used in order that the recommended service intervals can be applied. Only use a prescribed grade of oil for both filling and oil change, otherwise there is a risk of the service life, starting characteristics, fuel consumption and environmental impact of the car being affected.

If engine oil of the prescribed grade and viscosity is not used, engine related components may become damaged. Volvo disclaims any liability for any such damage.

Volvo recommends that oil changes are carried out at an authorised Volvo workshop.

19.2.3. Engine oil — specifications

Engine oil grade and volume for each respective engine alternative can be read in the table.

Volvo recommends:



Engine	Engine code ^[1]	Oil grade	Volume, incl. oil filter (litres, approx.)
T8 Recharge	B4204T34	Castrol Edge Professional V 0W-20 or VCC RBS0-2AE 0W-20	5.6
T8 Recharge	B4204T35		5.6
T8 Recharge	B4204T28		5.6

^[1] The engine code, component number and serial number can be found on the engine.

19.3. Specifications for fluids and lubricants

19.3.1. Topping up washer fluid

Washer fluid is used for cleaning the headlamps as well as the windscreen and rear window. Washer fluid with antifreeze must be used when the temperature is under the freezing point.

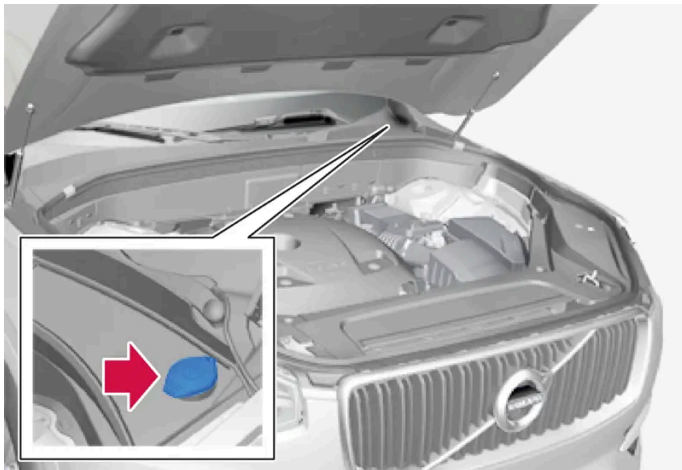

Washer fluid is filled into the reservoir with the blue cap. The reservoir is used for windscreen washer, rear window washer and headlamp washers*.

Note

When approx. 1 litre (1 qt) of washer fluid remains in the reservoir, the message **Washer fluid Level low, refill** is shown in the driver display, together with the  symbol.

Prescribed grade: Washer fluid recommended by Volvo – with frost protection during cold weather and for temperatures below freezing point.

Important

Use Volvo genuine washer fluid or equivalent with a recommended pH of between 6 and 8, in working dilution (e.g. 1:1 with neutral water).

Important

Use washer fluid with antifreeze when the temperature is below freezing to avoid the fluid freezing inside the pump, reservoir and hoses.

Volume:

- Cars **with** headlamp washing: 5.5 litres (5.8 qts).

The content of this manual represents the status of the user manual at the time of printing and may not be completely valid in future instances. For more information, refer to the first page for the complete disclaimer note.

- Cars **without** headlamp washing: 3.5 litres (3.7 qts).

* Option/accessory.

19.3.2. Air conditioning — specifications

The car's climate control system uses a freon-free refrigerant, either R1234yf or R134a, depending on market. Information about which refrigerant the car's climate control system uses is printed on a decal located on the underside of the bonnet.

Refrigerant and compressor oil are used in the air conditioning system. Information is shown below about the label for refrigerant quantity, and the table below shows the prescribed quality and volume for compressor oil.

A/C decal

Decal for R134a



Decal for R1234yf

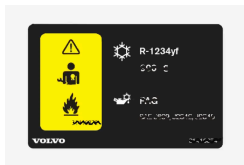

Symbol explanation R1234yf

Symbol	Meaning
	Caution
	Mobile air conditioning system (MAC)
	Lubricant type
	A trained and certified technician is required in order to service the mobile air conditioning system (MAC)
	Flammable refrigerants

Refrigerant

Refrigerant amount is printed on the decal located on the underside of the bonnet.

Cars with R134a refrigerant



1 Refrigerant amount.

Warning

The air conditioning system contains pressurised refrigerant R134a. This system must only be serviced and repaired by an authorised workshop.

Cars with R1234yf refrigerant

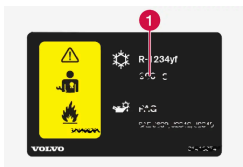

1 Refrigerant amount.

Warning

The air conditioning system contains pressurised refrigerant R1234yf. In accordance with SAE J2845 (Technician Training for Safe Service and Containment of Refrigerants Used in Mobile A/C System), service and repair of the refrigerant system must only be performed by trained and certified technicians in order to ensure the safety of the system.

Compressor oil

Volume	Prescribed grade
120 ml (4.06 fl. oz.)	PAG SP-A2

Evaporator^[1]

Important

The A/C system's evaporator must never be repaired or replaced with a previously used evaporator. A new evaporator must be certified and labelled in accordance with SAE J2842.

[1] Only applies to cars with R1234yf refrigerant

19.3.3. Brake fluid – specifications

Brake fluid is the medium in a hydraulic brake system that is used to transfer pressure from e.g. a brake pedal via a master brake cylinder, which in turn acts on the brake callipers.

Prescribed grade: Volvo Original or equivalent fluid compliant with a combination of Dot 4, 5.1 and ISO 4925 class 6.

Note

It is recommended that brake fluid is changed or filled by an authorised Volvo workshop.

19.3.4. Transmission fluid – specifications

Under normal driving conditions, the transmission fluid does not need to be changed during the service life of the gearbox. However, it may be necessary in adverse driving conditions.

Automatic gearbox

Prescribed transmission fluid:	AW-1
--------------------------------	------

19.3.5. Fuel tank - volume

The fuel tank's filling capacity can be read in the table below.

	All engines
Litres (approx)	70
US gallons (approx)	18.5

19.3.6. Adverse driving conditions for engine oil

Adverse driving conditions can lead to abnormally high oil temperature or oil consumption. Below are some examples of adverse driving conditions.

Check the oil level more frequently for long journeys:

- towing a caravan or trailer
- in mountainous regions
- at high speeds
- in temperatures colder than -30 °C (-22 °F) or hotter than +40 °C (+104 °F).

The above also apply to shorter driving distances at low temperatures.

Choose a fully synthetic engine oil for adverse driving conditions. It provides extra protection for the engine.

Volvo recommends:



 **Important**

In order to fulfil the requirements for the engine's service intervals all engines are filled with a specially adapted synthetic engine oil at the factory. The choice of oil has been made very carefully with regard to service life, starting characteristics, fuel consumption and environmental impact.

An approved engine oil must be used in order that the recommended service intervals can be applied. Only use a prescribed grade of oil for both filling and oil change, otherwise there is a risk of the service life, starting characteristics, fuel consumption and environmental impact of the car being affected.

If engine oil of the prescribed grade and viscosity is not used, engine related components may become damaged. Volvo disclaims any liability for any such damage.

Volvo recommends that oil changes are carried out at an authorised Volvo workshop.

19.3.7. Engine oil — specifications

Engine oil grade and volume for each respective engine alternative can be read in the table.

Volvo recommends:



Engine	Engine code ^[1]	Oil grade	Volume, incl. oil filter (litres, approx.)
T8 Recharge	B4204T34	Castrol Edge Professional V 0W-20 or VCC RBS0-2AE 0W-20	5.6
T8 Recharge	B4204T35		5.6
T8 Recharge	B4204T28		5.6

^[1] The engine code, component number and serial number can be found on the engine.

19.4. Specifications for wheels and tyres

19.4.1. Approved tyre pressures

Approved tyre pressures for each engine alternative can be found in the table.

Note

All engines, tyres or combinations of these are not always available in all markets.

Engine	Tyre size	Speed	Load, 1-3 persons		Max. load		ECO pressure ^[1]
			Front kPa (psi) ^[2]	Rear kPa (psi)	Front kPa (psi)	Rear kPa (psi)	Front/rear kPa (psi)
All engines	235/55 R19 275/45 R20	0-160 km/h (0-100 mph)	260 (38)	260 (38)	290 (42)	290 (42)	290 (42)
	275/40 R21 275/35 R22	160+ km/h (100+ mph)	280 (41)	280 (41)	310 (45)	310 (45)	–

^[1] Economical driving.

^[2] In certain countries the "bar" unit is used alongside the SI unit "Pascal": 1 bar = 100 kPa.

19.4.2. Approved wheel and tyre sizes

In certain countries not all approved sizes are indicated by the registration document or other documents. The following table shows all approved combinations of wheel rims and tyres.

✓ = Approved

Engine	man/ aut	235/55 R 19 8x19x42.5	275/45 R 20 ^[1] 9x20x38.5	275/40 R 21 ^[1] 9x21x38.5	275/35 R 22 ^[1] 9x22x38.5
All engines	aut	✓	✓	✓	✓

^[1] Only in combination with wheel arch extension.

19.4.3. Minimum permitted tyre load index and speed rating for tyres

The table below shows minimum permitted load index (LI) and speed rating (SS).

Engine	man/ aut	Minimum permitted load index (LI) ^[1]	Minimum permitted speed rating (SS) ^[2]
All engines	aut	103	H

^[1] The tyre's load index must be at least equal to or greater than indicated in the table.

^[2] The tyre's speed rating must be at least equal to or greater than indicated in the table.

19.5. Type designations

The decals in the car contain information such as chassis number, type designation, colour code, etc.

Label location



The figure is schematic - parts may vary depending on market and model.

Knowing the car's type designation, vehicle identification and engine numbers can facilitate contact with a Volvo dealer regarding the car and when ordering spare parts and accessories.

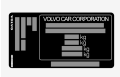

1 Decal for type designation, vehicle identification number, permissible maximum weights and code designation for exterior colour and type approval number. The decal is positioned on the door pillar, and will be visible when the right-hand rear door is opened.



2 Decal for A/C system for cars with refrigerant R1234yf.



2 Decal for A/C system for cars with refrigerant R134a.



3 Label for parking heater.



4 Decal for engine code and the engine's serial number. For certain engine alternatives there is no decal. In these cases, the engraved engine code can be read directly on the engine instead.



5 Label for engine oil.



6 Decal for gearbox type designation and serial number.



7 Decal for the car's identification number - VIN (Vehicle Identification Number). The decal is located on the top left-hand part of the instrument panel and is visible through the windscreen.

Further information on the car is presented in the registration document.

Note







It is not intended that the decals illustrated in the owner's manual should be exact replicas of those in the car. They are included to show their approximate appearance and locations in the car. The information that applies to your particular car can be found on the decal on the car.

19.6. Fuel consumption and CO₂ emissions

The information in the tables below is in accordance with WLTP (Worldwide Harmonised Light-Duty Vehicles Test Procedure), which is an international test method for vehicles.

The fuel consumption for a vehicle is measured in litres per 100 km and carbon dioxide emissions (CO₂) are measured in gram CO₂ per km.

Explanation	
	Weighted combined value. The value is weighted between electric mode and fuel mode over the entire drive cycle.
CO ₂	Gram CO ₂ /km









	Litres/100 km
	Certified value for the car's potential range ("up to") in km in electric mode. The value should not be interpreted as an expected range, and the range is difficult to achieve during normal driving.
	Urban and suburban driving
	Average value over all four drive cycle phases (urban, suburban, extra-urban and motorway driving)
aut	Automatic gearbox
	Low value
	High value

 **Note**

If there is no consumption and emissions data in the table, this is available in an enclosed supplement.

 **Note**

The capacity of the hybrid battery diminishes with age and use, which may result in increased use of the internal combustion engine and, as a consequence, reduced fuel economy and reduced range during electric operation.

						
			CO ₂			
T8 Recharge(B4204T34)	aut		57	2.5	56 ^[1]	51 ^[1]
			76	3.4	46 ^[1]	44 ^[1]

The values in the table above for fuel consumption, CO₂ emissions, and range for electric mode are based on special drive cycles (see below). The car's weight may increase depending on its equipment level. Together with how heavily the car is loaded, this affects fuel consumption and CO₂ emissions, and reduces its range in electric mode. According to WLTP, each car has unique fuel consumption, CO₂ emission values and electric range values, depending on how the car is equipped. These values range between the low value and high value in the table above. In many markets, you can find your car's unique fuel consumption, CO₂ emission values and electric range values in the car's registration document.

The certified values for the car should not be interpreted as the expected values. The certification values are the comparative values obtained during special drive cycles (see below).

There are several reasons for fuel consumption that is higher and an electric range that is shorter than the values in the table. Examples of these include:

- If the car is not regularly charged from the mains.
- If the car is equipped with extra equipment that affects its weight.
- Driving style.
- If the customer chooses wheels other than those mounted as standard on the basic version of the model, this could increase rolling resistance.

The content of this manual represents the status of the user manual at the time of printing and may not be completely valid in future instances. For more information, refer to the first page for the complete disclaimer note.

- High speed causes increased air resistance.
- Fuel quality, road and traffic conditions, weather and the condition of the car.

A combination of the examples above could increase consumption considerably.

There may be huge deviations in fuel consumption if comparing to the drive cycle profiles (see below), which are used in the certification of the car and on which consumption figures in the table are based. For further information, please refer to the referenced regulations.

 **Note**

Extreme weather conditions, driving with a trailer or driving at high altitudes, in combination with poorer fuel quality than recommended, are factors that considerably increase the car's fuel consumption.

WLTP standard

From and including 1 September 2018, a new standard was introduced for calculating consumption values in the car. The WLTP standard (Worldwide Harmonised Light-Duty Vehicles Test Procedure) represents the average driving conditions for everyday driving. In comparison with the previous standard (NEDC), WLTP takes into account more varied traffic situations and speeds, but also equipment and weight classes. Optional equipment that affects consumption is deactivated during testing, e.g. air conditioning, seat heating, etc. The new standard should provide more realistic figures when it comes to fuel consumption, carbon dioxide and emissions, as well as range for electric operation. The values are intended to allow comparison between different cars and not to represent your typical normal consumption and range for electric mode.

Drive cycle profiles

A drive cycle simulates actual average driving of the car. The standard is based on four different drive cycle profiles, which are as follows:

- **Urban driving** – slow driving
- **Suburban driving** – average speed driving
- **Extra-urban driving** – fast driving
- **Motorway driving** – very fast driving.

Every drive cycle is determined by different conditions such as speed, time and mileage, for example.

The official value for combined driving, which is shown in the table, is a combination of the results from the four drive cycles, in accordance with legal requirements.

The exhaust gases are collected in order to extrapolate the carbon dioxide emissions (CO₂ emissions) during the four drive cycles. These were then analysed to determine the value for CO₂ emissions.

^[1] Drive mode PURE