

EX90 2027 (26w17) User Manual

Version 2026-05-11

Disclaimer

Due to the dynamic nature of our software-based product, the content of this PDF represents the most up-to-date version of the user manual as of the time of printing. As we continuously update and improve our product, certain content may not reflect the most up-to-date information in a future instance. Therefore, we strongly recommend utilizing the digital user manual app in your car's center display for the most accurate and up-to-date information. You can also access information in the Volvo Cars mobile app.

Please note that if you choose to print the manual, we cannot guarantee the validity of the information in future instances, as updates may have occurred since the time of printing. To ensure the highest level of safety and optimal product usage, we strongly advise relying on the digital user manual, which can be easily accessed through your car's center display.

This printable version is generic and does not correspond to your car. If there are discrepancies between this printable manual and the manual you see in your car's center display, the latter takes precedence.

Contents

1. [Consumer information](#)
 - 1.1 [About the user manual](#)
 - 1.1.1 [Reading the user manual](#)
 - 1.2 [Customer support and contact information](#)
 - 1.3 [Driver responsibility](#)
 - 1.4 [Warranty information](#)
 - 1.5 [Modifications, repairs and accessory installations](#)
 - 1.6 [About Volvo's components](#)
 - 1.7 [Certified technicians](#)
 - 1.8 [Information about recalls](#)
 - 1.9 [Reporting safety defects](#)
 - 1.10 [Finding the vehicle identification number](#)
 - 1.11 [Approval of terms and conditions and data collection](#)
 - 1.12 [Handling of recorded and collected data](#)
 - 1.13 [About connected services and the fair use policy](#)
 - 1.14 [Changing ownership of the vehicle](#)
 - 1.15 [Resetting user data](#)
 - 1.16 [Recommendations when changing regions](#)
2. [User accounts, profiles and services](#)
 - 2.1 [Setting up your vehicle for the first time](#)
 - 2.2 [Volvo ID](#)
 - 2.2.1 [Creating a Volvo ID](#)
 - 2.3 [Volvo Cars app](#)
 - 2.4 [Getting started with Google services](#)
 - 2.5 [Customization and settings](#)
 - 2.6 [Vehicle user profiles](#)
 - 2.6.1 [Switching profiles](#)
 - 2.6.2 [Adding a profile](#)
 - 2.6.3 [Removing a profile](#)
 - 2.6.4 [Assigning a key to a profile](#)
 - 2.6.5 [Managing keys assigned to profiles](#)

- 2.6.6 Restricting access to a profile
 - 2.6.7 Adding an account to a profile
 - 2.7 Volvo Assistance
 - 2.7.1 Calling Volvo Assistance for roadside assistance
 - 2.8 Emergency assistance
 - 2.8.1 Calling emergency services with SOS button
 - 2.8.2 Changing the emergency call recipient
 - 2.9 HomeLink
- 3. Displays, software and phone
 - 3.1 Displays
 - 3.1.1 Center display
 - 3.1.1.1 Center display views
 - 3.1.1.2 Status symbols in the center display
 - 3.1.1.3 Keyboard
 - 3.1.1.3.1 Changing the keyboard language
 - 3.1.1.3.2 Adding and removing keyboard languages
 - 3.1.2 Instrument panel
 - 3.1.2.1 Warning and indicator symbols
 - 3.1.2.2 Battery meter
 - 3.1.2.3 Power meter
 - 3.1.3 Head-up display
 - 3.1.3.1 Adjusting the head-up display
 - 3.1.4 System settings
 - 3.1.4.1 Changing time and date
 - 3.1.4.2 Changing the system language
 - 3.1.4.3 Changing system units
 - 3.1.5 Restarting the displays
 - 3.2 Phone
 - 3.2.1 Connecting your phone to the vehicle
 - 3.2.2 Using your phone in the vehicle
 - 3.2.3 Switching between paired phones
 - 3.2.4 Apple CarPlay
 - 3.2.4.1 Connecting your iPhone to Apple CarPlay
 - 3.2.5 Android Auto™
 - 3.2.5.1 Connecting your Android™ phone to Android Auto™
 - 3.3 Sound and media
 - 3.3.1 Radio
 - 3.3.1.1 Adding radio favorites
 - 3.3.2 Sound settings
 - 3.3.3 Media players
 - 3.4 In-vehicle apps
 - 3.4.1 Downloading apps
 - 3.4.2 Uninstalling apps
 - 3.5 Connectivity and software
 - 3.5.1 Internet connection
 - 3.5.1.1 Connecting to the internet via a Bluetooth-connected phone
 - 3.5.1.2 Connecting to the internet via Wi-Fi
 - 3.5.2 Over-the-air updates
 - 3.6 Voice control
 - 3.6.1 Using voice control
- 4. Interior comfort and climate
 - 4.1 Interior

- 4.1.1 Using the wireless charger
- 4.1.2 Enabling the wireless charger
- 4.1.3 USB ports
- 4.1.4 12 V socket
- 4.1.5 Sun visors
- 4.2 Comfort
- 4.3 Climate
 - 4.3.1 Climate controls
 - 4.3.1.1 Activating seat heating
 - 4.3.1.2 Activating seat ventilation
 - 4.3.1.3 Activating the steering wheel heating
 - 4.3.2 Climate settings
 - 4.3.3 Temperature and air conditioning
 - 4.3.3.1 Activating air conditioning
 - 4.3.3.2 Setting the temperature
 - 4.3.3.3 Synchronizing temperature
 - 4.3.3.4 Activating eco climate
 - 4.3.4 Air distribution and climate modes
 - 4.3.4.1 Adjusting air vents
 - 4.3.4.2 Activating auto climate mode
 - 4.3.4.3 Activating manual climate mode
 - 4.3.5 Ice, condensation and defrosters
 - 4.3.5.1 Activating max defroster
 - 4.3.5.2 Activating rear windshield and door mirror heating
 - 4.3.6 Interior climate when parked
 - 4.3.6.1 Setting the preconditioning timer
 - 4.3.6.2 Keeping climate active while parked
 - 4.3.6.3 Air purification
 - 4.3.7 Air quality
 - 4.3.7.1 Air quality indication
 - 4.3.7.2 Air cleaning
 - 4.3.7.2.1 Advanced air cleaning
 - 4.3.7.2.2 Focused air cleaning
 - 4.3.7.2.2.1 Activating focused air cleaning
 - 4.3.7.3 CleanZone
 - 4.3.7.4 Activating air recirculation
 - 4.3.8 Climate system
 - 4.3.8.1 Climate zones
 - 4.3.8.2 Partial climate
 - 4.3.8.3 Perceived and actual temperature
 - 4.3.8.4 Climate sensors
 - 4.3.8.5 Heaters
- 4.4 Windows and glass panes
 - 4.4.1 Operating the windows
 - 4.4.2 Adjusting roof tint
 - 4.4.3 Pinch protection
 - 4.4.4 Resetting windows
- 4.5 Seats
 - 4.5.1 Front seats
 - 4.5.1.1 Adjusting the front seats
 - 4.5.1.2 Resetting the front seat positions
 - 4.5.1.3 Activating seat massage

- 4.5.1.4 Extending the seat cushion
 - 4.5.2 Second-row seats
 - 4.5.2.1 Adjusting second-row seats
 - 4.5.2.2 Folding down the second-row seats
 - 4.5.3 Third-row seats
 - 4.5.3.1 Getting in and out of the third row
 - 4.5.3.2 Folding down the third-row seats
 - 4.6 Interior lighting
 - 4.6.1 Adjusting the reading lights
 - 4.6.2 Adjusting interior lights
 - 4.6.3 Disabling interior auto lights
 - 4.6.4 Activating all interior lights
- 5. Safety
 - 5.1 Collision response
 - 5.1.1 Pedestrian protection system
 - 5.2 Occupant detection
 - 5.3 Proper seating
 - 5.4 Seat belts
 - 5.4.1 Fastening and adjusting seat belt
 - 5.4.2 Setting seat belt to only retract
 - 5.4.3 Seat belt reminder
 - 5.5 Airbags
 - 5.5.1 Airbag deployment
 - 5.5.2 Front airbags
 - 5.5.2.1 Sensor-controlled passenger airbag status
 - 5.5.3 Side airbags
 - 5.5.4 Inflatable curtains
 - 5.5.5 Airbag maintenance and servicing
 - 5.5.6 Airbag labels
 - 5.6 Child safety
 - 5.6.1 Child restraints
 - 5.6.1.1 Installing child restraints
 - 5.6.1.1.1 Installing child restraints on the second-row seats
 - 5.6.1.1.2 Installing child restraints on the third-row seats
 - 5.6.1.2 Child restraint attachment points
 - 5.6.1.2.1 ISOFIX/LATCH attachment points
 - 5.6.1.2.2 Top tether attachment points
 - 5.6.1.2.3 Lower tether attachment points
- 6. Entry and security
 - 6.1 Keys
 - 6.1.1 Key tag
 - 6.1.1.1 Charging the key tag
 - 6.1.2 Key card
 - 6.1.3 Digital key
 - 6.1.3.1 Creating a digital key
 - 6.1.3.2 Deleting a digital key
 - 6.1.4 Key reading locations
 - 6.2 Opening and closing
 - 6.2.1 Opening the hood
 - 6.2.2 Closing the hood
 - 6.2.3 Trunk access
 - 6.2.3.1 Opening the trunk hands-free

- 6.2.3.2 Adjusting trunk opening height
- 6.3 Locking and unlocking
 - 6.3.1 Activating child lock
 - 6.3.2 Settings for locking and unlocking
 - 6.3.2.1 Adjusting locking and unlocking settings
 - 6.3.3 Unresponsive lock
- 6.4 Anti-theft
 - 6.4.1 Alarm
 - 6.4.1.1 Reducing alarm sensitivity
- 7. Charging your vehicle
 - 7.1 Charging types
 - 7.1.1 Charging cables
 - 7.2 Charging view and settings
 - 7.2.1 Setting a target battery level for charging
 - 7.2.2 Setting the amperage limit for charging
 - 7.2.3 Adding and managing charging schedules
 - 7.2.4 Setting a minimum battery level for charging
 - 7.2.5 Plug & Charge
 - 7.2.5.1 Activating Plug & Charge
 - 7.3 Starting and stopping charging
 - 7.3.1 Starting AC charging
 - 7.3.2 Starting DC charging
 - 7.3.3 Stopping AC charging
 - 7.3.4 Stopping DC charging
 - 7.3.5 Releasing the charging cable
 - 7.3.5.1 Using the emergency release handle for the charging cable
 - 7.4 Charging time and statuses
 - 7.4.1 Charging times
 - 7.4.1.1 Manually activating battery preconditioning
 - 7.4.2 Charging status
 - 7.4.2.1 Charging status in the charging port
 - 7.4.2.2 Charging status in the instrument panel
- 8. Driving
 - 8.1 A typical driving cycle
 - 8.2 Trips app
 - 8.3 Starting the vehicle
 - 8.3.1 Startup checks
 - 8.4 Turning the vehicle off
 - 8.5 Driving characteristics
 - 8.5.1 Drive modes
 - 8.5.1.1 Selecting a drive mode
 - 8.5.2 One Pedal Drive
 - 8.5.2.1 Adjusting One Pedal Drive
 - 8.5.3 Stability control
 - 8.5.4 Suspension
 - 8.5.4.1 Adjusting suspension feel
 - 8.6 Range
 - 8.6.1 Range and trip
 - 8.6.1.1 Resetting the trip meter
 - 8.7 Steering
 - 8.7.1 Steering wheel
 - 8.7.1.1 Steering wheel controls

- 8.7.1.2 Adjusting the steering wheel position
 - 8.7.2 Adjusting steering feel
- 8.8 Brakes
 - 8.8.1 Foot brake
 - 8.8.2 Parking brake
 - 8.8.2.1 Engaging the parking brake
 - 8.8.3 Auto hold
 - 8.8.4 Post-impact braking
- 8.9 Selecting the gear
- 9. Visibility, mirrors, and exterior lights
 - 9.1 Exterior lights
 - 9.1.1 Driving lights
 - 9.1.1.1 Selecting a primary lighting mode
 - 9.1.1.2 High beam
 - 9.1.1.2.1 Operating the high beam
 - 9.1.1.3 Operating the turn signals
 - 9.1.1.4 Cornering lights
 - 9.1.1.5 Activating the rear fog light
 - 9.1.1.6 Hazard warning lights
 - 9.1.1.6.1 Activating the hazard warning flashers
 - 9.1.2 Exterior convenience lights
 - 9.1.2.1 Enabling the welcome lights
 - 9.2 Mirrors
 - 9.2.1 Adjusting door mirrors
 - 9.3 Wipers and washers
 - 9.3.1 Controlling the front wipers
 - 9.3.2 Controlling the rear wiper
 - 9.3.3 Activating washers
- 10. Driver support and navigation
 - 10.1 Navigation
 - 10.1.1 Finding and selecting a navigation destination
 - 10.2 Detection of surroundings and traffic
 - 10.2.1 Locations of cameras, sensors and radar units
 - 10.2.2 Camera detection and limitations
 - 10.2.3 Radar detection and limitations
 - 10.2.4 Parking sensor detection and limitations
 - 10.3 Driver behavior detection
 - 10.4 Safety interventions and warnings
 - 10.4.1 Collision warnings and mitigation
 - 10.4.2 Interventions and warnings when reversing
 - 10.4.2.1 Alerts about traffic crossing behind the vehicle
 - 10.4.2.2 Disabling automatic braking when reversing
 - 10.4.3 Lane keeping aid
 - 10.4.3.1 Adjusting lane keeping aid
 - 10.4.4 Blind spot information
 - 10.4.5 Door opening alerts
 - 10.4.6 Driver alert
 - 10.4.6.1 Disabling distraction alert notifications
 - 10.4.7 Connected safety
 - 10.4.7.1 Enabling connected safety
 - 10.4.8 Emergency stop assist
 - 10.5 Assisted driving

- 10.5.1 Road signs and speeding response
 - 10.5.1.1 Speed limit warnings
 - 10.5.1.1.1 Adjusting speed limit warnings
 - 10.5.1.2 Road sign information
 - 10.5.1.2.1 Enabling road sign information
- 10.5.2 Pilot Assist
 - 10.5.2.1 Pilot Assist video guide
 - 10.5.2.2 Pilot Assist communication and status
 - 10.5.2.3 Activating Pilot Assist
 - 10.5.2.4 Deactivating Pilot Assist
 - 10.5.2.5 Adjusting the target speed for Pilot Assist
 - 10.5.2.6 Enabling and disabling steering assistance when driving
 - 10.5.2.7 Changing lanes with Pilot Assist
 - 10.5.2.8 Adjusting Pilot Assist settings
 - 10.5.2.9 Pilot Assist conditions and limitations
- 10.6 Assisted parking
 - 10.6.1 Parking view
 - 10.6.2 Park Pilot Assist
 - 10.6.2.1 Parking using Park Pilot Assist
 - 10.6.2.2 Leaving a parking space using Park Pilot Assist
- 11. Scenarios and driving recommendations
 - 11.1 Cold conditions
 - 11.1.1 Winter driving recommendations
 - 11.2 Recommendations for driving through water
 - 11.3 Preparations for a long trip
 - 11.4 Long-term parking
- 12. Storage, stowing and towing
 - 12.1 Passenger compartment storage
 - 12.1.1 Glove compartment
 - 12.2 Trunk space and storage
 - 12.2.1 Removing the cargo hatch
 - 12.2.2 Installing the safety net
 - 12.2.3 Stowing cargo in the trunk
 - 12.2.3.1 Lowering the rear for loading
 - 12.2.3.2 Accessing the cargo hold
 - 12.3 Storage under the hood
 - 12.4 Towing a trailer
 - 12.5 Determining the permitted gross vehicle weight
 - 12.6 Recommendations for loading
- 13. Care and maintenance
 - 13.1 Vehicle status
 - 13.1.1 Battery status and health
 - 13.2 Exterior cleaning and care
 - 13.2.1 Washing the exterior by hand
 - 13.2.2 Washing the vehicle in an automatic car wash
 - 13.2.3 Polishing and waxing
 - 13.2.4 Touching up paintwork damage
 - 13.2.4.1 Finding the paint color code
 - 13.2.5 Windshield damage
 - 13.2.6 Refilling washer fluid
 - 13.2.7 Cleaning wipers

- 13.2.8 Replacing front wiper blades
- 13.2.9 Replacing the rear wiper blade
- 13.2.10 Activating the wiper service position
- 13.2.11 Corrosion protection
- 13.3 Interior cleaning and care
 - 13.3.1 Cleaning fabrics and textiles
 - 13.3.2 Cleaning leather and vinyl
 - 13.3.3 Cleaning glass and glossy surfaces
 - 13.3.4 Cleaning interior plastic, metal, and wood components
 - 13.3.5 Cleaning mats
- 13.4 Wheels and tires
 - 13.4.1 Wheel and tire recommendations
 - 13.4.1.1 Tires and wheel storage
 - 13.4.1.2 Tire economy
 - 13.4.2 Designations on tire sidewall
 - 13.4.2.1 Tire tread wear indicators
 - 13.4.3 Changing wheels
 - 13.4.3.1 Spare wheel
 - 13.4.3.2 Winter tires
 - 13.4.3.3 Using snow chains
 - 13.4.4 Checking the brake discs for wear
 - 13.4.5 Punctures
 - 13.4.5.1 Temporary puncture repair
 - 13.4.5.1.1 Using the temporary puncture repair kit
 - 13.4.5.1.2 Inflating tires with the puncture repair compressor
 - 13.4.6 Tire pressure
 - 13.4.6.1 Tire pressure monitoring
 - 13.4.6.1.1 Saving a new reference value for tire pressure monitoring
 - 13.4.6.2 Adjusting tire pressure
 - 13.4.7 Tire terminology
- 13.5 Vehicle electrical system and batteries
 - 13.5.1 Traction battery
 - 13.5.1.1 Managing battery health and performance
 - 13.5.1.2 Powertrain cooling system
 - 13.5.2 12 V battery
 - 13.5.2.1 Battery labels
 - 13.5.3 Battery recycling
 - 13.5.4 Fuses
- 13.6 Tools and equipment
 - 13.6.1 Using a warning triangle
 - 13.6.2 Attaching the towing eye
- 13.7 Raising the vehicle
 - 13.7.1 Workshop lifting areas
 - 13.7.2 Activating jack mode
- 13.8 Maintenance and repairs
 - 13.8.1 Booking maintenance or repairs
 - 13.8.2 On-board diagnostic port
- 14. Immobilized vehicle and recovery
 - 14.1 Damaged vehicle
 - 14.2 Malfunction
 - 14.3 Vehicle has no power or is not responding
 - 14.4 Recovery

- 14.5 Safety mode
- 14.6 Having your vehicle towed
 - 14.6.1 Activating tow mode
- 15. Specifications
 - 15.1 General vehicle characteristics
 - 15.1.1 Vehicle dimensions
 - 15.1.2 Weights
 - 15.1.3 Towing specifications and capabilities
 - 15.1.4 Type designations
 - 15.2 Powertrain specifications
 - 15.2.1 Electric motor specifications
 - 15.2.2 Performance
 - 15.2.3 Charging cable specifications
 - 15.3 Wheel and tire specifications
 - 15.3.1 Approved tire pressures
 - 15.4 Fluid specifications
 - 15.4.1 Brake fluid specifications
 - 15.4.2 Climate system specifications
 - 15.5 Certificates and type approvals
 - 15.5.1 Procedure to temporarily change the automatic high beam sensitivity
 - 15.5.2 Exterior radar type approvals
 - 15.5.3 Interior radar type approvals
 - 15.5.4 Type approvals for Telematic Connectivity Antenna Module
 - 15.5.5 Type approval for TPMS sensor radio frequency
 - 15.5.6 Type approvals for wireless charger and NFC
 - 15.5.7 Door NFC certification
 - 15.5.8 Key systems certification
 - 15.5.9 Certifications for radio and entertainment system
 - 15.5.10 Advanced air cleaning certification
 - 15.5.11 Electromagnetic compatibility compliance
 - 15.6 Labels

1. Consumer information

There's a lot to learn about your Volvo vehicle. This section covers some essential topics, such as where you can find support if you need it and information about certain consumer rights and responsibilities.



Tip

Where to start?

Technically, the whole manual is recommended reading for anyone new to the vehicle. However, you can start by reading the information about how this manual works so you know how to find what you need.

Driver responsibility

The information about driver responsibility is also a good place to start reading. It covers some general principles for safe use of the vehicle and its features.

1.1. About the user manual

Learn how the user manual applies to using your vehicle, as well as where you can find the manual and how to navigate its content.

An important part of your vehicle

Your vehicle is a highly advanced product. However, as a well-designed product, advanced doesn't have to mean it's difficult to use. The aim here is to give you an intuitive experience, with natural interactions that work for both driver and passenger alike. This manual is designed to be a part of the vehicle, giving you information for safe and effective use. It is your resource on the vehicle's functions and features.



Tip

New user

If you are new to this vehicle, take some time to explore the different areas of the manual. Knowing the vehicle's capabilities and limitations is your responsibility and a necessity for safe and effective use.

Keep the manual up to date

Make sure that you keep the manual up to date by always having the latest version. Take a look any time a software update introduces changes or new features.

A guide to your vehicle's intended use

The manual establishes the vehicle's intended use, as defined by Volvo. Whenever you are directed to the manual, consider it an instruction to make absolutely sure that you are using the vehicle as intended. This is the recommendation, as both the descriptive and prescriptive parts of the manual provide important information that contributes to safe and effective use.

The content of this manual represents the status of the user manual at the time of printing and may not be completely valid in future instances. For more information refer to the first page for the complete disclaimer note.

Note

Intended use

If you use the vehicle in a manner which Volvo has not intended, it can negatively affect how it works. This includes shortening the vehicle's service life and limiting your ability to use the vehicle safely and effectively. It may also affect the validity of the vehicle warranty.

Volvo is not the only authority that defines proper use of the vehicle. It is your responsibility to use the vehicle in accordance with local laws and restrictions.

Accuracy in representing your vehicle

The primary goal of this manual is to accurately describe how your vehicle works. However, certain differences between produced vehicles are not reflected in the manual, such as colors, materials and certain equipment.

Note

Vehicles are equipped and adapted to meet specific market needs, as well as local legislation and requirements. Certain regional variations in configuration may not be reflected in the manual's content.

Where to find the manual

Your vehicle's user manual is available as an app in the vehicle's display, via the mobile app for the vehicle and at [volvocars.com/intl/support](https://www.volvocars.com/intl/support) [<https://www.volvocars.com/intl/support>].

Note

Volvo's support site

The version of the user manual on Volvo's support site is for a fully-equipped vehicle with all of the available options, functions and features. Therefore, it may differ from this user manual due to what's available in your vehicle.^[1]

Printed supplements

The manual is fully digital, but a selection of its content may be included with your vehicle as a printed supplement. The inclusion of printed supplements depends on your region and how your vehicle is configured.

Applicability

 **Important**

- Maintain and handle the vehicle according to Volvo's recommendations in the user manual. Volvo accepts no responsibility for damage or accidents if you disregard the instructions in this manual.
- It is recommended that you read all the user information before you drive for the first time.
- If you find information that differs from the information in your vehicle through other channels, such as the Volvo website, it is always the user information in the vehicle's display that is valid.
- Volvo works continuously to improve the quality of the user information and make it more accessible and useful. This means that descriptions and illustrations may change. Volvo reserves the right to make changes without prior notice.
- The original version of this user manual is written in British English. Therefore, there may be certain differences between the descriptions in the manual and the actual vehicle.
- The descriptions in this manual are based on general usage conditions. Remember that they can change depending on location, environment and driving behavior.
- No illustrations or texts in this manual may be copied without permission from Volvo.

^[1] Availability may vary between regions and equipment levels.

1.1.1. Reading the user manual

Learn how the content of this user manual is organized so that you can find what you need, when you need it.

Your vehicle's user manual is designed to guide you, both when you're looking for a specific piece of information and when you're simply exploring to learn more about your vehicle.

Structure

This manual is a large network of informational pages. Each page has its own content and might have a list of links that take you to related pages. The links can take you to subsections of the section you're in or to other sections that are connected to what you're currently reading.



Tip

Finding the right level of information

Sometimes the answer to what you're looking for might not lie in the details. Moving up a level or two in the structure might provide the context and perspective you need, or just a better idea of where to look.

Searching for information

You can use the search field for quicker access to what you're looking for.

All main areas

To get you started, the related information links on this page include all of the main sections in this user manual.

Navigate through interactive images

Some of the manual pages have images with interactive markers. You can tap these markers to reveal links to relevant parts of the manual. These interactive markers allow you to explore the user manual in a more visual way.



Tip

Animated introductions

Some pages show a short animation as an introduction. This provides you with a few visual hints of what you can expect to find in that part of the user manual.

Images and videos

Images in the user manual are sometimes schematic and intended to give an overview or an example. Images can differ from your vehicle due to equipment level or market requirements.

Highlighted content

You can find content that is highlighted in various ways throughout this user manual.



Warning

Content that is highlighted like this primarily provides information about conditions or use with a clear potential to cause severe harm to health.



Important

Content that is highlighted like this primarily provides information about conditions or use with a clear potential to cause material damage.

 **Note**

Content that is highlighted like this primarily contains information that can help you avoid incorrect use or information that is easily missed or misunderstood.

 **Tip**

Content that is highlighted like this primarily provides tips for use or where to find related content.

Equipment, accessories and features

Some equipment, accessories and features might be limited or only available for certain vehicle configurations or markets. Even if the information is available to you, it does not guarantee that the specific equipment, accessory or feature described is available in your vehicle.

 **Note**

There may be differences in terminology between the manual and materials used for marketing, sales and advertisements.

For more information on standard and optional equipment, contact Volvo Support.

1.2. Customer support and contact information

If you have any questions regarding your vehicle, you can find answers or solutions in a number of places. In addition to searching the user manual you are reading now, you can visit Volvo's website, Volvo's support site or contact Volvo Assistance.

Website and support site

Volvo's website [volvocars.com](https://www.volvocars.com) [https://www.volvocars.com] has several customer support resources.

The support section [volvocars.com/intl/support](https://www.volvocars.com/intl/support) [https://www.volvocars.com/intl/support] provides contact information, software news and answers to frequently asked questions. You can also find your closest Volvo retailer or contact Volvo via phone or chat.

Volvo Assistance

Volvo Assistance can offer help in the event of a breakdown or if your vehicle unexpectedly becomes immobilized. This includes roadside assistance. Volvo Assistance is available 24 hours a day, 7 days a week.

Press the assist button  on the roof or use the mobile app for the vehicle to contact Volvo Assistance.

Contact information

The content of this manual represents the status of the user manual at the time of printing and may not be completely valid in future instances. For more information refer to the first page for the complete disclaimer note.

For questions that can't be solved by Volvo's other support services, contact Volvo using the following information:

Volvo Car USA

1800 Volvo Place

Mahwah, NJ 07430

Attn: Volvo Consumer Relations Center

For quicker handling of your inquiries, send a fax to 1-866-631-9059.

Telephone: 1-800-458-1552

[volvocars.com/us](https://www.volvocars.com/us/) [<https://www.volvocars.com/us/>]

Volvo Car Financial Services

P.O. Box 91300

Mobile, AL 36691-1300

Visit Volvo Car Financial Services for questions about your existing VCF contract.

1.3. Driver responsibility

As a driver, you are responsible for doing everything possible to ensure your own safety, as well as that of your passengers and other road users.

Your knowledge, decisions and actions determine how safely you drive. Your vehicle has features that, in certain situations, can compensate for mistakes and lapses in judgment. However, they do not change where the responsibility lies. They are a supplement to good driver practices, which you are responsible for as a driver.

You have likely studied and practiced to ensure you have the necessary knowledge and abilities to be a safe driver. This section covers a few essentials you may recognize, such as:

- Driving and using driver support functions
- Knowing the vehicle's capabilities and limitations
- Driver distraction
- Driver fatigue
- Laws and regulations

Driving and using driver support functions

You are responsible for adapting your driving to the current conditions, even when using driver support functions. This includes adapting your distance to other vehicles' speeds, as well as being ready to react to traffic and road hazards. Your vehicle's safety interventions and warnings rely on accurate detection and identification of surrounding traffic and road conditions. The detection systems cannot handle all driving, traffic, weather and road conditions.

 **Note**

Driver support

Driver support functions can assist you with certain driving tasks and improve driving awareness. When used correctly, they can improve safety and convenience, but they are not a replacement for safe driving practices. Drive the vehicle with the same attention to safety as you would need to in a vehicle without these functions.

Knowing the vehicle's capabilities and limitations

Before driving, all drivers are advised to familiarize themselves with the vehicle and any functions and features they might use. The driver has a responsibility to ensure they have sufficient knowledge of the vehicle to use it safely.

If you are uncertain about any of the vehicle's functions or have questions about its intended use, consult the manual. If you can't find the information you need, contact Volvo Support.

Driver distraction

Distractions reduce your attentiveness and focus when driving. As a driver, you are always responsible for assessing whether a task is safe to perform. Your assessment should take the situation as a whole into account, as well as specific conditions and circumstances that can cause distraction. It might be safe to adjust the volume when you're driving on a straight empty road, but not in more demanding situations, such as when overtaking.

 **Warning**

Avoid distractions

Any task that prevents you from keeping your attention on the road and surrounding traffic should only be performed when the vehicle is parked. A few examples include:

- Do not hold your phone while driving. Local laws often restrict or forbid phone use while driving.
- Do not manually change the navigation route while driving.
- Do not change detailed sound settings while driving.

Driver responsibility and safety features

Your vehicle has several safety features designed to reduce the risk of an accident. They do not reduce the driver's responsibility to remain attentive or the need to operate the vehicle as safely as possible.

 **Tip**

Help from passengers

Tasks that risk distracting the driver can often be done by a passenger instead. However, certain actions are simply not available in the vehicle when driving, such as reading this manual in the center display. For these actions, you need to be parked.

Voice commands

Voice commands can, in some situations, be less distracting than doing the same task manually.

Driver fatigue

The driver is always responsible for being well-rested. Your vehicle has some functions with abilities to warn you if you show signs of fatigue. It's important to always stop and take a break at the slightest feeling of fatigue, regardless of whether a function has given you a warning.

Laws and regulations

The driver is always responsible for knowing and following local laws and regulations. If you drive to a region with different traffic laws, make sure that the vehicle is equipped as required and read up on how the traffic laws differ from what you're used to.

1.4. Warranty information

Your vehicle comes with a range of warranties. You can find general warranty information here. For detailed information, refer to your vehicle's service and warranty booklet.

	Time/Distance
New Vehicle Limited Warranty (US) New Vehicle Warranty (Canada)	4 years / 50,000 miles / 80,000 kilometers
Battery Warranty (12V)	4 years / 50,000 miles / 80,000 kilometers, Full Coverage
High Voltage Battery	8 years / 100,000 miles / 160,000 kilometers
Adjustments	1 year / 12,000 miles / 20,000 kilometers
Seatbelts and SRS	5 years / unlimited mileage / kilometers
Corrosion Protection	12 years / unlimited mileage / kilometers
Volvo Assistance Warranty Coverage, US/Canada	4 years unlimited mileage (refer to the separate booklet in the Owner's Wallet)
Volvo Roadside Assistance	Complimentary towing provided for all out-of-warranty vehicles to an authorized Volvo retailer, within a 25-mile/ 50-kilometer radius

1.5. Modifications, repairs and accessory installations

Modifications ^[1], repairs and installation of accessories or extra equipment requires proper knowledge and quality of both work and parts. Otherwise, they risk impairing your vehicle's functionality and safety. Contact a Volvo retailer before making any alterations to your vehicle.

For any alterations ^[2] to the vehicle, Volvo strongly recommends that:

- you seek prior advice of a trained and qualified Volvo service technician.
- work is only carried out by trained and qualified Volvo service technicians.
- installed parts and accessories are approved by Volvo. ^[3]
- parts and accessories are installed according to their installation instructions.

- they comply with local laws and regulations.^[4]

Contact a Volvo retailer for more information.

Warning

Systems can be negatively affected

Unapproved or incorrectly installed accessories can negatively affect your vehicle's performance, communication and safety systems. Certain accessories only work with associated software that needs to be installed in the vehicle.

Electrical installations

For additional electrical installations, it is essential to use appropriate connection points to ensure the integrity of the vehicle's electrical system. The vehicle has a specific ground attachment point designated for aftermarket installations, which is separate from those reserved for critical components. Volvo recommends an authorized Volvo workshop for any electrical installations.

End-of-life handling

Some parts of the vehicle are dangerous to handle. Special handling is required when servicing or scrapping after the vehicle has reached its end-of-life.

- Electrical components in the vehicle^[5] may contain harmful substances and can deliver lethal electrical shock if handled incorrectly.
- Components such as airbag modules, seat belt tensioners, adaptable steering columns and button cell batteries may contain perchlorate materials.

CALIFORNIA Proposition 65

Operating, servicing and maintaining a passenger vehicle or off-highway motor vehicle can expose you to chemicals, including engine exhaust, carbon monoxide, phthalates, and lead, which are known to the State of California to cause cancer and birth defects or other reproductive harm. To minimize exposure, avoid breathing exhaust, do not idle the engine except as necessary, service your vehicle in a well-ventilated area and wear gloves or wash your hands frequently when servicing your vehicle. For more information go to www.p65warnings.ca.gov/products/passenger-vehicle [<https://www.p65warnings.ca.gov/products/passenger-vehicle>]. Certain components of this vehicle, such as airbag modules and seat belt pre-tensioners, may contain Perchlorate Material. Special handling may be required for service or vehicle end-of-life disposal. See www.dtsc.ca.gov/hazardouswaste/perchlorate. Battery posts, terminals, and related accessories contain lead and lead compounds. Wash hands after handling.

Note

Non-approved changes and liability

Volvo does not accept any liability for damage, incurred cost, personal injury or death that is caused by changes to the vehicle^[6] not approved by Volvo.

^[1] Modifications include changes to the vehicle's software, including but not limited to tuning.

^[2] This means modifications, repairs and installation of accessories and extra equipment.

^[3] Accessories that are not approved by Volvo may not have been specifically tested for use with your vehicle.

[4] This applies to both the act of making the alteration and subsequent use of the altered vehicle.

[5] Such as batteries

[6] Including but is not limited to modification, repair and installation of accessories or extra equipment.

1.6. About Volvo's components

Volvo Cars produces and manufactures vehicles with specific attention given to protecting occupants in the event of an accident.

Volvo produces and manufactures vehicles that are designed to protect the passengers in the event of an accident.

Volvo vehicles are designed to absorb the forces of a collision. The energy absorbing system—which consists of but is not restricted to structural components such as bumper reinforcements, bumpers; energy absorbers, frames, rails, mudguard protection guards, A-pillars, B-pillars and body panels—must interact to keep the passenger compartment intact and protect the occupants.

The collision safety system—which consists of but is not restricted to airbags, inflatable curtains and deployment sensors, interacts with the above components so that the airbags deploy at the right time.

Because of the above, Volvo Car USA does not permit the use of aftermarket or alternative parts or anything other than Volvo genuine parts for repair after collisions.

Volvo Car USA also recommends the use of replacement window glass approved by Volvo. Use of aftermarket window glass, in particular windshields, can have a negative effect on the collision avoidance systems and advanced lighting systems.

In addition, Volvo does not permit use or re-use of structural components from an existing vehicle that has been damaged previously. Even if these parts may appear the same, it is difficult to determine whether the parts have been previously replaced with parts other than genuine parts or if the parts have been damaged in a previous collision. The quality of these used parts may have been affected by exposure to the elements.

1.7. Certified technicians

Ensure that the technicians handling your vehicle have the qualifications required to do so safely.

Certified technicians have met high competence requirements within specific areas. In addition to having passed the exam, every technician must also have worked in the field for at least two years before a certificate is issued. These professional technicians have the best capacity to analyze vehicle problems and carry out the maintenance that is necessary to keep your Volvo in the best possible condition.

Electric vehicles

Technicians who carry out work on vehicles with electric drive should also have the necessary training and special certification required to carry out repairs and/or maintenance on electrically powered vehicles.

 **Warning**

A number of electrical components in vehicles with electric drive use current with high voltage and can be extremely dangerous if they are handled incorrectly. These components, as well as all orange-colored cables in the vehicle, must only be handled by trained and qualified Volvo service technicians.

1.8. Information about recalls

It is important that you stay updated about open recalls.

To find out if your vehicle has any open recalls, you can:

- Visit Volvo's website [volvocars.com](https://www.volvocars.com/) [<https://www.volvocars.com/>]
- Visit the National Highway Traffic Safety Administration^[1] website www.nhtsa.gov [<https://www.nhtsa.gov/>]

 **Note**

You will need your vehicle's vehicle identification number^[2] to check if it's affected by a recall or safety alert.

^[1] NHTSA

^[2] VIN

1.9. Reporting safety defects

If you think there is a safety defect with your vehicle, you need to report it to the correct authorities. The following information is phrased according to external legal requirements.

If you believe your vehicle has a defect that may cause accidents, personal injury or death, you must immediately inform the National Highway Traffic Safety Administration (NHTSA), in addition to notifying Volvo Car USA, LLC. If the NHTSA receives similar complaints, they may start investigating the issue, and if they conclude that there is a safety-related defect in a group of vehicles, they can order a recall for rectification. The NHTSA, however, cannot involve itself in individual problems between you, the retailer or Volvo Car USA, LLC. The NHTSA can be contacted by calling the toll-free number for vehicle safety:

1-888-327-4236

(TTY: 1-800-424-9153) or writing to: NHTSA Headquarters, 1200 New Jersey Avenue SE., West Building, Washington D.C. 20590.

You can also obtain other information concerning motor vehicle safety from <http://www.safecar.gov>, where you can specify the vehicle's VIN (Vehicle Identification Number) to see whether there are any open vehicle recalls.

Volvo strongly recommends that if the vehicle is part of a service campaign, a safety or emission-related recall or some other similar action, it should be carried out as soon as possible. Check with the retailer or Volvo Car USA, LLC, to see if the vehicle is subject to any such measures.

NHTSA can be reached via:

Internet: <http://www.nhtsa.gov>

Telephone: 1-888-327-4236

1.10. Finding the vehicle identification number

There are several ways to find your vehicle's unique vehicle identification number. ^[1] You might need your vehicle's VIN if you contact Volvo about any questions or problems regarding your vehicle.

You can find the number in one of the following ways:

- In the center display.
- On a label on the dashboard, close to the bottom edge of the windshield. It can typically be read from outside the vehicle.
- In the vehicle's registration documentation.
- By contacting a service technician, who can retrieve it through the on-board diagnostics socket.

In the center display

1. Press the vehicle symbol  in the bottom bar and go to **Settings**.
2. Go to **System** → **About** → **VIN number**.

^[1] VIN

1.11. Approval of terms and conditions and data collection

You will see messages about different terms and conditions and data collection ^[1] in the center display. Your agreement is necessary for certain apps and services to work properly.

The first time you use your vehicle, a guide opens in the center display to assist you in making various settings. In connection with the guide, you are prompted to consent to different types of terms and conditions and the collection of information. You can do this later in privacy settings as well.

The content of this manual represents the status of the user manual at the time of printing and may not be completely valid in future instances. For more information refer to the first page for the complete disclaimer note.

You may also need to give your consent, for example, when you:

- Use an app or service for the first time.
- Add a new profile.
- Delete a profile.
- Change the ownership of the vehicle.
- Reset user data or do a factory reset.

 **Note**

Accept Google's terms and conditions

Not accepting Google's terms and conditions limits the availability and performance of certain features, such as Pilot Assist, map features and voice control.

General Privacy Notice

Depending on your market, Volvo Cars may collect and process different types of personal data for various purposes. You can find more information about how Volvo Cars processes your personal data in the Volvo Cars General Privacy Notice available on Volvo's website. If there are any differences between the user manual and the privacy notice related to the processing of personal data, the privacy notice takes precedence.

Accept privacy settings

1. Press the vehicle symbol  in the bottom bar and go to **Settings**.
2. Go to **Privacy**.
3. Select the privacy setting you want to change and follow the instructions in the center display.

 **Important**

Accept privacy settings

If you decide not to accept the privacy settings, you may not experience full functionality from apps and services.

 **Note**

Volvo services

You can manage your consent to data sharing with Volvo here.

Vehicle location sharing

You need to enable location sharing in your vehicle to use certain apps and functions. For example, location sharing is required to use remote vehicle services via Volvo Assistance and for apps such as Find my vehicle and the Trips app.

^[2] Map features also rely on location sharing. If you disable location sharing via the privacy settings, location sharing is also disabled for any features or apps that use it.

[1] Data is collected to provide better vehicle, safety and app functions.

[2] The Trips app can then collect data such as the vehicle's position, speed, mileage and power consumption.

1.12. Handling of recorded and collected data

Certain information about the vehicle's status and operation is recorded and collected for quality and safety reasons. This can provide an understanding of the circumstances around traffic accidents involving the vehicle and other usage scenarios.

Event Data Recorder (EDR)

This vehicle is equipped with an event data recorder (EDR). The main purpose of an EDR is to record, in certain crash or near crash-like situations, such as an air bag deployment or hitting a road obstacle, data that will assist in understanding how a vehicle's systems performed. The EDR is designed to record data related to vehicle dynamics and safety systems for a short period of time, typically 30 seconds or less. The EDR in this vehicle is designed to record such data as:

- How various systems in your vehicle were operating;
- Whether or not the driver and passenger seat belts were buckled/fastened;
- How far (if at all) the driver was depressing the accelerator and/or brake pedal; and,
- How fast the vehicle was traveling.

These data can help provide a better understanding of the circumstances in which crashes and injuries occur. NOTE: EDR data is recorded by your vehicle only if a non-trivial crash situation occurs; no data is recorded by the EDR under normal driving conditions and no personal data (e.g., name, gender, age, and crash location) is recorded. However, other parties, such as law enforcement, could combine the EDR data with the type of personally identifying data routinely acquired during a crash investigation.

To read data recorded by an EDR, special equipment is required, and access to the vehicle or the EDR is needed. In addition to the vehicle manufacturer, other parties, such as law enforcement, that have the special equipment, can read the information if they have access to the vehicle or the EDR.

Active Safety Data Recorder (ASDR)

This vehicle is equipped with an Active Safety Data Recorder (ASDR). This data recorder can record information related to the usage of the vehicle, functional errors and active safety actuations (e.g. auto brake). The information saved is used by technicians for service and maintenance to diagnose and repair possible faults that have occurred in the vehicle and to fulfill certain legal requirements. The registered data can also, in combined form, be used for research and product development purposes to continuously improve the safety and quality of Volvo vehicles.

1.13. About connected services and the fair use policy

Use of your vehicle's connected services is subject to certain conditions.

Where Volvo Cars is responsible for the provision of mobile connectivity services to enable use of certain functions, and excluding any separate contract for mobile connectivity services of the owner or any other user of the vehicle that Volvo Cars is not party to, each user understands and agrees that, to the extent permitted by law, that: (1) they have no contractual relationship with the underlying wireless service carrier, (2) they are not a third-party beneficiary of any agreement between the vehicle owner and the underlying carrier, (3) the underlying carrier has no liability of any kind to the user, whether for breach of contract, warranty, negligence, strict liability in tort or otherwise, (4) data transmissions and messages may be delayed, deleted or not delivered, and emergency calling may not be completed, (5) the underlying carrier cannot guarantee the security of wireless transmissions and will not be liable for any lack of security relating to the use of the services.

Fair use policy

Your use of the connectivity services which are part of your vehicle is subject to this fair use policy.

When using these services, you agree not to:

- submit content that is unlawful, obscene, libelous, threatening, harassing, hateful, racially or ethnically offensive or otherwise inappropriate
- use the services in breach of any applicable law
- use the services for commercial purposes.

Your access to these services is part of a shared access. Volvo reserves the right to suspend your access to or use of the services if your use involves very high volumes of data, disproportionate to other users. Volvo may also suspend your access for technical reasons or to protect other functions of your vehicle.

1.14. Changing ownership of the vehicle

The driver of the vehicle must be registered with Volvo in order to use all available functions and services. Therefore, when there is a change of ownership, the current owner needs to be removed to give the new owner access.

The current owner needs to end their ownership by removing their Volvo ID from the vehicle. This can be done in the mobile app for the vehicle or by visiting a Volvo retailer. The new owner can also get help with registering their ownership from a Volvo retailer.

Note

Reset the vehicle

When the current owner has ended their ownership, an automatic factory reset of the vehicle takes place. This means that profiles, user data and other individual settings are removed.

No owner?

If the vehicle doesn't have an owner, you can claim the ownership by connecting your Volvo ID to your profile in profile settings via the center display. Make sure that you have two keys in the vehicle as you will need both of them for the setup process.

1.15. Resetting user data

You can reset the user data and system settings in the center display.

You can reset the app settings or network settings to their standard values or do a complete factory reset. If you do a factory reset, you will delete profiles, keys, user data and other customized settings.

Note

Only the owner can reset the network settings and do a factory reset.

Volvo Cars app connection

If you do a factory reset in the vehicle, the Volvo Cars app will still be connected and may recreate your profile using cloud data. To avoid this, you need to remove the vehicle connection in the Volvo Cars app.

1. Press the vehicle symbol  in the bottom bar and go to **Settings**.
2. Go to **System** → **Reset options**.
3. Select what you want to reset and follow the instructions in the center display.

1.16. Recommendations when changing regions

When relocating or importing your vehicle to a new region, you need to register your vehicle and Volvo ID there. This is to make sure that digital services work correctly and that the vehicle complies with local laws and regulations.

To get help registering your vehicle in a new region, contact Volvo Support.

Note

Available services may vary over time and depend on region. This may also have an effect when visiting another region temporarily.

Do not export your Volvo to another country without researching the country's current safety requirements. In some cases it may be difficult or impossible to meet these requirements.

2. User accounts, profiles and services

Get more out of your vehicle by customizing it using profiles and connecting it to the phone app. This gives you access to more features and services, such as support if you're having issues on the road.

Note

Some of the services available for your vehicle require a registered personal account, such as your Volvo ID.

To get the most out of your vehicle experience:

- Connect your Volvo ID
- Download and sign in to the Volvo Cars app on your phone
- Set up your user profile and customize the vehicle's settings, such as ergonomic settings and other preferences
- Sign in with your Google account

2.1. Setting up your vehicle for the first time

There is a guide that helps you set up your vehicle the first time you use it.

The setup guide for your vehicle automatically starts in the center display. It guides you through setting up a profile and other essential settings.

Tip

Before getting your vehicle

Before you start, you will need to create a Volvo ID and download the Volvo Cars app. This makes the in-vehicle setup faster.

The setup guide covers the following:

- Important settings, such as your vehicle's system language
- Connecting the vehicle to your Volvo ID and the Volvo Cars app
- Consent to terms and conditions for various vehicle services, including third-party services
- Setting up Internet access
- Consent to software updates
- Setting up a profile

 **Note**

Stay parked during setup

The vehicle needs to be stationary and in P when you go through the setup guide.

Complete setup

It is advisable to complete the setup before driving the vehicle. If you exit the guide before going through the necessary steps, certain features will be unavailable until you go back and complete the process. You will also be reminded about the setup the next time you drive the vehicle.

No guide?

If the vehicle has already been set up by someone else, such as a previous owner, you can reset the vehicle to access the setup guide again.

2.2. Volvo ID

Your Volvo ID is a personal account that gives you access to various services connected to your vehicle.

You will need your Volvo ID when you use remote features via the Volvo Cars app.

 **Note**

Available services can vary over time and depend on both region and equipment level.

2.2.1. Creating a Volvo ID

Create your Volvo ID in the Volvo Cars app on your phone or on Volvo's website.

If you want to use the Volvo Cars app to create your Volvo ID, make sure that you have the latest version installed on your phone.

1. Open the app on your phone or go to [volvocars.com](https://www.volvocars.com) [<https://www.volvocars.com>].

Note

If you use the website, make sure that you are signed in.

2. Select the option to create a new Volvo ID and follow the instructions.

Note

After creating your Volvo ID, you may need to confirm your email address to fully activate your account.

2.3. Volvo Cars app

The Volvo Cars app allows you to control certain functions and interact with the vehicle via your phone.

The Volvo Cars app is available for iPhone and Android phones. You can download it for free from your phone's app store. The app is updated regularly, so make sure that you have the latest version on your phone.

Note

Sign in with your Volvo ID

You need to sign in to the app using the same Volvo ID that's connected to your profile in the vehicle.

Give your consent

Give your consent to Volvo services in privacy settings to be able to connect the app to the vehicle.

Check the internet connection

The Volvo Cars app and your vehicle need to be connected to the internet for all services to work properly.

Here are a few things you can do in the Volvo Cars app:

- Check the battery level, lock status, window status and other vehicle statuses

- Lock and unlock doors
- Start and stop parking climate control
- Contact Volvo for more assistance
- View your account information

 **Note**

Available services may vary over time and depend on region.

2.4. Getting started with Google services

Signing in with your Google account gives you a personalized experience when using Google services and apps such as Maps.

To sign in to your Google account and take full advantage of Google services, the vehicle needs to be connected to the internet.

1. If you don't already have a Google account, go to accounts.google.com/signup [https://accounts.google.com/signup] and create one.
2. Sign in using your Google account via the center display and follow the instructions.

2.5. Customization and settings

You can customize many of your vehicle's features and behaviors by accessing its settings.

Where to find settings

Settings and adjustments are available in the following places:

- The settings tab in the display contains most of your vehicle settings and adjustments. To access it, press the vehicle symbol  in the bottom bar and go to **Settings**. There are several categories to explore within the tab.
- Some views and in-vehicle apps have their own settings sections. Open the app or view and look around to find available customization options.
- The mobile app for the vehicle has settings related to remote and connected features.

Setting types

Your vehicle's settings apply differently depending on their type. Most settings are specific to a user profile, but some apply to all users of the vehicle. A few settings are only available to adjust when the owner profile is in us, since only it has administra-

tive privileges.



Tip

Customized experience

Set up user profiles for all drivers to get a customized experience. There are many profile-specific settings that are applied automatically when you select your profile.

Some settings apply indefinitely from the moment you change them, while others may only be temporarily applied, such as until the end of the current drive.

2.6. Vehicle user profiles

For a more customized experience, you can set up user profiles for different drivers.

To access all of your vehicle's features, you need to set up the owner profile. You can then add co-driver profiles for more users. Having individual user profiles allows each driver to save customized settings and adjustments that are automatically applied when their profile is selected.

Profile type	Who uses it?
Owner	The permanent user profile for the owner of the vehicle.
Guest	A guest user profile that's available for temporary users of the vehicle.
Co-driver	Up to five additional user profiles for regular users of the vehicle.

The owner has all the administrative privileges, while the co-drivers have some of them. The guest can make some adjustments, but the guest profile resets when you start using another profile.

You can find the profile settings in settings, where you can do the following:

- Add and switch profiles
- Restrict access to your profile
- Connect the Volvo Cars app to the vehicle
- Connect keys to your profile
- Change your profile name
- Remove your profile, if you are a co-driver

2.6.1. Switching profiles

You can switch between profiles in the center display.

 **Note**

Only available while stationary

You can only switch profiles when the vehicle is stationary and in P. Switching is also unavailable during certain tasks.

Can't switch profile

If you have problems switching to another profile, you will use the guest profile. Try again later.

Locked profile?

You might need a PIN or pattern to unlock a profile before using it. If it's not your profile, you can switch to your own profile instead.

1. Press the vehicle symbol  in the bottom bar and go to **Settings**.
2. Go to **Profiles**.
3. Select your profile.

2.6.2. Adding a profile

You can add new profiles in the center display.

When you add a new profile, the setup guide starts automatically in the center display. It guides you through all of the essential settings.

 **Note**

If you don't complete the setup guide, some features and services will be unavailable.

 **Tip**

The owner can also create new profiles in the Volvo Cars app by inviting a new co-driver to link their Volvo ID to the vehicle.

Add a profile in profile settings

1. Press the vehicle symbol  in the bottom bar and go to **Settings**.
2. Go to **Profiles**.

3. Press **Add new** and follow the instructions in the center display.

2.6.3. Removing a profile

You can remove your user profile in the center display.

Note

You cannot remove the owner or the guest profile, but you can reset them. If you want to reset the owner profile, you need to do a factory reset. The owner profile also resets when you end your ownership. The guest profile resets when you switch to another profile.

Tip

The vehicle owner can also remove user profiles from the vehicle via the Volvo Cars app.

1. Press the vehicle symbol  in the bottom bar and go to **Settings**.
 2. Go to **Profiles**.
 3. Select **Remove this profile**.
- > The vehicle will switch to the guest profile automatically.

Note

If you have a Volvo ID connected to your profile as a co-driver, you cannot delete your profile. You can only remove your profile from the vehicle.

2.6.4. Assigning a key to a profile

You can assign keys to your profile. Choose a distance-capable key or key card.

In the setup guide

You can assign a key to the owner profile during the setup guide. When it's time, place your key on the NFC^[1] reader and follow the instructions in the center display. You can also do this later in profile settings.

 **Note**

If you want to assign a digital key to your profile, you have to create a digital key first.

 **Tip**

Assign a key to your profile so that your profile is automatically selected when you unlock the vehicle or unlock the driver's door using the key. If you use a key that's not assigned to any profile, the guest profile will be automatically selected.

Assigning a key to a profile in Profile settings

1. Press the vehicle symbol  in the bottom bar and go to **Settings**.
2. Go to **Profiles** → **Car keys**.
3. Select the key you want to assign and follow the instructions in the center display.

^[1] Near-field communication

2.6.5. Managing keys assigned to profiles

You can manage your assigned keys in profile settings.

 **Note**

What you can manage

A co-driver can only disconnect their own connected keys. The owner can change the primary key, as well as disconnect or remove all of the connected keys.

Changing a key

You can only change the primary key. For any other keys, you can disconnect the old key and then connect the new key to your profile.

1. Press the vehicle symbol  in the bottom bar and go to **Settings**.
 2. Go to **Profiles** → **Car keys**.
- > You will see a list of all the assigned keys.

3. Select the key you want to manage and follow the instructions in the center display.



Tip

New phone?

The owner can change the primary key if it's already assigned to their profile. To do this, select the primary key and press **Change device** in the center display and follow the instructions. You will need your new phone to scan a QR code and the Volvo ID that's linked to the vehicle to log in.

2.6.6. Restricting access to a profile

You can restrict access to a profile by adding a profile lock in the center display. When a profile lock is active, you need a PIN or pattern to unlock the profile.

1. Press the vehicle symbol  in the bottom bar and go to **Settings**.
2. Go to **Profiles** → **Profile lock**.
3. Select your preferred lock type and follow the instructions in the center display.

2.6.7. Adding an account to a profile

You can add different accounts to your profile, such as your Google account and accounts from third-party apps.

1. Press the vehicle symbol  in the bottom bar and go to **Settings**.
2. Go to **Profiles** → **Accounts**.
3. Select **Add account**.
 - > You will see a list of possible accounts to add.
4. Select the account you want to add and follow the instructions in the center display.

If you want to remove an account from your profile, select the account and press **Remove**.

2.7. Volvo Assistance

Volvo Assistance is a service that provides assistance and remote access to certain vehicle features. You can contact a Volvo Assistance service center at any time for assistance.

If you experience any unpredictable problems on the road, you can call Volvo Assistance. For example, if:

- your vehicle's battery runs out of charge
- your vehicle breaks down
- you get a flat tire.

Volvo Assistance is available in the Volvo Cars app and by pressing the assist button  on the ceiling.

Note

Not for emergencies

If you need assistance in an emergency situation, press the SOS button instead. Situations that could require immediate emergency assistance include traffic accidents, acute illness and external threats.

An included service

Volvo Assistance is included with new Volvo vehicles for the first few years of ownership.^[1] For more information regarding your vehicle, contact Volvo support or a Volvo retailer.

Note

If you don't have a Volvo Assistance agreement, you will still be able to use the service for an extra cost.

Terms and conditions

Volvo Assistance is intended to be active for as long as the vehicle is used and the technology it relies on is supported, such as the vehicle's mobile network connectivity.

Certain information, including personal data, needs to be shared with Volvo in order to use Volvo Assistance.

Note

Volvo reserves the right to reduce Volvo Assistance functionality that is deemed no longer practically possible to maintain.

If a vehicle remains unused for more than one year, it is considered no longer in use.

If you need any help or have any questions regarding Volvo Assistance, contact Volvo support.

^[1] Availability and inclusion with new vehicles varies between regions.

2.7.1. Calling Volvo Assistance for roadside assistance

You can press the assist button in the ceiling to contact Volvo Assistance for roadside assistance^[1]. For example, if you experience any unpredictable problems on the road, such as if your vehicle's battery runs out of charge, your vehicle breaks down or you get a flat tire.

Note

Not for emergencies

If you need assistance in an emergency situation, press the SOS button instead. Situations that could require immediate emergency assistance include traffic accidents, acute illness and external threats.

Using Volvo Assistance abroad

If you press the assist button  when you are abroad, you will reach Volvo Assistance in your home country.

Tip

You can also use the mobile app for the vehicle to contact Volvo Assistance.



The assist button is located on the roof, to the right of the overhead console.

1. Press and hold the assist button for at least 2 seconds.



- > The vehicle makes a voice call to Volvo Assistance. It also sends information, such as its location and status. The Volvo Assistance call center will try to communicate with you to find out what kind of help you need.

If the voice call fails, the Volvo Assistance call center has the ability to respond based on information sent by the vehicle.

^[1] Availability depends on region.

2.8. Emergency assistance

In an emergency, the vehicle can connect you to an emergency call center. This is done automatically in response to severe collisions or manually by pressing the SOS button on the roof.^[1]

Note

Strictly for emergencies

Situations that could require immediate emergency assistance include traffic accidents, acute illness and external threats.

Built to work after a collision

In order to call an emergency call center after a collision, the system must not be critically damaged. The system is designed to survive severe collisions and has its own backup battery in case the regular power supply fails.

When an emergency call is made, the following happens:

1. The vehicle makes a voice call to an emergency call center. It also sends information, such as its location and status.
2. The emergency call center will try to communicate with you to find out what kind of help you need.
3. If the voice call fails, the emergency call center has the ability to respond based on information sent by the vehicle.

Using the SOS button

The SOS button is located on the roof, on the left side of the overhead console. You can read more about using the SOS button in a separate section of the manual.

When the emergency assistance system is working normally, the SOS button LED is white. In other cases, the light may change to red or flash at varying intervals.

LED behavior	Description
Blinking	The system is performing a self-check.
Solid red with SOS symbol showing in the instrument panel	The system has detected a critical fault. Immediate service is recommended.
Solid red without SOS symbol showing in the instrument panel	The system has detected a fault. It may still work but should be checked.
Moderate flashing	An emergency call is starting.
Rapid flashing	The system is transmitting data to the emergency services.
Slow flashing	The system is connected to the emergency services.
Solid white	The system is working normally.

Automatic emergency response

The vehicle automatically attempts to contact an emergency call center if it registers a collision above a certain level of severity. ^[2]

In situations where the driver is unable to continue driving, the vehicle can perform a controlled stop to reduce the risk of a collision. If this happens, your vehicle can automatically connect you to an emergency call center. ^[3]

Note

Not an emergency?

If you need help on the road but aren't in an emergency situation, press the assist button  to call Volvo Assistance instead. Volvo Assistance can help you in certain situations, such as if your vehicle's battery runs out of charge, your vehicle breaks down or you get a flat tire.

^[1] Availability varies between regions. Contact Volvo Support for more information.

^[2] For example, when safety features such as airbags or seat belt pretensioners have deployed.

^[3] The availability of this feature may differ between regions.

2.8.1. Calling emergency services with SOS button

A long press of the SOS button in the vehicle's ceiling connects you to an emergency call center. ^[1]

Note

Strictly for emergencies

Situations that could require immediate emergency assistance include traffic accidents, acute illness and external threats.

Not an emergency?

If you need help on the road but aren't in an emergency situation, press the assist button  to call Volvo Assistance instead. Volvo Assistance can help you in certain situations, such as if your vehicle's battery runs out of charge, your vehicle breaks down or you get a flat tire.

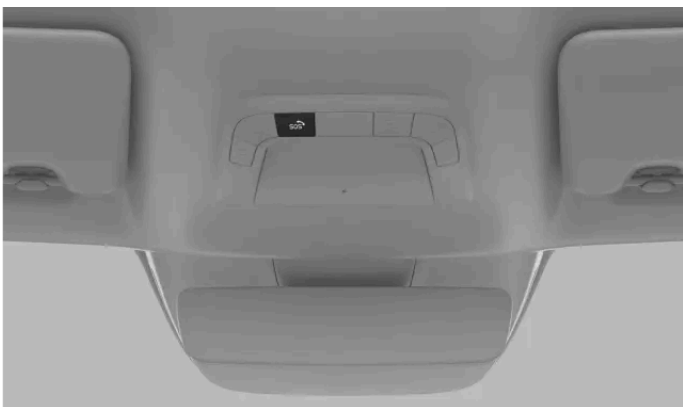

The SOS button is located on the roof, to the left of the overhead console.

1. Press and hold the SOS button for at least 2 seconds.



- > The vehicle makes a voice call to an emergency call center. It also sends information, such as its location and status. The emergency call center will try to communicate with you to find out what kind of help you need.

If the voice call fails, the emergency call center has the ability to respond based on information sent by the vehicle.

[1] Availability varies between regions.

2.8.2. Changing the emergency call recipient

When pressing the SOS button, your vehicle will make a call to a Volvo emergency service by default. If you want your vehicle to call an emergency center instead, you need to change this in your profile settings.

Note

Default settings

In some regions, the vehicle calls an emergency center by default instead of Volvo's emergency service.

Unable to change recipient?

The ability to change the emergency call recipient depends on your region and may vary over time.

1. Press the vehicle symbol  in the bottom bar and go to **Settings**.
2. Go to **Controls** → **More** → **SOS button calls Volvo Cars emergency service**.
3. Select one of the options.

2.9. HomeLink

HomeLink® lets you control other devices remotely, such as the garage door or an alarm system, and can be used instead of the original remote controls for these devices.

You can use the HomeLink app via the center display to remotely control other devices, such as garage doors, gates or an alarm system, from inside your vehicle.

 **Note**

Save the original remotes

You can still use the original device remotes as well as HomeLink if you want to. Make sure that you keep the original remotes, since you need them if you want to reconnect the devices, such as in a new vehicle.

Selling the vehicle

If you sell your vehicle, it's recommended that you delete the connection between the vehicle and the connected devices. You can delete devices in the HomeLink app via the center display. All devices will be deleted if you do a factory reset.

Setting HomeLink up

You set HomeLink up in the center display. Press the app library symbol  in the bottom bar and open **HomeLink**. Press **Begin** and follow the instructions in the center display. Make sure to have the original remote control for your device on hand because you will need it during the setup.

Using HomeLink

When you have connected a device to the vehicle, you can use the center display instead of the device's original remote. Press the app library symbol  in the top bar and open **HomeLink**. Then simply press the connected device to activate it and wait a few seconds for it to respond.

You can find more information about a connected device by selecting it via the center display. You can also change the device's name and icon, reprogram the device or delete it.

 **Warning**

If HomeLink is used to control a garage door or gate, make sure that nobody is near the door or gate while it is in motion.

Do not use HomeLink for any garage door that does not have safety stop and safety reverse.

 **Note**

After reprogramming a device

If you start to reprogram a device, it will be deleted from the list even if HomeLink can't create a new connection.

Using HomeLink while the vehicle is locked

It is not possible to use HomeLink if the vehicle is locked from the outside and the alarm is active.



Tip

HomeLink only works for a few minutes after all occupants have left the vehicle and the vehicle is left unlocked. To use HomeLink again, you need to have the key inside the vehicle.

If you experience any issues with HomeLink, contact their customer support at [homelink.com](https://www.homelink.com/) [<https://www.homelink.com/>].

3. Displays, software and phone

Explore how to interact with your vehicle. Here's where you can find more information on your vehicle's displays, connectivity features, sound and media, in-vehicle apps, software and voice control.



You can access most of your vehicle's functions via its displays, but there's also plenty you can do by using your phone.

An internet-connected vehicle makes remote access possible and keeps the vehicle up to date by downloading software updates. Learn how everything is connected.

3.1. Displays

The different displays show you information related to the vehicle and your driving. You can also control many of the vehicle's functions by interacting with the displays.

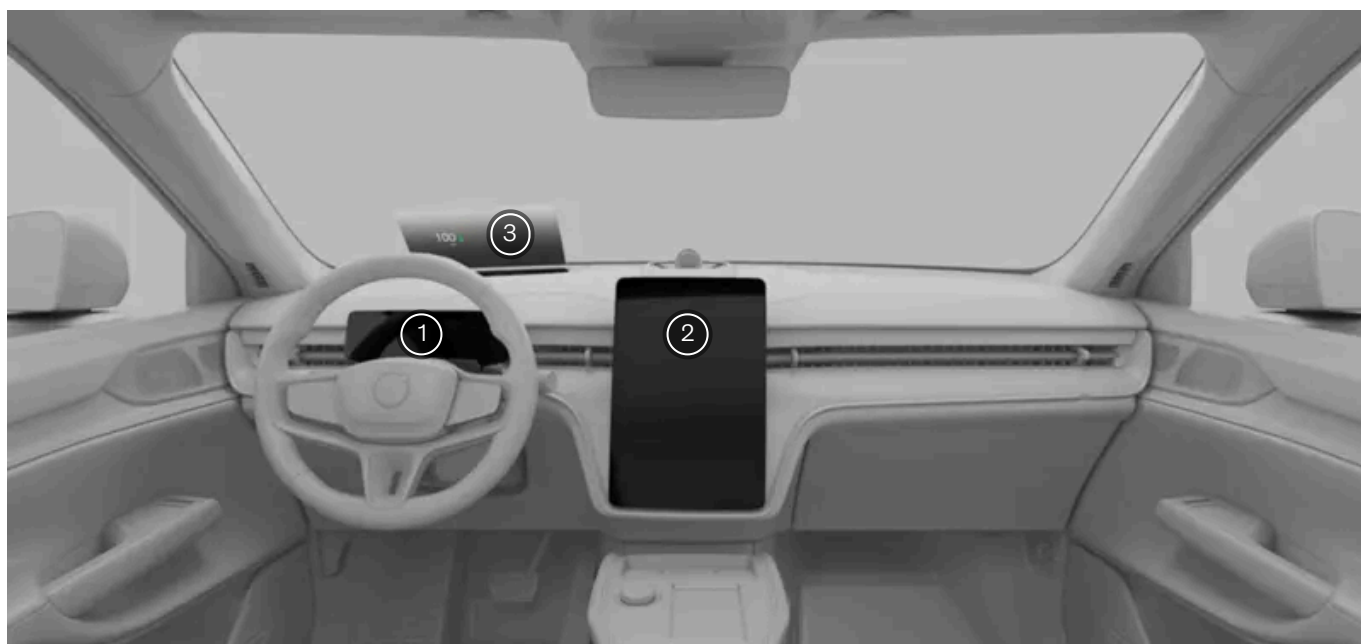

Locations of the displays

- ① Instrument panel
- ② Center display
- ③ Head-up display

i Tip

You can adjust the brightness for all of the displays via the lights and displays settings in the center display.

3.1.1. Center display

Interact with the center display to control and view information about many of the vehicle's features and functions.

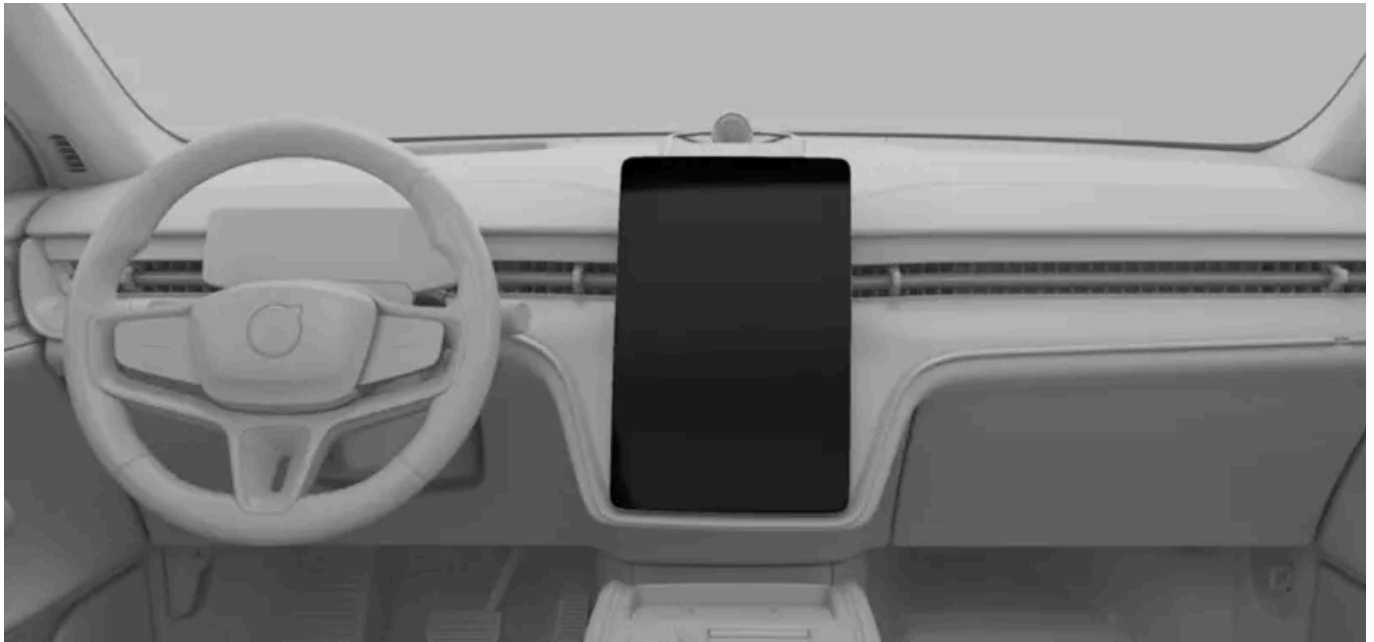

The center display sits in the middle of the dashboard.

Frequently used features such as climate, vehicle status and the app library can be accessed by pressing the symbols at the bottom of the display.

Examples of functions that can be viewed and controlled via the center display are:

- Navigation
- Media players
- In-vehicle apps
- Phone

 **Important**

Do not use sharp objects on the center display, as they may damage it.

3.1.1.1. Center display views

Learn about some of the views that you can see in the center display.

The various bars provide status information, display shortcuts to apps or quick controls, and allow you to navigate around the center display views. The main views let you use and access navigation information, in-vehicle apps, climate, vehicle status and settings. There are also some specialized views for managing specific vehicle functions.

Center display bars







The content of this manual represents the status of the user manual at the time of printing and may not be completely valid in future instances. For more information refer to the first page for the complete disclaimer note.

The status bar at the top of the center display shows you symbols relating to the vehicle's status and apps, along with the time and outside temperature. The bottom bar is your main way of navigating around the center display views. By pressing the symbols, you can get to other views and functions as well as access the comfort view and activate the hazard warning flasher. The status bar and bottom bar are always visible, regardless of which view you're looking at.

In some views, you will see the contextual bar appear above the bottom bar. This bar contains shortcuts to recently used functions or apps that only appear when you can use them. Sometimes these shortcuts are replaced by quick controls, which allow you to control ongoing phone calls and media when the associated views or widgets aren't visible.

Main views

The following list contains the main views that you will see and use in the center display.

Home view	The home view shows a large navigation map, and so it also works as the navigation view. There are widgets with quick controls for media and phone underneath the map. You can access the home view from other views by pressing the home symbol  in the bottom bar.
App library	You can access the manual, in-vehicle apps and the app store in this view. To get to this view, press the app library symbol  in the bottom bar.
Climate view	You can change a variety of climate settings in this view, such as activating or deactivating defrosters and adjusting settings for air conditioning. The climate view is accessed by pressing the fan symbol  on the bottom bar.
Vehicle overview	This view gives you access to the quick controls, settings and vehicle status tabs as well as user profiles. These come together to give you an overview of the vehicle, which can be accessed by pressing the vehicle symbol  on the bottom bar.
Quick controls view	This view gives you quick and easy access to some of the vehicle's functions, such as exterior lights and driver adjustments. You can get to the quick controls view by pressing the vehicle symbol  in the bottom bar.
Settings view	This view is where you can access all of the different settings tabs and views for your vehicle. You can get to the settings view by pressing the vehicle symbol  in the bottom bar.
Vehicle status view	This view shows you important information relating to your vehicle's status, such as issues that need to be resolved and their severity. You can also see the odometer and when your vehicle is due for a maintenance appointment. It can be accessed by pressing the vehicle symbol  on the bottom bar.

Specialized views

The following views are related to specific functions in the vehicle.

Comfort view	The comfort view appears when you press the seat symbol in the bottom bar that corresponds to the driver or passenger side. This view gives each side quick access to a few essential climate and comfort settings, such as seat heating and temperature control.
Adjustments view	You can adjust the seats, door mirrors, steering wheel and head-up display in the adjustments view. These are grouped together because they are related to your driving position. For example, if you change your seat position, you probably also need to adjust the door mirrors, steering wheel height and head-up display.
Parking view	The parking view contains features that help you park. When shown, it takes up most of the center display. If the parking view doesn't automatically appear when you need it to, you can open it yourself by pressing the camera symbol  in the contextual bar above the bottom bar.

Note

Driver distraction overlay

What you can see and do in the center display sometimes depends on whether the vehicle is moving or not. To minimize driver distraction while the vehicle is moving, some views become unavailable, such as certain settings. If this happens, the center display shows the driver distraction overlay. When the vehicle stops moving, the overlay disappears and you can interact with the view again.

3.1.1.2. Status symbols in the center display

Status symbols are shown in the status bar at the top of the center display. The symbols tell you important information about your vehicle's system status.











Symbol types

Some status symbols, such as the clock and temperature, will always be visible in the status bar. Others are only visible when a particular function is active, such as wireless charging, or even disabled. You will also see symbols that tell you when there is an error, such as when you have a Wi-Fi or mobile internet connection issue.

 **Note**

Make sure you look up any status symbols that you are unfamiliar with. They might not appear with any extra information or notifications.

This is a list of some status symbols that can appear in the status bar. It is not an exhaustive list, and you might also see status symbols in the status bar from third-party apps.

12:31	Clock	The clock shows you the current time. You can choose whether to display the time in the 12-hour or 24-hour format.
8°C	Outside temperature	This is the current ambient temperature outside the vehicle. You can choose to have the temperature displayed in degrees Celsius or Fahrenheit in the vehicle's system settings.
-8°C *	Outside temperature with snowflake	This is the current ambient temperature outside the vehicle. The snowflake appears when the outside temperature is low.
	Microphone is listening	The microphone is active and recording.
	Microphone is not listening	The microphone is not recording.
	New notification	There is a new notification in the notification center.
	Mobile internet signal	Mobile internet is active and being used by the vehicle. The number of bars indicates the signal strength.
	Mobile internet error	There is an issue with the mobile internet connection.
	Wi-Fi signal	Wi-Fi is enabled and active. The number of bars indicates the signal strength. If no bars are shown, this indicates that a Wi-Fi connection is active but there is no signal.
	Wi-Fi internet error	There is an issue with the Wi-Fi internet connection.
	Bluetooth connected	Bluetooth is enabled and a device is connected to the vehicle.
	Location	Your location is being shared.
	Wireless charging active	A device is charging on the wireless charger.
	Software updates available	New over-the-air software updates are available to download and install.



3.1.1.3. Keyboard

The center display keyboard appears any time you can enter text or numbers. You can customize many of its features in settings.

You can use the on-screen keyboard to write text or numbers. For example, when searching for a destination in the navigation app or entering the password for a Wi-Fi network.

The keyboard layout can change depending on the type of input field you are writing in.

The keyboard supports some alternative ways of inputting text. These include:

- Glide typing
- Speech-to-text
- Handwriting



Tip

You can download other keyboards to use by going to the app store in the app library.

3.1.1.3.1. Changing the keyboard language

You can change the language for the center display keyboard on the keyboard itself.

Change the keyboard language when you want to write text in a different language. This can be useful when you are driving abroad and need to search for a destination or address in the local language.



Note

To be able to change the keyboard language, you need to have more than one language available for the keyboard. If you only have one language available, the languages symbol won't be shown on the keyboard.

Changing language to the next available language

1. Press the languages symbol  at the bottom of the keyboard.
- > The keyboard language switches to the next one in the available languages list.

Changing language to any available language

The content of this manual represents the status of the user manual at the time of printing and may not be completely valid in future instances. For more information refer to the first page for the complete disclaimer note.

2. Press and hold the languages symbol  at the bottom of the keyboard.
 - > A list of available languages appears.
 3. Select the language you want to use.
 - > The keyboard language changes to the one you selected.
-



3.1.1.3.2. Adding and removing keyboard languages

You can add and remove keyboard languages in settings.



You can add languages to the center display's on-screen keyboard if you want to write in a language that isn't already available. Languages can also be removed from the keyboard if you find that you no longer need them.

1. Press the vehicle symbol  in the bottom bar and go to **Settings**.
2. Go to **System** → **Languages and input** → **Keyboard**.
3. Choose the keyboard you want to make changes to.
4. Select **Languages**.

Adding a language

5. Press the plus sign  above the currently available languages and search for your desired language.
6. Select the language you want to add, then press the download symbol .
- > The language is added to the list of languages available to use on your keyboard.

Removing a language

7. Press the edit symbol  above the list of currently available languages.
 8. Select the language you want to remove from the list of available languages, then press the trash can symbol .
 - > The language is removed from the list of languages available to use on your keyboard.
-

3.1.2. Instrument panel

The instrument panel shows notifications and information related to your driving and the vehicle itself.

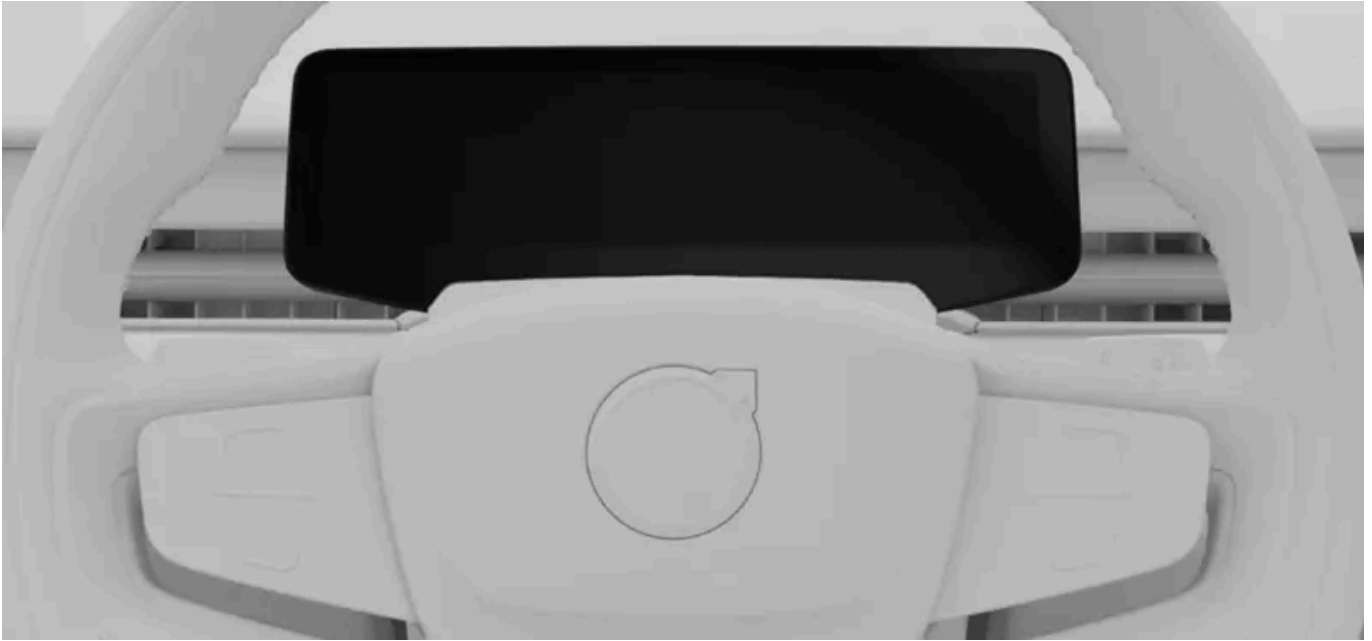

The instrument panel is located in front of the driver, behind the steering wheel. Its position changes along with the steering wheel when you adjust it to your preferred driving posture.

Use the steering wheel buttons to interact with the display and control what's shown on it.

Examples of information that can be shown in the instrument panel are:

- Warning and indicator symbols
- Speed
- Navigation
- Notification messages
- Battery meter
- Power meter

Display modes

There are three instrument panel modes that you can choose from: calm, map and surround. Use the buttons on the steering wheel to change the display mode.

Calm This displays essential information, such as speed, battery level and range, as well as warning and indicator symbols.

Map The instrument panel shows your current navigation route on a map, as well as essential driving and vehicle information.

Surround In this mode, you will see a depiction of the vehicle and its position on the road. The same essential information as calm mode is also displayed.

Important

Using surround mode

Surround mode cannot perfectly depict what is really happening on the road around you, so do not rely on it when you are driving.

 **Warning**

If the instrument panel turns off, doesn't turn on or is only partially legible, you must not use the vehicle. This is because the driver will not receive warnings and vehicle status information shown in the instrument panel, such as warnings and information relating to brakes, airbags or other safety systems. If there is an issue with the instrument panel, contact an authorized Volvo workshop.

 **Important**

Clear space around the instrument panel

Do not hang or place any objects on the steering column in front of or behind the instrument panel. You risk damaging the instrument panel if an object is placed there when the steering wheel position changes.

 **Tip**

You can change the instrument panel settings in the center display.

3.1.2.1. Warning and indicator symbols

The instrument panel symbols tell you the status of different systems in your vehicle. Some indicate whether a system is active and operating as it should, and others alert you to important information or detected faults.

Symbol types and colors

Some symbols are warnings that require immediate action, while others indicate the current status of specific functions. The symbol color roughly signifies the level of importance. Red symbols are the most critical, while amber symbols represent less urgent warnings and alerts. Symbols in other colors typically convey status information about the vehicle's functions.

 **Tip**

Be sure to look up the meaning of symbols you are unfamiliar with. Many symbols will appear with a notification providing more information.

BRAKE























Brake system warning A fault is detected in the brake system. Take immediate action and contact an authorized Volvo workshop.

PARK

Parking brake warning Continuous illumination indicates that the parking brake is engaged. Flashing indicates a parking brake fault.



System fault warning A fault is detected in the vehicle system. Take immediate action and contact an authorized Volvo workshop.

	Seat belt reminder	Someone in the vehicle isn't wearing their seat belt.
	Emergency call	There is an issue with the emergency call system.
	SRS warning	A fault is detected with the airbags or related safety systems. Take immediate action and contact an authorized Volvo workshop.
	Brake system warning	A fault is detected in the brake system.
	Anti-lock braking system warning	The anti-lock braking system is disengaged. The friction brakes still function but without anti-lock braking.
	Turn signal warning	A fault is detected with the turn signals.
	Vehicle propulsion system fault	There is a fault in the vehicle propulsion system. Have your vehicle checked in a workshop. Contacting an authorized Volvo workshop is recommended.
	Lane keeping aid fault	There is a fault with the lane keeping aid system. ^[1]
	Tire pressure warning	Constant illumination indicates low tire pressure. Flashing indicates a system fault or inability to measure the tire pressure.
	Air suspension warning	A fault is detected in the air suspension system.
	Stability system alert	A flashing symbol indicates that the stability system is intervening. A fault in the system is indicated by steady illumination.
	Front wiper failure	A fault is detected with the front wipers.
	Reduced performance alert	The vehicle's performance is reduced.
	Driver support system fault	There is a fault with the driver support system.
	Left lane keeping aid warning	You are too close to or crossing over the lane markings on the left-hand side of the vehicle.
	Right lane keeping aid warning	You are too close to or crossing over the lane markings on the right-hand side of the vehicle.
	Towbar unlocked	The towbar is unlocked.
	Rear fog light on	The rear fog light is on.
	Exterior lights malfunction	There is an issue with the exterior lights.
	Automatic high beam active	Automatic high beam is active.
	Manual high beam on	Manual high beam is on.
	Ready to drive	The vehicle has started and is ready to drive. This appears when the vehicle goes from being parked to being put into a driving gear. It disappears when the vehicle starts to move.

	Left turn signal	The left turn signal is active and indicating a left turn.
	Right-hand turn signal	The right turn signal is active and indicating a right turn.
	Parking lights	The position lights are on.
	Child lock	The child lock is active. Passengers in the rear seats can't open the rear doors or operate the rear windows.
	Hold	Hold is active.
	Charging cable connected	The charging cable is still connected to the vehicle.
	Automatic high beam enabled	Automatic high beam is enabled.
	Rain sensor	The rain sensor is active and the front wipers are in auto mode.
	Lane keeping aid off	Lane keeping aid is turned off or temporarily unavailable.

[1] When a fault is indicated, the function is disabled.

[2] Depending on the vehicle's current theme, this symbol can be a different color.

3.1.2.2. Battery meter

The battery meter shows the charge level percentage and estimated range of your vehicle.

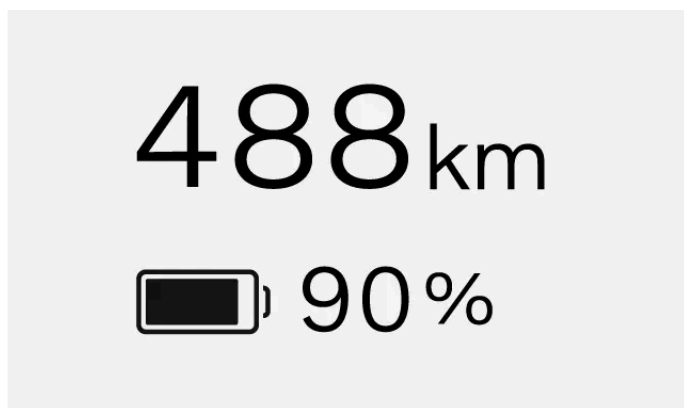

The battery meter is shown in the instrument panel at all times.

Remaining battery

The battery percentage indicates the level of charge left in your vehicle's battery.

The range tells you how far you can drive with the battery's current charge level. The estimated range is based on your historical driving patterns.

i Note

Driving style and external factors, such as outside temperatures and driving for prolonged periods at high speeds, can have different effects on the estimated battery range.

Cold battery indicator

When the vehicle has a cold battery, a snowflake ❄ appears next to the battery percentage. This indicates that the battery's charge capacity and range are reduced compared to normal conditions.

When the battery warms up – for example, while preconditioning the vehicle or when driving – the snowflake disappears from the instrument panel.

3.1.2.3. Power meter

The power meter tells you how and when the battery power is being used or regenerated.

The power meter is always visible in the instrument panel, and its appearance varies between instrument panel modes.

The different sections and colors of the power meter indicate different power uses or limitations. They can appear on their own or in combination with other sections.

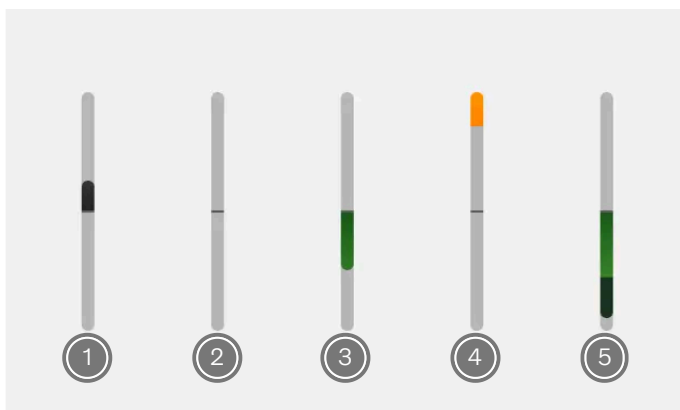

- 1 The vehicle is using power to move. The size of this section grows and shrinks with the amount of power being used.
- 2 This line is always visible. When you can see just the line by itself, it means that the vehicle is neither using nor regenerating power.
- 3 The vehicle's battery is regenerating power rather than using it. This can appear when decelerating or braking, or when easing up on the accelerator while using One Pedal Drive. The size of this section grows and shrinks with the amount of power being regenerated.

- ④ The vehicle isn't able to draw its normal amount of power from the battery, and the available power is reduced. This can appear in cold weather, when the battery percentage is low or when the vehicle's performance is reduced.
 - ⑤ The friction brakes are in use. You might see this section appear when the disc brakes are engaged or if the battery is full and can't store any more power. The more you apply the friction brakes, the larger the section becomes.
-

3.1.3. Head-up display

The head-up display projects information from the instrument panel onto the windshield in front of the driver.

The display unit, which projects the information through a glass cover, is located on the dashboard.

Examples of information that can be shown in the head-up display include:

- Speed
- Symbols relating to notifications that can be seen in the instrument panel
- Navigation directions

You can adjust the head-up display brightness and position, as well as turn it on or off in settings.

Note

Some factors may impair your ability to see the information in the head-up display. For example:

- wearing polarized sunglasses
- not sitting centered in the seat
- unfavorable light conditions.

Important

To avoid damaging the display, do not store any objects on the glass cover, and make sure that objects cannot fall onto it.

3.1.3.1. Adjusting the head-up display

You can adjust the brightness and position of the head-up display in settings.

1. Press the vehicle symbol  in the bottom bar and go to **Settings**.
 2. Go to **Controls** → **Lights and displays** → **Adjust head-up display**.
 3. Use the steering wheel buttons to adjust the brightness and position of the head-up display.
-

3.1.4. System settings

You can change the system settings so that the vehicle displays information in a way that suits you.

There are a number of system settings that you can change, including:

- System language
 - Time and date
 - Units of measurement
 - Keyboard languages
-

3.1.4.1. Changing time and date

You can manually change the time, date and local time zone in settings.

By default, your vehicle uses information from the internet to automatically change the time, date and local time zone for you. You can also manually change these, as well as the time format, in settings.

1. Press the vehicle symbol  in the bottom bar and go to **Settings**.
 2. Go to **System** → **Date and time**.
 3. If **Automatic date and time** and **Automatic time zone** are enabled, turn them off.
 4. Select your desired setting and make any changes.
- > The changes are shown on the displays.
The clock in the center display's status bar updates if you made changes to the time settings.



Tip

To change the time format, turn it on for 24-hour format or off for 12-hour format.

3.1.4.2. Changing the system language

You can change the language of the vehicle's system in settings.

If you want your vehicle's systems to use a language that is different from the current language, you need to change the system language.



Important

Only select a system language that you can fully understand. The vehicle communicates safety-critical information and notifications to you through messages, so you need to be able to understand them at all times.

1. Press the vehicle symbol  in the bottom bar and go to **Settings**.
 2. Go to **System** → **Languages and input** → **Languages**.
 3. Choose the language you want to change to.
- > The new language is shown in the displays.

3.1.4.3. Changing system units

You can go to setting to changes the units of measurement, such as for speed and distance.



Tip

When driving abroad, it can be useful to change the vehicle's units of measurement to match the local ones. It can be especially helpful if road signs display distances and speeds in units that are different from those currently displayed in your vehicle.

1. Press the vehicle symbol  in the bottom bar and go to **Settings**.
2. Go to **System** → **Units**.

3. Select the units of measurement you want the vehicle to display.

> The vehicle displays units in the new format.

3.1.5. Restarting the displays

You can restart the displays using the play/pause button on the center console.

If you are having problems with the displays, restarting them might resolve any issues. Problems with the displays include a frozen display, center display not starting or the vehicle not being able to connect to the internet.

To restart the displays, the vehicle must be at a standstill and not moving.

1. Press and hold the play/pause button on the center console until the Volvo logo appears. It might take some time for the logo to appear.



> The displays restart.

i Note

Ignore any messages that appear in the center display when you are pressing and holding the play/pause button.

3.2. Phone

Connect your phone to the vehicle via Bluetooth to be able to use it while driving. When you are away from your vehicle, you can also use your phone to read the manual or use some vehicle features remotely via the Volvo Cars app.

Connect your phone to your vehicle

The content of this manual represents the status of the user manual at the time of printing and may not be completely valid in future instances. For more information refer to the first page for the complete disclaimer note.

Connecting your phone to the vehicle via Bluetooth allows you to use it through the vehicle's interface. You can also stream media directly from your phone to the vehicle, as well as share its internet connection.

You can use voice control or the center display to search for your contacts, make and receive phone calls, and respond to text messages without even touching your phone.

Other uses for your phone

Using your phone with your vehicle isn't limited to just when you're inside the vehicle. Download the Volvo Cars app to remotely use certain vehicle functions or read the manual when you're away from the vehicle.

3.2.1. Connecting your phone to the vehicle

Connect your phone to the vehicle via Bluetooth to use your phone through the vehicle's interface.

Bluetooth must be enabled for both the vehicle and your phone for them to be able to pair. You can turn Bluetooth on in settings. Make sure that your phone is set as discoverable so that the vehicle can find it when pairing.

1. Press the vehicle symbol  in the bottom bar and go to **Settings**.
 2. Go to **Connectivity** → **Bluetooth** → **Found devices**.
 3. Choose the device you want to pair the vehicle with from the list of discovered devices.
 4. Check that the confirmation code in the center display matches the one shown on your phone.
 5. Accept the settings and permission requests that appear on your phone.^[1]
- > Your phone is now connected to the vehicle. It will automatically connect next time, as long as Bluetooth is enabled on your phone.

Note

You can have multiple phones paired with the vehicle, but only one can be connected to the vehicle at a time. To change the active phone, select it from the list of paired devices or add a new device.

^[1] You can still connect your phone to the vehicle even if you skip over permission requests, but there will be reduced functionality.

3.2.2. Using your phone in the vehicle

The content of this manual represents the status of the user manual at the time of printing and may not be completely valid in future instances. For more information refer to the first page for the complete disclaimer note.

You can use your phone via the center display and voice control.

 **Important**

Make sure that you comply with all local laws and regulations regarding mobile phone use while driving.

 **Note**





You need to connect your phone to the vehicle via Bluetooth and accept the corresponding phone settings permissions to be able to use these features.



Calling

There are a few different ways you can make and receive phone calls while in your vehicle. You can:

- answer and decline incoming calls using the center display
- call someone while driving by asking the digital assistant to make the call for you
- use the in-vehicle phone app via the center display to call contacts, or enter a phone number using the on-screen keypad.

When you have an ongoing call, it will be shown in the center display. If you open the in-vehicle phone app when you have an ongoing call, you can:

- mute and unmute your microphone 
- change the sound input and output, such as through the vehicle or your mobile phone's microphone and speakers 
- end the call 
- put the call on hold by pausing it 
- use the keypad to input numbers, such as when asked to select an option in a service menu .

If you receive a second phone call while in the middle of an ongoing call, answering the second phone call automatically puts the first one on hold. You can switch between the two calls  or create a conference call and speak to both callers at the same time .

Messaging

You can write and send text messages via the digital assistant using voice control^[1]. If you receive a text message, a notification will appear in the center display with the following options:

- **Play** to hear the digital assistant read the message out loud.
- **Mute** to stop receiving new message notifications from this specific conversation for the rest of the time you are in the vehicle.

You can also ignore the notification and view it later in the notification center.

Looking through and searching for your contacts

Use the in-vehicle phone app to search for a specific contact by:

- pressing the search symbol 
- going to the contacts tab and typing their name
- going to the keypad tab and entering their number.

You can also just ask the digital assistant to find the contact you are looking for.

^[1] Only applies to Android phones or phones with iOS 13 or later.

3.2.3. Switching between paired phones

You can change which Bluetooth-paired phone the vehicle is connected to in settings.

The vehicle can connect to and remember multiple phones, but it can only be actively connected to one phone at a time.

If you want to switch the Bluetooth connection to a new device, you need to pair it with the vehicle first. You can do this in settings.

Before trying to switch to a different paired device, make sure that Bluetooth is enabled on the device you want to switch to.

1. Press the vehicle symbol  in the bottom bar and go to **Settings**.
 2. Go to **Connectivity** → **Bluetooth** → **Saved devices**.
 3. Press the name of the phone you want to connect to.
- > If the connection is successful, the phone's name moves to the top of the saved devices list.

If you can't see the device you want to switch to in the saved devices list, try pairing it with the vehicle again.

3.2.4. Apple CarPlay

Activate Apple CarPlay to use your iPhone wirelessly via the vehicle.

Apple CarPlay gives you another way of using your iPhone via the vehicle's interface. You can use certain communication, navigation and media apps on your iPhone via the center display, as well as the steering wheel buttons and voice control.

 **Important**

Local laws and regulations

Make sure that you comply with all local laws and regulations regarding mobile phone use while driving.

CarPlay content

Volvo does not accept responsibility for the content available in Apple CarPlay.

 **Note**

Phone compatibility and supported apps

Apple CarPlay only works with iPhones, but it doesn't work with all iPhone models. To find out if your iPhone is compatible or to learn more about which apps are supported, go to Apple's website www.apple.com/ios/carplay.
[\[https://www.apple.com/ios/carplay\]](https://www.apple.com/ios/carplay).

 **Tip**

Keep your iPhone and apps updated to the latest versions.

Connect your iPhone and start CarPlay

Connect your iPhone to the vehicle via Bluetooth and activate Apple CarPlay. After setting up CarPlay for the first time, it automatically starts when you connect your phone via Bluetooth again.

CarPlay view

You can access the CarPlay view by opening the CarPlay app in the app library. If the CarPlay symbol  is shown in the contextual bar, you can also access the view by pressing this symbol.

Once active, the CarPlay view takes up the whole of the center display. However, the bottom bar, contextual bar and status bar will still be visible at all times if you want to return to the vehicle's own system.

Navigation with CarPlay

You can use navigation apps on your iPhone via Apple CarPlay. If you start a navigation route via CarPlay, you can see the guidance in the center display's CarPlay view, as well as in the instrument panel. If you are following a navigation route in the vehicle's own navigation app and then start another navigation route in CarPlay, instrument panel navigation using the vehicle's own app will end.

Using Siri

If you want to use Siri instead of the vehicle's in-built digital assistant, press and hold the voice control button  on the steering wheel while CarPlay is active.

You can use Siri to read out, write and send messages. Siri will read and write messages in the language selected in the Siri settings on your iPhone. If you write a message via Siri, the center display won't show you your message, but it will be displayed



on your iPhone.

3.2.4.1. Connecting your iPhone to Apple CarPlay

Connect your iPhone to the vehicle via Bluetooth to start using Apple CarPlay.

Bluetooth must be enabled for both the vehicle and your phone for them to be able to pair. You can turn Bluetooth on in settings. Make sure that your phone is set as discoverable so that the vehicle can find it when pairing.

To be able to use CarPlay, you need to activate Siri on your iPhone and have an active internet connection. You also need to turn the vehicle's Wi Fi off, as CarPlay can't be active while Wi Fi is enabled.

1. Press the vehicle symbol  in the bottom bar and go to **Settings**.
 2. Go to **Connectivity** → **Bluetooth**.
 3. Select your iPhone from the list of discovered devices.
 4. Check that the confirmation code in the center display matches the one shown on your phone.
 5. On your iPhone, consent to using CarPlay.
 6. In the vehicle's center display, read and accept CarPlay's terms and conditions.
- > Your iPhone connects to CarPlay, and the CarPlay view opens in the center display. A CarPlay symbol  also appears in the status bar to indicate that CarPlay is active.

CarPlay automatically starts the next time you connect your iPhone via Bluetooth.



Tip

You can disconnect from CarPlay but keep your iPhone connected to the vehicle by pressing the CarPlay symbol  next to your device's name in the vehicle's Bluetooth settings.

3.2.5. Android Auto™

Connect your phone via Bluetooth and activate Android Auto™ to use your Android™ phone through the vehicle.

Android Auto gives you another way to use your Android phone via the vehicle's interface. With Android Auto, you can safely access your phone's communication, navigation and media apps via the center display as well as the steering wheel buttons.

 **Important**

Local laws and regulations

Make sure that you comply with all local laws and regulations regarding mobile phone use while driving.

Android Auto content

Volvo does not accept responsibility for the content available in Android Auto.

 **Note**

Phone compatibility and supported apps

Android Auto only works with Android phones, but it doesn't work with all phone models. To find out if your phone is compatible or to learn more about which apps are supported, go to Android Auto's website www.android.com/auto/ [<https://www.android.com/auto/>].

Google Trademarks and compatibility

Google, Android and Android Auto are trademarks of Google LLC. Compatible Android phone and compatible active data plan required.

 **Tip**

Keep your phone updated

Keep your phone and apps updated to the latest versions.

Connect your Android phone and start Android Auto

 **Note**

Make sure your phone has at least Android 9.0 and an active internet connection

To be able to use Android Auto, you need to have Android 9.0 or higher installed on your phone and an active internet connection.

Connect your Android phone to the vehicle via Bluetooth and activate Android Auto. If you are using Android Auto for the first time, you need to accept the terms and conditions in the center display. Android Auto will then start. If you have used Android Auto before, it will automatically start when you connect your phone to the vehicle.

Android Auto view

You can access the Android Auto view by opening the Android Auto app in the app library. If the Android Auto symbol  is shown in the contextual bar, you can also access the view by pressing this symbol.

Once active, the Android Auto view takes up the entire the center display. However, the bottom bar, contextual bar and status bar will still be visible at all times if you want to return to the vehicle's own system.

Navigation with Android Auto

You can use navigation apps on your phone via Android Auto. If you start a navigation route via Android Auto, you can see the guidance in the center display's Android Auto view as well as in the instrument panel. If you are following a navigation route in the vehicle's own navigation app and then start another navigation route in Android Auto, the instrument panel navigation for the vehicle's own app will end.

Using Google Assistant

Talk to Google Assistant on Android Auto to carry out tasks with your voice so that you can keep your focus on driving. To use Google Assistant, just say "Hey Google" or press and hold the voice control button  on the steering wheel while Android Auto is active.



You can use Google Assistant to carry out tasks such as sending messages, getting directions or controlling media.

3.2.5.1. Connecting your Android™ phone to Android Auto™

Connect your Android phone to the vehicle via Bluetooth to start using Android Auto.

Bluetooth must be enabled for both the vehicle and your Android phone for them to be able to pair. You can turn Bluetooth on in settings. Make sure that your phone is set as discoverable so that the vehicle can find it when pairing.

You need to turn the vehicle's Wi-Fi off since Android Auto can't be active while Wi-Fi is enabled.

1. Press the vehicle symbol  in the bottom bar and go to **Settings**.
 2. Go to **Connectivity** → **Bluetooth**.
 3. Select your Android phone from the list of discovered devices.
 4. Check that the confirmation code in the center display matches the one shown on your phone.
 5. In the vehicle's center display, read and accept Android Auto's terms and conditions.
- > Your phone connects to Android Auto and the Android Auto view opens in the center display. An Android Auto symbol  also appears in the status bar to indicate that Android Auto is active.

Android Auto automatically starts the next time you connect your phone via Bluetooth.

3.3. Sound and media

Listen to music and media through the vehicle's sound system. You can adjust how it sounds in settings.

Sound settings

There is a variety of sound settings for you to customize your sound experience. The sound system also supports Dolby Atmos.

Radio and media players

You can listen to live radio via the pre-installed radio app and stream media from your phone to the vehicle via the Bluetooth media player.

Your vehicle also comes with SiriusXM so you can listen to satellite and IP radio.



Tip

You can find and download more third-party media apps via the vehicle's app store.

Controlling media playback

You can control media playback in a number of ways by using:

- media playback controls in the center display
- the media knob on the center console
- the steering wheel buttons
- voice control.

3.3.1. Radio

Use the pre-installed radio app to listen to live radio in your vehicle.

HD Radio™



HD Radio^[1] allows the vehicle to receive digital versions of radio stations. Listening to digital radio can give you better sound and a smoother listening experience. You can see the HD Radio symbol  in the radio app's stations list and the HD Radio logo in the now-playing view. The symbol and logo change appearance depending on whether you are listening to an HD Radio station or not.

HD Radio is turned on by default. You can find the setting to turn it off or on by pressing the settings symbol  at the top of the radio app.

Note

If the radio switches between digital and standard FM versions of a radio station, you might notice changes in the sound, such as volume, tone and timing. This is normal and doesn't mean that there is anything wrong with the radio. If this happens repeatedly when you're in a particular area, it might be a good idea to turn HD Radio off until you leave that area.

Radio favorites

You can add stations to your radio favorites list for quicker access.

Tip

You can find and download other radio apps via the app store.

^[1] HD Radio™ and the HD, HD Radio, and “Arc” logos are proprietary trademarks of iBiquity Digital Corp.

3.3.1.1. Adding radio favorites

You can add radio stations to the favorites list in the radio app.

Add the radio stations you listen to frequently to the favorites list for quicker access. You can add up to 50 radio stations to the list.

1. Press the app library symbol  on the bottom bar and open the radio app.

2. Find the station you want to add as a favorite from the list of currently available radio stations.
 3. Press the star symbol ☆ to the right of the station name.
- > The appearance of the station's star symbol changes and the radio station appears in the favorites list.

If you want to remove a station from the favorites list, just press the star next to its name.

3.3.2. Sound settings

You can change and adjust a variety of sound options in settings.

Focus

You can choose from four sound focus settings: all, driver, front and rear. All is the default setting and doesn't focus the sound in a particular direction. It provides a neutral sound focus where occupants in the front and rear seats have the same sound experience. The driver setting focuses the sound towards the driver. The front setting focuses sound towards the front seats, while the rear setting focuses it towards the rear seats.

Stage

By default, intensity and envelopment are set to a neutral level. Increase or decrease these settings to customize your sound experience.

Abbey Road Studios

Choose from five different settings to change and experience the sound as if you are in London's Abbey Road Studios.

Tone and equalizer

Customize how your media sounds by adjusting the values for the different tone qualities. Turn the equalizer on to adjust the sound frequencies to your preferences. If you decide that you don't like your equalizer adjustments, just press **Reset levels** to return the levels to the default settings.

Volume

You can adjust the volume of a variety of sounds via the center display, such as:

- Media
- Ringtone
- Calls
- Voice assistant
- Navigation
- Notifications
- Park assistance



Tip

There are other ways to adjust the volume of sounds in your vehicle. You can turn the media knob on the center console, press the steering wheel buttons or use voice control.

Voice amplification

Voice amplification can help you hear people in other seat rows better via the sound system. You can choose the amplification to be low, medium or high, or simply turn it off. The setting resets to off by default after each drive.

You can also choose to amplify the front seats only. Just turn this setting on when voice amplification is active or turn it off to amplify all seat rows in the vehicle again.

3.3.3. Media players

Your vehicle comes with a pre-installed media player. You can download more third-party media apps from Google Play in the app library.

Your vehicle comes with the Bluetooth media player pre-installed in the app library.

Use the Bluetooth media app to stream media from a Bluetooth-connected device straight to the vehicle.

3.4. In-vehicle apps

All of the vehicle's apps can be found in the app library.

You can access the app library by pressing its symbol in the bottom bar.



App library symbol

The apps in the library are shown in chronological order, starting with the app installed first and ending with the most recently installed app.

Some apps are pre-installed, such as Bluetooth media, Google Maps and Google Assistant. You can search for and download new apps via Google Play, which can be accessed in the app library.

3.4.1. Downloading apps

Download more apps to your vehicle from the app store in the app library.

Your vehicle comes with some apps pre-installed, but you can find and download more in the app store.

1. Press the app library symbol  in the bottom bar.
 2. Press **Get more apps** to go to the app store.
 3. Search for the app you want to download.
 4. Download and install your desired app.
- > If the app is successfully downloaded and installed, it appears in the app library.

3.4.2. Uninstalling apps

You can uninstall apps you no longer want or use in the app library.

 **Note**

Pre-installed apps, such as phone and radio, can't be uninstalled.

1. Press the app library symbol  in the bottom bar.
 2. Find the app you want to uninstall, then press and hold the app until a menu appears.
 3. Select **Uninstall** from the menu.
 4. Press **Uninstall** to continue uninstalling the app.
- > The app is uninstalled and disappears from the app library.

3.5. Connectivity and software

Connect your vehicle to the internet to get more from your vehicle and receive over-the-air software updates.

Internet connectivity

Connect your vehicle to the internet via the vehicle's built-in mobile network connection, Wi-Fi or a Bluetooth-connected mobile phone.

Software updates

Over-the-air updates keep your vehicle's software up to date.

3.5.1. Internet connection

Connecting your vehicle to the internet gives you access to certain features and over-the-air software updates.

There are several ways to connect your vehicle to the internet:

- Mobile network
- Wi-Fi network
- Bluetooth-connected phone tethering

Mobile network

Your vehicle has a built-in modem for connecting to a mobile network. The mobile internet connection is set up before you get your vehicle and is included for a certain number of years. As long as the vehicle has an active mobile network service plan and it's in an area with network reception, it can connect to the internet. Contact an authorized Volvo workshop for information about mobile connectivity services for your vehicle.

The vehicle supports mobile networks up to, and including, 5G. The available mobile network speeds depend on the SIM card installed in your vehicle.

Note

Mobile network connectivity conditions and limitations

- The vehicle needs to be in an area with mobile network reception.
- Mobile connectivity services must be active for the region where the vehicle is located.
- Obstacles such as buildings, hills and mountains can weaken or block the mobile network signal.

Wi-Fi

You can connect the vehicle to a Wi-Fi network for internet access. The vehicle can automatically connect to the network whenever it is within range.

Bluetooth-connected phone tethering

When a phone is connected to the vehicle via Bluetooth, the vehicle can use the phone's mobile internet connection. To do this, Bluetooth tethering needs to be enabled for the phone in the vehicle's connectivity settings. Both the phone and mobile network provider need to support sharing an internet connection through tethering.

Internet connection settings

You can find the connectivity settings in the center display.



3.5.1.1. Connecting to the internet via a Bluetooth-connected phone

Connect your phone to the vehicle via Bluetooth and share its internet connection.

 **Note**

Sharing your phone's mobile internet connection with the vehicle will affect the amount of mobile data you use. Some mobile data providers might not allow this kind of data use. It's possible that the amount available will be limited or that your provider may charge you extra for it. Make sure you check your provider's conditions for data usage before activating Bluetooth tethering.

You need to connect your phone to the vehicle via Bluetooth before you can share your phone's internet connection.

1. Press the vehicle symbol  in the bottom bar and go to **Settings**.
 2. Go to **Connectivity** → **Bluetooth**.
 3. Press the Bluetooth tethering symbol  for the phone that you want to share the internet connection from.
 4. Press **Accept** to continue with the tethering activation.
- > The Bluetooth tethering symbol changes color, indicating that tethering is now active.
-

3.5.1.2. Connecting to the internet via Wi-Fi

Connect your vehicle to a Wi-Fi network for internet access.

1. Press the vehicle symbol  in the bottom bar and go to **Settings**.
2. Go to **Connectivity** → **Wi-Fi**.
3. Enable Wi-Fi if it is disabled.
4. Select the Wi-Fi network you want to connect to.
5. Enter the Wi-Fi network password using the center display keyboard and press **Confirm**.

The content of this manual represents the status of the user manual at the time of printing and may not be completely valid in future instances. For more information refer to the first page for the complete disclaimer note.

> The vehicle connects to the Wi-Fi network.

3.5.2. Over-the-air updates

Over-the-air updates keep your vehicle's software up to date.

When your vehicle is connected to the internet, it can receive over-the-air^[1] updates to keep the vehicle's software up to date. Your vehicle will tell you when there is an update available to download and install by displaying the update symbol  in the status bar, as well as a notification.

You can also check for new software updates by going to **System** → **System details** → **Software update** in settings.

Automatic software downloads

You will be asked if you want to enable automatic software downloads when you set up your vehicle for the first time. You can always choose to enable or disable automatic downloads at a later time in settings. If you decide not to enable them, you will be asked for consent to download software updates whenever they are available.

Installing software updates

When a new software update is available, the vehicle will download the update but it won't install it for you. You need to start the installation yourself, either via a notification in the center display or in the software update view. You can also choose to postpone the update so that it installs at a later time or cancel the installation after confirming it.

You can't access or use your vehicle while a software update is installing. Therefore, make sure that there is sufficient remaining battery charge and that you don't need to use your vehicle during the installation process. The vehicle will tell you how much battery charge you need to start the installation and give you an estimate of how long it will take to install the update.

Note

Installation issues

There might be updates that you can't install yourself. If this happens, you will see a notification in the center display telling you what to do next.

Don't use the diagnostic port

Don't use the diagnostic port while a software update is installing. Using the diagnostic port during installation might affect the vehicle's systems and the software update.

Alarm disabled

To avoid any false alarms, the vehicle's alarm is disabled during the software installation process.

^[1] OTA

3.6. Voice control

Keep your hands on the wheel and use your voice to interact with the vehicle via the digital assistant.

With the help of the digital assistant, you can use voice control to carry out tasks, such as searching the internet and getting weather forecasts. You can also use your voice to interact with the vehicle and control a number of its functions, including:

- Media player
- Phone
- Navigation
- Climate

Speaking to the digital assistant

The assistant understands everyday speech, so you don't need to know any specific voice commands to use it. You can ask the assistant anything, and it responds by confirming what you said, then doing what you asked. It will let you know if it doesn't understand you.

 **Note**

- The voice control feature is from a third-party supplier. Availability, how to use it and how it works may vary over time and between regions.
- A poor internet connection may limit the number of available functions.

3.6.1. Using voice control

Use your voice to control and interact with a number of the vehicle's functions via the digital assistant.

The only time you need to use specific voice commands to interact with the digital assistant is when you activate it. After activating the assistant, just speak or give instructions to it using everyday phrases.

Note

Google Assistant isn't available in every language yet. Find out more at support.google.com or try to use another language if you can.

1. Say "Ok Google" or "Hey Google" to activate Google Assistant.
 - > The assistant confirms that it's listening.
2. Speak or give instructions to the digital assistant using everyday phrases.

Tip

Other ways to activate

You can also activate the digital assistant by pressing the steering wheel button and via the center display.

Sign in to your Google account

If you sign in with a Google account, Google Assistant will be more personalized when the vehicle is online. For example, you can easily call contacts stored in your Google contacts or check what's in your Google Calendar.

4. Interior comfort and climate

Get familiar with your vehicle interior and the controls for seat adjustment, climate and windows.



Your vehicle is equipped with multiple features to assist you in your driving. While some features are mainly for comfort, others improve visibility. Reading this section of the manual can assist in making your driving experience more comfortable.

4.1. Interior

Get to know the interior layout and its practical features, such as cup holders and charging ports for your devices.



Interior walk-through

It's good to know the names and locations of a few places and components, as they are referenced throughout the manual.

Passenger compartment	The passenger compartment is divided into the front and rear passenger compartment.
Trunk	The trunk, or cargo area, is the space behind the rear seats, which you typically access from behind the vehicle.
Dashboard	The dashboard refers to the whole set of panels and components in front of the driver and front passenger. It has some of the main areas for interaction, such as displays, steering wheel, air vents and glove compartment.
Center console	The center console sits between the front seats. This is where you will find volume controls, storage compartments, a wireless charger, a cup holder and a rearward-facing utility panel. You can also find USB ports at both the front and back of the center console.
Overhead console	The overhead console sits on the roof against the windshield. It provides easy access to certain important functions and indicators. This is also where you will find the front seat reading lights.
Door control panel	Each door has its own set of controls for windows and locks.

4.1.1. Using the wireless charger

Use the wireless charger to charge Qi-certified devices, such as a phone.



To use the wireless charger, your device should be certified to the Qi wireless charging standard. Also make sure that wireless charging is enabled on both the device^[1] and on the charger itself. You can enable the charger in the center display.

Warning

Wireless charging may affect the operation of a pacemaker or other implanted medical devices. If you have one, consult your doctor before using the wireless charging system.

 **Important**

NFC cards and charging

Do not place cards with NFC, such as key cards or electronic payment cards, between the wireless charger and the device when using the charging function. This could damage them.

If you have any cards or other sensitive items in your phone case, remove them before charging or make sure that they aren't in between your phone and the charger.

Before charging a device, make sure there are no other objects on the charger.

1. Place the device in the middle of the charger.
- > The device starts charging, and the integrated cooling fan activates. The charging symbol is visible in the center display status bar.

 **Warning**

Never leave your phone on the wireless charger when you leave the vehicle.

 **Note**

- Your results may differ when charging different devices: For example, the time it takes before charging starts and how quickly a device is fully charged.
- Your device might get hot during charging. This is normal and nothing to worry about. If the device battery gets too hot, charging is deactivated.

If the device doesn't charge

If your device doesn't charge when placed on the charger, here are some steps you can try:

- Make sure you have enabled the charger in the center display.
- Make sure there are no items on the charger apart from the device you want to charge.
- Lift the device and then place it back in the middle of the charger.
- Remove any cases or covers from the device.
- Disable the device's NFC function if it has one.

[1] Many Qi-certified devices are always enabled

4.1.2. Enabling the wireless charger

You can enable or disable the wireless charger in the center display.

The charger has to be enabled before you start using it.

1. Press the vehicle symbol  in the bottom bar and go to **Settings**.
2. Go to **Controls** → **More** → **Wireless device charging**.
3. Turn the charger on.

4.1.3. USB ports

You can use your vehicle's USB ports to charge phones, tablets, and other devices.

Location of the USB ports



There are two USB ports^[1] under the center display.



There are also two USB ports ^[1] in the rear part of the center console.

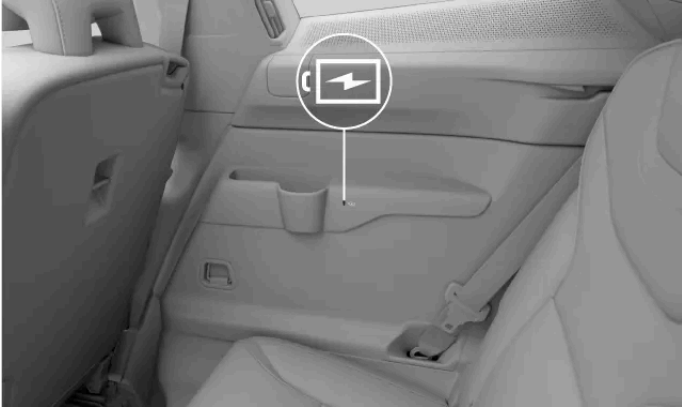

Finally, for the third-row passengers, there is one USB port in each side panel.

Using the USB ports

Always disconnect devices from the ports when not in use.

Some devices may become hot during charging. This is normal.

The ports are disabled after you leave the vehicle. If you leave the vehicle unlocked, the ports will remain active for a while longer.

USB port specifications

The power output from the USB ports depends on the device you are charging. The voltage and current is modulated to what the device will accept.

- Type C port
- Max. power output 18 W
- Supports Quick Charge 3.0

^[1] type C

4.1.4. 12 V socket

You can use the 12 V socket to power various electrical devices, such as a cool box.



The 12 V electrical socket is on the right-hand side in the trunk.

The vehicle turns off power to the outlet automatically when you leave the vehicle. If you leave the vehicle unlocked, the socket remains active for a while longer.

Always disconnect devices from the outlet and close the cover when not in use.

Some devices may become hot when charged through the 12 V outlet. This is normal for many devices.

Warning

Failure to observe the following instructions could cause damage or personal injury.

- Do not use electrical devices with large, heavy plugs. They can damage the outlet or come loose while driving.
- Do not use electrical devices that could interfere with the vehicle's systems, such as the radio receiver.
- Only connect undamaged and fully working devices that meet all relevant safety standards^[1].
- Keep an eye on connected devices to prevent damage or injury if they malfunction.
- Do not connect adapters or extension cables to the 12 V socket, as they can override the socket's safety features.
- Do not expose the socket, connectors, or connected devices to water or other liquids.
- Do not touch or use the socket if it appears to be damaged or has come into contact with water or other liquids.

Power rating

Important

The maximum power draw is 120 W (10 A).

4.1.5. Sun visors

There are sun visors overhead in front of the driver's seat and the front passenger seat.



The visors can be folded down and angled to the side when necessary. With the sun visor angled to the side, you can also extend the rod holding the sun visor for better positioning.

There is a covered mirror in the sun visor. The mirror light comes on automatically when you open the cover.

There is also a clip on the sun visor that can be used to conveniently store cards, tickets, etc.

4.2. Comfort

Your vehicle has several features designed to enhance your comfort while driving or parked.

While many of your vehicle's features are designed to enable safe driving practices, others are more focused on enhancing your comfort. This includes certain climate features and comfort modes.

Climate

Your vehicle has the ability to provide a comfortable climate in the passenger compartment. It can cool, heat and dehumidify the air for you when needed. There are also built-in features for providing good air quality.

Many of the climate features are automatic, while others can be adjusted manually.

Seats

The front seats of your vehicle are adjustable. While a good driving posture is necessary for visibility and safe driving practices, adjusting your seat also enables better comfort while driving or parked.

In colder temperatures, it's nice to heat your seat for a more comfortable driving experience. When it's warm outside, you can activate seat ventilation instead. You can activate and adjust the seat heating and ventilation via the center display.

Your front seats are also equipped with a massage feature. You can choose from five different massage programs with three different speeds and intensities.

Heated steering wheel

The steering wheel has built-in heating, which can provide comfort in colder temperatures. You can activate and adjust the steering wheel heating via the display.

Keeping climate active while parked

You can maintain a comfortable interior climate in your vehicle while it is parked. This includes keeping the climate functions and the entertainment system on. You can activate the keep climate active function via the center display. Just be aware that range may be affected if you leave this setting on for too long.

4.3. Climate

Your vehicle has the ability to provide a comfortable climate in the passenger compartment. It will cool, heat and dehumidify the air for you when needed. There are also built-in features which will provide good air quality.



This section of the manual covers the various climate features in your vehicle, such as air conditioning, climate modes and heating options.

4.3.1. Climate controls

You can control the vehicle's interior climate through various means, both from inside the vehicle and from your phone.



Climate controls in the front passenger compartment

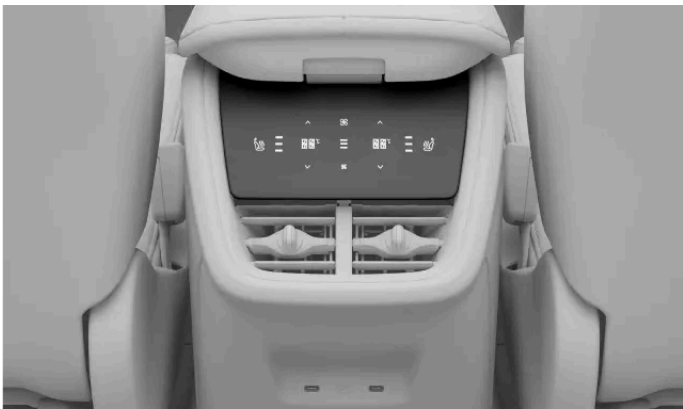

Climate controls in the center console



The mobile app

You can control the vehicle's interior climate here:

- The center display
- The center console's rear seat panel
- The overhead console
- The mobile app for the vehicle.

Most of your vehicle's climate controls and settings can be found in the center display. There are, however, also some physical buttons. The passengers in the rear seats can, for example, set their own preferred temperature via the climate settings in the center console rear seat panel. There is also a defroster button located in the overhead console.

In addition, passengers in the rear seats can control their own seat heating via the climate control panel on the back of the center console.

The content of this manual represents the status of the user manual at the time of printing and may not be completely valid in future instances. For more information refer to the first page for the complete disclaimer note.

 **Tip**

Use the mobile app for the vehicle to remotely precondition your vehicle. That way, you can ensure a comfortable interior climate when you enter the vehicle.

4.3.1.1. Activating seat heating



You can activate the seat heating function via the comfort view in the center display. There are three levels of heating to choose from.

In colder temperatures, it's nice to heat your seat for a more comfortable driving experience. You can activate and adjust seat heating via the center display.

 **Warning**

Seat heating should not be used by individuals who:

- have difficulties sensing temperature shifts due to sensory loss.
- have trouble controlling the seat heating settings.

1. Open the comfort view for the seat by pressing the corresponding seat symbol   in the bottom bar.
2. Select your preferred heating level.

To close comfort view, press the down arrow symbol on the bottom bar.

 **Tip**

Second-row seat heating

Passengers in the second-row seats can control their own seat heating. This can be done via the climate control panel on the back of the center console. You can also control the second row seat heating from the center display. Press the fan symbol  in the bottom bar and go to **Rear** to access the seat heating settings.

Automatic seat heating



In cold weather, you may appreciate automatic seat heating. Go to climate settings to turn on automatic activation.

4.3.1.2. Activating seat ventilation

The content of this manual represents the status of the user manual at the time of printing and may not be completely valid in future instances. For more information refer to the first page for the complete disclaimer note.

You can activate the seat ventilation via the comfort view in the center display.

In warmer temperatures, it's nice to use seat ventilation for a more comfortable driving experience. You can activate and adjust seat ventilation via the center display.

1. Open the comfort view for the seat by pressing the corresponding seat symbol   in the bottom bar.
2. Select your preferred level of ventilation.

To close comfort view, press the down arrow symbol on the bottom bar.

4.3.1.3. Activating the steering wheel heating

Steering wheel heating can be controlled via the center display. You can activate it manually or set it to automatic activation.

In colder temperatures, it's nice to heat your steering wheel for a more comfortable driving experience. You can activate and adjust steering wheel heating via the center display.

1. Press the driver side's seat symbol in the bottom bar .
2. Select your preferred steering wheel heating level.





Tip

Automatic steering wheel heating

In cold weather you, may appreciate automatic steering wheel heating. Go to climate settings to turn on automatic activation.

4.3.2. Climate settings

In climate settings, you can choose which functions should automatically activate when the vehicle turns on.

You can access the climate settings by pressing the fan symbol  in the bottom bar and go to settings .

There are a number of climate functions you can set to automatically turn on and set the heat level for. These include:

The content of this manual represents the status of the user manual at the time of printing and may not be completely valid in future instances. For more information refer to the first page for the complete disclaimer note.

- Seat heating
- Steering wheel heating
- Rear defroster

4.3.3. Temperature and air conditioning

With the automatic climate settings, the climate system aims to always provide you with a comfortable interior environment. However, if you want to, you can always make adjustments to your liking.

The auto climate mode provides a comfortable interior environment in most circumstances. However, adjustments can always be made. For example, you can make changes to the temperature settings, set different settings in different climate zones or change the air conditioning settings.



Tip

Third-row climate

Third-row climate automatically activates when passengers are detected in the third row.

When the third-row climate is active, the driver's climate settings are also applied to the third row.



Note



In certain circumstances, such as when fast charging on particularly warm days, the air coming from the air vents might not be as cool as expected. This is because the climate system is prioritizing cooling the battery over cooling the passenger compartment. This helps to provide good conditions for battery performance and range.

4.3.3.1. Activating air conditioning

The air conditioning cools and dehumidifies the incoming air.

When you select auto climate mode, the air conditioning is automatically activated or deactivated to maintain the set temperature. Deselecting the air conditioning while in auto climate mode will activate manual climate mode.

For the air conditioning to work efficiently, windows, doors and the trunk need to be closed.

1. Press the fan symbol  in the bottom bar.
2. Press the air conditioning symbol .

4.3.3.2. Setting the temperature

You can change the temperature in the passenger compartment via the center display.

1. Press the temperature in the bottom bar.
2. Use the plus or minus symbol to adjust the temperature.





Tip

You can also set the temperature in your vehicle hands-free via voice control.

4.3.3.3. Synchronizing temperature

By default, the driver's temperature setting is used for all climate zones. However, each climate zone can also have its own individual setting. You can switch between the two options by desynchronizing and synchronizing the temperature.

1. Press the driver's temperature setting in the bottom bar.
2. Press the synchronization symbol  to desynchronize the temperature.
 - > The climate zones are desynchronized and the desynchronization symbol appears.
3. Press the desynchronization symbol  to resynchronize the temperature.



Tip

The temperature setting is also desynchronized when the passenger sets a different temperature on their side.

4.3.3.4. Activating eco climate

Your vehicle has an eco climate function which prioritizes the vehicle's range over climate-related features.

Eco climate prioritizes range over climate comfort. The heating, cooling and air conditioning functions are limited in this mode.

Note

Problems with fogging may occur, as the air conditioning function that adjusts humidity is limited when eco climate is active. When the air conditioning function is limited, it can also affect the air quality, especially in the rear seats as the air recirculation increases.

1. Press the fan symbol  in the bottom bar.
2. Press the eco climate symbol ECO.

4.3.4. Air distribution and climate modes

The general air distribution is decided by the selected climate mode and settings. There are also air vents that offer additional airflow adjustments throughout the vehicle.

Adjustable air vents

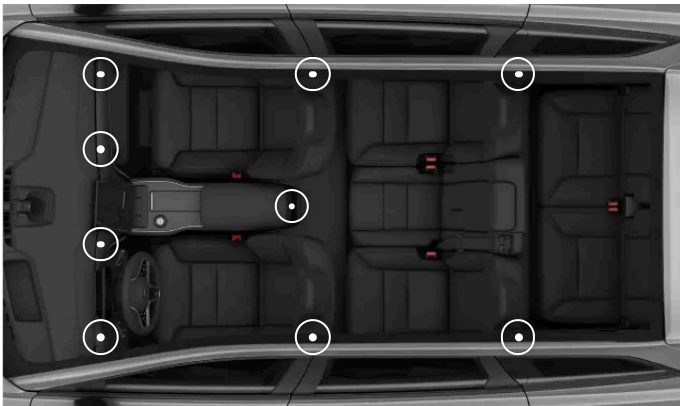

The locations of the adjustable air vents

The adjustable air vents can be redirected to control the direction of the airflow.

Climate modes

There are two climate modes – automatic and manual. Automatic mode takes care of most adjustments and climate functions for you. However, in manual mode, you can control more of the available adjustments and functions yourself.

You can also turn the climate system off completely.

! Important

Condensation risk

Turning the climate system off completely can cause condensation on the windows, which impacts visibility.

The climate modes and their settings are available in the center display climate view.

4.3.4.1. Adjusting air vents

You can adjust the air vents in the center display or by using the physical vent knobs.

Opening and closing air vents

1. Press the fan symbol in the bottom bar .



Press the air vent you want to open or close.

Redirecting the air flow

3. Move the physical air vent knobs to redirect the airflow.

4.3.4.2. Activating auto climate mode

When you activate auto climate mode, the climate system controls several of its functions automatically.

i Note

Deselecting the air conditioning while in auto climate mode will activate manual climate mode.

1. Press the fan symbol  in the bottom bar.
2. Select **Auto**.
3. You can change the fans' power level and the temperature if you prefer.

4.3.4.3. Activating manual climate mode

If you activate manual climate mode, you can set your preferred airflow direction and have more control over the fans' power level.

1. Press the fan symbol in the bottom bar .
2. Select **Manual**.
3. Choose your preferred airflow direction and fan power level.

4.3.5. Ice, condensation and defrosters

In cold conditions, ice and condensation can obstruct visibility. Your vehicle is equipped with defrosters, a heated rear windshield and heated door mirrors to prevent this from happening.

There are defrosters positioned by the windows and windshields. The side mirrors heat up at the same time as the rear windshield. Together, these functions seek to ensure good visibility.

 **Important**

Always make sure the windows and windshields have good visibility before you start driving.



4.3.5.1. Activating max defroster

Activate max defroster to quickly remove condensation and ice from the front windshield and windows.

Max defroster increases the fan speed and temperature. Air conditioning is activated and air recirculation is unavailable while max defroster is active. When max defroster is turned off again, the climate settings return to their previous levels.

 **Note**

When max defroster uses the high fan speed, the noise level of the fans increases.



1. Press the fan symbol in the bottom bar .
2. Press the max defroster symbol .

 **Tip**

The defroster button  in the overhead console activates the max defroster, as well as the heating of the rear windshield and side mirrors. If you already have either the max defroster or rear defroster activated via the center display, pressing the defroster button in the overhead console will activate the second function. Press the defroster button again to turn both off.

4.3.5.2. Activating rear windshield and door mirror heating

Activate the rear windshield and door mirror heating to get rid of condensation and ice.

1. Press the fan symbol in the bottom bar .
2. Press the rear defroster symbol .

 **Tip**

Overhead console defroster button

The defroster button  in the overhead console activates the max defroster, as well as the heating of the rear windshield and side mirrors. If you already have either the max defroster or rear defroster activated via the center display, pressing the defroster button in the overhead console will activate the second function. Press the defroster button again to turn both off.

Automatic rear defroster

In climate settings, you can set the rear defroster to automatically turn on when you start the vehicle in cold conditions.

4.3.6. Interior climate when parked

Your vehicle can maintain a comfortable interior climate when parked. You can also precondition your vehicle so that the passenger compartment is prepared for your next trip.

Note

Parking climate functions automatically turn off when their maximum running time is reached or the vehicle battery level is too low.

Preconditioning

Preconditioning automatically activates auto climate mode to warm up or cool down the passenger compartment to a comfortable temperature before you enter your vehicle. It also preconditions the battery to help your vehicle's performance and range.

You can schedule single and recurring preconditioning timers in the center display or via the mobile app for the vehicle. Preconditioning automatically deactivates when you enter the vehicle or when the scheduled time is reached.

Tip

When setting a timer via the mobile app, you can select what you want to precondition and set your preferred passenger compartment temperature.

For preconditioning to be available, the traction battery must be sufficiently charged. If preconditioning is started when your vehicle is not connected for charging, the vehicle's range will be affected.

Note

When preconditioning in a hot climate, condensation might drip under the vehicle. This is normal.

Keeping climate active

You can maintain a comfortable interior climate in your vehicle while it is parked. This includes keeping the climate functions and the entertainment system on. You can activate the keep climate active function via the center display. Just be aware that range may be affected if you leave this setting on for too long.

4.3.6.1. Setting the preconditioning timer

You can set and activate a timer to precondition your vehicle for a specific departure time. If you want, you can set it to recur on specific days.

If you choose to precondition the passenger compartment, the vehicle will cool or heat it before your scheduled departure time. You can set the timer to repeat on a weekly schedule or for a single departure time.

1. Press the fan symbol  in the bottom bar and go to **Timers**.
 2. Go to **Climate timers** → **Add timer**.
 3. Choose a departure time.
- > The timer is set.

Setting a timer to repeat

4. Turn on **Repeat weekly** to set a weekly schedule and select one or more weekdays.
5. Press **Save**.

You can activate an existing timer under **Climate timers**.

 **Tip**

When setting a timer via the mobile app, you can select what you want to precondition and set your preferred passenger compartment temperature.

4.3.6.2. Keeping climate active while parked

You can activate the keep climate active function to maintain a comfortable climate in the vehicle while you are away from it.

Warning

Never leave a child or pet unattended in your vehicle. You are responsible for their safety and well-being. Some regions have laws prohibiting people or pets being left inside a locked vehicle.

Note

The keep climate active function will automatically turn off when the maximum running time is reached, the vehicle's battery level is too low or you start a new drive cycle. If you activate it when your vehicle battery level is already low, the maximum running time will be shorter.

1. Press the fan symbol in the bottom bar .
2. Go to **Timers** → **Keep climate active**.
3. Press **Start**.
4. Confirm your selection.

Press **Stop** to turn it off again.

4.3.6.3. Air purification

Air purification improves the air quality in the passenger compartment of your vehicle before you start your drive.

You can start air purification via the mobile app for the vehicle. It also starts automatically when preconditioning ends.

Air purification improves the interior air quality by blowing fresh air through the air filter and letting the air recirculate in the passenger compartment. This happens until the air quality reaches a certain level.

Tip

You can check the content of small particulate matter^[1] via the mobile app for the vehicle during the pre-cleaning cycle.

^[1] PM2.5

4.3.7. Air quality

Your vehicle is designed to provide a pleasant and healthy interior climate. Air filtering helps to remove odors, substances and particles from the passenger compartment.

Passenger compartment air filter

The air going into the passenger compartment is first filtered through the climate control system. To ensure high performance, the filter needs to be replaced regularly. If the filter is exposed to intense use, such as prolonged driving through areas of smog or dust clouds, then the filter needs to be changed more frequently. If you are uncertain about what kind of filter to use, contact Volvo support.

Air quality system

The air in the passenger compartment is purified by:

- filtering allergy- and asthma-inducing substances.
- removing gases and particles to reduce odors.
- removing air contaminants such as particles.

If the air quality sensors detect contaminants in the outside air, the air intake closes and internal air recirculation activates.

Air cleaning

To provide good air quality, your vehicle is equipped with different air cleaning capabilities. Some of these can be activated via the center display to quickly improve air quality in the passenger compartment.

CleanZone

CleanZone indicates whether conditions for good air quality are met or not.

4.3.7.1. Air quality indication

The air quality tab in the center display's climate view provides you with information on air quality both inside and outside of the vehicle.

The air quality tab indicates the quality of the inside and outside air. A sensor measures the content of particles smaller than 2.5 µm in the passenger compartment. The information on the content of contaminants outside the vehicle is provided by an external service and is based on modeled data.



Tip

For some regions, information on pollen levels is available. Press **Air quality and pollen** to see more detailed information.

4.3.7.2. Air cleaning

To provide good air quality, your vehicle is equipped with different air cleaning capabilities.

Your vehicle has multiple functions to ensure good air quality. Some of these are passive, while others can be controlled in the center display.

4.3.7.2.1. Advanced air cleaning

Advanced air cleaning aims to minimize the amount of hazardous particles and harmful gases in the passenger compartment.

Advanced air cleaning is always active except during air recirculation or when the climate system is turned off. You can see in the climate view air quality tab if it's active or not.

4.3.7.2.2. Focused air cleaning

You can improve the passenger compartment's air quality by activating focused air cleaning. This lowers the number of unwanted particles in the air.

When you activate focused air cleaning, your vehicle prioritizes lowering the particle content in the incoming air over your climate comfort. This limits some of the other climate comfort features, such as lowering the fan power level.

Comfort is reduced because the climate system recirculates more air. This is most noticeable when there are multiple passengers in the vehicle.



Activating focused air cleaning

Focused air cleaning prioritizes lowering the number of unwanted air particles in the vehicle over other climate comfort features. You activate it in the center display's climate view.

The focused air cleaning function quickly cleans the air in the passenger compartment to get rid of unwanted particles. When it's active, it's prioritized over other climate functions.

 **Important**

When focused air cleaning is active, climate comfort and ventilation are reduced. This may lead to condensation that fogs up the windows and hinders visibility.

1. Press the fan symbol  in the bottom bar.
 2. Go to **Air quality**.
 3. Press the focused air cleaning symbol .
 4. Press **Activate**.
- > **Focused** appears below the fan symbol  in the bottom bar when focused air cleaning is active.

 **Note**

Avoid using focused air cleaning for longer periods of time, as the air in the passenger compartment can become stuffy. Once the air inside the vehicle has been cleaned, focused air cleaning has no further benefits, and so you can turn it off.

Press the focused air cleaning symbol  again to turn it off. You can also turn focused air cleaning off by activating other climate features.

4.3.7.3. CleanZone

CleanZone is an air quality function that controls and indicates whether all conditions for providing good air quality are met.

You can find information regarding air quality in the climate view air quality tab. CleanZone is achieved if all conditions to provide a good air quality in the passenger compartment are met. If it can't be achieved, the center display shows which condition is still not met.

4.3.7.4. Activating air recirculation

Air recirculation helps you keep out harmful or foul-smelling air from the passenger compartment. In some cases, it's activated automatically but you can also activate it manually in the climate view.

By default, the climate system automatically decides whether to recirculate air depending on certain environmental conditions. If the air quality sensor notices that the outside air is polluted, your vehicle will automatically close the air intake and instead recycle the air in the passenger compartment. You can also manually activate constant air recirculation to close the air intake if you want to.



Important

If air is recirculated for a long period of time, condensation can fog up the windows, which can affect visibility.

Note

Air recirculation is unavailable while max defroster is active.

If you activate air recirculation manually, it will time out after a while.

1. Press the fan symbol  in the bottom bar.
2. Press the recirculation symbol .

4.3.8. Climate system

Your vehicle's climate system seeks to provide everyone in the vehicle with a comfortable environment using electronic climate control.

All climate control system functions are controlled via the center display.

Your vehicle uses sensors to automatically control different capabilities that are designed to offer a comfortable interior climate at all times.

Tip

Most climate functions can also be controlled using voice control. Most features require an internet connection for use with voice control.

4.3.8.1. Climate zones

The passenger compartment is divided into different climate zones. These zones enable passengers to set their own preferred temperature to enjoy a comfortable environment.



Your vehicle's passenger compartment is divided into different climate zones. All zones are directly synced to the driver's preferred climate settings by default. However, the temperature can then be adjusted individually for each zone.

4.3.8.2. Partial climate

To save energy, your vehicle can limit the rear climate functions if there are no rear occupants.

If the vehicle detects that there are no occupants in the rear seats, it limits the climate functions for the rear passenger compartment. This reduces energy consumption.

4.3.8.3. Perceived and actual temperature

Your temperature perception is affected by several factors besides the actual temperature of the air around you. Knowing the difference between perceived and actual temperature can benefit your climate comfort experience.

Whether the air in your vehicle feels warm or cold depends not only on its temperature but also several other factors. These factors include your own body temperature, airflow and humidity in the vehicle, and whether you're exposed to direct sunlight. When you adjust the temperature setting, the vehicle considers some of the factors contributing to your perceived temperature. The vehicle then continuously adapts its climate functions to make the interior climate feel like the temperature you selected. This means that the actual temperature in your vehicle may differ from the temperature you selected, giving you a more consistent climate comfort experience.

Your vehicle takes exposure to sunlight into consideration when regulating the climate in the vehicle. For example, if the sun hits the driver's side, it can adjust the airflow and temperature to balance the perceived temperature on that side.

4.3.8.4. Climate sensors

There are several climate sensors located inside and outside of your vehicle. These sensors help to provide a comfortable climate in the passenger compartment.

For the interior sensors to be able to perform as intended, it's important that you don't cover them.

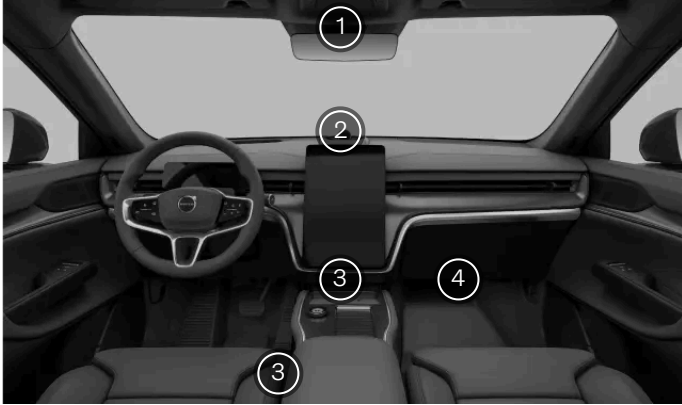

- ① Humidity sensor in the rearview mirror console.
- ② Sunlight sensor on the upper side of the dashboard.
- ③ Passenger compartment temperature sensor under the center display.
- ③ Passenger compartment temperature sensor between the center console and the driver seat.
- ④ Airborne particulate matter sensor on the underside of the glove compartment.

The exterior ambient temperature sensor is located on the underside of the vehicle.

4.3.8.5. Heaters

If the ambient temperature is lower than the temperature you prefer in your vehicle, the heating system can help provide a comfortable interior climate.

Electric heater

The electric heater is powered by the vehicle's traction battery. It's used to heat the battery and for heating the passenger compartment during preconditioning and while driving.

If the charge level in the traction battery is too low, the heater will switch off.

Heat pump

The heat pump works primarily as a range extender. In low temperatures, the heat pump helps to heat up the passenger compartment, while using less energy compared to the electric heater, which extends the battery's power availability. The heat pump operates during both preconditioning and driving. It also helps to maintain the traction battery at its desired operating temperature.

4.4. Windows and glass panes

Your vehicle has several different windows and glass panes. Many of them are laminated for added safety and security. The lamination also provides better sound insulation in the passenger compartment.

All laminated windows, except for the windshield and panoramic roof, are labeled with a laminated glass symbol.



Note

Be sure not to use tinted film with a metallic surface coating on the front or rear windshield. This can cause problems with signal reception, as antennas are located here.

Panoramic roof

Your vehicle's panoramic roof has an infrared coating which helps to keep the passenger compartment cool in sunny conditions.

It also has an electrochromic layer that lets you switch between transparent and tinted glass.

4.4.1. Operating the windows

You can use the power switches in the door panels to operate the windows. The switches in the driver door can control all the windows in your vehicle, while both the front and rear passenger switches are limited to controlling their respective windows.

Warning

Always consider the safety risks while operating the windows. The vehicle's moving parts can injure children or other occupants, as well as damage objects.

- Make sure you have a clear view of the windows you're operating.
- Don't allow children to play with the window controls.
- Never leave children alone in the vehicle.
- Never put an object or body part through an open window, even if the vehicle's electrical system is fully disconnected.

The window switches may still work for a while after you exit the vehicle. Keep this in mind when leaving the vehicle unattended.

Control the windows individually using the switches on the driver door panel. Each switch controls the corresponding left or right window.

Press the window symbol  to select the rear windows. The current window selection is indicated by the lights next to the symbol.

All of the windows have built-in pinch protection to help prevent injuries. Be sure to read the relevant information on pinch protection in its separate section of the manual.

To operate the windows, a key must be present inside or near the vehicle. If you use a key card, or if your distance-capable key is discharged, you need to place it on the card reader to be able to operate the windows.

 **Note**

Situations where the windows cannot be opened

- The windows cannot be opened at speeds above approximately 180 km/h (112 mph) but they can be closed.
- At very low temperatures, the windows might freeze in place and you won't be able to operate them.

1.



You can find the switches for the windows on the driver door.

Locate the switch on the door panel for the window you want to operate.

2. Use the switches to open or close the windows:

- A slight push or pull allows you to manually operate the window until you release the switch.
- If you push or pull the switch fully, the window automatically moves even if you release the switch. Stop it by moving the switch in the opposite direction.

 **Tip**

Noise reduction

One way to reduce wind noise when the rear windows are open is to also open the front windows slightly.

Child lock

You can disable the rear window controls in settings. This prevents rear seat passengers from operating the windows.

 **Note**

If automatic window movement or pinch protection isn't working properly, you may need to reset the windows. You can learn how to do this in a separate section of the manual.

4.4.2. Adjusting roof tint

Your vehicle's panoramic roof is made of electrochromic glass. This means that you can switch between a transparent and a tinted roof.

The panoramic roof is protected by a layer of infrared film, shielding the passenger compartment from some of the outside heat on sunny days. In addition to this, the electrochromic properties of the glass make it possible to switch between a transparent and a tinted roof through the settings in the center display.

1. Press the vehicle symbol  in the bottom bar and go to **Settings**.
2. Go to **Controls** → **Lights and displays** → **Roof shading**.
3. Turn the roof shading on or off.

 **Tip**

You can also adjust the roof tint via quick controls in the center display. This allows you to quickly adjust the roof tint without going into settings.

4.4.3. Pinch protection

To help prevent injuries from power-operated windows and other moving parts, your vehicle has a built-in pinch protection system. Occupants should also keep proper user practices in mind to reduce the risk of getting caught between moving or closing parts.

If something blocks the window while it is closing, it will stop and then slightly reverse, allowing you to remove whatever is in the way. Similarly, the trunk is offers pinch protection when opening or closing.

 **Warning**

Always consider the safety risks while operating the windows. The vehicle's moving parts can injure children or other occupants, as well as damage objects.

- Make sure you have a clear view of the windows you operate.
- Don't allow children to play with the window controls.
- Never leave children alone in the vehicle.
- Never put an object or body part through an open window, even if the vehicle's electrical system is fully disconnected.

If a window stops closing automatically due to obstructions such as ice, you can still try to close the window manually by continuing to pull the control switch. However, always try to remove the cause of the obstruction first and make sure nothing is blocking the path of the window before trying to close it again.

If there is a problem with pinch protection, you can try to solve the issue by resetting the window.

 **Warning**

The power window pinch protection may not work properly if the vehicle loses track of the current window position. The window positions are recalibrated when you reset automatic window movement. Always reset it to make sure the window positions are correctly calibrated if:

- the vehicle has lost power: for instance, if the 12 V battery has been disconnected.
- the automatic window movement does not work properly.

This restores the automatic window functionality and re-enables the pinch protection function.

4.4.4. Resetting windows

If you're experiencing issues with a power-operated window, you may need to reset it. This allows the vehicle to recalibrate its position to restore both pinch protection and automatic window movement.

Calibration errors

Your vehicle continuously monitors your windows and how they are positioned. Sometimes, an error can occur causing your vehicle to perceive a window's position to be different than it actually is. This can cause errors with the auto close function, as well as with pinch protection. If there is a calibration error with a window, you can reset it yourself or with help from an authorized Volvo workshop.

There are two different calibration errors that can affect window calibration. If the window monitoring system registers a calibration error, the auto close function is disabled. If the error is not detected, the auto close function may still work to a certain degree, but not as intended.

The two types of calibration errors are:

Offset down The window is further down than the vehicle's registered window position. This stops the window from fully closing, as the vehicle registers it as closed before it reaches the top of the window frame. You can recalibrate a window experiencing this error on your own.

The content of this manual represents the status of the user manual at the time of printing and may not be completely valid in future instances. For more information refer to the first page for the complete disclaimer note.

Offset up The window is further up than the vehicle's registered window position. The manual controls work, but if you use auto close, the window will close and then open again. This is because the system registers the top of the window frame as an obstruction and activates pinch protection. There is no way to recalibrate a window with this offset on your own. Instead contact an authorized Volvo workshop.

! Important

The pinch protection system might not work properly until the window has been reset after losing calibration.

Before resetting a window, make sure it is fully closed. You can force the window to close completely by overriding the window's auto-close movement system. Pull the window switch to the manual position three times in quick succession, then close the window manually.

Resetting window

1. Lightly press the window switch until the window is completely open.
 2. Lightly pull the switch until the window is completely closed.
- > Recalibration is now done, re-enabling both pinch protection and the automatic window movement.

Check to make sure that the window operates correctly after following the reset steps. The window should close completely when you pull the switch all the way and release. If the problem persists, contact an authorized Volvo workshop.

4.5. Seats

The seats are all designed to provide comfort and safety. Adjust the seats, activate comfort functions, and make sure to sit properly.



The vehicle seats have a range of features to provide comfort, safety and flexibility.

In this section of the manual, you'll get to know the comfort features and adjustments available for the vehicle seats. This includes features such as the seat positional adjustments and how to fold the rear seats to get more space for stowing. At the same time, you will learn the essentials of how to use these features safely and properly.

A separate safety section in this manual provides more information about the seats' passive safety functions and how to accommodate them through proper seating.

4.5.1. Front seats

The front seats have plenty of adjustments to increase comfort.



Adjustments

The power seat adjustments are divided into groups called adjustment modes:

- Basic adjustments Height and position of the seat and backrest tilt.
- Tilt and lumbar support Lumbar support height and depth adjustments, as well as seat cushion tilt.
- Side support Side bolster positions.



Tip

Extending the seat cushion

You can manually extend the seat cushion to better support the full length of your upper legs. Grasp the handle below the front of the cushion and pull the cushion forward.

Seat adjustment knob

All power seat adjustments are done using the knob on the side of the seat. When you press the center button, the seat adjustment view appears in the center display to guide you.

Features

The front seats also have the following comfort features:

- Massage** You can choose from five different massage programs with three different speeds and intensities.
- Ventilation** Most parts of the front seats are ventilated. There are three levels of cooling to choose from.
- Heating** The seats have three levels of heating available.
- Speaker headrests** The front headrests have integrated speakers for a more immersive listening experience.



Important

Warning sounds

Never attach covers or pillows to the speaker headrests. The speakers are a part of the vehicle's safety system, and covering them might dampen the warning sounds.



Tip

Handbag storage

If you or your passengers bring a handbag or smaller luggage, you can find a convenient storage space for it underneath the front part of the center console.

4.5.1.1. Adjusting the front seats

Adjust the front seats with the seat adjustment knob. You can find this on the side of the seat closest to the door.

Seat adjustment knob



The seat adjustment knob can move up and down, forward and backward, as well as rotate in both directions. In the middle of the knob there is also a button you can use to change the active adjustment mode.

There are lots of different changes you can make to the seats. To control them all with the adjustment knob, the available changes have been grouped into separate adjustment modes. Each mode is visually represented in the center display to guide you while adjusting the seat.

 **Warning**

Never adjust the seat while driving. This can cause dangerous distraction and loss of control. Instead, be sure to make all necessary adjustments to the seat before starting a drive.

Adjusting the seat

1. Start by pressing the button on the adjustment knob.
 - > The seat adjustment view appears in the center display.
2. To cycle through the different adjustment modes, press the button on the knob repeatedly.
3. Rotate or move the knob to adjust the seat according to your preference.
 - > The visual guide in the center display indicates which part of the seat you are adjusting.



Tip

Quick adjustments

You can also customize the seat without visual guidance from the center display. Just move or rotate the seat adjustment knob to start adjusting. Note, however, that only the basic adjustment mode is available this way.

Extending the seat cushion

You can manually extend the seat cushion to better support the full length of your upper legs. Grasp the handle below the front of the cushion and pull the cushion forward.



Note

Adjustment lock

If you move the adjustment knob in the same direction numerous times within a short time frame, the knob becomes temporarily unresponsive. A message also appears in the center display telling you the seat adjustment controls have been disabled. This is to prevent unintentional use of the adjustment knob.



Important

Once you've finished adjusting the seat to your liking, it's important to make sure other parts of the vehicle are aligned correctly. Your driving posture is important and is affected by factors in addition to your seat adjustments, such as the position of your steering wheel, mirrors and head-up display.

4.5.1.2. Resetting the front seat positions

If the seat doesn't move to the saved profile position, or if the seat movement appears limited or uneven, the seat may need to be reset.

1. Move the seat all the way forward and then all the way back.
2. Move the seat cushion to its highest position and then to its lowest position.
3. Adjust the seat to your preferred position and save it to your profile.

If the issue persists, contact your authorized Volvo workshop.

4.5.1.3. Activating seat massage

You can activate the seat massage function via the seat adjustment view in the center display. There are several different massage programs and settings you can choose from.

1. Press the button on the seat adjustment knob.

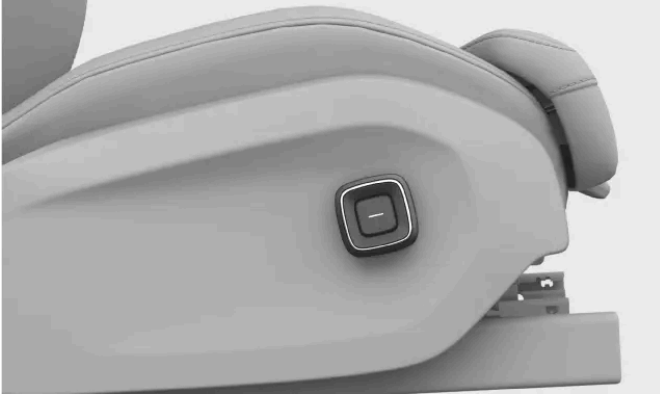

The knob is located on the side of the seat closest to the door.

- > The seat adjustment view appears in the center display.
2. Select **Massage**.
 3. Select your preferred program, speed and intensity.
 4. Select **Start**.
- > Massage starts and a notification appears in the center display telling you how long the massage will run for.

If you would like to stop the massage before the massage program finishes, select **Stop** from the massage view in the center display.



You can also reach the massage view in the center display via settings without using the seat adjustment knob.

4.5.1.4. Extending the seat cushion

You can adjust the front seat cushion length to better support your legs.



Grasp and pull the handle on the front of the seat.

2. Adjust the length of the seat cushion.

4.5.2. Second-row seats

The rear seats are divided into a second and third row, each offering its own set of features and adjustments.



You can adjust the second-row seats in a number of ways to get more space or use the additional features to better suit your needs.

Adjustable backrest tilt Adjust the tilt of the backrest to provide better comfort and back support.

Adjustable seat position You can move the seats forwards or backwards depending on how much space you need.

Foldable headrests The second-row seats have foldable headrests. This can give you more space when you fold the seats.

The content of this manual represents the status of the user manual at the time of printing and may not be completely valid in future instances. For more information refer to the first page for the complete disclaimer note.

Foldable backrests	You can fold the seats to create more cargo space. Each seat can be folded independently.
Seat heating	The second-row seats have access to three levels of heating. You can control this from the panel on the back of the center console or from the center display.



Tip

Fold-out armrests

Fold out the armrest on the innermost side of each backrest to access a cup holder and get additional arm support.

4.5.2.1. Adjusting second-row seats

You can adjust the second-row seats, either to make your seat feel more comfortable or to free up more space behind the seat.

Both the position of the seat and the tilt of the backrest can be set individually for each seat.



Warning

Never adjust the seats while the vehicle is moving. Sudden braking or turning can cause you to lose control of the seat and risk injury.

Put the gear selector in P to prevent the gear selector from being accidentally moved.



Important

Child restraints

Never adjust the seat if there is a child restraint installed on it that uses either the lower or top tether anchor points to secure it. This can damage the child restraint or loosen the tethers that keep it fixed in place.

Pinch risk

Take extra care when adjusting the seat position if the seat behind it has a passenger sitting in it or a child restraint installed on it.

Adjusting seat position

1.



Grasp the handle under the seat cushion and pull it up.

2. Slide the seat forward or backward to your preferred position.

3. Release the handle.

> The seat locks into place.

Adjusting backrest tilt

4.



Pull and hold the handle on the side of the seat upward to unlock backrest movement.

5. Lean forward or backward in the seat.

> The backrest follows your movement.

6. Release the handle when you've reached your preferred position.

7. Press against the backrest until it locks.

Important

After adjusting, folding or raising a seat, make sure all parts of the seat are properly locked in place.

4.5.2.2. Folding down the second-row seats

You can fold the second-row seats to get more stowing space.

! Important

Before folding the seats, make sure:

- there are no objects on the seats.
- the seat belts are not buckled.
- there is enough space to fold the seats down. If needed, move the front seats forward.

! Warning

If any of the rear seats are folded down, they must not be in contact with the front seats. This can impede the safety of other occupants.



Pull the handle on the side of the seat up.

- > The backrest and headrest release and tilt forward.
- Guide the backrest down to its folded position.
- Press down on the backrest to lock it into place.

When you want to raise the seat again, use the same handle on the side of the seat to unlock the backrest. Then, manually push it to its upright position. Make sure the backrest locks into place. Finally, move the headrest back to its locked position.

! Important

After adjusting, folding or raising a seat, make sure all parts of the seat are properly locked in place.

4.5.3. Third-row seats

The rear seats are divided into a second and third row, each offering its own set of features and adjustments. The seats on the third row are designed with both comfort and flexibility in mind.



The seats have the following features:

Foldable backrests The backrests and headrests can fold in one motion to give you more stowing space.

Foldable headrests You can fold the headrests without folding the backrests. This can give you a more unobstructed rear view when the seats aren't in use.

4.5.3.1. Getting in and out of the third row

You can temporarily adjust the outer second-row seats to make it easier to enter and exit the third row of seats.

! Important

Pinch risk

Be careful after getting in and out of the third row so that the second-row seat does not press against or affect an installed child restraint or seated passenger.

1.



Pull the handle on the top of the outer seat backrest.

> The backrest unlocks.

2.



Pull the backrest to tilt it forward until it comes to a stop.

3. Continue to pull the backrest to move the whole seat forward.

To return the seat to its original position, follow the steps in reverse order. Push the seat backwards and allow the backrest to tilt backwards until it locks into place.

! Important

After adjusting, folding or raising a seat, make sure all parts of the seat are properly locked in place.

4.5.3.2. Folding down the third-row seats

You can fold the third-row seats from three locations in the vehicle. Each location has its own benefits, depending on why you want to fold the seats.

Folding button locations



On the right-hand side in the trunk, there is a button panel. The top two buttons, one for each seat, can be used to fold and raise the third-row seats. This location can be useful if you need more room for stowing while using the trunk.



When a rear door is open, you can find the folding buttons in the door frame. There is one identical set of buttons on each side of the vehicle. These locations can be useful if you plan to fold both the second- and third-row seats .

Important

Before folding or raising the seats, make sure:

- no one is sitting in any of the third-row seats.
- there are no loose items on or under the seats.
- the seat belts are not buckled.
- there is enough space to fold the seats down. If needed, move the second row seats forward.

 **Warning**

If any of the rear seats are folded down, they must not be in contact with the front seats. This can impede the safety of other occupants.

- Press the folding button for the seat you want to fold.
- > The seat backrest and headrest fold forward.

 **Note**

Pinch protection

If the vehicle detects something blocking the path while folding or raising the backrest, the backrest will revert to the start position. Remove whatever is in the way and press the folding button again. If something is blocking the backrest movement in both directions, the backrest locks itself and a timeout message appears in the center display. You must dismiss this message before you can try again.

When you no longer need the extra cargo space, press the folding button again. The backrest will raise into position. Once the backrest is locked, manually move the headrest back until you hear a click.

 **Tip**

If any of the rear seats are folded down by mistake, you need to press the folding button again to stop the seat movement. The backrest will then move back to its original position.

4.6. Interior lighting

The lights in your vehicle's passenger compartment provide illumination for different purposes. There are lights for reading, as well as for general illumination and lighting up storage areas.

Reading lights

The front and rear seats have reading lights. You can adjust their intensity to suit your needs. In the rear, they also work as the general lighting.

General illumination

Your vehicle has lights to provide general illumination of the passenger compartment, such as when you get into the vehicle. General illumination can be activated both manually and automatically.

Ambiance lights

The content of this manual represents the status of the user manual at the time of printing and may not be completely valid in future instances. For more information refer to the first page for the complete disclaimer note.

The ambient lights in the vehicle provide comfortable illumination in the passenger compartment when it's dark outside.

Storage area lights

There are lights in different storage areas, such as the trunk and door pockets, to make it easier to find what you're looking for.

4.6.1. Adjusting the reading lights

There are reading lights available for the front and rear seats. You can adjust the brightness according to your needs.

The front seat reading lights are located in the overhead console and the rear reading lights can be found over the rear doors.

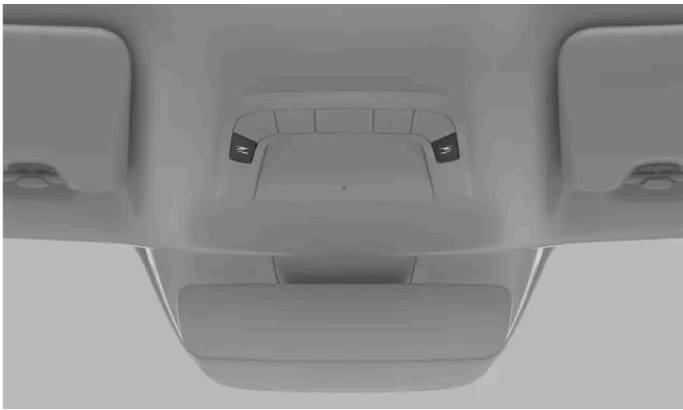

The front seat reading lights in the overhead console



Rear seat reading lights

1. Press the button next to your reading light to turn it on and off. The button is marked with a reading light symbol.



2. Hold the button down to adjust the brightness.

4.6.2. Adjusting interior lights

You can adjust the brightness of the interior lights in the lights and displays section of the settings.

1. Press the vehicle symbol  in the bottom bar and go to **Settings**.
2. Go to **Controls** → **Lights and displays** → **Interior brightness**.
3. Adjust the brightness.



Tip

Screen and button brightness

You can adjust the brightness of the displays via the lights and displays menu in the center display.

4.6.3. Disabling interior auto lights

The auto lights off function keeps the interior lights off, even when you are entering or exiting your vehicle.

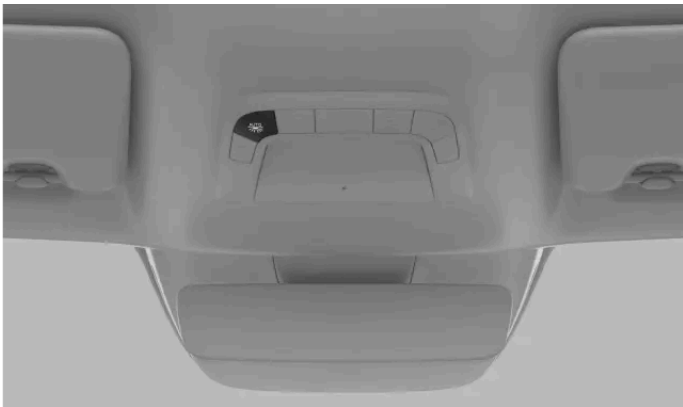

The auto lights off button in the overhead console

The interior auto lights function, sometimes called courtesy lights, turns the interior lights on automatically when a door is opened. The auto lights can make it easier to enter and exit the vehicle if it's dark outside. However, there may also be situations where you don't want the lights to turn on, such as when passengers are sleeping in the vehicle.

The auto lights off button is located in the overhead console and is marked with an auto lights off symbol.



When the auto lights are turned off, the button illumination changes color.

The content of this manual represents the status of the user manual at the time of printing and may not be completely valid in future instances. For more information refer to the first page for the complete disclaimer note.

1. Press the button to turn the function on or off.

***i* Note**

Even if the auto lights are disabled, the lights will still turn on if you use the lights all on function.

4.6.4. Activating all interior lights

Activating all interior lights turns on most of the interior lights. This can be helpful when you're looking for something in the passenger compartment.

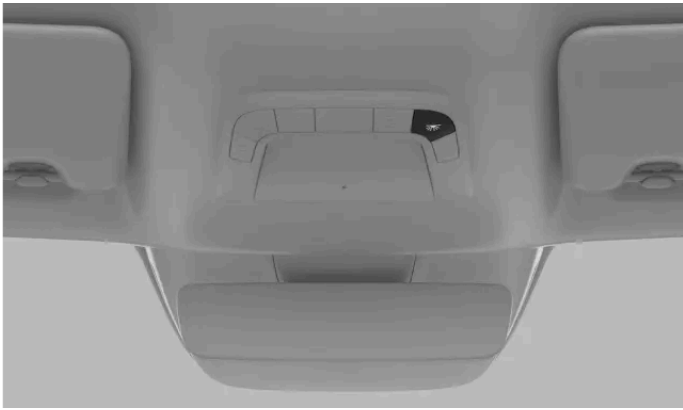

All interior lights on button in the overhead console

The activate all interior lights button is located in the overhead console and is marked with a light symbol.



1. Press the button to turn all interior lights on or off.

***i* Note**

Even if auto lights have been disabled, the lights will still turn on if you use the lights all on function.

5. Safety

Get to know your vehicle's collision-protection features and what is required for safe use of the vehicle.

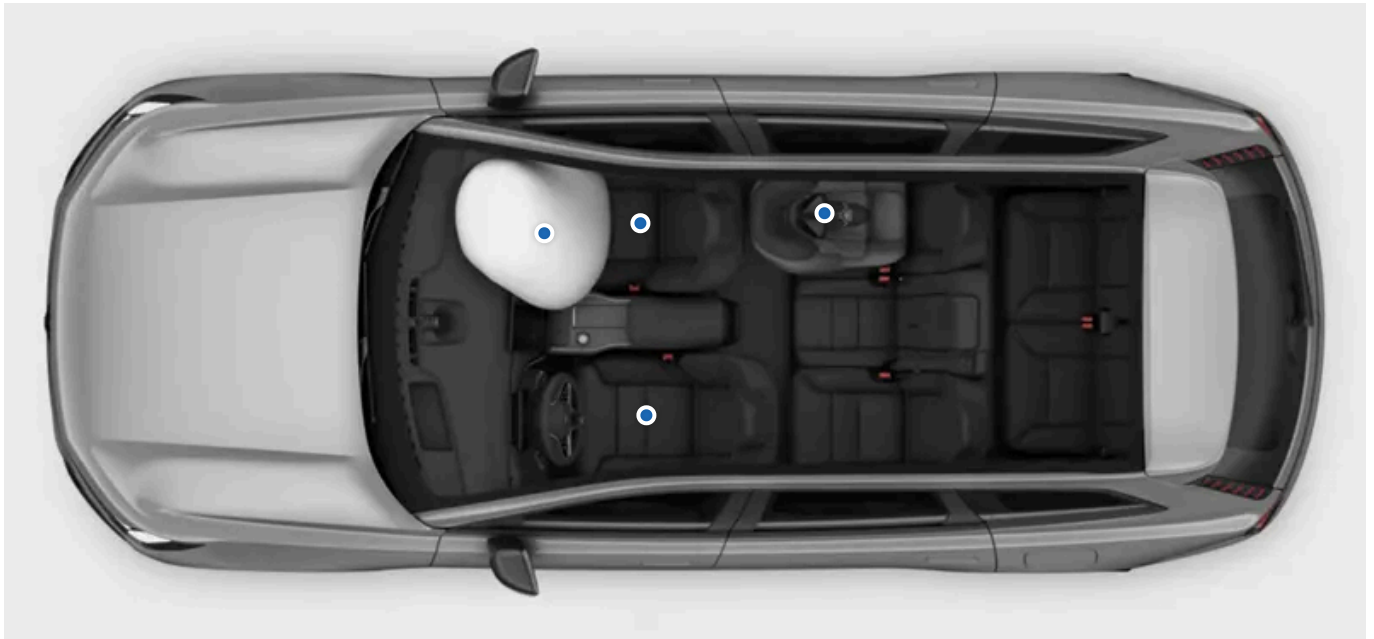

The safety section describes features designed to reduce the risk of serious injury in the event of a collision. The safety features include seat belts, airbags, child restraints and other components or functions that can help save lives when used correctly.

Your vehicle is designed to promote and provide the conditions for safe use. Safety features never replace the need for safe user practice. This not only applies to features directly related to safety but also to the rest of your vehicle. It's your responsibility to use the vehicle's functions safely.

Warning

Safety synergy

The safety features are designed to work together to increase the safety of all occupants in the vehicle. No feature replaces the need for another unless the manual explicitly states so. For example, the presence of airbags in no way reduces the need to wear a seat belt.

SRS warning

Sensors in the vehicle can detect if there is something wrong with the airbags or related safety systems. A red warning symbol will appear in the instrument panel to alert you if any faults are found.



SRS warning symbol

If the red SRS warning symbol appears in the instrument panel, immediately contact an authorized Volvo workshop.



Note

Startup checks

Several safety systems are part of the vehicle's startup check. During the check, the yellow SRS symbol may appear in the instrument panel. This is completely normal and means that the safety systems are starting up and checking for potential issues. Make sure you address any indicated faults.



SRS start-up symbol

Safety-related areas

Some driver support functions are related to safety. Instead of keeping you safe in the event of an accident, they are designed to prevent them in the first place. Get to know those functions as well for a safer trip.

5.1. Collision response

In the event of a collision, your vehicle has many features designed to help mitigate the effects. Your vehicle's response to a collision happens before, during, and after the impact.



Tip

You can find information related to collision response in many places throughout this manual. Therefore, this section exists to provide a more comprehensive overview of your vehicle's capabilities in this area.

Before

Before an impact, several driver support functions can work to avoid the collision or reduce its effects. If the vehicle perceives a collision to be likely or unavoidable, it has the ability to preemptively activate protective systems, such as seat belt pretensioning, before the impact occurs.

During

During a collision, sensors throughout the vehicle continuously provide information about the states of the vehicle and its occupants. The vehicle uses the information to selectively time and activate protective functions such as airbag deployment and seat belt pretensioning. Collisions are complex events that can unfold in several stages, where the first impact isn't necessarily the most severe. Good timing is essential for the best chance of effective protection.

The vehicle's safety systems work in synergy with passive safety features. In the event of a collision, your vehicle's construction distributes forces to specific structural components. It also takes advantage of crumple zones that absorb energy from the impact. Using similar principles, the exterior has been designed with the protection of pedestrians in mind.

After

After a collision, the vehicle tries to stop in a controlled and safe manner. It can also make an automated call for emergency response.

Note

Safety mode

During a collision, the vehicle's safety systems may disconnect the high-voltage battery. This is to protect both the occupants and the vehicle itself from potential damage caused by the battery. At the same time, the vehicle enters safety mode. When safety mode is active, you cannot drive the vehicle. However, depending on the severity of the collision, you may be able to exit safety mode via the center display if you need to move the vehicle out of immediate danger. Doing so will reconnect the high-voltage battery and enable short distance driving.

Important

Your vehicle is designed around safety, but no protective system is 100% effective in all situations. Safety features never replace the need for safe user practice.

5.1.1. Pedestrian protection system

Your vehicle is equipped with a system that can mitigate the effects of a frontal collision with a pedestrian. If the system has been activated, your vehicle needs to be recovered and serviced.

The pedestrian protection system is designed to reduce pedestrian injuries in the event of a collision with the vehicle. If the system is triggered during a collision, the vehicle responds in three specific ways, in addition to the normal collision behavior:

- The hood lifts to absorb the impact from the pedestrian.
- An automatic alarm is sent via an emergency call center.
- A symbol appears in the instrument panel to indicate the system has been triggered.



Pedestrian protection system

If the system has been triggered, follow the recommendations given.

Note

The pedestrian protection system relies on sensors to detect certain types of collisions. The sensors are active at speeds of approx. 25-50 km/h (15-30 mph), but there are many conditions and factors that determine whether or not the pedestrian protection system will trigger. There may be objects in the vehicle's surrounding environment that the sensors detect in a similar way to a pedestrian. The system may activate in the event of a collision with such an object.

 **Important**

Driver responsibility

The pedestrian protection system is a supplement to safe driving practices. It does not reduce or replace the need for the driver to stay attentive and focused on driving safely. Drive the vehicle with the same attention to safety as you would if you were driving a vehicle without the ability to mitigate collisions.

 **Warning**

Damaged front end

Contact an authorized Volvo workshop if the front end of the vehicle has been damaged in any way. This is to ensure the damage hasn't affected any of the vehicle's safety systems, including the pedestrian protection system.

Raised hood after activation

Do not drive the vehicle if the hood is blocking your view after the system has been activated. It is recommended to have the vehicle transported with a recovery vehicle instead. If the pedestrian protection system has been activated, your vehicle needs service at an authorized Volvo workshop.

Vehicle modifications

Do not make modifications or additions to the front end of the vehicle. Modifications to the vehicle risk adversely affecting the safety systems and could lead to serious injury and vehicle damage. Carefully read the section about vehicle modifications and contact Volvo if you are considering modifying your vehicle.

5.2. Occupant detection

Your vehicle can remind you not to leave anyone inside when you lock it.

Presence warnings

By default, your vehicle alerts you if it detects that passengers or pets are still in the vehicle when you try to lock it. When this happens, your vehicle will not lock and you'll receive a notification in the center display. However, it's possible to lock the vehicle with a passenger inside if you've temporarily allowed occupant locking in the locking settings.

 **Tip**

Mobile notification

If your Volvo Cars app is linked to the profile currently signed in to the vehicle, you will also get a notification in the app in situations when the vehicle would alert you.

 **Warning**

Volvo recommends that you do not leave people or pets in a locked vehicle.
Some regions have laws prohibiting people or pets being left inside a locked vehicle.

5.3. Proper seating

Appropriate seating and proper seat belt use are essential for the safety and comfort of everyone in the vehicle. There are also specific recommendations for pregnancy and child seating.

 **Important**

Importance of proper seating

Safety features, such as seat belts and airbags, require that all occupants are properly seated for the best chance of effective protection in a collision. Failure to follow the seating instructions can endanger life or lead to serious injury.

Pregnancy

Take extra care to follow all seating recommendations if the occupant is pregnant. The following are either additions or of extra importance:

- Make sure that the seat belt does not cross the abdomen. The hip strap should be under the belly and the shoulder section should pass above it.
- In the driver's seat, avoid sitting closer to the steering wheel than necessary. Adjust the seat to create as much distance as possible between your abdomen and the steering wheel while still keeping all driver controls comfortably within reach.

Child seating needs

Always seat children with extra care and attention to their needs. Make sure you have the required child restraint, that it's installed correctly, and that the child remains safely seated throughout the entire trip. For children traveling facing forward, the same seating recommendations apply as for adults. Always make sure the seat belt is properly adjusted and that the headrest is at a height suitable for the child when possible.

 **Note**

Physical limitations

Physical limitations can prevent an occupant from following the seating recommendations. The vehicle may need modifications to accommodate safe use. Contact an authorized Volvo workshop for information about Volvo-approved modifications.

Sitting posture

Both sitting posture and proper seat belt adjustment are important for safety. Avoid irregular sitting postures.

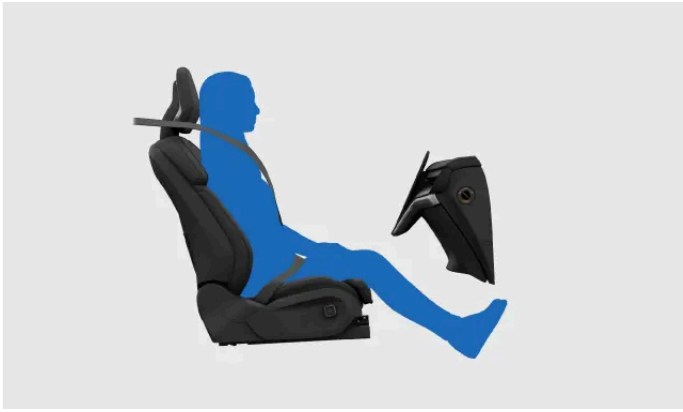

A correctly seated occupant. Do not adopt other postures when the vehicle is moving.



Do not slide forward in the seat. The lower back should have contact with the backrest.

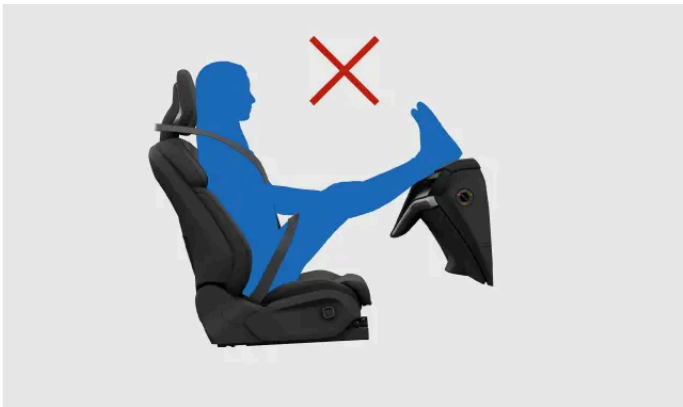

Keep both feet planted on the floor.



Do not tilt the backrest to a lying position. The seat belt must remain tensioned against the shoulder.

Whiplash protection considerations

Proper headrest use is essential to reduce the risk of neck injuries in a collision. All of the vehicle's headrests are designed to help protect the head and neck when used correctly. As an added safety feature, the front seats' construction can reduce the risk of whiplash injuries in certain collisions. These seats are designed to shift in a way that lowers whiplash-associated forces.

- Keep the back of your head against the headrest.
- Make sure occupants have correctly adjusted headrests when possible.
- Avoid stowing luggage against the back of the front seats. This can prevent the seat from moving as intended in the event of a collision.

5.4. Seat belts

When you use seat belts correctly, they can help prevent serious injury in situations ranging from sudden braking to severe collisions.

Seat belt features



The seat belt locks itself to act as a safety restraint under certain conditions, such as sudden and forceful pulling of the belt, if the vehicle is driven aggressively and if the vehicle is on a steep incline.

The vehicle can use seat belt pulses to alert the driver. The seat belt can also adjust as a safety precaution in a high-risk situation.

Built-in seat belt pretensioners can tighten the seat belts extremely quickly in response to a collision.

When installing certain child restraints^[1], all of the vehicle's seat belts except the driver's seat belt can be set to only retract.

Seat belt reminder

The content of this manual represents the status of the user manual at the time of printing and may not be completely valid in future instances. For more information refer to the first page for the complete disclaimer note.

The vehicle uses built-in sensors to detect if the driver or any of the passengers aren't using their seat belts. The system alerts the driver with a warning sound, and the seat belt reminder symbol appears in the overhead console.



Seat belt reminder symbol

Important

Wearing seat belts

These are the essentials for wearing seat belts properly. There is also more detailed information in other sections of the manual covering proper seating and seat belt adjustments.

- Make sure that everyone in the vehicle wears their seat belt and that all belts are properly adjusted.
- Adjust the upper attachment point of the seat belt to fit the wearer's size.
- Wear the seat belt closely against the body.
- Minimize slack in all belt segments.
- Allow the belt to run as straight as possible between its three anchor points.^[2]
- Have the backrest in an upright position.
- Follow all seating and posture recommendations.^[3]
- Do not wear the seat belt in ways other than those described in this manual.
- Always use seat belts when driving.
- Never use the same seat belt for more than one individual at a time.

Warning

Seat belt care and maintenance

- Never modify or repair seat belts or related parts, such as fittings and hooks, yourself. Any service or replacement must be done by a trained technician with access to type-approved parts.^[4]
- Contact an authorized Volvo workshop if the seat belt or a related part shows signs of damage or wear.
- Replace the seat belt if it has been subjected to a heavy load, such as in a collision. It may have lost protective properties even if there is no apparent damage.
- Clean the seat belt as soon as possible if anything is spilled onto it. The spilled substance can enter the mechanism and deteriorate the material.

^[1] Read everything about child safety before installing a child restraint.

^[2] For example, never wrap it around or attach it to other items or fittings in the vehicle.

^[3] There are general seating recommendations, as well as specific recommendations for children and pregnant occupants.

^[4] Volvo recommends an authorized Volvo workshop.

5.4.1. Fastening and adjusting seat belt

A correctly fastened and adjusted seat belt is important for your safety and comfort.



Correctly fastened and adjusted seat belt.

Note

These instructions apply to adults and children who are seated normally or are using a booster seat or booster cushion. Read the separate section covering child safety for detailed information about child seating and different types of child restraints.

Fastening the seat belt

1. Pull the seat belt out by the latch plate. If you pull too fast, the locking mechanism will engage.
 2. While extended, check the belt for twists, knots or damage.
 3. Insert the latch plate into the buckle.
- > The latch plate clicks into place.

Warning

Check when seat belt is fastened

- The seat belt should run directly and as straight as possible between its three anchor points. Any unnecessary slack increases the risk of injury.
- Make sure everyone in the vehicle is wearing their seat belt correctly.
- Use the correct buckle for each rear seat belt. Using the wrong buckle can lead to a seat belt malfunction or failure.

Adjusting the seat belt

The content of this manual represents the status of the user manual at the time of printing and may not be completely valid in future instances. For more information refer to the first page for the complete disclaimer note.

4. For occupants in the front and second-row seats, adjust the height of the seat belt's upper attachment point.

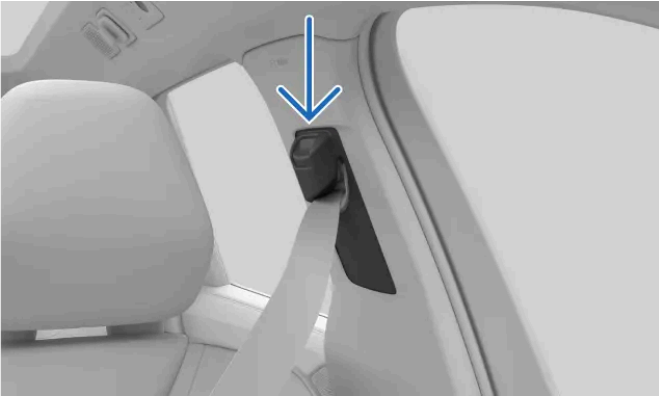

Seat belt top attachment point.

1. Hold the button on the upper attachment point down to allow it to slide up and down.
 2. Place it as high as possible without the belt touching the throat or neck.
5. Tension the hip strap to remove slack by pulling upwards on the diagonal chest strap. It should be as straight and low as possible, running below the abdomen.

 **Important**

Pregnancy

Take extra care to follow all seating recommendations if the occupant is pregnant. Make sure that the seat belt does not cross the abdomen. The hip strap should be under the belly and the shoulder section should pass above it.

Releasing the seat belt

6. Release the seat belt by pressing the buckle button.
7. Guide the seat belt back to its retracted position.

 **Important**

Make sure the seat belt retracts fully after using it. Closing a door with the seat belt caught in the gap can damage both the seat belt and the door.

5.4.2. Setting seat belt to only retract

By setting the seat belt to only retract, you can tighten the belt without it loosening when you let go. This allows you to install certain child restraints in your vehicle that are secured using the seat belt.

When set to only retract, the seat belt's locking mechanism will engage continuously. This allows you to tighten the belt manually to secure a seat belt-installed child restraint.

All seat belts in your vehicle, except for the driver's seat belt, can be set to only retract.

1. Pull the seat belt out fully.
- > When the full length is unfurled, the belt switches to only being able to retract.

Allow the seat belt to retract fully to return the seat belt's function to normal.

 **Important**

Seat belts can only be used to install child restraints specifically designed for seat belt installation. Always follow the instructions that come with the child restraint.

5.4.3. Seat belt reminder

The vehicle uses built-in sensors to detect if the driver or any of the passengers aren't using their seat belts.

If the vehicle detects any occupants that are not wearing their seat belts, the system alerts the driver with a warning sound, and the seat belt reminder symbol appears in the overhead console and in the instrument panel.



Seat belt reminder symbol

You can find information about which seat belts aren't fastened in the instrument panel.



Vehicle overview in the instrument panel

If the reminder appears, buckle the indicated seat belts as soon as possible in a safe manner. Stop the vehicle, if necessary, to avoid distracted driving.

In some cases, the sensors may mistake an object on the seat for a passenger and alert you if the seat belt hasn't been fastened. If you dismiss these reminders in the instrument panel, the large graphic will disappear, but the other warning indicators will remain active. Buckle the seat belt to remove them.

 **Warning**

Always make sure everyone in the vehicle wears their seat belt.

5.5. Airbags

There are several airbags that your vehicle can deploy in a collision. They can help reduce the impact forces experienced by occupants.

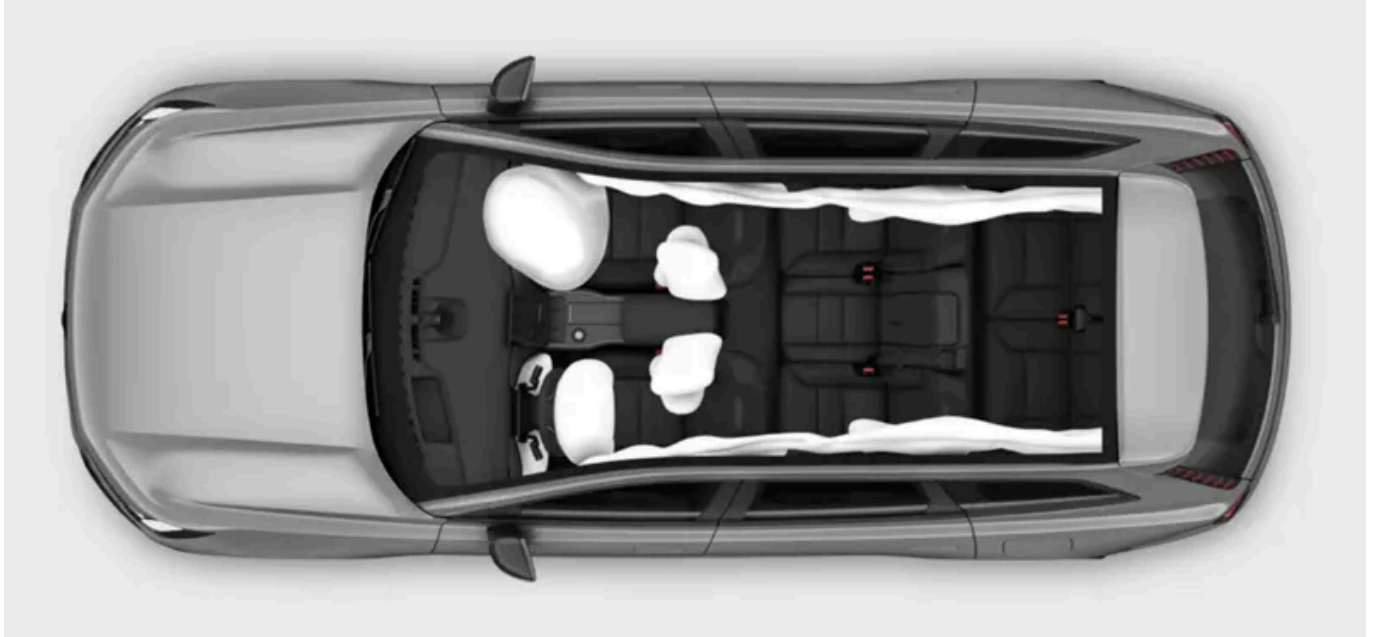

The image shows a selection of available airbags. Continue reading for details on the airbags in your vehicle.

The airbags are designed to work with the rest of the vehicle's safety features. Their effectiveness particularly relies on proper seating and seat belt use. An airbag deployment is a sudden, forceful but controlled event that can significantly lower the risk of serious injury for correctly seated occupants.

Warning

The airbags cannot work as intended in the event of a collision if an occupant is incorrectly seated. Always use seat belts.

Sensors throughout your vehicle allow it to deploy different airbags based on information about the collision itself, as well as the status of the vehicle and its occupants.

Airbag types

Your vehicle has the following airbag types:

- Front airbags** Frontal collision airbags for the front occupants.
- Side airbags** Seat-integrated side-on collision airbags for the front occupants.
- Inflatable curtains** Ceiling-mounted airbags for occupants seated by a window.

5.5.1. Airbag deployment

If an airbag has deployed, your vehicle needs to be recovered and serviced.

When the vehicle deploys an airbag, it inflates almost instantly with considerable force, accompanied by a loud noise. After that point, it behaves differently depending on the type of airbag. The front and side airbags deflate as they are compressed and provide controlled cushioning for a single severe impact. The inflatable curtains stay inflated longer to protect against repeated impacts.

 **Warning**

Airbag-related injuries

No safety feature can prevent all possible injuries in a collision. The airbags are designed to reduce the risk of severe injuries. Impacting an airbag often results in some form of injury, and several factors affect the type and severity of the injury. Reading the manual allows you to recognize and avoid practices known to increase the risk of injury.

To reduce the risk of airbag-related injuries in a collision:

- Follow the manual's instructions for proper seating and use of seat belts.
- Learn the placement of all airbags and how they affect the use of your vehicle.
- Properly stow loose objects when driving and do not place or mount any objects around the airbag deployment areas.
- Do not make any modifications to the interior or electrical systems of your vehicle that are not approved by Volvo.

 **Note**

Deployment conditions

Not all airbags may deploy in a collision. This is because different airbags require different conditions and forces to deploy. The severity of damage to the vehicle after a collision is not a reliable indicator of whether any airbags should have deployed.

Airbag gases and smoke

- The gas inside an airbag contains smoke that releases into the interior compartment when the airbag deflates.
- Always be attentive to signs of fire after a severe collision, but keep in mind that some smoke is normal if an airbag has deployed.
- Skin and eyes can become irritated from prolonged exposure to the dust and smoke from deployed airbags.

After airbag deployment

After a collision in which the airbags have deployed, prioritize the safety and medical needs of those involved in the accident. Before handling the vehicle, contact an authorized Volvo workshop. Follow the manual's instructions for safe handling and recovery of a vehicle that's immobilized or in safety mode.

 **Important**

Do not try to drive or move the vehicle if any of the airbags have deployed. If the vehicle poses an acute traffic hazard and is able to move, an exception can be made to move it a short distance out of immediate danger.

5.5.2. Front airbags

The front airbags are designed to deploy in certain frontal collisions. An occupant sensor controls whether the front passenger airbag is enabled or disabled.

The front airbags can help protect the driver and front passenger from severe injury if they are properly seated during a collision. The airbags on each side deploy independently of one another.

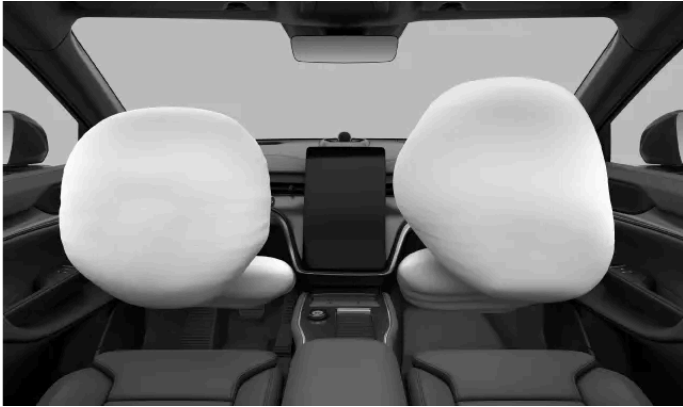

The driver side has two front airbags. The upper airbag is packed inside the steering wheel and the knee airbag is packed behind a panel below the steering wheel.

The passenger side has two front airbags. The upper airbag is packed behind a panel above the glove compartment, and the knee airbag is packed behind a panel below the glove compartment.

All front airbag locations are marked with the text AIRBAG or SRS AIRBAG.

Warning

Do not block the front airbags

- Keep the glove compartment closed when driving.
- Do not place luggage, children or pets in the space between the seated occupant and the front airbags, including in the occupant's lap.
- Legs or feet must never be placed on the dashboard. This could endanger life or lead to serious injury.
- Do not place or mount any items on the dashboard. Even small objects can become dangerous projectiles in a collision and end up between inflating airbags and occupants.

Blocking airbags in general

Keep all airbag locations and expansion spaces free of obstructions. Obstructions can reduce airbag effectiveness and cause serious injury.

- Follow the instructions for a correct sitting posture.
- Properly stow luggage and other objects. The vehicle has several luggage compartments for safe stowing.
- Do not modify or mount accessories onto any panel covering an airbag or adjacent panels.

Passenger airbag status

The content of this manual represents the status of the user manual at the time of printing and may not be completely valid in future instances. For more information refer to the first page for the complete disclaimer note.

The vehicle is equipped with an occupant sensor that controls whether the passenger airbag is enabled or disabled. Read its separate section for detailed information about sensor-controlled airbag status.

If the occupant sensor has disabled the front passenger airbag, the status will be shown in the overhead console.



This icon indicates that the passenger airbag is disabled and cannot be deployed by the vehicle.

 **Warning**

Child restraints and front passenger seat

Never use a child restraint in the front passenger seat. Volvo follows NHTSA's and Transport Canada's recommendations and recommends that all children up to and including 12 years of age sit in the rear seat. This is a particularly strong recommendation for children in rearward-facing child restraints.

 **Tip**

Read everything about airbags

There is more information about airbags and safety in general. Make sure you have read everything about these topics so that you understand the capabilities and limitations of your vehicle's safety features.

5.5.2.1. Sensor-controlled passenger airbag status

The vehicle has a system for detecting the presence of a correctly seated occupant in the front passenger seat. It includes a weight sensor built into the seat. The system disables the front passenger's airbags under certain conditions. When disabled, the airbags will not deploy in a collision.

The vehicle determines whether the front passenger airbags should be enabled or disabled. This requires that the seat be used as Volvo intended. Follow all available recommendations about proper seating and use.

 **Warning**

Always check the status if you are not sure whether the front passenger airbags are enabled or disabled. If the passenger airbag is disabled, this will be visible in the overhead console.

 **Note**

NHTSA child seating recommendations

Volvo follows NHTSA recommendations and recommends that ALL children up to and including 12 years of age sit in a rear seat and be restrained in a suitable manner appropriate to their height and weight. This is strongly recommended for children in rearward-facing child restraints.

Conditions for enabled airbags

The front passenger airbag status depends on the sensor reading of the occupant's presence and classification. The airbag will be enabled under the following conditions and so will deploy in a collision.

- A heavy object is placed on the seat.
- The seat is occupied by a person, whether a child or adult, weighing more than the threshold for enabling the airbag.

Conditions for disabled airbags

The front passenger airbag status depends on the sensor reading of the occupant's presence and classification. The airbags will be disabled under the following conditions and thus will not deploy in a collision.

- The front passenger seat is unoccupied. Small and medium-sized objects placed on the seat are typically not heavy enough to affect airbag status.
- A child or small person is occupying the seat, with or without a booster seat.
- A rearward-facing infant seat is installed according to the manufacturer's instructions.
- A forward-facing child restraint is installed according to the manufacturer's instructions.

The airbags will be disabled regardless of whether or not there is a child sitting in the seat or child restraint.

A symbol in the overhead console indicates that the passenger airbags are disabled and will not be deployed by the vehicle. It is shown along with the words PASSENGER AIRBAG OFF.



Symbol indicating disabled airbags.

Safe and correct use

 **Warning**

Pay attention to the occupant classification system^[1]. Failure to follow these instructions could adversely affect the system's function, lead to incorrect airbag status and result in serious injury of an occupant.

- Do not place any objects that add to the total weight on the seat when it is occupied.
- Do not use the seat belt in a way that exerts more pressure on the passenger than normal.
- The full weight of the front-seat passenger should always be on the seat cushion. The passenger should never lift themselves off the seat cushion using the armrest in the door or the center console, by pressing their feet on the floor, by sitting on the edge of the seat cushion or by pressing against the backrest in a way that reduces pressure on the seat cushion.
- Never wrap the seat belt around an object on the front passenger's seat.
- Do not place any object around or under the front passenger's seat in such a way that jamming, pressing or squeezing occurs between the object and the front seat.

^[1] OCS

5.5.3. Side airbags

The side airbags are designed to deploy in the event of a side-on collision.

The side airbags can help protect the driver and front passenger if they are properly seated. The side airbags will typically only deploy on the collision side of each front seat.

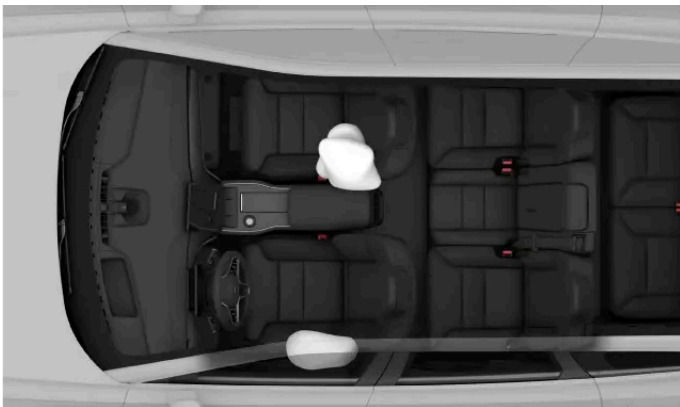

Left-side collision airbags for the front occupants. In a right-side collision, they deploy on the other side of each front seat (mirrored as compared with the depicted scenario).

The side airbags are placed on either side of each front seat. The airbags are packed into the seat's back frame on both sides of the seat.

Both front seats have markings with the text AIRBAG.

 **Warning**

Do not block the side airbags

- Do not place any objects on either side of the front seats. Objects between the seats and the door panel, or between the seats and the center console, can interfere with the side airbags.
- Do not use seat covers that have not been approved by Volvo.

Blocking airbags in general

Keep all airbag locations and expansion spaces free of obstructions. Obstructions can reduce airbag effectiveness and cause serious injury.

- Follow the instructions for a correct sitting posture.
- Properly stow luggage and other objects. The vehicle has several luggage compartments for safe stowing.
- Do not modify or mount accessories onto any panel covering an airbag or adjacent panels.

 **Tip**

Read everything about airbags

There is more information about airbags and safety in general. Make sure you have read everything about these topics so that you understand the capabilities and limitations of your vehicle's safety features.

5.5.4. Inflatable curtains

Your vehicle's inflatable curtains help protect occupants seated by a window in certain collisions. They are placed above the doors on both sides of the vehicle.

The inflatable curtains are designed to help protect the head of a properly seated and secured occupant. Unlike conventional airbags, the inflatable curtains stay inflated for an extended time after deployment.



Inflatable curtain deployed on one side of the vehicle.

The inflatable curtains are packed behind panels along the ceiling's edges on both sides of the vehicle. The panels are marked IC AIRBAG.

 **Warning**

Do not block the inflatable curtains

- Do not hang heavy items from the ceiling hooks or handles. The hooks are meant for light coats and jackets.
- Do not modify or mount accessories to the panels covering the inflatable curtains, the ceiling, pillars or adjacent panels.

Blocking airbags in general

Keep all airbag locations and expansion spaces free of obstructions. Obstructions can reduce airbag effectiveness and cause serious injury.

- Follow the instructions for a correct sitting posture.
- Properly stow luggage and other objects. The vehicle has several luggage compartments for safe stowing.
- Do not modify or mount accessories onto any panel covering an airbag or adjacent panels.

 **Tip**

Read everything about airbags

There is more information about airbags and safety in general. Make sure you have read everything about these topics so that you understand the capabilities and limitations of your vehicle's safety features.

5.5.5. Airbag maintenance and servicing

Contact an authorized Volvo workshop if there is any indication of faults or damage to the airbags or other safety systems.

Any servicing or repairs of the airbags and related safety systems must be performed by authorized service technicians.^[1] Never attempt to alter or repair any part of the vehicle's safety systems yourself. Incorrectly performed repairs can lead to malfunctions and serious injury. Contact an authorized Volvo workshop when your vehicle needs servicing or repairs.



Warning

Vehicle modifications and airbags

Modifications to the vehicle risk affecting airbags and other safety systems. Carefully read the section about vehicle modifications, and contact Volvo ^[2] if you are considering modifying your vehicle in any way ^[3], such as when accommodating a disability.

Airbags and water damage

If the vehicle has been flooded or the interior has been exposed to excessive amounts of water, there may be water damage affecting the safety systems. This can lead to unintentional airbag deployment and cause injury.

- Do not use the vehicle if you suspect it has water damage.
- Contact Volvo Assistance for recovery support.



Note

A warning appears in the instrument panel if the vehicle detects any airbag faults. Immediately contact an authorized Volvo workshop if this happens.



Red SRS warning symbol

^[1] Volvo recommends an authorized Volvo workshop for any repairs or servicing.

^[2] You can find detailed contact information in a separate section in this manual or by contacting Volvo support.

^[3] This applies to all parts of the vehicle, but the front seats and all airbag locations are especially necessary to consider.

5.5.6. Airbag labels

The airbag labels in your vehicle provide essential information about the airbags or can act as airbag location markers.

Airbag location labels

Places in your vehicle marked either AIRBAG, IC AIRBAG or SRS AIRBAG indicate that there is an airbag in that location.



Warning

Airbag label locations

The airbag label locations tell you where your vehicle's airbags are located. Keep these locations and the space around them free of objects. Obstructions can interfere with airbag deployment, reduce their effectiveness and cause serious injury. The airbags section contains more detailed information about use and conditions that can affect the airbags.

Airbag information labels



This label is located on the front passenger seat sun visor.



This label is located in front of the dashboard on the front passenger side.

 **Warning**

Child restraints and front passenger seat

Never use a child restraint in the front passenger seat. Volvo follows NHTSA's and Transport Canada's recommendations and recommends that all children up to and including 12 years of age sit in the rear seat. This is a particularly strong recommendation for children in rearward-facing child restraints.

5.6. Child safety

Several features in the vehicle aim to increase child safety, including anchor points for child restraint installation and child locks.



Children in the vehicle should always be securely seated and kept under adult supervision. Follow the recommendations in this manual, as well as local regulations and recommendations that apply to you.



Warning

Securely seated

- Children should be securely seated in a child restraint or with the vehicle's seat belt, depending on their age and size. Never let a child sit in the lap of another passenger or in a location not intended for passengers.
- Other occupants in the vehicle should be properly seated and use their seat belts correctly. This can help prevent serious injury to children in the vehicle in situations, ranging from sudden braking to severe collisions.

Under supervision

- Never leave children alone in the vehicle. Children may be exposed to potentially harmful temperatures on hot or cold days, or may lock themselves in.
- Do not allow children to play in the vehicle or play with any of the vehicle's controls. This reduces the risk of injury to the child or inadvertent activation or deactivation of the vehicle's features.

5.6.1. Child restraints

Children should always use suitable child restraints and be securely seated in the vehicle according to given recommendations.

Different types of child restraints are specifically designed for certain age and height ranges. Your vehicle is equipped with child restraint attachment points that suit different types of child restraints.

Volvo follows NHTSA's and Transport Canada's recommendations and recommends that all children up to and including 12 years of age sit in the rear seat. This is a particularly strong recommendation for children in rearward-facing child restraints.

Child restraints are classified into different approval levels:

Universal	A child restraint of this approval level can be installed on a seat in any vehicle model, as long as the vehicle seat position is suitable for universally approved child restraints according to the vehicle's manual.
Vehicle specific	A child restraint of this approval level can be installed on a seat in specific vehicle models, as long as the child restraint manufacturer has included the vehicle model in the type list for the specific restraint.

 **Warning**

Child restraints and front passenger seat

Never use a child restraint in the front passenger seat. Volvo follows NHTSA's and Transport Canada's recommendations and recommends that all children up to and including 12 years of age sit in the rear seat. This is a particularly strong recommendation for children in rearward-facing child restraints.

Damaged and old child restraints

Never use or reuse a child restraint:

- if the restraint has been involved in an accident or is damaged in any way
- if the expiration date or service life of the restraint has been exceeded
- if you don't know the full history of the restraint.

 **Important**

Loose child restraints

Never leave a loose child restraint in the passenger compartment. When not in use, keep it installed according to the manufacturer's instructions or store it securely in the trunk. A loose child restraint can cause damage in the event of a collision or sudden braking.

General safety recommendations

When applicable, follow the general safety recommendations regarding seat belt use, headrest adjustment and proper seating.

Local regulations

Regulations on where and how children should be seated and secured differ between regions. Make sure that you know what applies to the region you are in.

Child restraint registration and recalls

Child restraints could be recalled for safety reasons. You must register your child restraint to be reached in a recall. To stay informed about child safety seat recalls, be sure to fill out and return the registration card that comes with new child restraints.

Child restraint recall information is readily available in both the U.S. and Canada.

For recall information in the U.S., call the U.S. Government Auto Safety Hotline at 1-800-424-9393 or go to <https://www-odi.nhtsa.dot.gov/owners/SearchSafetyIssues> [<https://www-odi.nhtsa.dot.gov/owners/SearchSafetyIssues>].

In Canada, visit Transport Canada's Child Safety website at <https://www.tc.gc.ca/en/services/road/child-vehicle-seat-safety.html> [<https://www.tc.gc.ca/en/services/road/child-car-seat-safety.html>].

Airbag information labels



This label is located on the front passenger seat sun visor.

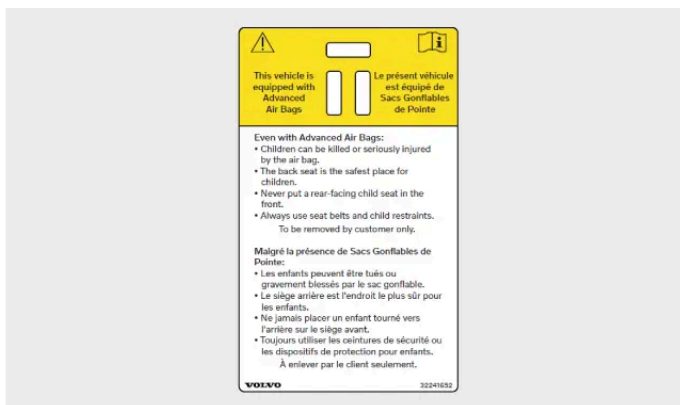

On new vehicles, this label is located in front of the dashboard on the front passenger side.

5.6.1.1. Installing child restraints

When installing and using a child restraint, there are several things to keep in mind, depending on the location of the child restraint in your vehicle.

Warning

Follow the instructions

Take extra care to read all information about child safety in this manual and follow the instructions from the manufacturer of your child restraint. If you do not, the child could sustain serious injury in the event of an accident.

Child restraints and front passenger seat

Never use a child restraint in the front passenger seat. Volvo follows NHTSA's and Transport Canada's recommendations and recommends that all children up to and including 12 years of age sit in the rear seat. This is a particularly strong recommendation for children in rearward-facing child restraints.

 **Important**

Local regulations

Regulations on where and how children should be seated and secured differ between regions. Make sure that you know what applies to the region you are in.

Manufacturer's instructions

Always follow the instructions from the manufacturer of the child restraint.

5.6.1.1.1. Installing child restraints on the second-row seats

To securely install a child restraint on either of the second-row seats, there is important information to read and recommendations to follow.

ISOFIX^[1], top and lower tether attachment points can be used when installing a child restraint on the second-row seats.

 **Tip**

Long-term use of a child restraint may cause wear and tear on the vehicle interior. Use a kick guard accessory to protect the vehicle interior.

Allowed child restraints

- Only use child restraints that are recommended by Volvo, universally approved or are vehicle-specific approved where the vehicle is included in the child restraint manufacturer's vehicle list.

Seat preparations

- Remove cushion extenders, leg supports and other accessories from the seat before installing a child restraint. If you use a kick guard accessory, this can remain on the seat.
- Child restraint support legs, if any, should always be mounted directly to the floor. Do not fit support legs to any raised or uneven floor surfaces, footrests or other objects. To get enough space, adjust the seat to its rearmost position before installing.^[2]
- Loose objects should not be stored around any support legs of a child restraint.
- Any restraining straps for a child restraint should always be secured to designated attachment points. Do not secure restraining straps to seat rails, handles or other parts of the interior.
- When installing an adjustable, rearward-facing child restraint, adjust the child restraint according to the child's age. Older children should be seated in a more upright position than younger ones.

Seat belt use

- When installing a child restraint secured using the vehicle's seat belt, or when the vehicle's seat belt is used to secure a child, make sure that brackets or other parts of the restraint do not come into contact with the seat belt buckle release button.

- If you use the vehicle seat belt when installing a child restraint, you can set the seat belt to only retract. Read more about this in a separate section of the manual.
- When securing a child with the vehicle's seat belt, always start with the seat belt's upper attachment point adjusted to its highest level. Then lower it as needed to properly position the belt against the shoulder.

 **Tip**

Buckling the seat belt

It can be difficult to buckle a child sitting in a child restraint due to the narrow spaces involved. To make it easier, push the belt buckle forward slightly. This will give you a better angle to work with. You can also temporarily move the seat next to the child restraint to get more space.

 **Warning**

Follow the instructions

Take extra care to read all information about child safety in this manual and follow the instructions from the manufacturer of your child restraint. If you do not, the child could sustain serious injury in the event of an accident.

 **Important**

Follow the general recommendations for any child restraint attachment points used to install a child restraint.

1. Follow the instructions from the manufacturer to install the child restraint.

 **Note**

Installation questions

If you have installation questions, contact the manufacturer of the child restraint for more detailed instructions.

Protecting the vehicle interior

During installation, be careful to avoid damage to the vehicle interior caused by protruding parts or sharp edges on the child restraint.

- If the child restraint uses lower tether straps, never adjust the position of the seat after the straps have been secured to the lower tether attachment points. Always remember to remove the straps when the child restraint is not installed.
- Never adjust the backrest of a seat if there is a child restraint installed on it that uses the top tether attachment point to secure it. This can damage the child restraint or loosen the tethers that keep it fixed in place.
- Fasten loose parts of child restraints, such as restraining straps, according to the manufacturer's instructions.

 **Important**

Raised headrest

The headrest must always be raised when a child restraint is installed.

General safety recommendations

When applicable, follow the general safety recommendations regarding seat belt use, headrest adjustment and proper seating.

Local regulations

Regulations on where and how children should be seated and secured differ between regions. Make sure that you know what applies to the region you are in.

 **Tip**

Seat belt reminder

The seat belt reminder may appear for a seat if a child restraint has been installed without using the vehicle's seat belt. You can dismiss the reminder in the instrument panel, but other warning indicators will remain active. Buckle the seat belt to remove them.

^[1] Also known as LATCH or LUAS

^[2] An exception can be made if a child restraint is also installed on the seat behind it. In this case, try to adjust the seat to accommodate both child restraints.

5.6.1.1.2. Installing child restraints on the third-row seats

To securely install a child restraint on either of the third-row seats, there is important information to read and recommendations to follow.

ISOFIX^[1] and top tether attachment points can be used when installing a child restraint on the third-row seats.

 **Tip**

Long-term use of a child restraint may cause wear and tear on the vehicle interior. Use a kick guard accessory to protect the vehicle interior.

Allowed child restraints

- Only use child restraints that are recommended by Volvo, universally approved or are vehicle-specific approved where the vehicle is included in the manufacturer's vehicle list.
- Child restraints that use support legs are not allowed on the third row.

The content of this manual represents the status of the user manual at the time of printing and may not be completely valid in future instances. For more information refer to the first page for the complete disclaimer note.

- Any restraining straps for a child restraint should always be secured to designated attachment points. Do not secure restraining straps to seat rails, handles or other parts of the interior. There are no lower tether attachment points at floor level for the third-row seats.

Seat preparations

- Remove cushion extenders, leg supports and other accessories from the seat before installing a child restraint. If you use a kick guard accessory, this can remain on the seat.
- When installing an adjustable, rearward-facing child restraint, adjust the child restraint according to the child's age. Older children should be seated in a more upright position than younger ones.
- To make space in the third row, move the second-row seats forward. Fold the outer and center second-row seats to get access to the third row. Then install the child restraint while sitting next to it.
- Always leave the second-row backrests in their most upright position when there is a child restraint installed behind them.

Seat belt use

- When installing a child restraint secured using the vehicle's seat belt, or when the vehicle's seat belt is used to secure a child, make sure that brackets or other parts of the restraint do not come into contact with the seat belt buckle release button.
- If you use the vehicle seat belt when installing a child restraint, you can set the seat belt to only retract. Read more about this in a separate section of the manual.

Warning

Follow the instructions

Take extra care to read all information about child safety in this manual and follow the instructions from the manufacturer of your child restraint. If you do not, the child could sustain serious injury in the event of an accident.

Important

Follow the general recommendations for any child restraint attachment points used to install a child restraint.

1. Follow the instructions from the manufacturer to install the child restraint.

Note

Installation questions

If you have installation questions, contact the manufacturer of the child restraint for more detailed instructions.

Protecting the vehicle interior

Be careful during installation to avoid damage to the vehicle interior caused by protruding parts or sharp edges of the child restraint.

- Fasten loose parts of child restraints, such as restraining straps, according to the manufacturer's instructions.

 **Important**

Raised headrest

The headrest must always be raised when a child restraint is installed.

General safety recommendations

When applicable, follow the general safety recommendations regarding seat belt use, headrest adjustment and proper seating. Make sure you read these sections of the manual before installing a child restraint.

Local regulations

Regulations on where and how children should be seated and secured differ between regions. Make sure that you know what applies to the region you are in.

 **Tip**

Seat belt reminder

The seat belt reminder may appear for a seat if a child restraint has been installed without using the vehicle's seat belt. You can dismiss the reminder in the instrument panel, but other warning indicators will remain active. Buckle the seat belt to remove them.

^[1] Also known as LATCH or LUAS

5.6.1.2. Child restraint attachment points

Your vehicle has different types of attachment points. Be sure to use the correct attachment points for your specific child restraint.

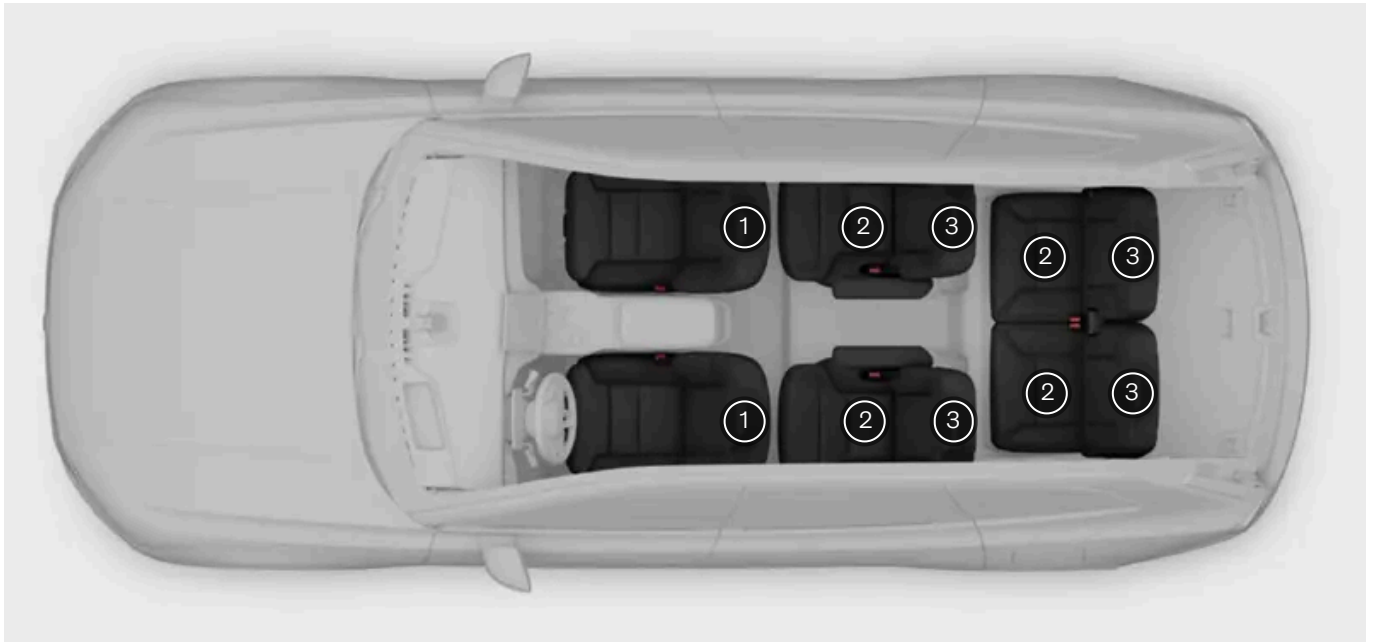

- ① Lower tether attachment points on the floor rails of the front seats
- ② ISOFIX^[1] attachment points between the backrests and seat cushions of the rear seats
- ③ Top tether attachment points on the backs of the rear seats

Your vehicle's various attachment points can be used in combination with each other or together with other fastening methods to secure different types of child restraints.

ISOFIX, also known as LATCH or LUAS, is an international standard for child restraint attachment points that can be used in combination with the top tether attachment points or a support leg.

Some child restraints are secured using a vehicle seat belt, usually in combination with other fastening methods.

i Note

Manufacturer's instructions

When using attachment points, always follow the instructions from the manufacturer of the child restraint.

^[1] Also known as LATCH or LUAS

5.6.1.2.1. ISOFIX/LATCH attachment points

Your vehicle is equipped with ISOFIX^[1] attachment points that can be used to secure child restraints on a rear seat.

The ISOFIX^[1] attachment points can be used in combination with other fastening methods to secure ISOFIX^[1] child restraints. These attachment points are part of an international standard for child restraints.

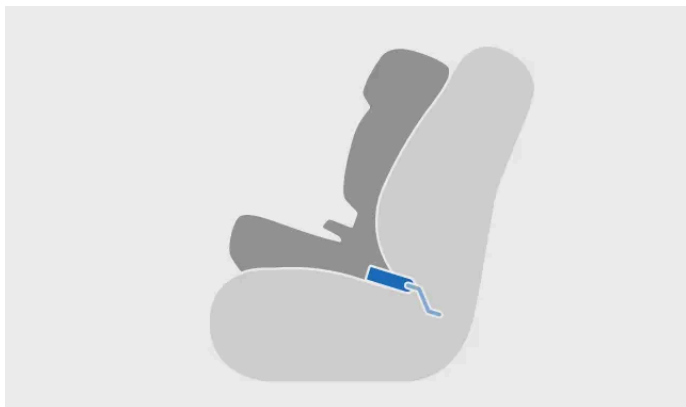

Child restraint installed using ISOFIX^[1]



Attaching to ISOFIX^[1] attachment point

Child restraints installed on any of the second- or third-row seats can use these attachment points.

Note

ISOFIX is an international standard for child restraint attachment points. It is also known by other regional names such as LATCH and LUAS.

Attachment point locations for the rear seats

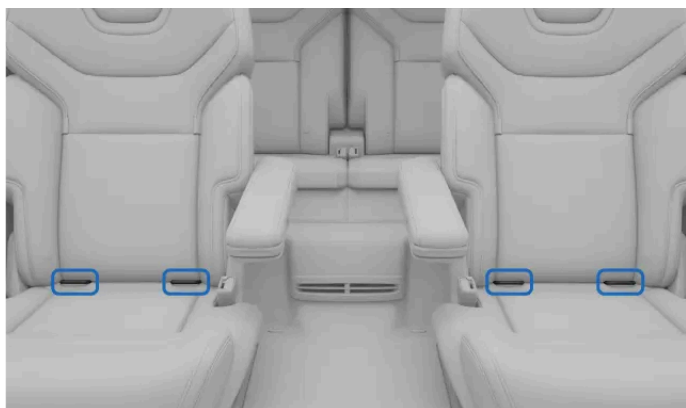

Locations of ISOFIX^[1] attachment points for the second-row seats

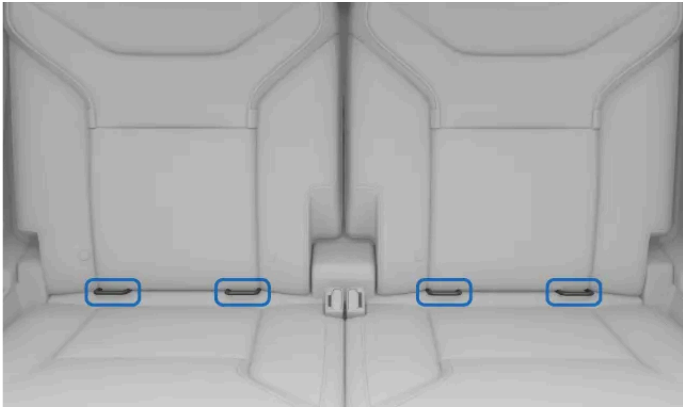

Locations of ISOFIX^[1] attachment points for the third-row seats

The ISOFIX^[1] attachment points are located between the seat's backrest and the seat cushion. You may need to push down on the seat cushion to fully access them.

The attachment locations are indicated by the ISOFIX^[1] symbol.



i Note

Manufacturer's instructions

When using attachment points, always follow the instructions from the manufacturer of the child restraint.

^[1] Also known as LATCH or LUAS

5.6.1.2.2. Top tether attachment points

Your vehicle is equipped with top tether attachment points that can be used to secure child restraints in a rear seat.

Attachment point locations for the rear seats

The top tether attachment points are located on the back of the backrests.



The top tether attachment point locations for the second-row seats and third-row seats are indicated by the top tether symbol.



The top tether attachment points can be used in combination with other fastening methods to secure different types of child restraints.

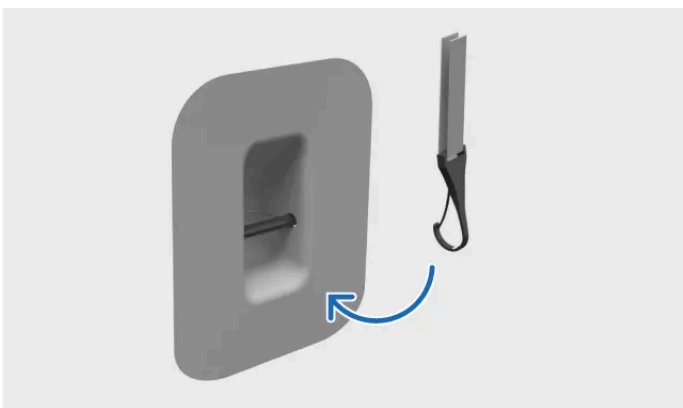

Fastening tether to top tether attachment point

Child restraints installed on any of the rear seats can use these attachment points.

 **Important**

Manufacturer's instructions

When using attachment points, always follow the instructions from the manufacturer of the child restraint. Unless otherwise instructed, the top tether straps should be routed around the sides of the headrest support. If there is only one strap, route it around the side closest to the seat belt retractor.

5.6.1.2.3. Lower tether attachment points

Your vehicle is equipped with lower tether attachment points that can be used to secure child restraints on a second-row seat.

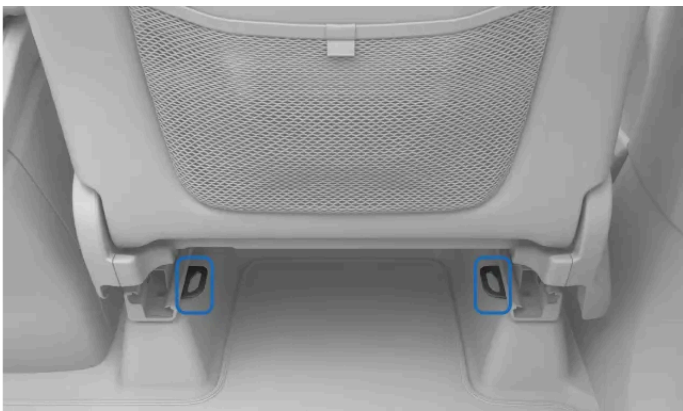

The lower tether attachment points can be found at the back of the floor rails of the front seats.

The lower tether attachment points are mainly used together with the vehicle seat belt to secure certain rearward-facing child restraints.

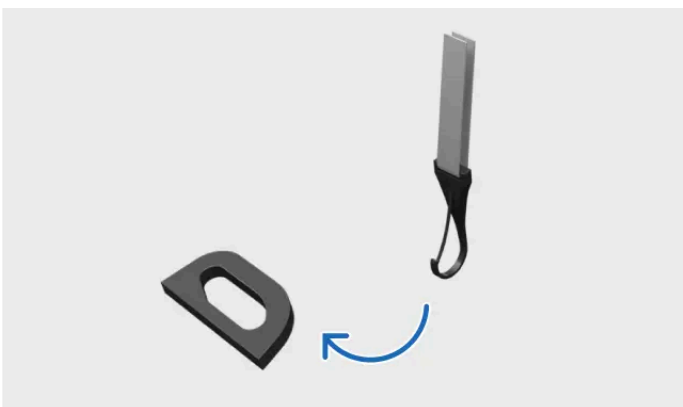

Fastening tether to lower tether attachment point

Child restraints installed on any second-row seat can use these attachment points.



Tip

Attaching the hook

Sometimes the narrow spaces can make it difficult to attach the tether hook to the attachment point. Try to flip the hook over and attach it from another angle.



Note

Manufacturer's instructions

When using attachment points, always follow the instructions from the manufacturer of the child restraint.

6. Entry and security

Learn about the various features associated with entering and exiting the vehicle, including how the keys and alarm work.



This section of the manual covers the different types of keys, opening and closing the doors, locking and unlocking, and the alarm.

Learn more about the different types of keys and how you can customize your vehicle's responses when you lock, unlock, approach or leave it.

6.1. Keys

Your vehicle supports several types of keys. Some keys can be sensed by the vehicle as you approach or leave it, while key cards need to be placed on the driver's door handle.

Key types

! Important

Using keys is fairly straightforward, but you should be aware of the limitations of each key type for safety and security reasons. It's important to read all of the information in this manual about keys and how to use them.

Vehicle and key wireless technologies may cause disturbances in other devices. You can find more information about these systems in the specifications section of this manual.

For safety and security reasons, never leave unattended keys in an exposed place.

The vehicle supports the following types of keys:

The content of this manual represents the status of the user manual at the time of printing and may not be completely valid in future instances. For more information refer to the first page for the complete disclaimer note.

- Digital key
- Key card
- Key tag

Digital keys and charged key tags are distance-capable, meaning your vehicle can detect them when you approach or leave it. This allows for automatic locking and unlocking.

Keys without power, such as a key card or a distance-capable key with a discharged battery, use NFC^[1]. This means they can only be read at specific key reading locations.

Note

Ordering new or additional keys

Your vehicle comes with a limited number of keys. Contact Volvo Support if you lose a key or simply require additional keys.

Digital key availability

The digital key for your vehicle is currently available for certain Apple iPhone, Samsung Galaxy and Google Pixel models. Check with your device manufacturer if you're unsure about the compatibility of your device. Many manufacturers have information about compatibility and UWB capability on their website.

Tip

Key card as backup access

It's a good idea to keep a key card on hand in case a device with a digital key is lost or stolen. It can also be helpful if you need to give a service technician or roadside assistance access to your vehicle but don't want to share your digital key.

Key reading locations

There are two ways your vehicle can detect your key and use it to lock or unlock:

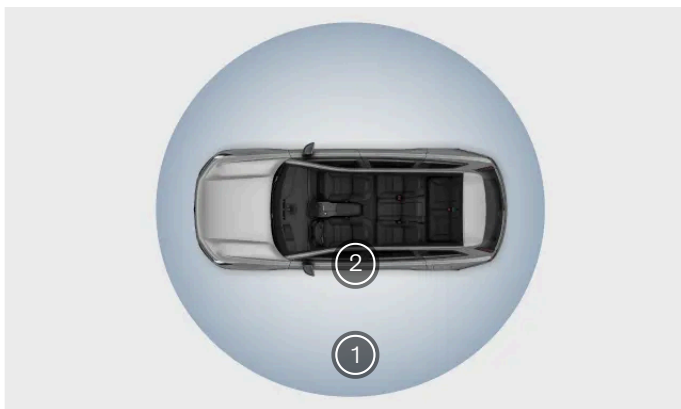

- ① Distance-capable keys can lock or unlock the vehicle from a distance.
- ② Key cards lock or unlock the vehicle when held against the key reader in the driver's door handle.

There is also a key reader between the front seats where you can place a key card or a discharged distance-capable key to start the vehicle. The key reader is located in the same place as the wireless charger.

 **Note**

Unresponsive vehicle

If your vehicle doesn't respond when you approach it with your distance-capable key, try unlocking it by pulling the door handle. You can also place any of your keys on the door handle to unlock the vehicle.

The reasons your vehicle may not respond as usual include:

- The vehicle has been turned off for several days and needs time to turn its systems back on, recognize the key and give you access.
- The key's wireless signals are being blocked.
- You're using a key tag that has a low battery or has entered battery-saving mode.

If the vehicle's batteries are drained down completely, it will not respond to any key.

User profiles and keys

You can assign keys to a user profile. This allows the vehicle to automatically identify the person unlocking it and apply all of their customizations. You can read more about which customization options are available in a separate section of this manual.

Locking keys in

If you lock the vehicle while a distance-capable key is still inside, that key will be temporarily deactivated. You can still use one of your other keys on the door handle to enter the vehicle.

 **Warning**

If you leave a person in the vehicle, make sure that you do not leave a key in the vehicle. This is especially important in the case of children.

Improper use of vehicle opening and starting systems can result in serious personal injury. Always take your keys with you when you leave the vehicle, including the digital key and key tag. The vehicle can be started, and systems such as the power windows can be operated, leading to serious personal injury. Never leave children, disabled persons or anyone who cannot help themselves in the vehicle. The doors can be locked using a distance-capable key or by touching the capacitive lock sensor area of the door handle. This could result in people being trapped in the vehicle in an emergency. For example, depending on the time of year, people trapped in the vehicle can be exposed to very high or low temperatures. Never remove the key while the vehicle is moving or while it is rolling to a stop.

 **Important**

The outer door handle contains electronic components. Protect these from rough handling. Never leave any vehicle keys inside the vehicle, including digital and distance-capable keys. Entry by unauthorized persons could harm the vehicle, or your vehicle could be stolen. Always take the keys with you whenever you leave your vehicle.

6.1.1. Key tag

You can use your key tag to lock, unlock and drive the vehicle.



The key tag works at a distance to lock, unlock and start the vehicle, but it can also be used in the same way as a key card.

To use it like a key card, place it on the driver's door handle with the logo facing towards you.

Charging the key tag

Use the wireless charger between the front seats or an external wireless charger^[1] to recharge the tag.

Battery level

You can see the battery status of any connected key tag in the vehicle status view.

! Important

- If the tag is left with a discharged battery for too long, you won't be able to recharge it. If the battery is completely discharged and does not respond to being recharged, you can buy a new one. Contact an authorized Volvo workshop for more information.
- If the vehicle does not detect your key tag while you are inside it, then it won't lock when you leave. To update the key detection status, place the key on the key reader.

i Note

- To maintain optimal battery health, avoid leaving the battery fully discharged for long periods.
- If your key tag stops working at a distance, it may be due to a low battery. Be aware that the signals between the key and the vehicle can also be affected by obstacles or interference from other signals.
- Remember that even if the key tag battery is discharged, it can still be used as a key card.

 **Warning**

The key tag includes a non-replaceable battery that can be extremely hazardous. Keep batteries out of reach of children. If you suspect a battery has been ingested or in any way inserted into the body, seek immediate medical attention. Battery fluid is also hazardous, and physical contact with it should be avoided.

^[1] Qi compatible

6.1.1.1. Charging the key tag

Keep the key tag charged for optimal functionality.

Battery level

You can see the battery status of any connected key tag in the vehicle status view.

Tag battery indicators

 Key tag battery is critically low.

 Key tag low battery status^[1].

 Key tag is charging.

 Key tag battery is fully charged.

 The vehicle does not detect the key tag. This could indicate that the battery is completely dead.

 **Warning**

The vehicle's use of Bluetooth, UWB^[2] and NFC signals may cause disturbances in other devices at certain distances.

 **Important**

Do not place cards with NFC, such as key cards or electronic payment cards, between the wireless charger and the device when using the charging function. This could damage them.

Keep sensitive devices away from the vehicle's sensors so that neither suffer interference or damage.

Before charging the key tag, make sure there are no other objects on the charger.

1. Make sure the wireless charger is turned on. You do this via the center display.
2. Place the tag on the center of the wireless charger with the logo facing upward.



Wireless charger

- > The key tag will start charging.
While charging, the tag works like a key card.

i Tip

You can also use a Qi charger to recharge the tag.

! Important

To maintain optimal battery health, don't leave the battery fully discharged for long periods.

If the tag is left with a discharged battery for too long, you won't be able to recharge it. If the battery is completely discharged and does not respond to being recharged, you can buy a new one. Contact an authorized Volvo workshop for more information.

i Note

The key reader and wireless charger are located in the same place. This means that if you have any type of vehicle key on the key reader, you have to remove it to be able to wirelessly charge a phone.

If the tag is too hot or too cold it won't charge correctly.

The vehicle will not respond to any key if the vehicle battery is completely discharged.

Remember that even if the key tag battery is discharged, it can still be used as a key card.

[1] The key tag won't be distance-capable until it has been recharged, but it can still be used as a key card.

[2] Ultra-wideband

6.1.2. Key card

Your key cards can lock and unlock the vehicle and allow you driving access.



You can lock and unlock the vehicle by placing the key card on the driver's door handle.

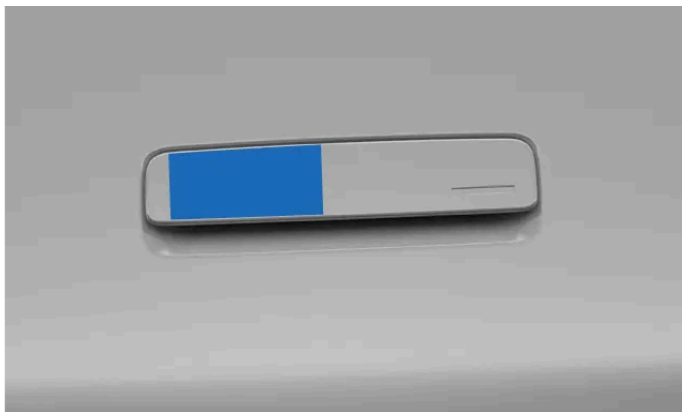

Key reading location on the driver's door handle

The key card starts the vehicle when it is placed on the key reader located between the two front seats. When you start using the pedals, you can remove the card from the key reader.

If the vehicle is stationary without a card on the key reader for a while, you will need to put the card back on the reader for the vehicle to reactivate driving mode.

Warning

The vehicle's use of Bluetooth, UWB^[1] and NFC^[2] signals may cause disturbances in other devices at certain distances.

Important

Do not place cards with NFC, such as key cards or electronic payment cards, between the wireless charger and the device when using the charging function. This could damage them.

i Note

The key reader and wireless charger are located in the same place. This means that if you have any type of vehicle key on the key reader, you have to remove it to be able to wirelessly charge a phone.

i Tip

Key card as backup access

If your vehicle is unresponsive when you try to unlock it using a distance-capable key, try unlocking the driver door with your key card. The key card is designed specifically to also act as a backup in this kind of situation. You will be able to get to any belongings inside even if the other doors don't work. If your vehicle is unresponsive, contact Volvo support.

Keep in mind that if the vehicle battery is discharged, you won't be able to open the doors.

[1] Ultra-wideband

[2] Near-Field Communication

6.1.3. Digital key

The digital key allows you to lock, unlock and start your vehicle using a compatible phone or smart watch.

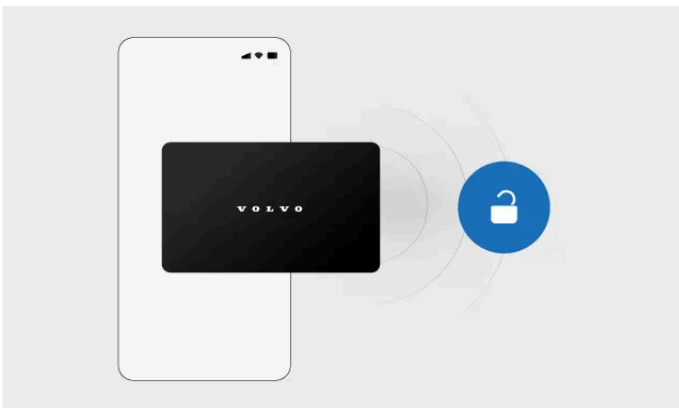

Once you've set up a digital key on your device, it works in the same way as your other keys. If your device has UWB^[1] capability, your vehicle will be able to detect the digital key from a distance. If your device doesn't have UWB capability, the digital key works as a key card.

The vehicle's owner can create one primary digital key. Once the primary key has been created, you can share digital keys with family and friends.

 **Note**

Compatible devices

The digital key for your vehicle is currently available for certain Apple iPhone, Samsung Galaxy and Google Pixel models. Check with your device manufacturer if you're unsure about the compatibility of your device. Many manufacturers have information about compatibility and UWB capability on their website.

Using the digital key on a device with UWB

When you set up a digital key on a device with UWB capability, you can lock or unlock the vehicle by:

- using the approach and leave feature for automatic unlocking and locking
- touching the underside of the door handle
- using your device as a key card
- using the lock and unlock button in your device's wallet app.

To get driving access, you just need to bring your device with you inside the vehicle or place it on the key reader between the front seats. The key reader is located in the same place as the wireless charger.

 **Tip**

Disable passive entry in wallet app

Many wallet apps have a setting that lets you disable passive entry. When this feature is disabled, your vehicle won't unlock automatically when you get close to it while carrying a digital key. The approach unlock feature will still be available when you use your other distance-capable keys.

Using the digital key on a device without UWB

If your device doesn't have UWB capability, your digital key works as a key card. To unlock the vehicle, open your key in the wallet app and place the device on the left-hand side of the driver's door handle. To start the vehicle, put the device on the key reader between the front seats.

Sharing the digital key

Once you've set up a primary digital key, you can share it with family and friends. Open the digital key in your phone's wallet app to find the sharing option.

 **Note**

The option to share your digital key may not be available in all wallet views. Make sure to open the wallet app via the app icon.



Tip

No battery

You may still be able to use your digital key as a key card even if your device has run out of battery. Contact the device manufacturer for more information.

[1] Ultra-wideband

6.1.3.1. Creating a digital key

The vehicle's owner can create a primary digital key at any time via settings.

The vehicle's owner can create a primary digital key in the setup guide. This digital key can then be shared with family and friends. You can access the guide via your vehicle's center display, the Volvo Cars app or the activation email you received when you created your Volvo ID.



Note

Compatible devices

The digital key for your vehicle is currently available for certain Apple iPhone, Samsung Galaxy and Google Pixel models. Check with your device manufacturer if you're unsure about the compatibility of your device. Many manufacturers have information about compatibility and UWB capability on their website.

Creating a digital key via the center display

You need to be inside the vehicle while setting up your digital key. You also need to make sure that:

- the vehicle is stationary and unlocked
- you are signed in to the vehicle's owner profile in the center display
- both your vehicle and your phone have a stable internet connection ^[1]
- both your vehicle and your phone are updated to the latest software version
- Bluetooth is enabled on your phone
- cellular data usage is enabled in the wallet app on your phone
- you have access to the Volvo ID registered to the vehicle's owner profile. ^[2]

1. Press the vehicle symbol  in the bottom bar and go to **Settings**.
2. Go to **Profiles**.
3. Select the owner profile and go to **Car keys** → **Set up digital key**.

4. Scan the QR code in the center display using your phone and follow the link that appears.
5. Authenticate yourself using your Volvo ID.
 - > The pairing guide appears on your phone.
6. Follow the guide on your phone.
 - > If pairing is successful, your primary digital key appears in your phone's wallet app. You can now share your digital key with family and friends.

Moving the primary digital key to another phone

If you want to move the primary digital key to another device, such as a new phone, you can do so via the center display. In the owner's profile settings, select your primary digital key and press **Change device** to move the key to the new device.



Tip

Assigning digital keys to a profile

The primary digital key is always assigned to the vehicle's owner profile. If you have shared a digital key with someone, make sure they assign it to their vehicle user profile to ensure that all of their preferred settings are applied when they unlock the vehicle.

- [1] If the vehicle is parked in an underground garage or surrounded by obstacles such as buildings, hills or mountains, the network signal may be blocked or too weak.
- [2] If you aren't the vehicle owner, you can't create your own digital key. You need to ask the owner to share their digital key with you instead.

6.1.3.2. Deleting a digital key

You can delete digital keys at any time, either via the center display or in your phone's wallet app.

Anyone with a digital key can delete and remove it from their phone's wallet app. The vehicle's owner can also remove the primary key or shared keys via their wallet app or the owner's profile in the center display.

 **Note**

Compatible devices

The digital key for your vehicle is currently available for certain Apple iPhone, Samsung Galaxy and Google Pixel models. Check with your device manufacturer if you're unsure about the compatibility of your device. Many manufacturers have information about compatibility and UWB capability on their website.

Grace period

When the vehicle's owner deletes a shared key through their phone's wallet app, the key will be fully disabled after the shared key's holder finishes their last drive or 48 hours after deletion. If the shared key is deleted via the center display, the key is instantly disabled.

Removing one or all digital keys via the center display

1. Press the vehicle symbol  in the bottom bar and go to **Settings**.
2. Go to **Profiles**.
3. Select the owner's profile and go to **Car keys** → **Digital keys**.
4. Select the digital key or keys you want to remove.
5. Press **Remove** and authenticate yourself using your Volvo ID.

 **Note**

Lost device

If a device with a digital key gets lost, it's a good idea to delete the digital key. If you can't do it via the center display, you can delete it via the Volvo Portal website. Always keep a key card on hand so that you can still access your vehicle if you lose your device.

6.1.4. Key reading locations

There are some key interaction points where your vehicle can detect your keys to let you lock, unlock or drive it.

Interaction points for keys

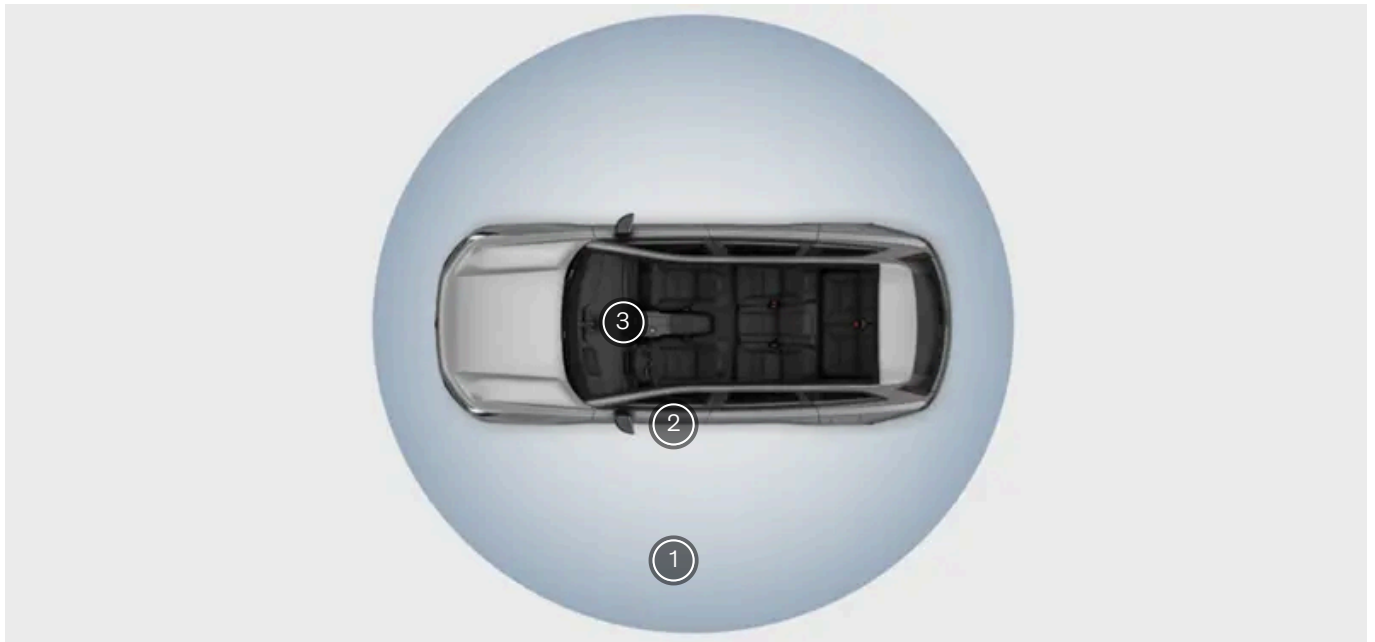

- ① Your distance-capable keys can lock and unlock the vehicle automatically from a short distance away.
- ② Keys that are not distance-capable need to be placed on the driver's door pillar to unlock the vehicle.
- ③ Key cards or discharged keys can be placed on the key reader between the front seats to start the vehicle.

Distance-capable keys

Digital keys and charged key tags are distance-capable, meaning your vehicle can detect them when you approach or leave it. This allows for automatic locking and unlocking.

Go to settings to select your preferences and to turn automatic locking and unlocking on or off.

i Note

NFC functionality

Your distance-capable keys also have NFC^[1] functionality. This means that even if a distance-capable key has a low or discharged battery, you can still use it as a key card. Therefore, any reference to key card functionality applies to discharged distance-capable keys too.

Exterior key reader

You can lock and unlock the vehicle by placing any type of key on the key reading sensor. It's on the side of the driver's door handle which is closest to the front of the vehicle.

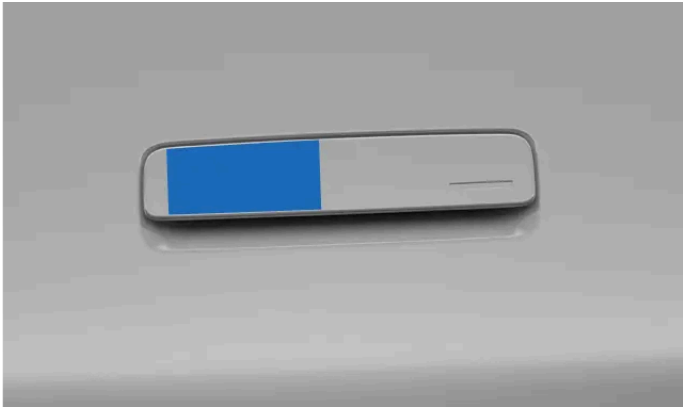

Key reading location on the driver's door handle

Make sure the card or device is laid flat against the reader. If you're using a key tag, the logo should be facing towards you.

Interior key reader

You can place your key card or a discharged key tag on the key reader between the front seats to get driving access.



The key reader between the front seats is also the wireless charger.

i Note

The key reader won't work at the same time as the wireless charger.

^[1] Near-Field Communication

6.2. Opening and closing

Your vehicle has a few features and situation-specific behaviors you should be aware of when opening and closing the doors.

Opening the doors

The outer door handles stay folded in until you unlock the vehicle.

From inside the vehicle, the doors open using the lever near the window controls.

The rear doors are equipped with a double-pull feature to help protect against accidental opening. To open the rear doors from the inside, you need to pull the door handle twice.



Tip

Soft close

If you leave the doors in a nearly closed position, the vehicle will attempt to close them fully.



Important

Emergency open

The doors can always be opened from the inside using the inner door lever unless the child lock is on. This can be useful in an emergency or if your vehicle's battery is flat. To release the door latch mechanically, pull the lever all the way up twice.



Note

In rare cases, frost or ice may prevent the handles from folding outwards. If this happens and the vehicle is unlocked, you can still use the handles to open the vehicle.

If ice buildup prevents you from accessing the door handles, there are some steps you can try:

- Activate preconditioning in the Volvo Cars app to heat the vehicle.
- Carefully brush or tap the door handle to remove the ice manually.

Opening the hood

The hood is opened using a lever near the driver's seat.

Opening the trunk

Open the trunk manually using the button on the trunk hatch or via the center display. You can also use the hands-free feature.

Open door warning

Regularly check that the hood, trunk and doors are fully closed.



Open doors are highlighted in red on the vehicle symbol in the bottom right of the instrument panel. The vehicle will also use warning sounds to indicate improperly closed doors.

For safety reasons, the vehicle will make it harder for you to accelerate from a low speed if the driver door isn't fully closed.

! Important

In the interest of safety and security, you should always make sure that the doors have closed fully, even if your vehicle will try to automatically close passenger compartment doors that are slightly open.

6.2.1. Opening the hood

You need to pull two separate release levers to open the hood; this provides access to the front storage compartment. Be sure to close the hood again before driving the vehicle.

Locations of release levers

The lever to open the hood can be found below the dashboard on the driver's side, just in front of the door hinge.



The second lever is below the front edge of the hood.



1. Pull back on the hood release lever inside the vehicle.

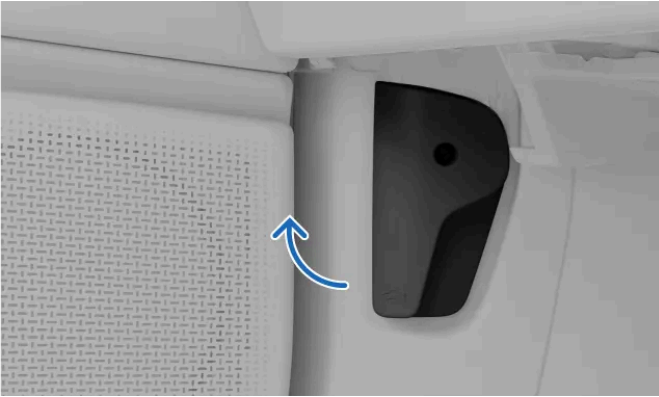

Pulling the interior release lever

- > The hood releases from its fully locked position. It opens slightly, which gives you access to the second lever.
2. Pull the lever that's located below the front edge of the hood.



- > The hood releases fully.
3. Lift the hood by its front edge and open it to its fully extended height.
- > The hood will stay in position.

i Note

After closing the hood

If you see an open hood warning in the instrument panel, open the hood and check for obstructions before closing it again. Contact Volvo support if the notification doesn't go away.

 **Warning**

Do not drive with the hood open

Stop the vehicle immediately if there is any indication that the hood is not completely closed.

6.2.2. Closing the hood

Take extra care to ensure that the hood completely closes after it has been opened.

Make sure nothing gets in the way of the hood as it closes.

 **Warning**

Pinching and crushing hazard

Keep all hands away from the hood's closing path. Be extra cautious when children or pets are nearby.

1. From the fully opened position, simply pull the hood down by holding the outer edge.
2. Carefully lower the hood until it reaches the locking mechanism.



Where to press the hood down to close it

Press down with both hands on the sides of the hood lid's front edge.

 **Note**

Make sure the hood fits into the latches at the same time. Keep the front edge flat as it closes.

You should hear the hood lock on both sides.

4. Make sure there are no significant gaps or any indication that the hood is not completely closed.

 **Note**

Open hood warning

If you see an open hood warning in the instrument panel, open the hood and check for obstructions before closing it again. Contact Volvo support if the notification doesn't go away.

 **Warning**

Stop the vehicle immediately if there is any indication that the hood is not completely closed.

6.2.3. Trunk access

You have several options for accessing the trunk hatch. For example, you can open it manually or use the hands-free feature.

 **Warning**

Be aware when the trunk is opening or closing. Make sure that no people are in the vicinity of the trunk when it is in motion. Always use the trunk access functions with caution. If there is an obstruction when closing the trunk, you will hear a beep.

Do not interfere with the trunk support arms; they are highly pressurized, and tampering with them can result in serious injury.

After use, check the display for indications that the trunk is fully closed.

 **Note**

Pinch protection

The vehicle can detect obstructions to the trunk hatch when opening or closing. If the trunk hatch tries to close with an obstruction in the way, you will hear a warning sound and the trunk will open fully. If pinch protection activates while the trunk hatch is opening, the lid will stop moving.

Opening the trunk manually

If the vehicle is unlocked, you can simply open the trunk using the button above the license plate.

Opening and closing the trunk hands-free

If you're carrying a distance-capable key, you can use the hands-free feature. Make a single kicking motion under the rear bumper and the trunk will open or close automatically.

Access via the center display

The content of this manual represents the status of the user manual at the time of printing and may not be completely valid in future instances. For more information refer to the first page for the complete disclaimer note.

You can open and close the trunk using the controls in the center display. Press and hold the button to complete the trunk movement.

Using the trunk closing button

Press the trunk closing button on the inner right side of the trunk hatch to close it.



Location of the trunk closing button



You can also use the closing button to adjust how far the trunk opens. This is useful if you want the trunk hatch to stay within easy reach or if you are somewhere with a low ceiling, such as a garage.

Locking the trunk

The trunk will automatically lock when you close all of the doors and lock the vehicle as you normally would. You can also press the trunk locking button on the inside of the trunk hatch or lock and unlock the trunk via the Volvo Cars app.



Press the trunk locking button when carrying a distance-capable key to close the trunk and lock the vehicle. If the trunk can't lock for some reason, you will hear three beeps.

Note

Locking with the trunk open

If the trunk is not properly closed when you lock the vehicle, the alarm won't be fully enabled. In these cases, the alarm will only protect the side doors.

The vehicle also won't detect any motion inside if you've locked it with the trunk still open.

Once you close the trunk, it will lock and be covered by the alarm.

6.2.3.1. Opening the trunk hands-free

If your hands are full and you have your distance-capable key with you, just pass your foot under the rear bumper once to make the trunk open automatically.

If your vehicle is locked, using the hands-free feature will unlock and open the trunk. You can choose whether only the trunk or all of the doors unlock via the locking settings in the center display.



The sensor detects movement under the rear bumper. Any detected movement unlocks the trunk.

Make sure you have a charged distance-capable key on you.

1. Make a single kicking motion under the rear bumper and move back.
- > A short audible response indicates that it's about to open.

i Note

Repeated foot movements cancel or reset the activation.

Closing the trunk hands-free

You can also use the kicking motion to close the trunk hands-free. When the hatch is about to close, you will hear a beeping sound. The hatch will start moving shortly after.

If you try using the hands-free feature without a distance-capable key, three beeps will indicate that the trunk cannot close.

If the function appears to be unresponsive, keep in mind that obstructions to the sensor such as mud can interfere with a proper response.

6.2.3.2. Adjusting trunk opening height

You can adjust how much the trunk hatch opens.

The content of this manual represents the status of the user manual at the time of printing and may not be completely valid in future instances. For more information refer to the first page for the complete disclaimer note.

If the vehicle is often in places with a low ceiling, such as a garage, you may want to reduce the trunk opening height. To have more room to access the trunk, you can raise the trunk opening height.

Once adjusted, the trunk hatch will continue to open to the newly set height until changed.

1. Open the trunk hatch.
2. Adjust the trunk hatch to the desired height using the close button on the inner right side of the trunk hatch.



Use the close button marked with the associated symbol.

To lower the trunk hatch, move it manually to the preferred height, then press the close button to stop it. If you do not press the close button, the hatch will continue to lower until it closes.

To raise the trunk hatch, move it manually to the preferred height.

3. Press and hold the close button for a few seconds to set the new height.

> A chime will confirm that the new height is set.

A height adjustment is saved to the profile being used at that time.

6.3. Locking and unlocking

You have several options for locking and unlocking the vehicle, depending on what keys you use and which settings are enabled.

Locking and unlocking from a distance

Your vehicle can unlock and lock automatically when you approach or leave it with a recognized distance-capable key. You can enable or disable this behavior in settings.

You can use your Volvo Cars app to lock or unlock your vehicle. If you have set up a digital key on your device, you can also use the lock and unlock buttons in your device's wallet app.

Important

It is the driver's responsibility to ensure the vehicle is locked, even when automatic functions are enabled.

Vehicle thieves can use frequency jamming to interfere with key functions and prevent vehicles from locking. When you leave your vehicle, always check that the driver's door is locked.

Note

Digital key and distance capability

Make sure you enable Bluetooth on your device for your vehicle to be able to detect it from a distance.

If you're using a digital key on a device that doesn't have UWB^[1] capability, the key isn't distance-capable and can only be used as a key card.

Tip

Disable passive entry in wallet app

Many wallet apps have a setting that lets you disable passive entry. When this feature is disabled, your vehicle won't unlock automatically when you get close to it while carrying a digital key. The approach unlock feature will still be available when you use your other distance-capable keys.

Using the touch points on the door handles

If you want to lock or unlock your vehicle manually while still using a distance-capable key, you can use the touch points on the door handles.

To unlock the vehicle, touch the underside of the door handle.



Touch point on the underside of the door handle.

To lock the vehicle, place a finger on the small indentation on the door handle.

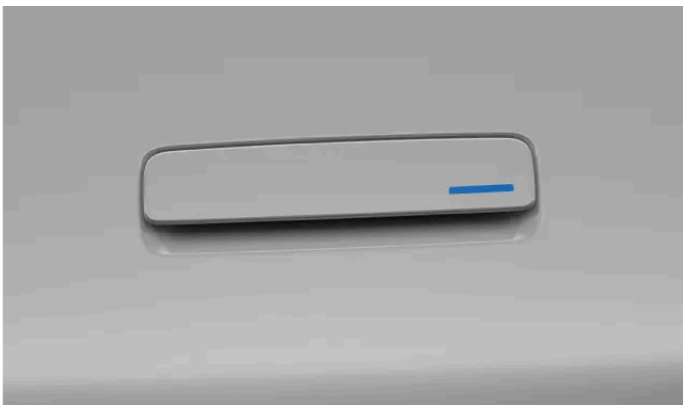

The indentation marks the touch point where you can place your thumb or fingers to lock your vehicle.

Note

For the touch points to work, you need to keep a recognized distance-capable key where your vehicle can detect it.

To prevent your vehicle from unlocking or locking automatically when you approach or leave it, be sure to disable **Unlock car when approaching** and **Lock car when leaving** in settings.

Using the key reader

You can lock or unlock your vehicle by putting any of your keys on the NFC^[2] reader on the driver's door handle.

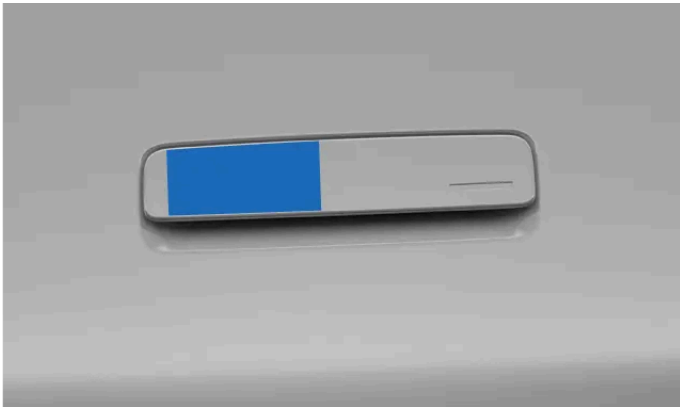

Key reading location on the driver's door handle

Make sure the card or device is laid flat against the reader. If you're using a key tag, the Volvo logo should be facing towards you. If you're using your digital key, open the key in the wallet app before placing your device on the reader.

Using the button panels

Direct controls for the door locks are located on the button panels on the inside of the front doors. The lock and unlock symbols are visible on the buttons.



Warning

Volvo recommends that you do not leave people or pets in a locked vehicle. The driver is always fully responsible for the well-being and safety of anyone left inside.

Some regions have laws prohibiting people or pets being left inside a locked vehicle.

^[1] Ultra-wideband

^[2] Near-Field Communication

6.3.1. Activating child lock

You can activate and deactivate the child lock in settings.



 **Important**

When driving with children in the rear seats, check that the rear doors are secured with an active child lock.

The child lock can increase passenger safety in the rear seats. When the child lock is active, passengers in the rear seats are unable to open the rear doors or operate the rear windows.

The driver maintains control over the windows, and the vehicle can be opened from the outside if it is unlocked.

Activating the child lock:

1. Press the vehicle symbol  in the bottom bar and go to **Settings**.
 2. Go to **Controls** → **Locking**.
 3. Press the child lock symbols   to activate the child lock.
- > A child lock symbol appears in the instrument panel to confirm that the lock is on.



Symbol shown in the instrument panel indicating that child lock is active.

You can deactivate the child lock by following the same steps you took to activate it. To deactivate the child lock, the vehicle needs to be stationary with the driver sitting in the driver's seat.

 **Note**

Double pull

Your vehicle is equipped with a double-pull safety feature on the doors. When the child lock is active, the double-pull feature doesn't work for the rear doors, since they can't be opened.

6.3.2. Settings for locking and unlocking

You can customize how your vehicle reacts when locking or unlocking.

 **Note**

Different settings affect how and when your vehicle is locked. Make sure to familiarize yourself with the different options and how they affect the locking and unlocking behaviors.

Approach and leave locking

You can choose whether your vehicle should automatically unlock when you approach it and lock when you're walking away from it with the **Unlock car when approaching** and **Lock car when leaving** settings. For these features to work, you need to carry a recognized distance-capable key.

General locking behavior

You can customize many of your vehicle's general locking behaviors. For example, you can turn feedback responses on or off and choose which doors unlock when you use the touch points on the driver's door handle.

It's also possible to set the vehicle to automatically lock while driving for improved occupant safety. Enabling this setting prevents the doors from being accidentally opened when moving at speed. It triggers at a relatively low driving speed.

 **Note**

Double pull

When **Auto lock while driving** is disabled, the rear door double pull feature only works when you lock the vehicle manually.

Occupant locking

Occupant locking is a feature designed for when you want to lock the vehicle from the outside but still have someone inside it. The occupants will still be able to open the vehicle from the inside and the alarm won't be armed. Use this feature responsibly.

 **Note**

Battery consumption

While occupant locking is enabled, some vehicle features remain active and consume power. This can drain the battery level faster than normal, even when your vehicle is parked.

Software updates

Your vehicle won't receive any over-the-air software updates while occupant locking is enabled. Keep this in mind if you plan to allow occupant locking for an extended period of time.

 **Warning**

Volvo recommends that you do not leave people or pets in a locked vehicle. By allowing occupant locking, it will be possible to lock the vehicle when it has detected people or pets inside. Certain vehicle systems can remain active, and the vehicle doors can still be opened from within. The driver remains responsible for the well-being and safety of anyone left inside.

6.3.2.1. Adjusting locking and unlocking settings

You can adjust several of your vehicle's locking and unlocking responses and behaviors in settings.

 **Important**

Changing locking and unlocking settings

Enabling or disabling certain features affects how and when your vehicle locks and unlocks. Make sure you familiarize yourself with the different key types, as well as the locking and unlocking features. Misunderstanding a feature might lead you to believe that your vehicle is locked when it isn't.

It is the driver's responsibility to ensure the vehicle is locked, even when automatic functions are enabled.

1. Press the vehicle symbol  in the bottom bar and go to **Settings**.
2. Go to **Controls** → **Locking**.
3. Adjust your locking and unlocking settings.

 **Warning**

Volvo recommends that you do not leave people or pets in a locked vehicle.

Some regions have laws prohibiting people or pets being left inside a locked vehicle.

6.3.3. Unresponsive lock

If your vehicle doesn't lock or unlock as expected, there are some steps you can try.

 **Note**

If the vehicle's batteries are drained down completely, it will not respond to any key.

If the vehicle has been turned off for a long time, it may take several seconds for it to unlock. This is because the vehicle needs time to turn its systems back on, to recognize the key and to give you access.

Locking not working

If the vehicle won't lock, check that all of the doors are properly closed.

If the hood or trunk are not properly closed when you lock the vehicle, it will only lock the closed doors. Once you close the hood or trunk, they will also be locked and covered by the alarm.

The content of this manual represents the status of the user manual at the time of printing and may not be completely valid in future instances. For more information refer to the first page for the complete disclaimer note.

 **Note**

Occupant detection

One reason why the vehicle won't lock may be that an occupant is detected in the vehicle. When this happens, a message appears in the center display.

Automatic locking not working

For the vehicle to automatically unlock when you approach and lock when you leave, make sure that:

- **Unlock car when approaching** and **Lock car when leaving** are enabled in settings.
- your distance-capable key is charged.
- the key's wireless signals are not being blocked.

If your vehicle doesn't respond when you approach it with your distance-capable key, you can try unlocking it by touching the underside of the door handle or placing your key on the driver door handle key reader.

Digital key not working

If you are using a digital key, you can also try:

- turning your device's Bluetooth off and on
- checking that any required access settings are selected
- making sure that your vehicle and device are updated to the latest software version
- restarting your device
- deleting and creating the digital key again.

Rear doors not unlocking

If the rear doors don't open when you pull the inner door handles, make sure the child lock isn't active and that you pull the handle twice. The first pull unlocks the door and the second pull opens it.

6.4. Anti-theft

Your vehicle has a number of systems and features which help to make your vehicle secure when it's locked.

When you lock the vehicle, some of its functions and systems are either shut down or activated to help protect the vehicle from theft. For example, the alarm is automatically armed.

 **Warning**

Do not leave your keys unattended in your vehicle. They can be used to disable the security systems.

Alarm

The alarm is automatically armed when you lock the vehicle and disarmed when you unlock it.

Gear shift lock

When the vehicle is locked, the gear shift is locked.

Immobilizer

The immobilizer is an anti-theft system that prevents your vehicle from being driven until it's started using a valid key. If your vehicle can't find the key or fails to authenticate it, it will remain immobilized. If the key can't be found or has a low battery, a notification appears in the center display. If your vehicle is unresponsive to a battery-powered key, try using a key card. If the vehicle appears to have no power, the cause could be discharged batteries or something affecting its electrical systems.

6.4.1. Alarm

The alarm helps deter unwanted interference with your vehicle when it's parked.

The alarm is enabled when you lock the vehicle and disabled when you unlock it.

Attempting to open a locked door triggers the alarm. The vehicle tells you when it is unlocked by folding out the door handles.

Note

Locking with hood or trunk open

If the hood or the trunk are not properly closed when you lock the vehicle, the alarm won't be fully enabled. In these cases, the alarm will only protect the side doors.

The vehicle also won't detect any motion inside if you've locked it with the hood or trunk still open.

Once you close the hood or trunk, it will lock and be covered by the alarm.

Alarm indicator

The alarm indicator is a red light located at the front center of the dashboard, just inside the windshield. The indicator confirms when the alarm is enabled with a flashing red light.

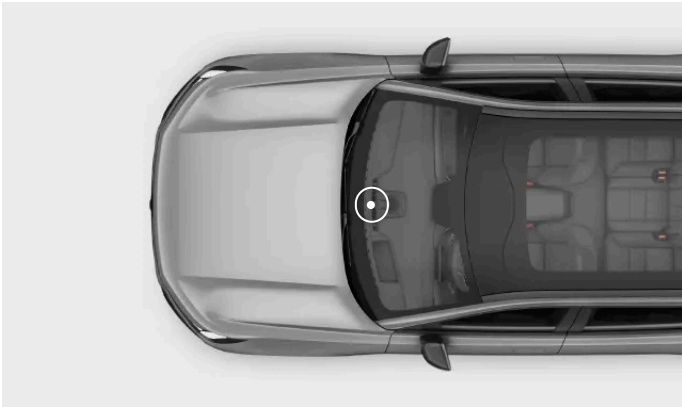

Triggering the alarm

The alarm triggers when an unauthorized attempt is made to open the hood, trunk or any door. Movement inside the vehicle can also trigger the alarm.

Once the alarm is triggered, the following happens:

- The alarm indicator and the warning lights flash for up to 5 minutes.
- The alarm sound starts.
- The alarm cycle restarts several times over if whatever triggered the alarm isn't resolved.

Note

To avoid any false alarms, the vehicle's alarm is disabled while over-the-air software updates are being installed.

Tip

Alarm sensitivity

The alarm sensitivity can be lowered in settings, which is especially useful if the vehicle is parked on a ferry where it can be affected by external motion or vibrations.

The alarm may also be triggered if you use a vehicle jack, connect a trailer or have the vehicle towed. In such cases, you should always activate reduced alarm sensitivity.

Stopping the alarm

Unlocking the vehicle while the alarm is triggered will stop any alarm sounds and lights. The alarm indicator will continue to flash rapidly for a few minutes to highlight that there was a recent potential security issue.

Important

Do not make any changes or additions to the alarm system, or it may not work properly.

6.4.1.1. Reducing alarm sensitivity

Reduce the alarm sensitivity when you expect significant movement in or around the vehicle when parked.

This setting is especially useful if the vehicle is parked where it can be affected by external motion, such as when traveling on a ferry.

 **Note**

Check the alarm indicator if you are unsure about how the vehicle is reacting.

1. Press the vehicle symbol  in the bottom bar and go to **Settings**.
2. Go to **Controls** → **Locking** → **Reduce alarm sensitivity**.
3. Turn reduced alarm sensitivity on or off.

Reduced alarm sensitivity resets to off at the start of a new driving session.

7. Charging your vehicle

Learn how charging works and how you can make each charging session more efficient.



In this section, you can find out more about the different charging types, charging settings, and how to start and stop charging. You can also read about other types of charging-specific information.

7.1. Charging types

Learn more about the different types of charging for your vehicle and how to initiate charging for each type.

 **Warning**

Charging components and high voltage

- The vehicle's charging components carry hazardous currents and voltages. They must be handled with care. Do not perform actions that are not clearly described in the user manual.
- Do not modify or make your own repairs to any charging components. Contact an authorized Volvo workshop for any required repairs or servicing.
- Installation and repairs of at-home charging equipment^[1] must be performed by a licensed electrician.
- Damage to the vehicle's high voltage components, including the traction battery, can cause overheating, fire and serious personal injury. If there is a risk of damage, such as after battery leakage, flooding, fire or a collision, do not use the vehicle. Contact an authorized Volvo workshop as soon as possible. If possible, leave the vehicle outdoors and away from people, buildings, property and other objects that could catch or spread fire.

If you have a pacemaker or similar device

Charging the vehicle may affect the function of an implanted pacemaker or other medical equipment. People with an implanted pacemaker are recommended to consult a doctor before charging the first time.

 **Note**

12 V battery charging

The vehicle keeps the 12 V battery charged as long as the high voltage battery has sufficient charge.

Condensation during charging

During charging, condensation from the cooling system can collect under the vehicle. This is perfectly normal and is caused by the traction battery cooling down.

AC charging at a charging station or from a charging point at home

AC charging points are available at a variety of charging locations, both public and private. An AC charging point can be installed at home and is the recommended source for regular charging.

AC charging with household outlet

You can charge your vehicle from a regular household outlet. This type of charging is only suitable for occasional charging and is not recommended for regular use. If you are planning to charge your vehicle from a household outlet, there are additional steps you need to take to ensure it is done safely.

 **Warning**

Do not use visibly worn or damaged electrical sockets as they could cause overheating, electric shock or personal injury.

 **Important**

- The vehicle must only be charged from approved, grounded household outlets.
- Do not exceed the maximum permitted charging current when charging via a regular household outlet. Limits imposed by local and national charging recommendations may apply.
- Ensure that the household outlet breaker can handle the charging cable's specified current before you start charging. If you are uncertain, the outlet must be checked by a qualified and licensed electrician.
- Never connect the charging cable when there is a risk of thunderstorm or lightning strike.

DC fast charging

DC fast charging is available at certain charging stations. These charging stations deliver very high power that allows for shorter charging times.

 **Note**

Voltage boost charging

When charging your vehicle at a DC charging station with an output voltage below 800 V or battery maximum voltage^[2], a voltage boost charging is automatically activated. It will convert the lower voltage from the charging station to the higher voltage required by your vehicle. This means you can still charge quickly even if the station doesn't support the battery maximum voltage. To enhance your DC charging experience, it is recommended that you charge your vehicle at a high-voltage-rated charging station.

 **Note**

Charging stations with support for fast charging are usually clearly marked CCS or Combo.

Charging cables

There are different charging cables to use when you charge your vehicle. Mode 3 cables are the standard cable to use when charging electric vehicles. There are different versions of the mode 2 cable available. Mode 2 cables can be used as an emergency solution, but it is not recommended to use them as a daily charging method.

^[1] Including any work on the electric meter housing or power distribution service panel.

^[2] Your vehicle's battery voltage can vary based on battery variant.

7.1.1. Charging cables

When using a charging cable for the first time, always check to make sure it's compatible with your vehicle.

Charging cable recommendations and use

 **Warning**

High voltage

The cable is connected to a hazardous electrical system. Contact with high voltage current can cause fatality or serious personal injury.

Damaged cables

Do not use a charging cable that shows any signs of damage or wear. This can cause an electric shock. A damaged or malfunctioning charging cable provided by Volvo may only be repaired at an authorized workshop. Contact an authorized Volvo workshop for more information. If you are charging at a charging station, try another cable or charging point.

Excessive wear and debris

Remember to always check the charging cable's connector and the charging port for excessive wear and debris, such as ice or gravel. Do not touch the charging cable connector or use any tools to attempt to remove debris from the charging cable. It can damage the charging cable's connector.

Public charging stations are in constant use and can be exposed to more wear and tear than a private charging station.

Cable placement

Remember to place the cable where there is minimal risk of it getting damaged or causing personal injury. A carelessly placed cable can easily get run over or tripped over.

Child safety

Keep children away from charging cables, especially when the cables are plugged in.

 **Important**

Adapters

Adapters approved by Volvo may be used for certain scenarios.

Liquids and cables

Do not submerge the charging cable or its components in liquid. If you need to clean the cable, use a clean cloth lightly dampened with water. If needed, use a mild detergent but never use chemicals or strong solvents.

Only use recommended cables

- Only use the cables originally provided with your vehicle.
- Volvo takes no responsibility for damage or injury caused by charging equipment not recommended by Volvo.

 **Note**

Recommended cables

Volvo recommends a charging cable according to SAE J1772 that supports temperature monitoring.

Charging cable instructions

Before using a charging cable, make sure to read the instructions from the cable's manufacturer.

Some charging stations have a permanently attached charging cable. Be sure to follow the charging station's instructions for use.

Mode 3 cable for charging stations

You can use this type of cable to charge your vehicle at AC charging stations.

Mode 2 charging cables

Use a charging cable with a household plug to charge the vehicle from an ordinary household outlet, such as when no other charging options are available.

 **Important**

Do not use this type of charging as a daily charging method.

7.2. Charging view and settings

In the charging view, you can access information about the charging process, start or stop charging, unlock the charging cable and set different charging settings. You can customize the charging settings according to your preferences. The charging view appears automatically when charging is initiated.

Note

The information content can vary depending on the current charging status.

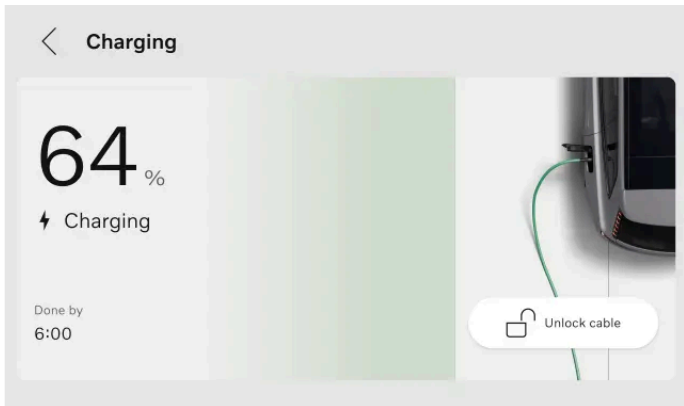

The following information, functions and settings are available in the center display:

- Current battery level
- Target battery level
- Amperage^[1]
- Charging status
- Set a target battery level
- Limit the electrical current for AC charging
- Add and manage schedules
- Set a minimum battery level
- Unlock the charging cable
- Activate Plug & Charge

Tip

You can also access information about battery level, charging status and the charging process in the Volvo Cars app.

You can also access the charging view through the settings in the center display.

^[1] Amperage is only shown if a limit was set.

7.2.1. Setting a target battery level for charging

You can set a target battery level by selecting a value in the charging view. This can help you to maintain good charging performance and battery longevity.

There are two preset options: **Daily drive** and **Long trip**. **Daily drive** is the recommended charging level which charges your vehicle up to 90%. **Long trip** charges your vehicle up to 100% and can be selected if you want the maximum range possible from your vehicle. You can also choose to customize the target battery level value by selecting **Custom**.

 **Tip**

You can also set a target battery level for charging from the Volvo Cars app.

1. Press the vehicle symbol  in the bottom bar and go to **Settings**.
 2. Go to **Charging** → **Target battery level**.
 3. Select your preferred battery level.
- > The target battery level value changes. The value is saved until you change it again.

7.2.2. Setting the amperage limit for charging

You can set an amperage limit for AC charging by selecting a value in the charging view.

Ampere, often written as "amp" or "A," is the unit for electric current.

An amperage limit can be set for a specific location. The amperage limit setting is automatically applied when you charge your vehicle in that location.

1. Press the vehicle symbol  in the bottom bar and go to **Settings**.
 2. Go to **Charging** → **Limit charging current**.
 3. Turn the function on.^[1]
 4. Adjust the amperage limit to your preferred value.
- > The amperage limit changes, and the value is saved until you change it again. When your vehicle is charging, the amperage limit is shown in the center display.

 **Note**

The amperage may be limited by the charging station, charging cable or the vehicle. There is no guarantee that the vehicle can be charged with the specified amperage if it is higher than what is permitted by the charging station or charging cable.

[1] Only available for AC charging.

7.2.3. Adding and managing charging schedules

You can set and activate a charging schedule for your vehicle in the charging view. This means you can specify when you want the vehicle to charge, such as when it is plugged in overnight.



Tip

You can also add a charging schedule from the Volvo Cars app.

You can decide to activate either a manual or a smart schedule.

A smart schedule decides when to charge based on different parameters, for example battery health, cheapest time and user preferences. [1] You only need to set a departure time and the system will try to meet your desired target battery level by the selected departure time. However, there are some external factors that can affect this, such as available power, type of charging cable at the charging station and the amount of time between plugging in the charging cable and the departure time. Make sure to plan accordingly and allow enough time for your vehicle to be able to charge as planned.

A charging schedule can be set for a specific location. When you arrive at that specific location, the charging schedule is automatically applied.

1. Press the vehicle symbol  in the bottom bar and go to **Settings**.
 2. Go to **Charging** and select either **Smart schedules** or **Manual schedules**.
 3. Press **Add** to add a charging schedule.
 4. If you added a smart schedule, select the departure time and press **Save**.
If you added a manual schedule, select start and stop times and press **Save**.
 5. Activate the schedule by turning it on.
- > The timer is active and the scheduled charging time is visible in the charging view.

You can also modify the schedule by adjusting the start and stop times or the departure time.

Deactivate the schedule by turning it off. The timer is not active and no scheduled charging is planned.

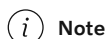

Note

You can also override a charging schedule and charge right away via the Volvo Cars app. This option is available if a charging schedule is active, your vehicle is in park and the charging cable is connected. [2]

[1] The options may vary depending on region.

[2] The options may vary depending on region and app version.

7.2.4. Setting a minimum battery level for charging

You can set a minimum battery level by selecting a value in the charging view. This ensures that your vehicle always charges to the minimum level, regardless of any other settings.

A minimum battery level can be set for a specific charging location. The battery level setting is automatically applied when you charge your vehicle in that location. If a charging schedule is active, charging pauses until the scheduled start time when the minimum battery level is reached.

1. Press the vehicle symbol  in the bottom bar and go to **Settings**.
 2. Go to **Charging** → **Minimum battery level**.
 3. Turn the function on.
 4. Adjust the minimum battery level to your preferred value.
- > The minimum battery level changes, and the value is saved until you change it again.

7.2.5. Plug & Charge

Plug & Charge is an authentication and billing system that simplifies your charging experience.

Plug & Charge is enabled by ISO 15118, the international standard for charging electric vehicle. When using Plug & Charge, you don't need to use additional cards, apps or manual authentication steps. Instead, you can just connect the charging cable to your vehicle, which automatically recognizes and authenticates your vehicle, allowing the charging process to start.

The number of charging stations that support Plug & Charge is limited, and not all types of charging might be supported. If the charging station doesn't support Plug & Charge, you need to authorize yourself at the charger.

There are other ways that can help you simplify your charging process. By using certain vehicle parameters, you can connect the information to different apps and charging providers. Your vehicle can then be automatically identified at the charging station, without any need for additional cards. However, the vehicle displays won't show any information or instructions for these methods.

7.2.5.1. Activating Plug & Charge

You can activate Plug & Charge in the charging view. This can simplify the charging process, from authentication to billing.

Note

Plug & Charge is included in the charging view but may not be available in your country. This is because e-mobility service providers^[1], charging stations and other infrastructure need to support Plug & Charge in your country before the feature can be used.

1. Press the vehicle symbol  in the bottom bar and go to **Settings**.
2. Go to **Charging** → **Advanced settings** → **Plug & Charge**.
3. Turn the function on.
4. Press **View more** to easily copy your vehicle's unique PCID^[2] number. Follow the instructions on how to activate Plug & Charge in the Volvo Cars app.

If you use a provider that isn't a Volvo partner, the process and instructions may vary depending on the e-mobility service provider.

5. Connect your vehicle at a public charging station.
- > The contract certificate is installed through the cable, and the authorization and payment are handled by the vehicle and the charging station. You can see the status in the instrument panel and the charge port during the installation. The charging session starts when the authorization is finished.

Note

If there are any faults related to Plug & Charge, try to reconnect the charging cable. If it still doesn't work, check the charging settings to see if there is a contract installed in your vehicle. If there is a contract, contact your e-mobility service provider to make sure that there are no issues with the contract. If there is no contract, follow the activation steps again. If the problem persists, try normal charging. Authorize yourself at the charger and follow the instructions in the charging station interface.



If Plug & Charge isn't working after a workshop visit, it could be because the contract certificate was removed from your vehicle. Follow the activation steps again.

Handling Plug & Charge contract certificates

 **Note**

Removing contract certificates

After the Plug & Charge contract certificates are created, they're stored in the vehicle and in an external server outside the vehicle. Remember to delete both certificates when ending or transferring vehicle ownership.

Your contract certificate in the vehicle can be deleted from the center display. Press the vehicle symbol  in the bottom bar and go to **Settings** → **Charging** → **Advanced settings** → **Plug & Charge** → **Charging account**. Then press the trash can symbol .

To delete your contract certificate in the external server, go to the Plug & Charge settings in the Volvo Cars app.^[3]

Factory resetting of your vehicle doesn't automatically delete the installed contract certificates. You still have to delete the contract certificate via the center display.

Adding a new contract certificate

To add a new contract certificate, make sure Plug & Charge is on and follow the activation steps again. The most recent contract certificate will always be installed. If you want to delete the account permanently, you also need to cancel the contract with your e-mobility service provider.

^[1] An e-mobility service provider, also known as an e-MSP, is a company or organization that offers services related to electric mobility.

^[2] Provisioning certificate ID

^[3] If you use a provider that isn't Volvo's partner, contact them as the process and instructions may vary.

7.3. Starting and stopping charging

You can charge your vehicle by using either AC^[1] charging or DC^[2] charging. How you start and stop the charging process depends on the type of charging you use.

AC charging is the recommended charging mode for everyday charging, as it maintains the condition of the battery over time. AC charging can be used if you are charging from a charging station, a charging point at home or a regular household outlet. DC charging is available at certain charging stations and charges your vehicle faster than AC charging. DC charging can be used when you need to recharge your battery quickly.

^[1] Alternating current

^[2] Direct current

7.3.1. Starting AC charging

AC charging can be done at certain charging stations, from a charging point at home or from a regular household outlet. The cable you need depends on the charging mode.

The content of this manual represents the status of the user manual at the time of printing and may not be completely valid in future instances. For more information refer to the first page for the complete disclaimer note.

To initiate charging, make sure:

- the vehicle is in park.
- the charging settings are set up according to your preferences.

If you are using a regular household outlet, also make sure it meets the safety requirements for charging.

 **Warning**

Do not connect any equipment other than the charging cable between the charging source and the vehicle's charging port.^[1] It can cause malfunction, damage or electric shock.

1. Connect the charging cable to the charging source. Some charging stations have a permanently attached charging cable that you connect to your vehicle.
2. Open the charging hatch by lightly pressing on its back edge.



3. Remove any protective cover from the cable connector.

 **Important**

To avoid damage to the vehicle, position the connector's protective cover so that it does not touch the vehicle.

4. Connect the cable to the charging port.
- > When the cable is fully inserted it locks into place. Charging starts within a few seconds.

You can see the charging status in the charging port and in the instrument panel.

Recommended action if charging does not start

First, disconnect the cable from the vehicle's charging port, then from the charging source. Wait a moment before reconnecting it. If the problem persists, contact an authorized Volvo workshop.

[1] This includes extension cords, outlet splitters and power strips , travel adapters, external timers, surge protectors, and similar devices.

7.3.2. Starting DC charging

DC charging is available at certain charging stations.

DC charging stations have permanently attached charging cables, so you don't need to use your own.

Warning

- Public charging stations are in constant use and can be exposed to more wear and tear than a private charging station. Remember to always check the charging cable connector for excessive wear or debris.
- Do not touch the charging cable connector or use any tools to attempt to remove debris from the charging cable. This can cause an electric shock.
- Do not use a charging cable that shows any signs of damage or wear. This can cause an electric shock. Try another cable or charging point at the charging station.
- Ensure that the charging cable connector connects all the way into the charging port. A worn connector may prevent a safe connection to your vehicle.

To initiate charging, make sure:

- the vehicle is in park.
- to check the charging station for any instructions before you begin.

1. Open the charging hatch by lightly pressing on its back edge.



2. Remove any covers from the port and cable connector.
 3. Use both hands to press the cable's connector all the way into the charging port. Make a habit of pushing the charging cable upwards for a couple of seconds after inserting it to ensure connection and locking.
- > The charging cable automatically locks in place after a few seconds.

The content of this manual represents the status of the user manual at the time of printing and may not be completely valid in future instances. For more information refer to the first page for the complete disclaimer note.

4. After confirming that the cable is locked in place, follow the charging station's instructions for charging authorization.
 - > Charging starts after an insulation test has been completed by the charging station. It can take a minute to complete.

You can see the charging status in the charging port and in the instrument panel.

7.3.3. Stopping AC charging

You can stop the charging process at any time.

 **Important**

Stop the charging session before attempting to unplug the cable from the vehicle charging port. If you do not, you may cause damage to the cable or to the system.

1. Stop charging by pressing the release button next to the charging socket.



- > Charging has stopped and the charging cable unlocks from the charging port.

2. Unplug the charging cable from the vehicle.

 **Note**

If the charging cable isn't unplugged within a short period of time, the cable locks again and charging resumes.

3. If available, reattach the protective cover on the cable connector.
4. Depending on the cable you have used:
 - Unplug the charging cable from the charging station.
 - Reattach the charging cable to the station's storage socket.
5. Close the charging hatch.

 **Tip**

You can also stop the charging process from the charging station or by pressing the **Unlock cable** button in the center display.

7.3.4. Stopping DC charging

You can stop the charging process at any time.

 **Important**

Stop the charging session before attempting to unplug the cable from the vehicle charging port. If you do not, you may cause damage to the cable or to the system.

1. Stop charging by pressing the release button next to the charging socket.



- > The charging is stopped and the charging cable handle unlocks. This may take a couple of seconds.
2. Unplug the charging cable from the vehicle.
 3. If available, reattach the protective cover on the cable connector.
 4. Reattach the charging port's protective cover and close the charging hatch.

 **Tip**

You can also stop the charging process from the charging station or by pressing the **Unlock cable** button in the center display.

7.3.5. Releasing the charging cable

If the charging cable doesn't automatically release after you have stopped charging, there are some steps you can try.

The charging cable usually releases automatically when you have stopped charging. However, if the charging cable is left in the charging port for a while after charging has stopped, the charging cable will automatically lock in again.^[1]

Make sure that the key is within range and that the vehicle is unlocked.

- Stop charging by pressing the release button next to the charging port or by pressing **Unlock cable** in the center display.
- If you're charging at a public charging station, follow the instructions in the charging station's interface to stop charging.

The content of this manual represents the status of the user manual at the time of printing and may not be completely valid in future instances. For more information refer to the first page for the complete disclaimer note.

- Carefully wiggle the charging cable.
- Lock and unlock the vehicle.
- Lock the vehicle and wait until the LED on the vehicle's charging port turns off. This can take some time. After that, unlock the vehicle and try to stop charging via the release button or via the center display again.

If the charging cable still doesn't release, stop charging via the charging station, charging point or household outlet in one of the following ways:

- Charging via a public charging station: Contact the charging station's customer service to get help with stopping the charging.
- Charging via a home charging point: Safely disconnect the power supply to your home charging point.
- Charging via a household outlet: Unplug the cable from the household outlet.

If the problem persists, contact an authorized Volvo workshop.

^[1] Applies to AC charging.

7.3.5.1. Using the emergency release handle for the charging cable

If the charging cable doesn't release from the vehicle after you have stopped charging, you can use the emergency release handle. Never use the emergency release handle when charging is in progress.

1. Open the trunk and the cargo hatch.
2. Locate the emergency release handle on the left side of the trunk.



3.

 **Warning**

Before using the emergency release handle, check the instrument panel or the charging port to make sure the charging process has stopped. The emergency release handle should not be used when charging is in progress.

Carefully pull the emergency release handle until you feel resistance.

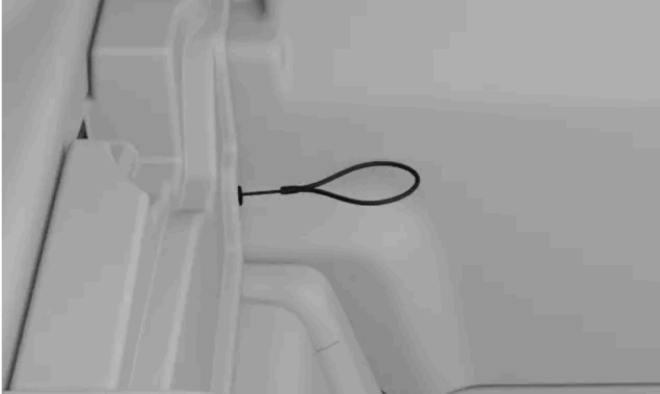

> The charging cable unlocks from the charging port.

 **Note**

The emergency release handle automatically retracts when the next charging cycle is started.

4. Wait for about 5 seconds before unplugging the charging cable from the vehicle.

5. Close the trunk.

If the problem persists, contact an authorized Volvo workshop.

7.4. Charging time and statuses

Learn more about charging times so that you have an idea of what to expect in different situations and what the different charging statuses mean.

7.4.1. Charging times

The time it takes to charge your vehicle depends on the charging type and several factors. The charging times mentioned are approximate.

Some examples of factors that can affect the charging time are:

- preconditioning

The content of this manual represents the status of the user manual at the time of printing and may not be completely valid in future instances. For more information refer to the first page for the complete disclaimer note.

- the vehicle's climate system and other active electrical loads
- ambient temperature
- battery temperature
- charging equipment
- battery size
- battery condition and vehicle condition
- infrastructure
- charging settings such as amperage limit.

AC charging from a household outlet^[1]

Current (A) ^[2]	Charging power (kW)	Charging time (hours) ^[3]
10	2.2	76
16	3.6	39
32	7.2	17
48	11	11

Fast charging from a DC charging station

Note

The charging times shown are based on rated power for compatible high-voltage charging stations. Actual charging power may be limited when using low voltage, for example 400 V DC charging stations.

Station power (kW) ^[4]	Charging time (minutes) ^[5]
50	92
150	32
300	24
350	22

Note

The battery can charge the fastest when the battery level is low. After reaching 30%, the maximum charging speed gradually decreases as the battery level increases.

Tip

When you use Google Maps to set a fast-charging station as your destination, the vehicle preconditions the battery to improve charging performance once you get there.

 **Note**

If data is missing, it will be updated at a later stage.

- [1] Using a 200-240 V socket.
- [2] Maximum charging current may vary depending on region.
- [3] From 0-100%
- [4] Maximum power that the charging station can supply
- [5] Applies at 10-80% state of charge provided that the temperature of the battery is approximately 35 °C (95 °F). Charging times will vary and are dependent on factors such as outside temperature, charging equipment, battery condition and vehicle condition.

7.4.1.1. Manually activating battery preconditioning

Before starting DC fast charging, you can activate battery preconditioning in the charging view. This can improve charging performance and efficiency, especially during cold conditions.

Activating battery preconditioning before DC charging means that the battery will reach the ideal temperature for maximum charging speed, leading to a reduced charging time.

 **Tip**

Battery preconditioning automatically activates when a DC fast charging station has been set as your destination in the navigation app.

1. Press the vehicle symbol  in the bottom bar and go to **Settings**.
 2. Go to **Charging**.
 3. Press **Precondition battery**.
 4. Press **Start**.
- > Battery preconditioning is active for approximately 30 minutes and then automatically deactivates. The remaining time and status of preconditioning are shown in the center display.

Press **Stop preconditioning** if you want to deactivate the preconditioning manually.

7.4.2. Charging status

The vehicle's charging status is shown using different colors, both in the charging port and in the displays.











- ① Charging status information in the instrument panel
- ② Charging status information in the charging port

The charging port light only indicates the current status of the charging cycle. If you would like more comprehensive information, you can find this in the instrument panel. You can also access the charging view in the center display for an even more detailed description.

7.4.2.1. Charging status in the charging port

You can see the vehicle's current charging status in the charging port.

Color	Color name	Description
	White, solid	The charging cable is attached and unlocked.
	White, pulsating	The charging cable is attached and the charging process is either initiating or waiting to start.
	Green, pulsating	Charging is in progress.
	Blue, solid	Charging is scheduled.
	White, pulsating fast	The status is visible while charging is being stopped.
	Green, solid	Charging is complete.
	Red, solid	Charging fault. Check the displays for additional information. Always make sure that the charging cable is correctly connected to the vehicle charging port and that the power source, such as the cable or the charging station, works correctly. If an error is indicated, try to disconnect the cable from the vehicle, then reconnect it and re-initiate charging to see if the problem is solved. If the problem persists, contact an authorized Volvo workshop.
	Red, pulsating	The status is visible if you have tried to unlock the charging cable without being authorized. Unlock the vehicle and try again.

7.4.2.2. Charging status in the instrument panel



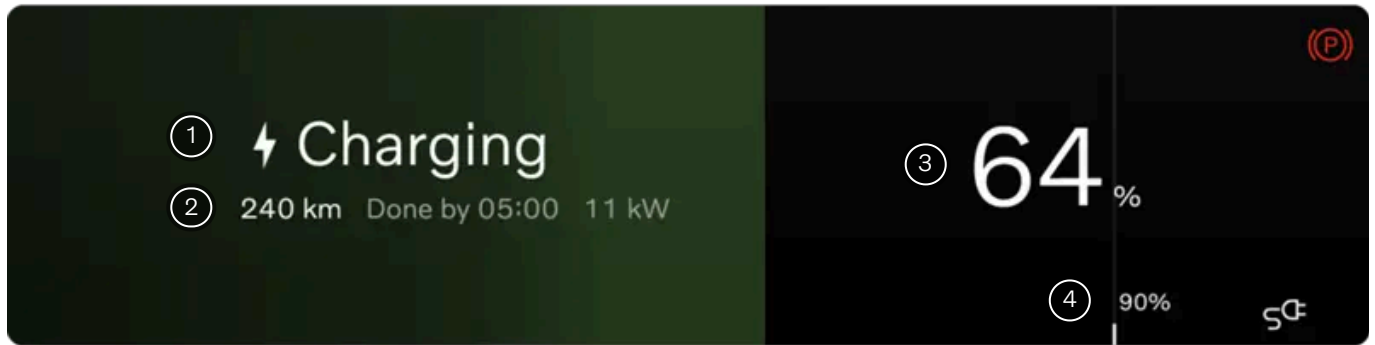



You can see the vehicle's current charging status in the instrument panel.







Information available in the instrument panel.

- ① Charging status information
- ② Current range and charging power
- ③ Battery level information
- ④ Target battery level

The instrument panel contains charging status information, such as status text, battery level, current range, charging power, remaining charging time and scheduled time information. Different colors of the progress bar are also visible. The information may vary depending on the charging status.

Status	Color	Color name	Description
Initializing		Silver, pulsating	The cable is plugged in and the vehicle is initializing the connection.
Authorizing		Silver, pulsating	The cable is plugged in and authorizing the payment method when Plug & Charge is enabled.
Charging		Green, pulsating	The vehicle is charging. If the vehicle is charging while a navigation route is active, the navigation symbol  is visible in the display. The symbol indicates the required battery level for the route.
Ready to go		Green, pulsating	The vehicle is charging and the battery level is sufficient to reach the next destination. The vehicle continues to charge until it reaches the target battery level.
Done		Green, solid	Charging is complete.
Charging to minimum level		Green, pulsating	The vehicle is charging to the minimum level while a schedule is active.

Status	Color	Color name	Description
Scheduled		Blue, solid	The cable is plugged in, and your vehicle is scheduled to charge at a later time. Information about the scheduled time is visible in the display.
Smart charging		Green, pulsating	The cable is plugged in and the vehicle is set to smart charging. The system is responsible for choosing when you charge.
Waiting		Silver, solid	The cable is plugged in but the vehicle is not charging. This can occur because the charging point is using its own scheduling or if something overheated.
Charging fault		Red, solid	The cable is plugged in but there is an error in the charging connection. Depending on the error, the display shows different messages. If the problem persists, contact an authorized Volvo workshop.

8. Driving

Your vehicle is designed for driving. This section covers the essential driver controls that allow you to start, stop, steer and change gears. You can also find information about driving characteristics and handling here.



Many of your vehicle's driving features can be customized for a personalized experience. While some features are more directed towards comfort, others are strictly safety related. It's important to check your driving position, maintain good visibility and to always stay attentive and focused while driving.

8.1. A typical driving cycle

This description provides an overview of your vehicle's capabilities and behavior in the different stages of a typical driving cycle.

A driving cycle starts when you unlock your vehicle and ends when your vehicle is powered down after driving.

The different situations and scenarios described here have their own sections in this manual with more detailed information.

Approaching and unlocking

Your vehicle unlocks differently depending on which type of key you use. When your vehicle unlocks, it also powers on.

Entering

When you enter your vehicle, it can automatically select your profile if you use a connected key. It adjusts the driver's space and applies your profile settings for features and vehicle behavior. Additional features can be accessed when you are seated and ready to drive, such as climate and comfort.

Beginning your drive

The type of key you are using affects how you start the vehicle. If you are using a key card or a discharged key, it needs to be placed on the card reader for you to be able to start driving. If your vehicle detects a distance-capable key, you just have to keep it inside of the vehicle.

To start driving, press the brake pedal and select a gear. Your vehicle can notify you of any open doors, unbuckled seat belts or other issues related to driving.

Tip

This manual contains information that might be useful, depending on what kind of trip you're about to go on. For example, you can find information about your vehicle's stowing capabilities or what you need to think about when driving in winter conditions.

Parking

Your vehicle will automatically apply the parking brake and enter a parked state when you leave the driver's seat. This is part of a gradual power-down as you get ready to leave the vehicle. If you want to remain in your vehicle after parking with the climate and media features still available, you can adjust your climate settings to remain active after parking.

You can also manually activate the parking brake by pressing the P button on the right-hand steering wheel stalk.

Powering down, locking and leaving

When you leave and lock your vehicle, it will gradually power down. This is done automatically and the vehicle will enter a stand-by state.

You can also manually turn your vehicle off via the center display.

Tip

If possible, charge your vehicle when you leave it for longer periods of time.

8.2. Trips app

The Trips app is a driving journal that automatically logs all trips made with your vehicle.

When this app is enabled, it automatically collects your vehicle's identification number^[1], location and other trip-related data, such as time, distance and battery consumption.

Note

The Trips app calculates battery consumption based on pure consumption during a trip. If you see a different value in your vehicle's trip meter, it's because the trip meter also takes energy regeneration into account.

In the Volvo Cars app, you can:

- View, manage and delete all of your trips.
- Export your driving journal.
- Stay informed if a trip isn't uploaded due to an issue, such as network problems.

When the Trips app is enabled, all users that have paired the Volvo Cars app with the vehicle can see the trips. If the Trips app is disabled, the vehicle stops sending information about new trips.

 **Note**

Vehicle location sharing

You need to enable vehicle location sharing in the display and in the Volvo Cars app to start logging your trips.

Storage limits

When a trip is logged, it can be stored in the Trips app for up to 400 days. The app has the capacity to store approximately 500 trips. When this limit is reached, older trips are automatically deleted to free up space and make room for new trips.

 **Note**

If the journal isn't logging trips, the reasons might include:

- Weak or no network connection.
- The app isn't receiving GPS coordinates.
- Location permissions are disabled so the Trips app can't access the vehicle's location.

[1] VIN

8.3. Starting the vehicle

Starting your vehicle requires a key to be present and used correctly, and you must press down on the brake pedal while starting and select a driving gear.



Your main interaction points for starting your vehicle are the brake pedal and the gear stalk.

Your vehicle unlocks differently depending on which type of key you are using. Once unlocked, your vehicle gradually powers on. Many features, such as the climate system, will be accessible once you enter your vehicle.

To start your vehicle, press down the brake pedal and select a driving gear. If you are using a key card or a discharged distance-capable key, you must first place it on the card reader.

Before you start driving, make sure that:

- All doors are closed.
- All occupants are properly seated and wearing their seat belts correctly.
- The driver seat, the steering wheel position and the mirrors are adjusted to your driving position.
- No charging cables are connected.
- The driver area is unobstructed and the pedals can move freely.

i Tip

The vehicle can alert you to certain conditions you should address before driving. If something is preventing you from starting the vehicle, have a look in the instrument panel for guidance.

1. If you are using a distance-capable key, make sure to keep it with you.

If you are using a key card or a discharged distance-capable key, place it on the card reader.



The location of the key card reader used to start the vehicle with a key card or a discharged distance-capable key.

2. Press and the brake pedal and hold it down.
 3. Select D or R using the right-hand steering wheel stalk.
- > The selected gear is indicated in the instrument panel. The ready symbol also appears, emphasizing the transition from parked to a driving gear.

READY

***i* Note**

The ready symbol disappears when the vehicle's speed exceeds a walking pace.

8.3.1. Startup checks

When you select a gear to start driving, the vehicle performs a number of self-checks of important systems and functions. This short test is indicated on the instrument panel.

The startup check is indicated by several warning and indicator symbols in the instrument panel. If any of the warning or indicator symbols remain visible after a few seconds, it tells you that there's a fault or condition you need to address before driving.

If a fault is indicated:

- Read any related information presented on the instrument panel.
- For additional information about warning and indicator symbols, consult that section of the manual.
- Resolve the indicated fault before driving.
- If you cannot resolve the issue yourself, do not hesitate to contact an authorized Volvo workshop.

After performing the startup check, the vehicle continues to actively monitor many of its systems and functions.

8.4. Turning the vehicle off

The vehicle typically powers down automatically, but you can also manually turn it off in the center display.

Your vehicle keeps track of certain actions after parking, such as people unbuckling seat belts and opening their doors to get out. This allows the vehicle to automatically turn itself off after you lock and leave it. However, in some situations, you may want to manually turn it off.

Note

In some situations, the automatic power-down, including locking, can be interrupted or prevented. This can happen if a door is not fully closed, a key is left in the vehicle or movement is detected in the vehicle.

Turning the vehicle off manually

1. Press the vehicle symbol  in the bottom bar and go to **Settings**.
2. Go to **Controls** → **Car modes** → **Power options**.
 - > The **Power options** menu is shown.
3. Select one of the power options.
 - > The vehicle powers down to the selected level.

If you power your vehicle down and remain seated in the driver's seat, you can press the brake pedal to start your vehicle again.

Note

After being turned off, a number of essential systems remain available, such as key detection, alarm, internet connectivity and battery monitoring. Under normal conditions, they only use a small amount of power.

8.5. Driving characteristics

Explore the features that affect driving performance and dynamics. This allows you to customize your driving experience.



Your vehicle has several features that affect your vehicle's driving dynamics and performance.

- One Pedal Drive** This allows you to both brake and accelerate using only the accelerator pedal. The function can be turned on or off and adjusted in the center display.
- Automatic creeping** This allows you to drive at very low speeds without holding down the accelerator. You can enable or disable automatic creeping in settings.
- Drive modes** You can configure the vehicle for daily driving or set a drive mode to suit your driving situation. Depending on which drive mode you select, certain driving dynamics may be affected, such as steering, suspension, braking, and acceleration.
- Steering feel** Adjusting the steering feel affects the steering wheel resistance and firmness.
- Suspension feel** The suspension feel affects ride quality and can be adjusted in the center display.
- Electronic stability control^[1]** Your vehicle has automatic stability control systems in place that can help to prevent skidding.

i Tip

Exterior sound

Your vehicle plays an artificial driving sound when you are driving at low speeds. This is to alert others of your presence.

^[1] ESC

8.5.1. Drive modes

The drive modes change the driving dynamics of your vehicle and which settings are available.

The drive modes available in your vehicle are all suitable for different scenarios and types of driving. Depending on which drive mode you select, certain driving dynamics may be affected, such as steering, suspension, braking, and acceleration. Your

vehicle's estimated range is also affected. Each drive mode allows for different adjustable settings related to both driving and climate.

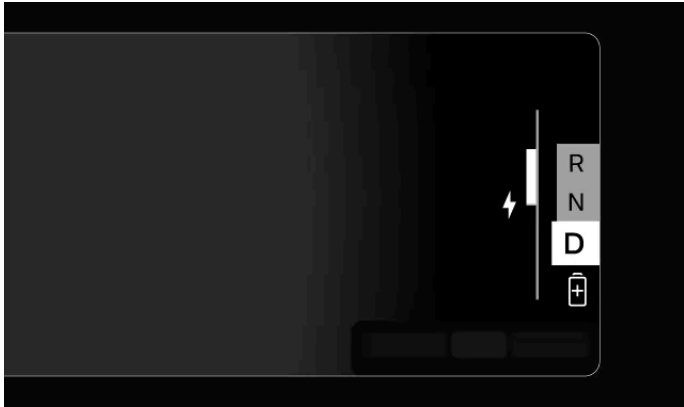

Your selected drive mode is shown below the gear in the instrument panel^[1].

You can select these drive modes:

- Standard** This is the default mode and is recommended for everyday use.
- Range** This mode limits climate and driving performance to maximize range.
- Performance** Your vehicle will prioritize performance, allowing for quicker acceleration and an enhanced road handling experience. This mode decreases your expected range.
- Off-road** The off-road mode is suitable for when you're driving on roads with limited accessibility or rough terrain. You can also use off-road mode when you're driving on loose surfaces such as deep snow or sand. Your vehicle's suspension is raised, giving it a higher ground clearance. The off-road mode also activates hill descent control, allowing your vehicle to brake in a more controlled and active way when driving downhill.

Note

Default drive mode

If the vehicle is in range mode when you turn it off, range will be selected the next time you start the vehicle. If you are using another mode, standard mode will be selected by default.

Off-road limitations

The off-road mode has limitations and is only available below certain driving speeds. Hill descent control is available until you reach 40 km/h (25 mph). Driving at higher speeds automatically disables the off-road mode in full. If this happens while driving on a steep downhill gradient, the automatic braking effect from hill descent control will gradually decrease.

Driving with the suspension raised is only available at speeds below 25 km/h (15 mph). If you exceed this speed, your vehicle's suspension automatically returns to its previous height.

When Pilot Assist is activated, the off-road mode can't be selected.

The off-road mode is not designed to be used on public roads.

^[1] The standard mode is not indicated in the instrument panel

8.5.1.1. Selecting a drive mode

You can select a drive mode in settings.

Your vehicle is equipped with several drive modes suited for different driving conditions and situations. Selecting a drive mode adjusts the driving characteristics and dynamics of your vehicle, which might disable certain settings. You can select a drive mode in settings.

1. Press the vehicle symbol  in the bottom bar and go to **Settings**.
 2. Go to **Driving** → **Driving dynamics** → **Drive modes**.
 3. Select a drive mode.
- > Your vehicle's driving characteristics and dynamics are adjusted depending on your selected drive mode.

 **Note**

Default drive mode

If the vehicle is in range mode when you turn it off, range will be selected the next time you start the vehicle. If you are using another mode, standard mode will be selected by default.

8.5.2. One Pedal Drive

You control both braking and acceleration with the accelerator pedal when One Pedal Drive is active.



Braking behavior changes through the use of the accelerator pedal. When you press the accelerator, the vehicle accelerates normally, but releasing the pedal engages braking. The more you ease up on the pedal, the more braking action you get. By releas-

ing the accelerator completely, you will eventually bring your vehicle to a full stop.

You can turn One Pedal Drive on or off in settings. You can also select the **Auto** setting which enables One Pedal Drive but only allows you to brake by releasing the accelerator when you are close to a vehicle in front of you.

Regenerative braking is prioritized by One Pedal Drive. However, the disc brakes can be applied if the braking action demands it.

Using the One Pedal Drive auto setting

When the **Auto** setting is selected, you can only brake using One Pedal Drive when there is a vehicle detected in front of you. This means that if the road ahead is clear, releasing the accelerator pedal does not brake the vehicle. This can make driving in light traffic for a longer time more comfortable, as you won't have to apply constant pressure on the accelerator. However, this also means that you must be ready to use the brake pedal in situations where you have to brake without a vehicle right in front of you. These situations may include, but are not limited to, stopping at a stop sign, traffic light or intersection, or when driving through a roundabout.

Important

Radar and camera detection conditions

When **Auto** is selected, One Pedal Drive uses the vehicle's camera and radar units, which have some general limitations. The detection system cannot handle all driving, traffic, weather or road conditions. Read the separate manual sections about detection types, how they work and their limitations to better understand how the **Auto** setting's performance can be affected.

Keep the brake pedal in mind

There is a limit to the braking force that can be applied by releasing the accelerator when using One Pedal Drive. For hard braking, you need to use the brake pedal.

You can only use One Pedal Drive after selecting a driving gear, D or R. When N is selected, no braking force will be applied when you ease up on the accelerator, even if One Pedal Drive is enabled in settings.

Slippery road conditions

Using One Pedal Drive is not recommended when road conditions are slippery.

Off-road

One Pedal Drive is unavailable when the off-road feature is activated.

8.5.2.1. Adjusting One Pedal Drive

You can adjust how much braking force One Pedal Drive applies when you release the accelerator.

The available settings are:

- Auto** Releasing the accelerator only applies braking force when you're close to a vehicle in front of you.
- High** When you ease up on the accelerator, the vehicle will apply braking force until it comes to a standstill.
- Low** When you ease up on the accelerator, the vehicle will apply less braking force than in the high setting.
- Off** Releasing the accelerator doesn't engage the brakes.

The content of this manual represents the status of the user manual at the time of printing and may not be completely valid in future instances. For more information refer to the first page for the complete disclaimer note.



Tip

Quick access

A button for adjusting One Pedal Drive is also available in quick controls in the center display when you drive. This allows you to quickly adjust One Pedal Drive without going into settings.

Automatic creeping

By turning One Pedal Drive off, you also enable automatic creeping. This means that your vehicle can move slowly without you using the accelerator.

When automatic creeping is active, you can temporarily pause it by pressing down hard on the brake pedal until your vehicle is stopped. This activates the hold feature. If you want to initiate creeping again, simply tap the accelerator.



Warning

There is a limit to the braking force that can be applied by releasing the accelerator when using One Pedal Drive. For hard braking, you need to use the brake pedal.

1. Press the vehicle symbol  in the bottom bar and go to **Settings**.
2. Go to **Driving** → **Driving dynamics** → **One pedal drive**.
3. Select a One Pedal Drive setting.

8.5.3. Stability control

Your vehicle has stability control systems in place that can help to prevent skidding.

Electronic stability control

Electronic stability control^[1] consists of several sub-features that can apply your vehicle's brakes automatically to prevent skidding when the vehicle detects a loss of traction or steering control. To do so, ESC applies the brakes to each wheel individually. When this intervention happens, the symbol for ESC flashes in the instrument panel.



Your vehicle's stability control includes several other features, such as:

Anti-lock braking system^[2]

The vehicle's anti-lock braking system prevents the brakes from locking up during hard braking. This improves braking performance and maneuverability and helps to stabilize the vehicle.

Trailer stability assist

This is part of the ESC and can intervene if fishtailing is detected when you are towing a trailer.

The content of this manual represents the status of the user manual at the time of printing and may not be completely valid in future instances. For more information refer to the first page for the complete disclaimer note.

Traction control^[3]

TCS is a safety feature designed to detect when the wheels lose traction or slip. The feature will then help the wheels regain traction by applying braking measures.

Regeneration stability control

Helps with preventing wheel locking when regenerative braking is applied.

[1] ESC

[2] ABS

[3] TCS

8.5.4. Suspension

Your vehicle's suspension is designed to create a pleasant driving experience.

Your vehicle's suspension affects the comfort and handling of your drive. Some of the suspension features can be customized in the center display, while others are automatic.

Suspension feel

You can change how stiff or soft your road contact is by adjusting the suspension feel in settings. Different suspension settings are suited for different driving situations and scenarios.

 **Important**

The suspension can only be adjusted via the center display. The physical suspension system should only ever be handled by a trained technician.

 **Note**

Speed-dependent suspension feel

Your vehicle will automatically adjust the suspension firmness depending on your speed. This is separate from the adjustable suspension feel setting and allows you to maintain good road handling while driving at different speeds.

Suspension height

You can raise the suspension to increase your vehicle's ground clearance by activating the off-road feature. This is done in settings in the center display.

 **Note**

Speed-dependent height

Your vehicle will automatically adjust the driving height depending on your speed. This is separate from the off-road setting and allows you to maintain good road handling while driving.

 **Warning**

The shock absorbers are gas pressurized. Do not heat or open the shock absorbers.

8.5.4.1. Adjusting suspension feel

You can change the suspension feel in settings.

Suspension affects both comfort and handling. By changing the suspension feel you affect the compression and rebound characteristics of your vehicle's suspension.

 **Important**

The suspension can only be adjusted via the center display. The physical suspension system should only ever be handled by a trained technician.

1. Press the vehicle symbol  in the bottom bar and go to **Settings**.
2. Go to **Driving** → **Driving dynamics** → **Suspension feel**.
3. Select a suspension feel setting.

8.6. Range

Your vehicle's expected range is shown in the instrument panel and depends on several factors.

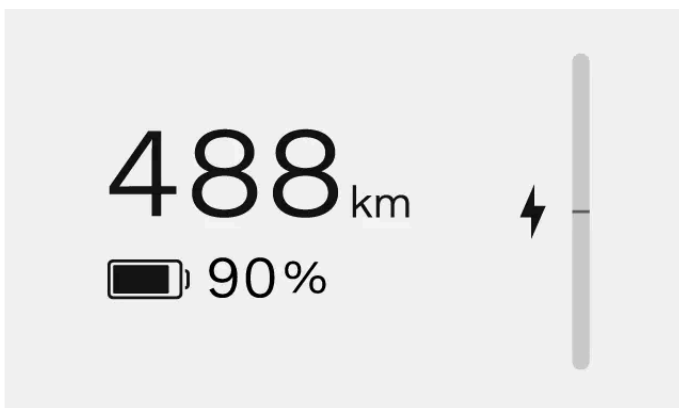

Your range is primarily related to your vehicle's battery level and your driving practices, but external conditions can also be a factor. The battery level and expected range are displayed in the instrument panel. The expected range is calculated based on your

driving pattern, both current and historical.

Factors that affect your vehicle's range

How you drive your vehicle, which settings or features are activated, weather conditions and traffic can all affect your vehicle's range in different ways.

Speed	Driving at higher speeds drains the battery more.
City driving and traffic situation	Varying your speed through frequent acceleration and braking will increase your battery consumption compared to keeping a constant speed.
Eco driving	Keep track of your driving with help of the range assistant to drive as economically as possible.
Outside temperature	The outside temperature can affect your battery consumption and range.
Battery temperature	A cold battery is less efficient and needs more energy to be heated.
Preconditioning	By preconditioning your vehicle, you can decrease the energy used to heat up both the vehicle and the battery. This can be done in the climate settings.
Climate settings	Which climate features are activated and to what extent affects your battery consumption.
Tires and tire pressure	Tire condition and tire pressure can affect your range.
Road condition and topography	The condition of the road, along with any potential slopes, can affect your vehicle's battery consumption.
Towing	Towing a trailer demands more power from your vehicle and will therefore adversely affect battery consumption. This is relative to the type of trailer being towed.

If you want to know more about your vehicle's range and how you can affect it, you can have a look in the range and trip app, which is accessed in the app library .

Range in cold temperatures

Cold temperatures can negatively affect your vehicle's battery. When the vehicle has a cold battery, a snowflake ❄️ appears next to the battery percentage. This indicates that the battery's charge capacity, performance and range are reduced compared to normal conditions. You can avoid this by always charging your vehicle while it's parked, which can prove especially useful if you are parking in a cold climate.

When the battery warms up – for example, while preconditioning the vehicle or when driving – the snowflake disappears from the instrument panel.

Factory reset and range value

After a factory reset or when the vehicle is delivered from the factory, the estimated range is based on a certified value. After driving your vehicle for a while, the estimated range is instead based on your historical driving patterns.

8.6.1. Range and trip

The range and trip app provides you with an overview of your range and energy consumption. This can help you drive more efficiently.

You can access information about your energy consumption in the range and trip app, which is accessed in the app library .

By viewing the different tabs, **Range assistant** and **Trip information**, you can get access to different aspects of your energy consumption and range.

Range assistant



You can view your current range and energy consumption in the **Range assistant** tab. Your consumption is displayed differently depending on the situation. When you are in motion it is based on distance, and when you are stationary it is based on time. The value always reflects your current consumption rate and therefore increases during actions such as fast acceleration or up-hill driving.

Your speed, climate settings and driving style all affect how much range you get. This means it might be a good idea to keep track of your energy consumption based on these three factors in order to maintain economical driving.

- Speed** Your average speed during the last minute.
- Driving style** Your acceleration and braking behavior over the last few minutes.
- Climate** The expected average energy consumption based on your current climate settings.

The estimated range is calculated on your driving style and current driving conditions. In addition to this, the calculated maximum and minimum range values are shown next to the estimated range value. These indicate your potential range, based on higher or lower consumption.

- Maximum range** Calculation based on typical city driving with the climate system turned off.
- Minimum range** Calculation based on high-speed driving with the climate system turned on.

Range optimizer

You can activate the range optimizer in the **Range assistant** tab. The range optimizer sets up the vehicle to help you maximize its range by lowering energy consumption. When it is active, it switches to eco climate setting and adjusts power delivery to prioritize range over power.

Trip information



Trip information provides an overview of your recent and current energy consumption over distance. This is also where you can reset your trip meter.

You can look at and monitor your trip information in different ways:

- Since last reset** This distance can only be reset manually. It allows you to define the start and stop time for the measured trip distance. Just remember to reset it at the start of the trip you want to keep track of and check the driven distance when you're done.
- Since last charge** This distance resets automatically when you charge the vehicle.
- Current trip** This distance resets automatically and reflects how far you've driven on your current drive.

You can open a more detailed view by pressing each of the different trip options.

8.6.1.1. Resetting the trip meter

You can reset your vehicle's trip meter. This is done in the range and trip app.

The trip meter can show you information of your current trip, since your last charge or since your last reset.

1. Press the app library symbol  in the bottom bar and open the **Range and trip** app.
2. Go to **Trip information** → **Since last reset** → **Reset**.
3. Reset the trip meter.

8.7. Steering

Get familiar with your vehicle's steering-related functions.



Your vehicle has been designed to provide a responsive and intuitive steering experience. Be sure to adjust your driving posture and select your preferred steering feel before driving.



Tip

Steering and driver support interactions

Several of your vehicle's driver support features can affect steering. Read the manual sections about these features for a more complete understanding of how they may interact with and affect your steering experience.

Speed-dependent steering response

Steering resistance and firmness change with the speed of the vehicle. At low speeds, steering resistance is low for precision maneuvering. At high speeds, the steering adapts to be firmer.

Steering feel





You can adjust the steering feel via the settings in the center display. Steering feel affects the firmness of the steering wheel's turning.

Steering-related faults

If you notice that your steering wheel is abnormally stiff or if steering-related features^[1] are not available or working properly, it may be due to a fault related to the steering system.

If your vehicle notices a steering-related fault, it will notify you with a message in one or both of the displays. Be sure to read and follow the instructions in the message.

The instructions in the message depend on the nature and severity of the detected fault. The level of urgency is critical to how fast you need to act and can be communicated by the message and through the use of symbols.

	Steering assistance temporarily reduced	Take caution. Follow the instructions in the message. ^[2]
	Steering fault	Take caution. Follow the instructions in the message. ^[2]
	Steering fault	Immediate action required. Follow the instructions in the message with urgency and caution. Book a service as soon as possible.
	Stop safely	Immediate action required. Stop the vehicle safely and call for assistance.

Important

Steering-related driver support features are not available if a fault is detected.

^[1] Such as lane keeping aid or Pilot Assist

^[2] If the problem persists, contact an authorized Volvo workshop.

8.7.1. Steering wheel

Get to know the steering wheel and some of its controls and features.

You can use your steering wheel for more than just steering the vehicle.



Heated steering wheel

The steering wheel has built-in heating. The function can be turned on manually or set to automatic activation.

Adjust the steering wheel position

The steering wheel can be electronically adjusted to suit your driving posture. This is done in the center display.

Steering wheel touch buttons

There are touch buttons on the steering wheel that can control certain settings and adjustments.

Horn

The horn button is located in the middle of the steering, indicated with the horn symbol .

8.7.1.1. Steering wheel controls

The steering wheel has several buttons and control surfaces. They control specific functions, such as the horn, as well as certain settings, adjustments and what's shown in the instrument panel.



- Horn
- Touch-sensitive buttons
- Left-hand stalk
- Right-hand stalk

Touch-sensitive buttons



- ⏩ Increase set speed
- Decrease set speed
- 🔄 Alternate steering assist

- ☰ Switch between instrument panel views
- 🗣 Voice control
- 🔊 Increase volume or confirm
- 🔇 Decrease volume or decline
- ⏮ Media: Previous or rewind
- ⏭ Media: Next or fast-forward
- 🔄 These buttons currently have no use^[1].
- 🔄 These buttons currently have no use^[1].

The buttons' functions change depending on the context and they typically control what's currently shown in the displays.

Interacting with the touch-sensitive buttons

The buttons on the right-hand side of the steering wheel often control what you see on the right-hand side of the instrument panel. The buttons on the left-hand side often control what you see on the left-hand side. The instrument panel typically shows which action each button corresponds to.

You can find the touch button zone you're looking for by moving your finger across the buttons. The displays react and shows you the button's assigned behavior or action. When the function you want is indicated, press the button.

^[1] Buttons for a potential future function.

8.7.1.2. Adjusting the steering wheel position

You can adjust the steering wheel position to suit your driving posture. The steering wheel position you choose is stored as part of your user profile.

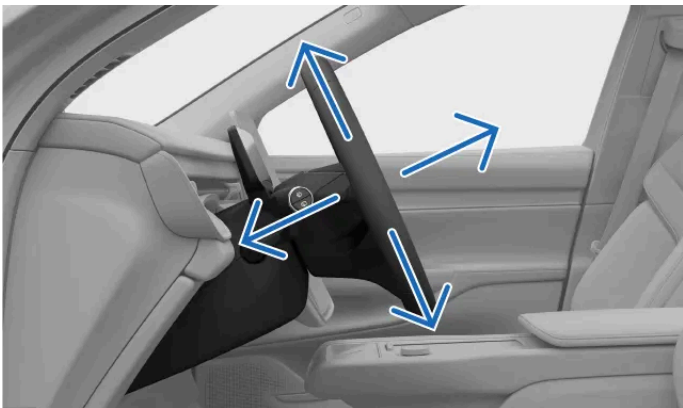

Adjusting the steering wheel position is fundamental to your driving posture, offering you better comfort and control of the vehicle.

The steering wheel adjustment view is accessed via the center display. It guides you through the available settings to move the steering wheel to your preferred position.



Tip

Quick access

You can open the adjustments view using the seat adjustment knob on the side of your seat. There, you can make several adjustments related to your driving posture. You can also access certain driver adjustments in the quick controls view in the center display. This allows you to make adjustments via the display without heading into settings.



Warning

Make sure that you adjust your steering wheel position when you are parked, as this should not be done while driving.



Important

Clear space around the instrument panel

Do not hang or place any objects on the steering column in front of or behind the instrument panel. You risk damaging the instrument panel if an object is placed there when the steering wheel position changes.

1. Press the vehicle symbol  in the bottom bar and go to **Settings**.
 2. Go to **Controls** → **Steering wheel** → **Adjust steering wheel**.
- > The view for steering wheel adjustments appears.
3. Adjust the steering wheel position using the steering wheel buttons.



Important

Once you've finished adjusting the steering wheel position to your liking, it's important to make sure other parts of the vehicle are aligned correctly. Your driving posture is important and is affected by more than the steering wheel adjustments, such as the position of your seat and mirrors.

8.7.2. Adjusting steering feel

You can adjust the steering wheel resistance and driving feel via settings.

A range of predefined settings are available to control the steering feel. These options are selected in the center display.

Note

Your vehicle has speed-dependent steering wheel resistance, in addition to the manually adjusted steering feel. This means that your vehicle automatically adjusts the steering wheel resistance in line with your driving speed, giving you enhanced control and stability.

1. Press the vehicle symbol  in the bottom bar and go to **Settings**.
2. Go to **Driving** → **Driving dynamics** → **Steering feel**.
3. Select a steering feel setting.

8.8. Brakes

Your vehicle has several types of braking functions, both manual and automatic.



Your vehicle has several features and capabilities when it comes to braking.

Foot brake	Your main way of braking manually. Pressing the brake pedal may activate regenerative braking or engage the friction brakes, depending on the driving conditions.
One Pedal Drive	When One Pedal Drive is active, you control both braking and acceleration with the accelerator pedal.
Regenerative braking	Slows the vehicle down by using the vehicle's movement to charge the battery. ^[1]
Friction brakes	Slows the vehicle down by engaging the disc brakes.
Parking brake	Keeps the vehicle in place while parked.
Auto hold	Automatically applies the brake to hold the vehicle when coming to a stop.
Automatic braking	This is a general term for the vehicle's braking interventions. Several driver support and safety systems can intervene and perform braking maneuvers for safety reasons or convenience.
Post-impact braking	Automatic braking after severe collisions to avoid further hazards.

The content of this manual represents the status of the user manual at the time of printing and may not be completely valid in future instances. For more information refer to the first page for the complete disclaimer note.

Electronic stability control^[2]

Helps prevent skidding and other stability-related issues by automatically applying the brakes.

Anti-lock braking system^[3]

Prevents the brakes from locking up during hard braking. This improves the braking performance, stability and maneuverability of the vehicle.

 **Important**

Brake wear indicators

Your vehicle is equipped with electrical brake pad wear indicators that monitor the condition of the brake pads. When the brake pad thickness wears below the safe limit, the brake wear warning symbol appears in the instrument panel.

If the brake wear warning symbol appears, contact an authorized Volvo workshop to have the brake pads inspected and, if necessary, replaced. Driving with worn brake pads can compromise safety and damage the brake discs.

 **Note**

Brake lights

Your vehicle's brake lights automatically light up during braking maneuvers. The lights respond to manual braking from the brake pedal and One Pedal Drive, as well as automatic braking from any driver support system.

Emergency brake lights

During hard braking maneuvers, or if the ABS system is activated, the emergency brake lights will activate. This causes additional brake lights to light up to alert vehicles behind you.

^[1] Converts kinetic energy to electricity

^[2] ESC

^[3] ABS

8.8.1. Foot brake

The foot brake engages different types of braking mechanisms, depending on the situation.



The foot brake engages either regenerative braking or the friction brakes, depending on how hard you press the pedal. Light braking activates regenerative braking, whereas harder braking engages the friction brakes.

Electronically controlled braking ^[1]

The foot brake is electronically controlled. As the braking force is transmitted electronically rather than physically, there are no natural reaction forces traveling from the brakes to the pedal.

Anti-lock braking system ^[2]

The vehicle's anti-lock braking system prevents the brakes from locking up during hard braking. This improves braking performance and maneuverability and helps to stabilize the vehicle.

Note

P button

At high speeds, pressing and holding the P button slows the vehicle down at a steady rate. This provides a backup alternative to braking normally. Only use the P button in this way if you are unable to brake using the brake pedal.

Startup checks

Several brake systems are part of the vehicle's startup check. Make sure to resolve any indicated brake faults before driving.



Warning

Wet brakes

The vehicle's stopping distance may be longer if the brake discs are wet. If they have been exposed to water, safely perform a braking maneuver to remove water from the brakes. Engaging the disc brakes while driving heats up and dries them.

^[1] Also called brake-by-wire.

^[2] ABS

8.8.2. Parking brake

The parking brake engages when you transition from a driving gear to the vehicle's parked state.

The parking brake locks the vehicle's rear wheels. When parked, the vehicle monitors and automatically tightens the grip if necessary.

By pressing the stalk button marked P, you put the vehicle in park and the parking brake is engaged.^[1]

Your vehicle will automatically engage the parking brake in several situations. These include:

- Your vehicle has been stationary in auto hold for an extended period of time.
- You leave your vehicle.
- A charging cable is connected to your vehicle.
- At the end of an assisted parking maneuver.

The instrument panel indicates when the vehicle is in park and the parking brake is engaged.



Warning

Avoid parking on a slope in winter conditions. The tires might lose traction, even if the parking brake is engaged. You are always responsible for safe parking. Check the parking brake warning symbol for the parking brake status.

PARK

Automatic release

The parking brake releases automatically when you select a driving gear.

Note

P button

At high speeds, pressing and holding the P button slows the vehicle down at a steady rate. This provides a backup alternative to braking normally. Only use the P button in this way if you are unable to brake using the brake pedal.

[1] The vehicle needs to be stationary to be put in park.

8.8.2.1. Engaging the parking brake

Engage the parking brake by pressing the button marked P on the right-hand steering wheel stalk.

Your vehicle can automatically apply the parking brake in several situations. You can also apply the parking brake manually.

1. After coming to a stop, press the button marked P on the right-hand steering wheel stalk.



- > The vehicle transitions to a parked state, which includes engaging the parking brake. The new state is indicated in the instrument panel.

PARK

The parking brake is automatically released when you select a driving gear.

8.8.3. Auto hold

Auto hold helps to keep the vehicle stationary after coming to a full stop, allowing you to release the brake pedal.

When in gear D or R and the vehicle comes to a full stop, auto hold will automatically activate if the necessary conditions are met.

To exit auto hold and continue driving in the selected gear, press the accelerator.

Note

Transitioning from auto hold to parked

Your vehicle will transition to P if auto hold is active for several minutes, if you unbuckle your seat belt or if you open the driver door.

Auto hold conditions

Auto hold is available when you are in gear D or R. You must also have your seat belt buckled and the driver door closed.

Auto hold is disabled when you are not using One Pedal Drive. By disabling One Pedal Drive, you enable automatic creeping. You must then manually activate the hold function to keep your vehicle stationary.

Manually activating hold

By pressing down hard on the brake pedal, you activate the hold function.^[1] This is indicated in the instrument panel with the hold symbol.

HOLD

Hold symbol

^[1] Manually activating hold is available when you are using automatic creeping.

8.8.4. Post-impact braking

The vehicle automatically applies the brakes when a severe collision is detected. This can reduce the risks associated with additional impacts.

In the moments after a collision, the vehicle may still be moving at high speed. There is also a major risk that the driver is not in full control of the vehicle, which could lead to additional impacts.

In the event of a severe collision^[1], automatic braking reduces your speed in a controlled manner, bringing the vehicle to a halt. Reducing your speed is especially important if there are pedestrians, vehicles or objects in the vehicle's path.

The brake lights and hazard warning lights activate during the maneuver. When the vehicle comes to a stop, the hazard warning lights stay on and the parking brake activates.

Note

Manual override

Pressing down on the accelerator overrides the braking maneuver, allowing the driver to select a safe place to stop.

Post-impact braking requires that the brake system is intact after the collision.

^[1] The severity of the collision must exceed a certain threshold for post-impact braking to activate. For example, if airbags have deployed.

8.9. Selecting the gear

Select a gear with the right-hand side steering wheel stalk. The current gear is indicated on the instrument panel.

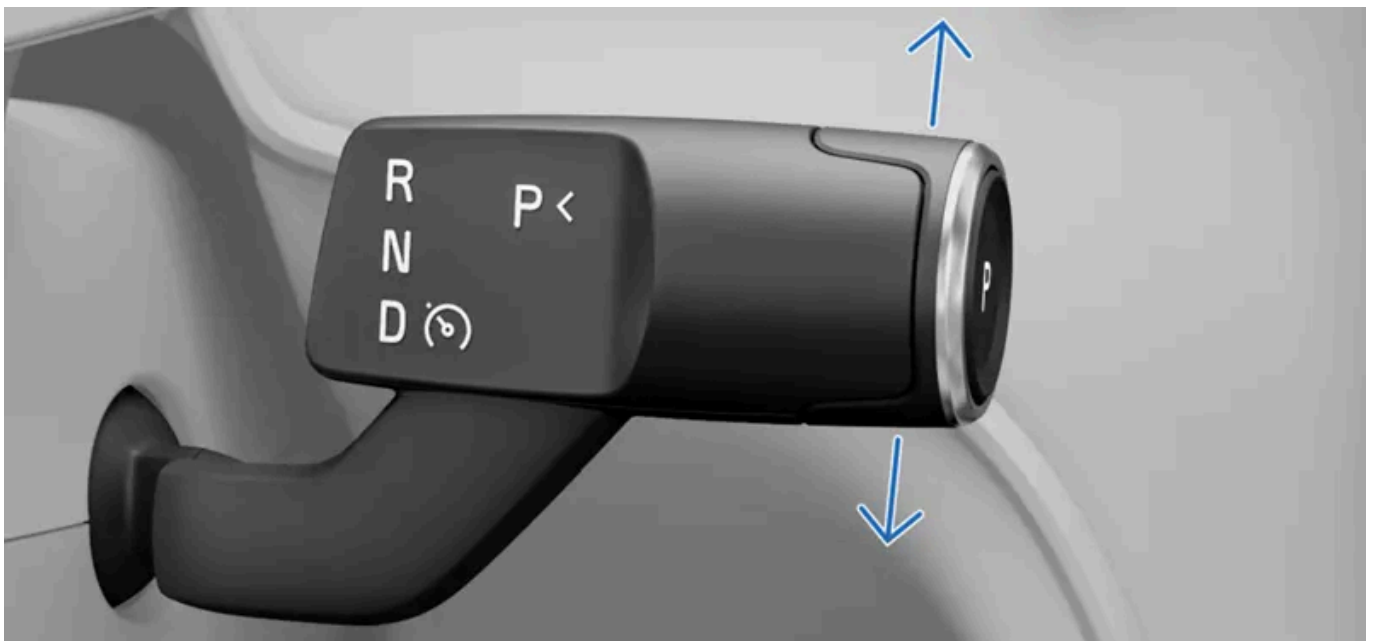

R Reverse

N Neutral

D Drive

In addition to gear selection, the right-hand stalk also controls the parking brake and certain driver support functions.

Changing gears is only possible when the vehicle is stationary or when you are driving at walking pace. You can't change gears while charging your vehicle.

1. Press the brake pedal^[1].

The content of this manual represents the status of the user manual at the time of printing and may not be completely valid in future instances. For more information refer to the first page for the complete disclaimer note.

2. Move the stalk up or down to select a gear.

> Your selection is indicated on the instrument panel.

 **Note**

When moving the gear selector either up or down, you can feel that it has two positions in both directions. Select R by moving the gear selector all the way up. Move the selector all the way down to select D.

You can select the neutral gear, N, by moving the gear selector to the first position, in either direction, and holding it there for a couple of seconds. The stalk always returns to its middle position between gear selections.

^[1] only necessary if your vehicle is stationary

9. Visibility, mirrors, and exterior lights

Learn how to control your car's lights, mirrors, and wipers for better visibility when conditions call for it.



Your vehicle is equipped with multiple features to assist you in your driving. Some are designed to improve safety, while others improve visibility. Some features are designed with both purposes in mind. Reading this section of the manual can assist in making your driving experience safer and more comfortable.

9.1. Exterior lights

Your vehicle has a range of lighting capabilities. You can select and control the different lighting options in the center display and on the left-hand steering wheel stalk.

 **Warning**

Vehicle light systems that are dependent on ambient light detection do not relieve you from your responsibility to ensure that proper lighting is used for all situations according to local laws and traffic regulations.

Exterior lights refers to all of the exterior illumination functions and features that affect visibility.



- ① You control certain driving lights, such as the high beam and the turn signals, with the left-hand steering wheel stalk.
- ② You select primary lighting modes, additional driving lights and exterior convenience lights in the center display.
- ③ The hazard warning lights button is located in the overhead console.

Some lighting features rely on the vehicle's ability to sense poor light conditions outside. Make sure that the vehicle's cameras are kept clean and are well-maintained. If the cameras' views are affected by dirt, they can't do their job properly. They need to be able to obtain enough information so that they can properly direct the vehicle's responses.

i Note

Camera maintenance

There is a forward-facing camera located behind the windshield. Do not clean the camera or any area behind the windshield cover by yourself, it should only be carried out by an authorized Volvo workshop or similarly qualified service professional. If you are concerned that the camera's visibility is obscured by dirt, use the windshield wipers and washer fluid to clean the windshield in front of the camera. The camera will be cleaned during regular scheduled servicing. If in doubt, or if you suspect that the camera needs immediate cleaning, contact Volvo Support.

Condensation

Exterior lighting may temporarily contain water from condensation. This is normal and all exterior lights are designed to withstand this. Condensation is normally vented out of the light housing after a period of time.

9.1.1. Driving lights



Driving lights mix automatic behaviors and manual controls, which allows you to adapt to any situation or visibility conditions.

! Important

The driver is always responsible for ensuring that the vehicle is driven while using a lighting mode that is suitable for the current driving conditions and local traffic regulations.

Primary lighting

You can choose between several different primary lighting modes in the center display. Your selection sets a standard lighting behavior.

Auto	Auto	Automatic lights mode ^[1] allows your vehicle to automatically detect and calculate which lighting mode is most suitable for the driving and environmental lighting conditions.
	Passing beam	You can manually select the passing beam to keep the front lights dipped.
	Parking lights	The position lights are points of illumination around the vehicle that make it more visible to other road users when your vehicle is stationary. ^[2]
Off	Off	Off deactivates all primary lighting modes. ^[3]

Note

Lighting mode availability

Some primary lighting modes can only be used under certain conditions, such as while driving or when your vehicle is turned off.

Adaptive features

In automatic lights mode, additional light features are enabled to help you adapt to changing driving conditions. This can be helpful in low lighting and when entering tunnels.

Additional lights

You can control the high beam and the turn signals using the left-hand steering wheel stalk.

The hazard warning flasher helps you to warn others of potential risks. You can turn them on or off by pressing the button in the display or the overhead console.

There are additional lights that can be enabled or adjusted in the display, such as:

Rear fog light The rear fog light warns traffic behind you of your presence in poor visibility conditions.

Auto-leveling

Auto-leveling automatically adjusts the vertical alignment of the passing beam to maintain good visibility and avoid causing glare to other road users.

^[1] Auto

^[2] The position lights can vary in different markets and regions.

^[3] Off cannot be selected when the vehicle is in drive.

9.1.1.1. Selecting a primary lighting mode

You can select a primary lighting mode via the center display.

The primary lighting mode sets the vehicle's standard lighting behavior. In certain lighting modes, you can activate or enable additional features to help you adapt to the driving conditions.

Note

Some primary lighting modes can only be used under certain conditions, such as while driving or when your vehicle is turned off.

1. Press the vehicle symbol  in the bottom bar and go to **Settings**.
2. Go to **Controls** → **Lights and displays** → **Exterior lights** → **Primary lighting**.
3. Select a primary lighting mode.

The primary lighting mode will reset to automatic^[1] between drives.

^[1] Auto

9.1.1.2. High beam

The high beam is important for your driving visibility. There are different states you can use to suit your needs.

Important

Remember that your ability to see the road properly in low lighting conditions is important not just for your own safety, but for other road users and pedestrians too.

The high beam is more powerful and has a longer reach of illumination than the passing beam. To use the high beam, you must first select the automatic or passing beam primary lighting mode.

You can choose between manual and automatic high beam. However, automatic high beam is only available in automatic lights mode^[1] and only activates in low lighting conditions.

Automatic high beam

When enabled, automatic high beam automatically switches between high beam and passing beam to avoid causing glare to other road users.

Note

Automatic high beam only activates at speeds over approximately 20 km/h (12 mph), in low light conditions.

You can use the left-hand steering wheel stalk to switch between the manual high beam and the automatic high beam. There are symbols in the instrument panel that show which high beam setting is currently active. These include:



Manual high beam is active.



The automatic high beam is enabled but not active.^[2]



The automatic high beam is active and the lights are turned on.

Important

Make sure that the vehicle cameras are well-maintained and kept clean. If the cameras' views are obscured by dirt, they will not be able to obtain enough information to properly direct the car's lighting responses.

^[1] Auto

^[2] Depending on the vehicle's current theme, this symbol can be a different color.

9.1.1.2.1. Operating the high beam

You can control the high beam using the left-hand steering wheel stalk.

There are several different high beam options you can choose from to suit the driving conditions.

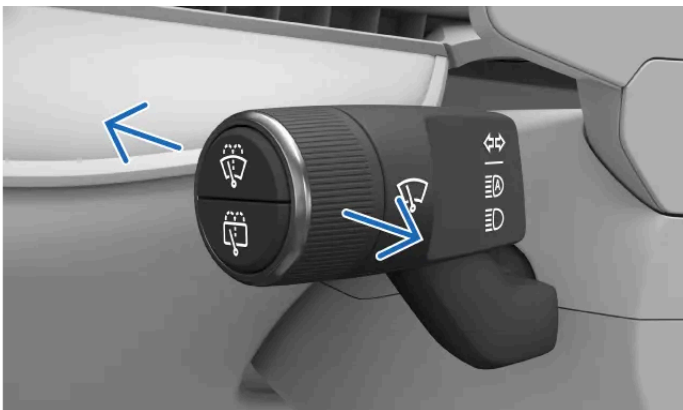

You can move the left-hand stalk forwards or backwards to switch between the different high beam options. The stalk always springs back to the neutral position.

The options available are:

- Automatic high beam
- Manual high beam
- High beam flash

 **Note**

Primary lighting modes

When you are in the automatic primary lighting mode, the high beam becomes part of the adaptive front-light system and works in different ways depending on the outside light conditions. You can enable the automatic high beam in all lighting conditions, but both the automatic and manual high beam can only be activated in low light conditions.

When passing beam is selected as the primary lighting mode, you can only activate the manual high beam.

The default lights setting is automatic^[1].

Enabling or activating the high beam

- When the high beam is turned off, push the stalk once to enable the automatic high beam or activate the manual high beam.

Deactivating the high beam

- Pull the stalk all the way towards you to turn the high beams off.

Flashing the high beam

- A short pull of the stalk activates the high beam flash.

Switching between manual and automatic high beam

- When automatic primary lighting mode is selected and the high beam is activated, push the stalk once to switch between automatic high beam and manual high beam.

 **Note**

If you deactivate the high beam, turning it back on during the same drive activates or enables the high beam option you last used.

The lights settings reset to their default values between drives.

 **Important**

Make sure that the vehicle cameras are well-maintained and kept clean. If the cameras' views are obscured by dirt, they will not be able to obtain enough information to properly direct the car's lighting responses.

9.1.1.3. Operating the turn signals

Use turn signals to communicate how you intend to maneuver your vehicle. The controls are located on the left-hand steering wheel stalk.

The signals have two types of activation – quick and standard. While the turn signals are blinking, you will hear a clicking sound and see a turn signal symbol in the instrument panel.



You can control the indicators using the left-hand stalk

Quick turn signal

- Move the left-hand steering wheel stalk slightly up or down and allow it to spring back to the middle.
- > The turn signals blink three times before turning off.

Standard turn signal

- Move the left-hand steering wheel stalk up to turn the right turn signal on and down to turn the left turn signal on.
- > The stalk moves back to its original position and the turn signals turn off when you straighten the steering wheel out after turning.

Note

You can cancel the turn signals by moving the left-hand steering wheel stalk slightly up or down in the opposite direction.

i Note

Turn signal malfunction

In the event of any malfunction or damage to the turn signals, the sound and the flashing indicator symbol will be twice as fast as normal, and the malfunction symbol  will appear in the instrument panel.

9.1.1.4. Cornering lights

The automatic cornering lights improve visibility in the immediate vicinity of the vehicle.

When the passing beam is active, cornering lights trigger when driving at low speeds in poor lighting conditions.

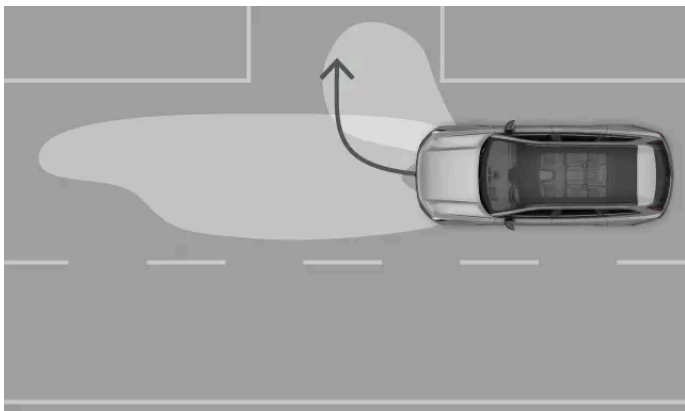

The cornering lights illuminate the area close to the vehicle to give you better visibility when turning.



i Note

If you turn without using the turn signal, only the light on the side you are turning towards will illuminate.

9.1.1.5. Activating the rear fog light

The rear fog light is designed to warn traffic behind you of your presence in bad weather with poor light conditions.

The rear fog light needs to be manually activated in the center display.

1. Press the vehicle symbol  in the bottom bar and go to **Settings**.
2. Go to **Controls** → **Lights and displays** → **Exterior lights** → **Rear fog light**.
3. Turn it on or off by pressing the fog light symbol .

9.1.1.6. Hazard warning lights

If there is a potential risk to surrounding traffic, you should turn the hazard warning lights on. This helps to alert other road users of the need for greater awareness.

Important

It is the driver's responsibility to use the hazard warning lights according to local laws and traffic regulations.

The hazard warning lights button is located in the overhead console. You can also access the lights in the bottom bar in the center display.



The location of the hazard lights button in the overhead console



The location of the hazard lights button in the center display

The status and interaction points to control the hazard warning lights are signified by the associated symbol.



In the event of a collision

Your hazard warning lights will automatically turn on in the event of a collision.^[1]

There is a cool-down period which disables the option to turn the hazard warning lights off. When you can manually deactivate the lights and use them again normally, the hazard warning lights button will begin flashing.

^[1] This is dependent on local regulations and regional standards.

9.1.1.6.1. Activating the hazard warning flashers

The hazard warning lights are essential for driving safety. Be sure that you know how to work them.



Hazard warning flasher symbol

When you get into the vehicle, the hazard warning lights button in the overhead console lights up, showing that you can use it. There's also a button located in the bottom bar in the center display.

1. Press the hazard warning lights button, either in the overhead console or the center display.
- > The hazard warning flasher buttons flash simultaneously in the same rhythm as the lights. If you're driving, both of the turn signal symbols in the instrument panel also flash and you will hear a clicking sound.

9.1.2. Exterior convenience lights

There are lighting functions available that make it easier to see when you are outside your vehicle.

Welcome lights

The welcome lights display a short lighting sequence and help you see your surroundings better as you lock or unlock your vehicle. You can also enable the welcome lights to trigger when you approach or leave your vehicle with a distance-capable key. This can be enabled in settings.

9.1.2.1. Enabling the welcome lights

The welcome lights help you see the area surrounding your vehicle.

You can enable the welcome lights to trigger as you approach or leave your vehicle with a distance-capable key. If this setting is disabled or you are not using a distance-capable key, the welcome lights are triggered when you lock or unlock your vehicle.

When the welcome lights setting is enabled, an additional light sequence will also be triggered.

1. Press the vehicle symbol  in the bottom bar and go to **Settings**.
2. Go to **Controls** → **Locking** → **Approaching and leaving** → **Greeting lights**.
3. Turn the welcome lights on or off.

The welcome lights setting stays active until you disable them.

9.2. Mirrors

The rearview mirror and the two door mirrors are important for your driving awareness. Make sure that you adjust the mirrors to your needs before driving.

Rearview mirror

You can adjust the interior rearview mirror by moving it manually.

Door mirrors

You can adjust the door mirror positions via settings and the buttons on the right-hand side of the steering wheel. Door mirror positions are automatically saved to the user profile.

The door mirrors are heated to prevent ice and frost from impeding visibility.

To fold the mirrors inwards, go to settings. It's useful to do this when parked. You can also set the door mirrors to automatically fold and unfold when you lock or unlock the vehicle.

Note

Alerts about vehicles in blind spots

The door mirrors have lights on them to give you greater driving awareness. They activate when vehicles are detected in or are approaching your blind spots.

 **Warning**

The passenger side's door mirror is curved to improve visibility. Objects may appear to be further away than they actually are.

 **Note**

Automatic dimming

Automatic dimming can reduce glare from strong lights in the door mirror on the driver's side and the rear-view mirror. Auto dimming is triggered only when poor lighting conditions are detected outside the vehicle. Auto dimming deactivates when reversing.

9.2.1. Adjusting door mirrors

Before you start driving, make sure that the door mirrors are in positions that give you good visibility.

Adjusting the door mirrors is an important part of the driver adjustments and is fundamental to your driving posture, allowing you better visibility and control of the vehicle.

1. Press the vehicle symbol  in the bottom bar and go to **Settings**.
2. Go to **Controls** → **Mirrors and wipers** → **Side mirrors**.
- > The adjustment settings view appears.
3. Select the door mirror you want to adjust.
4. Use the steering wheel buttons to adjust the selected mirror.

 **Important**

Adjustments for driving posture

Once you've finished adjusting the door mirrors to your liking, it's important to make sure other parts of the vehicle are aligned correctly. Your driving posture is important and is affected by more than your door mirror adjustments, such as the position of your seat and steering wheel.

Only adjust the mirrors via the center display

You can only adjust the door mirrors via the center display. It is not recommended to adjust the mirrors by hand, as this might break them.



Tip

Quick access to adjustment settings view

You can make several adjustments related to your driving posture in the adjustment settings view. To access this view without using the center display, just use the seat adjustment knob on the side of your seat. You can also access certain driver adjustments in the quick controls view via the center display. This allows you to make adjustments without going into settings.

Folding and unfolding door mirrors

You can fold and unfold the door mirrors in the **Mirrors and wipers** view. This can be useful to do when you are parking or driving in narrow spaces. You can also set the mirrors to automatically fold and unfold when you lock or unlock the vehicle in the **Locking** view.

9.3. Wipers and washers

The wipers and washers work together to keep the windshields clean and clear.



Important

Before activating the wipers, ensure that the wiper blades are not frozen in place and that any snow or ice on the windshield is removed.

Wiper and washer controls



You can control the wipers and washers using the scroll wheel and buttons on the left-hand steering wheel stalk.



Front wipers and washers



The content of this manual represents the status of the user manual at the time of printing and may not be completely valid in future instances. For more information refer to the first page for the complete disclaimer note.

Washers

The washer nozzles are integrated into the wiper arms for efficient washer fluid distribution.

When the windshield washers and headlights are on at the same time, the headlights are washed automatically. If the washer fluid level is low, the headlights washers only work when either the high beam or passing beam are on. This is to keep the windshield washers active for as long as possible.

Your vehicle tells you when it's time to refill the washer fluid. When washer fluid is running low, a message appears in the center display.

Front wiper modes

The front wipers have an automatic mode as well as multiple manual speeds. Each wiper mode sets a different speed for the wiper movements, so you need to select the appropriate mode for the conditions you are driving in. You can see the current wiper mode on the instrument panel. Between drives, the vehicle resets to automatic mode by default.

When automatic mode is active, the vehicle uses information from its rain sensor to activate the wipers and control their speed. You can change the rain sensor sensitivity in settings. When the rain sensor is active, you can see a symbol in the instrument panel.



Active rain sensor symbol

Rear wiper

Use the left-hand steering wheel stalk to manually turn the rear wiper on or off.

The rear wiper automatically activates if the front windshield wipers are active while you are reversing. If you change gear, the rear wiper will stop wiping the rear windshield. In low temperatures, the rear wiper won't automatically activate while you are reversing.

Important

Maintenance, refilling and replacing

- Clean the wiper blades regularly.
- Replace the wiper blades if they show signs of wear.
- Refill washer fluid when your vehicle tells you to.
- Avoid using the wipers without lubrication from either rain or washer fluid. It can cause wear or damage.

Vehicle wash safety

Turn the automatic wiper mode off when you enter a vehicle wash. Otherwise, the rain sensor will cause the wipers to activate, which could lead to damage.

9.3.1. Controlling the front wipers

You can manually activate the windshield wipers or change the way they work. When the vehicle detects rain in automatic mode, the wipers will activate.



There are different front wiper modes that you can activate by using the left-hand stalk. The modes are:

- II High
- I Low
- Auto** Automatic mode using rain sensor
- Off** Wipers are turned off

Single wipe

1. Press once quickly on the upper button on the end of the left-hand steering wheel stalk.



- > The wipers will swipe once across the front windshield.

Changing wiper mode

2. Rotate the scroll wheel on the end of the left-hand steering wheel stalk.
- > The wiper menu appears in the instrument panel, allowing you to scroll through the wiper modes. The currently selected mode is also highlighted.

9.3.2. Controlling the rear wiper

The rear wiper can be manually turned on and off. It also automatically activates if the front windshield wipers are active while you are reversing.



Turning on and off

1. Quickly press the lower button on the end of the left-hand steering wheel stalk one time.



- > Rear windshield interval wiping turns on or off. The current state is shown in the instrument panel.
2. Press the button again to turn the rear wiper off.

Tip

Activate when reversing

If the front wipers are active, the rear wiper will automatically activate when reverse gear is selected. It automatically turns off when you change gear. The rear wiper will not activate in low temperatures.

9.3.3. Activating washers

Activate the front or rear windshield washers using the buttons on the left-hand steering wheel stalk.



- Press and hold the button on the left-hand steering wheel stalk for the washers you want to activate. The front washers are activated by the upper button and the rear washer is activated by the lower button.



Front wipers and washers symbol



Rear wiper and washer symbol

- > The washers and wipers work together to distribute washer fluid across the windshield. When you release the button, the wipers make a few more passes to wipe away excess fluid.

10. Driver support and navigation

Driver support features are designed to improve safety, comfort and convenience when you are using your vehicle. They assist you with your driving, route-planning and decision-making on the road.



The collection of driver support features in this vehicle can assist you in driving, navigating and parking. Some are exclusively designed to improve safety, while others improve convenience. Some features are designed with both purposes in mind.

When used correctly, driver support features can reduce the effort of driving, help reduce distractions and improve safety for you and others. They often take advantage of the vehicle's ability to monitor and keep track of its surroundings. Some features deliver that information to you for increased driver awareness, while other features provide fast reactions to hazards that the vehicle identifies.

10.1. Navigation

Use the Google Maps navigation app to get directions and traffic information, as well as to find the nearest charging station.

When the vehicle is connected to the internet, it can continuously download map and traffic information to help you navigate to a destination. Navigation guidance can appear in the vehicle's displays.

The vehicle knows its location through GPS and shows it in the map views in the vehicle's displays.

Navigation app



Google Maps symbol

Note

Latest app version

Be sure to update the app whenever there's a new version available. Functionality and support for old versions may vary.

Connected navigation features

Whenever your vehicle is connected to the internet, it can get the latest navigation information.

Real-time traffic information	You can get real-time traffic information if the vehicle is connected to the Internet. For example, you can see if traffic is moving slowly. Different colored lines that correspond to traffic situations will appear on your chosen map route. If the Internet connection is lost, the lines disappear after a while. You also get information about traffic conditions along the chosen route, such as roadworks or accidents.
Alternative routes and redirected traffic	When you set a destination in the navigation app, the fastest route is suggested while also taking your navigation settings into account. For example, you can choose to avoid tolls or ferries. The chosen route can be redirected while you are driving, such as when there is an accident or a traffic condition that affects your travel time.
Sharing information with other devices	Link your Google account to an active user profile to get the same Google Maps information in your vehicle as on your other devices. Destinations saved to your Google account using other devices, such as home, work, favorites and last searches, are then also available in your vehicle.

Offline maps

When you are connected to the internet, you can download map areas so that they are available in the vehicle even if your vehicle has poor reception or no internet connection. This feature is available in Google Maps' settings.

Displayed information

When a route is added, the following travel information about the trip is shown in the center display:

- Travel time
- Distance to the next destination on your route, such as an extra stop
- Estimated time of arrival
- The name of the next destination on your route
- Estimated state of charge when reaching the destination

Depending on the selected display mode, the instrument panel shows different amounts of map and guidance information.

Navigation settings

You can change the navigation settings in the navigation app.

 **Warning**

Avoid driver distraction

Avoid any interaction with the vehicle's systems or other devices that may distract you from driving safely. Any task that does not allow you to keep your attention on the road and surrounding traffic should be done when the vehicle is parked.

 **Note**

Navigation limitations

- The navigation feature is from a third-party supplier. Availability, procedure and functionality may vary over time and depend on region.
- Navigation instructions can sometimes be less reliable than usual due to factors such as weather or road conditions.

Poor or no internet connection

The navigation app can have trouble finding a route or signal when you are in a location which can interfere with your internet connection, such as a tunnel or multi-story parking garage.

 **Tip**

Range and charging

There are features in navigation that can help you plan your trip based on charging stations, estimated charging time, estimated battery level upon arrival and range.

10.1.1. Finding and selecting a navigation destination

Find your destination using the search field or a voice command. The vehicle then suggests routes for you to choose from.

1. Press the app library symbol  in the bottom bar and open Google Maps.
2. Enter an address or destination in the search field.
 - > A route is suggested, together with alternative routes.
3. Select your preferred route.
4. Select start.
 - > Navigation instructions start.

10.2. Detection of surroundings and traffic

This section covers the essentials of how cameras, radar units and other sensors work, including their limitations. Understanding how your vehicle perceives its surroundings can help you use features that rely on this capability.

Your vehicle's ability to understand its surroundings is achieved through many systems and types of sensors. The vehicle's interpretation of the data it collects helps inform its behavior, especially for driver support features.

Cameras	Cameras work similarly to the human eye. What they capture is used for different purposes, which depends on the camera. For example, the upper front-facing camera helps the vehicle identify things such as traffic signs and road markings, while the rear parking camera captures images to display in the center display.
Radar units	The radar units use radio waves to collect information about the vehicle's surroundings. They can identify the distance to objects and certain aspects of their movement. This information is essential for many features in the vehicle.
Ultrasonic parking sensors	These sensors use sound waves to detect relatively close objects. They work by sending out ultrasound pulses that can bounce back to the sensors when they encounter an object.

How the systems work together

The different detection types complement each other. They are sometimes used on their own and sometimes together.

Important

Even when used together, these detection systems cannot handle all conditions and traffic situations. This is why it's important for the driver to never rely fully on driver support features. Always be attentive to conditions and situations where driver support feature performance is affected by the limitations of these features.

General detection and identification limitations

Each type of detection has its own set of limitations, but there are a few general things to consider as well.

- The vehicle can't always handle unpredictable or unusual situations. When the vehicle finds it difficult to correctly identify the environment or traffic situation, the accuracy of its response is affected.
- Damage to the vehicle can affect detection and features that use it. Many faults can be identified by the vehicle, but some may not be possible to self-identify. This is why it's important to make sure that the vehicle is in good condition and working order. Contact an authorized Volvo workshop if you suspect there is any fault or if you notice damage to the vehicle.
- Limiting factors and conditions can and often do coincide. They can compound and interact in ways that lead to an incorrect response from the vehicle.

Obstacle detection limitations

Obstacle detection helps the vehicle identify certain stationary and moving objects. These include other road users, such as pedestrians or other vehicles, as well as animals, barriers and other objects. If obstacles are in or close to the vehicle's driving path, they could pose a collision risk. Depending on the circumstances, the vehicle might be able to warn or intervene if the object is accurately identified. For every type of object the vehicle can identify, there are many factors that can prevent accurate identification. Examples of limiting factors, situations and events include:

- Closely spaced, overlapping or partially blocked objects and road users.
- Objects and road users that blend in with the background.
- Objects and road users that move or accelerate particularly fast.
- Uncommon vehicles, such as recumbent bicycles, combine harvesters or trailers with oddly shaped loads.
- Bicycles of a different type or size compared to a regular adult bicycle.
- New modes of transportation.
- Pedestrians wearing clothing or carrying objects that alter their silhouette.
- Pedestrians shorter than 80 cm (32 inches).
- Obstacles angled in ways that create an unknown silhouette.
- Size and speed of animals. Cats and dogs are often too small to identify reliably.

Note

Traffic detection examples

Examples of different traffic scenarios can help you understand some of the limitations of your vehicle's detection systems. Real-world scenarios are often more complex than the example illustrations^[1] in this manual.

Out of view and late detection

The various detection zones around your vehicle are static, each with a limited range and field of view. If something enters a detection zone at an unusual angle, at high speed or very close to your vehicle, it can cause a rapid response. This reduces safety margins compared to a situation in which earlier detection is possible.

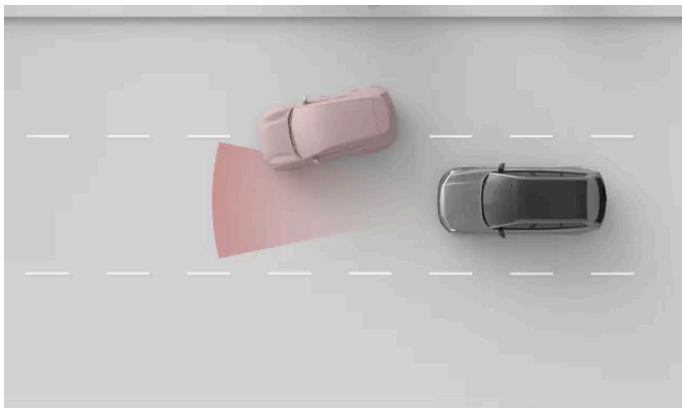

The front radar's detection zone has a limited width. If you get cut off by another vehicle, detection can occur relatively late, causing your vehicle to respond suddenly.

Important

Lane placement and small vehicles

Forward detection works better for objects in the middle of the lane than for those on the outer edges. Vehicles can go undetected if they don't occupy the middle of the lane. While this can happen for any vehicle, the risk is higher for small vehicles such as motorcycles. They take up less of the lane's width and can move about more within the lane. Always pay extra attention to any vehicle not driving in the middle of the lane.

Shape, size and number of objects

Detection can be less reliable depending on the shape, size and number of objects in a detection zone. These factors can make identification of the distance to the closest vehicle ahead less accurate, especially if several of these factors come into play.

- Small objects are harder to identify.
- The more objects in the detection field, the harder it is to identify individual ones.
- Objects close together that overlap are harder to identify.
- Objects with irregular shapes, such as overhanging or projecting parts, are harder to identify.

The presence of a large vehicle in front of you can make it difficult to identify a smaller one like a motorcycle between you and the large vehicle.

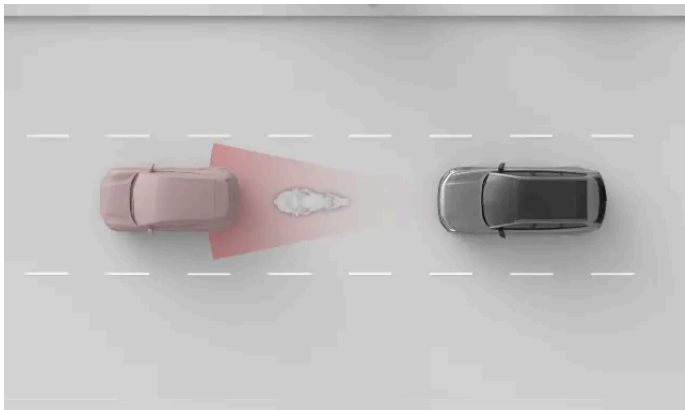

If the motorcycle and the larger vehicle are close to each other, they may appear to overlap to the detection systems, making detection of the motorcycle less accurate.

! Important

Trailer in front

Trailer detection is often less reliable than the detection of other vehicles due to their shape and height. This applies, in particular, to narrow trailers, flatbed trailers and trailers with high load beds. These types of trailers often don't have enough surface area at the height where forward detection systems focus.

Road and infrastructure

Curves in the road can cause the vehicle to misinterpret the traffic situation. For example, it can lose track of a vehicle or misidentify which lane a vehicle ahead is in.

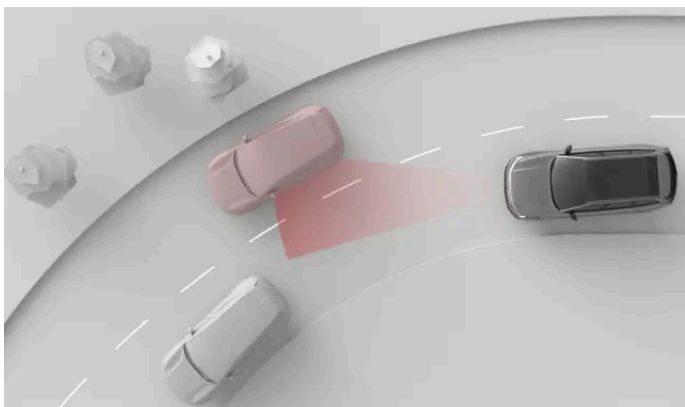

The content of this manual represents the status of the user manual at the time of printing and may not be completely valid in future instances. For more information refer to the first page for the complete disclaimer note.

On a curve, the vehicle ahead may slip out of the detection zone. Vehicles in the adjacent lane may also enter the zone, affecting your vehicle's perception of the distance to traffic ahead.

 **Important**

Road condition and irregularities

Both common and uncommon road features can impact the effectiveness of the vehicle's detection systems.

- Sharp bends and bumps in the road can temporarily obscure important parts of the vehicle's surroundings, such as other vehicles or road markings.
- Non-standard or unusual road infrastructure might not be correctly identified by the vehicle. For example, road work or traffic diversions can result in conflicting or multiple sets of road markings.
- Worn road markings or signs might not be correctly identified.

^[1] The representations of detection systems and the vehicle's surroundings are not to scale.

10.2.1. Locations of cameras, sensors and radar units

Knowing the placement of different components the vehicle uses to map its surroundings helps you keep them free of dirt, obstructions and accidental damage.

Many of your vehicle's driver support features rely on data from components that scan and map your vehicle's surroundings, such as cameras, sensors and radar units. This section doesn't show all components and their precise locations, but it gives you a general idea of where they are. Areas pointed out in this section are particularly important to keep clean. Damage to these areas can also affect functions that rely on components located there.

 **Warning**

Clean regularly

Camera, radar and other sensor areas on the vehicle must be cleaned on a regular basis and kept free from labels, objects, dirt and other potential obstructions. Otherwise, vehicle functions may respond incorrectly or become less responsive or deactivated.

Be careful when cleaning the area next to a camera to avoid scratching the lens.

Scraping the windshield

The windshield area in front of the front-facing camera has its own heating to defrost and remove any build-up of snow or ice. Do not use an ice scraper on this area, as it can scratch the glass surface. Scratches or damage to the glass in front of the camera can interfere with or limit its detection capabilities.

Mounted accessories

Be mindful of the effects of mounted vehicle accessories, such as cargo racks or exterior light accessories. The items themselves or the load you add may obstruct cameras, sensors or radar units.



- ① The top center of the windshield houses a front-facing camera.
- ② The side-view cameras are located on the door mirrors, which also house rear-view cameras.
- ③ There is a camera and a radar in the emblem area in the front of the vehicle.
- ④ The front of the vehicle also has a radar in each corner.



- ⑤ There is a rearview camera in the rear center of the vehicle.
- ⑥ The rear of the vehicle also has a radar in each corner.

The content of this manual represents the status of the user manual at the time of printing and may not be completely valid in future instances. For more information refer to the first page for the complete disclaimer note.



Tip

Finding the parking sensors

There are multiple ultrasonic parking sensors along the lower edge of the vehicle. You can see their exact locations by looking for their button-like cover plates along the bumper panel.



Important

Cleaning in front of radar units

If you find dirt, snow or ice, or if the vehicle indicates that a radar unit is blocked, you should address it as soon as possible. Always clean and clear a large area around the radar units to so their full field of view is available.

10.2.2. Camera detection and limitations

The vehicle cameras capture the surroundings in a way similar to the human eye. This comparison is useful for understanding their capabilities and limitations.

Cameras help the vehicle identify certain objects and surfaces that visually stand out against their backgrounds. This includes things such as road markings, traffic signs, pedestrians and other vehicles.

Camera information in the parking view can provide you with an additional way to monitor the vehicle's surroundings.

Light conditions

Cameras need light to work and are affected by light conditions.

- Strong light sources, such as the sun, can cause glare and reflections that negatively affect camera detection.
- Low light can negatively affect certain types of camera detection.
- Some detection types require low-light conditions. When it's dark, the lights from other vehicles can be identified, as they stand out against the background.



Important

Camera detection in darkness

For the vehicle to be able to identify other vehicles when it's dark, the other vehicles must have their headlights and taillights turned on and be clearly visible. While the vehicle also uses other types of detection, such as radar, it may not have enough information to reliably identify vehicles that are not seen by the cameras. Several driver support features can be affected by this, such as safety interventions, collision warnings and features that provide distance-keeping.

Visibility

Poor visibility for the driver typically means poor visibility for the cameras. Objects that are hard to detect for the human eye can sometimes be hard to detect for the cameras as well. This can include well-camouflaged objects or objects where the outlines don't stand out against the background.

- Fog, heavy rain, snow or dust storms can severely limit visibility for the cameras.
- Beware of dust, water or snow on the ground that may be disturbed and kicked up into the air by your vehicle, other traffic or the wind.

Field of view and obstructions

Cameras see in the direction they're facing and only within their field of view. The field of view differs for each camera and depends on their intended purpose.

Obstructions limit what the camera sees. Each camera views the surroundings from its mounting position, and anything that enters its field of view blocks its view of what lies behind the obstruction. Objects close to a camera will block more of the camera's field of view than objects that are further away. If the vehicle detects that a camera is blocked, it can disable certain features that rely on that camera.

- Make sure that any mounted accessories, extra equipment or externally-stowed cargo don't block part of the cameras' fields of view. For example, far-extending roof loads may block part of the top view for front- and rear-facing cameras.
- Trailers, bike racks or other towbar-mounted equipment can block the rear camera view.
- Dirt, ice, snow, water droplets and condensation on camera lenses obstruct the cameras' view to some extent. In some cases, the vehicle may be able to identify that something is in the way and notify you. However, it is still recommended to regularly inspect the cameras and make sure that they are clean and unobstructed.



Warning

Clean regularly

Camera, radar and other sensor areas on the vehicle must be cleaned on a regular basis and kept free from labels, objects, dirt and other potential obstructions. Otherwise, vehicle functions may respond incorrectly or become less responsive or deactivated.

Other limitations

If the cameras become too hot, they can be temporarily switched off to protect them from damage. This can happen when starting the vehicle after being parked in high temperatures in combination with direct sunlight hitting a camera. The camera will become available again once it has sufficiently cooled down.

 **Important**

Windshield damage

Windshield damage in the camera area, including small chips, scratches or cracks, can negatively affect performance of the camera and features that use it. This may reduce functionality, cause unreliable vehicle responses, or disable features. If damage occurs, follow this manual's separate recommendations for handling windshield damage.

Camera calibration

After replacing your vehicle's cameras or any of the surrounding parts, such as the windshield, door mirrors or front bumper, the cameras might take a while to recalibrate themselves. This can cause some driver support features to be unavailable for a short time after the vehicle is serviced. Calibration may take a while if it takes place during poor lighting conditions. You can find messages about ongoing camera calibration in the instrument panel.

10.2.3. Radar detection and limitations

The radar units use radio waves to collect information about the vehicle's surroundings. They can identify the distance to objects and certain aspects of their movement. It's important not to block the radar units.

There are several radar units aimed in different directions to collect information about the vehicle's surroundings. This information is primarily used by the vehicle's driver support features. Radio waves are continuously sent out and bounce back if they encounter an object in their path. As the waves return, the vehicle can calculate the position and motion of the object, for example.

The radar units are not affected by lighting conditions and work equally well on sunny days and in complete darkness.

 **Important**

Use responsibly

The radar units and the features that rely on them are supplements to safe driving practices. They do not reduce or replace the need for the driver to stay attentive and focused on driving safely.

Detection zone and field of view

Each radar unit in the vehicle has its own detection zone. The zone is limited by the radar's field of view and range.

Objects in the field of view block what's behind them. The closer something is to the radar, the more it blocks the radar's field of view.

- If a radar is blocked, certain features may become less effective or respond incorrectly.
- If the vehicle detects that a radar is blocked, it may disable certain features.
- Do not place or mount anything in front of or close to the vehicle's radar units. This includes stickers, vehicle body foil and adhesive tape.
- Paintwork damage in front of a radar can affect its performance. Contact a service point for repairs if there is any damage close to the radar units.^[1]

- Make sure that any mounted accessories, extra equipment or externally-stowed cargo don't block the vehicle's radar units.
- Trailers, bike racks or other towbar-mounted equipment can block the radar, making it and certain features unavailable.
- The radar units are sensitive to the buildup of dirt, ice or snow in front of them. This affects the radio waves and can reduce the radar's ability to detect objects. Radar obstruction cannot always be identified by the vehicle. In situations where it is detected, the vehicle communicates this via notifications in the displays. However, it is still recommended to regularly inspect the radar units and make sure the areas around them are clean and free of obstructions.

 **Warning**

Clean regularly

Camera, radar and other sensor areas on the vehicle must be cleaned on a regular basis and kept free from labels, objects, dirt and other kinds of potential obstructions. Otherwise, vehicle functions may respond incorrectly or become less responsive or deactivated.

Other conditions and limitations

Other radar sources can cause interference and reduce the effectiveness of your vehicle's radar units.

^[1] Volvo recommends authorized Volvo workshops for all servicing and repairs.

10.2.4. Parking sensor detection and limitations

The ultrasonic parking sensors allow the vehicle to detect objects and their distance from the vehicle. They operate at relatively close range during slow and tight maneuvering, such as when parking.

Ultrasonic sensors use sound waves to detect obstacles close to the vehicle. They work by sending out ultrasound pulses that can bounce back to the sensor when they encounter an object or barrier. This allows the vehicle to identify the distance to obstacles in the direction of detection.

Information from these sensors is only available at low speeds. They provide distance information when the parking view is shown in the display.

 **Important**

Use responsibly

Ultrasonic parking sensors and features that rely on them are supplements to safe driving practices. They do not reduce or replace the need for the driver to stay aware of the vehicle's surroundings and focused on driving safely.

Detection range

Ultrasonic sensors are typically located relatively low on the bumper.

- Obstacles whose supports are outside of the detection zone can go undetected. Such obstacles include objects that are suspended from above or objects that extend far from their ground support, such as certain barriers and gates.
- Objects in your immediate surroundings^[1] may not be detected when your vehicle is at a standstill. However, if an object has already been detected, the vehicle can still detect the object even if you come very close to it.

Blocked sensors

Ultrasonic sensors can get blocked, either reducing distance and obstacle detection or making it unavailable. To avoid blocked sensors or to better understand when they may be unavailable, consider the following:

- If a sensor is blocked, certain features may become less effective or not respond correctly.
- Heavy rain or snowfall can lead to unreliable detection, and features relying on the ultrasonic sensors becoming unavailable.
- If the vehicle detects that a sensor is blocked, it may disable certain features.
- Do not place or mount anything in front of or close to the vehicle's sensors. This includes stickers, vehicle body foil and adhesive tape.
- Bodywork damage where the sensors are located can affect their performance. Contact a service point for repairs if there is any damage near the sensors.^[2]
- Make sure that any mounted accessories, extra equipment or externally stowed cargo don't block the sensors.
- Trailers, bike racks or other towbar-mounted equipment can block sensors, making detection and certain features unavailable.
- Ultrasonic sensors are sensitive to the buildup of dirt, ice or snow in front of them. This can reduce their ability to detect objects. The vehicle cannot always identify parking sensor obstruction. In situations where it is detected, the vehicle communicates this via notifications in the display. However, it is still recommended to regularly inspect the sensor locations and make sure the areas around them are clean and free of obstructions.



Warning

Clean regularly

Camera, radar and other sensor areas on the vehicle must be cleaned on a regular basis and kept free from labels, objects, dirt and other kinds of potential obstructions. Otherwise, vehicle functions may respond incorrectly or become less responsive or deactivated.

^[1] about 15 cm (6 inches)

^[2] Volvo recommends authorized Volvo workshops for all servicing and repairs.

10.3. Driver behavior detection

The vehicle continuously monitors certain aspects of driver behavior. This is important for several driver support features.

Driver behavior detection is used to verify that specific conditions are met when driving and using certain features. Two cameras, one located by the instrument panel and one located just above the center display, continuously track the driver's behavior

without recording it. An important part of the monitoring system is checking that the driver's hands are on the steering wheel when driving. The information from this system is used by several driver support features.

Several aspects of driver behavior are monitored, including:

- Head and body posture
- Eye movement and focus
- Signs of tiredness or fatigue

i Note

System for understanding the driver

In addition to tracking the driver's attention, the vehicle monitors some other parts of driving. This includes keeping the doors closed and seat belts buckled while driving. The individual detection points are combined to form a better understanding of the driver's focus, attention and behavior.

Information from the behavior detection system is combined to identify whether the driver's attention is focused on driving. This includes keeping track of traffic and surroundings, as well as being attentive and alert. The detection system can give you notifications in the instrument panel.

Reliant features and functions

The driver behavior detection system keeps track of the driver's behavior to decide if the vehicle is being handled safely. If the system is blocked or detects driver misuse, it can trigger a response from several other features or functions of the vehicle.

Features that are affected by the driver behavior detection system include:

Driver alert	Driver alert can notify you if you seem tired, distracted or unfocused.
Emergency stop assist	In situations where the driver is unable to continue driving, the vehicle can perform a controlled stop to reduce the risk of a collision.
Collision warnings and mitigation	If you do not have full focus on driving, your vehicle can warn you or intervene in dangerous situations earlier than usual
Pilot Assist	Pilot Assist's steering assistance can be deactivated if you seem unfocused or don't respond to requests to keep your hands on the steering wheel.

Conditions and limitations

The driver behavior detection system relies on cameras for detection and tracking. While the system is advanced, cameras have limitations related to visibility that can affect the system's detection capabilities. Read the separate section about the conditions and limitations of your vehicle's cameras to understand how features relying on camera detection are affected.

- Attention tracking requires an unobscured view of the driver's face.
 - The seating position can affect how clearly the cameras can detect the driver's face.
 - Environmental conditions inside the cabin, such as smoke, can reduce how clearly the cameras can detect the driver's face.
 - Improperly stowed items can obscure the view of the driver, as can dust and dirt on the camera lens. Keep the driver's space clean and clutter-free.
 - Wearing certain clothing and accessories can obstruct parts of the driver's face that need to be visible for attention tracking, such as the eyes.

- Certain conditions can affect how well your vehicle can assess your driving and maneuvering. This, in turn, affects how well it can distinguish signs of an unfocused or tired driver.
 - Features that help with lane placement can sometimes compensate for maneuvering that would otherwise indicate a lack of driver focus. This makes it harder to identify signs of poor focus compared to unassisted driving.
 - Sudden changes in lighting conditions can temporarily affect how well your vehicle can detect driver attention.
 - Conditions such as strong winds or uneven road surfaces can affect your driving in ways similar to being unfocused. This can potentially cause warnings despite having a fully focused driver behind the wheel.

 **Important**

Affecting the system

Do not cover the cameras. The cameras can be fully or partially obscured by objects hung or placed on or around the instrument panel or the center display. Objects placed on the dashboard can fall down or become misplaced so that they cover the cameras' views. If the cameras are obscured or covered, your vehicle will notify you with a message on the instrument panel.

Do not intentionally try to trick the driver behavior detection system. The system is there to keep driving as safe as possible. By limiting the system's ability to detect a dangerous situation, you also limit its ability to perform a safety intervention.

10.4. Safety interventions and warnings

Your vehicle has features that directly or indirectly help prevent collisions. If your vehicle detects a dangerous traffic situation, it can intervene by warning the driver or performing an evasive driving maneuver.

Safe driving begins with good user practices. As an additional level of protection against incidents, your vehicle can warn you if it detects a situation that requires your immediate attention or action. In addition to making the driver aware through warnings, the vehicle can intervene by steering or braking to avoid or mitigate a collision.

Features that are designed to provide warnings or perform interventions in different ways include:

- Collision warnings and mitigation
- Blind spot information
- Lane keeping aid
- Driver focus and alertness notifications^[1]
- Emergency stop assist
- Alerts about traffic crossing behind the vehicle when reversing^[2]
- Automatic braking when reversing^[3]



Tip

What are safety interventions?

Safety interventions are responses from the vehicle in situations in which it identifies a high or imminent risk of collision. Warnings can be provided to alert you to hazards so that you can take action, but the vehicle is also capable of performing emergency steering or braking maneuvers depending on the situation. Some types of warnings and interventions are always enabled, while others are part of features that you may be able to customize or choose to turn on or off.

Safety interventions to avoid collisions

When the vehicle identifies a risk of collision, it reacts according to the level of urgency. It can identify objects such as pedestrians, cyclists and vehicles that are approaching or are in your driving path. Many factors can affect how early and effectively the vehicle can detect the risk of an incident. There are situations that are beyond the vehicle's capabilities, which is why safe driving practices are essential.

If the vehicle identifies an increasing risk of collision, alerts can quickly escalate to evasive maneuvers by the vehicle. If a threat appears suddenly, the vehicle can immediately perform evasive maneuvers.

Collision warnings	When the vehicle identifies that there's a risk of collision, the first step is to get the driver's attention. The vehicle can warn you visually, with sound or with seat belt or brake pulses.
Braking maneuvers	If the vehicle determines that immediate action is required, it can brake independently of the driver's actions. This can occur at the same time as a steering maneuver. The amount the vehicle brakes when intervening depends on the situation. An obstacle that suddenly appears just in front of the vehicle may cause the brakes to be fully applied, whereas another situation might require less braking to avoid a potential collision.
Steering maneuvers	If the vehicle determines that immediate action is required, it can steer independently of the driver's actions. This can occur at the same time as a braking maneuver.

Messages about performed safety interventions are shown in the instrument panel.



Note

Overriding steering and braking interventions

- You can always override the vehicle's steering by intentionally steering the vehicle yourself.
- To override a braking intervention, you must firmly press down on the accelerator pedal. Past a certain threshold, you override the ongoing braking action.

Knowing your vehicle's capabilities

Safety interventions by the vehicle can occur suddenly and catch you by surprise. This can cause concern, despite the benefit they provide. The more you know about your vehicle, the less unsettling these safety interventions will feel when they are activated. Be sure to read any notifications following an intervention to better understand why the vehicle intervened.

Reducing the amount of interventions and warnings

The amount of safety interventions and warnings you experience depends on the driving conditions and your driving style. Certain combinations of factors might result in responses you perceive to be unnecessary or too sensitive. In general, the most effective way to reduce the amount of warnings and interventions is to drive responsibly. Adapt your speed to the driving conditions and keep a safe distance to other vehicles. You can also adjust or turn off certain features in settings.

Balancing the need for responses

When the vehicle suggests, guides or performs a driving action, it is considered a response. Most driver support features have some set of possible responses. For instance, automatic braking to prevent a collision with a vehicle that suddenly brakes in front of you is a response. Features that can provide you with warnings and safety interventions are designed to limit unnecessary responses.

Your vehicle's responses each have their own set of conditions. These conditions may be related to the traffic situation, the state of the vehicle and driver, and information collected using the vehicle's detection systems. For a response to occur, all of the required conditions must be met, and the vehicle must have a high certainty that the response is needed. As a situation develops, the vehicle continuously evaluates the conditions and the need for a response. If the response need or conditions are uncertain, then the vehicle won't respond.

If you are able to address a potentially hazardous situation yourself, it is better for you to respond than to depend on a response from the vehicle. The vehicle can delay or avoid providing a response in situations where you have the opportunity to address it using non-emergency maneuvering. This helps reduce unnecessary warnings and safety interventions. You can address most potential hazards that the vehicle identifies through minor adjustments well ahead of the need for emergency evasive maneuvering. In most instances, you will perceive these as routine actions that are part of normal driving.

Important

Always address driving hazards

The vehicle can and will compensate for some instances where you are unable to or fail to respond to a driving hazard, but it will not be able to handle every situation. There are situations where an effective response is beyond the capabilities of the vehicle, as well as situations where the vehicle does not respond because it expects the driver to address the potential hazard. When driving, you must stay alert and attentive so that you can respond to hazards just like you would driving a vehicle without driver support features.

Conditions and limitations

Warning

Never rely on the vehicle's safety interventions as a replacement for safe driving practices. Drive the vehicle with the same attention to safety as you would need to in a vehicle without these features.

Warnings and interventions cannot be guaranteed in any situation. The vehicle cannot handle all driving, traffic, weather and road conditions. Failure of the vehicle to detect or respond to a hazard can happen for reasons that you may not be able to identify or predict.

The vehicle's ability to respond to hazards varies depending on many factors. May of them fall into the following categories:

- Your vehicle's speed and movement.
- Size, shape, speed and movement of objects or road users around the vehicle.
- Environmental conditions.
- The condition of the driving infrastructure.
- The complexity of the traffic situation.

Notable examples:

- Sharp turns can cause detection to become less consistent. The vehicle might be unable to identify hazards that appear suddenly as a result of turning sharply.
- Low traction, such as when the road is wet or icy, can reduce the effectiveness of interventions.
- Conditions and limitations affecting obstacle detection can prevent the vehicle from accurately identifying potential hazards. Obstacle detection limitations are described in detail in the separate manual section about how the vehicle detects the surroundings and traffic.
- The vehicle won't perform automatic braking interventions if you are driving forwards at or below walking pace. This is to avoid unwanted braking interventions when you are maneuvering in tight spaces.

Important

General limitations

You have good reason to feel safe in a vehicle capable of intervening in dangerous situations, but it's important to still do your best to drive safely and responsibly. The vehicle's capabilities are always limited by technological factors and constraints, vehicle condition and the driving environment.

Detection capabilities

The vehicle's ability to monitor its surroundings is used by features that can provide warnings and interventions. To better understand the limitations of such features, read the separate section about detection of traffic and surroundings. It provides an overview of how important components work, such as cameras and radar units, detailing both capabilities and limitations.

Reaction times

In favorable conditions, the vehicle can perceive and react to certain hazards: in some cases, faster than a human driver can. However, this capability is not a guarantee of intervention, as the vehicle cannot detect all potential hazards that may require a response.

Availability of responses

All of the vehicle's response types have their own set of conditions that define when they are available. This means that the available responses change continually as you drive. Certain conditions are strictly defined, such as an exact speed range, a setting being enabled or the driver wearing their seat belt. Other conditions have more imprecise thresholds that can depend on a combination of factors. This means that you cannot know for certain whether the vehicle will respond in a given situation, or how, but you can develop a sense of what responses are likely or not.

Read everything about the features you use

It is recommended that you read all information about driver support features before using them. It's essential to understand both their capabilities and limitations.

Wear your seat belt

Emergency braking interventions can occur even if the driver is not wearing their seat belt. The risk of injury from hard braking rises significantly for unrestrained occupants. Always wear your seat belt and make sure that any passengers also wear theirs.

Driver responsibility

Features that provide interventions and warnings are supplements to safe driving practices. They do not reduce or replace the need for the driver to stay attentive and focused on driving safely. The section covering driver responsibility is essential reading to understand the limitations of safety interventions and warnings. If you find anything unclear or have further questions, do not hesitate to contact your Volvo retailer.

^[1] Distraction alert

^[2] Cross Traffic Alert

^[3] Rear Auto Brake

10.4.1. Collision warnings and mitigation

Your vehicle has warning features designed to reduce the risk of a collision. If a collision cannot be avoided, early warning and response can help reduce its effects.

Collision warning features include:

- Forward collision warnings
- Warnings about vehicles cutting across your lane
- Rear collision warnings

Note

Safety interventions

If a sufficiently urgent risk of collision is identified, the vehicle can intervene to avoid or mitigate the collision without any preceding collision warnings. In this case, the warnings will be shown at the same time as the intervention.

Warning

Never rely on collision warnings or safety interventions by the vehicle as a replacement for safe driving practices. Drive the vehicle with the same attention to safety as you would need to in a vehicle without these features.

Forward collision warnings

Forward collision warnings can occur if you are getting too close to a vehicle in front of you. The vehicle warns you if it identifies a collision risk that requires your immediate attention.

The situation and level of urgency affect how forward collision warnings are communicated. Warnings can be communicated visually in the instrument panel, with sound and with seat belt and brake pulses.

Warnings about vehicles cutting across your lane

Your vehicle can warn you if you are about to be cut off, such as when a vehicle changes lanes just in front of you. Vehicles that swerve or move unpredictably in adjacent lanes can trigger these warnings as well. Your vehicle uses messages in the instrument panel to warn you in these situations.

Rear collision warnings

If your vehicle identifies a situation with a high risk of a rear collision, it can flash its rear lights to warn drivers behind you. Rear collision warnings appear automatically if you slow down suddenly^[1], such as during very hard braking. Warnings can also be provided if your vehicle detects a vehicle rapidly approaching from behind. In this case, you do not need to be slowing down for a warning to appear. Warnings can appear both when you're driving and when stopped, but only if your vehicle detects a sufficiently high risk of collision.

When you are in situations that cause rear collision warnings, your vehicle can pretension your seat belt as a safety measure. If your vehicle is at a standstill, it also applies hard braking as a precaution in case there is an unavoidable rear collision.



Note

Collision response

If a collision cannot be avoided, the vehicle can respond in other ways to protect occupants and reduce the danger to surrounding traffic. Read more about these features in the safety section of this manual.

[1] The rate of deceleration must exceed a certain threshold.

10.4.2. Interventions and warnings when reversing

Your vehicle has specialized features that can intervene and help prevent collisions when you are reversing at low speeds, such as when parking.

Forms of detection

The vehicle has several ways to identify objects that are in or approaching your reversing path. If it detects an object, the vehicle can provide warnings or intervene by braking.

Ultrasonic parking sensors These sensors can identify certain obstacles immediately behind the vehicle when reversing at low speeds.

Rear-facing radar The vehicle's rear radar can detect traffic approaching your reversing path from the sides.

Camera Certain features may use camera detection to help identify obstacles when reversing.



Important

These types of detection have limitations and cannot detect all obstacles in every situation. Be sure to read the separate manual sections about their conditions and limitations.

When you are reversing, some information from the detection systems can be communicated in the parking view.

Warning and intervention features

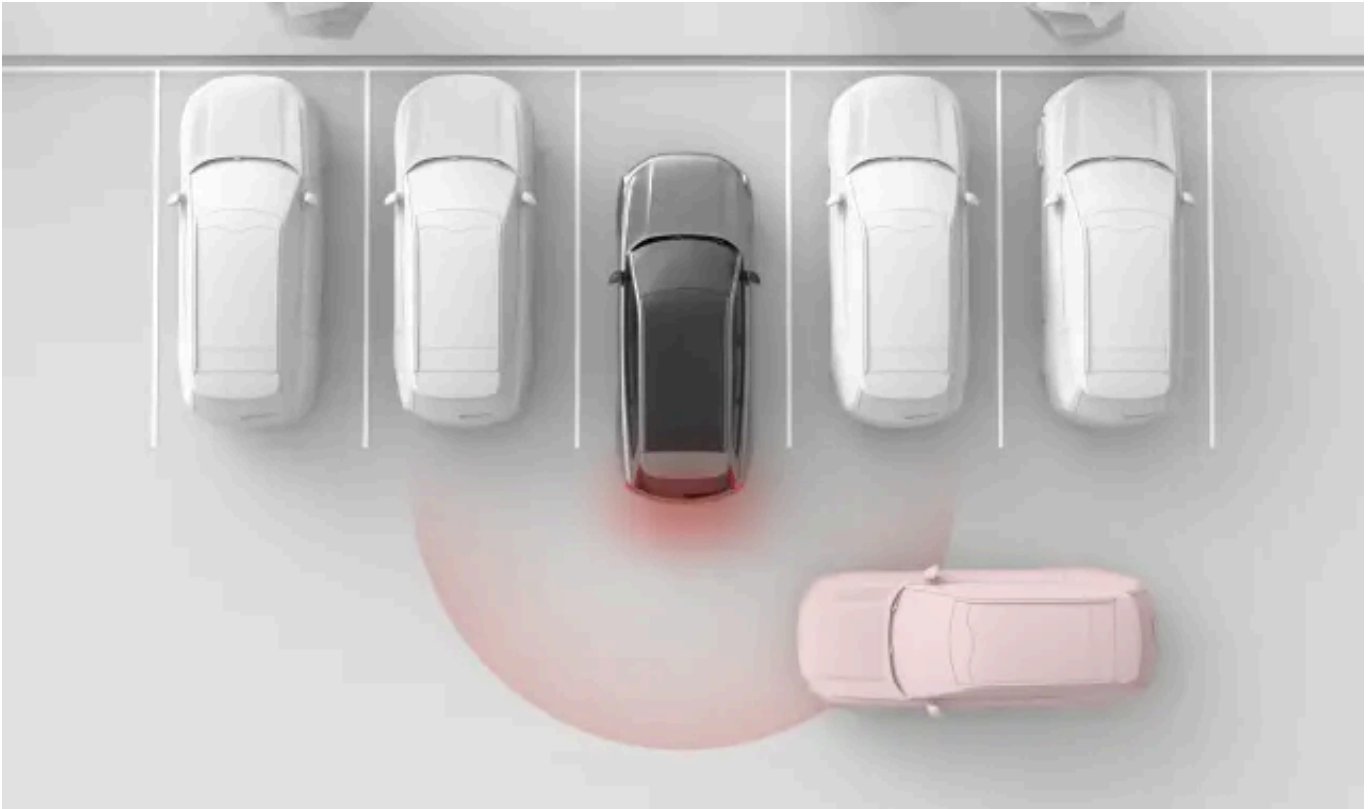

The following features are designed to react when the vehicle identifies a risk of collision when reversing.

Alerts about traffic crossing behind the vehicle^[1]

Your vehicle can provide visual and audible alerts if it detects traffic about to cross your reversing path.

Automatic braking when reversing^[2]

The vehicle can automatically brake to prevent a collision when reversing. This can happen if it detects an obstacle or crossing traffic behind the vehicle.



Tip

Temporary deactivation

The rear auto brake can be temporarily turned off if the interventions are too frequent or distracting. For example, reversing in tall grass or maneuvering in very tight spaces can cause unwanted braking interventions.

 **Important**

Use responsibly

Warnings and interventions when reversing are supplements to safe driving practices. They do not reduce or replace the need for the driver to stay attentive and focused on driving safely.

Pay attention to surroundings

The driver is always responsible for paying attention to the vehicle's surroundings and ensuring that it is safe to maneuver the vehicle.

Detection conditions

If the vehicle deactivates the rear radars, the cross traffic alert and rear auto brake features are automatically disabled. This happens if a trailer is connected. Towbar-mounted accessories that are not connected electrically to the vehicle does not disable the rear radar units but can obstruct them.

Detection of traffic or obstacles behind the vehicle relies on detection by the rear radars. Be sure to read the separate section about the limitations of radar detection.

Conditions for automatic braking

When and how your vehicle performs braking interventions during low-speed reversing depends on whether the detected obstacle is stationary or not.

- If the detected obstacle is moving, such as traffic about to cross your reversing path, automatic braking is available and may intervene when you are reversing at speeds below 15 km/h (9 mph).
- If the detected obstacle is stationary, automatic braking interventions only occur when you are reversing at speeds between 2 km/h (1 mph) and 15 km/h (9 mph). This is to avoid unwanted braking interventions during low-speed maneuvering in tight spaces.

^[1] Cross Traffic Alert (CTA)

^[2] Rear Auto Brake (RAB)

10.4.2.1. Alerts about traffic crossing behind the vehicle

When you're reversing at low speed, the vehicle can warn you if it detects traffic about to pass behind you. This feature is called Cross Traffic Alert.

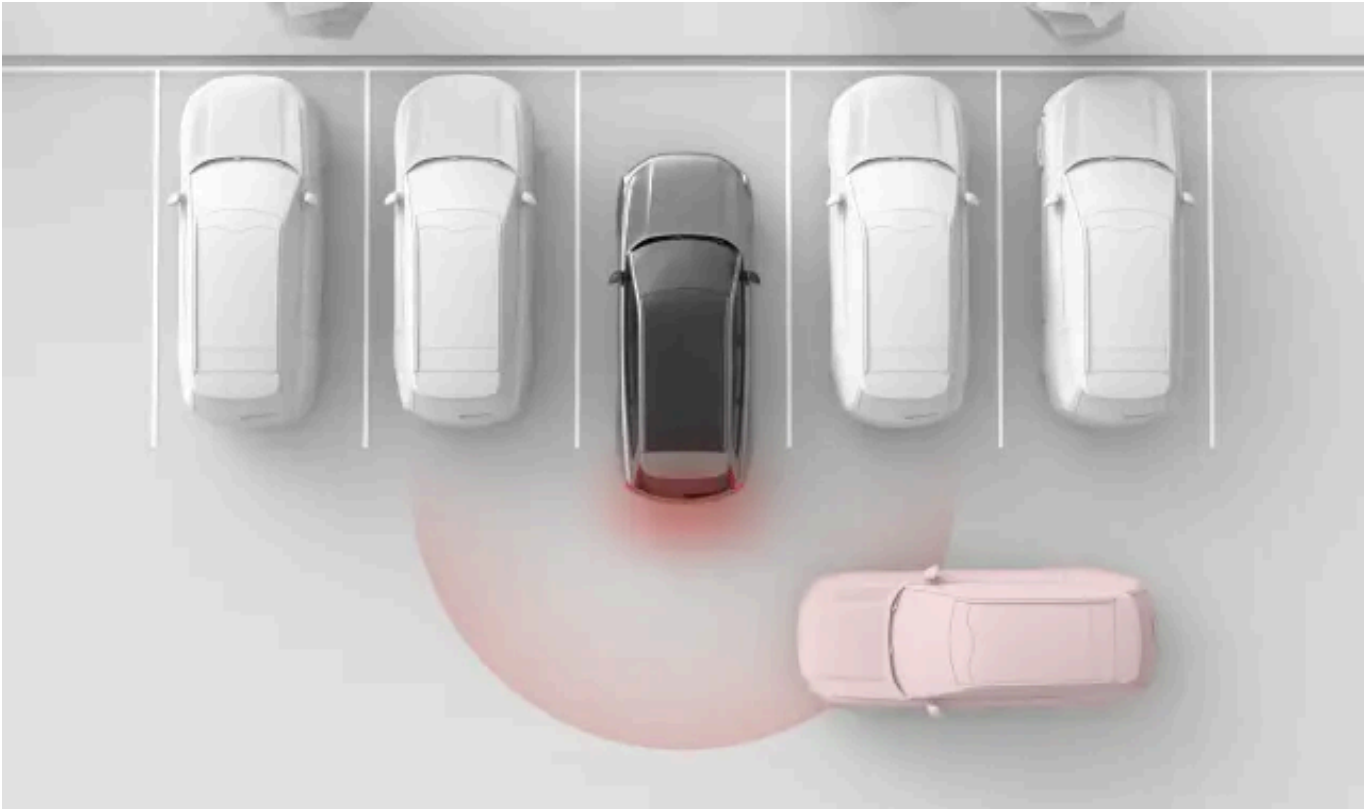

Alerts about traffic crossing behind the vehicle are only available when the vehicle is in reverse (R) or rolling backwards in neutral (N). This feature uses the rear radar to detect traffic. When it detects a moving vehicle, an alert appears in the center display, and you will hear a sound.

This feature is primarily designed for detecting larger vehicles in motion, such as vehicles. In favorable conditions it may also be able to warn you of smaller moving objects, such as cyclists and pedestrians.

! Important

Driver responsibility

Alerts about traffic crossing behind are a supplement to safe driving practices. They do not reduce or replace the need for the driver to stay attentive and focused on driving safely.

i Note

Automatic braking for crossing traffic

If automatic braking^[1] is enabled, the vehicle may also intervene by braking to prevent or mitigate an imminent collision with traffic detected behind you.

Detection zones

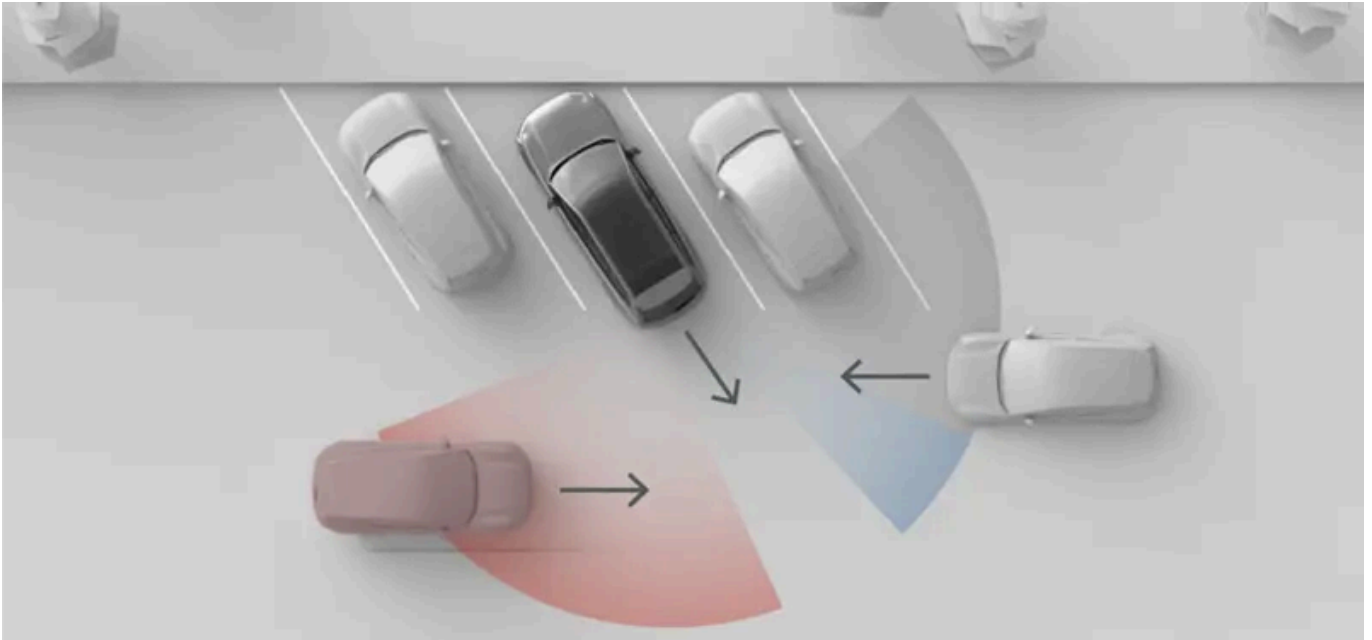

The situation in this image illustrates how surrounding objects such as parked vehicles can limit the vehicle's ability to detect other vehicles and traffic situations. In a situation without obstacles, the effective detection zones are the same on both sides.

Note

Backing out of a parking space

When parked, your rear corner radars' side views might be obstructed, which affects detection of crossing traffic. This happens when you are parked with the back corners of your vehicle further forward in the space than adjacent vehicles or other objects. This effect is particularly noticeable in angled parking spaces. However, as you back out of a parking space, the radar units gradually increase their view, making detection possible. To minimize the risk of delayed or no detection when backing out of a parking space, go slowly.

Conditions and limitations

- The alerts are only available when reversing at speeds below 15 km/h (9 mph).
- If the vehicle deactivates the rear radar units, this feature is automatically disabled. This happens if a trailer is connected. Towbar-mounted accessories that are not connected electrically to the vehicle does not disable the rear radar units but can obstruct them.
- Detection of traffic behind the vehicle relies on detection by the rear radar. Be sure to read the separate section about the limitations of radar detection.

^[1] Rear Auto Brake (RAB)

10.4.2.2. Disabling automatic braking when reversing

The rear auto brake can be temporarily disabled in the parking view.

The content of this manual represents the status of the user manual at the time of printing and may not be completely valid in future instances. For more information refer to the first page for the complete disclaimer note.

When you disable the rear auto brake you cancel your vehicle's ability to perform braking interventions when you are reversing. Disabling the rear auto brake is only temporary. By default, the feature will reset to enabled between drives.

! Important

Changing driver support settings

Make sure that you understand how changing your vehicle's settings affects its behavior. It is particularly important when it comes to features that affect the level of assistance the vehicle can provide.

1. In the parking view, press the rear auto brake button (Ⓜ).
- > Automatic braking when reversing is temporarily disabled.

10.4.3. Lane keeping aid

The lane keeping aid helps prevent accidental high-speed lane departures by providing warnings and steering interventions.

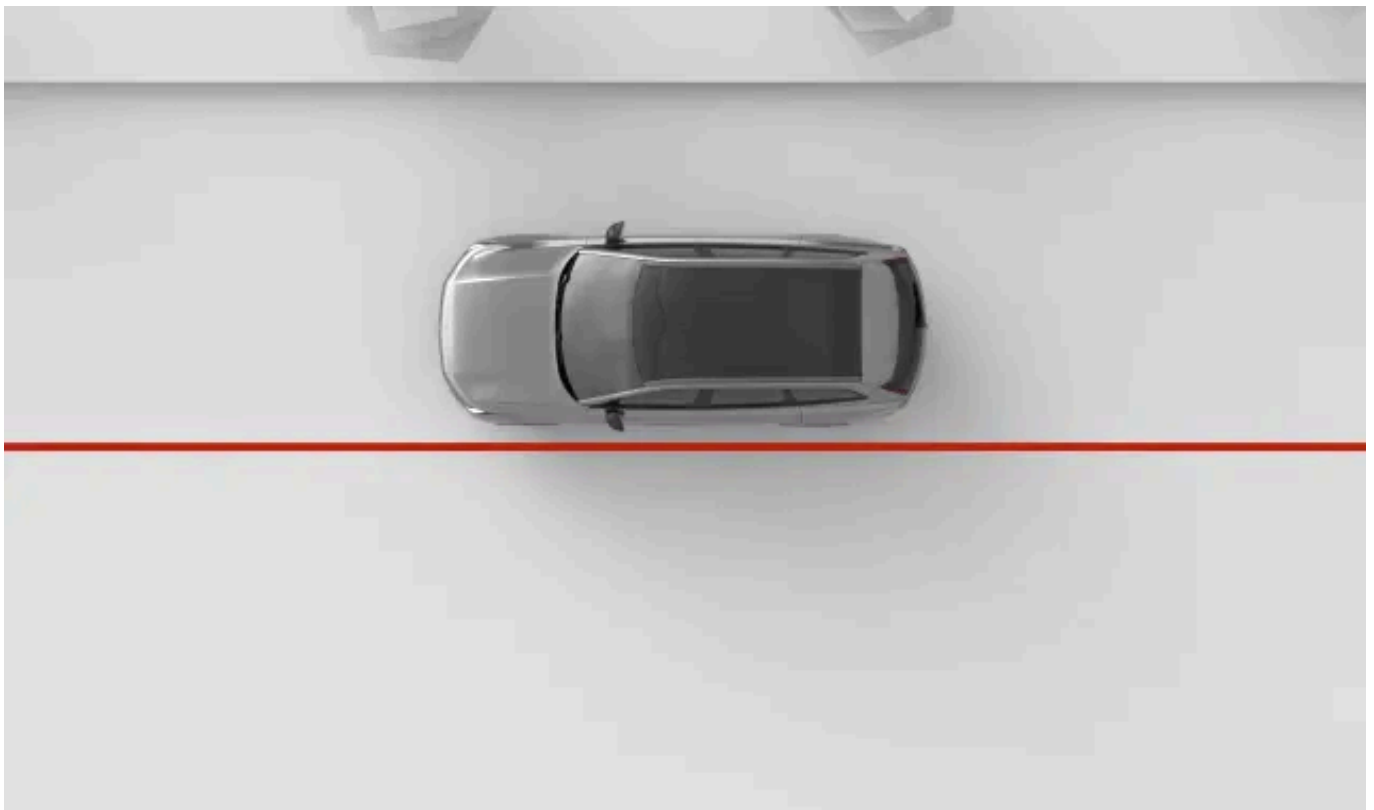

When lane keeping aid is enabled, the vehicle can alert you if you are about to drift out of your lane. It can also perform steering interventions. The lane keeping aid depends on the vehicle's forward-facing camera to identify road markings and your position

in the lane.

Warning

Lane keeping aid warnings and interventions are supplements to safe driving practices. They do not reduce or replace the need for the driver to stay attentive and focused on driving safely. Drive the vehicle with the same attention to safety as you would need to in a vehicle without the ability to intervene.

Main conditions for lane keeping aid

For lane keeping aid to work, several conditions need to be met. The following are the most essential:

- Your speed must be in the 60-180 km/h range (40-110 mph).
- The lane markings must be clearly visible for the vehicle's camera to see.
- The lane must be wide enough. A very narrow lane does not provide enough margin between the vehicle and the road markings.

Important

Steering actively

Never let go of the steering wheel when driving. Do not dismiss the vehicle's requests for you to steer actively and keep your attention on the road.

Lane keeping aid intervention types

Your vehicle can warn you if you are about to cross the boundary markings for your lane or intervene in either or both of the following ways:

Steering intervention The vehicle tries to steer back into the lane and alerts you with either a symbol or a message in the instrument panel.

Lane departure warning The vehicle alerts you with a symbol in the instrument panel and steering wheel vibrations.

Note

Signaling a turn or lane change

As long as you use the turn signals when changing lanes, the vehicle assumes that you are making an intentional maneuver.

Cutting a corner

The lane keeping aid may allow you to briefly cut across the lane marker while navigating a sharp corner.

Safety interventions are always enabled

Some situations can cause a steering intervention to prevent a dangerous lane departure even if lane keeping aid is turned off in settings.

Display symbols and communication

The content of this manual represents the status of the user manual at the time of printing and may not be completely valid in future instances. For more information refer to the first page for the complete disclaimer note.

Lane keeping aid warnings and interventions are communicated in the instrument panel.



This symbol appears if you are coming too close to the lane markings. The symbol is mirrored during left-side warnings.



This symbol indicates that lane keeping aid is disabled in settings or temporarily unavailable.



This symbol appears when there is a lane keeping aid malfunction. This means that lane keeping aid and safety interventions to prevent lane departures are disabled.

When the instrument panel shows surround display mode, lane keeping aid's status and actions are shown as animations and with symbols.

 **Important**

Using surround mode

Surround mode cannot perfectly depict what is really happening on the road around you, so do not rely on it when you are driving.

Conditions and limitations

For lane keeping aid to work, road markings must be present and visible. The vehicle identifies them using a forward-facing camera. This form of detection requires the camera view to be unobstructed and the conditions for visual detection to be present. Read the separate section about the conditions and limitations of your vehicle's cameras to understand how features relying on camera detection are affected.

The appearance, condition and layout of road markings can affect their detection in the following ways:

- Lane splits and merges can cause temporary misidentification of the lane.
- Non-standard or unusual road marking layouts might not be identified correctly by the vehicle. For example, road work or traffic diversions can result in conflicting or multiple sets of road markings.
- The vehicle may be unable to detect deteriorated road markings: for example, if they are worn, misshapen or discolored.
- Other edges or lines can be misidentified as road markings, such as curbs, road surface repair edges, barriers or well-defined shadows.
- Road markings must be sufficiently illuminated to be detected. In low-light conditions, they need to be illuminated by the vehicle or street lights.

10.4.3.1. Adjusting lane keeping aid

You can adjust or disable lane keeping aid in settings.

When lane keeping aid is enabled, the vehicle can alert you or intervene by steering if you are about to drift out of your lane. You can also adjust the vehicle's response to lane departures.

The available settings are:

Vibration The steering wheel vibrates if you drive too close to or over the lane markings.

Steering and vibration In combination with steering wheel vibrations, your vehicle will try to steer you back into your lane if you drive too close to or over the lane markings.

You can disable lane keeping aid in settings. This can be useful if the road markings are partially obscured or faded, which can cause unwanted warnings.

 **Important**

Changing driver support settings

Make sure that you understand how changing the vehicle's settings affects its behavior. It is particularly important when it comes to features that affect the level of assistance the vehicle can provide.

1. Press the vehicle symbol  in the bottom bar and go to **Settings**.
2. Go to **Driving** → **Safety assistance** → **Lane keeping aid**.
3. Adjust lane keeping aid. If you have previously disabled lane keeping aid, you must first re-enable it before you can adjust its response to lane departures.

 **Note**

Disabled

A symbol is shown in the instrument panel when lane keeping aid is disabled.



Safety interventions

Some situations, such as when you are about to cross a solid line or if you show signs of inattentiveness, can cause a steering intervention to prevent a dangerous lane departure even if lane keeping aid is turned off in settings.

10.4.4. Blind spot information

The blind spot information feature helps increase your awareness of vehicles in or approaching your blind spots. A light appears in the door mirror when a vehicle is detected.

Blind spot alerts can increase your awareness of vehicles to the side of your vehicle, which can help you avoid making dangerous lane changes. The alerts primarily appear as a light in the door mirror on the side of detection. They rely on your vehicle's rear radar units for detection of vehicles in adjacent lanes.

Traffic situations in which blind spot alerts appear include:

The content of this manual represents the status of the user manual at the time of printing and may not be completely valid in future instances. For more information refer to the first page for the complete disclaimer note.

- When you are being overtaken by another vehicle.
 - In some cases, they can appear before the passing vehicle reaches your blind spot. This happens if a vehicle is approaching quickly from behind in an adjacent lane.
- When you are overtaking another vehicle.

Regardless of the situation, the alert remains as long as the other vehicle is detected to your side.

If you start signaling a lane change while an alert is being shown, the alert will intensify.

Alerts in the door mirrors



When a vehicle is detected in or approaching your blind spot, a light appears in the door mirror.

Communication in the instrument panel

When the instrument panel shows surround display mode, blind spot information can be communicated using animations.

! Important

Using surround mode

Surround mode cannot perfectly depict what is really happening on the road around you, so do not rely on it when you are driving.

Detection areas

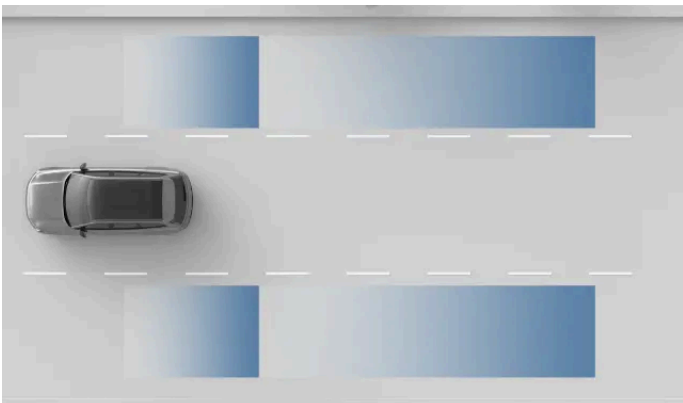

Radar detection areas.

! Important

The detection areas may not perfectly cover your own blind spots. Be sure to adjust your driving posture to allow for a good overview of surrounding traffic.

Conditions and limitations

- Blind spot information is active at speeds above 10 km/h (6 mph). It is not available when reversing.
- When passing other vehicles, the speed difference between your vehicle and the other vehicles must be below 15 km/h (9 mph) for the alerts to appear.
- Blind spot information relies on detection by the rear radar units. Be sure to read the separate section of this manual about the limitations of radar detection.
- If the rear radar units are obstructed, such as by an attached trailer or mounted bike rack, blind spot alerts are automatically disabled.

! Important

Driver responsibility

Alerts about vehicles in the blind spots are a supplement to safe driving practices. They do not reduce or replace the need for the driver to stay attentive and focused on driving safely.

The lack of a blind spot indication is not a confirmation that it is safe to change lanes. It is one of several pieces of information that inform your assessment of whether it is safe to proceed.

10.4.5. Door opening alerts

Door opening alerts are designed to make exiting your vehicle safer. They can warn you of traffic approaching from behind so that you don't open a door in its path.

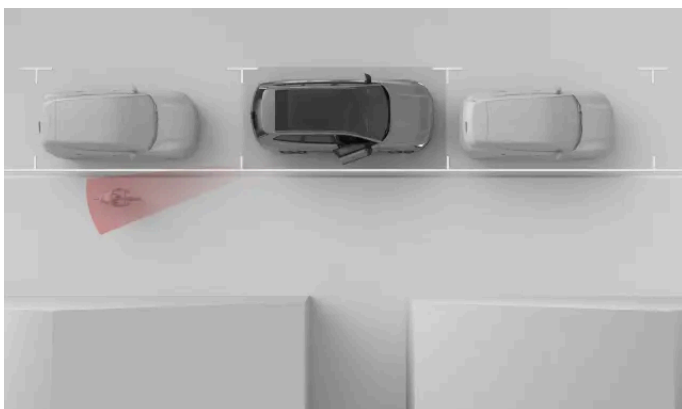

Door opening alerts are designed to warn you of passing traffic so that you don't open a door in its path. These alerts can be provided when the vehicle is stationary or moving very slowly^[1].



When the vehicle detects traffic that is about to pass close to the sides, a light appears in the door mirror. If you begin to open the door on the side of the detected traffic, the alert intensifies. An audible alert can occur along with the visual alerts, depending on how urgent the warning is.

i Tip

Door opening alerts and blind spot information

Door opening alerts are indicated in a similar way to alerts about vehicles in your blind spot. These two features also rely on the same rear radar units to detect traffic.

Limitations

The vehicle uses its rear radar system to detect approaching traffic. Be sure to read about radar and detection conditions and limitations in their separate section of the manual.

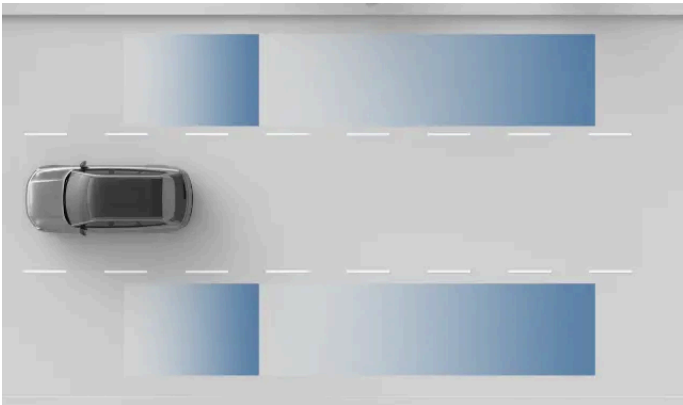

Radar detection areas.

! Important

Door opening alerts are supplements to safe user practices. The driver and passengers are fully responsible for making sure that the vehicle doors can be safely opened.

^[1] Below 3.6 km/h (2.2 mph)

10.4.6. Driver alert

The vehicle continuously observes your behavior while driving and can notify you if you seem unfocused. A lack of focus can be caused by distractions or being tired.

If the vehicle identifies signs of reduced driver focus, it will notify you with a sound and a message. The type of message depends on whether you seem tired or distracted. If you ignore the message and continue to behave the same way, the warnings will escalate. Unresponsiveness can ultimately result in the vehicle slowing down to perform an emergency stop maneuver.

The vehicle uses different methods to assess your focus when driving.

Attention tracking Camera tracking of your face and eye movements allows the vehicle to determine where you are directing your attention.

Maneuvering Analyzing the way you maneuver the vehicle can provide an indication of lacking focus. One example of this is excessive lane drifting.

Distraction alerts

Your level of attentiveness while driving is continuously monitored by your vehicle's internal cameras. If you seem inattentive or distracted, the vehicle can alert you of this via messages in the instrument panel. The alerts disappear only after your vehicle detects that you are attentive again. If you do not regain an acceptable level of attention and focus on your driving, the alerts can escalate to warnings. If your vehicle finds you to be unresponsive for a certain amount of time, it can stop automatically within its current lane.



Distraction alert notifications can be turned off in settings.



Distraction alert notifications are enabled by default every time you activate Pilot Assist with steering assistance.

Alerts about a tired or drowsy driver

Your vehicle monitors certain aspects of your driving as well. Certain driving patterns, such as excessive lane drifting, may provide indications that the driver is tired or drowsy.

If the vehicle identifies signs of tiredness or drowsiness, it will notify you with a sound and a message in the instrument panel. These alerts cannot be disabled in settings.



 **Warning**

The importance of a well-rested driver

Take any notifications about signs of driver tiredness seriously, as a tired driver is often unaware of their condition. If you feel tired or get an alert about it from the vehicle, stop as soon as possible in a suitable location for a rest. Always plan for regular breaks and start all trips with a well-rested driver.

Driving while tired is comparable to driving under the influence of alcohol.

Conditions and limitations

- Attention tracking requires an unobscured view of the driver's face.
 - Improperly stowed items can obscure the view of the driver, as can dust and dirt on the camera lens. Keep the driver's space clean and clutter-free.
 - Wearing certain clothing and accessories can obstruct parts of the driver's face that need to be visible for attention tracking, such as the eyes.
- Certain conditions can affect how well your vehicle can assess your driving and maneuvering. This, in turn, affects how well it can distinguish signs of an unfocused or tired driver.
 - Features that help with lane placement can sometimes compensate for maneuvering that would otherwise indicate a lack of driver focus. This makes it harder to identify signs of poor focus compared to unassisted driving.
 - Conditions such as strong winds or uneven road surfaces can affect your driving in ways similar to being unfocused. This can potentially cause warnings despite having a fully focused driver behind the wheel.

Read the separate section about conditions and limitations of your vehicle's driver behavior detection system and cameras to understand how features relying on these systems are affected.

 **Important**

Driver responsibility

Alerts about poor focus when driving are a supplement to safe driving practices. The driver is fully responsible for making sure they are able to stay alert and maintain focus when driving.

10.4.6.1. Disabling distraction alert notifications

You can disable or enable distraction alert notifications in settings.

You cannot disable alerts concerning driver tiredness or drowsiness.

 **Warning**

The importance of a well-rested driver

Take any notifications about signs of driver tiredness seriously, as a tired driver is often unaware of their condition. If you feel tired or get an alert about it from the vehicle, stop as soon as possible in a suitable location for a rest. Always plan for regular breaks and start all trips with a well-rested driver.

Driving while tired is comparable to driving under the influence of alcohol.

 **Note**

Driver responsibility

Alerts about poor focus when driving are a supplement to safe driving practices. They do not reduce the driver's responsibility to continuously assess whether they are too tired or unfocused to drive safely.

1. Press the vehicle symbol  in the bottom bar and go to **Settings**.
2. Go to **Driving** → **Safety assistance** → **Distraction alert**.
3. Turn distraction alert notifications on or off.

 **Important**

Distraction alert notifications are enabled by default every time you activate Pilot Assist with steering assistance.

10.4.7. Connected safety

Your vehicle can communicate information with other vehicles on the road, which can help you to be aware of or avoid accidents or traffic situations further up the road. This feature is called connected safety.

Through an internet connection, your vehicle and other vehicles on the same road can share information about current road conditions and situations, such as:

- activated hazard warning flasher
- accidents
- slippery roads
- roadwork
- large animals
- pedestrians and bicycles.^[1]

Connected safety can be enabled or disabled in privacy settings.

 **Warning**

Connected Safety is not a replacement for safe driving practices. Drive the vehicle with the same attention to safety as you would in a vehicle without this feature.

Connected safety warnings

Depending on the information your vehicle receives from other road users about situations further up the road, one of these symbols can be shown in the instrument panel:



A vehicle's hazard warning flasher is active. This symbol also appears when there is road work, large animals, pedestrians and bicycles.



Slippery road conditions are detected.



An accident has happened.

 **Tip**

Warnings from connected safety can also be shown in the head-up display.

Conditions and limitations

For Connected Safety to work, these conditions need to be met:

- Connected Safety must be enabled in settings.
- Other vehicles need to have connected safety available and enabled.
- Both your vehicle and other vehicles must be connected to the internet.
- The road you're on is in the Volvo Cars database.

 **Note**

Slippery road conditions not registered

A slippery road may not always trigger a warning from Connected Safety. Low friction between the tires and road surface is often used to identify a slippery road. Maneuvers such as braking or accelerating rarely cause low-friction situations. As a result, the feature may not always detect a slippery road during these maneuvers.

^[1] This feature aims to notify you of unexpected pedestrians and bicycles that could cause a hazard, such as on a highway.

10.4.7.1. Enabling connected safety

You can enable or disable connected safety in settings.

Connected safety can warn you of upcoming situations on the road you're on, such as another vehicle with their hazard warning lights activated or slippery road conditions. The feature relies on communication with other road users via internet connection.

Important

Increased data transfer

Enabling connected safety increases the amount of data transferred to and from your vehicle.

Changing driver support settings

Make sure that you understand how changing your vehicle's settings affects its behavior. It is particularly important when it comes to features that affect the level of assistance the vehicle can provide.

1. Press the vehicle symbol  in the bottom bar and go to **Settings**.
2. Go to **Privacy** → **Connected safety**.
3. Enable connected safety.

10.4.8. Emergency stop assist

In situations where the driver is unable to continue driving, the vehicle can perform a controlled stop to reduce the risk of a collision.

If the vehicle determines that the driver is unresponsive for a certain amount of time, it can automatically come to a stop within the current lane. This can help avert an accident if the driver suffers a medical emergency while driving, for example.

The vehicle initiates a controlled stop if the driver doesn't respond to requests to actively drive the vehicle. These requests can come from the driver alert feature if the driver is unfocused or shows signs of being too inattentive to drive safely. They may also be related to the driver not keeping their hands on the steering wheel.

Tip

Emergency stops are performed if the vehicle finds the driver to be unresponsive for a certain amount of time. You can always override the stop maneuver by actively steering, braking or accelerating. This indicates that you are attentive again and available to continue the drive.

During the stopping maneuver, the vehicle utilizes all of the information it continuously collects about its surroundings to come to a controlled stop in the lane of the road you're on. It also activates the hazard lights to warn other drivers.

If the driver is able to respond after the safe stop maneuver completes, they should move the vehicle to a safe spot where it does not pose a traffic hazard.

Emergency assistance

In the event of an emergency stop, your vehicle can automatically connect you to an emergency call center.^[1] You can read more about emergency assistance in a separate section of the manual.

Warning

- Driving interventions such as controlled emergency stops are supplements to safe driving practices. They do not reduce or replace the need for the driver to stay attentive and focused on driving safely.
- Do not intentionally trigger an emergency stop maneuver if it is not absolutely necessary for stopping safely.

Conditions and limitations

Your vehicle's driver behavior detection system constantly monitors the driver's actions. It relies on interior cameras to keep track of eye movement, attention, drowsiness and whether the driver's hands are on the steering wheel. Emergency stop assist uses information from this system to identify driver actions and decide when an emergency stop is necessary. It is therefore important not to try to trick the behavior monitoring system or cover the cameras.

Emergency stop assist relies on information from the radar and camera units to identify the vehicle's surroundings and perform a safe stop. Read the separate sections about the conditions and limitations of your vehicle's driver behavior detection system, cameras and radar units to understand how features relying on these kinds of detection are affected.

Important

Vehicle faults

If emergency stop assist is unavailable due to a driver support system fault, a message telling you to book a service is shown in the instrument panel. Contact an authorized Volvo workshop if a fault is indicated in this way or another.

Vehicle alterations

Modifications, repairs and accessory installations can negatively affect or limit driver support features. There is a separate manual section with detailed information on this topic.

^[1] The availability of this feature may differ between regions.

10.5. Assisted driving

Assisted driving features use the vehicle's ability to monitor its surroundings to make driving safer and less demanding.

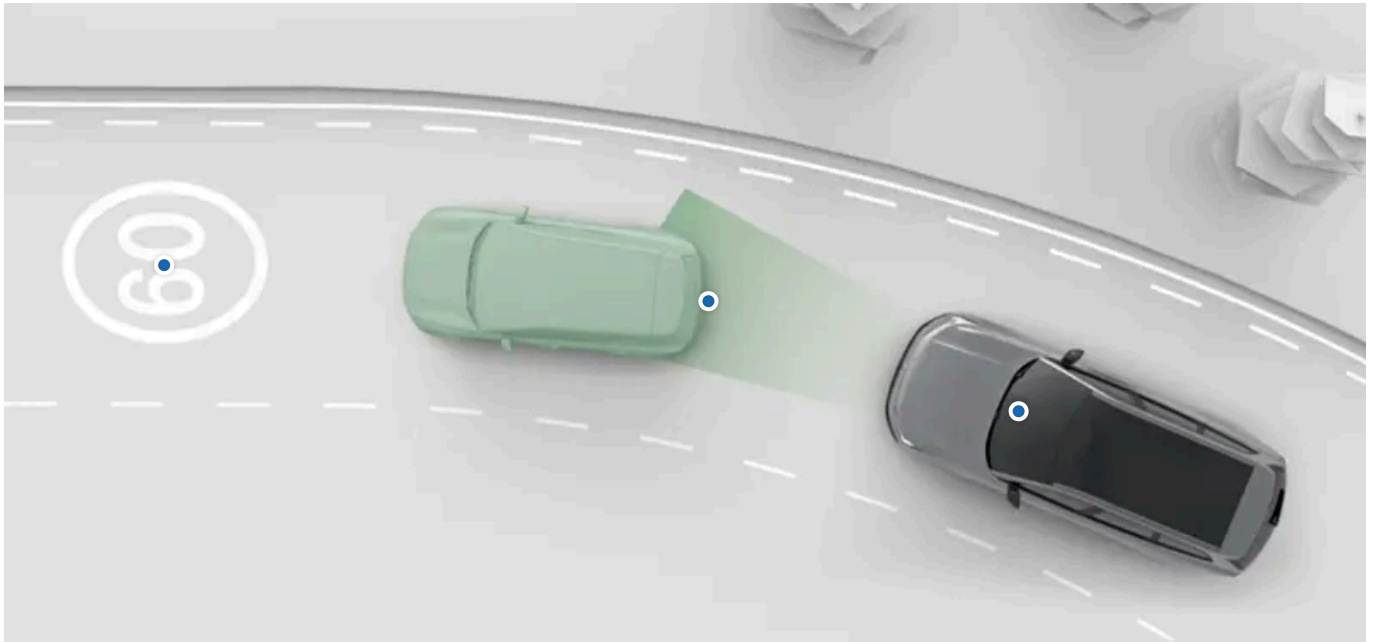

There are several forms and levels of assistance. They can actively assist you with a number of driving tasks and provide informational support for better driver decision-making.

You can enable, disable or customize many of your vehicle's assisted driving features in settings.

Pilot Assist	This feature can assist you in several driving tasks, such as steering, managing speed and changing lanes. Pilot Assist can be customized in settings.
Road signs and speeding response	Several features can assist you with keeping track of the speed limit and preventing unintentional speeding. They include road sign information, which makes you aware of the speed limit, and different responses from the vehicle designed to prevent you from exceeding the speed limit. These features can be customized in settings.



Tip

Safety interventions and warnings

Many of the driver support features are designed to improve both convenience and safety. Features that primarily provide safety interventions and warnings have their own, separate section in this manual.

Assisted parking

There is a separate section of this manual covering assisted parking features.

 **Important**

Required knowledge and driver responsibility

Assisted driving features are designed to make driving safer and less demanding, but they do not reduce the driver's responsibility to operate the vehicle as safely as possible. Be sure to read all related information about a feature before using it. The section covering driver responsibility is essential reading to understand the capabilities and limitations of your vehicle's assisted driving features.

If you find anything unclear or have further questions, do not hesitate to contact an authorized Volvo workshop.

Detection capabilities

The vehicle's ability to monitor its surroundings is used by assisted driving features. To better understand the limitations of such features, read the separate section about detection of traffic and surroundings. It provides an overview of how important components work, such as cameras and radar units, by detailing both capabilities and limitations.

10.5.1. Road signs and speeding response

Several features can assist you with keeping track of the speed limit and preventing unintentional speeding.

To help you maintain a legal speed, your vehicle is designed to make you aware of the current speed limit by showing it in the instrument panel. It can also respond with warnings if you exceed the speed limit.

Road sign information The vehicle can detect and display information from road signs, such as the speed limit.

Speed limit warnings This feature will warn you visually and with sound if you exceed the speed limit.

 **Important**

Speed-related information and warning features are supplements to safe driving practices. They do not reduce or replace the need for the driver to stay attentive and focused on driving safely. It is the driver's responsibility to observe and maintain a legal and safe speed.

10.5.1.1. Speed limit warnings

Speed limit warnings can be provided to help prevent unintentional speeding.

Speed limit warnings can be provided when you exceed the speed limit. You can enable or disable these warnings in settings.

When enabled, the warnings appear visually in the instrument panel. You can adjust the visual warnings to be accompanied by an audible alert, and you can set a speed offset so that they occur at a higher threshold above the speed limit. This is done in settings.

Conditions and limitations

The content of this manual represents the status of the user manual at the time of printing and may not be completely valid in future instances. For more information refer to the first page for the complete disclaimer note.

Speed limit warnings use road sign information to keep track of the speed limit. If information about the speed limit is unavailable for some reason, no warning can be provided.

For speed limit warnings to occur, road sign information must be enabled in settings.

 **Important**

Driver responsibility

Speed limit warnings are supplements to safe driving practices. They do not reduce or replace the need for the driver to stay attentive and focused on driving safely. It is the driver's responsibility to observe and maintain a legal and safe speed.

10.5.1.1. Adjusting speed limit warnings

Speed limit warnings can be enabled, disabled and customized in settings.

The following options are available:

- Visual** The speed limit symbol in the instrument panel flashes if you exceed the speed limit.
- Audio and visual** An audible alert accompanies the visual alert if you exceed the speed limit.
- Offset from speed limit** Allows you to set an offset for the warnings so that they occur at a higher threshold above the speed limit.

You can also disable speed limit warnings.

1. Press the vehicle symbol  in the bottom bar and go to **Settings**.
2. Go to **Driving** → **Safety assistance** → **Speed limit warnings**.

 **Note**

Road sign information must be enabled to access the settings for speed limit warnings.

3. Choose one of the available speed limit warning options.
- > After enabling speed limit warnings, you can also choose an offset for the speed limit.

10.5.1.2. Road sign information

The vehicle can identify and display road signs as you pass them, allowing you to keep track of the speed limit. This feature combines direct detection of signs with sign information from map data.

The signage symbols shown in the instrument panel come from two different sources: real-world signs identified by the camera and map data. The vehicle automatically prioritizes which source to use depending on the situation.

The vehicle can only show signs that are part of the vehicle's sign library.

You can enable or disable road sign information in settings.

How signs are shown

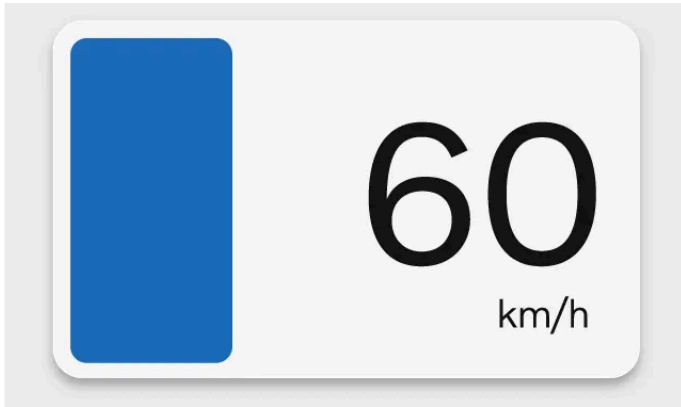

How the road sign symbols appear may depend on the current instrument panel mode.

The vehicle can simultaneously display several sign types. This can include the current speed limit, along with a warning sign or an additional traffic information sign. When driving with Pilot Assist, the vehicle can also display an upcoming speed limit.

Detected road signs appear next to the speedometer in the instrument panel.

Displayed road signs

This list contains examples of road sign types that can be shown in the vehicle.

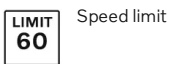

Note

Symbol availability

Road signs available to display in your vehicle can change over time and vary between regions. The selection presented in this manual may not include every sign that can appear in your vehicle's display.

Symbol design

Road sign styles vary between regions. The symbol style displayed by the vehicle will not exactly match the symbol style on signs you encounter. If you have any issues interpreting a displayed sign despite the information provided in this manual, contact Volvo support.

Road sign display times

The content of this manual represents the status of the user manual at the time of printing and may not be completely valid in future instances. For more information refer to the first page for the complete disclaimer note.

The sign display time typically depends on the type of sign and whether you pass additional signs. Road signs can be shown in the following ways:

- Briefly as one-time alerts after passing a sign.
- Until the sign no longer applies.
- Until you pass another sign with higher display priority.

 **Note**

Lingering signs

The vehicle might fail to identify a sign indicating the end of a traffic limitation. If this happens, a symbol for the previous limitation can linger in the instrument panel. It will eventually be replaced or canceled. In the meantime, drive according to the applicable rules of the road.

Conditions and limitations

 **Important**

Driver responsibility and road signs

Road sign information is designed to help manage information while driving. It is a supplement to safe driving practices. The driver is fully responsible for remaining attentive, keeping track of road signs and following local regulations. Do not prioritize the vehicle's road sign detection over your own observations if they conflict.

Why all signs are not shown

The vehicle cannot detect and show every sign that is relevant to the driver.

- The system does not support all types of signs.
- Signs may go undetected in certain conditions and traffic situations.

Conditions affecting road sign detection or identification:

- Road sign information must be enabled in settings.
- The vehicle's forward-facing camera must be clean and free of obstructions.
- The road sign must be clearly visible and properly illuminated.
- The road sign must be within a certain distance and within the camera's field of view.
- The vehicle may not be able to identify misaligned road signs, such as signs placed too high or at an angle.
- The vehicle may not be able to identify damaged or worn road signs.

Conditions affecting sign information from map data:

- An internet connection is required to download map data that contains information about road signs.
- The coverage of road sign information from map data varies between regions.

Note

For consistent and up-to-date road sign information in your vehicle, be sure to accept Google's Terms of service. Contact an authorized Volvo workshop if you experience any issues with the road sign information feature.

10.5.1.2.1. Enabling road sign information

Your vehicle can show available road signs and traffic information in the instrument panel. You can enable and disable road sign information in settings.

1. Press the vehicle symbol  in the bottom bar and go to **Settings**.
2. Go to **Driving** → **Safety assistance** → **Road sign information**.
3. Enable or disable road sign information.

When using Pilot Assist with **Adapt to speed limit** enabled, speed limit signs will still be shown in the instrument panel after disabling road sign information.

10.5.2. Pilot Assist

Pilot Assist combines several support capabilities to make driving safer, more convenient and less demanding. It can assist you with speed management and steering guidance in a wide variety of situations.

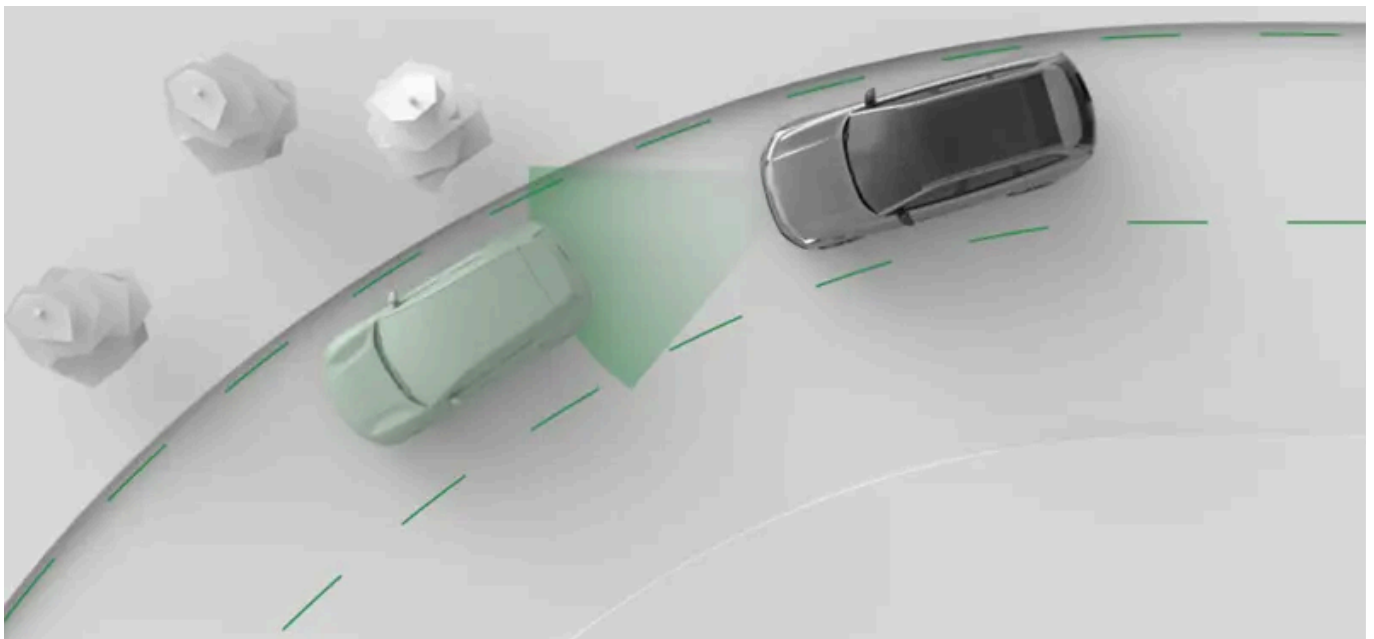

Pilot Assist actively guides your driving in a number of ways. When driving with Pilot Assist, you select the target speed. The vehicle then manages acceleration and braking to meet that target while also adapting to surrounding traffic.

It's also capable of steering assistance. When enabled, steering assistance helps with road positioning by guiding your steering wheel movement.

 **Important**

Before using Pilot Assist

Take the time to read everything the manual has to say about Pilot Assist before using it. Understanding its capabilities and limitations is necessary for safe use.

The driver is in control

When using Pilot Assist, you are still in control of the vehicle. It's your responsibility to continuously assess Pilot Assist's performance. As long as you judge its input to be correct, you can let it guide your driving.

 **Tip**

Customize Pilot Assist

Some of Pilot Assist's capabilities can be customized either in the Pilot Assist settings or by using the steering wheel buttons. This allows you to set it up for the level of support you want.

Managing speed and distance to vehicles ahead

When you activate Pilot Assist, a set speed value appears next to the speedometer. This represents the target speed that Pilot Assist tries to maintain. You can adjust the set speed with the steering wheel buttons.

When **Adapt to speed limit** is enabled in settings, Pilot Assist can adapt the set speed to changes in the speed limit. When the speed limit changes, the new speed limit appears as a suggested set speed in the instrument panel for you to confirm.

If your vehicle detects a vehicle ahead that's either slower than you or a bit too close, Pilot Assist will slow down to maintain a certain distance to the vehicle in front. Once the road ahead becomes clear again, your vehicle returns to the target speed. You can adjust the general distance to vehicles ahead in settings.

Steering assistance

The availability of active steering assistance depends on the conditions you are experiencing. For example, if you encounter a stretch of road with worn-out markings, the vehicle may temporarily turn steering assistance off and tell you to steer the vehicle unassisted by Pilot Assist. As soon as the necessary conditions are met again, steering assistance reactivates.

Steering assistance can be enabled in Pilot Assist's settings or using the steering wheel buttons if you are driving.

Pilot Assist features and settings

There are a number of Pilot Assist capabilities and settings to read about in this manual.

Steering assist	When driving with steering assistance, your steering is actively guided. This can help you maintain correct lane positioning.
Lane change assist	Guides lane change maneuvers initiated by the driver.

Curve speed assist	Driving speed is adapted ahead of known road features such as curves and roundabouts. You can always override this by pressing down on the accelerator pedal.
Adapt to speed limit	If the speed limit changes, the new speed limit appears as a suggested set speed in the instrument panel for you to confirm.
Time interval to vehicle ahead	Adjust the target time interval to the vehicle ahead. This way, you can adjust the distance to vehicles in front of you.

Status and availability

Pilot Assist's availability depends on the current driving conditions and is indicated in the instrument panel. You can always see the current level of support you're getting from Pilot Assist in the instrument panel.

Note

Pause

In some situations, Pilot Assist can be temporarily paused. This can happen when a driver decision is needed to resume driving with Pilot Assist, such as after coming to a stop. When Pilot Assist is paused, the instrument panel will typically display a message with instructions for resuming.

Pilot Assist uses map data provided by Google. Not accepting Google's terms and conditions limits the availability and performance of Pilot Assist. You can manage your consent in privacy settings via the center display.

10.5.2.1. Pilot Assist video guide

Watch the Pilot Assist video guide to learn more about Pilot Assist.

You can watch the video guide to get a good understanding of how the Pilot Assist feature works, when to use it and how to adjust some of its settings. However, the video guide doesn't include all the information you need to know to be able to use Pilot Assist safely and correctly. Make sure you read everything about Pilot Assist in the user manual before using the feature.

American English

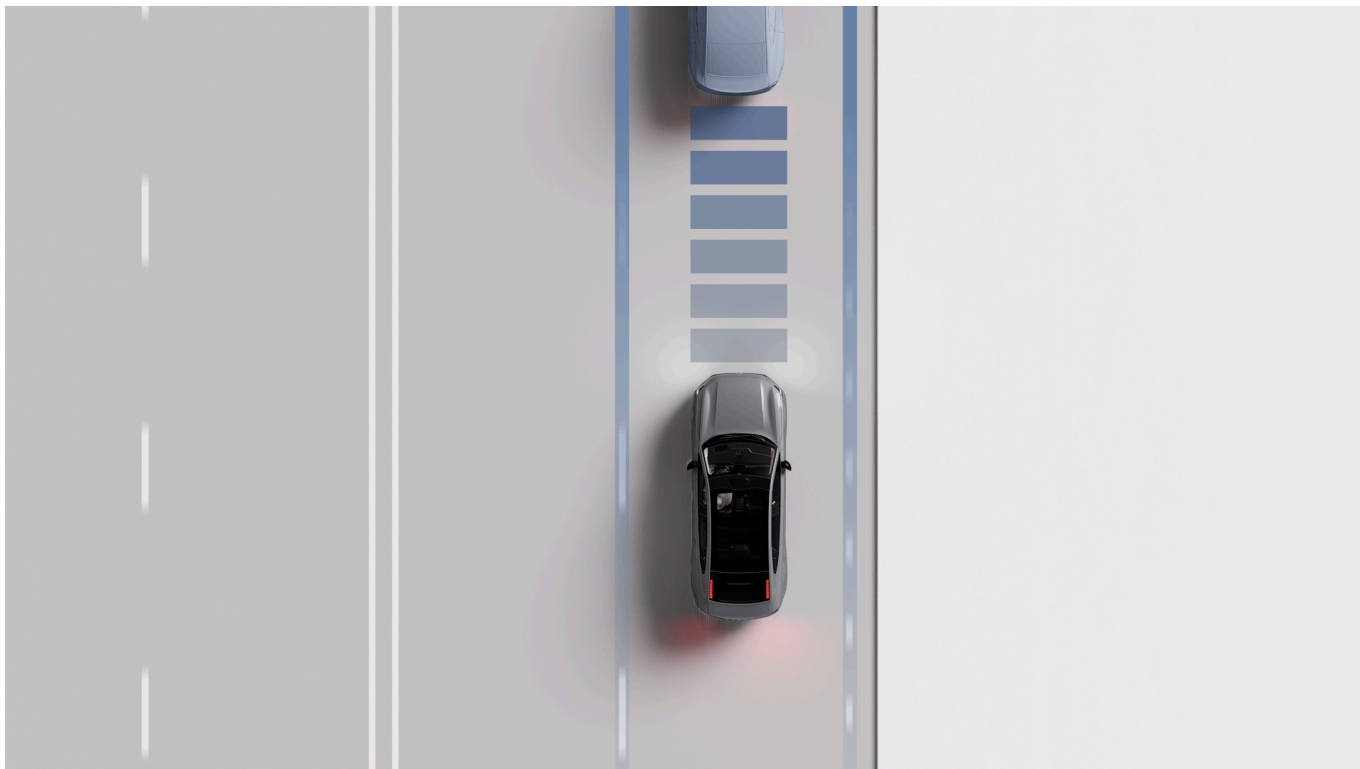

Spanish

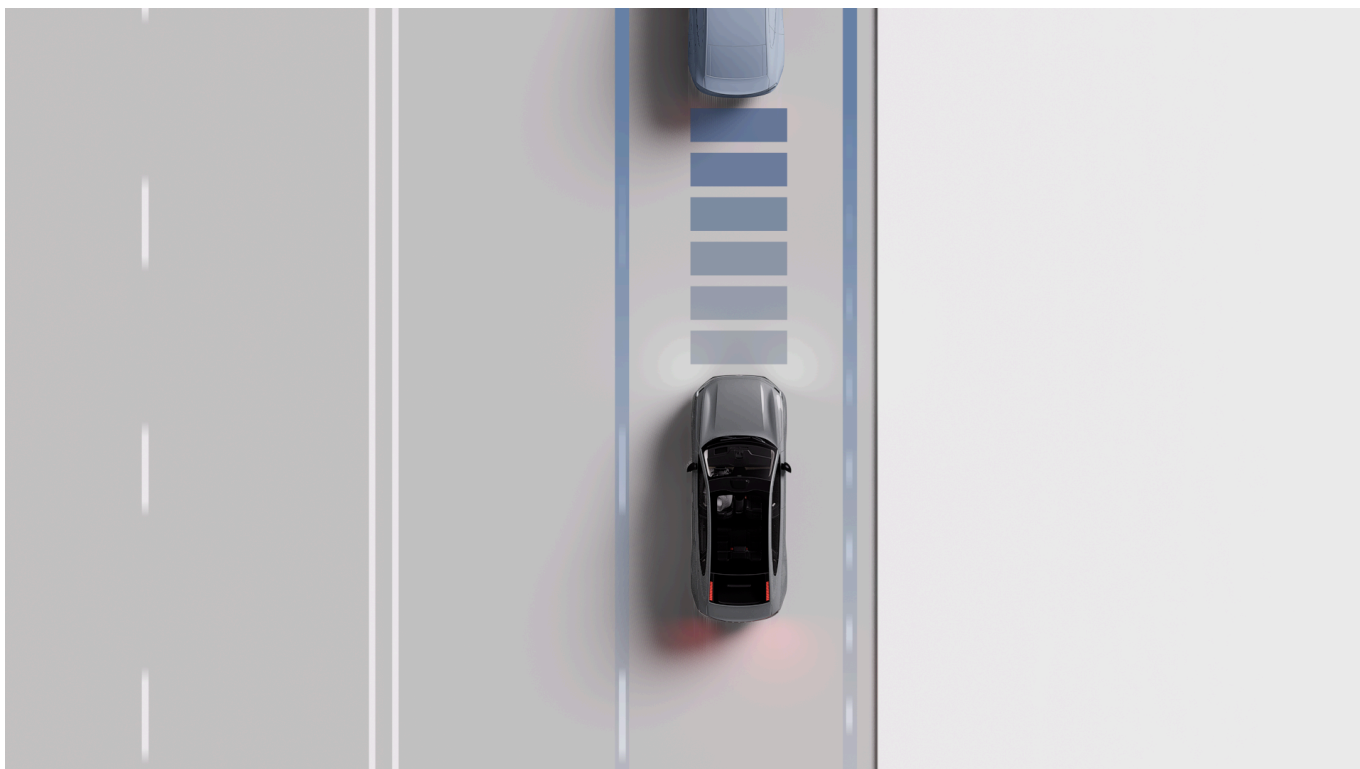

10.5.2.2. Pilot Assist communication and status

The content of this manual represents the status of the user manual at the time of printing and may not be completely valid in future instances. For more information refer to the first page for the complete disclaimer note.

Learn how Pilot Assist's status and actions are communicated in the vehicle.

The instrument panel shows the status of Pilot Assist using graphics and symbols. Important information can also appear as notifications.

The primary status is shown below the gear indicator. It tells you whether Pilot Assist is active or not.

The target speed appears in green above the speedometer.

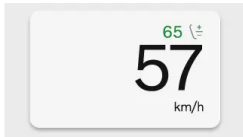

Communication with symbols

Pilot Assist's status is communicated using symbols. The symbols show what level of support Pilot Assist is currently providing based on your Pilot Assist settings.



Pilot Assist without steering assistance is available to activate if all conditions are met.



Pilot Assist with steering assistance is available to activate if all conditions are met.



Pilot Assist is active without providing steering assistance.



Pilot Assist is active and providing steering assistance.



Lane change assist communication. The color and direction of the arrows are different depending on the situation.



Steering assistance is temporarily unavailable.



Pilot Assist is adapting the driving speed to a vehicle ahead. The symbol is shown next to the speedometer.



Curve speed assist is active and Pilot Assist is adapting the driving speed to the current road features, such as a curve or traffic circle. The symbol is shown next to the speedometer.

Communication in surround display mode

When the instrument panel is in surround display mode, it will show Pilot Assist's status and actions as animations and symbols. The animations can show what level of support Pilot Assist is currently providing, depending on your Pilot Assist settings. This may include speed-keeping, distance-keeping, adjusting the speed to other vehicles ahead and availability of steering assistance.

 **Important**

Using surround mode

Surround mode cannot perfectly depict what is really happening on the road around you, so do not rely on it when you are driving.

Notifications and messages

When using Pilot Assist, notifications may appear in the instrument panel. They may contain important information about the status of Pilot Assist features, as well as instructions for you to follow, such as not letting go of the steering wheel.

10.5.2.3. Activating Pilot Assist

You activate Pilot Assist by moving the right-hand steering wheel stalk downwards while driving. It's important to assess whether the current driving conditions allow you to use Pilot Assist safely.

When driving, a gray Pilot Assist symbol in the instrument panel indicates that the function is available but not yet activated. The symbol changes depending on whether steering assistance is enabled in settings or not.

D Pilot Assist with steering assistance is off but available to activate if all conditions are met.



D Pilot Assist without steering assistance is off but available to activate if all conditions are met.



 **Important**

Before using Pilot Assist

Take the time to read everything about Pilot Assist in this manual before using it for the first time. Understanding its capabilities and limitations is important for safe use.

Assess the situation

Make sure the traffic situation and conditions are suitable for activation. Wait until you complete any ongoing maneuvers, such as a lane change, before activating Pilot Assist.

Activating Pilot Assist when driving

1.



When appropriate, pull the right-hand steering wheel stalk all the way down.

> Activation is confirmed in the instrument panel.

The first time you activate Pilot Assist during a drive, your speed at the time of activation becomes the set speed.



Tip

Resuming Pilot Assist

If you recently used Pilot Assist and you want to use your previous target speed, keep the steering wheel stalk pulled down for little while longer when activating Pilot Assist. This resumes your previously set target speed upon activation.

When Pilot Assist is active, you can adjust the target speed with the steering wheel buttons.

10.5.2.4. Deactivating Pilot Assist

When you want to stop driving with Pilot Assist, you can deactivate it manually. There are also situations in which Pilot Assist deactivates automatically.

Deactivating and activating Pilot Assist is done in the same way. You simply pull the right-hand steering wheel stalk downwards. You can also deactivate Pilot Assist by braking.

When you deactivate Pilot Assist, all of its assistance is turned off. This includes speed- and distance-keeping, as well as steering assistance.

Deactivating Pilot Assist using the stalk

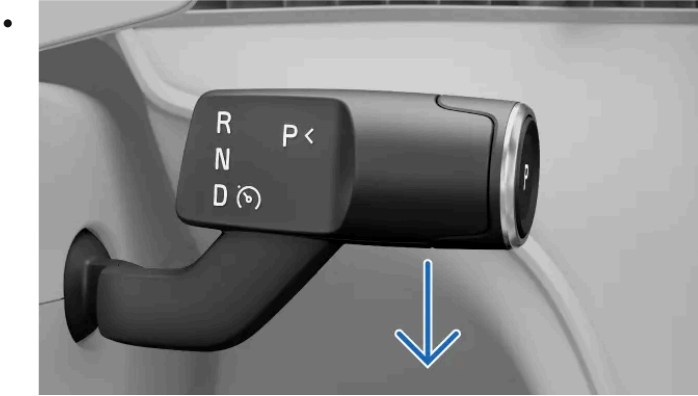

Pull the right-hand steering wheel stalk all the way down.

> Deactivation is confirmed in the instrument panel.

Deactivating by braking

- Press down on the brake pedal.

> Deactivation is confirmed in the instrument panel.

Note

Automatic deactivation

Pilot Assist has several limitations and only works if all the necessary conditions are met. If the driving conditions change during your drive, Pilot Assist can deactivate automatically.

Examples of scenarios where Pilot Assist may automatically deactivate include instances where:

- You are not driving actively. You must stay attentive and keep both of your hands on the steering wheel, even if steering assistance is activated.
- You open a door or unbuckle your seat belt.
- You change gears. Pilot Assist can only support you when D is selected.
- You leave the turn signal on for a long time when driving with steering assistance. This can indicate that you are not fully focused.
- You manually speed up and maintain a higher driving speed than the target speed. This indicates that you want to return to full manual control of your vehicle.
- Camera or radar conditions for Pilot Assist are not met.

10.5.2.5. Adjusting the target speed for Pilot Assist

Pilot Assist can support you in keeping a set target speed. You can adjust the target speed with the steering wheel control buttons.

When you are driving with Pilot Assist active, you can select a target speed. The vehicle then manages acceleration and braking to meet that target while also adapting to surrounding traffic.

You can adjust your set target speed by pressing the set speed adjustment buttons on your steering wheel's left-hand control area. When this is possible, the instrument panel will provide information about which buttons to press.

The behavior for changing the target speed differs depending on whether your vehicle is built for a market using km/h or mph as the standard speed unit. This behavior doesn't change if you select a different speed unit in system settings.

For vehicles built for a km/h market:

Press once Adjust the target speed by 5 units.

Press and hold Adjust the target speed by 1 unit continuously by pressing and holding the button.

For vehicles built for a mph market:

Press once Adjust the target speed by 1 unit.

Press and hold Adjust the target speed by 5 units continuously by pressing and holding the button.

When you adjust by 5 units at a time, the target speed will default to speed increments that are divisible by five, such as 25, 30, or 35.

When **Adapt to speed limit** is enabled in settings, Pilot Assist can adapt the set speed to upcoming speed limit changes. The new speed limit then appears as a suggested set speed in the instrument panel for you to confirm.

1. Adjust the target speed using the buttons on the steering wheel.

> Your new target speed is shown in green above the speedometer.

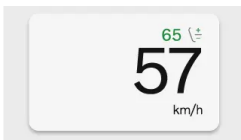

10.5.2.6. Enabling and disabling steering assistance when driving

Pilot Assist steering assistance can be easily enabled or disabled using the steering wheel buttons. This allows you to control it without going into settings while driving.

Steering assistance is part of Pilot Assist and can only be used when Pilot Assist is active.

If steering assistance is unavailable for some reason, such as deteriorated lane markings, you won't be able to activate it. However, if steering assistance is enabled, it will automatically activate when the required conditions are met.

1. Press the steering assistance button  on the steering wheel.

The content of this manual represents the status of the user manual at the time of printing and may not be completely valid in future instances. For more information refer to the first page for the complete disclaimer note.

> Steering assistance is either enabled or disabled.

If enabled, steering assistance activates automatically when the required conditions are met.

If disabled, Pilot Assist will remain active but mainly provide speed- and distance-keeping support.

10.5.2.7. Changing lanes with Pilot Assist

Lane change assist is a feature included in Pilot Assist that can help you make changes to overtake other vehicles.

Pilot Assist automatically provides steering assistance during lane changes if all conditions are met.

In addition to the general conditions for using Pilot Assist, conditions for assisted lane changes include:

- Both steering assistance and lane change assist are enabled in Pilot Assist's settings.
- Pilot Assist is active.
- The conditions for steering assistance are met.
- Your speed is in the range of 65-150 km/h (40-90 mph).
- The traffic situation allows a lane change.
 - The vehicle checks if the conditions for an assisted lane change are met, such as the adjacent lane being available. However, the responsibility to assess and decide whether a lane change can be done safely ultimately lies with the driver.
 - There are road and driving conditions that do not provide the vehicle enough information for it to provide steering assistance during a lane change. In such situations, the driver can still perform unassisted lane changes. This disables steering assistance until its conditions are met again.
- You are driving on a highway or similar road.

Lane change status is communicated via symbols and messages.

Symbols showing information about available or ongoing lane changes are shown below the gear indicator.



Lane change assist is available to use. The symbol shows an arrow to indicate the direction of a possible lane change. It can be shown for either side or both sides simultaneously. During an ongoing lane change, the arrow pointing in the direction of the lane change will start to flash.

Information about interrupted lane changes or faults affecting the vehicle's ability to perform assisted lane changes is communicated using symbols and messages.



The ongoing lane change is interrupted. An assisted lane change maneuver can be interrupted if there is a change in conditions or traffic situation or if you override the steering guidance. The lane change is canceled immediately. Take full control of the vehicle as required.



Lane change assist is unavailable and any ongoing lane change is canceled. This can happen if there is a fault affecting critical systems, such as steering assistance. Be attentive to any messages that may follow.

 **Warning**

Lane change assist is a supplement to safe driving practices. It does not reduce or replace the need for the driver to stay attentive and focused on driving safely. Drive the vehicle with the same attention to safety as you would need to in a vehicle without the ability to intervene.

1. When a lane change is available, use the turn signal stalk to initiate the lane change.
- > The vehicle recognizes that you want to change lanes. If the necessary conditions are met, the vehicle begins to guide your steering during the lane change.

 **Note**

Keep your hands on the steering wheel

Keep both hands on the steering wheel during the lane change. You are responsible for intervening if needed. You can override the vehicle's guidance by braking, accelerating or steering at any time.

10.5.2.8. Adjusting Pilot Assist settings

You can adjust or change which features are enabled for Pilot Assist in settings.

Pilot Assist includes several features, some of which you can enable, disable or customize in settings. This allows you to set Pilot Assist up for the level of support you want.

The customizable settings include:

Steering assist	Guides the steering wheel movement to correctly position the vehicle in the lane.
Lane change assist	Guides lane change maneuvers initiated by the driver.
Curve speed assist	Driving speed is adapted ahead of known road features such as curves and roundabouts.
Adapt to speed limit	The speed limit of the road you're on appears as a suggested set speed in the instrument panel for you to confirm.
Time interval to vehicle ahead	Adjust the target time interval to vehicles ahead. This way, you can adjust the distance to vehicles in front of you.



Tip

Customizing Pilot Assist features using the steering wheel buttons

Features such as steering assistance and target speed can be adjusted using the steering wheel buttons. The instrument panel typically shows what actions are available and which buttons to use.

Quick access

You can also adjust the time interval to vehicles ahead via the contextual bar. This allows you to make quick adjustments, without going into settings.



Important

Changing driver support settings

Make sure that you understand how changing your vehicle's settings affects its behavior. It is particularly important when it comes to features that affect the level of assistance the vehicle can provide.

1. Press the vehicle symbol  in the bottom bar and go to **Settings**.
2. Go to **Driving** → **Pilot Assist**.
3. Customize the Pilot Assist settings to your preferences.



Note

Adjusting the time interval to vehicles ahead

When driving at higher speeds, the general distance to a vehicle ahead will be longer than when driving at lower speeds, even if the target time interval is the same. This is because the calculated distance becomes longer for the given time interval.

10.5.2.9. Pilot Assist conditions and limitations

To use Pilot Assist safely, it's important to be aware of its limitations. Although it is an advanced function, there are conditions and situations that it cannot handle.

Driver responsibility when using Pilot Assist

While Pilot Assist takes over many tasks related to driving, you are still considered the driver and are responsible as such. When using the function, you are still required to actively and attentively drive the vehicle. Pilot Assist does not know your intentions or the intentions of other drivers. It cannot predict or identify every potentially hazardous situation that an attentive driver can. It's your responsibility to continuously assess Pilot Assist's performance and act if necessary. As long as you judge its input to be correct, you can let it guide your driving.

Important

Driving conditions

Assessing Pilot Assist's performance requires that you take all driving, traffic, weather or road conditions into consideration. For example, if visibility is poor, you may need to increase the distance to vehicles ahead compared to the distance kept by Pilot Assist. The same applies to maintaining a speed that is safe for the current road and traffic conditions.

Improved safety and convenience

When used correctly, Pilot Assist can improve safety and reduce the effort of driving. In some cases, it can compensate for driver errors, such as mistakes caused by lapses of attention or distractions. This potential benefit is a supplement to safe driving practices. It does not reduce or replace the need for the driver to stay attentive and focused on driving safely.

Driver readiness

Using speed- and distance-keeping features can mean you may not use the pedals for long periods of time. However, you must remain prepared and ready to brake or accelerate manually if necessary. Avoid changing your driving posture in ways that can delay your response time.

Hands on the wheel

Pilot Assist can guide your steering, but you are still required to keep your hands on the steering wheel, just like when driving unassisted. As long as you believe the steering input is correct, you can let Pilot Assist guide your steering.

Eyes on the road

When using Pilot Assist, you must still remain attentive as a driver. This includes keeping track of your surroundings and the traffic around you, just like when driving unassisted.

Speed range for Pilot Assist

Pilot Assist is available at different speeds depending on the context of activation and use.

- When using Pilot Assist without steering assistance, you can set target speeds from 20-180 km/h (10-110 mph).
- When using Pilot Assist with steering assistance, you can set target speeds between 20 and 150 km/h (10-90 mph).
- Pilot Assist can be activated below 20 km/h (10 mph), but will then try to accelerate up to the minimum set speed.

The content of this manual represents the status of the user manual at the time of printing and may not be completely valid in future instances. For more information refer to the first page for the complete disclaimer note.

- When following another vehicle, Pilot Assist can stay active below 20 km/h (10 mph).
 - In situations where you are driving slowly behind other vehicles, such as in a traffic queue, you may be able to use Pilot Assist even if you driving slower than 20 km/h (10 mph). This requires a vehicle ahead whose speed your vehicle can match.^[1]

Activation and availability

Several conditions must be met to activate Pilot Assist. They are related to current traffic and road conditions and the vehicle's system status. Some are related to the vehicle being driving-ready, such as the driver wearing their seat belt, keeping their hands on the steering wheel^[2] and all doors being closed. Others relate to your current driving situation, such as driving at a speed within the speed range for Pilot Assist. Activation at a standstill requires a vehicle ahead within a close distance. If activation is prevented, the specific reason is typically communicated in the instrument panel.

Keeping track of vehicles ahead

One of Pilot Assist's capabilities is adapting the vehicle's speed to a vehicle ahead and maintaining a certain distance to it. Pilot Assist's behavior and ability to track traffic ahead depends on several factors, such as your speed and the speed of the vehicle in front.

Very slow or stationary vehicles in front of you can make Pilot Assist behave differently, depending on the situation and your speed:

- If Pilot Assist follows a vehicle that comes to a stop, Pilot Assist slows your vehicle down to a stop behind the other vehicle.
- If a stopped vehicle is detected ahead of you, Pilot Assist will slow you down in an attempt to stop behind the other vehicle.
 - Depending on your driving speed, the vehicle may not be able to reach a full stop behind the vehicle in front. You are always responsible for keeping track of the surrounding traffic and driving in a way that allows you to react and control your vehicle safely.
- When driving at high speeds, Pilot Assist can misinterpret stationary vehicles in front of you, such as when catching up to a stationary line of traffic. In a situation like this, Pilot Assist will not consider the stopped vehicles or slow you down. Always be attentive and available to control your vehicle and brake when necessary.



Warning

Stopped or slow vehicles ahead

A stopped vehicle in your lane is a collision risk that requires you to act by braking or steering.^[3]

- At speeds below 5 km/h (3 mph) Pilot Assist may pause when following another vehicle:
 - if there is uncertainty whether what's detected in front is a stopped vehicle or another object^[4].
 - if the vehicle ahead makes a turn and leaves your driving path.

Vehicle status and systems

Pilot Assist relies on the accurate detection and identification of surrounding traffic and road conditions. This includes using information from the cameras, radars and other sensors. The detection system cannot handle all driving, traffic, weather or road conditions. Read the separate manual sections about detection types, how they work and their limitations to better understand how Pilot Assist's performance can be affected.

Several of Pilot Assist's features depend on other systems in the vehicle.

- To adapt the speed to vehicles ahead, the vehicle uses a combination of radar and camera detection. Consequently, conditions and limitations of these systems can affect the availability and performance of this feature.
- Steering assistance is only available when the vehicle can identify its position on the road through camera detection of lane markings.
 - This requires the road to conform to certain standards.
 - Conditions and limitations of the vehicle's camera detection can affect the availability and performance of steering assistance.
- Information about road features, such as upcoming sharp curves and traffic circles, depends on accurate map data. Availability and functionality of the map data service may vary over time and depend on region. This in turn affects the availability and performance of the curve speed assist feature.
- Not accepting Google's terms and conditions limits the availability and performance of Pilot Assist. You can manage your consent in privacy settings via the center display.
- When Pilot Assist's target speed is set to adapt to the speed limit, the value is provided by the vehicle's road sign information system. In some conditions, it may not be able to provide an accurate speed limit.

 **Important**

Vehicle faults

Certain vehicle faults can affect the availability of driver support features. If Pilot Assist is unavailable, check the vehicle status view to see if there are any indicated issues.

Vehicle alterations

Modifications, repairs and accessory installations can negatively affect or limit driver support features. There is a separate manual section with detailed information on this topic.

Other conditions and limitations

- Pilot Assist is primarily intended for use when driving on level road surfaces. It may have difficulty keeping the correct distance to vehicles ahead on steep downhill slopes.
- Do not use Pilot Assist when driving with a trailer or heavy loads.

^[1] Pilot Assist's lowest target speed is 20 km/h (10 mph), even if your speed is lower than that when you activate it.

^[2] Wearing gloves can sometimes interfere with the hand-detection sensors on the steering wheel.

^[3] Your vehicle can still warn you of the collision risk and perform a safety intervention if you fail to react in time. This can happen separately from Pilot Assist's capabilities.

^[4] For example, obstacles designed to encourage slow driving.

10.6. Assisted parking

Your vehicle has several features that can help you during parking, such as guidance through camera and sensor views. Learn how to use the different types of assistance.

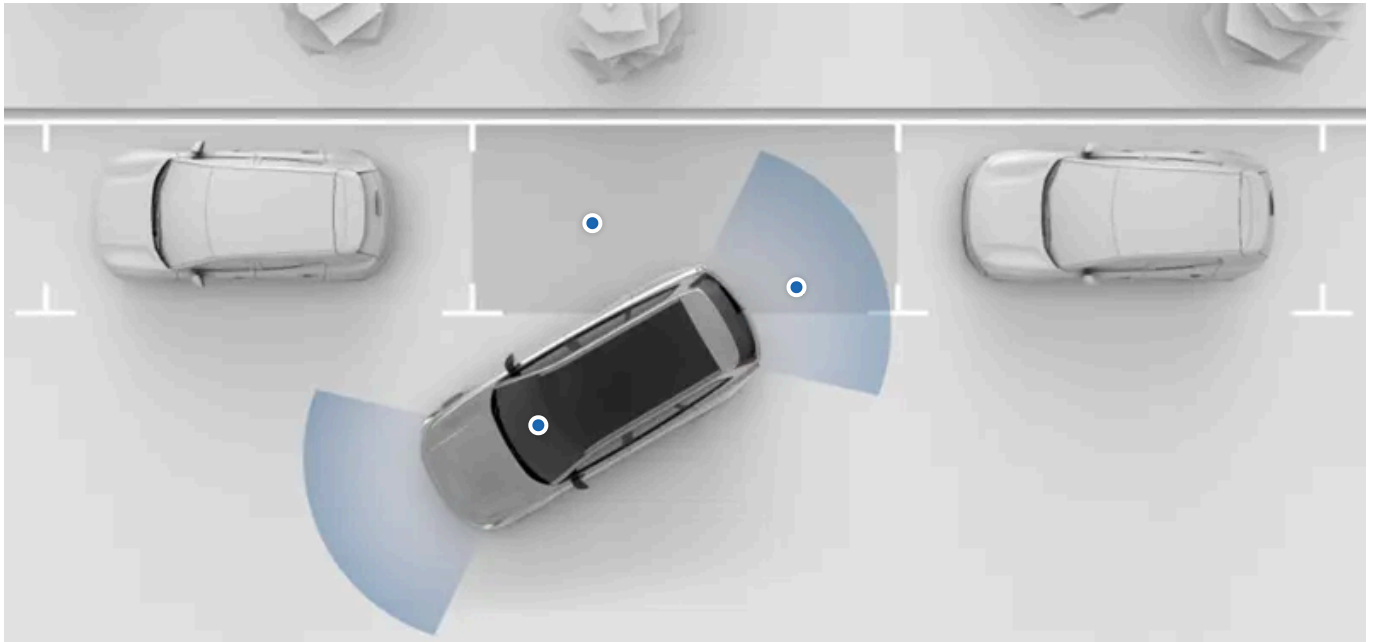

Your vehicle's parking assistance features are available in the center display parking view. In most cases, parking view opens automatically when you need it, but you can also open it manually.

The following parking assistance features are available in the parking view:

Distance and obstacle detection	The vehicle senses the surroundings using many different sensors. It uses this information to guide you with sound, graphics and warnings when driving at low speeds.
Parking camera views	The vehicle shows your surroundings using cameras located around the vehicle.
Rear Auto Brake	The vehicle can automatically brake if an obstacle is detected immediately behind the vehicle while reversing at low speeds.
Park Pilot Assist	This feature can actively steer, brake and move in and out of parking spaces.

 **Important**

Required knowledge and driver responsibility

Assisted parking features are designed to make driving more comfortable and safer, but they do not reduce the need or responsibility of the driver to operate the vehicle as safely as possible. Be sure to read all related information about a feature before using it. The section covering driver responsibility is essential reading for understanding the capabilities and limitations of your vehicle's assisted driving features.

If you find anything unclear or have further questions, do not hesitate to contact Volvo Support.

10.6.1. Parking view

The parking view contains both camera and parking sensor information to help improve your awareness of the vehicle's surroundings. This can be useful when maneuvering at low speeds, such as when parking.

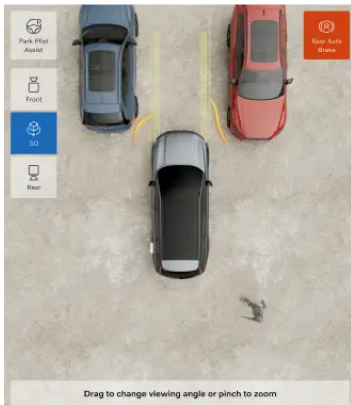

Accessing the parking view

In most cases, the parking view opens automatically when you need it. You can also access it by opening the Camera app in the contextual bar or in the app library .



The parking view closes automatically when you are driving above a certain speed. After parking, the parking view closes when you leave your vehicle.

Features in the parking view

The parking view contains the following features:

- Camera views that also provide visual guidance and obstacle detection
- Rear Auto Brake, which can provide automatic braking for obstacles while reversing at low speeds
- Park Pilot Assist, which can actively steer the vehicle in and out of parking spaces.

Camera views

You can choose from several camera views.



Front A camera at the very front of the vehicle provides the front view, along with a top view.



3D The vehicle combines front, rear and side camera views to show the vehicle in its surroundings. The standard perspective shows the vehicle from the top, but you can also adjust it to show other perspectives.



Rear A camera at the back of the vehicle provides the rear view, along with a top view.

Adjusting the 3D view

You can adjust the 3D view by dragging your fingers around to change the angle. You can also zoom in and out by pinching your fingers. Adjusting the view makes it easier to get a closer look from different angles and see things more clearly in the

parking view.

 **Tip**

Recenter the 3D view

You can always recenter the view by pressing the 3D view symbol. This allows you to return to the default 3D view again.

Automatic zoom in and out

If you approach an obstacle, the vehicle can automatically zoom in on the part of the vehicle that's closest to the obstacle. If you drive away from the obstacle or if the obstacle is removed, the vehicle can automatically zoom out again.

Obstacle and distance detection

The parking view can provide both visual and audible alerts if your vehicle detects any obstacles in your surroundings.

These alerts change if you go beyond a recommended stopping point. The color of the visual indication shifts toward red, and the sound changes when you get closer to the obstacle.

 **Important**

Driver responsibility

Obstacle and distance detection is a supplement to safe driving practices. It does not reduce the need or responsibility of the driver to operate the vehicle as safely as possible.

The driver is always responsible for paying attention to the vehicle's surroundings and ensuring that it is safe to maneuver the vehicle.

Detection limitations

The vehicle's obstacle and distance detection capabilities have limitations. Read the separate section covering detection of vehicle surroundings and traffic before using features that rely on these capabilities.

 **Note**

Camera calibration

After servicing your vehicle's parking cameras, they can sometimes take a while to recalibrate themselves. This may mean that certain features, such as the parking view, are unavailable for a short time after having the vehicle serviced.

10.6.2. Park Pilot Assist

Park Pilot Assist can help you maneuver in and out of certain parking spaces.

When active, Park Pilot Assist controls the vehicle with high precision, allowing you to park in tight spaces. It can help you both when parking and when leaving a parallel parking space.

 **Important**

Read everything

Read all information about the function before using it. It is important to know its proper use and limitations.

Detection of surroundings

Park Pilot Assist relies on the vehicle's ability to detect its surroundings by using information from the parking sensors. The sensors use nearby objects to detect available parking spaces rather than road markings. For this reason, Park Pilot Assist can only identify a space if another vehicle is parked in front of it.

During Park Pilot Assist maneuvers

Your vehicle controls acceleration, braking and steering during parking maneuvers. Even though Park Pilot Assist takes over the driving-related tasks of parking, you must still monitor the feature and its maneuvers. This means that as long as you agree with what Park Pilot Assist is doing, you don't need to do anything to speed up, slow down or steer your vehicle. However, you should always be ready to retake control of parking if you feel you need to.

Parking in a parking space

You can use Park Pilot Assist during parallel parking, when parking behind another vehicle. When you activate Park Pilot Assist, it identifies available spaces close to the vehicle and presents one of them in the center display. After confirming the suggested space to park in, you can let go of the steering wheel and start the parking maneuver by lightly tapping the brake pedal once. Your vehicle then controls steering, braking and acceleration to park. Supervise the maneuver and follow any instructions provided in the center display.

Leaving a parking space

You can use Park Pilot Assist to maneuver out of a parallel parking space. When you activate Park Pilot Assist, the vehicle suggests an exit direction. Use the turn signals to select and confirm which direction you prefer. After confirming the exit direction, you can let go of the steering wheel and lightly tap the brake pedal to start the Park Pilot Assist maneuver. Your vehicle then controls steering, braking and acceleration to leave the parking space. Supervise the maneuver and follow any instructions provided in the center display.

 **Warning**

Pay attention

When using Park Pilot Assist, you must keep the same level of attention to your surroundings as if parking without assistance. Immediately take full control of the vehicle if necessary.

Driver responsibility

The driver is always responsible for driving safely and in accordance with traffic rules and regulations. Park Pilot Assist is not a substitution for the driver's attention and judgment.

Limitations

Park Pilot Assist cannot handle all traffic, weather and road conditions. Read the separate manual section covering detection of vehicle surroundings and traffic before using features that rely on these capabilities.

Stopping Park Pilot Assist

You can always stop an ongoing maneuver. Depending on how you do so, Park Pilot Assist either pauses or ends the maneuver.

There are several reasons to stop an ongoing Park Pilot Assist maneuver, such as:

- You want to take over and complete the maneuver on your own.
- The current placement is good and you don't need it to continue.
- You want it to stop for safety reasons.

To exit Park Pilot Assist, do any of the following:

- Press **Cancel** in the center display.
- Start steering manually.
- Change gear.

Park Pilot Assist will stop automatically if:

- a pedestrian is detected close to the vehicle.
- the maximum allowed speed is exceeded.
- the maximum number of moves is exceeded.
- the slope is too steep.
- the vehicle detects a system malfunction or failure.

You can also pause Park Pilot Assist by pressing the brake pedal.

Note

Automatic pausing of Park Pilot Assist

Park Pilot Assist may pause automatically during a maneuver if:

- a door is opened.
- the driver is no longer detected by the vehicle's system.
- the vehicle performs an emergency braking maneuver.

Extending a paused maneuver

Pressing and holding the brake pedal can pause the maneuver for up to a minute before it's cancelled. Releasing the brake pedal within this time resumes the maneuver.

Resuming a paused maneuver

You can resume the maneuver by pressing the brake pedal once. If you don't press the brake pedal after an automatic pause, the maneuver cancels after a short while.

10.6.2.1. Parking using Park Pilot Assist

You can activate Park Pilot Assist in the parking view. It's capable of maneuvering the vehicle into a parallel parking space.

The parking view often appears automatically, such as when you are reversing, but sometimes you need to open it manually. Find the Camera app in the contextual bar or the app library .



Important

Before using Park Pilot Assist

Take the time to read everything about Park Pilot Assist in this manual before using it for the first time. Understanding its capabilities and limitations is important for safe use.

Assess the situation

Make sure the traffic situation and conditions are suitable for activation. Park Pilot Assist can only assist you when parallel parking and uses nearby vehicles to help identify a suitable space. If no vehicle is parked in front of the space, the system may not detect it.

Your vehicle controls acceleration, braking and steering during assisted parking maneuvers. Even though Park Pilot Assist takes over the driving-related tasks of parking, you must still monitor the feature and its maneuvers. This means that as long as you agree with what Park Pilot Assist is doing, you don't need to do anything to speed up, slow down or steer your vehicle. However, you should always be ready to retake control of parking if you feel you need to.

Prevented activation of Park Pilot Assist

Certain events and conditions, such as a door being opened, can prevent activation of Park Pilot Assist. When the condition no longer applies, Park Pilot Assist can be activated.

Selecting an available parking space

1. In the parking view, press the Park Pilot Assist button.



- > The vehicle begins scanning for available parking spaces.
2. Drive slowly in gear D to continuously scan for available spaces. Use the indicators to choose which side you want to park on.
 - > When the vehicle identifies an available parking space, it will be highlighted in the center display. You need to pass a spot before it appears as available in the center display.
 3. Stop the vehicle and select the suggested parking space via the center display to park there.

Starting the parking maneuver

The content of this manual represents the status of the user manual at the time of printing and may not be completely valid in future instances. For more information refer to the first page for the complete disclaimer note.

4. Start the parking maneuver by lightly tapping the brake pedal once.

 **Note**

Your vehicle won't begin any automatic maneuvers until you have selected a parking space via the center display.

5. Let go of the steering wheel and follow any further instructions in the center display.

 **Warning**

Pay attention to your surroundings and take control of the vehicle if necessary.

 **Note**

During Park Pilot Assist parking maneuvers

You might experience Park Pilot Assist parking maneuvers differently, depending on the situation. Sometimes, it might seem like the feature is a bit hesitant or that the vehicle is going backward and forward a lot. This is just part of the parking process but it can be due to difficulties with detection, positioning or planning. In other cases, you might feel that the parking is very fast or straightforward. If your selected parking space becomes unavailable or the parking maneuver can't be completed, your vehicle will notify you. If you don't see a notification, you can let the vehicle continue parking as long it's safe to do so.

6. The vehicle confirms when it has completed the maneuver and puts the vehicle in park.

10.6.2.2. Leaving a parking space using Park Pilot Assist

You can activate Park Pilot Assist in the parking view. It is capable of maneuvering the vehicle out of a parallel parking space.

The parking view often appears automatically, such as when you are reversing, but sometimes you need to open it manually. Find the Camera app in the contextual bar or the app library .



 **Important**

Before using Park Pilot Assist

Take the time to read everything about Park Pilot Assist in this manual before using it for the first time. Understanding its capabilities and limitations is important for safe use.

Assess the situation

Make sure the traffic situation and conditions are suitable for activation. Park Pilot Assist can only assist you when you are leaving a parallel parking space.

Your vehicle controls acceleration, braking and steering during Park Pilot Assist maneuvers. Even though your vehicle takes over the driving-related tasks of leaving a parking space, you must still monitor the feature and its maneuvers. This means that as long as you agree with what Park Pilot Assist is doing, you don't need to do anything to speed up, slow down or steer your vehicle. However, you should always be ready to retake control if you feel you need to.

Prevented activation of Park Pilot Assist

Certain events and conditions, such as a door being opened, can prevent activation of Park Pilot Assist. When the condition no longer applies, Park Pilot Assist can be activated.

Selecting an available exit path

1. In the parking view, press the Park Pilot Assist button.



- > The vehicle begins scanning for an exit path. Use the turn signals to choose the direction. When a path is identified, its direction is highlighted in the center display.
2. Press the highlighted suggestion in the center display to confirm the direction in which you want to exit the parking space.
3. Start the Park Pilot Assist maneuver by lightly tapping the brake pedal once.

 **Note**

Your vehicle won't begin any automatic maneuvers until you have confirmed an exit direction via the center display.

4. Let go of the steering wheel and follow any further instructions in the center display.

 **Warning**

Pay attention to your surroundings and take control of the vehicle if necessary.

 **Note**

During Park Pilot Assist maneuvers

You might experience Park Pilot Assist maneuvers differently, depending on the situation. Sometimes, it might seem like the feature is a bit hesitant or that the vehicle is going backward and forward a lot. This is just part of the process, but it may be caused by difficulties with detection, positioning or planning. In other cases, you might feel that the maneuvers are very fast or straightforward. If your confirmed exit path becomes unavailable or the maneuvers can't be completed, your vehicle will notify you. If you don't see a notification, you can let the vehicle continue as long it's safe to do so.

5. The vehicle confirms when it has completed the maneuver and puts the vehicle in park.

 **Note**

Due to safety reasons, the Park Pilot Assist maneuvers won't position your vehicle completely outside the parking space every time you use it to leave a parking spot. In most cases, the maneuvers stop when the vehicle reaches a good point for you to take over and continue driving. You can then fully exit the parking space without using Park Pilot Assist.

11. Scenarios and driving recommendations

The conditions you're experiencing sometimes affect how you can and should use your vehicle. Knowing its capabilities and how you can adapt to the situation can have a significant impact on the outcome. The benefits range from avoiding outright hazards to getting the most out of your vehicle's performance.



This section of the manual will cover specific driving scenarios. These include preparing for a long trip, wading through water and driving on icy roads. Exploring this section gives you a good idea of what features and practices can support you in demanding conditions.

11.1. Cold conditions

Driving and taking care of your vehicle in cold conditions can be tricky. It requires different preparations and a different way of driving than driving in a warmer climate does.

When driving in cold conditions, there are many things to take into consideration. From energy consumption and battery health to a comfortable climate and different safety aspects. Be sure to familiarize yourself with what this way of driving entails, as well as which laws and regulations may apply.

Visibility

In cold conditions, ice and condensation can obstruct visibility. Your vehicle is equipped with defrosters, a heated rear windshield and heated door mirrors to prevent this from happening.

 **Warning**

Scraping the windshield

The windshield area in front of the front-facing camera has its own heating to defrost and remove any build-up of snow or ice. Do not use an ice scraper on this area, as it can scratch the glass surface. Scratches or damage to the glass in front of the camera can interfere with or limit its detection capabilities.

Range

Cold temperatures can negatively affect your vehicle's battery. When the vehicle has a cold battery, a snowflake ❄️ appears next to the battery percentage. This indicates that the battery's charge capacity, performance and range are reduced compared to normal conditions. You can avoid this by always charging your vehicle while it's parked, which can prove especially useful if you are parking in a cold climate.

When the battery warms up – for example, while preconditioning the vehicle or when driving – the snowflake disappears from the instrument panel.

 **Tip**

Activating eco climate allows your vehicle to make extra adjustments to increase your range.

If you feel like this makes the passenger compartment a bit too cold, you can use seat heating and steering wheel heating to keep warm, as these use less energy.

Maintenance

 **Note**

Frozen door handles

In rare cases, frost or ice may prevent the handles from folding outwards. If this happens and the vehicle is unlocked, you can still use the handles to open the vehicle.

If ice buildup prevents you from accessing the door handles, there are some steps you can try:

- Activate preconditioning in the Volvo app to heat the vehicle.
- Carefully brush or tap the door handle to remove the ice manually.

Tire pressure

As the temperature drops, the tire pressure drops. Remember to check the tire pressure regularly and adjust it as needed.

 **Important**

Cleaning in front of radar units

If you find dirt, snow or ice, or if the vehicle indicates that a radar unit is blocked, you should address it as soon as possible. Always clean and clear a large area around the radar units to so their full field of view is available.

Parking in cold weather

When the battery is cold, the vehicle temporarily reduces battery performance until it has warmed up. Driving the vehicle in a state of reduced performance doesn't harm the battery.

To avoid temporarily reduced performance from a cold battery, connect the vehicle for charging and activate the vehicle's preconditioning prior to your trip. The vehicle can then heat the battery without affecting performance and available range.

In temperatures below -30 °C (-22 °F), avoid leaving the vehicle parked without charging for longer than 24 hours.

Important

You should always avoid completely running the battery down. If you need to leave your vehicle in the cold, make sure it's sufficiently charged beforehand.

11.1.1. Winter driving recommendations

There are some things to keep in mind when driving in snow and on ice. Here are some tips and recommendations for safer driving and improved effectiveness of your vehicle's systems.

Preparations for driving in winter conditions

- Cold weather is more demanding for the battery and can lead to temporarily reduced performance. For better battery performance, precondition your vehicle before driving.
- Use washer fluid with antifreeze to avoid ice forming in the washer fluid reservoir.
- Volvo recommends that winter tires be used when there's a risk of snow or ice.

Note

In some regions, winter tires are required by law. However, keep in mind that not all locations allow studded tires.

Recommendations for driving in winter conditions

Snowy and icy roads require careful driving practices that are different from driving on dry roads. There are a number of precautions to take that will help you drive more safely. For example:

- Remove all snow from your vehicle before you start driving, both for your own sake and for your fellow road users. Pay special attention to the sensor areas, lights, roof and hood.
- Avoid any sudden steering maneuvers, fast acceleration or hard braking, as such maneuvers can cause the vehicle to lose grip.
- Turn off One pedal drive or use the lowest One pedal drive setting.
- Keep a safe distance from the vehicle in front of you, as you are likely to require a longer braking distance.
- Keep in mind that even if the sun melts the snow and ice, it can still be slippery.
- Even when other parts of the road aren't icy, bridges can still be dangerous.

- Snow and ice can accumulate inside the mudguards, which can affect steering. Check regularly and remove any snow, ice, and debris.
- Snow and ice can collect in the braking system and reduce braking performance. Check that the brakes work properly on a regular basis. However, only do so in a safe and careful manner.
- Sometimes, using snow chains can be a good idea. However, be sure to read the instructions on how to use them safely and effectively.

 **Warning**

Avoid parking on inclines during winter conditions. The tires might lose traction, even if the parking brake is engaged. You are always responsible for safe parking.

 **Tip**

It's a good idea to practice driving on slippery surfaces under controlled conditions to learn how the vehicle reacts. Visit a skidpan if you have access to one.

11.2. Recommendations for driving through water

When driving through water, there are important limitations to consider regarding the water's depth and the driving speed.

 **Important**

Volvo recommends that wading be done with great caution and that you avoid it when possible. It can be difficult to accurately assess the water's depth and the strength of the current. The driver is always responsible for driving in a safe manner and in compliance with all applicable rules of the road.

- If possible, determine how deep the water is before you start driving. Only attempt to drive through if you are confident it's shallow enough to safely wade through.
- Activate off-road to increase your vehicle's ground clearance.
- It is not recommended to wade in water deeper than 45 cm (17 inches).
- Limit your speed to walking pace.
- Avoid wading in strong currents, especially if the water is deep enough to risk flowing over the vehicle.
- Oncoming traffic can cause waves that increase how high the water reaches.
- If possible, avoid stopping when you're in the water. Carefully keep driving forward or reverse out of it.
- Avoid driving through saltwater, as it can cause corrosion.



Warning

Wet brakes

The vehicle's stopping distance is longer if the brake discs are wet. Driving through water exposes the brake discs to water, and possibly mud or other sediment. After wading, safely perform a hard braking maneuver to remove dirt and water from the brakes. By engaging the brake discs while driving, they heat up and dry.

11.3. Preparations for a long trip

Before you head out on a long road trip, it's a good idea to check a few things.

- Make sure that the brakes work as intended.
- Check the tire tread depth and pressure. If there is a risk of snowy or icy roads, change to winter tires.
- Ensure that the wipers are in good shape and replace them if needed.
- Fill up the washer fluid.
- Charge the vehicle to the battery level you need for the first leg of your trip. It's a good idea to look up available charging stations along your planned route.
- Make sure that useful equipment is in place, such as charging cables, the puncture repair kit, first aid kit, a warning triangle and a reflective vest.
- If you plan to visit a region that uses different units of measurement, such as miles or kilometers per hour, you can change the vehicle's unit settings.
- If you plan to visit a region where the driver's side is different, the exterior lights need to be altered. Make sure you familiarize yourself with how the vehicle can reorient the exterior lights to match the driving situation.
- If driving in a region with different traffic laws, make sure the vehicle is equipped as required, and read up on how the rules of the road differ from what you're used to.
- Remote areas may have poor or no internet connection. If you plan to drive in these areas, download the maps you need in the navigation app so you can use them when your vehicle is offline.

11.4. Long-term parking

Follow the long-term parking recommendations if your vehicle will go unused for longer than one month. Remember to regularly check on the vehicle when it's parked.

Long-term parking preparations

- When leaving your vehicle parked for longer than one month, the recommended battery level is 40-60%. Use or charge the vehicle to reach the recommended level.
- If you are leaving the vehicle parked for longer than three months, it's recommended to keep it plugged in but set the battery charging limit to 50%. This is for better battery health.
- Check and adjust the tire pressure. The recommended pressure during long-term parking is 330 kPa (48 psi).

The content of this manual represents the status of the user manual at the time of printing and may not be completely valid in future instances. For more information refer to the first page for the complete disclaimer note.

- Choose a cool and shaded location. An environment with controlled and consistent conditions is recommended.

During long-term parking

Regularly check:

- the state of charge and that charging is working properly
- the tire pressure.



Tip

Keep the vehicle up to date

During periods when the vehicle goes unused, make a habit of checking for and installing software updates.

After long-term parking

- Before driving the vehicle, make sure all core driving controls and functions work properly, such as the brakes.
 - Install any available software updates.
-

12. Storage, stowing and towing

Your vehicle is designed to transport people as well as luggage and other cargo. Learn about the car's stowing and towing capabilities.



The storage space under the hood can be used to store items such as a puncture repair kit.

Your vehicle's passenger compartment and trunk have several areas for safely stowing items of different shapes and sizes. The trunk can be expanded to create more space for larger cargo.

You can also use the roof for transporting heavy cargo, and with a towbar, you can attach a trailer.

Warning

It is important to properly store objects, even small items. Objects that are not stowed securely can be dangerous in the event of sudden braking or a collision.

Adding cargo to the vehicle changes the vehicle's weight and driving control properties. Always refer to the vehicle's permitted weight regulations and guidelines.

Before towing a trailer, make sure that all connectors and safety attachments are secured. Also be sure to follow local regulations regarding towing.

Important

Carrying loads on the roof may interfere with vehicle sensors.

12.1. Passenger compartment storage

The content of this manual represents the status of the user manual at the time of printing and may not be completely valid in future instances. For more information refer to the first page for the complete disclaimer note.

Find where the storage locations are in the passenger compartment.



- ① Center seat backrest.
- ② Door panel storage compartments.
- ③ Pockets on the front seat backs.
- ④ Center console.
- ⑤ Space under center display.
- ⑥ Glove compartment.

There are also several small features which can be useful for storing specific items:

- Fold out the armrest on the innermost side of each backrest to access a cup holder.
- There are cup holders in the third-row side panels.
- There are coat hooks by the rear seats along the inside of the roof.

***i* Note**

The coat hooks by the third-row seats should not be used.

12.1.1. Glove compartment

Store items that you don't immediately need in the glove compartment.

In the event of sudden braking or a collision, loose items can be hazardous. The glove compartment is useful for storing small items safely and securely.

The glove compartment is located in the dashboard in front of the passenger seat.

The glove compartment can be opened via the center display.

 **Warning**

Do not leave the glove compartment open while driving. In the event of a collision, it could interfere with the deployment of the passenger knee airbag.

12.2. Trunk space and storage

The trunk can be configured to accommodate cargo of different shapes and sizes.

You can adapt the trunk in different ways and expand it to create a larger cargo space. This can be useful for storing larger items.



① Foldable rear seats

② Cargo hold

Folding down the rear seats is ideal for loading large objects. Install a safety net when doing so to prevent objects moving into the front passenger compartment.

The cargo hold is accessed via the cargo hatch. It's useful for storing items.



Tip

Adjust trunk opening height

You can adjust how much the trunk hatch opens. This can be useful when you're parked in places with a low ceiling, such as a garage, and you want to reduce the trunk opening height. You can also raise the trunk opening height to create more room for accessing the trunk.

Lower the rear for loading

To make it easier to load the trunk, you can adjust the height of the rear of the vehicle with buttons to the right in the trunk.

Stowing cargo securely

You can also find options for stowing cargo securely, such as load-retaining eyelets, bag hooks and a net pocket. These features are useful for making sure cargo doesn't move around in the trunk while you're driving.

12.2.1. Removing the cargo hatch

You can make the trunk space bigger and access the cargo hold more easily by removing the cargo hatch.

Removing the cargo hatch allows you to enlarge the trunk space and easily access the cargo hold.

Clear all items from the trunk to ensure that nothing will get in the way when you remove the cargo hatch.

1. Grasp the hatch handle. It's located in the middle of the cargo hatch, near the outer edge.
 2. Pull the hatch up and towards you.
- > The cargo hatch lifts out from the trunk.

Place the cargo hatch where it can't get damaged or fall.

12.2.2. Installing the safety net

The safety net can be installed behind the front seats or the rear seats.

 **Warning**

There should be no occupants in the vehicle to the rear of a safety net. A safety net can interfere with safety features such as airbags.

 **Important**

Do not use the safety net to secure large or heavy objects. Secure any large or heavy cargo items with straps using the load-retaining eyelets located around the rear interior of the vehicle.

When a safety net is in place behind a retractable seat, be careful not to recline or reposition the seat too far back.

When installing the safety net, make sure it is the right way round. The tightening straps should always be on the side facing you.

Installing behind front seats

1. Remove the coat hooks from their sockets by twisting the hooks. Store them in a safe place for when you need the hooks again.
2. Insert each pin of the safety net into a coat hook socket. Push the pins forward until they lock into place.



3. Fasten the lower corners of the net to the outer tether points behind the seats.



4. Tighten the straps to make the safety net tight and more secure.

- > The safety net is attached at all four points.



Installing behind second-row seats



Insert each pin of the safety net into the sockets at the sides of the inner roof. Push the pins forward until they lock into place.

6. Fasten the lower corners of the net to the load-retaining eyelets behind the seats.



7. Tighten the straps to make the safety net tight and more secure.

- > The safety net is attached at all four points.



i Tip

Removing the safety net

To remove the safety net, follow the installation steps in reverse order.

12.2.3. Stowing cargo in the trunk

The trunk has a number of options for stowing items. This can be useful for making sure that cargo doesn't move around in the trunk while you're driving.

The trunk has several features to help stow items. These include:

- Load-retaining eyelets in the lower four corners of the trunk for securely fastening objects with straps.
- Bag hooks for preventing shopping bags from falling over. They are located on the side panels.
- Net pocket on the side panel for storing smaller items.
- Cargo hold under the trunk floor for stowing items.

Load-retaining eyelets



Load-retaining eyelets are located in the four corners of the trunk. You can use the load-retaining eyelets to attach straps and secure cargo in the trunk.

 **Tip**

You will find a 12 V socket on the right-hand side of the trunk. It can be useful for powering various electrical devices, such as a cool box.

12.2.3.1. Lowering the rear for loading

You can lower the rear of the vehicle to make it easier to load items into the trunk.

There are buttons for controlling the trunk height adjustments on a small button panel on the right-hand side of the trunk's interior. These buttons are marked with symbols.



Raising the rear of the vehicle



Lowering the rear of the vehicle

 **Warning**

Before adjusting the rear height, make sure there are no people, animals or objects under the vehicle.

1. Press and hold a height adjustment button to start adjusting the rear of the vehicle's height.

 **Tip**

You don't need to adjust the height again after loading the trunk. The rear will return to its default height when you start driving.

 **Note**

If the hood or any of the doors are open, you can't adjust the rear of the vehicle's height.

12.2.3.2. Accessing the cargo hold

You can access a storage area under the floor of the trunk.

The cargo hatch can be lifted to store items in the cargo hold.

Clear all items from the trunk before opening the cargo hatch.

1. Grasp the hatch handle. It is located in the middle along the outer edge.
2. Pull the hatch up.
3. Hang the cargo hatch on the bag hook by using the strap on the underside of the cargo hatch.



The hatch stays open and the cargo hold is now accessible.

12.3. Storage under the hood

In addition to the trunk, there is also storage space under the hood.

Examples of items that can be stored in the front cargo area include the warning triangle, tool kit, towing eye, charging cable and puncture repair kit.

 **Important**

Make sure the hood is shut properly after using the storage space.

12.4. Towing a trailer

The content of this manual represents the status of the user manual at the time of printing and may not be completely valid in future instances. For more information refer to the first page for the complete disclaimer note.

The towbar allows you to tow a trailer with your vehicle. Be sure to familiarize yourself with towing features and any relevant safety issues.

Before towing a trailer, consider how this will affect your journey. Make a thorough assessment based on your vehicle's capabilities.

- Keep in mind that the vehicle performs differently with added weight at the rear. This affects both handling and power usage. Expect a notable reduction in range when towing a trailer.
- Only use trailers in good working condition that comply with local regulations.
- Make sure you have read the separate section covering loading recommendations.

 **Note**

Software features connected to your towbar

Make sure that the towbar is properly installed.

If you've installed a towbar that isn't recommended by Volvo, be aware that software features related to connecting your towbar may not work as expected.

If you've had the towbar installed after purchasing your vehicle, a system update may be needed for the towing features to work. Contact an authorized Volvo workshop to update the software.

Maximum permitted trailer weights

The stated maximum permitted trailer weights are those permitted by Volvo. National vehicle regulations can further limit permissible trailer weights and speeds. Your towbar may be certified for a higher towing weight than the vehicle can actually tow.

Towing preparations

1. Increase the tire pressure to the recommended pressure for a full load. This applies regardless of the trailer weight.
2. Attach the trailer.
3. It's advisable to check that the trailer lights are in good working order.

Driving with a trailer

4. Read the recommendations for driving with a trailer thoroughly before you start driving.

 **Important**

While driving

- Maintain a low speed when driving with a trailer up long, steep ascents.
- Avoid driving with a trailer on inclines of more than 12%.
- The additional load increases the risk of overheating, which will be indicated in the instrument panel. Follow any instructions shown.
- Avoid parking on an incline if possible. The extra weight of the trailer can affect the parking brake's ability to securely hold the vehicle. If you cannot avoid parking on an incline, be sure to block the wheels^[1] as a precaution.

Fishtailing

Fishtailing is a phenomenon that can occur when towing a trailer. It causes the vehicle and trailer to oscillate in a side-to-side motion, which can escalate quickly and cause loss of control. Fishtailing primarily occurs at high speeds, especially if the trailer load is too heavy or improperly distributed. The vehicle continually monitors its movement and can intervene to help the driver regain control if it detects fishtailing.

Factors that introduce sideways motion can trigger fishtailing. For example:

- Sudden gusts and powerful side winds.
- Uneven road surfaces.
- Sweeping steering wheel movements from side to side.

Trailer stability assistance

The stability control system^[2] intervenes if it detects fishtailing when towing a trailer. The system precisely times individual braking actions for the front wheels to mitigate the fishtailing phenomenon. This is often enough to help the driver stabilize the vehicle and trailer.

When the stability control system intervenes to suppress fishtailing, the electronic stability control symbol is shown in the instrument panel.



Electronic stability control symbol

^[1] If you do not have wheel chocks, you can use large stones or wooden blocks instead.

^[2] Electronic Stability Control (ESC)

12.5. Determining the permitted gross vehicle weight

Make sure to never exceed your vehicle's maximum gross vehicle weight. Calculate your load limits for transportation using the following information.

 **Warning**

- If the permitted axle weight, gross vehicle weight or another specified weight is exceeded then the tires may overheat. This could lead to serious tire damage and safety risks.
- Do not use replacement tires with a lower load capacity than the tires the vehicle was originally equipped with, as this lowers the vehicle's gross vehicle weight classification. Only use tires with the correct load capacity. For more information, contact Volvo Support.

Before you load the vehicle, you should familiarize yourself with the following weight terminology that can be found on the FMVSS/CMVSS label (Federal/Canadian Motor Vehicle Safety Standards) and the vehicle's tire information plate:

Terminology:

Curb weight	Weight of the vehicle, including all oil, fluids and all standard equipment. This does not include passengers, cargo or optional equipment.
Weight capacity	All weight added to the curb weight, including cargo and optional equipment. When towing, trailer hitch tongue load is also part of cargo weight.
Gross vehicle weight	The vehicle's curb weight + cargo + passengers.
Permissible axle weight	The maximum allowed weight that can be carried by an individual axle (front or rear). These figures are specified on the FMVSS/CMVSS label (Federal/Canadian Motor Vehicle Safety Standards). The total load on each axle must never exceed its maximum permitted weight.

Steps for determining correct load limit

1. Locate the statement "The combined weight of occupants and cargo should never exceed XXX kg or XXX lbs." on your vehicle's placard.
2. Determine the combined weight of the driver and passengers that will be riding in your vehicle.
3. Subtract the combined weight of the driver and passengers from XXX kg or XXX lbs.
4. The resulting figure equals the available amount of cargo and luggage load capacity. For example, if the "XXX" amount equals 1400 lbs. and there will be five 150 lb passengers in your vehicle, the amount of available cargo and luggage load capacity is 650 lbs. ($1400 - 750 (5 \times 150) = 650$ lbs.)
5. Determine the combined weight of luggage and cargo being loaded on the vehicle. That weight may not safely exceed the available cargo and luggage load capacity calculated in Step 4.
6. If your vehicle will be towing a trailer, load from your trailer will be transferred to your vehicle. Consult this manual to determine how this reduces the available cargo and luggage load capacity of your vehicle.

12.6. Recommendations for loading

Proper loading is important for safety and vehicle performance on the road.

Loading in general

Load weight and placement affect the vehicle's center of gravity, handling and performance.

 **Warning**

Unsecured cargo

A loose object weighing 20 kg (44 pounds) can, in a frontal collision at a speed of 50 km/h (30 mph), carry the impact of an object weighing 1,000 kg (2,200 pounds). Always follow the loading recommendations to reduce the risk of material damage or personal injury.

- Position heavy cargo as low as possible.
- Always secure cargo to the load-retaining eyelets with straps or web lashings. Otherwise, it may shift during heavy braking or sharp turns. This is particularly important if the rear seats are folded down.
- Do not stow cargo where it may obstruct airbag deployment. If stacked cargo reaches above the upper edge of the windows, be sure to have at least 10 cm (4 inches) of clear space between the window and the cargo. Otherwise, the intended protection of the inflatable curtain, which is concealed behind the panels above the windows, may be compromised.
- Always comply with the vehicle's specifications regarding weight and maximum permitted load.
- When loading the trunk, position cargo firmly against the rear seat backrests.
- Avoid placing cargo against the back of the front seats. This may compromise the effectiveness of the front-seat whiplash protection.
- Cover any sharp edges, corners and protrusions.
- Make sure that all cargo is secure for the duration of travel. You need to regularly check and re-tighten the straps because cargo can move during transit.
- Remove cargo you no longer need from the vehicle. Reducing the vehicle's overall weight improves both performance and range.

Roof loading

 **Important**

Any loads on the roof should not extend above the windshield. This can interfere with vehicle sensors.

Use a load carrier recommended by Volvo when carrying loads on the vehicle's roof. This reduces the risk of damage to the vehicle and helps ensure safety while traveling. Carefully follow the mounting instructions supplied with the load carriers.

Exterior loads affect the vehicle's aerodynamics, handling and sensitivity to crosswinds. Increased drag affects energy consumption and range.

- Position heavy cargo as low as possible.
- Distribute the load evenly across the load carriers.
- For long loads that extend over the hood, install the towing eye at the front of the vehicle and use it to secure the load.
- Drive gently. Avoid rapid acceleration, hard braking and sharp cornering.
- Remove the load carriers when you are not using them. This improves both performance and range. You can store the load carriers in the trunk's cargo hold.

13. Care and maintenance

Keep the interior and exterior of your vehicle in good condition with regular care and maintenance.



This section of the manual covers regular care and cleaning you can do yourself, information about some of your vehicle's components that have specific maintenance needs and service maintenance information.

Note

Volvo's maintenance program

Adhering to your vehicle's maintenance program is highly recommended. A vehicle in good condition contributes to traffic safety and operational reliability.

13.1. Vehicle status

The vehicle status view in the center display is a useful aid for keeping track of your vehicle's health. This is where the vehicle shows you information about any detected issues.

The vehicle status view shows a visual overview of your vehicle and lists any detected issues. The issues are classified depending on severity. A minor issue may be something you can sort out on your own, such as refilling washer fluid. A critical issue may require a workshop visit before you can safely drive the vehicle again. It's recommended to address issues as soon as they appear, especially if they're not minor.

 **Important**

The vehicle is unable to detect and identify all types of issues that can occur. It is therefore important to regularly inspect the car's condition and address any service or maintenance needs you identify. Contact an authorized Volvo workshop for guidance if you are unsure of an issue's severity, regardless of whether it is indicated by the vehicle or not.

To open the vehicle status view, press the vehicle symbol  in the bottom bar and go to **Status**.

13.1.1. Battery status and health

You can find your vehicle's traction battery status and health in the center display.

To open the vehicle status view, press the vehicle symbol  in the bottom bar and go to **Status** and then **Battery**.

Press the information symbol or downward arrow to find more information for each area:

- Charging power** Current estimation of your vehicle's charging power as well as the battery's preconditioning status. You can press the information symbol for more details on the actual charging power and the actual charging limit. If the vehicle is not plugged in, the values will be 0.
- Battery health** Battery state of health is a measure of how much energy can be stored in the battery compared to when it was new. Distance driven since last estimation is also provided.
- Battery temperature** Here you can find information about the battery temperature, which can impact charging speed, range and acceleration.

You will get notifications if functions related to the battery health are affected or if you need to take action somehow.

13.2. Exterior cleaning and care

Keep your vehicle's exterior in good condition by getting rid of dirt and taking care of any paintwork scratches as soon as you notice them. Ensure good visibility by keeping wiper blades in good condition.



Wash your vehicle regularly, top up the washer fluid when needed and replace the wiper blades when they get worn. Taking care of your vehicle's exterior doesn't just make it look nice; it also keeps your vehicle in good condition.

13.2.1. Washing the exterior by hand

To avoid problems with cleaning ingrained dirt, wash the vehicle regularly and as soon as it starts getting dirty. This reduces the risk of scratches and, of course, keeps your vehicle looking good.

 **Important**

When and where to clean the exterior

- Clean your vehicle as soon as it has attracted dust or dirt. This prevents the build-up of ingrained dirt, which often contains larger particles and debris that cause wear and damage, especially during cleaning.
- Remove bird droppings and tree sap or resin as soon as possible. These contain substances that can quickly damage and discolor the paintwork.
- Avoid washing your vehicle in direct sunlight. This can cause cleaning agents or wax to dry out and act as abrasives.
- If the vehicle has been exposed to corrosive substances, such as acid rain, salt, chemicals, iron powder, soot or ash, it needs to be cleaned as soon as possible to prevent damage. In areas with a lot of industrial emissions, more frequent washing is recommended.
- Clean the vehicle in a dedicated cleaning area that collects the wastewater and make sure the water is treated according to environmental regulations. Make sure that there is an oil separator in the cleaning area.

High-pressure washing

- Make sure that doors, windows and hatches are closed.
- Use a circular motion and keep the nozzle at least 30 cm (1 foot) from the vehicle's surface.
- Do not spray directly onto openings or sensitive areas such as locks, cameras, trim, air intakes or the charging port.

Do not wash while charging

Do not wash your vehicle if the charging cable is connected.

 **Note**

- Be gentle and use the right cleaning equipment for the type of surface you are washing.
- Only use cleaning agents and vehicle care products recommended by Volvo, and follow each product's accompanying instructions.

Full exterior washing

1. Start by rinsing the underbody, including the wheel housings and bumpers.
2. Rinse the entire vehicle to dissolve and wash away dirt. For particularly dirty surfaces, you can use a cold degreasing agent.
3. Then use a sponge, car shampoo and plenty of lukewarm water to wash the entire vehicle.
4. Dry the vehicle with a clean, soft chamois cloth or a gentle squeegee. This reduces the risk of stains from dried water droplets, which require additional polishing.
5. Remove dirt from the drainage holes in the doors and clean out the door sills after washing the vehicle.
6. If any tar stains from the road-surface asphalt remain, use a tar remover to get rid of them.

If there are particularly stubborn dirt patches or if you don't get the desired result when cleaning your vehicle, contact Volvo support for advice.

13.2.2. Washing the vehicle in an automatic car wash

Volvo recommends that you wash the vehicle by hand so that you can properly reach all parts of the vehicle. However, an automatic car wash is a simple way to quickly clean your vehicle as soon as it gets dirty.

Note

Volvo recommends that you do not use an automatic car wash during the first few months, when the vehicle is still new. This allows the paintwork to harden properly.

Important

Before using an automatic car wash

- Make sure that doors, windows and hatches are closed.
- To avoid the door handles unfolding while in the car wash, lock the vehicle.
- Reduce the alarm sensitivity if you won't be inside the vehicle while it's being washed.
- Change wiper mode to off.
- Fold the door mirrors in.
- Secure any auxiliary lights.
- Activate air recirculation.
- Deactivate driver support functions so that the vehicle does not automatically brake or give unnecessary warnings.

1. Follow the instructions to drive into the automatic car wash and stop at the designated location.
2. If you are using a tunnel car wash:
 - Put the gear in N and take your foot off the brake. Do not apply the parking brake.If you are using a rollover car wash:
 - Put the gear in P to engage the parking brake.
3. After the wash cycle is complete, follow the instructions and drive out.
4. Be sure to reset any functions you changed before you drove in.

 **Warning**

Always test the brakes after washing, including the parking brake. This helps prevent moisture from causing corrosion, which could reduce brake performance.

If there are particularly stubborn dirt patches or if you don't get the desired results when cleaning your vehicle, contact Volvo support for advice.

13.2.3. Polishing and waxing

If your vehicle loses its luster, it's time for a new coat of polish and wax. This gives the paintwork extra protection.

Feel free to wax your vehicle whenever necessary, but you shouldn't need to polish it during its first year.

 **Important**

Be careful

- Do not polish or use products intended for high-gloss paintwork on surfaces that have matte paintwork. This may create a permanent gloss on the surface.
- Polishing glossy trim moldings could wear away or damage the glossy surface layer.
- Avoid using polish or wax on rubber and unpainted plastic components.

Contact Volvo support for information on recommended cleaning agents and car care products.

1. Make sure the vehicle is protected from direct sunlight. The surface should be no more than 45 °C (113 °F) when applying polish or wax.
2. Wash and dry the vehicle thoroughly.
3. First polish the vehicle, then wax it. Follow the instructions on the packaging carefully. Many products contain both polish and wax.

13.2.4. Touching up paintwork damage

Taking care of your vehicle's paintwork helps to maintain the exterior. Inspect it regularly and repair damage right away to avoid further problems.

Common damage that may occur includes stone chips, scratches and marks along the edges of doors or bumpers.

 **Important**

Paintwork damage in front of a radar can affect the radar's detection capabilities. Contact a service point for repairs if you find any damage near the radars.^[1] If you're unsure about where your vehicle's radars are, you can find an overview of their locations in a separate section of this manual.

 **Note**

Paint batches and brands may differ slightly in color even if the color code is the same. Therefore, even though you can touch up paintwork damage on your own, Volvo recommends that you always contact an authorized Volvo workshop to get help with any paintwork damage.

- Contact a Volvo retailer for recommendations on touch-up pens and spray paints.
 - The surface must be clean and dry before doing any touch-ups.
 - The temperature of the surface should be at least 15 °C (59 °F).
 - Follow the instructions for the touch-up pen or paint you're using.
1. Apply masking tape over the damaged area. Then peel it off to remove all loose paint.
 2. If there are uneven edges, you may need to gently polish around the damaged area using a very fine abrasive cloth. Clean the area thoroughly afterwards and let it dry.
 3. If the damage:
 - has not reached the metal and an undamaged layer of paint remains, you can apply touch-up paint directly to the cleaned surface.
 - has reached the metal, first use a primer.
 - is on a plastic surface, first use an adhesive primer for better results. Spray into the lid of the spray can and brush on a thin layer.
 - is a long scratch, use masking tape around the damaged area to protect the undamaged paintwork.
 4. Stir the primer thoroughly and apply with a fine brush, matchstick or something similar. Let it dry.
 5. Finish with a base coat and clear coat.

^[1] Volvo recommends authorized Volvo workshops for all servicing and repairs.

13.2.4.1. Finding the paint color code

Small windshield cracks or chips can quickly spread, turning it from minor to severe damage. Contact an authorized Volvo workshop if you notice glass damage. Repair the windshield as soon as possible.

 **Important**

Camera and sensor area

Any windshield damage in the camera and sensor area, including small chips, scratches or cracks, can negatively affect forward detection and features that use it.

- Any windshield damage in this area requires inspection by a service technician.
- Volvo recommends not repairing small damage in the camera and sensor area. Instead, the entire windshield should be replaced.

Severe glass damage

If the windshield suffers severe damage, the entire glass panel needs to be replaced.

 **Warning**

Compromised safety

Do not drive the vehicle if there is structural damage to the windshield. Weakened glass can degrade very quickly, impair visibility and seriously compromise safety.

 **Note**

Compatibility of new windshield

It's important that the new windshield and its installation meet Volvo's specifications for safety and compatibility with the vehicle's features.

Calibration

When a windshield is installed, the forward-facing camera behind the glass requires function checks and calibration by a service technician to ensure that it works correctly.

13.2.6. Refilling washer fluid

The washer fluid reservoir cap is located under the hood. Be sure to use high-quality washer fluid.

The vehicle notifies you when the washer fluid level is getting low.^[1]

Note

Reservoir capacity

Your vehicle can hold 10.2 liters (approximately 10.8 U.S. quarts) of washer fluid.

Important

Washer fluid quality

- Use washer fluid with a pH between 6 and 8.
- If you use concentrated washer fluid, dilute it as instructed on the packaging and use clean pH-neutral water.
- Volvo recommends washer fluid with antifreeze in cold conditions, especially in temperatures below freezing. This is to prevent damage caused by the fluid freezing inside the pump, reservoir and hoses.

1. Open your vehicle's hood.

2.



Locate the blue cap with the washer fluid symbol and open it.

3. Pour the washer fluid into the reservoir. Avoid spillage if possible.

4. Close the cap and hood.

^[1] When there is about 1 liter (1 quart) left.

13.2.7. Cleaning wipers

Dirt, dust, sand, insects and different weather conditions are just a few of the things your wipers take care of. It's important to clean your wipers regularly to maintain good visibility and prolong the blades' service life.

1. Activate the wiper service position via settings in the center display. This gives you better access to the front wiper blades.
2. Rinse the area with water to get rid of any loose dust and dirt.
3. Use a soft sponge with a lukewarm soap solution or car shampoo to clean the area. Lift the wiper arms from the windshield for better access.
4. Use a clean, soft cloth to dry the wipers.
5. Make sure the wiper arms are folded back down against the windshield, and then deactivate the wiper service position.

 **Important**

Test the wipers before driving. Use plenty of washer fluid when the wipers are in motion. The windshield must be wet for the wipers to work properly.

13.2.8. Replacing front wiper blades

Your front wiper blades' service life is affected by the water, dirt and debris that they sweep off your windshield. The wiper blades need to be replaced when they show signs of wear.

1. Activate the wiper service position via settings in the center display.

2.



Fold the wipers up and away from the windshield.

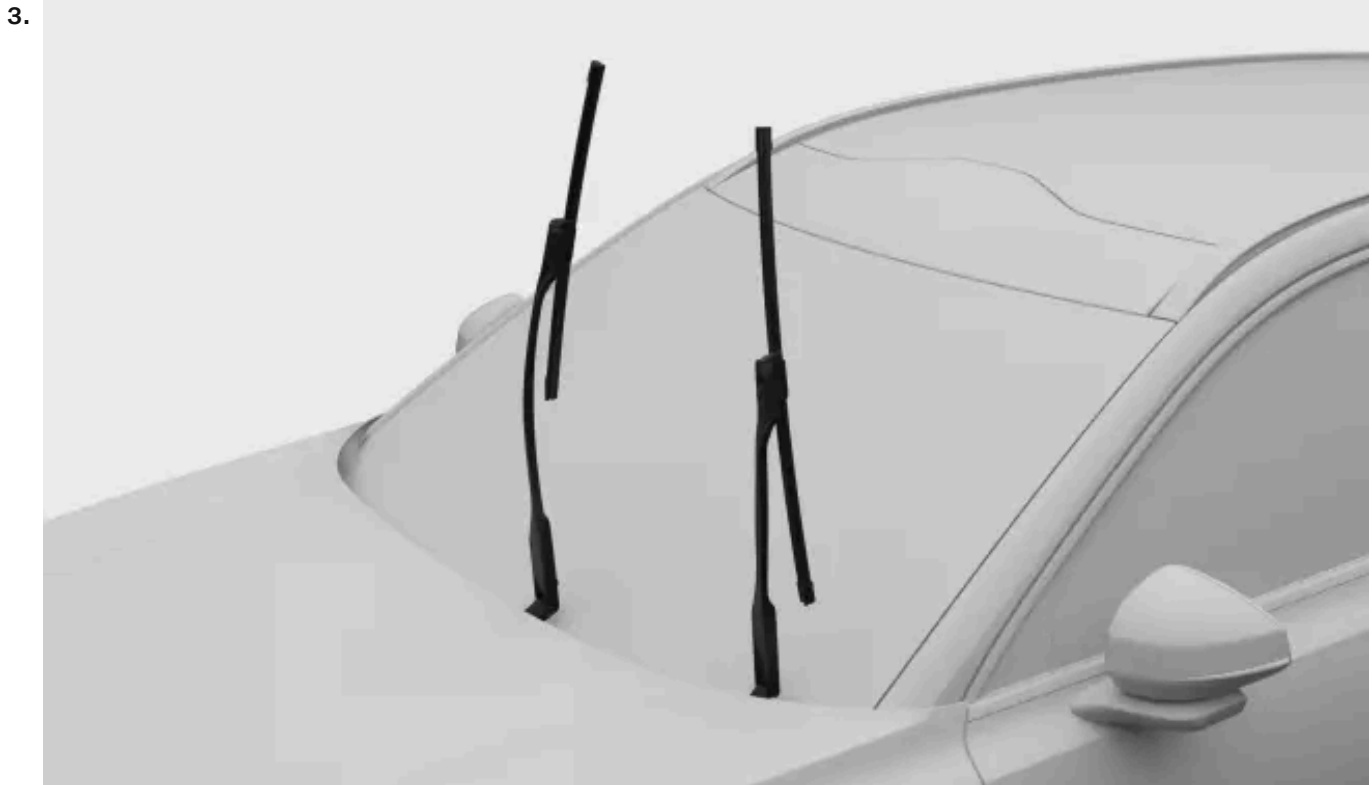

Carefully pull the lower half of the wiper blade upwards until the blade is horizontal.



Remove the wiper blade from the wiper arm.

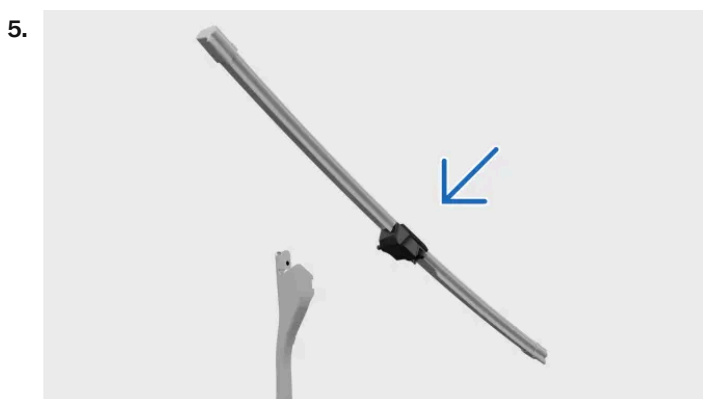

Make sure that the blade for the driver side is longer than the blade for the passenger side. Whilst keeping the wiper blade horizontal, slide the wiper blade onto the wiper arm. Ensure that the pin on the wiper arm goes into the hole on the wiper blade.

6. Grasp the lower part of the wiper blade and move it back down so that the blade is vertical. Push the blade into the wiper arm until you hear a click.

The content of this manual represents the status of the user manual at the time of printing and may not be completely valid in future instances. For more information refer to the first page for the complete disclaimer note.

7. Check that the blade is firmly attached.
8. Fold the wiper arms back down against the windshield.
9. Deactivate the wiper service position.

13.2.9. Replacing the rear wiper blade

Your rear wiper blade's service life is affected by the water, dirt and debris that it sweeps off your rear windshield. The wiper blade needs to be replaced when it shows signs of wear.

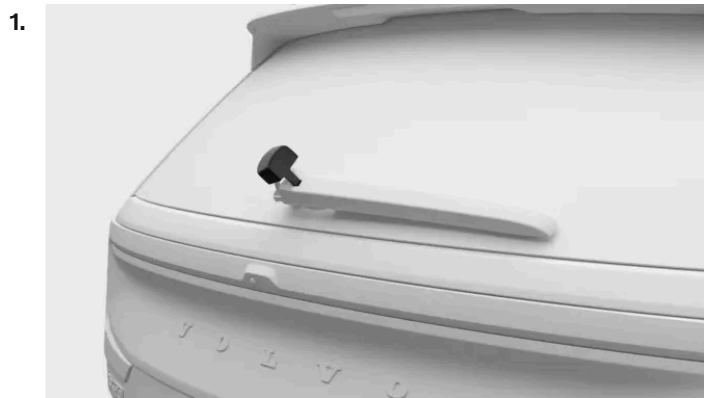

Find the plastic cover where the wiper arm attaches to the vehicle. Loosen the side of the cover closest to you first and then the side furthest away from you. Lift the plastic cover all the way. This will give you access to the hose connector.



The content of this manual represents the status of the user manual at the time of printing and may not be completely valid in future instances. For more information refer to the first page for the complete disclaimer note.

Disconnect the hose from the connector. You might need to wiggle it to get it loose.



Grasp the center of the wiper arm and lift it up and away from the rear windshield. You may feel some resistance halfway – this is the lock position. You need to pull the wiper arm past the lock position so that it doesn't fall back onto the windshield



Pull the blade down until it loosens and comes away from the wiper arm.



Press the new blade into place until you hear a click.

6. Check that the blade is firmly attached to the wiper arm.

7.



Fold the arm back down against the windshield.

8.



Connect the wiper blade hose to the hose connector. Lower the plastic cover back down.

***i* Note**

Make sure that the hose is positioned so that it doesn't get trapped or pinched when you lower the plastic cover again.

13.2.10. Activating the wiper service position

The wiper service position allows you to clean or replace the front wiper blades. When activated, the wipers move to a more accessible position on the windshield.

1. Press the vehicle symbol  in the bottom bar and go to **Settings**.
 2. Go to **Controls** → **Mirrors and wipers** → **Wipers** → **Wiper service position**.
 3. Activate the service position.
- > The wipers move to a more accessible position and can be lifted up from the windshield for servicing.

 **Important**

Fold the wipers down

Be sure to fold the wipers back down against the windshield after servicing them. Activating the wipers when they are in a raised position can damage the vehicle.

Once you have folded the wipers back down, deactivate the service position. This can be done by either of these options:

- The setting in the center display.
- Start driving.
- Start using the wipers or washers.

13.2.11. Corrosion protection

A good way to reduce the risk of corrosion is to keep your vehicle clean. Your vehicle also has durable corrosion protection.

Normally, the corrosion protection doesn't require maintenance apart from regular cleaning and washing, which removes corrosive substances. Avoid using strong alkaline or acidic cleaning solutions on glossy trim components because they can cause corrosion. Road surfaces with gravel or small stones can lead to paint chips that can act as entry points for corrosion. Deal with such damage as soon as you notice it.

The vehicle body's corrosion and abrasion protection consists of:

- protective coatings, both on the sheet metal and applied in a high-quality painting process
- shielding with plastic components
- corrosion-resistant cast aluminum used for exposed components of the wheel suspension.

13.3. Interior cleaning and care

The content of this manual represents the status of the user manual at the time of printing and may not be completely valid in future instances. For more information refer to the first page for the complete disclaimer note.

Keep the interior of your vehicle in good condition by taking care of its materials and keeping them clean.

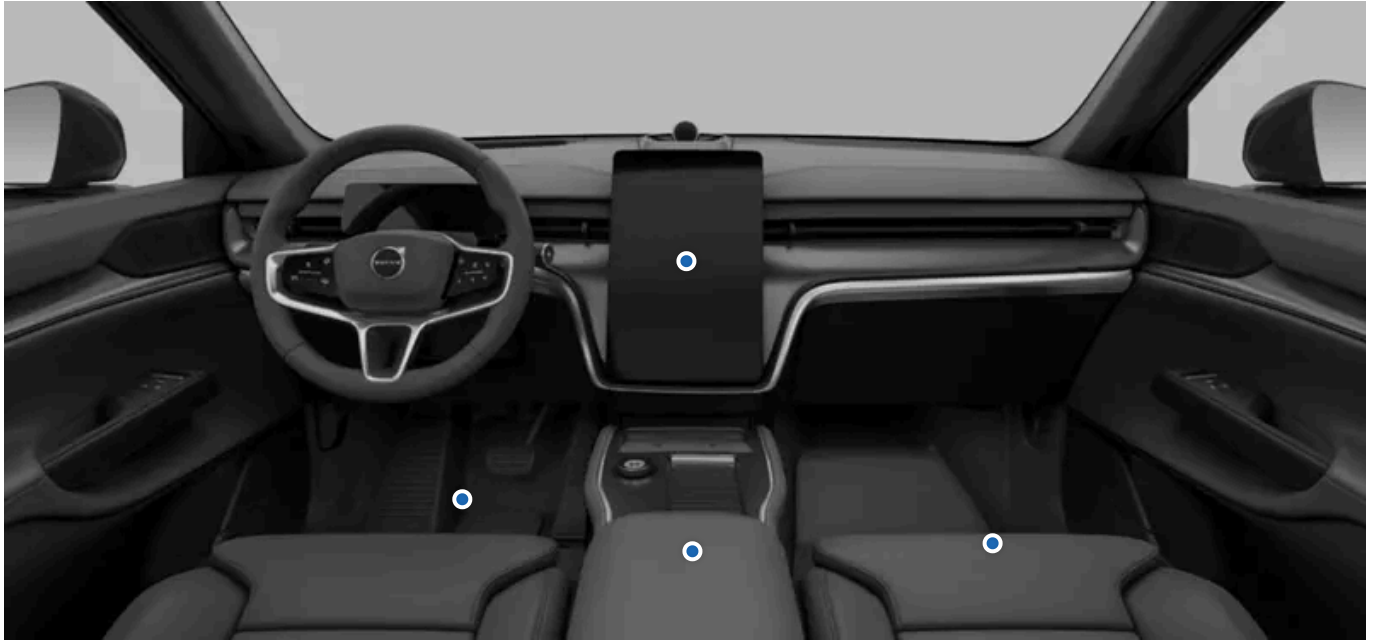

Use the passenger compartment storage areas and cup holders to keep your vehicle tidy. Always take care of stains and dirt as soon as you notice them to avoid permanent staining.

If there are particularly stubborn dirt patches, or if you don't get the desired result when cleaning your vehicle, contact Volvo Support for advice.

13.3.1. Cleaning fabrics and textiles

If you get a stain on the vehicle's interior, such as on the headlining or seat upholstery, clean it as soon as possible.

These recommendations apply to various interior fabrics.

 **Important**

When cleaning upholstery

- Never scrape or rub dirty surfaces. Instead, use gentle circular motions. Remember that sharp objects or abrasive materials can damage the vehicle.
- Always clean the entire upholstery. Cleaning only isolated spots on the upholstery can leave water rings or other marks.
- Do not remove surface upholstery during cleaning.
- Certain clothes, such as jeans or suede, can discolor the textile upholstery.
- Be careful when cleaning the headliner as harsh treatment may damage it.
- Only use cleaning agents and vehicle care products recommended for cleaning textiles, and follow each product's accompanying instructions.

 **Warning**

Seats with side airbags

Never spray a cleaning agent directly on the sides of seats with side airbags. Instead, wipe them clean with a cloth lightly dampened with a suitable cleaning agent.

1. Vacuum or dust the area to remove loose dust and dirt.
2. Clean the area with a neutral-colored, clean and lint-free microfiber cloth that is lightly dampened with water or a colorless, mild cleaning agent. Use gentle circular motions.

 **Tip**

To wash the textile upholstery, an upholstery cleaning machine is recommended for extracting the cleaning solution and performing a water rinse.

3. Let the material dry fully before use.

 **Important**

Cleaning seat belts

When cleaning a seat belt, keep it extended until fully dry.

13.3.2. Cleaning leather and vinyl

The leather and vinyl in your vehicle can be impacted by dirt and colored garments over time. You need to clean and treat the surface to make it more resistant to damage.

These leather cleaning recommendations only apply to real leather details.

 **Important**

When cleaning upholstery

- Never scrape or rub dirty surfaces. Instead, use gentle circular motions. Remember that sharp objects or abrasive materials can damage the vehicle.
- Do not use a steam cleaner on leather.
- Do not remove surface upholstery during cleaning.
- Do not use leather and vinyl cleaner on textile surfaces.
- Only use cleaning agents and vehicle care products recommended by Volvo, and follow each product's accompanying instructions. Contact Volvo Support for more information.

 **Warning**

Seats with side airbags

Never spray a cleaning agent directly on the sides of seats with side airbags. Instead, wipe them clean with a cloth lightly dampened with a suitable cleaning agent.

1. Vacuum or dust the area to remove loose dust and dirt.
2. Use a neutral-colored, clean microfiber cloth lightly dampened with cleaning agent and clean the area using gentle circular motions.
3. Let the upholstery dry fully before further use or applying any treatments.

13.3.3. Cleaning glass and glossy surfaces

Clean surfaces such as displays, mirrors and touch buttons regularly and gently.

 **Important**

When cleaning glass and glossy surfaces

Do not scrape or use any abrasive cleaning agent on displays, mirrors and touch buttons. This can damage the reflective surface.

1. Vacuum or dust the area to remove loose dust and dirt.
2. Use a clean microfiber cloth lightly dampened with water and clean the area with a gentle circular motion.
3. Let the surface dry fully before use.

13.3.4. Cleaning interior plastic, metal, and wood components

Clean panels and controls regularly, and deal with stains straightaway.

 **Important**

Be gentle

Never scrape or rub dirty surfaces. Instead, use gentle circular motions. Remember that sharp objects or abrasive materials can damage the vehicle.

1. Vacuum or dust the area to remove loose dust and dirt.
2. Use a clean microfiber cloth lightly dampened with water and clean the area with a gentle circular motion.

 **Important**

Never spray fluids directly on electrical components such as buttons or controls.

3. Let the material dry fully before use.

13.3.5. Cleaning mats

Clean the mats regularly and always make sure they are properly in place.

 **Important**

Be gentle

Never scrape or rub dirty surfaces. Instead, use gentle circular motions. Remember that sharp objects or abrasive materials can damage the vehicle.

1. Remove the mats for separate cleaning and access to the floor. Grasp the mat by the fastening pins and lift it straight up.
2. Vacuum the mats and floor to remove loose dust and dirt. Do not shake or beat the mats to remove dust and dirt, as they can crack.
3. Clean the area with a neutral-colored, clean microfiber cloth that is lightly dampened with water or a colorless, mild cleaning agent. Use gentle circular motions.
4. Let the mat dry fully before putting it back. Secure it in place by pressing down near each pin.

 **Warning**

Only use one mat for each seat and make sure the mats are properly fastened using all pins. If the driver's mat is not properly attached, it can move around and hinder driving by getting caught near or under the pedals.

13.4. Wheels and tires

The purpose of the tires is to carry your vehicle's load, ensure a good grip on the road surface, reduce vibration and protect the wheel rim from wear. Familiarize yourself with the recommendations to get the most out of your wheels and tires.



Familiarize yourself with tasks such as how to maintain the correct tire pressure and how to change tires so you are comfortable in these situations.

13.4.1. Wheel and tire recommendations

Volvo recommends that you only use wheel rims and tires that have been tested and approved by Volvo and are genuine Volvo accessories. A complete wheel refers to a tire mounted onto a wheel rim.

Recommended tires

On delivery, the vehicle is equipped with Volvo original tires that have the VOL marking on their sides^[1]. These tires are carefully adapted to the vehicle. It is therefore important to use new tires with this marking when you change tires, in order to maintain the vehicle's driving characteristics, comfort and electricity consumption.

Original tires

Your vehicle is originally equipped with tires that match the data on the label found on the pillar by the driver door.

The tires have good road-holding properties and provide good driving characteristics on dry and wet road surfaces. Remember, however, that the tires have been developed to provide these properties on roads that are free from ice and snow. Even if the vehicle is equipped with stability systems or all-wheel drive, these tires are not designed for winter driving. Change to winter tires when the weather requires you to.

Some vehicles are equipped with tire and rim combinations that offer with extra-high performance. They are designed to be capable on dry road surfaces and with resistance against aquaplaning. These may be more sensitive to damage on the road surface and, depending on conditions, may have a shorter service life.

All-season tires provide slightly better roadholding on slippery road surfaces than tires without the "all-season" classification. However, for good road-holding on icy or snow-covered roads, Volvo recommends winter tires on all four wheels.

Tire age

Volvo recommends that tires should be changed after 6 years from the date when they are first used. If you are unable to determine the date, use the DOT^[2] marking on the tire sidewall. Tires age and deteriorate over time, even if they are rarely used. The function can therefore be affected. Heat caused by hot climates, frequently carrying heavy loads or exposure to ultraviolet (UV) radiation may accelerate the aging process. Cracks or discoloration are examples of external signs indicating that the tire is unsuitable for use. A tire that has visible signs of deterioration should be changed immediately.

Replacing tires

Note that the front and rear wheel pairs have different dimensions. Never swap the originally mounted wheels between the front and rear axles.

When you replace your tires, you must make sure that all four tires have the right size designation for their corresponding axle, are of the same type (radial) and are preferably from the same manufacturer as the original tires. Volvo recommends that you use VOL-marked tires. Otherwise there is a risk of changing the vehicle's roadholding properties and driving characteristics.

If the wheels are mounted incorrectly, the vehicle's braking characteristics and capacity to deflect rain and slush are adversely affected.

Wheel rims and tire sizes

Warning

- Your Volvo's wheel rim and tire sizes are specified to meet stringent requirements for stability and driving characteristics. Unapproved combinations of wheel rim size and tire size may have a negative effect on vehicle stability and driving characteristics.
- Any damage caused by the mounting of unapproved combinations of wheel rim size and tire size are not covered by the new vehicle warranty. Volvo accepts no liability for death, personal injury or any costs caused by such installations.
- Do not use steel or aluminum wheel rims that are damaged, cracked or deformed, that have extensive corrosion damage, or that have been welded or repaired.

^[1] There may be deviations for certain tire dimensions.

^[2] Department of Transportation

13.4.1.1. Tires and wheel storage

To keep them in good condition, you should always store wheels that are not in use in a cool, dry, dark place. It is important to position them correctly and avoid exposure to chemicals.

When not in use, It is important to store wheels away from direct sunlight, rain, water, heat sources or sparks. You should never store them near solvents, gasoline, oils or similar substances – especially flammable ones.

Store wheels ^[1] hung up or lying on their sides on the floor. Never hang up tires not installed on rims for storage. Be sure to store them standing upright or lying on their sides. If you hang up tires without their rims, they may become deformed.

^[1] Tires installed on rims

13.4.1.2. Tire economy

To preserve your tires as much as possible, there are some things you should keep in mind.

- Correct tire pressure reduces uneven wear. It's important to check the pressure regularly.
- Hard acceleration, heavy braking and driving in a way which causes screeching tires lead to increased tire wear.
- Tire wear increases with speed.
- Unbalanced wheels cause uneven and excessive tire wear, as well as reduced ride comfort.
- Wheels must have the same direction of rotation during their entire service life.

- The rear tire grip should always be equal to or better than the front tire grip to reduce the risk of oversteering in case of heavy braking.
- Tires or wheel rims may be damaged permanently if you hit curbs or drive into deep holes.
- Driving style, road conditions and climate affect the tire wear.

13.4.2. Designations on tire sidewall

There are many digits, numbers and symbols that may be found on a tire's sidewall. Here are some examples and explanations of what they indicate.

Note

Be aware that the following tire designations are only examples. Not all of these designations may be available for your tires, and there may be designations on your tires which are not included here.

Tire dimensions

All tires have a designation of dimensions, such as: 265/40 R21 98 W.

- 265** Tire width (mm).
- 40** Ratio between tire wall height and tire width (%).
- R** Radial ply. The designation RF and symbol specify that the vehicle is equipped with puncture-resistant tires.
- 21** Rim diameter (inches).
- 98** Codes for the maximum permitted tire load, Load Index.
- W** Speed rating for maximum permitted speed, Speed Symbol.

Wheel rim dimensions

All wheel rims have a designation of dimensions, such as: 8J x 19 x 50.

- 8** Rim width (inches).
- J** Rim flange profile.
- 19** Rim diameter (inches).
- 50** Offset in mm (distance from wheel center to wheel contact surface against the hub).

Weather condition classification

Here are some classification examples. Weather capabilities can also be defined with certain symbols.

- M+S or M/S** Mud and Snow.
- AT** All Terrain.
- AS** All Season.

Tire age

DOT YLX2 0819 Tire Identification Number or TIN. This information helps the tire manufacturer identify tires in the event of safety recalls.

1. DOT^[1]
2. The first two or three characters are the code for the plant where the tire was manufactured.
3. The next two characters are the tire's size code.
4. The last four digits specify the week and year the tire was manufactured. For example, 0819 means that the tire was manufactured during week 08, year 2019.

Any numbers or letters shown in between are market codes chosen by the manufacturer.

Max load and pressure

Max load 685 kg (1610 lbs). Specifies the maximum load that the tire can carry.

Max pressure 240 kPa (35 psi). The maximum tire pressure that the tire should ever be subjected to. This limit is specified by the tire manufacturer.

Minimum permitted load index and speed rating

The tire load index and speed rating might not be shown on the sidewall as this is not a legal requirement.

Type, materials and tire rotation

P	Indicates that the tire is for passenger vehicles.
VOL	Volvo original tires.
Ply: Tread 2 polyester, 2 steel, 1 polyamide. Sidewall 2 polyester.	States the number of cord layers or number of layers with rubber-coated fabric in the tire's tread and sidewall. The tire manufacturers must also state the layer materials used in the tire and sidewall, which may be steel, nylon, polyester and certain other materials.
Arrow symbol	Tires with a tread pattern designed to only turn in one direction have the direction of rotation marked with an arrow.

Classification of uniform tire quality

Tread wear grade 200	The tread wear grade is a comparative rating based on the wear rate of the tire in a standardized test. A higher value is better.
Traction grade AA	The traction grade is based on standardized straight-ahead braking traction tests. The traction grades, from highest to lowest, are AA, A, B and C.
Temperature grade A	The temperature grade reflects the thermal performance of a tire that is properly inflated and not overloaded. The temperature grades, from highest to lowest, are A, B and C.

From the Consumer Guide to Uniform Tire Quality Grading

The purpose of this section is to aid the consumer in making an informed choice in the purchase of passenger vehicle tires.

All passenger vehicle tires must meet federal safety requirements apart from this classification.

Tread wear

The tread wear grade is a comparative rating based on the wear rate of the tire when tested under controlled conditions on a specified government test course. For example, a tire graded 150 would wear one and one-half (1 1/2) times as well on the government course as a tire graded 100. The relative performance of tires depends upon the actual conditions of their use, however, and may depart significantly from the norm due to variations in driving habits, service practices and differences in road characteristics and climate.

Traction

The traction grades, from highest to lowest, are AA, A, B, and C. Those grades represent the tire's ability to stop on wet sidewalk as measured under controlled conditions on specified government asphalt and concrete test surfaces. A tire marked C may have poor traction performance. Warning: The traction grade assigned to this tire is based on straight-ahead braking traction tests, and does not include acceleration, cornering, hydroplaning, or peak traction characteristics.

Temperature

The temperature grades are A (the highest), B, and C, representing the tire's resistance to the generation of heat and its ability to dissipate heat when tested under controlled conditions on a specified indoor laboratory test wheel. Sustained high temperature can cause the material of the tire to degenerate and reduce tire life, and excessive temperature can lead to sudden tire failure. The grade C corresponds to a level of performance that all passenger vehicle tires must meet under the Federal Motor Safety Standard No. 109. Grades B and A represent higher levels of performance on the laboratory test wheel than the minimum required by law. Warning: The temperature grade for this tire is established for a tire that is properly inflated and not overloaded. Excessive speed, underinflation, or excessive loading, either separately or in combination, can cause heat buildup and possible tire failure.

^[1] Department of Transportation

13.4.2.1. Tire tread wear indicators

There are tread wear indicators to show the status of the tire's tread depth.



The narrow grooves that run lengthwise across the tire's tread pattern are tread wear indicators. On the side of the tire are the letters TWI^[1].

Important

- Tires should be changed before wearing them down to the tread wear indicators to avoid poor traction in rain and snow.
- Volvo recommends that winter tires have a greater tread depth than 4 millimeters (1/8 inch) and summer tires 1.6 millimetres (1/16 inch).

^[1] Tread Wear Indicator

The content of this manual represents the status of the user manual at the time of printing and may not be completely valid in future instances. For more information refer to the first page for the complete disclaimer note.

13.4.3. Changing wheels

If you need to change a wheel, it's important to follow the recommended procedure.

Warning

Raising the vehicle to change a wheel

Changing a wheel requires that you raise the wheel off the ground. Carefully follow the separate instructions for raising the vehicle safely.

- If you are changing a wheel in or close to traffic, make sure you and the vehicle are clearly visible to others. Activate the hazard warning flasher, put out a warning triangle in a visible but safe place and wear a reflective vest.
- Designate a safe space for passengers to wait, away from both the vehicle and traffic.
- You are responsible for safety around the vehicle while it is raised. Do not allow people inside or close to the vehicle.
- Never get under the vehicle or let anyone reach under it with any part of their body while it is raised with a jack.

Note

You must activate jack mode before raising the vehicle off the ground.

Before removing the wheel

The wheels on your vehicle are fastened with wheel bolts. For extra security, you can use lockable bolts.

Important

- Make sure that the dimensions of the replacement wheel are approved for your vehicle.^[1]
- Make sure you read through all the instructions before you start. Get all the tools you need before the vehicle is raised.^[2]

Removing the wheel

1. Remove the wheel fastener cap manually. You don't need any tools to do this.
2. While your vehicle is still on the ground, use the wheel wrench to loosen the wheel fasteners approximately 0.5-1 turn. Press the wrench downwards while the wrench is extended to the left to avoid personal injury. The counterclockwise rotation loosens the fastener. If you have fasteners that are lockable bolts, start with them.
3. Follow the instructions on how to safely raise the vehicle. Be sure to activate jack mode.
4. Raise the vehicle high enough so that the wheel you want to remove is off the ground. Remove the fasteners and lift off the wheel.

The content of this manual represents the status of the user manual at the time of printing and may not be completely valid in future instances. For more information refer to the first page for the complete disclaimer note.

i Tip

When switching wheels between winter and summer, mark which side they were mounted on, for example L for left and R for right.

Mounting the wheel

5. Clean the surfaces between the wheel and hub.
6. Mount the wheel. Make sure you tighten the fasteners. However, the final tightening to the specified torque is done when the wheel is back on the ground and unable to rotate while you do it.

⚠ Warning

- The front and rear wheels are different sizes. Make sure you put them on the correct axle. Incorrectly mounted wheels can affect the vehicle's handling.
- Never use lubricant on the wheel fastener threads. This could cause the wheel fasteners to loosen after tightening.

7. Lower the vehicle back to the ground.
8. Fasten the fasteners crosswise. If you are using lockable bolts, finish with those.
It's very important to secure the fasteners properly. Tighten to 140 Nm (103 lb-ft). Check the tightening torque with a torque wrench. Over-tightened or loosely tightened fasteners may damage the fastening threads or the wheel itself.



Tighten the wheel fasteners crosswise.

9. Place the hubcap back over the wheel nuts, using the guide markers to position it correctly then press it into place. Ensure that it's securely fastened.
10. Check the tire pressure and store a new reference value in the tire pressure monitoring system.



Warning

Check the wheel fasteners

The wheel fasteners may need to be re-tightened a few days after the wheel has been changed. Temperature differences and vibrations may cause them to loosen.

Wheel properties after a wheel change

Be attentive to signs of incorrectly mounted wheels. This could affect the vehicle's braking characteristics and the ability to deflect rain and slush.

When you have changed the type or size of the wheels, you should drive carefully at first. The dynamics and driving characteristics of the wheels may have changed.

^[1] Some spare wheels have different dimensions. If your vehicle is approved for the spare wheel you intend to use, the difference in dimensions is okay.

^[2] Use tools that are designed for your vehicle model.

13.4.3.1. Spare wheel

If you get a flat tire, a spare wheel^[1] can be temporarily used until the original wheel can be replaced or repaired.

The spare wheel is only designed for temporary use. You should replace the spare wheel with an ordinary wheel as soon as possible.

When not in use, you should store the spare wheel in a bag on the floor of the trunk. It must be secured by two straps that are tensioned crosswise over the wheel and attached to the vehicle's four load-retaining eyelets.

 **Warning**

Before driving with a spare wheel

- Only use a spare wheel that is approved for your vehicle.
- Never drive your vehicle with more than one spare wheel mounted.
- Snow chains cannot be used if the spare wheel is mounted on the front axle.
- The spare wheel should never be repaired.
- Make sure to follow the spare wheel manufacturer's recommendations regarding tire pressure.

Driving with a spare wheel

- Never drive faster than 80 km/h (50 mph) when a spare wheel is mounted on your vehicle.
- Current laws prevents the use of the temporary spare wheel for anything other than as a temporary replacement for a punctured tire.
- Your vehicle's driving characteristics may be affected by using a spare wheel. It is important to replace the spare wheel with an original wheel as soon as possible.

 **Important**

The spare wheel is smaller than your vehicle's original wheels. This will affect the vehicle's ground clearance. Pay attention to high curbs, and don't wash your vehicle in an automatic car wash.

 **Note**

While a spare wheel is used, the tire pressure monitoring system might not work correctly.

^[1] The spare wheel must be of the Temporary Spare type.

13.4.3.2. Winter tires

Winter tires are designed for driving in road conditions with ice and snow. Winter tire tread depth should be deeper than that of regular tires.

Dimensions

When driving with winter tires, it's important that all four tires are of the correct type. Contact a Volvo retailer for advice.

Studded tires

Studded winter tires should be run-in gently for 500-1,000 km (300-600 miles) so that the studs settle properly into the tires. This gives the tire, and especially the studs, a longer service life.

The content of this manual represents the status of the user manual at the time of printing and may not be completely valid in future instances. For more information refer to the first page for the complete disclaimer note.

 **Note**

Legal regulations regarding the use of studded tires may vary. Make sure the tires you have mounted are in full compliance with local regulations and laws.

Tread depth

Road conditions with ice, slush, snow and low temperatures put higher demands on your tires than summer conditions. Volvo recommends that winter tires have a tread depth of at least 4 millimeters (0.15 inch).

 **Note**

Speed rating

Winter tires ^[1] are allowed to have a lower speed rating than your vehicle's top speed. However, if your winter tires do have a lower speed rating than your vehicle's top speed, you are not allowed to drive faster than tire speed rating.

^[1] Both studded and stud-free tires

13.4.3.3. Using snow chains

Using snow chains can help to improve traction in winter conditions. However, there are some restrictions you have to keep in mind.

 **Warning**

You can use snow chains on your vehicle, with the following restrictions:

- Use genuine Volvo snow chains or equivalent chains designed for the vehicle model, tire and wheel rim dimensions.
- Only single-sided snow chains are permitted.
- The wrong snow chains may cause serious damage to the vehicle and lead to an accident.

 **Note**

Using snow chains may result in malfunction of the tire pressure monitoring system.

Mounting snow chains

- Make sure you are in a safe place when mounting or removing the snow chains.
- Always comply with local regulations and laws regarding the use of snow chains.

The content of this manual represents the status of the user manual at the time of printing and may not be completely valid in future instances. For more information refer to the first page for the complete disclaimer note.

- Always carefully follow the mounting instructions from the manufacturer.
- Always use the same type of chain on the left- and right-hand tires.
- Volvo recommends that you do not use snow chains on wheels with dimensions greater than 20 inches.
- Make sure you use the correct size in relation to the wheels.
- Snow chains must only be used on the rear wheels.^[1]
- If wheels of a different size than the original wheels are mounted, certain snow chains must not be used.
- There needs to be sufficient distance between the chains and the vehicle's brakes, suspension and body components. Chains that risk interfering with brake components must not be used.
- If you need to move your vehicle while installing or removing chains, do not let the wheels run over the chain attachments.
- Amount the chains tensioned as tightly as possible and on them at regular intervals.



Tip

Practice mounting the snow chains before winter comes.

Driving with snow chains

- Once the snow chains are mounted, drive about 200 meters (650 feet). Then stop the vehicle and check again that the chains are firmly attached.
- Never exceed the chain manufacturer's specified speed limit. You must never exceed 50 km/h (30 mph) under any circumstances.
- While snow chains improve grip in certain conditions, they negatively affect other driving characteristics. If possible, avoid driving over uneven ground, such as bumps or holes. Also avoid fast or sharp turns and hard braking.
- Avoid driving on ground not covered in snow or ice, as this wears out both the snow chains and the wheels.
- Always have all-wheel drive^[2] enabled in the settings when driving with snow chains.

Contact a Volvo retailer for more information.

^[1] This also applies to all-wheel drive vehicles.

^[2] AWD

13.4.4. Checking the brake discs for wear

The brake discs on your vehicle wear with use over time. Check them to ensure that the braking system is working properly.

Each brake disc has a minimum thickness value engraved or printed on the brake disc itself. Measuring the thickness of the brake discs with vernier calipers or an equivalent tool from time to time can help you determine whether they need to be replaced.

 **Warning**

Raising the vehicle to remove a wheel

Removing a wheel requires that you raise the wheel off the ground. Carefully follow the separate instructions for raising the vehicle safely.

- If you are removing a wheel in or near traffic, make sure you and the vehicle are clearly visible to others. Activate the hazard warning flasher, put out a warning triangle in a visible but safe place and wear a reflective vest.
- Designate a safe space for passengers to wait, away from both the vehicle and traffic.
- You are responsible for safety around the vehicle while it is raised. Do not allow people inside or close to the vehicle.
- Never get under the vehicle or let anyone reach under it with any part of their body while it is raised with a jack.

 **Note**

You must activate jack mode before raising the vehicle off the ground.

1. Remove the wheel.
2. Inspect the surface of the brake disc for wear and measure its thickness.

 **Warning**

If the thickness of brake disc is less than what is indicated by the minimum thickness value, the brake disc should be replaced immediately. Continuing to use worn components beyond this limit can reduce braking performance and compromise safety.

 **Important**

Brake wear indicators

Your vehicle is equipped with electrical brake pad wear indicators that monitor the condition of the brake pads. When the brake pad thickness wears below the safe limit, the brake wear warning symbol appears in the instrument panel.

If the brake wear warning symbol appears, contact an authorized Volvo workshop to have the brake pads inspected and, if necessary, replaced. Driving with worn brake pads can compromise safety and damage the brake discs.

13.4.5. Punctures

If you experience a punctured tire, there are several actions you can take to recover safely, especially if it happens while you are driving.

If the puncture occurs while you are driving, it's important to think about safety first. Activate the hazard warning flashers and, if possible, move the vehicle away from immediate danger. If necessary, call roadside assistance.

Warning

- Do not drive the vehicle if it has a flat tire. It is not safe and will damage the vehicle.
- If possible, exit your vehicle from the side with the least traffic to avoid causing an accident.
- Place a warning triangle so that others are warned of your vehicle well in advance of passing. Remember to first put on a reflective vest if you have one.

Tip

If your vehicle is equipped with a temporary puncture repair kit, be sure to read its instructions before you use it.

13.4.5.1. Temporary puncture repair

Your vehicle is equipped with a temporary puncture repair kit^[1], which can be used to repair a minor flat in a tire. The kit includes a bottle of sealant fluid and a compressor.

Warning

Read through all of the instructions before using the repair kit.

Warning

California Proposition 65

Operating, servicing and maintaining a passenger vehicle or off-highway motor vehicle can expose you to chemicals, including engine exhaust, carbon monoxide, phthalates, and lead, which are known to the State of California to cause cancer and birth defects or other reproductive harm. To minimize exposure, avoid breathing exhaust, do not idle the engine except as necessary, service your vehicle in a well-ventilated area and wear gloves or wash your hands frequently when servicing your vehicle. For more information go to www.P65Warnings.ca.gov/passenger-vehicle [<https://www.p65warnings.ca.gov/products/passenger-vehicle>]. Certain components of this vehicle, such as airbag modules and seat belt pre-tensioners, may contain Perchlorate Material. Special handling may be required for service or vehicle end-of-life disposal. See www.dtsc.ca.gov/hazardouswaste/perchlorate [<https://www.dtsc.ca.gov/hazardouswaste/perchlorate>]. Battery posts, terminals, and related accessories contain lead and lead compounds. Wash hands after handling.

You should not drive faster than 80 km/h (50 mph) after the repair kit has been used on your tires.



Compressor

The compressor is intended to be used for temporary tire repair and is approved by Volvo. You can also use the compressor to check and adjust the tire pressure on your original tires when needed.

The compressor is an electrical device. When it's time to dispose of it, be sure to follow local regulations related to waste management.

Sealant fluid

The sealant fluid works as a temporary repair. It is effective at sealing a tread puncture but should not be used to seal a puncture in the sidewall of the tire. If the tire has larger slits, cracks or similar damage, you should not use the sealant to repair it.

The bottle of sealant fluid needs to be replaced if the expiration date has passed^[2]. The old bottle is considered hazardous waste.

^[1] Also called temporary mobility kit or TMK

^[2] See expiration date on bottle.

13.4.5.1.1. Using the temporary puncture repair kit

When using the temporary puncture repair kit, there are a number of important steps you need to follow. Make sure you read and understand each step before proceeding.

i Note

These instructions apply to the temporary puncture repair kit supplied by Volvo.



Overview of the temporary puncture repair kit compressor

- ① Pressure gauge
- ② Pressure-reducing valve
- ③ Label, maximum permitted speed
- ④ Air hose
- ⑤ Electrical cable



Sealing fluid bottle



Warning

Sealing fluid can be harmful

The sealing fluid contains substances that are harmful if swallowed. The contents can also cause allergic reactions or be otherwise harmful to the respiratory tract, the skin, the central nervous system and the eyes.

Precautions

- Store the kit out of reach of children.
- Avoid prolonged or repeated contact with the skin. If you get sealing fluid on your clothes, remove them.
- Wash hands thoroughly after handling.

First aid

- Ingestion: Do not induce vomiting unless directed to do so by medical personnel. Get medical attention.
- Skin: Wash affected areas of skin with soap and water. Get medical attention if symptoms occur.
- Eyes: Flush with plenty of water for least 15 minutes, occasionally lifting the upper and lower eyelids. Get medical attention if symptoms occur.
- Inhalation: Move the exposed person to fresh air. If irritation persists, get medical attention.

- Make sure the compressor power button is in the off position before starting.
- Don't remove the air hose during repair.
- If the puncture was caused by a nail or similar and it's still in the tire, leave it in. This helps to seal the puncture.
- If the repair is carried out in an area where there might be other vehicles, activate the hazard warning flashers and use a warning triangle, if you have one.

Preparations

1. Place the label showing maximum speed so that it is clearly visible as a reminder for the driver: for example, on the windshield. You will find it on the compressor.
2. Remove the TMK label from the sealing fluid bottle and place it on the rim of the tire. This helps you remember which one to replace.
3. Screw the bottle to the bottom of the bottle holder, which is located on the compressor where you originally found the label showing maximum speed. There is a reverse catch to prevent leakage. After the bottle is attached you won't be able to remove it. It can only be removed at a workshop^[1].
4. Attach one end of the air hose to the top of the sealing fluid bottle where you found the TMK label.
5. Unscrew the tire valve cap and attach the other end of the air hose to the tire. Screw the air hose connector as far down on the thread as possible.

Begin puncture repairs

6. Connect the compressor to the vehicle's 12 V outlet and ensure that the outlet works and is supplying current.^[2]
7. Start the compressor by pressing the power button.

- > The compressor pressure increases. The pressure may temporarily reach as high as 6 bar (87 psi) before settling after about 30 seconds.

 **Warning**

Never stand next to the tire while the compressor is on. If cracks or bumps appear, the compressor must be turned off immediately. Stop and contact Volvo Assistance for safe recovery.

8. Inflate the tire for 7 minutes or until the pressure reaches 3.5 bar (51 psi).

 **Important**

To avoid overheating, do not run the compressor for more than 10 minutes.

9. Shut the compressor off to check the pressure on the pressure gauge. Minimum pressure is 1.8 bar (26 psi) and maximum is 3.5 bar (51 psi). Use the pressure-reducing valve if the pressure is too high.

 **Warning**

If the pressure is below 1.8 bar (26 psi), the hole in the tire is too big. Do not continue and contact Volvo Assistance for safe recovery.

10. Unplug the compressor from the 12 V socket.
11. Unscrew the air hose from the tire and use the protective cap to prevent the remaining sealing fluid from leaking out.
12. Replace the tire valve cap.
13. As soon as possible, drive for 10 minutes^[3] and let the fluid seal the tire. After that, perform a follow-up check.

Follow-up check

14. With the compressor shut off, connect the air hose to the tire valve.
15. Check the tire pressure on the pressure gauge.
 - > • If it is below 1.3 bar (19 psi), the tire is insufficiently sealed. Stop and contact Volvo Assistance for safe recovery.
 - If the tire pressure is higher than 1.3 bar (19 psi), the tire must be inflated to the pressure specified on the tire pressure label on the driver's side door pillar. The pressure must be at least 2.0 bar (29 psi) to continue driving. If the pressure is below 2.0 bar (29 psi), call Volvo Assistance. If the pressure is too high, release air using the pressure-reducing valve.

16. Replace the tire valve cap.

- Replace the sealing fluid bottle and hose after use. Contact a Volvo retailer to do so.
- Volvo recommends replacing or repairing the damaged tire as soon as possible. Inform the workshop that the tire contains sealing fluid.

 **Warning**

Maximum mileage with tires containing sealing fluid is 200 km (120 miles).

- [1] An authorized Volvo workshop is recommended.
- [2] The outlet no longer supplies power 10 minutes after the driver has exited the vehicle. To resume power, just get back in the vehicle again.
- [3] Or 3 kilometers (2 miles)

13.4.5.1.2. Inflating tires with the puncture repair compressor

Your vehicle's tires can be inflated with the compressor that is included in the temporary puncture repair kit.

Make sure the compressor power button is in the off position before starting.

1. Attach one end of the air hose to the compressor where the speed limit label is located. Unscrew the tire valve cap and attach the other end of the air hose to the tire. Screw the air hose connector as far down on the thread as possible.
2. Connect the compressor to the vehicle's 12 V outlet and ensure that the outlet works and is supplying current.^[1]
3. Start the compressor by pressing the power button.

 **Important**

To avoid overheating, do not run the compressor for more than 10 minutes at a time.

4. Check the tire pressure on the compressor's pressure gauge^[2]. Use the pressure-reducing valve if the pressure is too high.
5. Turn off the compressor and unplug it from the 12 V socket.
6. Unscrew the air hose from the tire.
7. Replace the tire valve cap.

Return the kit to its storage location.

- [1] The outlet no longer supplies power 10 minutes after the driver has exited the vehicle. To resume power, just get back in the vehicle again.
- [2] You can find the recommended tire pressure for the vehicle's original tires on a label on the driver side door pillar.

13.4.6. Tire pressure

Correct tire pressure helps to improve driving stability, lower energy consumption and extend the lifespan of the tire.

Over time, tire pressure decreases. Pressure also varies depending on environmental conditions. All of this is normal. However, if you drive with the wrong tire pressure, the tires may overheat and become damaged. Tire pressure affects ride comfort, noise levels and handling characteristics.

Make it a habit to check the tire pressure monthly and before longer trips. Always make sure you use a reliable pressure gauge. To keep the tires in good shape, use the recommended tire pressure for cold tires.

Warning

If the tire pressure is too high or too low, the tires can sustain severe damage. The tires can explode while you are driving, causing you to lose control of the vehicle.

Tip

Maintaining the correct tire pressure will help you take advantage of your vehicle's full load capacity.

13.4.6.1. Tire pressure monitoring

Your vehicle can detect and indicate when the tire pressure is low. Tire pressure monitoring cannot be disabled. If the system is unable to detect low tire pressure, it will indicate that there's a malfunction.

For the tire pressure monitoring system to provide updated information, you need to drive the vehicle above 30 km/h (20 mph) for several minutes.



An indicator symbol lights up if low tire pressure is detected in any of the tires. It will stay illuminated until the problem is resolved.

In addition to messages in the instrument panel, you can also find information about tire pressure monitoring in the center display vehicle status view.

 **Warning**

No advance warning possible

The system cannot give you any advance warning of potential tire damage.

Ensure correct tire pressure immediately

When the low tire pressure symbol is lit, stop and check the tire pressures as soon as possible. Driving with under-inflated tires can cause tire failure.

If the tire pressure monitoring system is not working correctly, the indicator symbol on the instrument panel will first flash for approximately one minute and then remain lit. A message also appears on the instrument panel. If the fault is permanent, service is required.^[1]

Remember:

- The system does not replace the need for regular tire inspection and maintenance.
- The low tire pressure symbol won't disappear until the low tire pressure has been corrected.
- If the recommended tire pressure has changed, such as when changing tires or loads, you need to save a new tire pressure reference value.

 **Note**

Tire pressure monitoring sensors need to be mounted on all wheels, including winter tires. If you use a spare wheel or other wheel without the sensor, a fault message will appear in the instrument panel after a few minutes of driving. Remember to make sure that new wheels have the sensor to avoid a system malfunction warning.

Status

You will find information about any issues that the tire pressure monitoring system detects in the center display vehicle status view.

Red indicator symbol The tire pressure is very low. Stop immediately and check the tires.

Yellow indicator symbol The tire pressure is low. Stop and check the tires as soon as possible.

Warning triangle Tire pressure monitoring system status needs to be checked.

System description

The following information is phrased according to external legal requirements.

Each tire, including the spare (if provided), should be checked monthly when cold and inflated to the inflation pressure recommended by the vehicle manufacturer on the vehicle placard or tire inflation pressure label. (If your vehicle has tires of a different size than the size indicated on the vehicle placard or tire inflation pressure label, you should determine the proper tire inflation pressure for those tires.)

As an added safety feature, your vehicle has been equipped with a tire pressure monitoring system (TPMS) that illuminates a low tire pressure telltale when one or more of your tires is significantly underinflated. Accordingly, when the low tire pressure telltale illuminates, you should stop and check your tires as soon as possible, and inflate them to the proper pressure. Driving

on a significantly under-inflated tire causes the tire to overheat and can lead to tire failure. Under-inflation also reduces fuel efficiency and tire tread life, and may affect the vehicle's handling and stopping ability.

Please note that the TPMS is not a substitute for proper tire maintenance, and it is the driver's responsibility to maintain correct tire pressure, even if under-inflation has not reached the level to trigger illumination of the TPMS low tire pressure telltale.

Your vehicle has also been equipped with a TPMS malfunction indicator to indicate when the system is not operating properly. The TPMS malfunction indicator is combined with the low tire pressure telltale. When the system detects a malfunction, the telltale will flash for approximately one minute and then remain continuously illuminated. This sequence will continue upon subsequent vehicle start-ups as long as the malfunction exists. When the malfunction indicator is illuminated, the system may not be able to detect or signal low tire pressure as intended. TPMS malfunctions may occur for a variety of reasons, including the installation of replacement or alternate tires or wheels on the vehicle that prevent the TPMS from functioning properly. Always check the TPMS malfunction telltale after replacing one or more tires or wheels on your vehicle to ensure that the replacement or alternate tires and wheels allow the TPMS to continue to function properly.

^[1] Volvo recommends that you visit an authorized Volvo workshop for any repair or service needs.



13.4.6.1.1. Saving a new reference value for tire pressure monitoring

The tire pressure monitoring system needs a reference value to work from. This means that the value needs to be updated in certain circumstances for the system to work properly.

Whenever the tire pressure is adjusted, a new reference value needs to be saved. This could be when certain changes are made, such as every time you change to wheels that require a different recommended tire pressure. The reference value may also need to be updated when there is a significant change in the vehicle's weight due to loading or unloading.

Even when you are handling a low tire pressure warning and inflating to the previous reference value, you need to save the tire pressure value again to account for any temperature-related changes.

To save a new reference value, the vehicle needs to be turned on and stationary.

1. Inflate the tires to the correct tire pressure.^[1]
2. Press the vehicle symbol  in the bottom bar and go to **Status** → **Tire pressure**.
3. Press  to get to settings.
4. Select your reference tire pressure and press **Save**.

**Note****Save button unavailable**

For safety reasons, the **Save** button is only available when the vehicle is turned on and stationary.

The button is also unavailable if there is a warning about very low tire pressure in the instrument panel. This is to avoid accidentally saving a low value as reference. In this case, you need to inflate the tires to correct reference tire pressure and then start driving the vehicle. Once the warning in the instrument panel disappears, you can stop the vehicle and continue with saving a new reference value.

5. Confirm that you want to save a new value. The confirmation step helps prevent changing the new reference value by mistake.

> This overwrites the previous tire pressure and temperature and enters a new reference value.

6. Start driving the vehicle at a speed above 30 km/h (20 mph).

[1] Check the tire pressure label on the driver's side door pillar for information on the recommended tire pressure for your vehicle.

13.4.6.2. Adjusting tire pressure

The tire pressure may need to be adjusted if you're changing wheels or planning to drive with an unusually heavy load. It's normal for tire pressure to decrease over time. Adjusting it so that you have the correct pressure for the current situation helps ensure even tire wear and high performance.

The tires need to be at ambient temperature when the pressure is checked and adjusted. This is referred to as having cold tires. Never release air from a warm tire. When it cools down, the internal air pressure drops, which can lead to underinflated or even entirely deflated tires.

The tires can warm up very quickly and should be considered warm if driven for more than approximately 1.5 km (1 mile). They often need about 3 hours of cooling down before reaching ambient temperature again.

The recommended pressure for factory-mounted tires is shown on the door pillar on the driver's side.

1. Remove the tire valve's valve cap and then press the tire pressure gauge firmly onto the valve.
2. Check the gauge to see the current tire pressure.
3. Inflate the tire to the correct tire pressure.

Note

Low pressure warning

If you received a low pressure warning, inflate the tire to the last saved pressure value.

Changed conditions

If you need to adjust the tire pressure for changed conditions, such as when changing a tire, inflate to the recommended tire pressure.

4. Refit the valve cap^[1] to avoid damage to the valve.
5. Inspect the tire for stuck debris, such as nails or other objects, that could puncture the tire.
6. Check the sidewalls for any cavities, cuts, bumps or other irregularities.
7. Save the tire pressure reference value in the center display once you've adjusted the pressure.

If you accidentally over-inflate the tire, press the metal pin in the middle of the valve to let out the excess air. Then check the pressure again.

Note

Spare wheels may have recommended pressures that are different from those of the original tires. Always use the pressure recommended by the spare wheel manufacturer.

Tip

You can use the compressor from the temporary puncture repair kit to check and adjust the tire pressure on your original tires when needed.

^[1] Only use original Volvo dust caps or plastic ones, as metal dust caps may corrode and stick to the valve.

13.4.7. Tire terminology

The following is a list of tire-related terminology.

Tire information placard	A plate that specifies OE tire size (original equipment), recommended tire pressure and the maximum weight the vehicle can carry.
Tire identification number (TIN)	A number on the sidewall of each tire with information about tire brand and manufacturing plant, tire size and date of manufacture.
Inflation pressure	A measurement of how much air is in the tire.
Standard load	A class of P-metric or metric tires designed for a maximum load at 35 psi ^[1] . The load-bearing capacity of the tires does not increase if the tire pressure is increased above this pressure.
Extra load	A class of P-metric or metric tires designed for a heavier maximum load at 41 psi ^[2] . The load-bearing capacity of the tires does not increase if the tire pressure is increased above this pressure.

The content of this manual represents the status of the user manual at the time of printing and may not be completely valid in future instances. For more information refer to the first page for the complete disclaimer note.

kPa	Kilopascal, a metric unit for air pressure.
psi	Pounds per square inch, a standard unit for air pressure.
B-pillar	The beam on the side of the vehicle behind the driver's door.
Bead area of the tire	The tire's surface area next to the wheel rim.
Sidewall of the tire	The surface between the base of the tire and the tread.
Tread area of the tire	The surface around the tire in contact with the road when the tire is installed on the vehicle.
Rim	Metal support (wheel) for a tire or tire and inner tube unit against which the base of the tire seals.
Maximum load rating	A figure that specifies the maximum load in pounds and kilograms that the tire can carry. This classification is made by the tire manufacturer.
Maximum permissible inflation pressure	The maximum tire pressure that the tire should ever be subjected to. This limit is specified by the tire manufacturer.
Recommended tire inflation pressure	Tire pressure, specified by Volvo, based on the type of tires installed on a vehicle on delivery. This information is available on the tire plate on the B-pillar on the driver's side and in the tire pressure table.
Cold tires	Tires are considered cold when they have the same temperature as the surrounding air. This temperature is normally reached when the vehicle has been parked for at least three hours.

^[1] 37 psi or 2.5 bar for metric tires

^[2] 43 psi or 2.9 bar for metric tires

13.5. Vehicle electrical system and batteries

Your vehicle has a specialized electrical system that delivers electricity to and from the batteries. There are both high-voltage and low-voltage circuits for different electrical functions.

This section of the manual presents information about several of its electrical components. These include:

- Traction battery
- 12 V battery
- Emergency 12 V supply terminal
- Fuses

 **Important**

12 V terminal

In the event of a total loss of power, the vehicle can't be unlocked, as the locks are electrically operated. To access the vehicle and charge it, the vehicle can be powered for a short time using the externally accessible 12 V terminal. It is accessed by removing a small panel by the left front wheel housing.

Before any use of the 12 V terminal, consider the following:

- Volvo recommends that the 12 V terminal only be used by service technicians for the purpose of accessing the vehicle as part of immobilization recovery.
- The external 12 V terminal on your vehicle should only be used to make your vehicle accessible. Do not attempt to charge another vehicle or similar external source from this point.
- Only use a 12 V charger with a maximum charging current below 30 A.
- Do not connect another 12 V battery to the terminal.
- Connecting any power source that delivers current higher than 30 A will blow the fuse and thus disable it.
- Only use the 12 V terminal for short amounts of time. This is not meant as a way of powering the vehicle continuously.
- Make sure to follow the positive and negative markings on the terminals – reversing the polarity of the low-voltage system could lead to damaging the low-voltage system components or blowing the 30 A fuse.

 **Tip**

Vehicle charging

Features and equipment related to charging, such as the charging port and cables, have their own section.

Convenience features

Power-related features, such as USB ports and wireless device charging, are covered in other sections.

 **Warning**

- Do not handle or modify the vehicle's electrical components. Only perform actions that are clearly described in the user manual.
- High-voltage components can produce or conduct lethal currents and must only be handled by authorized technicians.
- Do not perform repairs on the vehicle's electrical system or components. Contact an authorized Volvo workshop for any required repairs or servicing.

13.5.1. Traction battery

Your vehicle's traction battery is the central energy and power source for your vehicle. It powers all electric propulsion and indirectly powers the rest of the vehicle by keeping the smaller 12 V battery charged.

The content of this manual represents the status of the user manual at the time of printing and may not be completely valid in future instances. For more information refer to the first page for the complete disclaimer note.

The traction battery sits low in the underbody of the vehicle.

Battery care and health

How you use your vehicle affects the traction battery's condition. Over time its capacity decreases. There are recommended user practices that can help extend the battery's service life. These user practices cover events and conditions that can cause battery damage.

Important

Leaving the vehicle with a low battery level can lead to battery damage. Make sure to charge the vehicle as soon as possible if the battery level is near empty.

Tip

There are separate sections in this manual about battery health and what you can do to recover from a low-power scenario.

Battery service and maintenance

The traction battery is a high-voltage component that only authorized technicians are equipped to service safely.

Warning

- Do not handle or modify the vehicle's electrical components. Only perform actions that are clearly described in the user manual.
- High-voltage components can produce or conduct lethal currents and must only be handled by authorized technicians.
- Do not perform repairs on the vehicle's electrical system or components. Contact an authorized Volvo workshop for any required repairs or servicing.

Battery passport

You can find out more about your vehicle's traction battery by scanning the battery passport QR code. It is located on the inside of the door pillar on the driver's side and is visible when the door is opened.

13.5.1.1. Managing battery health and performance

There are user practices that can help maintain the traction battery's condition and performance over time. Some scenarios can lead to battery damage and should always be avoided.

Low battery level and discharged battery

 **Important**

The traction battery can sustain severe damage if it is not charged after the battery level reaches 0%. The vehicle draws a small amount of power when parked. This means that leaving the vehicle with a low battery level without charging can lead to a discharged battery and battery damage. If the battery level is below 20% when parked, it is recommended that you connect the vehicle for charging as soon as possible.

If the battery level reaches 0%, the battery is considered discharged or empty. The vehicle then needs to be charged as soon as possible to reduce the risk of battery damage.

The smaller 12 V battery is also at risk of going flat if the traction battery can't supply it with power. If both batteries have gone flat, the vehicle will have no power at all and no ability to initiate charging.

High state of charge

 **Important**

The traction battery can sustain damage if the vehicle's battery level is kept very high for a long period of time.

For regular charging, battery wear can be reduced by selecting a target battery level lower than 100%. Only charge to 100% if the full range is needed for your next trip.

If you are leaving the vehicle plugged in for charging without any immediate plans to drive it, select the target battery level recommended in the vehicle's charging view.

Charging habits

AC charging is the recommended charging mode for everyday charging. This helps maintain the condition of the battery over time. DC charging causes more wear.

Long-term parking

When leaving your vehicle parked for longer than one month, the recommended battery level is 40-60%. Use or charge the vehicle to reach the recommended level.

If you are leaving the vehicle parked for longer than three months, you should keep it plugged in but set a battery charging limit of 50%. This is for better battery health.

Regularly check the battery level and make sure that charging is working.

 **Tip**

There is a separate section in this manual with more recommendations for long-term parking.

Parking in hot weather

 **Important**

Avoid exposing the vehicle to extreme temperatures. Avoid leaving the vehicle parked for longer than 24 hours if there is a possibility that the temperature could reach 55 °C (131 °F).

When it is warm out, you should plug the vehicle in while it is parked. High temperatures cause battery damage, especially when the vehicle is exposed to hot weather for prolonged periods. The car can actively cool the battery while it's parked, but that uses energy. When you return to your parked vehicle, the battery level may be noticeably lower than before. If the vehicle is plugged in for charging, it can cool the battery without lowering the battery level and risking a discharged battery.

In hot temperatures, it is recommended that you park in a shaded spot. Strong sunlight combined with high temperatures can lead to very high battery temperatures and excessive cooling needs.

Parking in cold weather

When the battery is cold, the vehicle temporarily reduces battery performance until it has warmed up. Driving the vehicle in a state of reduced performance doesn't harm the battery.

To avoid temporarily reduced performance from a cold battery, connect the vehicle for charging and activate the vehicle's preconditioning prior to your trip. The vehicle can then heat the battery without affecting performance and available range.

If temperatures are below -30 °C (-22 °F), avoid leaving the vehicle parked without charging for longer than 24 hours.

13.5.1.2. Powertrain cooling system

Your vehicle has an advanced temperature regulation system.

The system actively regulates the temperature of the traction battery while you're parked, charging or driving your vehicle. This happens if your vehicle experiences high or low temperatures and during preconditioning.

 **Important**

Never attempt to add coolant yourself.

The cooling system is a closed system. A trained technician must perform any required maintenance of the cooling system.^[1]

^[1] Volvo recommends an authorized Volvo workshop.

13.5.2. 12 V battery

The 12 V battery powers everything in your vehicle except the electric propulsion.

Servicing and replacement

The 12 V battery is maintenance-free.

Contact an authorized Volvo workshop if the 12 V battery needs to be replaced.

Important

12 V terminal

In the event of a total loss of power, the vehicle can't be unlocked, as the locks are electrically operated. To access the vehicle and charge it, the vehicle can be powered for a short time using the externally accessible 12 V terminal. It is accessed by removing a small panel by the left front wheel housing.

Before any use of the 12 V terminal, consider the following:

- Volvo recommends that the 12 V terminal only be used by service technicians for the purpose of accessing the vehicle as part of immobilization recovery.
- The external 12 V terminal on your vehicle should only be used to make your vehicle accessible. Do not attempt to charge another vehicle or similar external source from this point.
- Only use a 12 V charger with a maximum charging current below 30 A.
- Do not connect another 12 V battery to the terminal.
- Connecting any power source that delivers current higher than 30 A will blow the fuse and thus disable it.
- Only use the 12 V terminal for short amounts of time. This is not meant as a way of powering the vehicle continuously.
- Make sure to follow the positive and negative markings on the terminals – reversing the polarity of the low-voltage system could lead to damaging the low-voltage system components or blowing the 30 A fuse.

12 V battery specifications

Battery type	H5 AGM
Voltage	12 V
Dimensions (length × width × height)	242 × 175 × 190 mm (9.5 × 6.9 × 7.5 in)
Capacity	60 Ah
Cold start capacity ^[1]	680 A

Warning

California Proposition 65

Operating, servicing and maintaining a passenger vehicle or off-highway motor vehicle can expose you to chemicals, including engine exhaust, carbon monoxide, phthalates, and lead, which are known to the State of California to cause cancer and birth defects or other reproductive harm. To minimize exposure, avoid breathing exhaust, do not idle the engine except as necessary, service your vehicle in a well-ventilated area and wear gloves or wash your hands frequently when servicing your vehicle. For more information go to www.P65Warnings.ca.gov/passenger-vehicle [<https://www.p65warnings.ca.gov/products/passenger-vehicle>]. Certain components of this vehicle, such as airbag modules and seat belt pre-tensioners, may contain Perchlorate Material. Special handling may be required for service or vehicle end-of-life disposal. See www.dtsc.ca.gov/hazardouswaste/perchlorate. Battery posts, terminals, and related accessories contain lead and lead compounds. Wash hands after handling.

13.5.2.1. Battery labels

Low-voltage vehicle batteries have labels containing information for safe handling.

Symbols



Avoid sparks and naked flames.



Use protective goggles.



Store the battery out of reach of children.



The battery contains corrosive acid.



More information in the vehicle's user manual.



Risk of explosion.



If eyes are exposed to battery fluid, immediately flush with water. Seek medical attention as soon as possible.

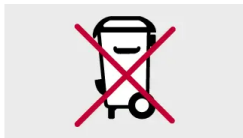

The battery must be disposed of properly to be recycled.



Recycle properly.

i Note

Depicted labels

Labels depicted in this manual are generic representations of those found around your vehicle. The manual only contains their location and what kind of information they contain. Find the actual label for specific information about your vehicle.

13.5.3. Battery recycling

Used batteries must be recycled in an environmentally sound manner.

Consult Volvo Support if you're unsure of how to dispose of batteries. The traction battery must only be handled by authorized technicians.

13.5.4. Fuses

Electrical fuses protect different parts of the vehicle's electrical system by shutting off the power if the current exceeds the fuse's threshold. A blown fuse must be replaced to restore functionality.

A blown fuse may be an indicator of an underlying electrical fault. Contact Volvo support if your vehicle indicates that a fuse has blown.

! Important

- Incorrect fuse replacement can cause severe damage to the electrical system.
- A replacement fuse must have the correct specifications, such as type and ampere value.
- Volvo recommends an authorized Volvo workshop for fuse replacements.

13.6. Tools and equipment

Your vehicle is equipped with some tools that may be useful in certain situations. For example, if you need to change a tire.

The tools and equipment in your vehicle are stored in different places, such as under the hood, in the glove compartment and in the trunk. Be sure to familiarize yourself with where everything is stored so you don't have to search for something when you need it.

! Warning

Store tools appropriately

Always store loose tools and equipment in their designated storage areas when not in use. Otherwise, they can cause damage or injury in the event of a collision.

Read all instructions before using tools

Before use, make sure you read and understand any available instructions for tools and equipment.

Contact Volvo support for recommendations concerning tools and equipment for your vehicle.

Towing eye



The towing eye can be attached to the vehicle's bumper to enable towing. It can also be used to secure objects carried on the roof that are longer than the roof.

Temporary puncture repair kit



Your vehicle is equipped with a temporary puncture repair kit that can be used to repair a minor tire puncture.

13.6.1. Using a warning triangle

Assemble and set out a warning triangle if your vehicle is immobilized in an area where there might be other vehicles. The purpose of the warning triangle is to give other drivers advance notice of your vehicle or other stationary hazards.

i Note

Local rules and regulations

Rules and regulations about how and when to put out a warning triangle vary between regions. You are responsible for knowing and following the rules that apply in your location.

i Tip

- If it's dark when you set out the warning triangle, wear a reflective vest if you have one in the vehicle. If you don't have one, you can hold the warning triangle so that its reflective parts are visible as you carry it.
- You can use the case as a reminder to retrieve the warning triangle when you leave by placing it on the driver's seat.

1. Activate the hazard warning lights.
2. Position the warning triangle in a suitable place with respect to traffic, at a distance that ensures that other drivers are alerted far enough in advance before they reach your vehicle.

Remember to retrieve the warning triangle before you drive off again.

13.6.2. Attaching the towing eye

Use the towing eye to attach a winch wire when towing.

On the right-hand side of the vehicle, the towing eye is screwed into a threaded socket behind a cover located on the front and rear bumpers.

! Important

Be sure to read about towing and its limitations before you start.

Fetch the towing eye so you have it at hand.

1.

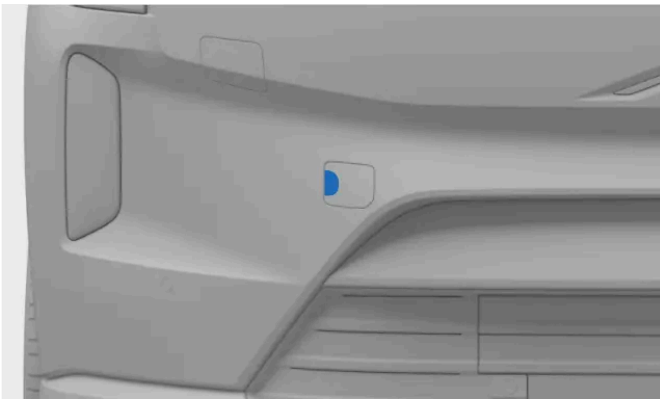

Front towing eye fastening cover

To attach in the front: remove the cover by pushing in the center of its left side. The cover pivots and can then be removed.

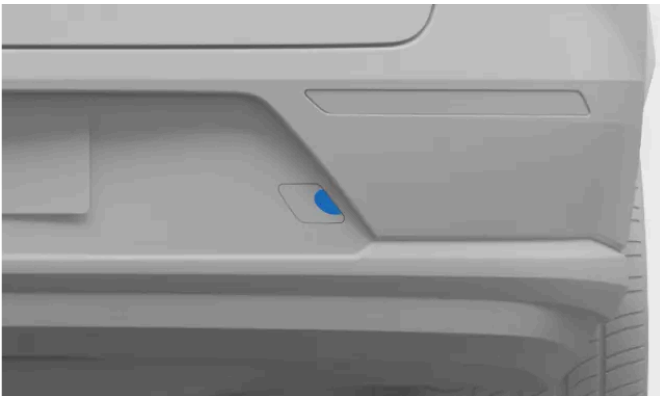

Rear towing eye fastening cover

To attach in the rear: remove the cover by pushing in the center of its right side. The cover loosens and can then be removed.

2. Screw the towing eye all the way into the socket.

! Important

It is important to screw the towing eye firmly into place. Putting something through the towing eye, such as a lug wrench, can provide extra leverage.

After you're done, remember to remove the towing eye and return it to its storage location.

13.7. Raising the vehicle

You can raise one wheel off the ground at a time using a jack. Be sure to read all instructions before raising the vehicle.

Important

It is very important to place the jack on the jacking points, or the battery may get damaged.

Recommended or supplied equipment

- The instructions for raising the vehicle presume use of a jack recommended or supplied^[1] by Volvo.
- Only use tools and equipment designed for your vehicle model. Contact a Volvo retailer for tool recommendations.
- Volvo recommends an authorized Volvo workshop for tasks not described in this manual.
- A portable jack designed for occasional and limited use is only suitable for short and urgent tasks, such as handling a flat tire. A workshop jack is recommended for frequent or extended use.
- Only raise the vehicle using its jacking points.

Other lifting equipment

- If using lifting equipment not supplied by Volvo^[2], carefully read the instructions before raising the vehicle. Ensure that the equipment is compatible with the vehicle.
- Use additional safety equipment such as axle stands and wheel blocks when applicable.
- When using workshop jacks or other lifting equipment designed for frequent and extended use, you should use separate lifting areas instead of the ones described in this instruction.

 **Warning**

Safety around the vehicle

- If you are changing a wheel in or close to traffic, make sure you and the vehicle are clearly visible to others. Activate the hazard warning flasher, put out a warning triangle in a visible but safe place and wear a reflective vest.
- Designate a safe area for passengers to wait, away from both the vehicle and traffic.
- You are responsible for safety around the vehicle while it is raised. Do not allow people to stay inside of or close to the vehicle.

Raising the vehicle

- Never get under the vehicle, or let anyone reach under it with any part of their body, while it is raised.
- Do not place any object between the ground and the jack or between the jack and the vehicle's jacking point.
- Do not use lifting equipment that shows any sign of damage.

Before raising the vehicle:

- Gather the tools and parts needed for your planned work.
 - Make sure that the jack is in good condition and that its threads are properly lubricated and free of dirt.
 - To avoid accidentally triggering the alarm, reduce your vehicle's alarm sensitivity.
1. Activate the parking brake.
 2. Activate jack mode in settings.
 3. Place wheel blocks to reduce the risk of vehicle movement while raised. Large stones or wooden blocks work well. Place them both in front of and behind each wheel that will remain on the ground.
 4. Locate the intended jacking point on the vehicle's underbody.

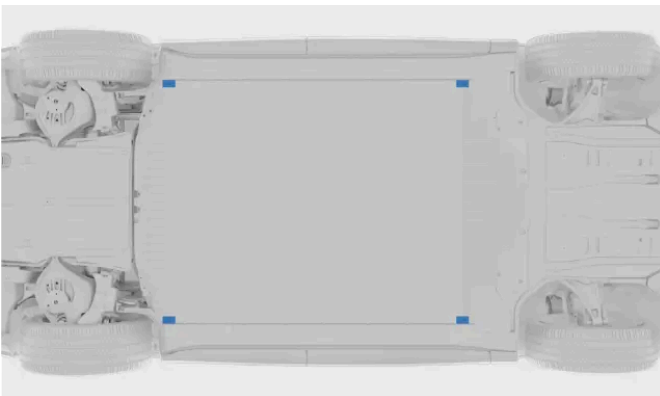

There are two jacking points on each side of the vehicle.

5. Place the jack under the vehicle's jacking point. The surface it stands on must be firm, non-slippery and level. Position the jack with the crank handle pointing away from the vehicle.
6. Crank the jack up until its head slots into the vehicle's jacking point. Ensure that the protruding piece on the jack head fits

into the jacking point slot.

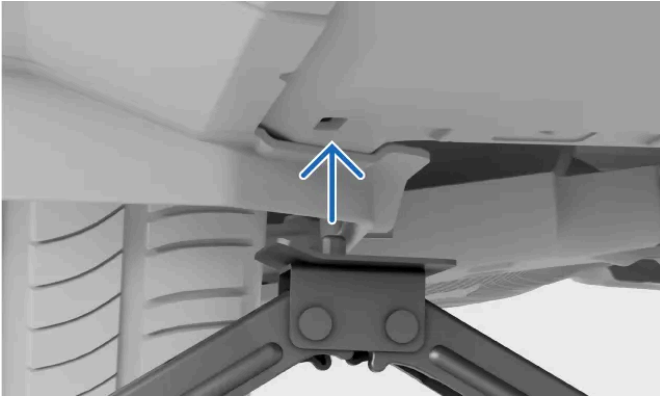

7. Make a final alignment. Make sure that:

- the jack is not leaning in any direction
- the base of the jack is centered under the jacking point
- the jack head meets the jacking point correctly.



8. Raise the vehicle to an appropriate height. Do not raise it higher than necessary for the work you're doing.

 **Warning**

Do not leave the vehicle unsupervised when raised.

Carefully lower the vehicle when you have finished your work. Remember to test important vehicle functions that may have been affected by the work you performed.

Put the jack back into its storage place.

Jack mode will deactivate as soon as you start to drive.

[1] Depending on market, a jack for occasional and limited use may be included with your vehicle.

[2] This includes workshop jacks or other lifting equipment designed for frequent and extended use.

13.7.1. Workshop lifting areas

You can use a workshop jack or lifting device designed for frequent and extended use when you raise the vehicle off the ground. However, when you do, you need to ensure that it's placed on the vehicle's lifting areas.

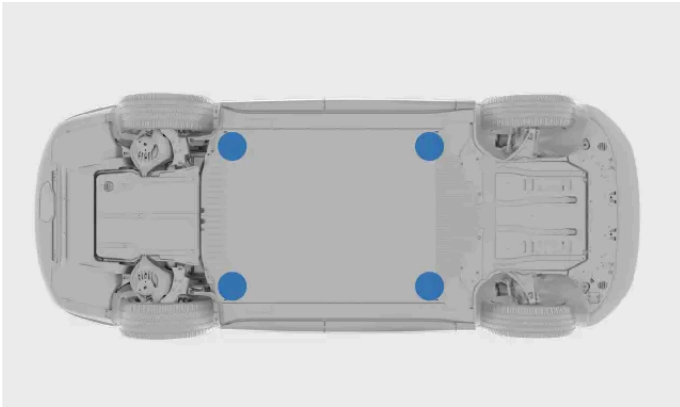

Lifting areas used for workshop equipment.

The lifting areas to use along with workshop equipment are positioned at the outer corners of the battery tray. They are just behind the regular jacking points, close to the ribbed area.

! Important

It is very important to place the workshop jack on the vehicle's lifting areas, or the battery may get damaged.

If you're using a workshop jack, make sure that the jack plate is fitted with a rubber guard to protect the vehicle as well as to ensure that the vehicle remains stable.

To avoid accidentally triggering the alarm, reduce your vehicle's alarm sensitivity before lifting it.

i Note

You must activate jack mode before raising the vehicle off the ground.

13.7.2. Activating jack mode

If you need to raise a wheel off the ground—for example, when changing a tire—you first need to activate jack mode.

Your vehicle is equipped with air suspension which will automatically level the vehicle if the ground is uneven. The air suspension has to be turned off when you use a jack to raise a wheel off the ground. If you don't, the vehicle will try to maintain a level position.

1. Press the vehicle symbol  in the bottom bar and go to **Settings**.

The content of this manual represents the status of the user manual at the time of printing and may not be completely valid in future instances. For more information refer to the first page for the complete disclaimer note.

2. Go to **Controls** → **Car modes** → **Jack mode**.

3. Activate jack mode.

Jack mode will automatically deactivate when you start driving again.

13.8. Maintenance and repairs

Properly performed maintenance and repairs are essential for keeping your vehicle in good working condition.

Your vehicle keeps track of when you last had a maintenance appointment and it tells you when it's time to make a new one. It can self-diagnose many types of faults and notify you if you need to take action.

If you notice any maintenance or repair needs that have not been detected by the vehicle, contact Volvo support.

Volvo recommends an authorized Volvo workshop for all maintenance and repair needs.

Important

Faults and notifications

If a notification in the vehicle calls for maintenance, make an appointment as soon as you can. The vehicle status view in the center display also contains information about detected issues.

Warning

- Do not handle or modify the vehicle's electrical components. Only perform actions that are clearly described in the user manual.
- High-voltage components can produce or conduct lethal currents and must only be handled by authorized technicians.
- Do not perform repairs on the vehicle's electrical system or components. Contact an authorized Volvo workshop for any required repairs or servicing.

Volvo's recommended maintenance program

Volvo recommends engaging an authorized Volvo workshop to perform any repair and maintenance work. Volvo workshops have the personnel, special tools and service literature required to provide high-quality servicing. Volvo's recommended maintenance program has been developed to give your vehicle a long service life. Maintaining your vehicle according to its customized maintenance program may be a prerequisite for coverage under Volvo's warranties. Your vehicle's service and warranty information ^[1] contains more details about service and warranty terms and conditions.



Warning

California Proposition 65

Operating, servicing and maintaining a passenger vehicle or off-highway motor vehicle can expose you to chemicals, including engine exhaust, carbon monoxide, phthalates, and lead, which are known to the State of California to cause cancer and birth defects or other reproductive harm. To minimize exposure, avoid breathing exhaust, do not idle the engine except as necessary, service your vehicle in a well-ventilated area and wear gloves or wash your hands frequently when servicing your vehicle. For more information go to www.P65Warnings.ca.gov/passenger-vehicle [<https://www.p65warnings.ca.gov/products/passenger-vehicle>]. Certain components of this vehicle, such as airbag modules and seat belt pre-tensioners, may contain Perchlorate Material. Special handling may be required for service or vehicle end-of-life disposal. See www.dtsc.ca.gov/hazardouswaste/perchlorate. Battery posts, terminals, and related accessories contain lead and lead compounds. Wash hands after handling.

^[1] This is a separate publication included with your vehicle.

13.8.1. Booking maintenance or repairs

Volvo support handles bookings when you need a maintenance or repair appointment. Authorized Volvo workshops have specialized training and equipment to take care of your vehicle.

Your vehicle notifies you when it's time for maintenance.

1. Contact Volvo support to book an appointment. They can locate your closest service point.

If you're unable to reach Volvo support and urgently need maintenance or repairs, contact a roadside assistance service available in your location.

13.8.2. On-board diagnostic port

Your vehicle has a diagnostic port that allows a workshop to connect to the vehicle and communicate with its systems. Do not connect equipment that has not been authorized by Volvo.

The diagnostic port is type OBDII.

The diagnostic port is located on the underside of the dashboard, close to the hood release lever.

Improper use of the diagnostic port can negatively affect the vehicle's systems and software. This includes connecting unauthorized equipment^[1] and the installation of software or diagnostic tools.

The content of this manual represents the status of the user manual at the time of printing and may not be completely valid in future instances. For more information refer to the first page for the complete disclaimer note.

 **Warning**

Volvo accepts no liability if unauthorized equipment is connected to the on-board diagnostic port. Contact an authorized Volvo workshop for more information.

[1] Equipment not approved by Volvo.

14. Immobilized vehicle and recovery

If you can't drive your vehicle, it's considered immobilized. You can always contact an authorized Volvo workshop if you're unable to find a solution in the manual or if you are uncertain about how to proceed.

Depending on the nature of the problem, you may be able to solve it on your own or with assistance from an authorized Volvo workshop or other services. In this part of the manual, you will find a number of scenarios and how to handle them safely.

In a situation where there are injuries or risk of injury, prioritize safety and medical needs over vehicle recovery. Don't hesitate to contact emergency services if necessary.

The following scenarios have their own manual sections that can help you identify the underlying issue and what the necessary steps for recovery are.

- The vehicle malfunctions and the vehicle can't be used as intended.
- The battery is dead and the vehicle is unresponsive.
- There is physical damage to the vehicle. The damage can make the vehicle unsuitable to drive or cause immobilization. Even superficial damage needs to be evaluated to ensure that you can safely use the vehicle.

14.1. Damaged vehicle

If your vehicle is damaged, it is important to identify the extent and severity of the damage to determine how to handle the vehicle safely.

Damage can immobilize your vehicle or make it unsafe to drive.

Contact an authorized Volvo workshop if your vehicle has been damaged or if it shows signs of damage sustained while parked. If the damage immobilizes or severely impairs the vehicle's performance, you will need to recover it using a roadside assistance and recovery service.

Important

Minor damage

Your vehicle can self-diagnose many defects, but it can't detect all types of damage or predict their consequences. A small impact resulting in superficial damage can harm components behind the affected area, such as misaligning a parking sensor behind a bumper. That's why it's important to have seemingly minor or superficial damage examined by a trained technician to determine the full extent of the damage.

Immobilizing damage

There are several types of damage that can immobilize the vehicle. They include but are not limited to:

- Collision damage
- Flat tire
- Windshield damage

The content of this manual represents the status of the user manual at the time of printing and may not be completely valid in future instances. For more information refer to the first page for the complete disclaimer note.

- Water damage
- Mechanical failure

Collision damage

After a severe-enough collision, your vehicle enters safety mode and needs to be recovered.

Important

If possible, do not try to drive or move the vehicle after a severe collision. The only exception is if the vehicle is a serious hazard to other vehicles on the road, in which case you should move it a short distance so it is out of immediate danger if the vehicle's condition allows you to do so.

Water damage

Water damage can cause permanent damage to your vehicle and severely affect how well it works.

Important

Simply drying the vehicle out or allowing it to dry will often be insufficient to resolve significant water damage. A trained technician should examine any water damage to determine its full extent and severity.

Mechanical damage

The best way to avoid mechanical failures is to follow the intended use and to regularly maintain your vehicle. It is important to continuously perform check-ups of your vehicle.

14.2. Malfunction

When part of your vehicle or one of its features is not working as designed, that is considered a malfunction.

^[1] It may not be safe to use your vehicle at all, depending on what type of malfunction the vehicle is experiencing.

Note

Immobilized vehicle

You should consider the vehicle to be immobilized if a malfunction prevents you from driving safely.

Unresponsive vehicle

There is a separate section in this manual for power-related issues.

General advice for malfunctions

If a function doesn't work properly, try the following actions:

- Read what the manual has to say about the function. Make sure that you are aware of what's required for it to work properly. The problem might mean that you are unaware of a limitation to a specific function.
- Restart all related devices and systems. This applies to the vehicle itself but can also include your phone or an app.
- If there is more than one way to use a function or perform a task, try the alternatives.

 **Note**

Changes after software updates

Software updates can make changes to functions that affect how they work. Be sure to read the information provided with each update so that you understand why the vehicle may behave differently.

Possible causes

When a function isn't working the way you expect it to, there are several possible causes:

- The vehicle's settings have been changed.
- Environmental conditions are affecting the vehicle and its systems.
- Signal interference is affecting connectivity and wireless systems.
- A fuse has blown and needs to be replaced.
- Software error.
- Mechanical failure.

Contact an authorized Volvo workshop if needed

If you can't solve the problem using the information in the manual, contact an authorized Volvo workshop.

Take note of what happened around the time the problem appeared. It may help identify the cause. Examples of key events include:

- Damage to the vehicle.
- Exposure to extreme conditions.
- Recently performed servicing, maintenance or replacement of a component.
- Recently updated software.
- Any other faults or malfunctions.

^[1] In some cases, a suspected fault or failure may instead be an intentional limitation under the conditions experienced by the vehicle.

14.3. Vehicle has no power or is not responding

If your vehicle is unresponsive or appears to have no power, the cause could be dead batteries or something affecting its electrical systems.

If the vehicle's batteries are dead, the vehicle will not respond to some of your actions. This includes trying to unlock or start it.

If the vehicle doesn't respond due to low power, there are several recovery options depending on the situation.

The following situations can lead to both batteries in the vehicle going dead:

- The vehicle is driven to 0% battery level and is not then immediately recharged.
- The vehicle is left with a low battery level. If not plugged in for charging, the battery level drops further, as the vehicle uses a small amount of power while parked.
- The vehicle is left without charging for a long time, which allows the battery level to drop.
- Low temperatures temporarily reducing battery capacity below the required level to keep the vehicle powered.

Conditions or uses that increase power consumption and result in a faster-than-expected drop in battery level include:

- Use of accessories or power-consuming vehicle functions.
- High temperatures, triggering battery cooling.

Recovery from a drained traction battery

If only the traction battery is dead, the vehicle's systems have power but it can't be started or driven. The vehicle shows that the battery level is at 0%. In this situation, the 12 V battery can power the systems needed to initiate charging of the traction battery. It's important to conserve energy in the 12 V battery so that you can access and charge the vehicle.

Vehicle recovery actions:

- If you can charge your vehicle where it's parked, do so immediately.
- If your vehicle can't be charged at your current location, have the vehicle recovered and transported to a charging source. In the meantime, try to conserve the remaining power in the 12 V battery. This is important for battery health and also keeps essential functionality available for you to use in an emergency.

Recovery from total loss of power

If the 12 V battery is drained, the vehicle will be completely unresponsive. This can happen if something prevents the traction battery from keeping the 12 V battery charged, such as allowing the traction battery to go dead and then not charging the vehicle in time. If both batteries are dead, the vehicle is entirely unresponsive and cannot be charged as usual.

Recovery actions:

- Contact an authorized Volvo workshop or a recovery and roadside assistance service.
- If there is a charging source where the vehicle is immobilized, it may be possible to temporarily power the vehicle using a special exterior 12 V terminal. This can allow you to initiate charging.
- If the vehicle can't be charged where it is, it needs to be transported to a location with a charging source. An authorized Volvo workshop has the equipment to power the vehicle and charge it.

 **Important**

12 V terminal

In the event of a total loss of power, the vehicle can't be unlocked, as the locks are electrically operated. To access the vehicle and charge it, the vehicle can be powered for a short time using the externally accessible 12 V terminal. It is accessed by removing a small panel by the left front wheel housing.

Before any use of the 12 V terminal, consider the following:

- Volvo recommends that the 12 V terminal only be used by service technicians for the purpose of accessing the vehicle as part of immobilization recovery.
- The external 12 V terminal on your vehicle should only be used to make your vehicle accessible. Do not attempt to charge another vehicle or similar external source from this point.
- Only use a 12 V charger with a maximum charging current below 30 A.
- Do not connect another 12 V battery to the terminal.
- Connecting any power source that delivers current higher than 30 A will blow the fuse and thus disable it.
- Only use the 12 V terminal for short amounts of time. This is not meant as a way of powering the vehicle continuously.
- Make sure to follow the positive and negative markings on the terminals – reversing the polarity of the low-voltage system could lead to damaging the low-voltage system components or blowing the 30 A fuse.

Other no-power scenarios

There may be cases where you are fairly sure that the battery level is not low. In these cases, a lack of power indicates that the 12 V battery isn't receiving power from the traction battery or can't deliver power to the vehicle.

Possible scenarios that affect the 12 V power delivery:

- A fuse has blown and needs to be replaced.
- The 12 V battery is defective.
- There is an electrical, hardware or software fault preventing the vehicle from turning on.

If you can't identify the cause of the problem or solve it by referring to the manual, contact an authorized Volvo workshop.

14.4. Recovery

Vehicle recovery typically requires transporting your vehicle with a recovery vehicle. This is necessary if the vehicle is immobilized and its functions cannot be restored where it is.

Contact an authorized Volvo workshop if you need to recover your vehicle.^[1]

The recommended recovery procedure depends on the conditions and state of the vehicle. If your vehicle is undamaged and has power, tow mode can be activated to pull the vehicle onto the recovery vehicle's platform. If the vehicle is damaged, unresponsive or in safety mode, it should be lifted onto the recovery vehicle's platform.

 **Important**

Wheels off the ground

Regardless of the vehicle's condition, it must be transported with all wheels off the ground when recovered. Forced wheel rotation during transportation can severely damage the vehicle.

Keep a safe distance

Do not allow anyone to stand directly behind your vehicle as it is pulled onto the recovery vehicle.

^[1] For urgent recovery needs, you can also directly contact a recovery and roadside assistance service.

14.5. Safety mode

If your vehicle detects damage that compromises safety, it can enter safety mode.

Safety mode limits the available functions when your vehicle has sustained damage. The vehicle must undergo damage assessment and repairs^[1] if safety mode has been activated. Contact an authorized Volvo workshop if safety mode has been activated for any reason.

The displays clearly indicate when the vehicle is in safety mode, if they are still functioning.

When safety mode is active, you cannot drive the vehicle. However, if you need to move the vehicle out of immediate danger, you can exit safety mode via the center display. You should drive with caution after you deactivate safety mode, and only for very short distances, such as to the side of the road.

 **Note**

When you exit safety mode, the vehicle performs a safety check-up. This is then communicated in the instrument panel. If the check-up fails, you will not be allowed to deactivate safety mode to move the vehicle.

 **Warning**

- Do not use or stay in the vehicle when it is in safety mode. The only exception is to move it a short distance if it poses an immediate danger in traffic.
- Do not tow the vehicle without first activating tow mode. This is done in the center display.
- Resetting the vehicle's status without performing damage assessment and repairs can result in further damage to the vehicle, as well as personal injury.

^[1] Volvo recommends an authorized Volvo workshop

14.6. Having your vehicle towed

Your vehicle can be towed short distances if necessary. For this, tow mode must first be activated.

Important

Before having your vehicle towed

- To avoid accidentally triggering the alarm, reduce your vehicle's alarm sensitivity before towing it.
- You can only access tow mode if the vehicle has power. If the vehicle can't be powered on, it will need a full recovery.
- Be sure to read all information about having your vehicle towed before you activate tow mode.
- You should only tow your vehicle short distances, such as to the side of the road or onto a recovery vehicle. Towing your vehicle longer distances can damage the vehicle by causing the battery to charge incorrectly.

To tow your vehicle, you must first activate tow mode, which involves attaching the towing eye and the winch wire. Make sure that you have all the necessary equipment ready.

1. Activate tow mode in the center display.
 - > Tow mode activation confirmation appears.
2. Tow your vehicle onto a recovery vehicle or to a safe place, such as the side of the road.
3. When the vehicle is in the necessary place, engage the parking brake.
 - > Tow mode deactivates.
4. If necessary, remove the towing eye and winch wire.

Important

Always use a recovery vehicle to transport the vehicle whenever it cannot be driven. Forced wheel rotation during transportation can severely damage your vehicle. Make sure the vehicle is only transported by a recovery vehicle such as a flatbed, so that the vehicle's wheels do not touch the ground while being transported.

14.6.1. Activating tow mode

If your vehicle needs to be towed onto a flatbed recovery vehicle, you first need to activate tow mode in settings.

 **Important**

- Having your vehicle towed without activating tow mode may damage it. Be sure to follow the instructions in the display until you have received confirmation that tow mode is active before your vehicle is towed.
- Tow mode can only be accessed if the vehicle has power. If the vehicle can't be powered on, it will need a full recovery.
- Be sure to read all information about having your vehicle towed before you activate tow mode.

 **Note**

Tow mode is only used when you have your vehicle towed. Do not activate it when towing other vehicles or trailers.

1. Press the vehicle symbol  in the bottom bar and go to **Settings**.
 2. Go to **Controls** → **Car modes** → **Tow mode**.
- > The tow mode tutorial appears in the center display.
3. Follow the tutorial until you get confirmation that tow mode is active.

Tow mode deactivates when you engage the parking brake.

15. Specifications

These specifications describe your vehicle in technical terms and figures. You might need to find some of these details, such as when buying new tires.

This information is divided up in the following sections, with some examples of their content to help guide you.

- General vehicle characteristics – dimensions, weights, and type designations.
 - Powertrain specifications – performance, electric motor, range and electric consumption.
 - Wheel and tire specifications – approved tire pressures and tire sizes.
 - Fluid specifications – brake fluid and refrigerant.
 - Certificates and type approvals
-

15.1. General vehicle characteristics

These are the basic facts about your vehicle. This information will help you determine your vehicle's specific setup.

You may need to know these things about your vehicle for a number of reasons. For example, to be able to order the right spare parts or accessories.

15.1.1. Vehicle dimensions

Here you can find your vehicle's measurements, such as length and height.

Locate the measurement you're looking for in the images first, then check the corresponding letter in the table below.

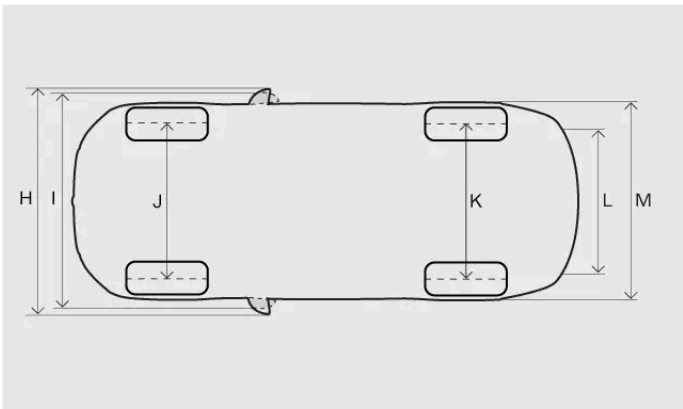
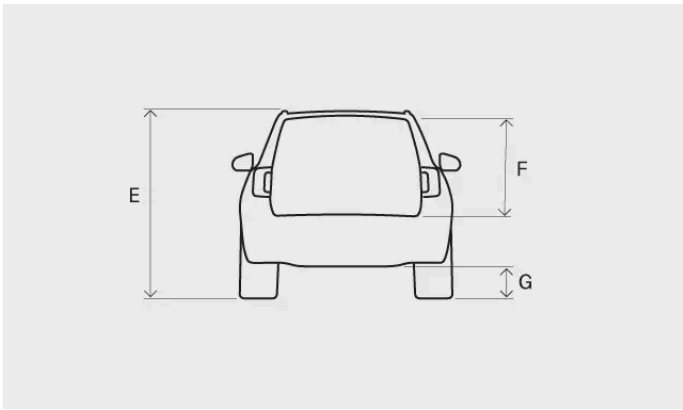
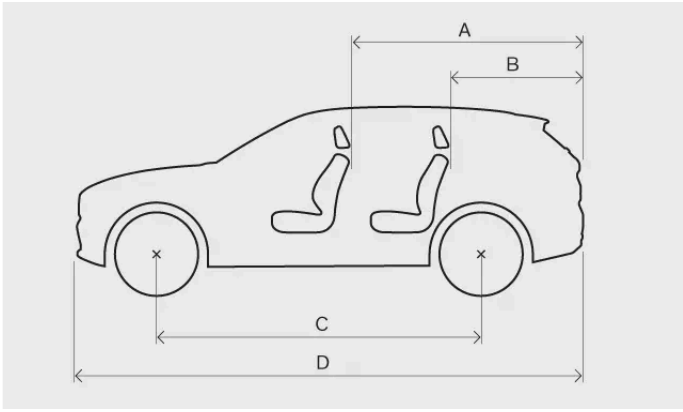

Measurement		Millimeters	Inches
A	Load length, floor, folded seat	2032 1276 ^[1]	80.0 50.2 ^[1]
B	Load length, floor	569	22.4
C	Wheelbase	2985	117.5
D	Length	5037	198.3
E	Height ^[2]	1741	68.5
F	Load height	779	30.7
G	Ground clearance ^[2]	213	8.4
H	Width including folded-out wing mirrors	2113	83.2
I	Width including folded-in door mirrors	2039	80.3

The content of this manual represents the status of the user manual at the time of printing and may not be completely valid in future instances. For more information refer to the first page for the complete disclaimer note.

Measurement		Millimeters	Inches
J	Wheel track ^[2]	1672–1676 ^[3]	65.8–66.0 ^[3]
K	Rear track ^[2]	1666–1677 ^[3]	65.6–66.0 ^[3]
L	Load width, floor	1138	44.8
M	Width	1964	77.3

^[1] From the second seat row in a vehicle with 6 or 7 seats.

^[2] At curb weight plus one person.

^[3] Depending on rim size.

15.1.2. Weights

You can find your vehicle's maximum gross vehicle weight and other weights below.

Twin motor		
	USA (lbs)	Canada (kg)
Gross vehicle weight	7300	3310
Load capacity	1070	484
Maximum front axle weight	3300	1500
Maximum rear axle weight	4320	1960
Maximum roof load	220	100
Curb weight	5790–5870	2660–2700

Important

When the vehicle is loaded, it must not exceed the maximum gross vehicle weight and axle weights.

15.1.3. Towing specifications and capabilities

Towing weights and towball loads for driving with a trailer can be viewed below.

Important

Always follow local rules and regulations when driving with a trailer, such as speed for the vehicle combination.

Braked trailer

The content of this manual represents the status of the user manual at the time of printing and may not be completely valid in future instances. For more information refer to the first page for the complete disclaimer note.

Max. gross trailer weight 4850 lbs

Max. towball load 485 lbs

Unbraked trailer

Max. gross trailer weight 1650 lbs

15.1.4. Type designations

Knowing the vehicle's detailed information can help facilitate contact with a Volvo retailer and when ordering spare parts and accessories.

Labels



① Label Vehicle Emission Control Information

② Certification label

Your Volvo is designed to meet all applicable emission standards, as evidenced by the label. The label is located on the right side of the hood's inner panel and will be visible when the hood is opened.

The certification label is located on the left-hand door pillar and will be visible when the door is open.



Label Vehicle Emission Control Information

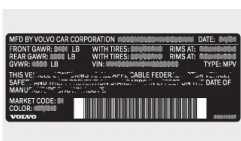

Certification label

Examples of information you can find on the certification label:

- Build date

The content of this manual represents the status of the user manual at the time of printing and may not be completely valid in future instances. For more information refer to the first page for the complete disclaimer note.

- Vehicle identification number
- Weight information
- Code designation for exterior color

Note

Labels depicted in this manual are generic representations of those found around your vehicle. The manual only contains their location and what kind of information they contain. Find the actual label for specific information about your vehicle.

Tip

For many markets, more information can also be found in the vehicle's registration document.

15.2. Powertrain specifications

Find the specifications regarding your vehicle's propulsion.

These specifications provide details about what your vehicle is capable of and certified for. They also specify data on relevant charging cables.

15.2.1. Electric motor specifications

Your vehicle is powered by two electric motors (front and rear) and you can find the specifications here.

Twin Motor Performance			
Front	Electric motor type		Asynchronous motor
	Electric motor model		F22DA
	Max. power output	kW	220
		hp	299
	Rated power (continuous power)		kW N/A
	Max. torque	Nm	390
		lb-ft	288

Rear	Electric motor type		Synchronous motor with permanent magnet
	Electric motor model		R31DA
	Max. power output	kW	280
		hp	381
	Rated power (continuous power)		kW N/A
	Max. torque	Nm	480
lb-ft		354	
Total vehicle (system)	Max. power output	kW	500
		hp	680
	Rated power (continuous power)		kW N/A
	Max. torque	Nm	870
		lb-ft	642

Note

If data is missing, it will be updated at a later stage.

15.2.2. Performance

You can find the vehicle's top speed and acceleration time below.

Top speed 180 km/h (112 mph)

Acceleration time 0-100 km/h (0-60 mph) 4.2 seconds (4.0 seconds)

Note

If data is missing, it will be updated at a later stage.

15.2.3. Charging cable specifications

These specifications provide details about mode 2 charging cables. Mode 2 charging cables can be purchased from the Volvo Extras shop.

Enclosure type IP 67

Compliance SAE J1772

Ambient temperature -32 °C to 50 °C (-25 °F to 122 °F)

Residual-current device

The content of this manual represents the status of the user manual at the time of printing and may not be completely valid in future instances. For more information refer to the first page for the complete disclaimer note.

Mode 2 charging cables have a built-in residual current device that protects the vehicle and the user from electric shocks caused by system faults.

 **Warning**

The residual-current device helps to protect the vehicle's charging system, but there is no guarantee that an overload will never occur.

 **Important**

The residual-current device does not protect the household outlet.

Temperature monitoring

The mode 2 cable is also equipped with a control unit, which has a built-in overtemperature monitoring function. This monitors the temperature of both the cable and the household outlet.

 **Important**

- Avoid exposing the control unit and its plug connector to direct sunlight. The overheating protection in the plug connector may otherwise reduce or stop your vehicle's charging.
- If charging is unintentionally stopped, both the charging cable and the vehicle system should be checked by a trained and qualified Volvo service technician. The household outlet should also be checked by a licensed electrician.

15.3. Wheel and tire specifications

Here you can find specific wheel and tire information applicable to your vehicle.

 **Note**

There are more recommendations regarding wheels and tires that are important to be aware of.

15.3.1. Approved tire pressures

You can find the approved tire pressures for your vehicle in the table below.

The recommended pressure for approved tires can be found on the tire pressure label. It's located on the door pillar on the driver's side and is visible when the door is opened.

Tire size	Cold tire pressure for up to seven people (depending on number of seats)	
	Front psi (kPa)	Rear psi (kPa)
255/50 R20 285/45 R20	41 (280)	41 (280)
265/45 R21 295/40 R21 265/40 R22 295/35 R22	42 (290)	42 (290)
Temporary spare tire T175/70 R20	60 (420)	60 (420)

 **Important**

Never swap the front and rear wheels.

15.4. Fluid specifications

Your vehicle has fluids to help its different systems function properly. When it is time to refill or perform maintenance, you may need to know the specifics of these fluids.

It is recommended that you get some fluids changed or filled by an authorized Volvo workshop. Check this section for the fluid you need information on and, if necessary, contact an authorized Volvo workshop to schedule an appointment.

15.4.1. Brake fluid specifications

The medium in your vehicle's brake system is called brake fluid.

Prescribed grade Volvo Original or equivalent brake fluid that fulfills a combination of the DOT 4, 5.1 and ISO 4925 class 6 classifications.

 **Important**

It is recommended that brake fluid be changed or filled by an authorized Volvo workshop.

15.4.2. Climate system specifications

Here you will find information about the refrigerant quantity and the prescribed quality and volume for compressor oil.

Climate system label



The label with information on climate system fluids is located on the underside of the hood.

On this label you can find:

- Refrigerant type (R1234yf)
- Refrigerant quantity

Label symbols



Caution



A trained and certified technician is required to service the mobile air conditioning system^[1]



Flammable refrigerants



Mobile air conditioning system^[1]



Lubricant type

Compressor oil

Volume 150 ml (5.07 US fl oz) (5.28 UK fl oz)

Prescribed grade POE V100

Servicing and repair of the climate system

Warning

Servicing and repair

The climate system contains pressurized refrigerant. The climate system must only be serviced and repaired by trained and certified technicians in order to ensure the safety of the system^[2]. Volvo recommends that you visit an authorized Volvo workshop for any repair or service needs.

Important

Repairing the evaporator

The climate system's evaporator must never be repaired or replaced with a previously used evaporator. A new evaporator must be certified and labeled in accordance with SAE J2842.

The content of this manual represents the status of the user manual at the time of printing and may not be completely valid in future instances. For more information refer to the first page for the complete disclaimer note.

[1] MAC

[2] In accordance with SAE J2845 (Technician Training for Safe Service and Containment of Refrigerants Used in Mobile A/C System).

15.5. Certificates and type approvals

This documentation shows that your vehicle meets certain standards and specifications.

User manuals are required by law to provide documentation of certain certificates and type approvals.

For more information, contact Volvo Support.

15.5.1. Procedure to temporarily change the automatic high beam sensitivity



You can set an alternative automatic high beam sensitivity in accordance with FMVSS108 requirements.

Important

The vehicle must be stationary to change the sensitivity. Keep the brake pedal pressed down throughout the procedure.

1. Put the vehicle in drive by selecting **D** with the right-hand steering wheel stalk.
 2. Press the vehicle symbol  in the bottom bar and go to **Settings**.
 3. Go to **Controls** → **Lights and displays** → **Exterior lights** → **Primary lighting**.
- > Make sure that the default automatic lights mode^[1] is selected.

The following steps must be completed within 30 seconds:

4. Press the low beam symbol .
5. Activate the high beam flash with a short pull on the left-hand steering wheel stalk.
6. Select automatic lights mode again in the primary lighting modes.
7. Activate the high beam flash again with a short pull on the left-hand steering wheel stalk.
8. Press the passing beam symbol  again.
9. Activate the high beam flash once more with a short pull on the left-hand steering wheel stalk.
10. Select automatic lights mode in the primary lighting modes.

Note

The sensitivity returns to the default setting when you start a new drive cycle.



^[1] Auto



15.5.2. Exterior radar type approvals

Find the exterior radar type approval you're looking for among the ones listed here.

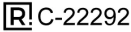
Front center radar



The content of this manual represents the status of the user manual at the time of printing and may not be completely valid in future instances. For more information refer to the first page for the complete disclaimer note.





Region	Labels and symbols	Specification
Argentina		C-22292
Australia		
Brazil		Este equipamento não tem direito à proteção contra interferência prejudicial e não pode causar interferência em sistemas devidamente autorizados. Para mais informações, consulte o site da ANATEL – https://www.gov.br/anatel/pt-br [https://www.gov.br/anatel/pt-br]
Canada		<p>Advanced Radar Sensor, ARS5-B IC: 4135A-ARS5B</p> <p>This device contains licence-exempt transmitter(s)/receiver(s) that comply with Innovation, Science and Economic Development Canada's licence-exempt RSS(s). Operation is subject to the following two conditions:</p> <p>(1) This device may not cause interference. (2) This device must accept any interference, including interference that may cause undesired operation of the device.</p> <p>L'émetteur/récepteur exempt de licence contenu dans le présent appareil est conforme aux CNR d'Innovation, Sciences et Développement économique Canada applicables aux appareils radio exempts de licence. L'exploitation est autorisée aux deux conditions suivantes:</p> <p>(1) L'appareil ne doit pas produire de brouillage; (2) L'appareil doit accepter tout brouillage radioélectrique subi, même si le brouillage est susceptible d'en compromettre le fonctionnement.</p> <p>Radiofrequency radiation exposure Information: This equipment complies with radiation exposure limits set forth for an uncontrolled environment. This equipment should be installed and operated with minimum distance of 20 cm between the radiator and the body of any persons, user or bystander.</p> <p>Informations sur l'exposition aux rayonnements radiofréquences: Cet équipement est conforme aux limites d'exposition aux rayonnements établies pour un environnement non contrôlé. Cet équipement doit être installé et utilisé avec un minimum de 20 cm de distance entre la source de rayonnement et votre corps.</p>

Region	Labels and symbols	Specification
China		<p>76-77GHz 2 3 4 10</p>
Eurasian Economic Union		<p>Настоящим компания ADC Automotive Distance Control Systems GmbH, Peter-Dornier-Strasse 10, 88131 Lindau, Germany, заявляет, что данный ARS5-B соответствует основным требованиям и другим соответствующим положениям Директивы. Оригинал декларации соответствия можно просмотреть по следующей ссылке http://continental.automotive-approvals.com/ Частотный диапазон(ы), в котором(ых) работает радиооборудование: 76-77 ГГц Максимальная мощность радиочастот, передаваемая в частотном диапазоне(ах), в котором(ых) работает радиооборудование: 33 дБм RMS EIRP дБм (2 Вт) Made in: China аппаратура радиолокационная, радионавигационная, датчик адаптивной радиолокационной станции</p>
European Union & EFTA	 <p>ADC Automotive Distance Control Systems GmbH Peter-Dornier-Strasse 10, 88131 Lindau, Germany</p>	<p>Simplified EU declaration of conformity. English Hereby, ADC Automotive Distance Control Systems GmbH declares that the radio equipment type ARS5-B is in compliance with Directive 2014/53/EU. The full text of the EU declaration of conformity is available at the following internet address: http://continental.automotive-approvals.com/ Frequency band(s) in which the radio equipment operates: 76–77 GHz Maximum radio-frequency power transmitted in the frequency band(s) in which the radio equipment operates: 2.0 W (33 dBm RMS EIRP)</p> <p>Bulgarian С настоящото ADC Automotive Distance Control Systems GmbH декларира, че този тип радиосъоръжение ARS5-B е в съответствие с Директива 2014/53/ЕС. Цялостният текст на ЕС декларацията за съответствие може да се намери на следния интернет адрес: http://continental.automotive-approvals.com/ радиочестотната лента или ленти, в която или които работи радиосъоръжението: 76–77 GHz максималната радиочестотна мощност, излъчвана в радиочестотната лента или ленти, в която или които работи радиосъоръжението.: 2.0 W (33dBm RMS EIRP)</p> <p>Spanish Por la presente, ADC Automotive Distance Control Systems GmbH declara que el tipo de equipo radioeléctrico ARS5-B es conforme con la Directiva 2014/53/UE. El texto completo de la declaración UE de conformidad está disponible en la dirección Internet siguiente: http://continental.automotive-approvals.com/ Banda o bandas de frecuencia en las que opera el equipo radioeléctrico: 76–77 GHz Potencia máxima de radiofrecuencia transmitida en la banda o bandas de frecuencia en las que opera el equipo radioeléctrico: 2.0 W (33dBm RMS EIRP)</p> <p>Czech Tímto ADC Automotive Distance Control Systems GmbH prohlašuje, že typ rádiového zařízení ARS5-B je v souladu se směrnicí 2014/53/EU. Úplné znění EU prohlášení o shodě je k dispozici na této internetové adrese: http://continental.automotive-approvals.com/ Kmitočtové pásmo (kmitočtová pásma), v němž (v nichž) rádiové zařízení pracuje: 76–77 GHz Maximální radiofrekvenční výkon vysílaný v kmitočtovém pásmu (v kmitočtových pásmech), v němž (v nichž) je rádiové zařízení provozováno: 2.0 W (33dBm RMS EIRP)</p> <p>Danish Hermed erklærer ADC Automotive Distance Control Systems GmbH, at radioudstyrstypen ARS5-B er i overensstemmelse med direktiv 2014/53/EU. EU-overensstemmelseserklæringens fulde tekst kan findes på følgende internetadresse: http://continental.automotive-approvals.com/ Frekvensbånd, som radioudstyret fungerer på: 76–77 GHz Maksimal radiofrekvenseffekt, der udsendes i de frekvensbånd, som radioudstyret fungerer på: 2.0 W (33dBm RMS EIRP)</p> <p>German Hiermit erklärt ADC Automotive Distance Control Systems GmbH, dass der Funkanlagentyp ARS5-B der Richtlinie 2014/53/EU entspricht. Der vollständige Text der EU-Konformitätserklärung ist unter der folgenden Internetadresse verfügbar: http://continental.automotive-approvals.com/ Das Frequenzband oder die Frequenzbänder, in dem bzw. denen die Funkanlage betrieben wird: 76–77 GHz Die in dem Frequenzband oder den Frequenzbändern, in dem bzw. denen die Funkanlage betrieben wird, abgestrahlte maximale Sendeleistung: 2.0 W (33dBm RMS EIRP)</p> <p>Estonian</p>

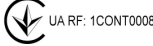

Region	Labels and symbols	Specification
		<p>Käesolevaga deklareerib ADC Automotive Distance Control Systems GmbH, et käesolev raadioseadme tüüp ARS5-B vastab direktiivi 2014/53/EL nõuetele. ELi vastavusdeklaratsiooni täielik tekst on kättesaadav järgmisel internetiaadressil: http://continental.automotive-approvals.com/</p> <p>Sagedusriba(d), millel raadioseade töötab: 76–77 GHz</p> <p>Raadioseadme töösagedus(t)el edastatav maksimaalne saatevõimsus: 2.0 W (33dBm RMS EIRP)</p> <p>Greek</p> <p>Με την παρούσα ο/η ADC Automotive Distance Control Systems GmbH, δηλώνει ότι ο ραδιοεξοπλισμός ARS5-B πληροί την οδηγία 2014/53/ΕΕ. Το πλήρες κείμενο της δήλωσης συμμόρφωσης ΕΕ διατίθεται στην ακόλουθη ιστοσελίδα στο διαδίκτυο: http://continental.automotive-approvals.com/</p> <p>Οι ζώνες συχνοτήτων στις οποίες λειτουργεί ο ραδιοεξοπλισμός: 76–77 GHz</p> <p>η μέγιστη ραδιοηλεκτρική ισχύς στις ζώνες συχνοτήτων στις οποίες λειτουργεί ο ραδιοεξοπλισμός: 2.0 W (33dBm RMS EIRP)</p> <p>French</p> <p>Le soussigné, ADC Automotive Distance Control Systems GmbH, déclare que l'équipement radioélectrique du type ARS5-B est conforme à la directive 2014/53/UE. Le texte complet de la déclaration UE de conformité est disponible à l'adresse internet suivante : http://continental.automotive-approvals.com/</p> <p>Bandes de fréquences utilisées par l'équipement radioélectrique : 76–77 GHz</p> <p>Puissance de radiofréquence maximale transmise sur les bandes de fréquences utilisées par l'équipement radioélectrique : 2.0 W (33dBm RMS EIRP)</p> <p>Croatian</p> <p>ADC Automotive Distance Control Systems GmbH ovime izjavljuje da je radijska oprema tipa ARS5-B u skladu s Direktivom 2014/53/EU. Cjeloviti tekst EU izjave o sukladnosti dostupan je na sljedećoj internetskoj adresi: http://continental.automotive-approvals.com/</p> <p>Frekvencijski pojas (frekvencijski pojasi) u kojem (kojima) radijska oprema radi: 76–77 GHz</p> <p>Najveća radiofrekvencijska snaga koja se prenosi u frekvencijskom pojasu (frekvencijskim pojasi) u kojem (kojima) radijska oprema radi: 2.0 W (33dBm RMS EIRP)</p> <p>Italian</p> <p>Il fabbricante, ADC Automotive Distance Control Systems GmbH, dichiara che il tipo di apparecchiatura radio ARS5-B è conforme alla direttiva 2014/53/UE. Il testo completo della dichiarazione di conformità UE è disponibile al seguente indirizzo Internet: http://continental.automotive-approvals.com/</p> <p>Bande di frequenza di funzionamento dell'apparecchiatura radio: 76–77 GHz</p> <p>Massima potenza a radiofrequenza trasmessa nelle bande di frequenza in cui opera l'apparecchiatura radio: 2.0 W (33dBm RMS EIRP)</p> <p>Latvian</p> <p>Ar šo ADC Automotive Distance Control Systems GmbH deklarē, ka radioiekārta ARS5-B atbilst Direktīvai 2014/53/ES. Pilns ES atbilstības deklarācijas teksts ir pieejams šādā interneta vietnē: http://continental.automotive-approvals.com/</p> <p>Frekvenču joslu(-as), kurā(-ās) radioiekārtas darbojas: 76–77 GHz</p> <p>Frekvenču joslā(-ās), kurā(-ās) darbojas radioiekārtas, maksimālo pārraidītā signāla jaudu: 2.0 W (33dBm RMS EIRP)</p> <p>Lithuanian</p> <p>Aš, ADC Automotive Distance Control Systems GmbH, patvirtinu, kad radijo įrenginių tipas ARS5-B atitinka Direktyvą 2014/53/ES. Visas ES atitikties deklaracijos tekstas prieinamas šiuo interneto adresu: http://continental.automotive-approvals.com/</p> <p>Dažnių juosta (-os), kurioje (-iose) veikia radijo įrenginiai: 76–77 GHz</p> <p>Didžiausia radijo dažnių galia, perduodama toje (tose) dažnių juostoje (-ose), kurioje (-iose) veikia radijo įrenginiai: 2.0 W (33dBm RMS EIRP)</p> <p>Hungarian</p> <p>ADC Automotive Distance Control Systems GmbH igazolja, hogy a ARS5-B típusú rádióberendezés megfelel a 2014/53/EU irányelvnek. Az EU-megfelelőségi nyilatkozat teljes szövege elérhető a következő internetes címen: http://continental.automotive-approvals.com/</p> <p>Az(ok) a frekvenciasáv(ok), amely(ek)en a rádióberendezés működik: 76–77 GHz</p> <p>Az abban a frekvenciasávban vagy azokban a frekvenciasávokban továbbított maximális jelerősség, amely(ek)ben a rádióberendezés üzemel: 2.0 W (33dBm RMS EIRP)</p> <p>Maltese</p> <p>B'dan, ADC Automotive Distance Control Systems GmbH, niddikjara li dan it-tip ta' tagħmir tar-radju ARS5-B huwa konformi mad-Direttiva 2014/53/UE. It-test kollu tad-dikjarazzjoni ta' konformità tal-UE huwa disponibbli f'dan l-indirizz tal-Internet li ġej: http://continental.automotive-approvals.com/</p> <p>Il-medda/meded tal-frekwenza li jaħdem fihom it-tagħmir tar-radju: 76–77 GHz</p> <p>Il-potenza massima tal-frekwenza tar-radju trażmessa fil-medda/meded tal-frekwenza li jaħdem fihom it-tagħmir tar-radju: 2.0 W (33dBm RMS EIRP)</p> <p>Dutch</p> <p>Hierbij verklaar ik, ADC Automotive Distance Control Systems GmbH, dat het type radioapparatuur ARS5-B conform is met Richtlijn 2014/53/EU. De volledige tekst van de EU-conformiteitsverklaring kan worden geraadpleegd op het volgende internetadres: http://continental.automotive-approvals.com/</p> <p>Frequentieband(en) waarin de radioapparatuur functioneert: 76–77 GHz</p> <p>Maximaal radiofrequent vermogen uitgezonden in de frequentieband(en) waarin de radioapparatuur functioneert: 2.0 W (33dBm RMS EIRP)</p> <p>Polish</p> <p>ADC Automotive Distance Control Systems GmbH niniejszym oświadcza, że typ urządzenia radiowego ARS5-B jest zgodny z dyrektywą 2014/53/UE. Pełny tekst deklaracji zgodności UE jest dostępny pod następującym adresem internetowym: http://continental.automotive-approvals.com/</p>

Region	Labels and symbols	Specification
		<p>p://continental.automotive-approvals.com/</p> <p>Zakresu(-ów) częstotliwości, w którym (których) pracuje urządzenie radiowe: 76–77 GHz</p> <p>Maksymalnej mocy częstotliwości radiowej emitowanej w zakresie(-ach) częstotliwości, w którym (których) pracuje urządzenie radiowe: 2.0 W (33dBm RMS EIRP)</p> <p>Portuguese</p> <p>O(a) abaixo assinado(a) ADC Automotive Distance Control Systems GmbH declara que o presente tipo de equipamento de rádio ARS5-B está em conformidade com a Diretiva 2014/53/UE. O texto integral da declaração de conformidade está disponível no seguinte endereço de Internet: http://continental.automotive-approvals.com/</p> <p>A(s) banda(s) de frequências em que o equipamento de rádio funciona: 76–77 GHz</p> <p>A potência máxima de radiofrequências transmitida na(s) banda(s) de frequências em que o equipamento de rádio funciona: 2.0 W (33dBm RMS EIRP)</p> <p>Romanian</p> <p>Prin prezenta, ADC Automotive Distance Control Systems GmbH declară că tipul de echipamente radio ARS5-B este în conformitate cu Directiva 2014/53/UE. Textul integral al declarației UE de conformitate este disponibil la următoarea adresă internet: http://continental.automotive-approvals.com/</p> <p>Banda (benzile) de frecvențe în care funcționează echipamentul radio: 76–77 GHz</p> <p>Puterea maximă de radiofrecvență transmisă în banda (benzile) de frecvențe în care funcționează echipamentul radio: 2.0 W (33dBm RMS EIRP)</p> <p>Slovak</p> <p>ADC Automotive Distance Control Systems GmbH týmto vyhlasuje, že rádiové zariadenie typu ARS5-B je v súlade so smernicou 2014/53/EÚ. Úplné EÚ vyhlásenie o zhode je k dispozícii na tejto internetovej adrese: http://continental.automotive-approvals.com/</p> <p>Frekvenčné pásmo resp. pásma, v ktorých rádiové zariadenie pracuje: 76–77 GHz</p> <p>Maximálny vysokofrekvenčný výkon prenášaný vo frekvenčnom pásme, resp. pásmach, v ktorých rádiové zariadenie pracuje: 2.0 W (33dBm RMS EIRP)</p> <p>Slovenian</p> <p>ADC Automotive Distance Control Systems GmbH potrjuje, da je tip radijske opreme ARS5-B skladen z Direktivo 2014/53/EU. Celotno besedilo izjave EU o skladnosti je na voljo na naslednjem spletnem naslovu: http://continental.automotive-approvals.com/</p> <p>Frekvenčni pas ali pasovi, na katerih deluje radijska oprema: 76–77 GHz</p> <p>Največja energija za radijsko frekvenco, preneseno po frekvenčnem pasu ali pasovih, na katerih radijska oprema deluje: 2.0 W (33dBm RMS EIRP)</p> <p>Finnish</p> <p>ADC Automotive Distance Control Systems GmbH vakuuttaa, että radiolaitetyyppi ARS5-B on direktiivin 2014/53/EU mukainen. EU-vaatimusten mukaisuusvakuutuksen täysimittainen teksti on saatavilla seuraavassa internetosoitteessa: http://continental.automotive-approvals.com/</p> <p>Radiotaajuudet, joilla radiolaitte toimii: 76–77 GHz</p> <p>Suurin mahdollinen lähetytsto radiotaajuuksilla, joilla radiolaitte toimii: 2.0 W (33dBm RMS EIRP)</p> <p>Swedish</p> <p>Härmed försäkrar ADC Automotive Distance Control Systems GmbH att denna typ av radioutrustning ARS5-B överensstämmer med direktiv 2014/53/EU. Den fullständiga texten till EU-försäkran om överensstämmelse finns på följande webbadress: http://continental.automotive-approvals.com/</p> <p>Det eller de frekvensband där radioutrustningen arbetar: 76–77 GHz</p> <p>Den maximala radiofrekvensseffekt som överförs inom det eller de frekvensband där radioutrustningen arbetar: 2.0 W (33dBm RMS EIRP)</p> <p>EFTA countries</p> <p>Icelandic</p> <p>Hér með lýsir ADC Automotive Distance Control Systems GmbH því yfir, að fjarskiptabúnaðurinn að gerð ARS5-B er í samræmi við tilskipun 2014/53/ ESB. Textinn í fullri lengd um Samræmisýfirlýsingu ESB er aðgengilegur á eftirfarandi veffangi: http://continental.automotive-approvals.com/</p> <p>Bandbreidd(ir), sem fjarskiptabúnaðurinn starfar í: 76–77 GHz</p> <p>Hámarks fjarskiptatíðni sendistyrkleika í bandbreiddinni/bandbreiddunum sem fjarskiptabúnaðurinn starfar í: 2.0 W (33dBm RMS EIRP)</p> <p>Custom Union Agreement between EU and Turkey</p> <p>Turkish</p> <p>İşbu belge ile, ADC Automotive Distance Control Systems GmbH şirketi ARS5-B tipi radyo ekipmanının 2014/53/AB sayılı direktife uygun olduğunu beyan eder. AB uygunluk beyanının tam metni aşağıdaki İnternet adresinde mevcuttur: http://continental.automotive-approvals.com/</p> <p>Radyo cihazının çalıştığı frekans bandı/bantları: 76–77 GHz</p> <p>Radyo ekipmanının çalıştığı frekans bandında/bantlarında iletilen maksimum radyo frekansı gücü: 2.0 W (33dBm RMS EIRP)</p> <p>Additional languages</p> <p>Albanian</p> <p>Nëpërmjet këtij dokumenti, "ADC Automotive Distance Control Systems GmbH" deklaron se radiopajisja e llojit ARS5-B është në pajtim me direktivën 2014/53/BE. Teksti i plotë i deklaratsë së konformitetit të BE-së disponohet në adresën e mëposhtme të internetit: http://continental.automotive-approvals.com/</p> <p>Brezat e frekuencës në të cilat punon radiopajisja: 76–77 GHz</p>

Region	Labels and symbols	Specification
		<p>Fuqia maksimale e radiofrekuencës e transmetuar në brezat e frekuencës në të cilat punon radiopajisja: 2.0 W (33 dBm RMS EIRP)</p> <p>Bosnian Ovim putem kompanija ADC Automotive Distance Control Systems GmbH potvrđuje da je tip radio opreme ARS5-B u skladu s Direktivom 2014/53/EU. Cjelokupni tekst EU izjave o usklađenosti je dostupan na sljedećoj web adresi: http://continental.automotive-approvals.com/ Frekvencijski pojasevi na kojima funkcioniра radio oprema: 76–77 GHz Maksimalna snaga radiofrekvencije koja se prenosi putem frekvencijskih pojaseva na kojima funkcioniра radio oprema: 2.0 W (33 dBm RMS EIRP)</p> <p>Georgian ამით, ADC Automotive Distance Control Systems GmbH აცხადებს, რომ ARS5-B ტიპის რადიომონწყობილობა შეესაბამება 2014/53/EU დირექტივას. ევროკავშირის შესაბამისობის დეკლარაციის სრული ტექსტი ხელმისაწვდომია შემდეგ ინტერნეტმისამართზე: http://continental.automotive-approvals.com/ სიხშირის დიაპაზონ(ებ)ი, რომელშიც/რომლებშიც რადიომონწყობილობა მუშაობს: 76–77 გჰც რადიოსიხშირის მაქსიმალური სიმძლავრე, გადაცემული სიხშირის დიაპაზონ(ებ)ში, რომელშიც/რომლებშიც რადიომონწყობილობა მუშაობს: 2.0 ვტ (33 დბმვ RMS EIRP)</p> <p>Macedonian ADC Automotive Distance Control Systems GmbH изјавува дека радио опремата од типот ARS5- В е во сообразност со Директивата 2014/53/EУ. Целосниот текст на Декларацијата за сообразност на ЕУ е достапен на следната интернет-адреса: http://continental.automotive-approvals.com/ Фреквентно поле(иња) во кои радио опремата функционира: 76–77 GHz Максимална моќност на радиофреквенција која се пренесува во фреквентното поле(иња) во кои радио опремата функционира: 2.0 W (33 dBm RMS EIRP)</p>
Ghana		AR2-0M-GE2-114
Indonesia	<p>For products manufactured in China:</p> 	
Israel		<p>510485261 מספר זיהוי היבואן</p> <p>חל איסור לבצע פעולות במכשיר שיש בהן כדי לשנות את תכונותיו האלחוטיות של המכשיר, ובכלל זה שינוי תוכנה, החלפת אנטנה מקורית או הוספת אפשרות לחיבור לאנטנה חיצונית, בלא קבלת אישור משרד התקשורת, בשל חשש להפרעת אלחוטיות</p>
Jordan		<p>ARS5-B</p> <p>ADC Automotive Distance Control Systems GmbH Peter-Dornier-Strasse 10, 88131 Lindau, Germany Continental</p>
Malaysia		
Mexico		IFETEL: RCPCOAR18-1800
Moldova		<p>Romanian</p> <p>DECLARAȚIA UE DE CONFORMITATE SIMPLIFICATĂ</p> <p>Prin prezenta, ADC Automotive Distance Control Systems GmbH declară că tipul de echipamente radio ARS5-B este în conformitate cu Reglementarea tehnică „Punerea la dispoziție pe piață a echipamentelor radio”. Textul integral al declarației de conformitate este disponibil la următoarea adresă de Internet: http://continental.automotive-approvals.com/ Banda (benzile) de frecvențe în care funcționează echipamentul radio: 76–77 GHz Puterea maximă de radiofrecvență transmisă în banda (benzile) de frecvențe în care funcționează echipamentul radio: 2.0 W (33dBm RMS EIRP)</p>
Morocco		<p>AGREE PAR L'ANRT MAROC</p> <p>Numéro d'agrément: MR 17505 ANRT 2018</p> <p>Date d'agrément: 14/09/2018</p>

Region	Labels and symbols	Specification
		
Ukraine		<p>US RF: 1CONT0008</p> <p>Ukrainian</p> <p>Цим ADC Automotive Distance Control Systems GmbH заявляє, що радіобладнання типу ARS5-B відповідає вимогам Директиви 2014/53/EU. Повний текст декларації ЄС про відповідність доступний за наступною адресою в мережі Інтернет: http://continental.automotive-approvals.com/</p> <p>Частотний діапазон(-и), в якому працює радіобладнання: 76–77 ГГц</p> <p>Максимальна потужність радіочастотного сигналу, що передається у частотному діапазоні(-ах), в якому працює радіобладнання: 2.0 Вт (33 дБм середньоквадратична ефективна потужність випромінювання)</p>
United Kingdom		<p>Model: ARS5-B</p> <p>FCC ID: OAYARS5B</p> <p>Contact information</p> <p>Volvo Car UK, Scandinavia House, Norreys Drive, Maidenhead, SL6 4FL, UK.</p> <p>Phone number: +441628 422200</p> <p>Simplified UK declaration of conformity</p> <p>Hereby, ADC Automotive Distance Control Systems GmbH declares that the radio equipment type ARS5-B is in compliance with the Radio Equipment Regulations 2017, SI 2017:1206 (as amended). The full text of the UK declaration of conformity is available at the following internet address: http://continental.automotive-approvals.com/</p> <p>Frequency band(s) in which the radio equipment operates: 76–77 GHz</p> <p>Maximum radio-frequency power transmitted in the frequency band(s) in which the radio equipment operates: 2.0 W (33 dBm RMS EIRP)</p>
United States		<p>Model: ARS5-B</p> <p>FCC ID: OAYARS5B</p> <p>Radiofrequency radiation exposure information: This equipment complies with FCC radiation exposure limits set forth for an uncontrolled environment. This equipment should be installed and operated with minimum distance of 20 cm between the radiator and your body. This transmitter must not be co-located or operating in conjunction with any other antenna or transmitter.</p> <p>Changes or modifications not expressly approved by the party responsible for compliance could void the user's authority to operate the equipment.</p>
Vietnam		
Zambia		

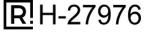
Front corner radar units



Region	Labels and symbols	Specification
Argentina		
Algeria		
Brazil		<p>Este equipamento não tem direito à proteção contra interferência prejudicial e não pode causar interferência em sistemas devidamente autorizados.</p>

Region	Labels and symbols	Specification
Canada		<p>This device contains licence-exempt transmitter(s)/receiver(s) that comply with Innovation, Science and Economic Development Canada's licence-exempt RSS(s). Operation is subject to the following two conditions:</p> <p>(1) This device may not cause interference.</p> <p>(2) This device must accept any interference, including interference that may cause undesired operation of the device.</p> <p>L'émetteur/récepteur exempt de licence contenu dans le présent appareil est conforme aux CNR d'Innovation, Sciences et Développement économique Canada applicables aux appareils radio exempts de licence. L'exploitation est autorisée aux deux conditions suivantes :</p> <p>1) L'appareil ne doit pas produire de brouillage;</p> <p>2) L'appareil doit accepter tout brouillage radioélectrique subi, même si le brouillage est susceptible d'en compromettre le fonctionnement.</p>



Region	Labels and symbols	Specification
		<p>Tehniline informatsioon: Sagedusriba: 76 ... 77 GHz Edastusvõimsus: 20 dBm (keskmise) EIRP Tootja ja aadress: HELLA GmbH & Co. KGaA Rixbecker Straße 75, 59552 Lippstadt, Saksamaa</p> <p>Greek Με την παρούσα ο/η HELLA GmbH & Co. KGaA, δηλώνει ότι ο ραδιοεξοπλισμός RS5.3 πληροί την οδηγία 2014/53/ΕΕ. Το πλήρες κείμενο της δήλωσης συμμόρφωσης ΕΕ διατίθεται στην ακόλουθη ιστοσελίδα στο διαδίκτυο: www.hella.com/vcc Τεχνικές πληροφορίες: Ζώνη συχνότητας: 76 ... 77 GHz Ισχύς μετάδοσης: 20 dBm (μέση) EIRP Κατασκευαστής και Διεύθυνση: HELLA GmbH & Co KGaA Rixbecker Straße 75, 59552 Lippstadt, Γερμανία</p> <p>French Le soussigné, HELLA GmbH & Co. KGaA, déclare que l'équipement radioélectrique du type RS5.3 est conforme à la directive 2014/53/UE. Le texte complet de la déclaration UE de conformité est disponible à l'adresse internet suivante: www.hella.com/vcc Informations techniques: Bande de fréquence : 76 ... 77 GHz Puissance d'émission : 20 dBm (moyenne) EIRP Fabricant et adresse : HELLA GmbH & Co. KGaA Rixbecker Straße 75, 59552 Lippstadt, Allemagne</p> <p>Gaelic Leis seo, dearbhaionn Hella GmbH & Co. KGaA go gcomhlíonann an cineál trealaimh raidió RS5.3 Treoir 2014/53 / AE. Tá téacs iomlán dhearbú comhréireachta an AE ar fáil ag an seoladh idirlín seo a leanas: www.hella.com/vcc Gwybodaeth dechnegol: Band amledd: 76 ... 77 GHz Pŵer trosglwyddo: 20 dBm (cyfartaledd) EIRP Gwneuthurwr a Chyfeiriad: HELLA GmbH & Co. KGaA Rixbecker Straße 75, 59552 Lippstadt, yr Almaen</p> <p>Croatian HELLA GmbH & Co. KGaA ovime izjavljuje da je radijska oprema tipa RS5.3 u skladu s Direktivom 2014/53/EU. Cjeloviti tekst EU izjave o sukladnosti dostupan je na sljedećoj internetskoj adresi: www.hella.com/vcc Tehničke informacije: Frekvencijski pojas: 76 ... 77 GHz Snaga prijena: 20 dBm (prosječno) EIRP Proizvođač i adresa: HELLA GmbH & Co. KGaA Rixbecker Straße 75, 59552 Lippstadt, Njemačka</p> <p>Italian Il fabbricante, HELLA GmbH & Co. KGaA, dichiara che il tipo di apparecchiatura radio RS5.3 è conforme alla direttiva 2014/53/UE. Il testo completo della dichiarazione di conformità UE è disponibile al seguente indirizzo Internet: www.hella.com/vcc Informazioni tecniche: Banda di frequenza: 76 ... 77 GHz Potenza di trasmissione: 20 dBm (media) EIRP Produttore e indirizzo: HELLA GmbH & Co. KGaA Rixbecker Straße 75, 59552 Lippstadt, Germania</p> <p>Latvian Ar šo HELLA GmbH & Co. KGaA deklarē, ka radioiekārta RS5.3 atbilst Direktīvai 2014/53/ES. Pilns ES atbilstības deklarācijas teksts ir pieejams šādā interneta vietnē: www.hella.com/vcc Tehniskā informācija: Frekvenču josla: 76 ... 77 GHz Raidīšanas jauda: 20 dBm (vidēji) EIRP Ražotājs un adrese: HELLA GmbH & Co. KGaA Rixbecker Straße 75, 59552 Lippstadt, Vācija</p> <p>Lithuanian Aš, HELLA GmbH & Co. KGaA, patvirtinu, kad radijo įrenginių tipas RS5.3 atitinka Direktyvą 2014/53/ES. Visas ES atitikties deklaracijos tekstas prieinamas šiuo interneto adresu: www.hella.com/vcc Technine informacija: Dažnių juosta: 76 ... 77 GHz Perdavimo galia: 20 dBm (vidutinis) EIRP Gamintojas ir adresas: HELLA GmbH & Co. KGaA Rixbecker Straße 75, 59552 Lippstadt, Vokietija</p> <p>Hungarian HELLA GmbH & Co. KGaA igazolja, hogy a RS5.3 típusú rádióberendezés megfelel a 2014/53/EU irányelvnek. Az EU-megfelelőségi nyilatkozat teljes szövege elérhető a következő internetes címen: www.hella.com/vcc Technikai információ: Frekvenciasáv: 76 ... 77 GHz Átviteli teljesítmény: 20 dBm (átlag) EIRP Gyártó és cím: HELLA GmbH & Co. KGaA Rixbecker Straße 75, 59552 Lippstadt, Németország</p> <p>Maltese B'dan, HELLA GmbH & Co. KGaA, niddikjara li dan it-tip ta' tagħmir tar-radju RS5.3 huwa konformi mad-Direttiva 2014/53/UE. It-test kollu tad-dikjarazzjoni ta' konformità tal-UE huwa disponibbli f'dan l-indirizz tal-Internet li ġej: www.hella.com/vcc Informazzjoni teknika: Faxxa tal-frekwenza: 76 ... 77 GHz</p>

Region	Labels and symbols	Specification
		<p>Qawwa tat-trażmissjoni: 20 dBm (medja) EIRP Manifattur u Indirizz: HELLA GmbH & Co KGaA Rixbecker Straße 75, 59552 Lippstadt, il-Ġermanja</p> <p>Dutch Hierbij verklaar ik, HELLA GmbH & Co. KGaA, dat het type radioapparatuur RS5.3 conform is met Richtlijn 2014/53/EU. De volledige tekst van de EU-conformiteitsverklaring kan worden geraadpleegd op het volgende internetadres: www.hella.com/vcc Technische informatie: Frequentieband: 76 ... 77 GHz Zendvermogen: 20 dBm (gemiddeld) EIRP Fabrikant en adres: HELLA GmbH & Co. KGaA Rixbecker Straße 75, 59552 Lippstadt, Duitsland</p> <p>Polish HELLA GmbH & Co. KGaA niniejszym oświadcza, że typ urządzenia radiowego RS5.3 jest zgodny z dyrektywą 2014/53/UE. Pełny tekst deklaracji zgodności UE jest dostępny pod następującym adresem internetowym: www.hella.com/vcc Specyfikacja: Pasma częstotliwości: 76...77 GHz Moc transmisji: 20 dBm (średnia) EIRP Producent i adres: HELLA GmbH & Co. KGaA Rixbecker Straße 75, 59552 Lippstadt, Niemcy</p> <p>Portuguese O(a) abaixo assinado(a) HELLA GmbH & Co. KGaA declara que o presente tipo de equipamento de rádio RS5.3 está em conformidade com a Diretiva 2014/53/UE. O texto integral da declaração de conformidade está disponível no seguinte endereço de Internet: www.hella.com/vcc Informação técnica: Banda de frequência: 76 ... 77 GHz Potência de transmissão: 20 dBm (média) EIRP Fabricante e Endereço: HELLA GmbH & Co. KGaA Rixbecker Straße 75, 59552 Lippstadt, Alemanha</p> <p>Romanian Prin prezenta, HELLA GmbH & Co. KGaA declară că tipul de echipamente radio RS5.3 este în conformitate cu Directiva 2014/53/UE. Textul integral al declarației UE de conformitate este disponibil la următoarea adresă de internet: www.hella.com/vcc Informații tehnice: Banda de frecvență: 76 ... 77 GHz Puterea de transmisie: 20 dBm (medie) EIRP Producător și adresa: HELLA GmbH & Co. KGaA Rixbecker Straße 75, 59552 Lippstadt, Germania</p> <p>Slovak HELLA GmbH & Co. KGaA týmto vyhlasuje, že rádiové zariadenie typu RS5.3 je v súlade so smernicou 2014/53/EÚ. Úplné EÚ vyhlásenie o zhode je k dispozícii na tejto internetovej adrese: www.hella.com/vcc Technická informácia: Frekvenčné pásmo: 76 ... 77 GHz Vysielací výkon: 20 dBm (priemer) EIRP Výrobca a adresa: HELLA GmbH & Co. KGaA Rixbecker Straße 75, 59552 Lippstadt, Nemecko</p> <p>Slovenian HELLA GmbH & Co. KGaA potrjuje, da je tip radijske opreme RS5.3 skladen z Direktivo 2014/53/EU. Celotno besedilo izjave EU o skladnosti je na voljo na naslednjem spletnem naslovu: www.hella.com/vcc Tehnične informacije: Frekvenčni pas: 76 ... 77 GHz Oddajna moč: 20 dBm (povprečje) EIRP Proizvajalec in naslov: HELLA GmbH & Co. KGaA Rixbecker Straße 75, 59552 Lippstadt, Nemčija</p> <p>Finnish HELLA GmbH & Co. KGaA vakuuttaa, että radiolaitetyypin RS5.3 on direktiivin 2014/53/EU mukainen. EU-vaatimustenmukaisuusvakuutuksen täysimittainen teksti on saatavilla seuraavassa internetosoitteessa: www.hella.com/vcc Tekninen informaatio: Taajuuskaista: 76 ... 77 GHz Lähetysteho: 20 dBm (keskimääräinen) EIRP Valmistaja ja osoite: HELLA GmbH & Co. KGaA Rixbecker Straße 75, 59552 Lippstadt, Saksa</p> <p>Swedish Härmed förklarar HELLA GmbH & Co. KGaA att radioutrustningen av typen RS5.3 överensstämmer med direktiv 2014/53/EU. Den fullständiga texten till EU-försäkran om överensstämmelse finns tillgänglig på följande internetadress: www.hella.com/vcc Teknisk information: Frekvensband: 76 ... 77 GHz Sändningseffekt: 20 dBm (medel) EIRP Tillverkare och adress: HELLA GmbH & Co. KGaA Rixbecker Straße 75, 59552 Lippstadt, Tyskland</p> <p>Turkish HELLA GmbH & Co. KGaA, işbu belgeyle RS5.3 tipi radyo ekipmanının 2014/53/AB sayılı direktife uygun olduğunu beyan eder.</p>

Region	Labels and symbols	Specification
		<p>AB uygunluk beyanının tam metni, aşağıdaki internet adresinde mevcuttur: www.hella.com/vcc</p> <p>Teknik Bilgiler: Frekans bandı: 76 ... 77 GHz İletim gücü: 20 dBm (ortalama) EIRP Üretici ve Adres: HELLA GmbH & Co. KGaA Rixbecker Straße 75, 59552 Lippstadt, Almanya</p> <p>Icelandic Hér með lýsir HELLA GmbH & Co. KGaA því yfir að útlarpsbúnaður af gerðinni RS5.3 sé í samræmi við tilskipun 2014/53/ESB. Heildartexti ESB-samræmisýfirlýsingarinnar er fáanlegur á eftirfarandi netfangi: www.hella.com/vcc Tæknilegar upplýsingar: Tíðnisvið: 76 ... 77 GHz Sendingarkraftur: 20 dBm (meðaltal) EIRP Framleiðandi og heimilisfang: Hella GmbH & Co. KGaA Rixbecker Straße 75, 59552 Lippstadt, Þýskaland</p> <p>Norwegian HELLA GmbH & Co. KGaA erklærer herved at radioutstyret av typen RS5.3 samsvarer med direktiv 2014/53/EU. Den fullstendige teksten til EU-samsvarserklæringen er tilgjengelig på følgende internetadresse: www.hella.com/vcc Teknisk informasjon: Frekvensbånd: 76 ... 77 GHz Overføringsytelse: 20 dBm (gjennomsnittlig) EIRP Produsent og adresse: Hella GmbH & Co. KGaA Rixbecker Straße 75, 59552 Lippstadt, Tyskland</p> <p>Serbian Ovim putem HELLA GmbH & Co. KGaA izjavljuje da je radio-oprema tipa RS5.3 usklađena sa Uredbom 2014/53/EU. Kompletan tekst EU Deklaracije o usaglašenosti dostupan je na sledećoj internet adresi: www.hella.com/vcc Tehničke informacije: Frekvencijski opseg: 76 ... 77 GHz Snaga prenosa: 20 dBm (prosečno) EIRP Proizvođač i adresa: HELLA GmbH & Co. KGaA Rixbecker Straße 75, 59552 Lippstadt, Nemačka</p> <p>Albanian Me anë të kësaj, Hella GmbH & Co. KGaA deklaron se pajisjet e radios tip RS5.3 janë në përputhje me Direktivën 2014/53 / EU. Teksti i plotë i deklaratës së konformitetit të BE është në dispozicion në adresën e mëposhtme të internetit: www.hella.com/vcc Informacion teknik: Fasha e frekuencës: 76 ... 77 GHz Fuqia e transmetimit: 20 dBm (mesatare) EIRP Prodhuesi dhe Adresa: Hella GmbH & Co. KGaA Rixbecker Straße 75, 59552 Lippstadt, Gjermani</p> <p>Bosnian Ovime kompanija Hella GmbH & Co. KGaA izjavljuje da je radijska oprema tipa RS5.3 u skladu s Direktivom 2014/53/EU. Puni tekst EU Izjave o sukladnosti dostupan je na sljedećoj internet adresi: www.hella.com/vcc Tehničke informacije: Raspon frekvencije: 76 ... 77 GHz Snaga prijena: 20 dBm (prosječno) EIRP (efektivna izotropska snaga zračenja) Proizvođač i adresa: Hella GmbH & Co. KGaA Rixbecker Straße 75, 59552 Lippstadt, Njemačka</p> <p>Macedonian Со ова Hella GmbH & Co. KGaA декларира дека радиоопремата од тип RS5.3 е во согласност со Директивата 2014/53/EU. Целосниот текст на декларацијата за сообразност на ЕУ е достапна на следната интернет-адреса: www.hella.com/vcc Технички информации: Појас на фреквенција: 76 ... 77 GHz Моќност на трансмисија: 20 dBm (просечна) EIRP Производител и адреса: Hella GmbH & Co. KGaA Rixbecker Straße 75, 59552 Lippstadt, Германија</p>
Ghana		NCA Approved: 7E5-7M-156-RDR

Region	Labels and symbols	Specification
United States of America		This device complies with Part 95M of the FCC Rules. Operation is subject to the following two conditions: (1) this device may not cause harmful interference, and (2) this device must accept any interference received, including interference that may cause undesired operation. CAUTION TO USERS Changes or modifications not expressly approved by the party responsible for compliance could void the user's authority to operate the equipment.
Vietnam		
Zambia		

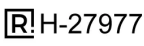
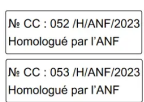

Rear corner radar units

Region	Labels and symbols	Specification
Argentina		
Algeria		
Australia		
Brazil		Este equipamento não tem direito à proteção contra interferência prejudicial e não pode causar interferência em sistemas devidamente autorizados.
Canada		This device contains licence-exempt transmitter(s)/receiver(s) that comply with Innovation, Science and Economic Development Canada's licence-exempt RSS(s). Operation is subject to the following two conditions: (1) This device may not cause interference. (2) This device must accept any interference, including interference that may cause undesired operation of the device. L'émetteur/récepteur exempt de licence contenu dans le présent appareil est conforme aux CNR d'Innovation, Sciences et Développement économique Canada applicables aux appareils radio exempts de licence. L'exploitation est autorisée aux deux conditions suivantes : 1) L'appareil ne doit pas produire de brouillage; 2) L'appareil doit accepter tout brouillage radioélectrique subi, même si le brouillage est susceptible d'en compromettre le fonctionnement.

Region	Labels and symbols	Specification
		<p>Tehniline informatsioon: Sagedusriba: 76 ... 77 GHz Edastusvõimsus: 23 dBm (keskmise) EIRP Tootja ja aadress: HELLA GmbH & Co. KGaA Rixbecker Straße 75, 59552 Lippstadt, Saksamaa</p> <p>Greek Με την παρούσα ο/η HELLA GmbH & Co. KGaA, δηλώνει ότι ο ραδιοεξοπλισμός RS5.5 πληροί την οδηγία 2014/53/ΕΕ. Το πλήρες κείμενο της δήλωσης συμμόρφωσης ΕΕ διατίθεται στην ακόλουθη ιστοσελίδα στο διαδίκτυο: www.hella.com/vcc Τεχνικές πληροφορίες: Ζώνη συχνότητας: 76 ... 77 GHz Ισχύς μετάδοσης: 23 dBm (μέση) EIRP Κατασκευαστής και Διεύθυνση: HELLA GmbH & Co KGaA Rixbecker Straße 75, 59552 Lippstadt, Γερμανία</p> <p>French Le soussigné, HELLA GmbH & Co. KGaA, déclare que l'équipement radioélectrique du type RS5.5 est conforme à la directive 2014/53/UE. Le texte complet de la déclaration UE de conformité est disponible à l'adresse internet suivante: www.hella.com/vcc Informations techniques: Bande de fréquence : 76 ... 77 GHz Puissance d'émission : 23 dBm (moyenne) EIRP Fabricant et adresse : HELLA GmbH & Co. KGaA Rixbecker Straße 75, 59552 Lippstadt, Allemagne</p> <p>Gaelic Leis seo, dearbhaíonn Hella GmbH & Co. KGaA go gcomhlíonnann an cineál trealaimh raidió RS5.5 Treoir 2014/53 / AE. Tá téacs iomlán dhearbú comhréireachta an AE ar fáil ag an seoladh idirlín seo a leanas: www.hella.com/vcc Gwybodaeth dechnegol: Band amledd: 76 ... 77 GHz Pŵer trosglwyddo: 23 dBm (cyfartaledd) EIRP Gwneuthurwr a Chyfeiriad: HELLA GmbH & Co. KGaA Rixbecker Straße 75, 59552 Lippstadt, yr Almaen</p> <p>Croatian HELLA GmbH & Co. KGaA ovime izjavljuje da je radijska oprema tipa RS5.5 u skladu s Direktivom 2014/53/EU. Cjeloviti tekst EU izjave o sukladnosti dostupan je na sljedećoj internetskoj adresi: www.hella.com/vcc Tehničke informacije: Frekvencijski pojas: 76 ... 77 GHz Snaga prijena: 23 dBm (prosječno) EIRP Proizvođač i adresa: HELLA GmbH & Co. KGaA Rixbecker Straße 75, 59552 Lippstadt, Njemačka</p> <p>Italian Il fabbricante, HELLA GmbH & Co. KGaA, dichiara che il tipo di apparecchiatura radio RS5.5 è conforme alla direttiva 2014/53/UE. Il testo completo della dichiarazione di conformità UE è disponibile al seguente indirizzo Internet: www.hella.com/vcc Informazioni tecniche: Banda di frequenza: 76 ... 77 GHz Potenza di trasmissione: 23 dBm (media) EIRP Produttore e indirizzo: HELLA GmbH & Co. KGaA Rixbecker Straße 75, 59552 Lippstadt, Germania</p> <p>Latvian Ar šo HELLA GmbH & Co. KGaA deklarē, ka radioiekārta RS5.5 atbilst Direktīvai 2014/53/ES Pilns ES atbilstības deklarācijas teksts ir pieejams šādā interneta vietnē: www.hella.com/vcc Tehniskā informācija: Frekvenču josla: 76 ... 77 GHz Raidīšanas jauda: 23 dBm (vidēji) EIRP Ražotājs un adrese: HELLA GmbH & Co. KGaA Rixbecker Straße 75, 59552 Lippstadt, Vācija</p> <p>Lithuanian Aš, HELLA GmbH & Co. KGaA, patvirtinu, kad radijo įrenginių tipas RS5.5 atitinka Direktyvą 2014/53/ES. Visas ES atitikties deklaracijos tekstas prieinamas šiuo interneto adresu: www.hella.com/vcc Technine informacija: Dažnių juosta: 76 ... 77 GHz Perdavimo galia: 23 dBm (vidutinis) EIRP Gamintojas ir adresas: HELLA GmbH & Co. KGaA Rixbecker Straße 75, 59552 Lippstadt, Vokietija</p> <p>Hungarian HELLA GmbH & Co. KGaA igazolja, hogy a RS5.5 típusú rádióberendezés megfelel a 2014/53/EU irányelvnek. Az EU-megfelelőségi nyilatkozat teljes szövege elérhető a következő internetes címen: www.hella.com/vcc Technikai információ: Frekvenciasáv: 76 ... 77 GHz Átviteli teljesítmény: 23 dBm (átlag) EIRP Gyártó és cím: HELLA GmbH & Co. KGaA Rixbecker Straße 75, 59552 Lippstadt, Németország</p> <p>Maltese B'dan, HELLA GmbH & Co. KGaA, niddikjara li dan it-tip ta' tagħmir tar-radju RS5.5 huwa konformi mad-Direttiva 2014/53/UE. It-test kollu tad-dikjarazzjoni ta' konformità tal-UE huwa disponibbli f'dan l-indirizz tal-Internet li ġej: www.hella.com/vcc Informazzjoni teknika: Faxxa tal-frekwenza: 76 ... 77 GHz</p>





Region	Labels and symbols	Specification
		<p>Qawwa tat-trażmissjoni: 23 dBm (medja) EIRP Manifattur u Indirizz: HELLA GmbH & Co KGaA Rixbecker Straße 75, 59552 Lippstadt, il-Ġermanja</p> <p>Dutch Hierbij verklaar ik, HELLA GmbH & Co. KGaA, dat het type radioapparatuur RS5.5 conform is met Richtlijn 2014/53/EU. De volledige tekst van de EU-conformiteitsverklaring kan worden geraadpleegd op het volgende internetadres: www.hella.com/vcc Technische informatie: Frequentieband: 76 ... 77 GHz Zendvermogen: 23 dBm (gemiddeld) EIRP Fabrikant en adres: HELLA GmbH & Co. KGaA Rixbecker Straße 75, 59552 Lippstadt, Duitsland</p> <p>Polish HELLA GmbH & Co. KGaA niniejszym oświadcza, że typ urządzenia radiowego RS5.5 jest zgodny z dyrektywą 2014/53/UE. Pełny tekst deklaracji zgodności UE jest dostępny pod następującym adresem internetowym: www.hella.com/vcc Specyfikacja: Pasma częstotliwości: 76...77 GHz Moc transmisji: 23 dBm (średnia) EIRP Producent i adres: HELLA GmbH & Co. KGaA Rixbecker Straße 75, 59552 Lippstadt, Niemcy</p> <p>Portuguese O(a) abaixo assinado(a) HELLA GmbH & Co. KGaA declara que o presente tipo de equipamento de rádio RS5.5 está em conformidade com a Diretiva 2014/53/UE. O texto integral da declaração de conformidade está disponível no seguinte endereço de Internet: www.hella.com/vcc Informação técnica: Banda de frequência: 76 ... 77 GHz Potência de transmissão: 23 dBm (média) EIRP Fabricante e Endereço: HELLA GmbH & Co. KGaA Rixbecker Straße 75, 59552 Lippstadt, Alemanha</p> <p>Romanian Prin prezenta, HELLA GmbH & Co. KGaA declară că tipul de echipamente radio RS5.5 este în conformitate cu Directiva 2014/53/UE. Textul integral al declarației UE de conformitate este disponibil la următoarea adresă de internet: www.hella.com/vcc Informații tehnice: Banda de frecvență: 76 ... 77 GHz Puterea de transmisie: 23 dBm (medie) EIRP Producător și adresa: HELLA GmbH & Co. KGaA Rixbecker Straße 75, 59552 Lippstadt, Germania</p> <p>Slovak HELLA GmbH & Co. KGaA týmto vyhlasuje, že rádiové zariadenie typu RS5.5 je v súlade so smernicou 2014/53/EÚ. Úplné EÚ vyhlásenie o zhode je k dispozícii na tejto internetovej adrese: www.hella.com/vcc Technická informácia: Frekvenčné pásmo: 76 ... 77 GHz Vysielací výkon: 23 dBm (priemer) EIRP Výrobca a adresa: HELLA GmbH & Co. KGaA Rixbecker Straße 75, 59552 Lippstadt, Nemecko</p> <p>Slovenian HELLA GmbH & Co. KGaA potrjuje, da je tip radijske opreme RS5.5 skladen z Direktivo 2014/53/EU. Celotno besedilo izjave EU o skladnosti je na voljo na naslednjem spletnem naslovu: www.hella.com/vcc Tehnične informacije: Frekvenčni pas: 76 ... 77 GHz Oddajna moč: 23 dBm (povprečje) EIRP Proizvajalec in naslov: HELLA GmbH & Co. KGaA Rixbecker Straße 75, 59552 Lippstadt, Nemčija</p> <p>Finnish HELLA GmbH & Co. KGaA vakuuttaa, että radiolaitetyypin RS5.5 on direktiivin 2014/53/EU mukainen. EU-vaatimustenmukaisuusvakuutuksen täysimittainen teksti on saatavilla seuraavassa internetosoitteessa: www.hella.com/vcc Tekninen informaatio: Taajuuskaista: 76 ... 77 GHz Lähetysteho: 23 dBm (keskimääräinen) EIRP Valmistaja ja osoite: HELLA GmbH & Co. KGaA Rixbecker Straße 75, 59552 Lippstadt, Saksa</p> <p>Swedish Härmed förklarar HELLA GmbH & Co. KGaA att radioutrustningen av typen RS5.5 överensstämmer med direktiv 2014/53/EU. Den fullständiga texten till EU-försäkran om överensstämmelse finns tillgänglig på följande internetadress: www.hella.com/vcc Teknisk information: Frekvensband: 76 ... 77 GHz Sändningseffekt: 23 dBm (medel) EIRP Tillverkare och adress: HELLA GmbH & Co. KGaA Rixbecker Straße 75, 59552 Lippstadt, Tyskland</p> <p>Turkish HELLA GmbH & Co. KGaA, işbu belgeyle RS5.5 tipi radyo ekipmanının 2014/53/AB sayılı direktife uygun olduğunu beyan eder.</p>

Region	Labels and symbols	Specification
		<p>AB uygunluk beyanının tam metni, aşağıdaki internet adresinde mevcuttur: www.hella.com/vcc</p> <p>Teknik Bilgiler: Frekans bandı: 76 ... 77 GHz İletim gücü: 23 dBm (ortalama) EIRP Üretici ve Adres: HELLA GmbH & Co. KGaA Rixbecker Straße 75, 59552 Lippstadt, Almanya</p> <p>Icelandic Hér með lýsir HELLA GmbH & Co. KGaA því yfir að útlarpsbúnaður af gerðinni RS5.5 sé í samræmi við tilskipun 2014/53/ESB. Heildartexti ESB-samræmisýfirlýsingarinnar er fáanlegur á eftirfarandi netfangi: www.hella.com/vcc Tæknilegar upplýsingar: Tíðnisvið: 76 ... 77 GHz Sendingarkraftur: 23 dBm (meðaltal) EIRP Framleiðandi og heimilisfang: Hella GmbH & Co. KGaA Rixbecker Straße 75, 59552 Lippstadt, Þýskaland</p> <p>Norwegian HELLA GmbH & Co. KGaA erklærer herved at radioutstyret av typen RS5.5 samsvarer med direktiv 2014/53/EU. Den fullstendige teksten til EU-samsvarserklæringen er tilgjengelig på følgende internetadresse: www.hella.com/vcc Teknisk informasjon: Frekvensbånd: 76 ... 77 GHz Overføringsytelse: 23 dBm (gjennomsnittlig) EIRP Produsent og adresse: Hella GmbH & Co. KGaA Rixbecker Straße 75, 59552 Lippstadt, Tyskland</p> <p>Serbian Ovim putem HELLA GmbH & Co. KGaA izjavljuje da je radio-oprema tipa RS5.5 usklađena sa Uredbom 2014/53/EU. Kompletan tekst EU Deklaracije o usaglašenosti dostupan je na sledećoj internet adresi: www.hella.com/vcc Tehničke informacije: Frekvencijski opseg: 76 ... 77 GHz Snaga prenosa: 23 dBm (prosečno) EIRP Proizvođač i adresa: HELLA GmbH & Co. KGaA Rixbecker Straße 75, 59552 Lippstadt, Nemačka</p> <p>Albanian Me anë të kësaj, Hella GmbH & Co. KGaA deklaron se pajisjet e radios tip RS5.5 janë në përputhje me Direktivën 2014/53 / EU. Teksti i plotë i deklaratës së konformitetit të BE është në dispozicion në adresën e mëposhtme të internetit: www.hella.com/vcc Informacion teknik: Fasha e frekuencës: 76 ... 77 GHz Fuqia e transmetimit: 23 dBm (mesatare) EIRP Prodhuesi dhe Adresa: Hella GmbH & Co. KGaA Rixbecker Straße 75, 59552 Lippstadt, Gjermani</p> <p>Bosnian Ovime kompanija Hella GmbH & Co. KGaA izjavljuje da je radijska oprema tipa RS5.5 u skladu s Direktivom 2014/53/EU. Puni tekst EU Izjave o sukladnosti dostupan je na sljedećoj internet adresi: www.hella.com/vcc Tehničke informacije: Raspon frekvencije: 76 ... 77 GHz Snaga prijensa: 23 dBm (prosječno) EIRP (efektivna izotropna snaga zračenja) Proizvođač i adresa: Hella GmbH & Co. KGaA Rixbecker Straße 75, 59552 Lippstadt, Njemačka</p> <p>Macedonian Со ова Hella GmbH & Co. KGaA декларира дека радиоопремата од тип RS5.5 е во согласност со Директивата 2014/53/EU. Целосниот текст на декларацијата за сообразност на ЕУ е достапна на следната интернет-адреса: www.hella.com/vcc Технички информации: Појас на фреквенција: 76 ... 77 GHz Моќност на трансмисија: 23 dBm (просечна) EIRP Производител и адреса: Hella GmbH & Co. KGaA Rixbecker Straße 75, 59552 Lippstadt, Германија</p>
Ghana		NCA Approved: 7E5-7M-151-RDR

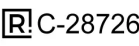





Region	Labels and symbols	Specification
United States of America		This device complies with Part 95M of the FCC Rules. Operation is subject to the following two conditions: (1) this device may not cause harmful interference, and (2) this device must accept any interference received, including interference that may cause undesired operation. CAUTION TO USERS Changes or modifications not expressly approved by the party responsible for compliance could void the user's authority to operate the equipment.
Vietnam		
Zambia		



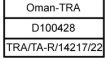
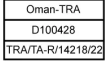
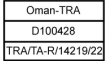
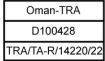

Radars for detecting foot movement below the rear bumper

Region	Labels and symbols	Specification
Argentina		C-28726
Canada/ FCC (US)		<p>Contains FCC ID: 2AQ6KA1003</p> <p>FCC Part15 and ISSED(IC) This device complies with part 15 of FCC Rules and Innovation, Science and Economic Development Canada's licence-exempt RSS(s). Operation is subject to the following two conditions: (1) this device may not cause harmful interference, and (2) this device must accept any interference received, including interference that may cause undesired operation.</p> <p>FCC Part15 FCC CAUTION Changes or modifications not expressly approved by the party responsible for compliance could void the user's authority to operate the equipment.</p> <p>FCC Part15 This transmitter must not be co-located or operated in conjunction with any other antenna or transmitter.</p> <p>SAR Specific Absorption Rate This equipment complies with radio frequency exposure limits set forth by the FCC and Industry Canada for an uncontrolled environment. This equipment should be installed and operated with a minimum distance of 20 cm between the device and the user or bystanders. This device must not be co-located or operating in conjunction with any other antenna or transmitter.</p> <p>Le présent appareil est conforme à la partie 15 des règles de la FCC et aux normes des CNR d'Innovation, Sciences et Développement économique Canada applicables aux appareils radio exempts de licence. L'exploitation est autorisée aux deux conditions suivantes: (1) l'appareil ne doit pas produire de brouillage, et (2) l'appareil doit accepter tout brouillage subi, même si le brouillage est susceptible d'en compromettre le fonctionnement.</p> <p>Cet équipement est conforme aux limites d'exposition aux radiofréquences définies par la FCC et Industrie Canada pour un environnement non contrôlé. Cet équipement doit être installé et utilisé avec un minimum de 20 cm de distance entre le dispositif et l'utilisateur ou des tiers. Ce dispositif ne doit pas être utilisé à proximité d'une autre antenne ou d'un autre émetteur.</p>
CE		<p>Manufacturer's name & Manufacturer's registered trade name or registered trade mark: ALPS ALPINE CO., LTD.</p> <p>Manufacturer's postal address:6-3-36, Nakazato, Furukawa, Osaki-city, Miyagi-pref., JAPAN 989-6181.</p> <p>Specification: frequency band(s) in which the radio equipment operates; 57 - 64GHz maximum radio-frequency power transmitted in the frequency band(s) in which the radio equipment operates; 13dBm e.i.r.p peak (This Value conforms to European standard ETSI EN 305 550 measurement method).</p> <p>Declaration of conformity: UK SIMPLIFIED EU DECLARATION OF CONFORMITY. Hereby, ALPS ALPINE CO., LTD. declares that the radio equipment type B2101 is in compliance with the relevant statutory requirements. The full text of the UK declaration of conformity is available at the following internet address: https://www.alpsalpine.com/common/pdf/Kick_Sensor/B2101.pdf</p>
China		<p>20mW(e.i.r.p) 24-24.5GHz ECM</p> <p>ISM</p> <p>5000</p> <p>-40 85 16</p>

Region	Labels and symbols	Specification
Albania, Andorra, Austria, Belgium, Bolivia, Bosnia and Herzegovina, Bulgaria, Canary Islands, Croatia, Cyprus, Czech Republic, Denmark, Egypt, Estonia, Finland, France, Georgia, Germany, Greece, Grenada, Honduras, Hungary, Iceland, Ireland, Italy, Latvia, Libya, Liechtenstein, Lithuania, Luxembourg, Macedonia, Malta, Mauritius, Monaco, Montenegro, Netherlands, Norway, Poland, Portugal, Romania, San Marino, Slovakia, Slovenia, Spain, Sweden, Switzerland, Turkey, Zimbabwe		<p>frequency band(s) in which the radio equipment operates; 57-64GHz maximum radio-frequency power transmitted in the frequency band(s) in which the radio equipment operates; 13dBm e.i.r.p peak (this value conforms to European standard ETSI EN 305 550 measurement method)</p> <p>Simplified EU declaration of conformity</p> <p>OHC2101 ALPS ALPINE CO., LTD. hereby declares that the radio equipment type OHC2101 is in compliance with Directive 2014/53/EU. The full text of the EU declaration of conformity is available at the following internet address: https://www.alpsalpine.com/common/pdf/Interior_Sensor/OHC2101.pdf</p> <p>OHLC2101 ALPS ALPINE CO., LTD. hereby declares that the radio equipment type OHLC2101 is in compliance with Directive 2014/53/EU. The full text of the EU declaration of conformity is available at the following internet address: https://www.alpsalpine.com/common/pdf/Interior_Sensor/OHLC2101.pdf</p> <p>OHRL2101 ALPS ALPINE CO., LTD. hereby declares that the radio equipment type OHRL2101 is in compliance with Directive 2014/53/EU. The full text of the EU declaration of conformity is available at the following internet address: https://www.alpsalpine.com/common/pdf/Interior_Sensor/OHRL2101.pdf</p> <p>OHRR2101 ALPS ALPINE CO., LTD. hereby declares that the radio equipment type OHRR2101 is in compliance with Directive 2014/53/EU. The full text of the EU declaration of conformity is available at the following internet address: https://www.alpsalpine.com/common/pdf/Interior_Sensor/OHRR2101.pdf</p>
Argentina	<p> C-28730</p> <p>OHC2101</p> <p> C-28727</p> <p>OHLC2101</p> <p> C-28729</p> <p>OHRL2101</p> <p> C-28728</p> <p>OHRR2101</p>	
Brazil		<p>"Este equipamento não tem direito à proteção contra interferência prejudicial e não pode causar interferência em sistemas devidamente autorizados". Para consultas, visite: www.anatel.gov.br</p>
Canada, Guyana, Puerto Rico, United States		<p>Contains FCC ID: 2AQ6KA1003</p> <p>FCC Part15 and ISSED(C) This device complies with part 15 of FCC Rules and Innovation, Science and Economic Development Canada's licence-exempt RSS(s). Operation is subject to the following two conditions: (1) this device may not cause harmful interference, and (2) this device must accept any interference received, including interference that may cause undesired operation.</p> <p>FCC Part15 FCC CAUTION Changes or modifications not expressly approved by the party responsible for compliance could void the user's authority to operate the equipment.</p> <p>FCC Part15 This transmitter must not be co-located or operated in conjunction with any other antenna or transmitter.</p> <p>SAR: Specific Absorption Rate This equipment complies with radio frequency exposure limits set forth by the FCC and Industry Canada for an uncontrolled environment. This equipment should be installed and operated with a minimum distance of 20 cm between the device and the user or bystanders. This device must not be co-located or operating in conjunction with any other antenna or transmitter.</p> <p>Le présent appareil est conforme à la partie 15 des règles de la FCC et aux normes des CNR d'Innovation, Sciences et Développement économique Canada applicables aux appareils radio exempts de licence. L'exploitation est autorisée aux deux conditions suivantes : (1) l'appareil ne doit pas produire de brouillage, et (2) l'appareil doit accepter tout brouillage subi, même si le brouillage est susceptible d'en compromettre le fonctionnement.</p> <p>Cet équipement est conforme aux limites d'exposition aux radiofréquences définies par la FCC et Industrie Canada pour un environnement non contrôlé. Cet équipement doit être installé et utilisé avec un minimum de 20 cm de distance entre le dispositif et l'utilisateur ou des tiers. Ce dispositif ne doit pas être utilisé à proximité d'une autre antenne ou d'un autre émetteur.</p>

Region	Labels and symbols	Specification
Ghana		<p>frequency band(s) in which the radio equipment operates; 57-64GHz maximum radio-frequency power transmitted in the frequency band(s) in which the radio equipment operates; 13dBm e.i.r.p peak (this value conforms to European standard ETSI EN 305 550 measurement method)</p> <p>Certification number</p> <p>OHC2101 NCA APPROVED:7M-7E7-X33-DSR OHLC2101 NCA APPROVED: 7M-7E7-X31-DSR OHRL2101 NCA APPROVED: HS-7E7-X2F-DSR OHRR2101 NCA APPROVED: 7M-7E7-X2D-DSR</p>
Israel		<p>סימולציה – "שירותי תח"ם" התקנתו של התקן זה חייבת להיות כוללת את כל המידע המפורט להלן. אין להשתמש בהתקן זה לשימוש אחר מזה המיועד. כל שינוי או התאמה לפרטים אלו עלולה לגרום לנזק לתקשורת. סימולציה – שירותי תח"ם</p>
Kazakhstan, Kyrgyzstan		<p>Frequency band ; 57-64GHz, Operating Power Supply voltage: 9 V to 16 V OHC2101, OHLC2101, OHRL2101, OHRR2101 ООО<<СТАНДА СЕРТ>></p> <p>Место нахождения РА, г. Ереван, Аван, Нарекаци 42/45 номер государственной регистрации 282.110.1052305 УНН 00918006 номер телефона +37493306330</p>
Malaysia	 MCMC MTSFB TC T007:2020 OHC2101, OHLC2101, OHRL2101, OHRR2101	
Mexico		<p>'IFT:VOALOH22-25083 La operación de este equipo está sujeta a las siguientes dos condiciones: (1) es posible que este equipo o dispositivo no cause interferencia perjudicial y (2) este equipo o dispositivo debe aceptar cualquier interferencia, incluyendo la que pueda causar su operación no deseada.</p>

Region	Labels and symbols	Specification
Moldova		<p>frequency band(s) in which the radio equipment operates; 57-64GHz maximum radio-frequency power transmitted in the frequency band(s) in which the radio equipment operates; 13dBm e.i.r.p peak (this value conforms to European standard ETSI EN 305 550 measurement method)</p> <p>Simplified Moldova declaration of conformity</p> <p>OHC2101 Prin prezenta, ALPS ALPINE CO., LTD. declară că tipul de echipamente radio OHC2101 este în conformitate cu Reglementarea tehnică „Punerea la dispoziție pe piață a echipamentelor radio”. Textul integral al declarației de conformitate este disponibil la următoarea adresă de Internet: https://www.alpsalpine.com/common/pdf/Interior_Sensor/OHC2101.pdf [https://www.alpsalpine.com/common/pdf/Interior_Sensor/OHC2101.pdf]</p> <p>OHLC2101 Prin prezenta, ALPS ALPINE CO., LTD. declară că tipul de echipamente radio OHLC2101 este în conformitate cu Reglementarea tehnică „Punerea la dispoziție pe piață a echipamentelor radio”. Textul integral al declarației de conformitate este disponibil la următoarea adresă de Internet: https://www.alpsalpine.com/common/pdf/Interior_Sensor/OHLC2101.pdf [https://www.alpsalpine.com/common/pdf/Interior_Sensor/OHLC2101.pdf]</p> <p>OHRL2101 Prin prezenta, ALPS ALPINE CO., LTD. declară că tipul de echipamente radio OHRL2101 este în conformitate cu Reglementarea tehnică „Punerea la dispoziție pe piață a echipamentelor radio”. Textul integral al declarației de conformitate este disponibil la următoarea adresă de Internet: https://www.alpsalpine.com/common/pdf/Interior_Sensor/OHRL2101.pdf [https://www.alpsalpine.com/common/pdf/Interior_Sensor/OHRL2101.pdf]</p> <p>OHRR2101 Prin prezenta, ALPS ALPINE CO., LTD. declară că tipul de echipamente radio OHRR2101 este în conformitate cu Reglementarea tehnică „Punerea la dispoziție pe piață a echipamentelor radio”. Textul integral al declarației de conformitate este disponibil la următoarea adresă de Internet: https://www.alpsalpine.com/common/pdf/Interior_Sensor/OHRR2101.pdf [https://www.alpsalpine.com/common/pdf/Interior_Sensor/OHRR2101.pdf]</p>
Oman	 <p>OHC2101</p>  <p>OHLC2101</p>  <p>OHRL2101</p>  <p>OHRR2101</p>	
Paraguay	 <p>OHC2101</p>  <p>OHLC2101</p>  <p>OHRL2101</p>  <p>OHRR2101</p>	
Serbia		

Region	Labels and symbols	Specification
United Kingdom		<p>frequency band(s) in which the radio equipment operates; 57-64GHz maximum radio-frequency power transmitted in the frequency band(s) in which the radio equipment operates; 13dBm e.i.r.p peak (this value conforms to European standard ETSI EN 305 550 measurement method)</p> <p>UK Simplified declaration of conformity</p> <p>OHC2101 Hereby, ALPS ALPINE CO., LTD. declares that the radio equipment type OHC2101 is in compliance with the relevant statutory requirements. The full text of the UK declaration of conformity is available at the following internet address: https://www.alpsalpine.com/common/pdf/Interior_Sensor/OHC2101.pdf [https://www.alpsalpine.com/common/pdf/Interior_Sensor/OHC2101.pdf]</p> <p>OHLC2101 Hereby, ALPS ALPINE CO., LTD. declares that the radio equipment type OHLC2101 is in compliance with the relevant statutory requirements. The full text of the UK declaration of conformity is available at the following internet address: https://www.alpsalpine.com/common/pdf/Interior_Sensor/OHLC2101.pdf [https://www.alpsalpine.com/common/pdf/Interior_Sensor/OHLC2101.pdf]</p> <p>OHRL2101 Hereby, ALPS ALPINE CO., LTD. declares that the radio equipment type OHRL2101 is in compliance with the relevant statutory requirements. The full text of the UK declaration of conformity is available at the following internet address: https://www.alpsalpine.com/common/pdf/Interior_Sensor/OHRL2101.pdf [https://www.alpsalpine.com/common/pdf/Interior_Sensor/OHRL2101.pdf]</p> <p>OHRR2101 Hereby, ALPS ALPINE CO., LTD. declares that the radio equipment type OHRR2101 is in compliance with the relevant statutory requirements. The full text of the UK declaration of conformity is available at the following internet address: https://www.alpsalpine.com/common/pdf/Interior_Sensor/OHRR2101.pdf [https://www.alpsalpine.com/common/pdf/Interior_Sensor/OHRR2101.pdf]</p>
Vietnam	 <p>OHC2101, OHLC2101, OHRL2101, OHRR2101</p>	
Zambia	 <p>OHC2101</p>  <p>OHLC2101</p>  <p>OHRL2101</p>  <p>OHRR2101</p>	

15.5.4. Type approvals for Telematic Connectivity Antenna Module

Find the type approvals for the Telematic Connectivity Antenna Module^[1] listed here.

Manufacturer

Harman Becker Automotive Systems GmbH

Becker-Goering-Strasse 16

The content of this manual represents the status of the user manual at the time of printing and may not be completely valid in future instances. For more information refer to the first page for the complete disclaimer note.

76307 Karlsbad

Germany

Local importer (UK)

Volvo Cars UK Limited

Scandinavia House, Morrey's Drive

Maidenhead SL6 4FL

United Kingdom

Local representative (UK)

Harman International Industries Inc.

26-27 London's St. Vita Basingstoke RG21 7PG

United Kingdom

European Union: Declaration of Conformity ^[2]

Frequency band(s) in which the radio equipment operates:

RF Interface	Transmission Frequency Bands (MHz)	Reception Frequency Bands (MHz)
GSM900	880-915	925-960
GSM1800	1710-1785	1805-1880
WCDMA band I	1920-1980	2110-2170
WCDMA band III	1710-1785	1805-1880
WCDMA band VIII	880-915	925-960
LTE FDD band 1	1920-1980	2110-2170
LTE FDD band 3	1710-1785	1805-1880
LTE FDD band 7	2500-2570	2620-2690
LTE FDD band 8	880-915	925-960
LTE FDD band 20	832-862	791-821
LTE FDD band 28	703-748	758-803
LTE FDD band 32 (Rx)	-	1452-1496
LTE TDD band 34	2010-2025	2010-2025
LTE TDD band 38	2570-2620	2570-2620
LTE TDD band 40	2300-2400	2300-2400
LTE TDD band 42	3400-3600	3400-3600
5G NR n1	1920-1980	2110-2170
5G NR n3	1710-1785	1805-1880
5G NR n7	2500-2570	2620-2690
5G NR n8	880-915	925-960

The content of this manual represents the status of the user manual at the time of printing and may not be completely valid in future instances. For more information refer to the first page for the complete disclaimer note.

RF Interface	Transmission Frequency Bands (MHz)	Reception Frequency Bands (MHz)
5G NR n20	832-862	791-821
5G NR n28	703-748	758-803
5G NR n38	2570-2620	2570-2620
5G NR n41	2496-2690 (restricted to 2570-2620 MHz)	2496-2690 (restricted to 2570-2620 MHz)
5G NR n77	3300-4200 (restricted to 3400-3800MHz)	3300-4200 (restricted to 3400-3800MHz)
5G NR n78	3300-3800 (restricted to 3400-3800 MHz)	3300-3800 (restricted to 3400-3800 MHz)
Bluetooth	2400-2483.5	2400-2483.5
GNSS (Rx)	-	1559-1610
ISM (Rx)	-	433.05-434.79

Maximum radio-frequency power transmitted in the frequency band(s) in which the radio equipment operates.

Bluetooth LE RF Transmitter Output Power: <5 dBm

NAD Module RF Transmitter Output Power:

GSM:

Class 4 (+33 dBm ± 2 dB) for EGSM 900

Class 1 (+30 dBm ± 2 dB) for GSM 1800

Class E2 (+27 dBm ± 3 dB) for GSM 900 8-PSK





Class E2 (+26 dBm +3/-4 dB) for GSM 1800 8-PSK

UMTS: Class 3 (+24 dBm +1/-3 dB)

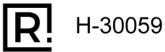

LTE: Class 3 (+23 dBm ± 2 dB)



5G: Class 3 (+23 dBm +2/-3 dB) ^[3]













Telematic Connectivity Antenna Module (TCAM2)

Region(s)	Labels	Specifications
Argentina	 H-30059	H-30059
Australia, New Zealand		R-NZ
Botswana		BOCRA/TA/2023/9085
Brazil		<p>05732-24-07978</p> <p>Este produto está homologado pela ANATEL de acordo com os procedimentos regulamentados para avaliação da conformidade de produtos para telecomunicações e atende aos requisitos técnicos aplicados, incluindo os limites de exposição da Taxa de Absorção Específica referente a campos elétricos, magnéticos e eletromagnéticos de radiofrequência. O máximo valor medido da Taxa de Absorção Específica referente à exposição localizada na cabeça foi de 0,786 W/kg. Para maiores informações, consulte o site da ANATEL – www.anatel.gov.br</p> <p>Products subject to Resolution 680/2017:</p> <p>Este equipamento não tem direito à proteção contra interferência prejudicial e não pode causar interferência em sistemas devidamente autorizados</p> <p>Marcações do Ato 4084 (Act 4084 Marking)</p> <p>Produtos para consumidor final:</p> <p>Para maiores informações, consulte o site da ANATEL – www.anatel.gov.br</p>

Region(s)	Labels	Specifications
Canada		<p>FCC/ISED statements</p> <p>Model: TCAM2 IC: 6434A-TCAM2 Contains IC: 6434A-SAN9200</p> <p>This device complies with part 15 of the FCC Rules and Industry Canada license-exempt RSS standard(s). Operation is subject to the following two conditions:</p> <p>(1) This device may not cause harmful interference, and (2) This device must accept any interference received, including interference that may cause undesired operation.</p> <p>Le présent appareil est conforme aux CNR d'Industrie Canada applicables aux appareils radio exempts de licence. L'exploitation est autorisée aux deux conditions suivantes :</p> <p>(1) l'appareil ne doit pas produire de brouillage, et (2) l'utilisateur de l'appareil doit accepter tout brouillage radioélectrique subi, même si le brouillage est susceptible d'en compromettre le fonctionnement.</p> <p>Modification statement:</p> <p>The party responsible for the compliance has not approved any changes or modifications to this device by the user. Any changes or modifications could void the user's authority to operate the equipment.</p> <p>Le responsable de l'homologation de ce produit n'approuve aucune modification apportée à l'appareil par l'utilisateur, quelle qu'en soit la nature. Tout changement ou modification peuvent annuler le droit d'utilisation de l'appareil par l'utilisateur.</p> <p>Wireless notice:</p> <p>This device complies with FCC/ISED radiation exposure limits set forth for an uncontrolled environment and meets the FCC radio frequency (RF) Exposure Guidelines and RSS-102 of the ISED radio frequency (RF) Exposure rules. This transmitter must not be co-located or operating in conjunction with any other antenna or transmitter. The closer distance between the Cellular internal antennas and the head of the closest passenger will be 86.5 mm and the minimum distance between the BTLE internal antenna and the head of the closest passenger will be 118.0 mm. The device has been tested placed at the centre of the flat phantom with its back side facing the flat phantom surface simulating the normal use conditions at a conservative testing distance of 40 mm according to manufacturer request.</p> <p>Le présent appareil est conforme à l'exposition aux radiations FCC / ISED définies pour un environnement non contrôlé et répond aux directives d'exposition de la fréquence de la FCC radiofréquence (RF) et RSS-102 de la fréquence radio (RF) ISED règles d'exposition. L'émetteur ne doit pas être colocalisé ni fonctionner conjointement avec à autre antenne ou autre émetteur. La distance la plus courte entre les antennes internes cellulaires et la tête du passager le plus proche sera de 86,5 mm et la distance minimale entre l'antenne interne BTLE et la tête du passager le plus proche sera de 118,0 mm. Le dispositif a été testé au centre du fantôme plat, sa face arrière faisant face à la surface du fantôme plat, simulant les conditions d'utilisation normales à une distance d'essai prudente de 40 mm, conformément à la demande du fabricant.</p> <p>Compliance of host devices based on modular approval</p> <p>The module has been evaluated in mobile stand-alone conditions: "The antenna used for this transmitter must be installed to provide a separation distance of at least 20 cm from all persons and must not be co-located or operating in conjunction with any other antenna or transmitter." Since the module is intended for use in a portable device () and co-located with other transmitter (Bluetooth), additional testing is performed to satisfy the SAR requirements of FCC Part 2.1093 (RF Co-location and SAR).</p> <p>Le module a été évalué dans des conditions d'autonomie mobile : "L'antenne utilisée pour cet émetteur doit être installée de manière à assurer une distance de séparation d'au moins 20 cm de toutes les personnes et ne doit pas être installée ou fonctionner en conjonction avec une autre antenne ou un autre émetteur. Étant donné que le module est destiné à être utilisé dans un appareil portable () et qu'il est situé au même endroit qu'un autre émetteur (Bluetooth), des tests supplémentaires sont effectués pour satisfaire aux exigences SAR de la partie 2.1093 de la FCC (Co-localisation RF et SAR).</p> <p>CAN ICES-3 (B) / NMB-3 (B)</p> <p>This Class B digital apparatus complies with Canadian ICES-003. Cet appareil numérique de classe B est conforme à la norme canadienne ICES-003.</p> <p>FCC Class B digital device notice</p> <p>This equipment has been tested and found to comply with the limits for a Class B digital device, pursuant to part 15 of the FCC Rules. These limits are designed to provide reasonable protection against harmful interference in a residential installation. This equipment generates, uses and can radiate radio frequency energy and may cause harmful interference to radio communications if not installed and used in accordance with the instructions. However, there is no guarantee that interference will not occur in a particular installation. If this equipment does cause harmful interference to radio or television reception, which can be determined by turning the equipment off and on, the user is encouraged to try to correct the interference by one or more of the following measures:</p> <ul style="list-style-type: none"> - Reorient or relocate the receiving antenna. - Increase the separation between the equipment and receiver. - Connect the equipment to an outlet on a circuit different from that to which the receiver is connected. - Consult the retailer or an experienced radio/TV technician for help.
China		<p>CMIIT ID: 2023CJ18966 RTM: Real-Time Monitoring 3.0</p>

Region(s)	Labels	Specifications
		
Costa Rica		00094-2024
European Union & EFTA		<p>English Hereby, Harman Becker Automotive Systems GmbH declares that the radio equipment type Telematics Connectivity Antenna Module is in compliance with Directive 2014/53/EU. The full text of the EU declaration of conformity is available at the following internet Address: http://www.harman.com/compliance</p> <p>Bulgarian С настоящото Harman Becker Automotive Systems GmbH декларира, че този тип радиосъоръжение Telematics Connectivity Antenna Module е в съответствие с Директива 2014/53/ЕС. Цялостният текст на ЕС декларацията за съответствие може да се намери на следния интернет адрес: http://www.harman.com/compliance</p> <p>Croatian Harman Becker Automotive Systems GmbH ovime izjavljuje da je radijska oprema tipa Telematics Connectivity Antenna Module u skladu s Direktivom 2014/53/EU. Cjeloviti tekst EU izjave o sukladnosti dostupan je na sljedećoj internetskoj adresi: http://www.harman.com/compliance</p> <p>Czech Tímto Harman Becker Automotive Systems GmbH prohlašuje, že typ rádiového zařízení Telematics Connectivity Antenna Module je v souladu se směrnicí 2014/53/EU. Úplné znění EU prohlášení o shodě je k dispozici na této internetové adrese: http://www.harman.com/compliance</p> <p>Danish Hermed erklærer Harman Becker Automotive Systems GmbH, at radioudstyrstypen Telematics Connectivity Antenna Module er i overensstemmelse med direktiv 2014/53/EU. EU-overensstemmelseserklæringens fulde tekst kan findes på følgende internetadresse: http://www.harman.com/compliance</p> <p>Dutch Hierbij verklaar ik, Harman Becker Automotive Systems GmbH, dat het type radioapparatuur Telematics Connectivity Antenna Module conform is met Richtlijn 2014/53/EU. De volledige tekst van de EU-conformiteitsverklaring kan worden geraadpleegd op het volgende internetadres: http://www.harman.com/compliance</p> <p>Estonian Käesolevaga deklareerib Harman Becker Automotive Systems GmbH, et käesolev raadioseadme tüüp Telematics Connectivity Antenna Module vastab direktiivi 2014/53/EL nõuetele. ELi vastavusdeklaratsiooni täielik tekst on kättesaadav järgmisel internetiaadressil: http://www.harman.com/compliance</p> <p>Finnish Harman Becker Automotive Systems GmbH vakuuttaa, että radiolaitetyyppi Telematics Connectivity Antenna Module on direktiivin 2014/53/EU mukainen. EU-vaatimustenmukaisuusvakuutuksen täysimittainen teksti on saatavilla seuraavassa internetosoitteessa: http://www.harman.com/compliance</p> <p>French Le soussigné, Harman Becker Automotive Systems GmbH, déclare que l'équipement radioélectrique du type Telematics Connectivity Antenna Module est conforme à la directive 2014/53/UE. Le texte complet de la déclaration UE de conformité est disponible à l'adresse internet suivante: http://www.harman.com/compliance Avertissement: a compter du 1er juillet 2020, conformément au « Décret n°2019-1186 relatif à l'affichage du Débit d'Absorption Spécifique des équipements radio » (NOR : SSAP1834791D), la valeur du débit d'absorption spécifique (DAS) pour tout équipement radio dont le rendement est supérieur à 20 mW et qui est susceptible d'être utilisé de manière raisonnablement prévisible à proximité de la tête ou à une distance inférieure ou égale à 20 cm du corps humain doit être fourni de manière lisible, intelligible et visible dans le manuel d'utilisation. L'exigence n'est actuellement applicable qu'aux appareils de téléphonie mobile, conformément au « Décret n° 2010-1207 relatif à l'affichage du débit d'absorption spécifique des équipements terminaux radio (NOR : SASP1011528D).</p> <p>German Hiermit erklärt Harman Becker Automotive Systems GmbH, dass das Gerät mit Funkfunktion Telematics Connectivity Antenna Module der Richtlinie 2014/53/EU entspricht. Der vollständige Text der EU-Konformitätserklärung ist unter der folgenden Internetadresse verfügbar: http://www.harman.com/compliance</p> <p>Greek Με την παρούσα ο/η Harman Becker Automotive Systems GmbH, δηλώνει ότι ο ραδιοεξοπλισμός Telematics Connectivity Antenna Module πληροί την οδηγία 2014/53/ΕΕ. Το πλήρες κείμενο της δήλωσης συμμόρφωσης ΕΕ διατίθεται στην ακόλουθη ιστοσελίδα στο διαδικτυο: http://www.harman.com/compliance</p> <p>Hungarian Harman Becker Automotive Systems GmbH igazolja, hogy a Telematics Connectivity Antenna Module típusú rádióberendezés megfelel a 2014/53/EU irányelvnek. Az EU-megfelelőségi nyilatkozat teljes szövege elérhető a következő internetes címen: 2014.5.22. L 153/104 Az Európai Unió Hivatalos Lapja HU: http://www.harman.com/compliance</p> <p>Italian</p>

Region(s)	Labels	Specifications
		<p>Il fabbricante, Harman Becker Automotive Systems GmbH, dichiara che il tipo di apparecchiatura radio Telematics Connectivity Antenna Module è conforme alla direttiva 2014/53/UE. Il testo completo della dichiarazione di conformità UE è disponibile al seguente indirizzo Internet: http://www.harman.com/compliance</p> <p>Latvian Ar šo Harman Becker Automotive Systems GmbH deklarē, ka radioiekārta Telematics Connectivity Antenna Module atbilst Direktīvai 2014/53/ES. Pilns ES atbilstības deklarācijas teksts ir pieejams šādā interneta vietnē: http://www.harman.com/compliance</p> <p>Lithuanian Aš, Harman Becker Automotive Systems GmbH, patvirtinu, kad radijo įrenginių tipas Telematics Connectivity Antenna Module atitinka Direktyvą 2014/53/ES. Visas ES atitikties deklaracijos tekstas prieinamas šiuo interneto adresu: http://www.harman.com/compliance</p> <p>Maltese B'dan, Harman Becker Automotive Systems GmbH, niddikjara li dan it-tip ta' tagħmir tar-radju Telematics Connectivity Antenna Module huwa konformi mad-Direttiva 2014/53/UE. It-test kollu tad-dikjarazzjoni ta' konformità ta-UE huwa disponibbli f'dan l-indirizz ta-Internet li ġej: http://www.harman.com/compliance</p> <p>Polish Harman Becker Automotive Systems GmbH niniejszym oświadcza, że typ urządzenia radiowego Telematics Connectivity Antenna Module jest zgodny z dyrektywą 2014/53/UE. Pełny tekst deklaracji zgodności UE jest dostępny pod następującym adresem internetowym: http://www.harman.com/compliance</p> <p>Portuguese O(a) abaixo assinado(a) Harman Becker Automotive Systems GmbH declara que o presente tipo de equipamento de rádio Telematics Connectivity Antenna Module está em conformidade com a Diretiva 2014/53/UE. O texto integral da declaração de conformidade está disponível no seguinte endereço de Internet: http://www.harman.com/compliance</p> <p>Romanian Prin prezenta, Harman Becker Automotive Systems GmbH declară că tipul de echipamente radio Telematics Connectivity Antenna Module este în conformitate cu Directiva 2014/53/UE. Textul integral al declarației UE de conformitate este disponibil la următoarea adresă internet: http://www.harman.com/compliance</p> <p>Slovak Harman Becker Automotive Systems GmbH týmto vyhlasuje, že rádiové zariadenie typu Telematics Connectivity Antenna Module je v súlade so smernicou 2014/53/EÚ. Úplné EÚ vyhlásenie o zhode je k dispozícii na tejto internetovej adrese: http://www.harman.com/compliance</p> <p>Slovenian Harman Becker Automotive Systems GmbH potrjuje, da je tip radijske opreme Telematics Connectivity Antenna Module skladen z Direktivo 2014/53/EU. Celotno besedilo izjave EU o skladnosti je na voljo na naslednjem spletnem naslovu: http://www.harman.com/compliance</p> <p>Spanish Por la presente, Harman Becker Automotive Systems GmbH declara que el tipo de equipo radioeléctrico Telematics Connectivity Antenna Module es conforme con la Directiva 2014/53/UE. El texto completo de la declaración UE de conformidad está disponible en la dirección Internet siguiente: http://www.harman.com/compliance</p> <p>Swedish Härmed försäkras Harman Becker Automotive Systems GmbH att denna typ av radioutrustning Telematics Connectivity Antenna Module överensstämmer med direktiv 2014/53/EU. Den fullständiga texten till EUförsäkran om överensstämmelse finns på följande webbadress: http://www.harman.com/compliance</p> <p>Turkish Harman Becker Automotive Systems GmbH işbu, radyo işlevli CONBOX-HIGH cihazı 2014/53 / ABDirektifi ile uyumlu olduğunu beyan eder. AB-uygunluk beyanını tam metnisi aşağıdaki İnternet adresinde mevcuttur: http://www.harman.com/compliance</p>
Indonesia	  <p>Dilarang melakukan perubahan spesifikasi yang dapat menimbulkan gangguan fisik dan/atau elektromagnetik terhadap lingkungan sekitarnya</p>	<p>100947/SDPPI/2024 13809</p>

Region(s)	Labels	Specifications
Israel		מספר אישור אלחוטית של משרד התקשורת הוא 11-11573 השימוש במכשיר הוא על בסיס משני ופטור מרשיון הפעלה אלחוטית, כלומר – לא מוגן מהפרעות וללא הפרעה למערכות אחרות הפועלות כדין. רק "בפעולת בזק" לשימוש עצמי של הלקוח בלבד, הצויד פטור מרשיון הפעלה אלחוטית. מתן "שרות בזק" לצד ג' מחייב רשיון מיוחד ממשרד התקשורת.
Japan	 003-230332 003-210116 ADF210080003	R: 003-230332 R: 003-210116 T: ADF210080003 Operating Temperature : [from -40 to 85] °C Operating Humidity : [from 0 to 93] %
Malaysia	 CIDF21000127	CIDF21000127
Mexico	IFT: VOVOTC24-01064  NYCE	IFT: VOVOTC24-01064
Morocco	 Agréé par l'ANRT Maroc Number of agreement: MR00039083ANRT2023 Date of agreement: 07/07/2023	MR00039083ANRT2023
Oman	 OMAN-TRA D100428 TRA/TA-R/16945/23	D100428 TRA/TA-R/16945/23
Paraguay	 2024-02-I-0235	2024-02-I-0235
Philippines	 NTC Type Approved No: ESD-GEC-2308176	ESD-GEC-2308176
Russia, Eurasian Economic Union		
Serbia	 II 005 23	I 005 23
Singapore	 Complies with IMDA Standards DB107713	Local importer: Volvo Cars Singapore Pte DB107713
South Africa	 ICASA TA-2023/2143 APPROVED	TA-2023/2143
South Korea		사용자 안내문 이 기기는 전파를 송수신하는 무선 통신 기기로, 전파관리국의 규정을 준수하여야 하며, 이를 위반할 경우 제재 조치를 받을 수 있습니다. R-RT8G-TCAM2
Taiwan	 CCAH245G0110T8	CCA245G0110T8 MPE 1.0 mW/cm² 0.15 mW/cm² 20

Part name	Toxic and hazardous substances and elements					
	Pb	Hg	Cd	Cr (VI)	PBB	PBDE
<p>This table was developed according to the provisions of SJ/T 11364.</p> <p>O: The content of this hazardous substance in all homogeneous materials of this component is below the limit required by GB/T 26572</p> <p>X: the content of this hazardous substance in a certain homogeneous material of this component is beyond the limit required by GB/T 26572</p> <p>(Enterprises may further explain the technical reasons for checking "X" in the table above according to their actual situation herein.</p>						

- [1] TCAM2 and TCAM3
- [2] DoC
- [3] For most bands. Some exceptions exist, per 3GPP standard
- [4] China RoHS

15.5.5. Type approval for TPMS sensor radio frequency

Here you find the radio frequency type approvals for the tire pressure monitoring system sensor.

Region	Specification
Albania	Hereby, Baolong Huf Shanghai Electronics Co., Ltd declares that the radio equipment type TMSS6A4 is in compliance with Directive 2014/53/EU. The full text of the EU declaration of conformity is available at the following internet address: https://www.bh-sens.com/conformity Frequency band: 433.92 MHz Maximum Transmit Power:<10 mW Manufacturer: Baolong Huf Shanghai Electronics Co., Ltd., 1st Floor, Building 5, 5500 Shenzhuan Rd., Songjiang, Shanghai
Andorra	Hereby, Baolong Huf Shanghai Electronics Co., Ltd declares that the radio equipment type TMSS6A4 is in compliance with Directive 2014/53/EU. The full text of the EU declaration of conformity is available at the following internet address: https://www.bh-sens.com/conformity Frequency band: 433.92 MHz Maximum Transmit Power:<10 mW Manufacturer: Baolong Huf Shanghai Electronics Co., Ltd., 1st Floor, Building 5, 5500 Shenzhuan Rd., Songjiang, Shanghai
Angola	Hereby, Baolong Huf Shanghai Electronics Co., Ltd declares that the radio equipment type TMSS6A4 is in compliance with Directive 2014/53/EU. The full text of the EU declaration of conformity is available at the following internet address: https://www.bh-sens.com/conformity Frequency band: 433.92 MHz Maximum Transmit Power:<10 mW Manufacturer: Baolong Huf Shanghai Electronics Co., Ltd., 1st Floor, Building 5, 5500 Shenzhuan Rd., Songjiang, Shanghai
Argentina	Baolong Huf Shanghai Electronics Co., Ltd, hereby declares that this TPMS sensor is in compliance with the essential requirements and provisions of ENACOM.
Armenia	Baolong Huf Shanghai Electronics Co., Ltd, hereby declares that this TPMS sensor is in compliance with the essential requirements and provisions of AR COC.
Australia	Baolong Huf Shanghai Electronics Co., Ltd, hereby declares that this TPMS sensor is in compliance with the essential requirements and provisions of RCM.
Austria	Hereby, Baolong Huf Shanghai Electronics Co., Ltd declares that the radio equipment type TMSS6A4 is in compliance with Directive 2014/53/EU. The full text of the EU declaration of conformity is available at the following internet address: https://www.bh-sens.com/conformity Frequency band: 433.92 MHz Maximum Transmit Power:<10 mW Manufacturer: Baolong Huf Shanghai Electronics Co., Ltd., 1st Floor, Building 5, 5500 Shenzhuan Rd., Songjiang, Shanghai
Azerbaijan	Baolong Huf Shanghai Electronics Co., Ltd, hereby declares that this TPMS sensor is in compliance with the essential requirements and provisions of AZ COC.
Bahrain	Baolong Huf Shanghai Electronics Co., Ltd, hereby declares that this TPMS sensor is in compliance with the essential requirements and provisions of TRA.

Region	Specification
Belgium	Hereby, Baolong Huf Shanghai Electronics Co., Ltd declares that the radio equipment type TMSS6A4 is in compliance with Directive 2014/53/EU. The full text of the EU declaration of conformity is available at the following internet address: https://www.bh-sens.com/conformity Frequency band: 433.92 MHz Maximum Transmit Power:<10 mW Manufacturer: Baolong Huf Shanghai Electronics Co., Ltd., 1st Floor, Building 5, 5500 Shenzhuan Rd., Songjiang, Shanghai
Bolivia	Baolong Huf Shanghai Electronics Co., Ltd, hereby declares that this TPMS sensor is in compliance with the essential requirements and provisions of ATT
Bosnia-Herzegovina	Hereby, Baolong Huf Shanghai Electronics Co., Ltd declares that the radio equipment type TMSS6A4 is in compliance with Directive 2014/53/EU. The full text of the EU declaration of conformity is available at the following internet address: https://www.bh-sens.com/conformity Frequency band: 433.92 MHz Maximum Transmit Power:<10 mW Manufacturer: Baolong Huf Shanghai Electronics Co., Ltd., 1st Floor, Building 5, 5500 Shenzhuan Rd., Songjiang, Shanghai
Botswana	Baolong Huf Shanghai Electronics Co., Ltd, hereby declares that this TPMS sensor is in compliance with the essential requirements and provisions of BOCAR.
Brazil	Baolong Huf Shanghai Electronics Co., Ltd, hereby declares that this TPMS sensor is in compliance with the essential requirements and provisions of ANATEL.
Bulgaria	Hereby, Baolong Huf Shanghai Electronics Co., Ltd declares that the radio equipment type TMSS6A4 is in compliance with Directive 2014/53/EU. The full text of the EU declaration of conformity is available at the following internet address: https://www.bh-sens.com/conformity Frequency band: 433.92 MHz Maximum Transmit Power:<10 mW Manufacturer: Baolong Huf Shanghai Electronics Co., Ltd., 1st Floor, Building 5, 5500 Shenzhuan Rd., Songjiang, Shanghai
Cambodia	Baolong Huf Shanghai Electronics Co., Ltd, hereby declares that this TPMS sensor is in compliance with the essential requirements and provisions of TRC.
Canada	Baolong Huf Shanghai Electronics Co., Ltd, hereby declares that this TPMS sensor is in compliance with the essential requirements and provisions of ISED.
Chile	 El equipo previamente individualizado cumple con las disposiciones establecidas en la Norma Técnica de Equipos de alcance reducido, aprobada por la resolución exenta N° 1.985, de 2017, de la Subsecretaría de Telecomunicaciones.
China	Baolong Huf Shanghai Electronics Co., Ltd, hereby declares that this TPMS sensor is in compliance with the essential requirements and provisions of SRRC.
Colombia	Baolong Huf Shanghai Electronics Co., Ltd, hereby declares that this TPMS sensor is in compliance with the essential requirements and provisions of CRC.
Costa Rica	Baolong Huf Shanghai Electronics Co., Ltd, hereby declares that this TPMS sensor is in compliance with the essential requirements and provisions of SUTEL.
Croatia	Hereby, Baolong Huf Shanghai Electronics Co., Ltd declares that the radio equipment type TMSS6A4 is in compliance with Directive 2014/53/EU. The full text of the EU declaration of conformity is available at the following internet address: https://www.bh-sens.com/conformity Frequency band: 433.92 MHz Maximum Transmit Power:<10 mW Manufacturer: Baolong Huf Shanghai Electronics Co., Ltd., 1st Floor, Building 5, 5500 Shenzhuan Rd., Songjiang, Shanghai
Cyprus	Hereby, Baolong Huf Shanghai Electronics Co., Ltd declares that the radio equipment type TMSS6A4 is in compliance with Directive 2014/53/EU. The full text of the EU declaration of conformity is available at the following internet address: https://www.bh-sens.com/conformity Frequency band: 433.92 MHz Maximum Transmit Power:<10 mW Manufacturer: Baolong Huf Shanghai Electronics Co., Ltd., 1st Floor, Building 5, 5500 Shenzhuan Rd., Songjiang, Shanghai
Czech Republic	Hereby, Baolong Huf Shanghai Electronics Co., Ltd declares that the radio equipment type TMSS6A4 is in compliance with Directive 2014/53/EU. The full text of the EU declaration of conformity is available at the following internet address: https://www.bh-sens.com/conformity Frequency band: 433.92 MHz Maximum Transmit Power:<10 mW Manufacturer: Baolong Huf Shanghai Electronics Co., Ltd., 1st Floor, Building 5, 5500 Shenzhuan Rd., Songjiang, Shanghai
Denmark	Hereby, Baolong Huf Shanghai Electronics Co., Ltd declares that the radio equipment type TMSS6A4 is in compliance with Directive 2014/53/EU. The full text of the EU declaration of conformity is available at the following internet address: https://www.bh-sens.com/conformity Frequency band: 433.92 MHz Maximum Transmit Power:<10 mW Manufacturer: Baolong Huf Shanghai Electronics Co., Ltd., 1st Floor, Building 5, 5500 Shenzhuan Rd., Songjiang, Shanghai

Region	Specification
Dominican Republic	Baolong Huf Shanghai Electronics Co., Ltd, hereby declares that this TPMS sensor is in compliance with the essential requirements and provisions of INDOTEL.
Egypt	Baolong Huf Shanghai Electronics Co., Ltd, hereby declares that this TPMS sensor is in compliance with the essential requirements and provisions of NTRA.
Estonia	Hereby, Baolong Huf Shanghai Electronics Co., Ltd declares that the radio equipment type TMSS6A4 is in compliance with Directive 2014/53/EU. The full text of the EU declaration of conformity is available at the following internet address: https://www.bh-sens.com/conformity Frequency band: 433.92 MHz Maximum Transmit Power:<10 mW Manufacturer: Baolong Huf Shanghai Electronics Co., Ltd., 1st Floor, Building 5, 5500 Shenzhuan Rd., Songjiang, Shanghai
Faroe Islands	Hereby, Baolong Huf Shanghai Electronics Co., Ltd declares that the radio equipment type TMSS6A4 is in compliance with Directive 2014/53/EU. The full text of the EU declaration of conformity is available at the following internet address: https://www.bh-sens.com/conformity Frequency band: 433.92 MHz Maximum Transmit Power:<10 mW Manufacturer: Baolong Huf Shanghai Electronics Co., Ltd., 1st Floor, Building 5, 5500 Shenzhuan Rd., Songjiang, Shanghai
Finland	Hereby, Baolong Huf Shanghai Electronics Co., Ltd declares that the radio equipment type TMSS6A4 is in compliance with Directive 2014/53/EU. The full text of the EU declaration of conformity is available at the following internet address: https://www.bh-sens.com/conformity Frequency band: 433.92 MHz Maximum Transmit Power:<10 mW Manufacturer: Baolong Huf Shanghai Electronics Co., Ltd., 1st Floor, Building 5, 5500 Shenzhuan Rd., Songjiang, Shanghai
France	Hereby, Baolong Huf Shanghai Electronics Co., Ltd declares that the radio equipment type TMSS6A4 is in compliance with Directive 2014/53/EU. The full text of the EU declaration of conformity is available at the following internet address: https://www.bh-sens.com/conformity Frequency band: 433.92 MHz Maximum Transmit Power:<10 mW Manufacturer: Baolong Huf Shanghai Electronics Co., Ltd., 1st Floor, Building 5, 5500 Shenzhuan Rd., Songjiang, Shanghai
Georgia	Hereby, Baolong Huf Shanghai Electronics Co., Ltd declares that the radio equipment type TMSS6A4 is in compliance with Directive 2014/53/EU. The full text of the EU declaration of conformity is available at the following internet address: https://www.bh-sens.com/conformity Frequency band: 433.92 MHz Maximum Transmit Power:<10 mW Manufacturer: Baolong Huf Shanghai Electronics Co., Ltd., 1st Floor, Building 5, 5500 Shenzhuan Rd., Songjiang, Shanghai
Germany	Hereby, Baolong Huf Shanghai Electronics Co., Ltd declares that the radio equipment type TMSS6A4 is in compliance with Directive 2014/53/EU. The full text of the EU declaration of conformity is available at the following internet address: https://www.bh-sens.com/conformity Frequency band: 433.92 MHz Maximum Transmit Power:<10 mW Manufacturer: Baolong Huf Shanghai Electronics Co., Ltd., 1st Floor, Building 5, 5500 Shenzhuan Rd., Songjiang, Shanghai
Greece	Hereby, Baolong Huf Shanghai Electronics Co., Ltd declares that the radio equipment type TMSS6A4 is in compliance with Directive 2014/53/EU. The full text of the EU declaration of conformity is available at the following internet address: https://www.bh-sens.com/conformity Frequency band: 433.92 MHz Maximum Transmit Power:<10 mW Manufacturer: Baolong Huf Shanghai Electronics Co., Ltd., 1st Floor, Building 5, 5500 Shenzhuan Rd., Songjiang, Shanghai
Greenland	Hereby, Baolong Huf Shanghai Electronics Co., Ltd declares that the radio equipment type TMSS6A4 is in compliance with Directive 2014/53/EU. The full text of the EU declaration of conformity is available at the following internet address: https://www.bh-sens.com/conformity Frequency band: 433.92 MHz Maximum Transmit Power:<10 mW Manufacturer: Baolong Huf Shanghai Electronics Co., Ltd., 1st Floor, Building 5, 5500 Shenzhuan Rd., Songjiang, Shanghai
Guadeloupe	Hereby, Baolong Huf Shanghai Electronics Co., Ltd declares that the radio equipment type TMSS6A4 is in compliance with Directive 2014/53/EU. The full text of the EU declaration of conformity is available at the following internet address: https://www.bh-sens.com/conformity Frequency band: 433.92 MHz Maximum Transmit Power:<10 mW Manufacturer: Baolong Huf Shanghai Electronics Co., Ltd., 1st Floor, Building 5, 5500 Shenzhuan Rd., Songjiang, Shanghai
Guatemala	Baolong Huf Shanghai Electronics Co., Ltd, hereby declares that this TPMS sensor is in compliance with the essential requirements and provisions of SIT.
Hong Kong	Hereby, Baolong Huf Shanghai Electronics Co., Ltd declares that the radio equipment type TMSS6A4 is in compliance with Directive 2014/53/EU. The full text of the EU declaration of conformity is available at the following internet address: https://www.bh-sens.com/conformity Frequency band: 433.92 MHz Maximum Transmit Power:<10 mW Manufacturer: Baolong Huf Shanghai Electronics Co., Ltd., 1st Floor, Building 5, 5500 Shenzhuan Rd., Songjiang, Shanghai

Region	Specification
Hungary	Hereby, Baolong Huf Shanghai Electronics Co., Ltd declares that the radio equipment type TMSS6A4 is in compliance with Directive 2014/53/EU. The full text of the EU declaration of conformity is available at the following internet address: https://www.bh-sens.com/conformity Frequency band: 433.92 MHz Maximum Transmit Power:<10 mW Manufacturer: Baolong Huf Shanghai Electronics Co., Ltd., 1st Floor, Building 5, 5500 Shenzhuan Rd., Songjiang, Shanghai
Iceland	Hereby, Baolong Huf Shanghai Electronics Co., Ltd declares that the radio equipment type TMSS6A4 is in compliance with Directive 2014/53/EU. The full text of the EU declaration of conformity is available at the following internet address: https://www.bh-sens.com/conformity Frequency band: 433.92 MHz Maximum Transmit Power:<10 mW Manufacturer: Baolong Huf Shanghai Electronics Co., Ltd., 1st Floor, Building 5, 5500 Shenzhuan Rd., Songjiang, Shanghai
India	Baolong Huf Shanghai Electronics Co., Ltd, hereby declares that this TPMS sensor is in compliance with the essential requirements and provisions of WPC.
Indonesia	Baolong Huf Shanghai Electronics Co., Ltd, hereby declares that this TPMS sensor is in compliance with the essential requirements and provisions of SDPPI.
Ireland	Hereby, Baolong Huf Shanghai Electronics Co., Ltd declares that the radio equipment type TMSS6A4 is in compliance with Directive 2014/53/EU. The full text of the EU declaration of conformity is available at the following internet address: https://www.bh-sens.com/conformity Frequency band: 433.92 MHz Maximum Transmit Power:<10 mW Manufacturer: Baolong Huf Shanghai Electronics Co., Ltd., 1st Floor, Building 5, 5500 Shenzhuan Rd., Songjiang, Shanghai
Israel	Baolong Huf Shanghai Electronics Co., Ltd, hereby declares that this TPMS sensor is in compliance with the essential requirements and provisions of MOC.
Italy	Hereby, Baolong Huf Shanghai Electronics Co., Ltd declares that the radio equipment type TMSS6A4 is in compliance with Directive 2014/53/EU. The full text of the EU declaration of conformity is available at the following internet address: https://www.bh-sens.com/conformity Frequency band: 433.92 MHz Maximum Transmit Power:<10 mW Manufacturer: Baolong Huf Shanghai Electronics Co., Ltd., 1st Floor, Building 5, 5500 Shenzhuan Rd., Songjiang, Shanghai
Ivory Coast	Baolong Huf Shanghai Electronics Co., Ltd, hereby declares that this TPMS sensor is in compliance with the essential requirements and provisions of ARTCI.
Japan	Baolong Huf Shanghai Electronics Co., Ltd, hereby declares that this TPMS sensor is in compliance with the essential requirements and provisions of MIC.
Jordan	Baolong Huf Shanghai Electronics Co., Ltd, hereby declares that this TPMS sensor is in compliance with the essential requirements and provisions of TRC.
Kazakhstan	Baolong Huf Shanghai Electronics Co., Ltd, hereby declares that this TPMS sensor is in compliance with the essential requirements and provisions of EAC.
Kenya	Baolong Huf Shanghai Electronics Co., Ltd, hereby declares that this TPMS sensor is in compliance with the essential requirements and provisions of CAK.
Korea	Baolong Huf Shanghai Electronics Co., Ltd, hereby declares that this TPMS sensor is in compliance with the essential requirements and provisions of KC.
Kosovo	Hereby, Baolong Huf Shanghai Electronics Co., Ltd declares that the radio equipment type TMSS6A4 is in compliance with Directive 2014/53/EU. The full text of the EU declaration of conformity is available at the following internet address: https://www.bh-sens.com/conformity Frequency band: 433.92 MHz Maximum Transmit Power:<10 mW Manufacturer: Baolong Huf Shanghai Electronics Co., Ltd., 1st Floor, Building 5, 5500 Shenzhuan Rd., Songjiang, Shanghai
Kuwait	Baolong Huf Shanghai Electronics Co., Ltd, hereby declares that this TPMS sensor is in compliance with the essential requirements and provisions of CITRA.
La Réunion	Hereby, Baolong Huf Shanghai Electronics Co., Ltd declares that the radio equipment type TMSS6A4 is in compliance with Directive 2014/53/EU. The full text of the EU declaration of conformity is available at the following internet address: https://www.bh-sens.com/conformity Frequency band: 433.92 MHz Maximum Transmit Power:<10 mW Manufacturer: Baolong Huf Shanghai Electronics Co., Ltd., 1st Floor, Building 5, 5500 Shenzhuan Rd., Songjiang, Shanghai
Latvia	Hereby, Baolong Huf Shanghai Electronics Co., Ltd declares that the radio equipment type TMSS6A4 is in compliance with Directive 2014/53/EU. The full text of the EU declaration of conformity is available at the following internet address: https://www.bh-sens.com/conformity Frequency band: 433.92 MHz Maximum Transmit Power:<10 mW Manufacturer: Baolong Huf Shanghai Electronics Co., Ltd., 1st Floor, Building 5, 5500 Shenzhuan Rd., Songjiang, Shanghai

Region	Specification
Lebanon	Baolong Huf Shanghai Electronics Co., Ltd, hereby declares that this TPMS sensor is in compliance with the essential requirements and provisions of MOT.
Liechtenstein	Hereby, Baolong Huf Shanghai Electronics Co., Ltd declares that the radio equipment type TMSS6A4 is in compliance with Directive 2014/53/EU. The full text of the EU declaration of conformity is available at the following internet address: https://www.bh-sens.com/conformity Frequency band: 433.92 MHz Maximum Transmit Power:<10 mW Manufacturer: Baolong Huf Shanghai Electronics Co., Ltd., 1st Floor, Building 5, 5500 Shenzhuan Rd., Songjiang, Shanghai
Lithuania	Hereby, Baolong Huf Shanghai Electronics Co., Ltd declares that the radio equipment type TMSS6A4 is in compliance with Directive 2014/53/EU. The full text of the EU declaration of conformity is available at the following internet address: https://www.bh-sens.com/conformity Frequency band: 433.92 MHz Maximum Transmit Power:<10 mW Manufacturer: Baolong Huf Shanghai Electronics Co., Ltd., 1st Floor, Building 5, 5500 Shenzhuan Rd., Songjiang, Shanghai
Luxembourg	Hereby, Baolong Huf Shanghai Electronics Co., Ltd declares that the radio equipment type TMSS6A4 is in compliance with Directive 2014/53/EU. The full text of the EU declaration of conformity is available at the following internet address: https://www.bh-sens.com/conformity Frequency band: 433.92 MHz Maximum Transmit Power:<10 mW Manufacturer: Baolong Huf Shanghai Electronics Co., Ltd., 1st Floor, Building 5, 5500 Shenzhuan Rd., Songjiang, Shanghai
Macedonia	Hereby, Baolong Huf Shanghai Electronics Co., Ltd declares that the radio equipment type TMSS6A4 is in compliance with Directive 2014/53/EU. The full text of the EU declaration of conformity is available at the following internet address: https://www.bh-sens.com/conformity Frequency band: 433.92 MHz Maximum Transmit Power:<10 mW Manufacturer: Baolong Huf Shanghai Electronics Co., Ltd., 1st Floor, Building 5, 5500 Shenzhuan Rd., Songjiang, Shanghai
Malaysia	Baolong Huf Shanghai Electronics Co., Ltd, hereby declares that this TPMS sensor is in compliance with the essential requirements and provisions of SIRIM.
Malta	Hereby, Baolong Huf Shanghai Electronics Co., Ltd declares that the radio equipment type TMSS6A4 is in compliance with Directive 2014/53/EU. The full text of the EU declaration of conformity is available at the following internet address: https://www.bh-sens.com/conformity Frequency band: 433.92 MHz Maximum Transmit Power:<10 mW Manufacturer: Baolong Huf Shanghai Electronics Co., Ltd., 1st Floor, Building 5, 5500 Shenzhuan Rd., Songjiang, Shanghai
Martinique	Hereby, Baolong Huf Shanghai Electronics Co., Ltd declares that the radio equipment type TMSS6A4 is in compliance with Directive 2014/53/EU. The full text of the EU declaration of conformity is available at the following internet address: https://www.bh-sens.com/conformity Frequency band: 433.92 MHz Maximum Transmit Power:<10 mW Manufacturer: Baolong Huf Shanghai Electronics Co., Ltd., 1st Floor, Building 5, 5500 Shenzhuan Rd., Songjiang, Shanghai
Morocco	Baolong Huf Shanghai Electronics Co., Ltd, hereby declares that this TPMS sensor is in compliance with the essential requirements and provisions of ANRT.
Mexico	Modelo del producto: TMSS6A4 Marca: BH SENS IFT: VOBHTM23-23595 La operación de este equipo está sujeta a las siguientes dos condiciones: (1) es posible que este equipo o dispositivo no cause interferencia perjudicial y (2) este equipo o dispositivo debe aceptar cualquier interferencia, incluyendo la que pueda causar su operación no deseada.
Moldova	Hereby, Baolong Huf Shanghai Electronics Co., Ltd declares that the radio equipment type TMSS6A4 is in compliance with Directive 2014/53/EU. The full text of the EU declaration of conformity is available at the following internet address: https://www.bh-sens.com/conformity Frequency band: 433.92 MHz Maximum Transmit Power:<10 mW Manufacturer: Baolong Huf Shanghai Electronics Co., Ltd., 1st Floor, Building 5, 5500 Shenzhuan Rd., Songjiang, Shanghai
Monaco	Hereby, Baolong Huf Shanghai Electronics Co., Ltd declares that the radio equipment type TMSS6A4 is in compliance with Directive 2014/53/EU. The full text of the EU declaration of conformity is available at the following internet address: https://www.bh-sens.com/conformity Frequency band: 433.92 MHz Maximum Transmit Power:<10 mW Manufacturer: Baolong Huf Shanghai Electronics Co., Ltd., 1st Floor, Building 5, 5500 Shenzhuan Rd., Songjiang, Shanghai
Mozambique	Baolong Huf Shanghai Electronics Co., Ltd, hereby declares that this TPMS sensor is in compliance with the essential requirements and provisions of INCM.
Namibia	Baolong Huf Shanghai Electronics Co., Ltd, hereby declares that this TPMS sensor is in compliance with the essential requirements and provisions of CRAN.

Region	Specification
Netherlands	Hereby, Baolong Huf Shanghai Electronics Co., Ltd declares that the radio equipment type TMSS6A4 is in compliance with Directive 2014/53/EU. The full text of the EU declaration of conformity is available at the following internet address: https://www.bh-sens.com/conformity Frequency band: 433.92 MHz Maximum Transmit Power:<10 mW Manufacturer: Baolong Huf Shanghai Electronics Co., Ltd., 1st Floor, Building 5, 5500 Shenzhuan Rd., Songjiang, Shanghai
New Zealand	Baolong Huf Shanghai Electronics Co., Ltd, hereby declares that this TPMS sensor is in compliance with the essential requirements and provisions of RCM.
Norway	Hereby, Baolong Huf Shanghai Electronics Co., Ltd declares that the radio equipment type TMSS6A4 is in compliance with Directive 2014/53/EU. The full text of the EU declaration of conformity is available at the following internet address: https://www.bh-sens.com/conformity Frequency band: 433.92 MHz Maximum Transmit Power:<10 mW Manufacturer: Baolong Huf Shanghai Electronics Co., Ltd., 1st Floor, Building 5, 5500 Shenzhuan Rd., Songjiang, Shanghai
Oman	Baolong Huf Shanghai Electronics Co., Ltd, hereby declares that this TPMS sensor is in compliance with the essential requirements and provisions of TRA.
Pakistan	Baolong Huf Shanghai Electronics Co., Ltd, hereby declares that this TPMS sensor is in compliance with the essential requirements and provisions of PTA.
Panama	Baolong Huf Shanghai Electronics Co., Ltd, hereby declares that this TPMS sensor is in compliance with the essential requirements and provisions of ASEP.
Paraguay	Baolong Huf Shanghai Electronics Co., Ltd, hereby declares that this TPMS sensor is in compliance with the essential requirements and provisions of CONATEL.
Peru (Maquinaria)	Baolong Huf Shanghai Electronics Co., Ltd, hereby declares that this TPMS sensor is in compliance with the essential requirements and provisions of MTC.
Philippines	Baolong Huf Shanghai Electronics Co., Ltd, hereby declares that this TPMS sensor is in compliance with the essential requirements and provisions of NTC.
Poland	Hereby, Baolong Huf Shanghai Electronics Co., Ltd declares that the radio equipment type TMSS6A4 is in compliance with Directive 2014/53/EU. The full text of the EU declaration of conformity is available at the following internet address: https://www.bh-sens.com/conformity Frequency band: 433.92 MHz Maximum Transmit Power:<10 mW Manufacturer: Baolong Huf Shanghai Electronics Co., Ltd., 1st Floor, Building 5, 5500 Shenzhuan Rd., Songjiang, Shanghai
Portugal	Hereby, Baolong Huf Shanghai Electronics Co., Ltd declares that the radio equipment type TMSS6A4 is in compliance with Directive 2014/53/EU. The full text of the EU declaration of conformity is available at the following internet address: https://www.bh-sens.com/conformity Frequency band: 433.92 MHz Maximum Transmit Power:<10 mW Manufacturer: Baolong Huf Shanghai Electronics Co., Ltd., 1st Floor, Building 5, 5500 Shenzhuan Rd., Songjiang, Shanghai
Puerto Rico	Baolong Huf Shanghai Electronics Co., Ltd, hereby declares that this TPMS sensor is in compliance with the essential requirements and provisions of FCC.
Qatar	Baolong Huf Shanghai Electronics Co., Ltd, hereby declares that this TPMS sensor is in compliance with the essential requirements and provisions of CRA.
Romania	Hereby, Baolong Huf Shanghai Electronics Co., Ltd declares that the radio equipment type TMSS6A4 is in compliance with Directive 2014/53/EU. The full text of the EU declaration of conformity is available at the following internet address: https://www.bh-sens.com/conformity Frequency band: 433.92 MHz Maximum Transmit Power:<10 mW Manufacturer: Baolong Huf Shanghai Electronics Co., Ltd., 1st Floor, Building 5, 5500 Shenzhuan Rd., Songjiang, Shanghai
San Marino	Hereby, Baolong Huf Shanghai Electronics Co., Ltd declares that the radio equipment type TMSS6A4 is in compliance with Directive 2014/53/EU. The full text of the EU declaration of conformity is available at the following internet address: https://www.bh-sens.com/conformity Frequency band: 433.92 MHz Maximum Transmit Power:<10 mW Manufacturer: Baolong Huf Shanghai Electronics Co., Ltd., 1st Floor, Building 5, 5500 Shenzhuan Rd., Songjiang, Shanghai
Saudi Arabia	Baolong Huf Shanghai Electronics Co., Ltd, hereby declares that this TPMS sensor is in compliance with the essential requirements and provisions of CST.
Serbia/Montenegro	Baolong Huf Shanghai Electronics Co., Ltd, hereby declares that this TPMS sensor is in compliance with the essential requirements and provisions of RS COC.
Singapore	Baolong Huf Shanghai Electronics Co., Ltd, hereby declares that this TPMS sensor is in compliance with the essential requirements and provisions of IMDA.

Region	Specification
Slovak Republic	Hereby, Baolong Huf Shanghai Electronics Co., Ltd declares that the radio equipment type TMSS6A4 is in compliance with Directive 2014/53/EU. The full text of the EU declaration of conformity is available at the following internet address: https://www.bh-sens.com/conformity Frequency band: 433.92 MHz Maximum Transmit Power:<10 mW Manufacturer: Baolong Huf Shanghai Electronics Co., Ltd., 1st Floor, Building 5, 5500 Shenzhuan Rd., Songjiang, Shanghai
Slovenia	Hereby, Baolong Huf Shanghai Electronics Co., Ltd declares that the radio equipment type TMSS6A4 is in compliance with Directive 2014/53/EU. The full text of the EU declaration of conformity is available at the following internet address: https://www.bh-sens.com/conformity Frequency band: 433.92 MHz Maximum Transmit Power:<10 mW Manufacturer: Baolong Huf Shanghai Electronics Co., Ltd., 1st Floor, Building 5, 5500 Shenzhuan Rd., Songjiang, Shanghai
South Africa	Baolong Huf Shanghai Electronics Co., Ltd, hereby declares that this TPMS sensor is in compliance with the essential requirements and provisions of ICASA.
Spain	Hereby, Baolong Huf Shanghai Electronics Co., Ltd declares that the radio equipment type TMSS6A4 is in compliance with Directive 2014/53/EU. The full text of the EU declaration of conformity is available at the following internet address: https://www.bh-sens.com/conformity Frequency band: 433.92 MHz Maximum Transmit Power:<10 mW Manufacturer: Baolong Huf Shanghai Electronics Co., Ltd., 1st Floor, Building 5, 5500 Shenzhuan Rd., Songjiang, Shanghai
Sri Lanka	Baolong Huf Shanghai Electronics Co., Ltd, hereby declares that this TPMS sensor is in compliance with the essential requirements and provisions of TRCSL.
Sweden	Hereby, Baolong Huf Shanghai Electronics Co., Ltd declares that the radio equipment type TMSS6A4 is in compliance with Directive 2014/53/EU. The full text of the EU declaration of conformity is available at the following internet address: https://www.bh-sens.com/conformity Frequency band: 433.92 MHz Maximum Transmit Power:<10 mW Manufacturer: Baolong Huf Shanghai Electronics Co., Ltd., 1st Floor, Building 5, 5500 Shenzhuan Rd., Songjiang, Shanghai
Switzerland	Hereby, Baolong Huf Shanghai Electronics Co., Ltd declares that the radio equipment type TMSS6A4 is in compliance with Directive 2014/53/EU. The full text of the EU declaration of conformity is available at the following internet address: https://www.bh-sens.com/conformity Frequency band: 433.92 MHz Maximum Transmit Power:<10 mW Manufacturer: Baolong Huf Shanghai Electronics Co., Ltd., 1st Floor, Building 5, 5500 Shenzhuan Rd., Songjiang, Shanghai
Taiwan	Baolong Huf Shanghai Electronics Co., Ltd, hereby declares that this TPMS sensor is in compliance with the essential requirements and provisions of NCC.
Thailand	Baolong Huf Shanghai Electronics Co., Ltd, hereby declares that this TPMS sensor is in compliance with the essential requirements and provisions of NBTC.
Trinidad and Tobago	Baolong Huf Shanghai Electronics Co., Ltd, hereby declares that this TPMS sensor is in compliance with the essential requirements and provisions of TATT.
Tunisia	Baolong Huf Shanghai Electronics Co., Ltd, hereby declares that this TPMS sensor is in compliance with the essential requirements and provisions of CERT.
Turkey	Hereby, Baolong Huf Shanghai Electronics Co., Ltd declares that the radio equipment type TMSS6A4 is in compliance with Directive 2014/53/EU. The full text of the EU declaration of conformity is available at the following internet address: https://www.bh-sens.com/conformity Frequency band: 433.92 MHz Maximum Transmit Power:<10 mW Manufacturer: Baolong Huf Shanghai Electronics Co., Ltd., 1st Floor, Building 5, 5500 Shenzhuan Rd., Songjiang, Shanghai
United Arab Emirates	Baolong Huf Shanghai Electronics Co., Ltd, hereby declares that this TPMS sensor is in compliance with the essential requirements and provisions of TDRA.
Ukraine	справжнім Baolong Huf Shanghai Electronics Co., Ltd заявляє, що тип радіобладнання TMSS6A4 відповідає Технічному регламенту радіобладнання; повний текст декларації про відповідність доступний на веб-сайті за такою адресою: https://www.bh-sens.com/conformity
United Kingdom	Hereby, Baolong Huf Shanghai Electronics Co., Ltd declares that the radio equipment type TMSS6A4 is in compliance with radio regulation 2017. The full text of the UK declaration of conformity is available at the following internet address: https://www.bh-sens.com/conformity Frequency band: 433.92 MHz Maximum Transmit Power:<10 mW Manufacturer: Baolong Huf Shanghai Electronics Co., Ltd., 1st Floor, Building 5, 5500 Shenzhuan Rd., Songjiang, Shanghai
Uruguay	Baolong Huf Shanghai Electronics Co., Ltd, hereby declares that this TPMS sensor is in compliance with the essential requirements and provisions of URSEC.
United States	Baolong Huf Shanghai Electronics Co., Ltd, hereby declares that this TPMS sensor is in compliance with the essential requirements and provisions of FCC.

Region	Specification
Uzbekistan	Baolong Huf Shanghai Electronics Co., Ltd, hereby declares that this TPMS sensor is in compliance with the essential requirements and provisions of MITC.
Vatican City	Hereby, Baolong Huf Shanghai Electronics Co., Ltd declares that the radio equipment type TMSS6A4 is in compliance with Directive 2014/53/EU. The full text of the EU declaration of conformity is available at the following internet address: https://www.bh-sens.com/conformity Frequency band: 433.92 MHz Maximum Transmit Power:<10 mW Manufacturer: Baolong Huf Shanghai Electronics Co., Ltd., 1st Floor, Building 5, 5500 Shenzhuan Rd., Songjiang, Shanghai
Vietnam	Baolong Huf Shanghai Electronics Co., Ltd, hereby declares that this TPMS sensor is in compliance with the essential requirements and provisions of MIC.
Zambia	Baolong Huf Shanghai Electronics Co., Ltd, hereby declares that this TPMS sensor is in compliance with the essential requirements and provisions of ZICTA.
Zimbabwe	Baolong Huf Shanghai Electronics Co., Ltd, hereby declares that this TPMS sensor is in compliance with the essential requirements and provisions of POTRAZ.

15.5.6. Type approvals for wireless charger and NFC

Below are the technical specifications and certificates for the wireless charger.

Manufacturer

Molex CVS Bochum GmbH

Address: Meesmannstr. 103, 44807 Bochum, Germany

Phone: +49 234 51668 0

Technical specification

Wireless charger







- Frequency Band: 127.55 kHz
- Maximum Magnetic Field Strength: 55.77 dB μ A/m







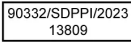

NFC card reader





- Frequency Band 13.56MHz
- Maximum Magnetic Field Strength: 42 dB μ A/m

Declaration of conformity

Albania, Austria, Belgium, Bulgaria, Croatia, Cyprus, Czech republic, Denmark, Estonia, Finland, France, Germany, Greece, Hungary, Iceland, Ireland, Italy, Latvia, Lithuania, Luxembourg, Malta, Netherlands, Norway, Poland, Portugal, Romania, Slovenia, Slovakia, Spain, Sweden, Switzerland	Hereby, Molex CVS Bochum GmbH declares that the radio equipment type WCH-303 is in compliance with Directive 2014/53/EU. The full text of the EU declaration of conformity is available at the following internet address: http://www.molex.com/doc
Argentina	 H-29186

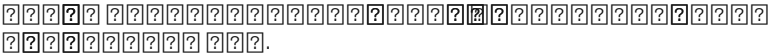
France, Belgium, Luxembourg, Switzerland	Le soussigné, Molex CVS Bochum GmbH, déclare que l'équipement radioélectrique du type WCH-303 est conforme à la directive 2014/53/UE. Le texte complet de la déclaration UE de conformité est disponible à l'adresse internet suivante: http://www.molex.com/doc
Ghana	
Greece, Cyprus	Με την παρούσα ο/η Molex CVS Bochum GmbH, δηλώνει ότι ο ραδιοεξοπλισμός WCH-303 πληροί την οδηγία 2014/53/ΕΕ. Το πλήρες κείμενο της δήλωσης συμμόρφωσης ΕΕ διατίθεται στην ακόλουθη ιστοσελίδα στο διαδίκτυο: http://www.molex.com/doc
Indonesia	 <p>Dilarang melakukan perubahan spesifikasi yang dapat menimbulkan gangguan fisik dan/atau elektromagnetik terhadap lingkungan sekitarnya</p> <p>China:</p>   <p>Mexico:</p>  
Israel	מספר אישור התאמה מטעם משרד התקשורת : 51-9279 חל איסור לבצע פעולות במכשיר אשר יש בהן כדי לשנות את תכונותיו האלחוטיות של המכשיר, ובכלל זה החלפת אנטנה מקורית או הוספת אפשרות לחיבור לאנטנה חיצונית ללא קבלת אישור משרד התקשורת, בשל חשש להפרעות אלחוטיות.
Italy, Switzerland	Il fabbricante, Molex CVS Bochum GmbH, dichiara che il tipo di apparecchiatura radio WCH-303 è conforme alla direttiva 2014/53/UE. Il testo completo della dichiarazione di conformità UE è disponibile al seguente indirizzo Internet: http://www.molex.com/doc
Latvia	Ar šo Molex CVS Bochum GmbH deklarē, ka radioiekārta WCH-303 atbilst Direktīvai 2014/53/ES. Pilns ES atbilstības deklarācijas teksts ir pieejams šādā interneta vietnē: http://www.molex.com/doc
Lithuania	Aš, Molex CVS Bochum GmbH, patvirtinu, kad radijo įrenginių tipas WCH-303 atitinka Direktyvą 2014/53/ES. Visas ES atitikties deklaracijos tekstas prieinamas šiuo interneto adresu: http://www.molex.com/doc
Hungary	Molex CVS Bochum GmbH igazolja, hogy a WCH-303 típusú rádióberendezés megfelel a 2014/53/EU irányelvnek. Az EU-megfelelőségi nyilatkozat teljes szövege elérhető a következő internetes címen: http://www.molex.com/doc
Malaysia	
Malta	B'dan, Molex CVS Bochum GmbH, niddikjara li dan it-tip ta' tagħmir tar-radju WCH-303 huwa konformi mad-Direttiva 2014/53/UE. It-test kollu tad-dikjarazzjoni ta' konformità ta' UE huwa disponibbli f'dan l-indirizz tal-Internet li ġej: http://www.molex.com/doc







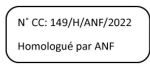
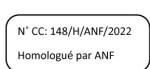

Mexico	IFT approval:VOMOWC23-11195
Oman	
Pakistan	
Paraguay	
Poland	Molex CVS Bochum GmbH niniejszym oświadcza, że typ urządzenia radiowego WCH-303 jest zgodny z dyrektywą 2014/53/UE. Pełny tekst deklaracji zgodności UE jest dostępny pod następującym adresem internetowym: http://www.molex.com/doc
Portugal	O(a) abaixo assinado(a) Molex CVS Bochum GmbH declara que o presente tipo de equipamento de rádio WCH-303 está em conformidade com a Diretiva 2014/53/UE. O texto integral da declaração de conformidade está disponível no seguinte endereço de Internet: http://www.molex.com/doc
Romania, Moldova	Prin prezenta, Molex CVS Bochum GmbH declară că tipul de echipamente radio WCH-303 este în conformitate cu Directiva 2014/53/UE. Textul integral al declarației UE de conformitate este disponibil la următoarea adresă internet: http://www.molex.com/doc
Kazakhstan, Kyrgyzstan	Модель: WCH-303 Изготовитель: Molex Сделано в Китае Сделано в Мексике Электропитание: 12V 1.8A 
Serbia	
Singapore	
Slovenia	Molex CVS Bochum GmbH potrjuje, da je tip radijske opreme WCH-303 skladen z irektivno 2014/53/EU. Celotno besedilo izjave EU o skladnosti je na voljo na naslednjem spletnem naslovu: http://www.molex.com/doc
Slovakia	Molex CVS Bochum GmbH týmto vyhlasuje, že rádiové zariadenie typu WCH-303 je v súlade so smernicou 2014/53/EÚ. Úplné EÚ vyhlásenie o zhode je k dispozícii na tejto internetovej adrese: http://www.molex.com/doc
South Africa	
South Korea	☐☐☐☐☐☐☐ Molex CVS Bochum GmbH ☐☐☐☐/☐☐☐☐ Germany / Mexico, China ☐☐☐☐☐☐/☐☐☐☐ WCH-303 ☐☐☐☐☐☐/☐☐☐☐ R-R-N7V-WCH-303 
Spain	Por la presente, Molex CVS Bochum GmbH declara que el tipo de equipo radioeléctrico WCH-303 es conforme con la Directiva 2014/53/UE. El texto completo de la declaración UE de conformidad está disponible en la dirección Internet siguiente: http://www.molex.com/doc

Sweden, Finland, Norway	Härmed försäkrar Molex CVS Bochum GmbH att denna typ av radioutrustning WCH-303 överensstämmer med direktiv 2014/53/EU. Den fullständiga texten till EU-försäkran om överensstämmelse finns på följande webbadress: http://www.molex.com/doc
Taiwan	
Thailand	
Turkey	<p>İşbu belge; Molex CVS Bochum GmbH telsiz ekipmanı tipinin WCH-303 2014/53/AB sayılı Direktif'e uygun olduğunu beyan eder. AB uygunluk beyanının tam metni aşağıdaki internet adresinde mevcuttur: http://www.molex.com/doc</p> <p>Importer: Volvo Car Turkey Otomobil LTD. ŞTİ. Selahattin Kutman Phone: +90 532 2730116 Address: Fatih Sultan Mehmet Mah. Poligon Cad. Buyaka2 Sitesi No:8B Kule2 Kat 4 Tepeüstü Ümraniye 34711 İstanbul, Turkey Email: selahattin.kutman@volvocars.com</p>
United Arab Emirates	
United Kingdom	<p>Hereby, Molex CVS Bochum GmbH declares that the radio equipment type WCH-303 is in compliance with the Radio Equipment Regulations 2017. The full text of the UK declaration of conformity is available at the following internet address: http://www.molex.com/doc</p> <p>Importer: Volvo Car UK Chris Mullord Phone: +44 7730 809372 Address: Scandinavia House Norreys Drive Maidenhead, SL6 4FL, UK Email: chris.mullord@volvocars.com</p>
Ukraine	<p>СПРОЩЕНА ДЕКЛАРАЦІЯ ПРО ВІДПОВІДНІСТЬ Molex CVS Bochum GmbH заявляє, що тип радіобладнання WCH-303 відповідає Технічному регламенту радіобладнання; повний текст декларації про відповідність доступний на веб-сайті за такою адресою: http://www.molex.com/doc</p> 
Vietnam	
Zambia	

15.5.7. Door NFC certification

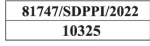
The outer door handle electronics are part of a keyless driver authorization system using NFC^[1]. The following information relates to legal, health and safety warnings, and/or standards compliance reference.

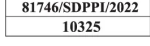
Model DH421

Concerning region	Product origin	Label image or cert. number	Regulatory compliance	Other
Algeria	China		N° CC: 149/H/ANF/2022 Homologué par ANF	
Algeria	USA		N° CC: 148/H/ANF/2022 Homologué par ANF	
Brazil			Este equipamento não tem direito à proteção contra interferência prejudicial e não pode causar interferência em sistemas devidamente autorizados. Para maiores informações, consulte o site da ANATEL – www.anatel.gov.br	Modelo: DH421
Cambodia	China	RF-TA-2022-0450		TRC identifier (RF-TA-2022-XXXX)
Cambodia	USA	RF-TA-2022-0451		
China (Hong Kong)				OFCA label
Indonesia	China	  		
Indonesia	USA	  		
Malaysia				

conditionssuivantes: (1) l'appareil ne doit pas produire de brouillage, et (2) l'appareil doit accepter tout brouillage radioélectrique subi, même si le brouillage est susceptible d'en compromettre le fonctionnement.

According 15.21 WARNING: Changes or modifications made to this equipment not expressly approved by WITTE Automotive; WITTE-Velbert GmbH & Co. KG may void the FCC authorization to operate this equipment.

The DH421 (outer door handle electronics) is a part of a keyless driver authorization system, with NFC as a new and additional feature (the system will be mounted inside of the outer door handle). The system combines the Keyless-Go feature based on capacitive sensors (lock/unlock/request) and the NFC (Near-Field-Communication at 13.56 MHz) contactless communication standard. The product is safe with regards to RF exposure to humans in the general public if a distance of 10 cm or more is maintained at all times where there is no intention to trigger the lock function.

 **Warning**

Improper use of vehicle opening can result in serious personal injury. Always take the key (including digital keys) with you when you leave the vehicle. The engine can be started, and vehicle systems such as the power windows can be operated, which can result in serious personal injury. Never leave children, disabled persons or anyone who cannot help themselves in the vehicle. The doors can be locked using the remote control key or by touching the capacitive lock sensor area of the door handle. This could result in people being trapped in the vehicle in an emergency. For example, depending on the time of year, people trapped in the vehicle can be exposed to very high or low temperatures. Never remove the key from the steering lock while the vehicle is moving or while it is rolling to a stop. The steering wheel column will lock up and you will not be able to steer or control the vehicle.

 **Note**

The outer door handle contains electronic components. Protect these from rough handling. Never leave any vehicle keys (including digital keys) inside the vehicle. Entry by unauthorized persons could damage the vehicle or your vehicle could be stolen. Always take the keys with you whenever you leave your vehicle.

^[1] Near-field communication

15.5.8. Key systems certification

Here you can find certification for compliance to standards for distance-capable keys and the associated key readers.



Key systems

Country/Region	Homologation type	Compliance	Label
EU Accession State Albania, Andorra, San Marino, Vatican City, Bosnia and Herzegovina, Macedonia, Monaco, Moldova, Montenegro, Turkey, Kosovo, Greenland, Faroe Islands	WAN00, YBN00	<p>UWB Reader (UWBR): Model: WAN00 Manufacturer: DENSO CORPORATION Address: 1-1, Showa-cho, Kariya-shi, Aichi-ken, 448-8661 Japan Operation frequency: CH5: 6240.0 - 6739.2 MHz CH9: 7737.6 - 8236.8 MHz. Maximum output power: -41.3 dBm/MHz or less Radio Frequency Key (RFK) Model: YBN00 Manufacturer: DENSO CORPORATION Address: 1-1, Showa-cho, Kariya-shi, Aichi-ken, 448-8661 Japan UWB Operation frequency: CH5: 6240.0 - 6739.2 MHz. CH9: 7737.6 - 8236.8 MHz. Maximum output power: -41.3 dBm/MHz or less Key system Manufacturer: DENSO CORPORATION Address: 1-1, Showa-cho, Kariya-shi, Aichi-ken, 448-8661 Japan Bluetooth Operation frequency: 2402 - 2480 MHz. Maximum output power: 0 dBm or less NFC Operation frequency: 13.56 MHz Qi Operation frequency: 110 - 205 kHz Hereby, DENSO CORPORATION declares that the radio equipment type is in compliance with Directive 2014/53/EU. The full text of the EU declaration of conformity is available at the following internet address: https://contact-us.denso.com/form/global/en/contact-us/doc/ [https://contact-us.denso.com/form/global/en/contact-us/doc/] DENSO CORPORATION vakuuttaa, että radiolaitetyyppi on direktiivin 2014/53/EU mukainen. EU-vaatustenmukaisuusvakuutuksen täysimittainen teksti on saatavilla seuraavassa internetosoitteessa: https://contact-us.denso.com/form/global/en/contact-us/doc/ [https://contact-us.denso.com/form/global/en/contact-us/doc/] Hierbij verklaar ik, DENSO CORPORATION, dat het type radioapparatuur conform is met Richtlijn 2014/53/EU. De volledige tekst van de EU-conformiteitsverklaring kan worden geraadpleegd op het volgende internetadres: https://contact-us.denso.com/form/global/en/contact-us/doc/ [https://contact-us.denso.com/form/global/en/contact-us/doc/] Le soussigné, DENSO CORPORATION, déclare que l'équipement radioélectrique du type est conforme à la directive 2014/53/UE. Le texte complet de la déclaration UE de conformité est disponible à l'adresse internet suivante: https://contact-us.denso.com/form/global/en/contact-us/doc/ [https://contact-us.denso.com/form/global/en/contact-us/doc/] Härmed försäkrar DENSO CORPORATION att denna typ av radioutrustning överensstämmer med direktiv 2014/53/EU. Den fullständiga texten till EU-försäkran om överensstämmelse finns på följande webbadress: https://contact-us.denso.com/form/global/en/contact-us/doc/ [https://contact-us.denso.com/form/global/en/contact-us/doc/] Hermed erklærer DENSO CORPORATION, at radioudstyrstypen er i overensstemmelse med direktiv 2014/53/EU. EU-overensstemmelseserklæringens fulde tekst kan findes på følgende internetadresse: https://contact-us.denso.com/form/global/en/contact-us/doc/ [https://contact-us.denso.com/form/global/en/contact-us/doc/] Hiermit erklärt DENSO CORPORATION, dass der Funkanlagentyp der Richtlinie 2014/53/EU entspricht. Der vollständige Text der EU-Konformitätserklärung ist unter der folgenden Internetadresse verfügbar: https://contact-us.denso.com/form/global/en/contact-us/doc/ [https://contact-us.denso.com/form/global/en/contact-us/doc/] Με την παρούσα ο/η DENSO CORPORATION, δηλώνει ότι ο ραδιοεξοπλισμός πληροί την οδηγία 2014/53/ΕΕ. Το πλήρες κείμενο της δήλωσης συμμόρφωσης ΕΕ διατίθεται στην ακόλουθη ιστοσελίδα στο διαδίκτυο: https://contact-us.denso.com/form/global/en/contact-us/doc/ [https://contact-us.denso.com/form/global/en/contact-us/doc/] Il fabbricante, DENSO CORPORATION, dichiara che il tipo di apparecchiatura radio è conforme alla direttiva 2014/53/UE. Il testo completo della dichiarazione di conformità UE è disponibile al seguente indirizzo Internet: https://contact-us.denso.com/form/global/en/contact-us/doc/ [https://contact-us.denso.com/form/global/en/contact-us/doc/] Por la presente, DENSO CORPORATION declara que el tipo de equipo radioeléctrico es conforme con la Directiva 2014/53/UE. El texto completo de la declaración UE de conformidad está disponible en la dirección Internet siguiente: https://contact-us.denso.com/form/global/en/contact-us/doc/ [https://contact-us.denso.com/form/global/en/contact-us/doc/] O(a) abaixo assinado(a) DENSO CORPORATION declara que o presente tipo de equipamento de rádio está em conformidade com a Diretiva 2014/53/UE. O texto integral da declaração de conformidade está disponível no seguinte endereço de Internet: https://c</p>	

The content of this manual represents the status of the user manual at the time of printing and may not be completely valid in future instances. For more information refer to the first page for the complete disclaimer note.

Country/Region	Homologation type	Compliance	Label
		<p>contact-us.denso.com/form/global/en/contact-us/doc/ [https://contact-us.denso.com/form/global/en/contact-us/doc/]</p> <p>B'dan, DENSO CORPORATION, niddikjara li dan it-tip ta' tagħmir tar-radju huwa konformi mad-Direttiva 2014/53/UE. It-test kollu tad-dikjarazzjoni ta' konformità tal-UE huwa disponibbli f'dan l-indirizz tal-Internet li ġej: https://contact-us.denso.com/form/global/en/contact-us/doc/ [https://contact-us.denso.com/form/global/en/contact-us/doc/]</p> <p>Käesolevaga deklareerib DENSO CORPORATION, et käesolev raadioseadmee tüüp vastab direktiivi 2014/53/EL nõuetele. ELi vastavusdeklaratsiooni täielik tekst on kättesaadav järgmisel internetiaadressil: https://contact-us.denso.com/form/global/en/contact-us/doc/ [https://contact-us.denso.com/form/global/en/contact-us/doc/]</p> <p>DENSO CORPORATION igazolja, hogy a típusú rádióberendezés megfelel a 2014/53/EU irányelvnek. Az EU-megfelelőségi nyilatkozat teljes szövege elérhető a következő internetes címen: https://contact-us.denso.com/form/global/en/contact-us/doc/ [https://contact-us.denso.com/form/global/en/contact-us/doc/]</p> <p>Me aně tě kěsajet deklarati, subjekti DENSO CORPORATION deklarati se pajsjet radio eshtë në përputhje me këtë rregull teknik për pajsjet radio dhe fundore të komunikimeve elektronike. Teksti i plotë i Deklaratës së Konformitetit eshtë i disponueshëm në adresën e mëposhtme të internetit: https://contact-us.denso.com/form/global/en/contact-us/doc/ [https://contact-us.denso.com/form/global/en/contact-us/doc/]</p> <p>Prin prezenta, DENSO CORPORATION declară că tipul de echipamente radio este în conformitate cu Reglementarea tehnică „Punerea la dispoziție pe piață a echipamentelor radio”. Textul integral al declarației de conformitate este disponibil la următoarea adresă de Internet: https://contact-us.denso.com/form/global/en/contact-us/doc/ [https://contact-us.denso.com/form/global/en/contact-us/doc/]</p> <p>DENSO CORPORATION tímto vyhlasuje, že rádiové zariadenie typu je v súlade so smernicou 2014/53/EÚ. Úplné EÚ vyhlásenie o zhode je k dispozícii na tejto internetovej adrese: https://contact-us.denso.com/form/global/en/contact-us/doc/ [https://contact-us.denso.com/form/global/en/contact-us/doc/]</p> <p>Tímto DENSO CORPORATION prohlašuje, že typ rádiového zařízení je v souladu se směrnici 2014/53/EU. Úplné znění EU prohlášení o shodě je k dispozici na této internetové adrese: https://contact-us.denso.com/form/global/en/contact-us/doc/ [https://contact-us.denso.com/form/global/en/contact-us/doc/]</p> <p>DENSO CORPORATION potrjuje, da je tip radijske opreme skladen z Direktivo 2014/53/EU. Celotno besedilo izjave EU o skladnosti je na voljo na naslednjem spletnem naslovu: https://contact-us.denso.com/form/global/en/contact-us/doc/ [https://contact-us.denso.com/form/global/en/contact-us/doc/]</p> <p>Aš, DENSO CORPORATION, patvirtinu, kad radijo įrenginių tipas atitinka Direktyvą 2014/53/ES. Visas ES atitikties deklaracijos tekstas prieinamas šiuo interneto adresu: https://contact-us.denso.com/form/global/en/contact-us/doc/ [https://contact-us.denso.com/form/global/en/contact-us/doc/]</p> <p>Ar šo DENSO CORPORATION deklarē, ka radioiekārta atbilst Direktīvai 2014/53/ES. Pilns ES atbilstības deklarācijas teksts ir pieejams šādā interneta vietnē: https://contact-us.denso.com/form/global/en/contact-us/doc/ [https://contact-us.denso.com/form/global/en/contact-us/doc/]</p> <p>DENSO CORPORATION niniejszym oświadcza, że typ urządzenia radiowego jest zgodny z dyrektywą 2014/53/UE. Pełny tekst deklaracji zgodności UE jest dostępny pod następującym adresem internetowym: https://contact-us.denso.com/form/global/en/contact-us/doc/ [https://contact-us.denso.com/form/global/en/contact-us/doc/]</p> <p>Hér með lýsir DENSO CORPORATION yfir því að er í samræmi við grunnkröfur og aðrar kröfur, sem gerðar eru í tilskipun 2014/53/EU. Samræmisýfirlýsing er einnig aðgengileg á eftirfarandi vefslóð: https://contact-us.denso.com/form/global/en/contact-us/doc/ [https://contact-us.denso.com/form/global/en/contact-us/doc/]</p> <p>DENSO CORPORATION erklærer at er i overensstemmelse med direktiv 2014/53/EU. Samsvarserklæringen i fulltekst er tilgjengelig på følgende internettdresse: https://contact-us.denso.com/form/global/en/contact-us/doc/ [https://contact-us.denso.com/form/global/en/contact-us/doc/]</p> <p>С настоящото DENSO CORPORATION декларира, че този тип радиосъоръжение е в съответствие с Директива 2014/53/ЕС. Цялостният текст на ЕС декларацията за съответствие може да се намери на следния интернет адрес: https://contact-us.denso.com/form/global/en/contact-us/doc/ [https://contact-us.denso.com/form/global/en/contact-us/doc/]</p> <p>DENSO CORPORATION ovime izjavljuje da je radijska oprema tipa u skladu s Direktivom 2014/53/EU. Cjeloviti tekst EU izjave o skladnosti dostupan je na sljedećoj internetskoj adresi: https://contact-us.denso.com/form/global/en/contact-us/doc/ [https://contact-us.denso.com/form/global/en/contact-us/doc/]</p>	

Country/Region	Homologation type	Compliance	Label
		<p>Овиме, DENSO CORPORATION изјављује да је радио опрема тип усаглашена са Директивом 2014/53/EU. Цео текст ЕУ декларације о усаглашености доступан је на следећој интернет адреси: https://contact-us.denso.com/form/global/en/contact-us/doc/ [https://contact-us.denso.com/form/global/en/contact-us/doc/]</p> <p>Amb aquest document, DENSO CORPORATION declara que el tipus d'equipament radioelèctric es conforme a la Directiva 2014/53/UE. El text complet de la declaració UE de conformitat està disponible en la següent adreça d'Internet: https://contact-us.denso.com/form/global/en/contact-us/doc/ [https://contact-us.denso.com/form/global/en/contact-us/doc/]</p> <p>İşbu belge; DENSO CORPORATION telsiz ekipmanı tipinin 2014/53/AB sayılı Direktif'e uygun olduğunu beyan eder. AB uygunluk beyanının tam metni aşağıdaki internet adresinde mevcuttur: https://contact-us.denso.com/form/global/en/contact-us/doc/ [https://contact-us.denso.com/form/global/en/contact-us/doc/]</p>	
Georgia	WAN00, YBN00	<p>გადამცემი მოდელი: WAN00 მუშაობის სიხშირე: CH5: 6240.0 - 6739.2 MHz CH9: 7737.6 - 8236.8 MHz. მაქსიმალური გამომავალი სიმძლავრე: -41.3 dBm/MHz ან ნაკლები გადამცემი მოდელი: YBN00 UWB მაქსიმალური გამომავალი სიმძლავრე: -41.3 dBm/MHz ან ნაკლები Bluetooth მუშაობის სიხშირე: 2402 - 2480 MHz მაქსიმალური გამომავალი სიმძლავრე: 0 dBm ან ნაკლები NFC მუშაობის სიხშირე: 13.56 MHz Qi მუშაობის სიხშირე: 110 - 205 kHz მუშაობის სიხშირე: CH5: 6240.0 - 6739.2 MHz CH9: 7737.6 - 8236.8 MHz. მაქსიმალური გამომავალი სიმძლავრე: -41.3 dBm/MHz ან ნაკლები მწარმოებელი: DENSO CORPORATION ათები: 1-1, Showa-cho, Kariya-shi, Aichi-ken, 448-8661 წინამდებარე დეკლარაციით, DENSO CORPORATION ვაცხადებ, რომ რადიომონწყობილობის ტიპი შეესაბამება რადიომონწყობილობის შესახებ ტექნიკური რეგლამენტის მოთხოვნებს. შესაბამისობის დეკლარაციის სრული ტექსტი ხელმისაწვდომია შემდეგ ინტერნეტმისამართზე: https://contact-us.denso.com/form/global/en/contact-us/doc/ [https://contact-us.denso.com/form/global/en/contact-us/doc/]</p>	
Israel	WAN00, YBN00	<p>חל איסור לבצע פעולות במכשיר שיש בהן כדי לשנות את תכונותיו האלחוטיות של המכשיר, ובכלל זה שינוי תוכנה, החלפת אנטנה מקורית או הוספת אפסוח לחיבור לאנטנה חיצונית, בלא קבלת אישור משרד התקשורת, בשל החשש הפורעות אלחוטיות.</p> <p>DENSO : סימן רשום ראה מוצר : שנת ייצור קורא : מוצר UWB)UWB) WAN00 : דגם ראה מוצר : ארץ ייצור חנת המפרים של המוצר : מוצר (RFK) YBN00 : דגם ראה מוצר : ארץ ייצור</p>	

Country/Region	Homologation type	Compliance	Label
United Arab Emirates	YBN00	UAE: ER17320/23 DENSO YBN00	
Ukraine	WAN00, YBN00	<p>UWB Reader (UWBR): модель: WAN00 смугу радіочастот: CH5: 6240.0 - 6739.2 МГц, CH9: 7737.6 - 8236.8 МГц максимальну потужність випромінювання: -41.3 дБм/МГц або менше Radio Frequency Key (RFK): модель: YBN00 UWB смугу радіочастот: CH5: 6240.0 - 6739.2 МГц, CH9: 7737.6 - 8236.8 МГц максимальну потужність випромінювання: -41.3 дБм/МГц або менше Bluetooth смугу радіочастот: 2402 - 2480 МГц максимальну потужність випромінювання: 0 дБм/МГц або менше NFC смугу радіочастот: 13.56 МГц Qi смугу радіочастот: 110 - 205 кГц виробник: DENSO CORPORATION адреса: 1-1, Showa-cho, Kariya-shi, Aichi-ken, 448-8661, Japan справжнім DENSO CORPORATION заявляє, що тип радіообладнання відповідає Технічному регламенту радіообладнання; повний текст декларації про відповідність доступний на веб-сайті за такою адресою: https://www.denso.com/global/en/contact-us/doc/ [https://www.denso.com/global/en/contact-us/doc/]</p>	 UA RF: 3DENS WAN00  UA RF: 3DENS YBN00
United Kingdom	WAN00, YBN00	<p>UWB Reader (UWBR) Model: WAN00 Manufacturer: DENSO CORPORATION Address: 1-1, Showa-cho, Kariya-shi, Aichi-ken, 448-8661 Japan Operation frequency: CH5: 6240.0 - 6739.2 MHz. CH9: 7737.6 - 8236.8 MHz. Maximum output power: -41.3 dBm/MHz or less Radio Frequency Key (RFK) Model: YBN00 Hereby, DENSO CORPORATION declares that the radio equipment type is in compliance with Directive 2014/53/EU. The full text of the EU declaration of conformity is available at the following internet address: https://www.denso.com/global/en/contact-us/doc/ [https://www.denso.com/global/en/contact-us/doc/] Hereby, DENSO CORPORATION declares that the radio equipment type is in compliance with the relevant statutory requirements. The full text of the UK declaration of conformity is available at the following internet address: https://www.denso.com/global/en/contact-us/doc/ [https://www.denso.com/global/en/contact-us/doc/] Manufacturer: DENSO CORPORATION Address: 1-1, Showa-cho, Kariya-shi, Aichi-ken, 448-8661 Japan UWB Operation frequency: CH5: 6240.0 - 6739.2 MHz. CH9: 7737.6 - 8236.8 MHz. Maximum output power: -41.3 dBm/MHz or less Key system Manufacturer: DENSO CORPORATION Address: 1-1, Showa-cho, Kariya-shi, Aichi-ken, 448-8661 Japan Bluetooth Operation frequency: 2402 - 2480 MHz. Maximum output power: 0 dBm or less NFC Operation frequency: 13.56 MHz Qi Operation frequency: 110 - 205 kHz</p>	

Country/Region	Homologation type	Compliance	Label
United States, Puerto Rico	WAN00, YBN00	<p>UWB Reader</p> <p>NOTE: This device complies with part 15 of the FCC Rules. Operation is subject to the following two conditions: (1) This device may not cause harmful interference, and (2) this device must accept any interference received, including interference that may cause undesired operation.</p> <p>Radio Frequency Key</p> <p>NOTE: This device complies with part 15 and part 18 of the FCC Rules. Operation is subject to the following two conditions: (1) This device may not cause harmful interference, and (2) this device must accept any interference received, including interference that may cause undesired operation.</p> <p>This equipment has been tested and found to comply with the limits for a wireless power charger, pursuant to part 18 of the FCC Rules. This equipment generates, uses and can radiate radio frequency energy and, if not installed and used in accordance with the instructions, may cause harmful interference to radio communications. However, there is no guarantee that interference will not occur in a particular installation.</p> <p>If this equipment does cause harmful interference to radio communications, which can be determined by turning the equipment off and on, the user is encouraged to try to correct the interference by one or more of the following measures:</p> <ul style="list-style-type: none"> • Reorient or relocate the receiving antenna. • Increase the separation between the equipment and receiver. • Connect the equipment into an outlet on a circuit different from that to which the receiver is connected. <p>FCC Warning: Changes or modifications not expressly approved by the party responsible for compliance could void the user's authority to operate the equipment.</p> <p>Radiofrequency radiation exposure information: This equipment complies with FCC radiation exposure limits set forth for an uncontrolled environment and meets the FCC radio frequency (RF) Exposure Guidelines as this equipment has very low levels of RF energy.</p>	
Vietnam	WAN00, YBN00	CÔNG TY TNHH SWEDEN AUTO. B2100176	
Zambia	WAN00, YBN00	<p>WAN00 ZMB/ZICTA/TA/2021/12/9</p> <p>YBN00 ZMB/ZICTA/TA/2023/3/4</p>	

Safety standard for RFK

Country/Region**EU Accession State****English**

Do not expose to excessive heat, such as sunshine, fire, etc., or low temperatures. This may cause explosion or leakage of flammable liquids or gases during use, storage, transportation or disposal. Do not throw battery into fire or hot stove, do not crush or cut mechanically as this may cause explosion. Do not expose the battery to extremely low air pressure at high altitude, which may cause explosion or leakage of flammable liquids or gases.

Swedish

Får inte exponeras för överdriven värme, t.ex. solsken, eld, etc., eller låga temperaturer eftersom detta kan orsaka explosion eller läckage av brandfarliga vätskor eller gaser under användning, lagring, transport och bortskaftande. Kasta inte batteriet i eld eller en het ugn, krossa eller skär det inte mekaniskt eftersom detta kan orsaka explosion. Akkumulatorm får inte utsättas för extremt lågt lufttryck på hög höjd eftersom detta kan orsaka explosion eller läckage av brandfarliga vätskor eller gaser.

Finnish

Älä altista liialliselle kuumuudelle, kuten auringonpaisteelle, tulelle tai vastaavalle; tai alhaiselle lämpötilalle, joka voi aiheuttaa räjähdyksen tai syttyvän nesteen tai kaasun vuotamisen käytön, varastoinnin tai kuljetuksen tai hävittämisen aikana. Älä heitä akkua tuleen tai kuumaan uuniin äläkä purista tai leikkaa akkua mekaanisesti, mikä voi aiheuttaa räjähdyksen. Älä altista äärimmäisen alhaiselle ilmanpaineelle suuressa korkeudessa, mikä voi aiheuttaa räjähdyksen tai syttyvän nesteen tai kaasun vuotamisen.

Danish

Må ikke udsættes for lave temperaturer eller overdreven varme såsom solskin, ild osv., da dette kan forårsage eksplosion eller lækage af brændbare væsker eller gasser under brug, opbevaring, transport og bortskaftelse. Batteriet må ikke smides i ild eller i en varm ovn, det må ikke knuses eller skæres mekanisk, da dette kan forårsage eksplosion. Akkumulatoren må ikke udsættes for ekstremt lavt lufttryk i stor højde, da dette kan forårsage eksplosion eller lækage af brændbare væsker eller gasser.

Dutch

Niet blootstellen aan overmatige hitte zoals zonneschijn, vuur, enz. of lage temperaturen. Dit kan explosie of lekkage van brandbare vloeistoffen of gassen veroorzaken tijdens gebruik, opslag, vervoer of verwijdering. Gooi de batterij niet in het vuur of in een hete oven, plet of knip de batterij niet mechanisch, want dat kan een explosie veroorzaken. Stel de batterij niet bloot aan extreem lage luchtdruk op grote hoogten, wat explosie of lekkage van brandbare vloeistoffen of gassen kan veroorzaken.

German

Nicht übermäßiger Hitze, wie Sonnenschein, Feuer etc., sowie niedrigen Temperaturen aussetzen. Dieses kann zur Explosion oder zum Austreten von entflammenden Flüssigkeiten oder Gasen während des Gebrauchs, der Lagerung, des Transports oder der Entsorgung führen. Batterie nicht ins Feuer oder in einen heißen Ofen werfen, nicht mechanisch zerdrücken oder zerschneiden, da dies zur Explosion führen kann. Den Akku nicht extrem niedrigem Luftdruck in großer Höhe aussetzen, was zur Explosion oder zum Austreten von brennbaren Flüssigkeiten oder Gasen führen kann.

French

Ne pas exposer à une chaleur excessive, comme la lumière du soleil, le feu, etc. ou à de basses températures. Cela peut entraîner une explosion ou une fuite de liquides ou de gaz inflammables pendant l'utilisation, le stockage, le transport ou l'élimination. Ne pas jeter la batterie dans le feu ou dans un four chaud, ne pas l'écraser ou la couper mécaniquement, car cela pourrait entraîner une explosion. Ne pas exposer l'accumulateur à une pression atmosphérique extrêmement faible en haute altitude, ce qui pourrait entraîner une explosion ou une fuite de liquides ou de gaz inflammables.

Greek

Ο φορτιστής να μη εκτίθεται σε υπερβολική ζέση, όπως στον ήλιο, στη φωτιά κλπ., αλλά ούτε σε χαμηλές θερμοκρασίες. Τουτό μπορεί να επιφέρει έκρηξη ή διαρροή φλεγόμενων υγρών ή αερίων κατά τη διάρκεια της χρήσης, της αποθήκευσης, της μεταφοράς ή της διάθεσης απορριμμάτων. Μη ρίχνετε μπαταρίες στη φωτιά ή σε αναμμένο φούρνο, μη συμπιέζετε και μη κόβετε αυτές κατά μηχανικό τρόπο, επειδή τούτο μπορεί να επιφέρει ανάφλεξη μέχρι και έκρηξη. Ο φορτιστής να μη εκτίθεται σε υπερβολικά χαμηλή ατμοσφαιρική πίεση σε μεγάλο ύψος, επειδή τούτο μπορεί να προκαλέσει έκρηξη ή διαρροή φλεγόμενων υγρών ή αερίων.

Slovak

Nevystavujte batériu nadmernému teplu, napríklad slnečnému žiareniu, ohňu atď., ani nízkym teplotám. To môže spôsobiť výbuch alebo únik horľavých kvapalín alebo plynov počas používania, skladovania, prepravy alebo likvidácie. Batériu nevhadzujte do ohňa alebo horúcej pece (rúry), nedrťte ju ani mechanicky nerozrezávajte, pretože to môže spôsobiť výbuch. Nevystavujte batériu extrémne nízkemu tlaku vzduchu vo vysokých nadmorských výškach, ktorý môže spôsobiť výbuch alebo únik horľavých kvapalín alebo plynov.

Latvian

Nepakļaujiet pārmērīgam karstumam, piemēram, saules, uguns iedarbībai vai tamlīdzīgi; vai zemai temperatūrai, kas lietošanas, uzglabāšanas, transportēšanas vai izmantošanas laikā var izraisīt eksploziju vai uzliesmojoša šķidrums, gāzes noplūdi. Akumulatora likšana ugunī, karstā cepeškrāsnī vai mehāniska tā saspišana vai griešana var izraisīt eksploziju. Nepakļaujiet ekstrēmi zemam gaisa spiedienam lielā augstumā, kas var izraisīt eksploziju vai uzliesmojoša šķidrums, gāzes noplūdi.

Czech

Nevystavovat nadměrnému teplu jako je sluneční záření, oheň nebo podobným vlivům, či nízkým teplotám, které by mohly způsobit výbuch, únik hořlavé kapaliny nebo plynu během používání, skladování nebo přepravy či likvidace. Nevyhazovat baterii do ohně nebo horkých kamen, ani ji mechanicky nedrtit nebo nerozřezávat, což může vést k výbuchu. Nevystavovat baterii extrémně nízkému tlaku vzduchu ve velké nadmořské výšce, který může mít za následek výbuch nebo únik hořlavé kapaliny či plynu.

Polish

Nie wystawiać na działanie nadmiernego ciepła, takiego jak światło słoneczne, ogień itp.; lub niską temperaturą, która może spowodować wybuch lub wyciek łatwopalnej cieczy lub gazu podczas użytkowania, przechowywania, transportu lub utylizacji. Nie wrzucać baterii do ognia lub gorącego piekarnika, ani nie poddawać mechanicznemu kruszeniu lub cięciu baterii, co może spowodować wybuch. Nie jest przeznaczona do ekstremalnie niskich ciśnień powietrza na dużej wysokości, które może spowodować wybuch lub wyciek łatwopalnej cieczy lub gazu.

Slovenian

Ne izpostavljajte niti visokim temperaturam kot je sonce, ogenj in podobno niti nizkim temperaturam, ker lahko pride do eksplozije in uhajanja vnetljive tekočine ali plina med uporabo, shranjevanjem, prevozom ali odlaganjem. Baterije ne odlagajte v ogenj ali vročo pečico, ne je stiskati ali rezati, ker lahko eksplodira. Ne izpostavljajte izjemno nizkemu zračnemu tlaku na visoki nadmorski višini, ker lahko eksplodira ali pa povzroči uhajanje vnetljive tekočine ali plina.

Icelandic

Látið ekki nærri miklum hita svo sem sólskini, eldi eða álíka; eða lágu hitastigi. Það getur valdið sprengingu eða leka á eldfimum vökva eða gasi við notkun, geymslu, flutning eða förgun. Fargið ekki rafhlöðunni með eldi, varast skal að kremja eða skera, það getur valdið sprengingu. Látið ekki vera í

Country/Region

mjög lágum loftþrýstingi í mikilli hæð. Það getur valdið sprengingu eða leka á eldfimum vökva eða gasi.

Lithuanian

Nelaikykite per didelio karščio, pvz., saulės, ugnies ar pan.; arba žema temperatūra, dėl kurios naudojimo, sandėliavimo, transportavimo ar šalinimo metu gali įvykti sproginimas arba degių skysčių ar dujų nuotėkis. Nemeskite akumulatoriaus į ugnį ar įkaitusią orkaitę ir nemeskite akumulatoriaus mechanškai sutraiškinti ar įpjauti, nes tai gali sukelti sproginimą. Nelaikykite labai žemo oro slėgio dideliame aukštyje, nes gali įvykti sproginimas arba degių skysčių ar dujų nuotėkis.

Italian

Non esporre a calore eccessivo come luce solare, fuoco o simili, o a bassa temperatura poiché possono provocare un'esplosione o la fuoriuscita di liquidi o gas infiammabili durante l'uso, lo stoccaggio o il trasporto o lo smaltimento. Non smaltire una batteria nel fuoco o in un forno caldo, né schiacciare o tagliare meccanicamente una batteria, può provocare un'esplosione. Non sottoporre ad una pressione dell'aria estremamente bassa ad alta quota, poiché potrebbe provocare un'esplosione o la fuoriuscita di liquidi o gas infiammabili.

Estonian

Ärge jätke toodet liigse kuumuse (nt otsese päikesekiirguse, leegi vms) või madala temperatuuri mõju kätte. See võib lõppeda kasutamise, ladustamise, transpordi või kõrvaldamise ajal tuleohtliku vedeliku või gaasi plahvatuse või lekkega. Ärge visake akut tulle ega muljuge või lõigake seda, sest see võib põhjustada plahvatuse. Ärge viige suurele kõrgusele või väga madala õhurõhuga keskkonda. See võib lõppeda tuleohtliku vedeliku või gaasi plahvatuse või lekkega.

Spanish

No exponga a calor excesivo como por ejemplo exposición directa al sol, fuego o similar; ni tampoco a bajas temperaturas, que puedan provocar una explosión o la fuga de líquidos o gases inflamables durante el uso, almacenamiento, transporte o desecho de la batería. No arroje la batería al fuego o a un horno caliente, ni la aplaste o corte mecánicamente, ya que puede producir explotar. No someta la batería a una presión de aire extremadamente baja a causa de una gran altitud ya que puede provocar una explosión o la fuga de líquido o gas inflamable.

Hungarian

Ne tegye ki túlzott hőhatásnak, például napsütésnek, tűznek vagy hasonlónak; vagy alacsony hőmérsékletnek ami robbanást vagy gyűlékony folyadék vagy gáz szivárgását okozhatja használat, tárolás, szállítás vagy ártalmatlanítás során. Ne dobja az akkumulátort tűzbe vagy forró sütőbe, és ne tegye mechanikusan összetörni vagy vágni az akkumulátort, mert ez robbanást okozhat. Ne tegye ki rendkívül alacsony légnyomásnak nagy magasságban, ami robbanást vagy gyűlékony folyadék vagy gáz szivárgását okozhatja.

Portuguese

Não expor ao calor excessivo, como sol, fogo, etc., ou baixas temperaturas. Isto pode resultar na explosão ou vazamento de líquidos ou gases inflamáveis durante a utilização, armazenamento, transporte ou eliminação. Não atirar a bateria ao fogo ou forno quente, não a esmagar ou cortar mecanicamente, pois isto pode causar uma explosão. Não expor o acumulador a pressão de ar extremamente baixa a grande altitude, o que pode causar explosão ou vazamento de líquidos ou gases inflamáveis.

Bulgarian

Да не се излага на прекомерна топлина, като слънце, огън или подобни; или на ниска температура. В противен случай това може да доведе до избухване или до изтичане на запалими течности или газове по време на употреба, складиране, преносване или изхвърляне. Не изхвърляйте батерията в огън, нито се опитвайте да я смачкате или срежете. Това може да доведе до избухване. Да не се излага на прекомерно ниско атмосферно налягане на висока надморска височина, което може да доведе до избухване или теч на запалими течности или газове.

Maltese

Tesponix għal sħana eċċessiva bħal xemx, nar jew simili; jew temperatura baxxa, li tista 'tirriżulta fi splużjoni jew it-tnixxija ta' likwidu jew gass li jaqbad waqt l-użu, il-ħażna jew it-trasport jew ir-rimi. Tarmix batterija fin-nar jew f'forn jaħraq, jew tagħti tgħaffiġ jew qtugh mekkaniku ta' batterija, li jista' jirriżulta fi splużjoni. Tghamix suġġett għal pressjoni ta 'arja estremament baxxa f'altitudni għolja li tista' tirriżulta fi splużjoni jew tnixxija ta 'likwidu jew gass li jaqbad.

Romanian

Nu expuneți la căldură excesivă, cum ar fi soarele, focul sau condiții asemanătoare; sau temperatură scăzută, care poate cauza o explozie sau scurgerea de lichid sau gaz inflamabil în timpul utilizării, depozitării, transportului sau eliminării. Nu aruncați bateria în foc sau într-un cuptor încins și nu provocați zdrobirea sau tăierea mecanică a bateriei, care poate duce la explozie. Nu expuneți la presiune extrem de scăzută a aerului la altitudine mare, care poate duce la explozie sau la scurgerea lichidului sau emiterea de gaz inflamabil.

Croatian

Nemojte izlagati visokim temperaturama poput sunca, vatre ili slično, niti niskim temperaturama, koje mogu uzrokovati eksploziju i curenje zapaljive tekućine ili plina tijekom upotrebe, skladištenja, transporta ili odlaganja. Ne odlagati baterije u vatru ili vruću pećnicu, nemojte je stiskati ili rezati, jer može dovesti do eksplozije. Ne izlažite baterije ekstremno niskom tlaku zraka na velikoj nadmorskoj visini, jer može eksplodirati ili izazvati curenje zapaljive tekućine ili plina.

Albanian

Mos e ekspozoni ndaj nxehtësisë së tepërt si rrezet e diellit, zjarrit etj. dhe temperaturave të ulëta. Kjo mund të shkaktoj një shpërthim ose rrjedhje të lëngut ose gazit të ndezshëm gjatë përdorimit, ruajtjes, transportit ose asgjësimit. Mos e hidhni baterinë në zjarr ose në furrë të nxehtë, mos e shtypni ose preni mekanikisht pasi kjo mund të shkaktoj një shpërthim. Mos e ekspozoni baterinë ndaj presionit jashtëzakonisht të ulët të ajrit në lartësi të madhe, gjë që mund të shkaktoj një shpërthim ose rrjedhje të lëngut ose gazit të ndezshëm.

Serbian

Nemojte izložiti izrazito visokim temperaturama (sunčevi zraci, vatra, ili slično) ili izrazito niskim temperaturama. Može doći do eksplozije ili curenja zapaljive tečnosti ili gasa prilikom korišćenja, skladištenja, i otpada. Nemojte odstraniti bateriju u vatru, nemojte je drobiti ili seći, jer može doći do eksplozije. Nemojte izložiti ekstremno niskom vazдушnom pritisku na velikim visinama. Može doći do eksplozije ili curenja zapaljive tečnosti ili gasa.

Catalan

No exposi a una calor excessiva com ara exposició directa al sol, foc o similar; ni tampoc a baixes temperatures, que puguin provocar una explosió o la fuga de líquids o gasos inflamables durant l'ús, l'emmagatzematge, el transport o el rebuig de la bateria. No llenci la bateria al foc o a un forn calent, ni l'aixafi o la talli mecànicament, ja que podria explotar. No sotmeti la bateria a una pressió d'aire extremadament baixa a causa d'una gran altitud, ja que podria provocar una explosió o la fuga de líquid o gas inflamable.

Turkish

Country/Region	
	Güneş ışığı, ateş vb. aşırı ısı ve düşük sıcaklıklara maruz bırakmayınız. Bu durum; kullanım, depolama, nakliye veya imha sırasında yanıcı sıvı veya gazın patlamasına veya sızıntısına neden olabilir. Pili ateşe veya sıcak fırına atmayınız, ayrıca patlamaya neden olabileceğinden mekanik olarak ezmeyin veya kesmeyiniz. Bataryayı yüksek irtifada düşük hava basıncına maruz bırakmayınız, bu durum da patlamaya veya yanıcı sıvı veya gaz sızıntısına neden olabilir.
Georgia	არ გაუშვათ ზედმეტი სიცხე, როგორცაა მზე, ხანძარი და ა.შ., ან დაბალ ტემპერატურაზე. ამან შეიძლება გამოიწვიოს აალებადი სითხეების ან აირების აფეთქება ან გაჟონვა გამოყენების, შენახვის, ტრანსპორტირებისა თუ განადგურების დროს. არ ჩააგდოთ ბატარეა ცეცხლში ან ცხელ ლუმელში, არ დაამტვრიოთ ან გაჭრათ მექანიკურად, რადგან ამან შეიძლება აფეთქება გამოიწვიოს. არ დაუშვათ ბატარეა ჰაერის უკიდურესად დაბალ წნევაზე მაღალ სიმაღლეზე, რამაც შეიძლება გამოიწვიოს აალებადი სითხეების ან აირების აფეთქება ან გაჟონვა.
United Kingdom	Do not expose to excessive heat, such as sunshine, fire, etc., or low temperatures. This may cause explosion or leakage of flammable liquids or gases during use, storage, transportation or disposal. Do not throw battery into fire or hot stove, do not crush or cut mechanically as this may cause explosion. Do not expose the battery to extremely low air pressure at high altitude, which may cause explosion or leakage of flammable liquids or gases.

Battery

Battery TYPE: CP1254 A4 WC

Manufacturer

- Manufacturer Name: VARTA Microbattery GmbH
- Trade Name: VARTA
- Address: VARTA-Platz 1, 73479 Elwangen, Germany
- URL: <https://www.varta-microbattery.com/en> [<https://www.varta-microbattery.com/en>]







Importer



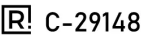





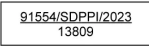
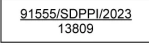
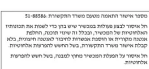
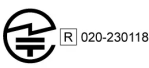

- Importer Name: Volvo Car Corporation
- Trade Name: VOLVO
- Address: 405 31 Göteborg, Sweden
- URL: [volvocars.com](https://www.volvocars.com) [<https://www.volvocars.com>]





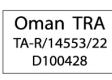

15.5.9. Certifications for radio and entertainment system

You can find the certifications and labels for the radio and entertainment system listed here.

Region	Labels and symbols	Specification
Argentina		C-29148
Australia		
Belarus		
Botswana		REGISTERED No: BOCRA/TA/2023/8267
Brazil		20252-23-10187 Atendimento à Regulamentação Anatel Este equipamento não tem direito à proteção contra interferência prejudicial e não pode causar interferência em sistemas devidamente autorizados. Este produto está homologado pela ANATEL, de acordo com os procedimentos regulamentados pela Resolução 242/2000, e atende aos requisitos técnicos aplicados. Para maiores informações, consulte o site da ANATEL www.anatel.gov.br
Brunei		DTA-022618
China		CMIIT ID: 2023DJ11659 [Placeholder text for Chinese regulatory information]
European Union (CE (RED))		Simplified EU declaration of conformity, radio Hereby, Aptiv Services Deutschland GmbH, 42367 Wuppertal, declares that DHU 1.0 is in compliance with Directive 2014/53/EU. The full text of the EU declaration of conformity is available at the following internet address: https://www.aptiv.com/automotive-homologation
Generic		<ul style="list-style-type: none"> • Product name: Display head unit • Model Name: DHU 1.0 • Manufacturer: Aptiv Services Deutschland GmbH, Am Technologiepark 1, 42119 Wuppertal Germany • Brand: Aptiv
Ghana		NCA APPROVED: 7EA-M1-163-SRD
India		ETA-SD-20221210313

Region	Labels and symbols	Specification
Indonesia (SDPPI)	<p>For display head units manufactured in China:</p>  <p>For display head units manufactured in Mexico:</p> 	
Israel		51-88586
Japan (Radio)		020-230118
Japan (Telecom)		D230032020
Malaysia	 	VOLVO CAR MANUFACTURING MALAYSIA SDN. BHD.: HIDF21000141 VOLVO CAR MALAYSIA SDN. BHD.: HIDF15000171
Mexico	<p>IFT: VOAPDH23-39393</p> 	IFT: VOAPDH23-39393 La operación de este equipo está sujeta a las siguientes dos condiciones: (1) Es posible que este equipo o dispositivo no cause interferencia perjudicial y (2) Este equipo o dispositivo debe aceptar cualquier interferencia, incluyendo la que pueda causar su operación no deseada. Model Name: DHU 1.0 Brand: Aptiv
Morocco		MR 00035090 ANRT 2022
New Zealand		
Oman		TA-R/14553/22 D100428
Paraguay		NR: 2022-10-I-0659 Importer: Rieder & Cia. Address: Avda España c/ Dr. Morra. Local phone number of the importer/retailer in Paraguay: +595 021-2190 700
Philippines		ESD-RCE-2231790
Russia (EAC)		

Region	Labels and symbols	Specification
United States of America and Canada		<p>FCC ID: LTQDHU1 IC: 3659A-DHU1 FCC § 15.19 Labelling requirements</p> <p>This device complies with part 15 of the FCC Rules and ISSED license-exempt RSS standard(s). Operation is subject to the following two conditions: (1) This device may not cause harmful interference, and (2) this device must accept any interference received, including interference that may cause undesired operation.</p> <p>Le présent appareil est conforme aux CNR d'ISED applicables aux appareils radio exempts de licence. L'exploitation est autorisée aux deux conditions suivantes: (1) l'appareil ne doit pas produire de brouillage, et (2) l'utilisateur de l'appareil doit accepter tout brouillage radioélectrique subi, même si le brouillage est susceptible d'en compromettre le fonctionnement.</p> <p>FCC § 15.21 Information to user</p> <p>Changes or modifications not expressly approved by the party responsible for compliance could void the user's authority to operate the equipment. NOTE: THE MANUFACTURER IS NOT RESPONSIBLE FOR ANY RADIO OR TV INTERFERENCE CAUSED BY UNAUTHORIZED MODIFICATIONS TO THIS EQUIPMENT. SUCH MODIFICATIONS COULD VOID THE USER'S AUTHORITY TO OPERATE THE EQUIPMENT.</p> <p>RF Exposure Requirements</p> <p>This equipment complies with FCC RF radiation exposure and Industry Canada RSS-102 RF exposure limits set forth for an uncontrolled environment. This device and its antenna must not be co-located or operating in conjunction with any other antenna or transmitter. To comply with FCC RF exposure and Industry Canada RSS-102 RF exposure compliance requirements, this grant is applicable to only Mobile Configurations. The antennas used for this transmitter must be installed to provide a separation distance of at least 20 cm from all persons and must not be co-located or operating in conjunction with any other antenna or transmitter.</p> <p>Cet équipement est conforme aux limites d'exposition aux rayonnements énoncées pour un environnement non contrôlé et respecte les règles d'exposition aux fréquences radioélectriques (RF) CNR-102 de l'IC. Cet équipement doit être installé et utilisé en gardant une distance de 20 cm ou plus entre le radiateur et le corps humain (à l'exception des extrémités : mains, poignets, pieds et chevilles).</p>
Vietnam		<p>Name: BD CONSULTANT Code: A00282014</p>
Zambia		ZMB/ZICTA/TA/2022/10/39
Bluetooth		
Waste		

Frequency bands and output power for European Union CE (RED) certification

Application	Frequency	Maximum output power
FM	87.5-108 MHz	
DAB	174.0-240.0 MHz	
Bluetooth	2400-2483.5 MHz	4 dBm (2.5 mW)
Bluetooth Low Energy	2400-2483.5 MHz	5 dBm (3.2 mW)
WLAN 2.4 GHz	2400-2483.5 MHz	14 dBm (25 mW)
WLAN 5 GHz	5150-5250 MHz	14 dBm (25 mW)
WLAN 5 GHz	5725-5850 MHz	14 dBm (25 mW)

Information for Taiwan (BSMI) certification

□□□□: □□□□ (BT/WLAN)

The content of this manual represents the status of the user manual at the time of printing and may not be completely valid in future instances. For more information refer to the first page for the complete disclaimer note.

???: DHU 1.0

?: / ?

Connection points description and RoHS table for Taiwan (BSMI) certification

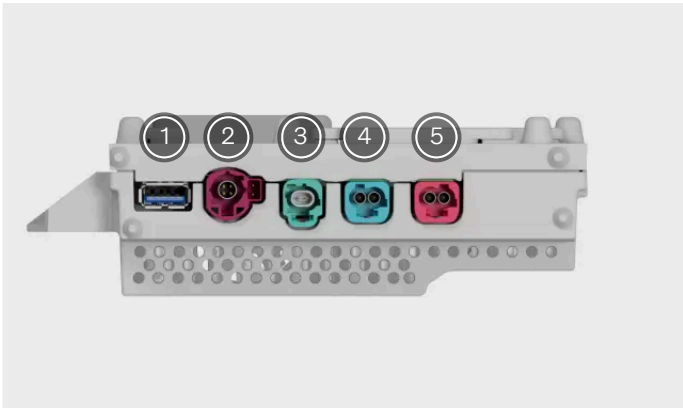

- ① USB Debug
- ② USB 2.0
- ③ ? (Ethernet)
- ④ ? (Center Display Connection)
- ⑤ ? (Parking Assistance Camera)

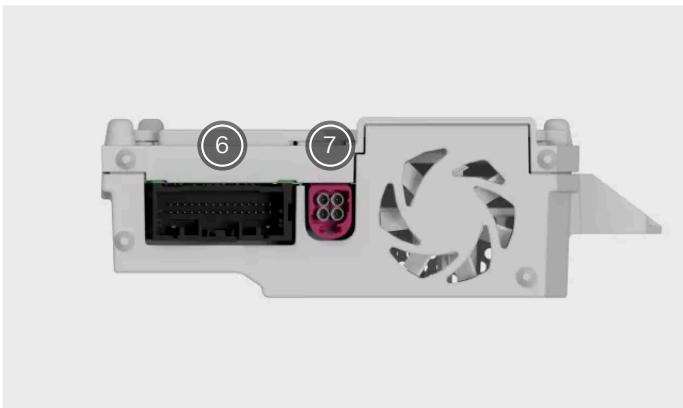

- ⑥ ? (Main Connector)
- ⑦ FM/DAB

RoHS table						
? (BT/WLAN) ? : DHU 1.0						
?	?					
	?(Pb)	?(Hg)	?(Cd)	?(Cr+6)	?(PBB)	?(PBDE)
?	-	o	o	o	o	o
?	-	o	o	o	o	o
?	-	o	o	o	o	o
?	o	o	o	o	o	o

1.0 wt % 0.01 wt %
2.2-2.5
3.2

15.5.10. Advanced air cleaning certification

Here you find the certification for the advanced air cleaning.

The Advanced air cleaner (Part numbers 31497530, 31497531) has been certified by the California air resource board (CARB). The product has been tested according to the following standards: Electrostatic Air Cleaners [UL 867:2011 Ed.5+R:16Aug2021] Electrostatic Air Cleaners [CSA C22.2#187:2020 Ed.5] This product complies with the maximum allowable concentration of ozone of 0.050 parts per million by volume (ppmv) in a 24-h period.



15.5.11. Electromagnetic compatibility compliance

The following text is related to the Electromagnetic Compatibility (EMC) compliance.

i Note

This equipment has been tested and found to comply with the limits for a Class B digital device, pursuant to part 15 of the FCC Rules. These limits are designed to provide reasonable protection against harmful interference in a residential installation. This equipment generates, uses and can radiate radio frequency energy and may cause harmful interference to radio communications if not installed and used in accordance with the instructions. However, there is no guarantee that interference will not occur in a particular installation. If this equipment does cause harmful interference to radio or television reception, which can be determined by turning the equipment off and on, the user is encouraged to try to correct the interference by one or more of the following measures:

- Reorient or relocate the receiving antenna.
- Increase the separation between the equipment and receiver.
- Connect the equipment into an outlet on a circuit different from the one to which the receiver is connected.
- Consult the retailer or an experienced radio/TV technician for help.

! Important

Changes or modifications made by the user not expressly approved by Volvo Cars could void the user's authority to operate the equipment.

15.6. Labels

Your vehicle has a number of labels that provide information about the vehicle and its use, such as specifications and warnings.

Warning label



Yellow signal panel with warning symbol.

Indicates a potentially hazardous situation which, if not avoided, could result in death or serious injury.

Notice label



Notice symbol in signal panel.

Indicates a hazardous situation which, if not avoided, could result in minor or moderate damage to property.

Information label



Label with no signal panel.

Indicates important information but no risk for personal injury or damage to property.

Note

Depicted labels

Labels depicted in this manual are generic representations of those found around your vehicle. The manual only contains their location and what kind of information they contain. Find the actual label for specific information about your vehicle.