

V90 2025 (24w46) User Manual

Version 2025-08-28

Disclaimer

Due to the dynamic nature of our software-based product, the content of this PDF represents the most up-to-date version of the user manual as of the time of printing. As we continuously update and improve our product, certain content may not reflect the most up-to-date information in a future instance. Therefore, we strongly recommend utilising the digital user manual app in your car's centre display for the most accurate and up-to-date information. You can also access information in the Volvo Cars mobile app.

Please note that if you choose to print the manual, we cannot guarantee the validity of the information in future instances, as updates may have occurred since the time of printing. To ensure the highest level of safety and optimal product usage, we strongly advise relying on the digital user manual, which can be easily accessed through your car's centre display.

This printable version is generic and does not correspond to your car. If there are discrepancies between this printable manual and the manual you see in your car's centre display, the latter takes precedence.

Contents

1. [Owner information](#)
 - 1.1 [Owner information](#)
 - 1.2 [Reading the owner's manual](#)
 - 1.3 [Complete owner's manual in centre display](#)
 - 1.4 [Navigate in the owner's manual in the centre display](#)
2. [Your Volvo](#)
 - 2.1 [Volvo ID](#)
 - 2.1.1 [Volvo ID](#)
 - 2.1.2 [Creating a Volvo ID](#)
 - 2.1.3 [Problems logging in with Volvo ID](#)
 - 2.2 [Type approvals and licences](#)
 - 2.2.1 [License agreement for driver display](#)
 - 2.2.2 [Type approval for HomeLink®](#)
 - 2.2.3 [Type approval for Radio Equipment Directive](#)
 - 2.2.4 [Certificate for wireless charger](#)
 - 2.2.5 [Type approval for remote control key system](#)
 - 2.2.6 [Approval of terms and conditions and data collection](#)
 - 2.2.7 [Candidate List Substance Information \(CL\) in accordance with the Reach Regulation, Article 33.1](#)
 - 2.3 [Displays and controls by the driver in a left-hand drive car](#)
 - 2.4 [Displays and controls by the driver in a right-hand drive car](#)
 - 2.5 [Connection of equipment to the car's diagnostic socket](#)
 - 2.6 [Driver distraction](#)
 - 2.7 [Environmental efficiency](#)
 - 2.8 [Getting started with Google services](#)
 - 2.9 [Change of market when importing or relocating](#)
 - 2.10 [Showing the car's identification number](#)
 - 2.11 [Recording data](#)
 - 2.12 [Online connectivity and entertainment](#)
 - 2.13 [Important information on accessories and auxiliary equipment](#)
3. [Safety](#)
 - 3.1 [Seatbelts](#)

The content of this manual represents the status of the user manual at the time of printing and may not be completely valid in future instances. For more information, refer to the first page for the complete disclaimer note.

- 3.1.1 Seatbelts
 - 3.1.2 Putting on and taking off seatbelts
 - 3.1.3 Seatbelt tensioner
 - 3.1.4 Resetting the electric seatbelt tensioner
 - 3.1.5 Door and seatbelt reminder
 - 3.2 Airbags
 - 3.2.1 Airbags
 - 3.2.2 Driver airbags
 - 3.2.3 Passenger airbag
 - 3.2.4 Activating and deactivating passenger airbag
 - 3.2.5 Inflatable curtains
 - 3.2.6 Near-side airbags
 - 3.3 Child safety
 - 3.3.1 Mounting points for child seats
 - 3.3.1.1 Lower mounting points for child seats
 - 3.3.1.2 i-Size/ISOFIX mounting points for child seats
 - 3.3.1.3 Upper mounting points for child seats
 - 3.3.2 Integrated child seat
 - 3.3.2.1 Integrated child seat
 - 3.3.2.2 Folding up the seat cushion in the integrated child seat
 - 3.3.2.3 Folding down the seat cushion in the integrated child seat
 - 3.3.3 Child seat location
 - 3.3.3.1 Table for location of child seats using the car's seatbelts
 - 3.3.3.2 Child seat positioning
 - 3.3.3.3 Child seat mounting
 - 3.3.3.4 Table for location of ISOFIX child seats
 - 3.3.3.5 Table for location of i-Size child seats
 - 3.3.4 Activating and deactivating child safety locks
 - 3.3.5 Child safety
 - 3.3.6 Child seats
 - 3.3.7 Activating and deactivating passenger airbag
 - 3.4 Safety mode
 - 3.4.1 Traffic accident
 - 3.4.2 Safety mode
 - 3.4.3 Starting and moving the car after safety mode
 - 3.5 Safety
 - 3.6 Pedestrian Protection System
 - 3.7 Safety during pregnancy
 - 3.8 Whiplash Protection System
4. Displays and voice control
- 4.1 Driver display
 - 4.1.1 Gauges and indicators in driver display
 - 4.1.1.1 Fuel gauge
 - 4.1.1.2 Outside temperature gauge
 - 4.1.1.3 Gear shift indicator
 - 4.1.2 Trip computer
 - 4.1.2.1 Trip computer
 - 4.1.2.2 Resetting the trip meter
 - 4.1.3 Driver display
 - 4.1.4 Driver display settings
 - 4.1.5 License agreement for driver display
 - 4.1.6 Messages in the driver display

- 4.2 Centre display
 - 4.2.1 Settings
 - 4.2.1.1 Resetting user data
 - 4.2.1.2 Changing system units
 - 4.2.1.3 Changing system language
 - 4.2.1.4 Settings for head-up display
 - 4.2.1.5 Settings for unlocking
 - 4.2.1.6 Setting the speed limit for Care Key
 - 4.2.1.7 Settings for lock indication
 - 4.2.1.8 Settings for Keyless entry
 - 4.2.2 User profiles
 - 4.2.2.1 User profiles
 - 4.2.2.2 Link key to user profile
 - 4.2.2.3 Managing user profiles
 - 4.2.2.4 Profile settings
 - 4.2.2.5 Link account to user profile
 - 4.2.3 Centre display
 - 4.2.4 Managing the centre display
 - 4.2.5 Centre display views
 - 4.2.6 Managing subviews in centre display
 - 4.2.7 Symbols in the centre display's status bar
 - 4.2.8 Moving apps in the centre display
 - 4.2.9 Messages in the centre display
 - 4.2.10 Keyboard in the centre display
 - 4.2.11 Changing keyboard language in centre display
 - 4.2.12 Date and time
 - 4.2.13 Navigate in the owner's manual in the centre display
 - 4.3 Head-up display
 - 4.3.1 Head-up display
 - 4.3.2 Settings for head-up display
 - 4.3.3 Cleaning the Head-up display
 - 4.3.4 Using a stored position for seat, door mirrors and head-up display
 - 4.3.5 Storing position for seat, door mirrors and head-up display
 - 4.4 Symbols and messages
 - 4.4.1 Messages for BLIS
 - 4.4.2 Symbols and messages for electronic stability control
 - 4.4.3 Symbols and messages for Pilot Assist
 - 4.4.4 Symbols and messages for lane assistance
 - 4.4.5 Display mode for lane assistance
 - 4.4.6 Symbols and messages for park assist system and park assist camera
 - 4.4.7 Symbols in the centre display's status bar
 - 4.4.8 Indicator and warning symbols
 - 4.4.9 Symbols and messages for parking climate control
 - 4.4.10 Overheating in the engine and drive system
 - 4.4.11 Symbols and messages for the transmission
 - 4.5 Voice control
 - 4.5.1 Voice control with Google Assistant
 - 4.5.2 Using voice control
 - 4.6 Displays and controls by the driver in a left-hand drive car
 - 4.7 Displays and controls by the driver in a right-hand drive car
- 5. Lighting
 - 5.1 Exterior lighting

- 5.1.1 Active bending lights
- 5.1.2 Active main beam
- 5.1.3 Using direction indicators
- 5.1.4 Brake lights
- 5.1.5 Rear fog lamp
- 5.1.6 Front fog lamps and cornering lights
- 5.1.7 Dipped beam
- 5.1.8 Using main beam
- 5.1.9 Using the guidance light
- 5.1.10 Adapting the headlamp pattern from the headlamps
- 5.1.11 Emergency brake lights
- 5.1.12 Position lamps
- 5.1.13 Welcome light
- 5.1.14 Hazard warning flashers
- 5.1.15 Daytime running lights
- 5.1.16 Checking trailer lamps
- 5.2 Interior lighting
 - 5.2.1 Interior lighting
 - 5.2.2 Adjusting interior lighting
- 5.3 Adjusting light functions via the centre display
- 5.4 Lighting control
- 6. Windows, glass and mirrors
 - 6.1 Rearview mirrors
 - 6.1.1 HomeLink®
 - 6.1.2 Rearview and door mirrors
 - 6.1.3 Angling adjustment of the door mirrors
 - 6.1.4 Adjusting rearview mirror dimming
 - 6.1.5 Using a stored position for seat, door mirrors and head-up display
 - 6.1.6 Storing position for seat, door mirrors and head-up display
 - 6.1.7 Activating and deactivating the heated rear window and door mirrors
 - 6.1.8 Activating and deactivating automatic starting of the heated rear window and door mirrors
 - 6.2 Windscreen and rear window
 - 6.2.1 Damaged windscreen
 - 6.2.2 Wiper blades and washer fluid
 - 6.2.3 Using the rear window wiper and rear window washer
 - 6.2.4 Using the rain sensor
 - 6.2.5 Using windscreen and headlamp washers
 - 6.2.6 Using windscreen wipers
 - 6.2.7 Activating and deactivating the heated rear window and door mirrors
 - 6.2.8 Activating and deactivating automatic starting of the heated rear window and door mirrors
 - 6.2.9 Activating and deactivating the heated windscreen
 - 6.2.10 Activating and deactivating automatic start of heated windscreen
 - 6.3 Side windows and panoramic roof
 - 6.3.1 Power windows
 - 6.3.2 Operating power windows
 - 6.3.3 Panoramic roof
 - 6.3.4 Operating the panoramic roof
 - 6.3.5 Automatic closing of the panoramic roof's sun blind
 - 6.3.6 Using the sun blind
 - 6.4 Windows, glass and mirrors
 - 6.5 Pinch protection for windows and sun blinds
 - 6.6 Reset sequence for pinch protection

- 6.7 Activating and deactivating max defroster
- 7. Seats and steering wheel
 - 7.1 Front seat
 - 7.1.1 Climate controls for front seat
 - 7.1.1.1 Activating and deactivating heated front seat
 - 7.1.1.2 Activating and deactivating automatic start of heated front seat
 - 7.1.1.3 Regulating fan level for front seat
 - 7.1.1.4 Regulating temperature for front seat
 - 7.1.1.5 Synchronising temperature
 - 7.1.1.6 Activating and deactivating ventilated front seat
 - 7.1.2 Memory function for front seat
 - 7.1.2.1 Using a stored position for seat, door mirrors and head-up display
 - 7.1.2.2 Storing position for seat, door mirrors and head-up display
 - 7.1.3 Front seat
 - 7.1.4 Power front seat
 - 7.1.5 Adjusting the power front seat
 - 7.1.6 Adjusting the passenger seat from the driver's seat
 - 7.1.7 Manual front seat
 - 7.1.8 Multifunctional front seat function overview
 - 7.1.9 Massage settings in the front seat
 - 7.1.10 Adjusting the side support in the front seat
 - 7.1.11 Adjusting the length of the seat cushion in the front seat
 - 7.1.12 Adjusting the lumbar support in the front seat
 - 7.2 Rear seat
 - 7.2.1 Climate controls for rear seat
 - 7.2.1.1 Activating and deactivating heated rear seat
 - 7.2.2 Rear seat
 - 7.2.3 Adjusting the head restraints in the rear seat
 - 7.2.4 Lowering the backrests in the rear seat
 - 7.2.5 Through-load hatch in the rear seat
 - 7.3 Steering wheel
 - 7.3.1 Speed-dependent steering force
 - 7.3.2 Steering wheel controls and horn
 - 7.3.3 Adjusting the steering wheel
 - 7.3.4 Activating and deactivating the heated steering wheel
 - 7.3.5 Activating and deactivating automatic start of heated steering wheel
- 8. Climate control
 - 8.1 Climate system controls
 - 8.1.1 Climate controls for passenger compartment
 - 8.1.1.1 Activating auto climate control
 - 8.1.1.2 Regulating fan level for front seat
 - 8.1.1.3 Activating and deactivating air conditioning
 - 8.1.1.4 Activating and deactivating air recirculation
 - 8.1.1.5 Activating and deactivating time setting for air recirculation
 - 8.1.1.6 Regulating temperature for front seat
 - 8.1.1.7 Synchronising temperature
 - 8.1.1.8 Changing air distribution
 - 8.1.2 Climate controls for seat and steering wheel
 - 8.1.2.1 Activating and deactivating the heated steering wheel
 - 8.1.2.2 Activating and deactivating automatic start of heated steering wheel
 - 8.1.2.3 Activating and deactivating heated rear seat
 - 8.1.2.4 Activating and deactivating heated front seat

- 8.1.2.5 Activating and deactivating automatic start of heated front seat
- 8.1.3 Climate controls for windows and mirrors
 - 8.1.3.1 Activating and deactivating the heated rear window and door mirrors
 - 8.1.3.2 Activating and deactivating automatic starting of the heated rear window and door mirrors
 - 8.1.3.3 Activating and deactivating the heated windscreen
 - 8.1.3.4 Activating and deactivating automatic start of heated windscreen
 - 8.1.3.5 Activating and deactivating max defroster
- 8.1.4 Climate controls
- 8.2 Air distribution
 - 8.2.1 Activating and deactivating air recirculation
 - 8.2.2 Activating and deactivating time setting for air recirculation
 - 8.2.3 Activating and deactivating max defroster
 - 8.2.4 Air distribution
 - 8.2.5 Changing air distribution
 - 8.2.6 Opening, closing and aiming the air vents
- 8.3 Air quality
 - 8.3.1 Air quality
 - 8.3.2 Advanced Air Cleaner
 - 8.3.3 CleanZone
 - 8.3.4 Clean Zone Interior Package
 - 8.3.5 Interior Air Quality System
 - 8.3.6 Passenger compartment filter
 - 8.3.7 Air purification
 - 8.3.8 Starting and switching off air purification
 - 8.3.9 Air Quality app
- 8.4 Parking climate
 - 8.4.1 Pre-cleaning
 - 8.4.1.1 Air purification
 - 8.4.1.2 Starting and switching off air purification
 - 8.4.2 Parking climate
 - 8.4.3 Symbols and messages for parking climate control
 - 8.4.4 Climate comfort when parking
 - 8.4.5 Starting and switching off climate comfort when parking
- 8.5 Climate
- 8.6 Servicing the climate control system
- 8.7 Activating and deactivating ventilated front seat
- 8.8 Climate control - sensors
- 8.9 Climate zones
- 8.10 Perceived temperature
- 9. Key, locks and alarm
 - 9.1 Key
 - 9.1.1 User profiles
 - 9.1.1.1 User profiles
 - 9.1.1.2 Link key to user profile
 - 9.1.1.3 Managing user profiles
 - 9.1.1.4 Profile settings
 - 9.1.1.5 Link account to user profile
 - 9.1.2 Immobiliser
 - 9.1.3 Keys
 - 9.1.4 Ordering additional keys
 - 9.1.5 Replacing the battery in the key
 - 9.1.6 Locking and unlocking with the key's buttons

- 9.1.7 Care Key – speed limit key
- 9.1.8 Setting the speed limit for Care Key
- 9.1.9 Unlocking the tailgate with a key button
- 9.1.10 Detachable key blade
- 9.1.11 Locking and unlocking with the detachable key blade
- 9.1.12 The key's range
- 9.1.13 Type approval for remote control key system
- 9.1.14 Antenna locations for the start and lock systems
- 9.1.15 Ignition positions
- 9.1.16 Selecting ignition mode
- 9.2 Locking and unlocking
 - 9.2.1 Keyless locking and unlocking
 - 9.2.1.1 Operating the tailgate with foot movement
 - 9.2.1.2 Antenna locations for the start and lock systems
 - 9.2.1.3 Keyless locking and unlocking with touch-sensitive surfaces
 - 9.2.1.4 Keyless locking and unlocking
 - 9.2.1.5 Settings for Keyless entry
 - 9.2.1.6 Closing and locking tailgate with button
 - 9.2.1.7 Keyless unlocking of tailgate
 - 9.2.2 Keys
 - 9.2.3 Locking and unlocking with the key's buttons
 - 9.2.4 Settings for unlocking
 - 9.2.5 Unlocking the tailgate with a key button
 - 9.2.6 Locking and unlocking with the detachable key blade
 - 9.2.7 Automatic locking when driving
 - 9.2.8 Double lock
 - 9.2.9 Setting the max. opening for electrically operated tailgate
 - 9.2.10 Locking and unlocking from inside the car
 - 9.2.11 Unlocking the tailgate from inside the car
 - 9.2.12 Locking and unlocking
 - 9.2.13 Activating and deactivating child safety locks
 - 9.2.14 Lock confirmation
 - 9.2.15 Settings for lock indication
- 9.3 Alarm
 - 9.3.1 Alarm
 - 9.3.2 Activating and deactivating alarms
 - 9.3.3 Reduced alarm level
- 10. Driver support
 - 10.1 Cruise control functions
 - 10.1.1 Cruise control
 - 10.1.1.1 Cruise control
 - 10.1.1.2 Standby mode for cruise control
 - 10.1.1.3 Setting the stored speed for cruise control functions
 - 10.1.2 Pilot Assist
 - 10.1.2.1 Automatic braking with cruise control functions
 - 10.1.2.2 Setting the stored speed for cruise control functions
 - 10.1.2.3 Change of target with cruise control functions
 - 10.1.2.4 Pilot Assist
 - 10.1.2.5 Display mode for Pilot Assist
 - 10.1.2.6 Symbols and messages for Pilot Assist
 - 10.1.2.7 Standby mode for Pilot Assist
 - 10.1.2.8 Setting time interval to vehicle ahead

- 10.1.2.9 Difference between Pilot Assist and lane assistance
 - 10.1.2.10 Warning from cruise control functions in the event of a collision risk
 - 10.1.3 Overtaking assistance
 - 10.1.3.1 Overtaking Assistance
 - 10.1.3.2 Using Overtaking Assistance
 - 10.1.4 Cruise control functions
 - 10.1.5 Steering wheel buttons for the cruise control functions
 - 10.1.6 Selecting and activating cruise control functions
 - 10.1.7 Deactivating cruise control functions
 - 10.1.8 Intelligent Speed Assist (ISA)
- 10.2 Distance Warning
 - 10.2.1 Distance Warning
 - 10.2.2 Limitations of distance warning
 - 10.2.3 Setting time interval to vehicle ahead
 - 10.2.4 Warning from cruise control functions in the event of a collision risk
- 10.3 Blind Spot Information
 - 10.3.1 BLIS
 - 10.3.2 Messages for BLIS
 - 10.3.3 Limitations of BLIS
- 10.4 Cross Traffic Alert
 - 10.4.1 Warning and auto-brake when reversing
 - 10.4.2 Activating and deactivating warning and auto-brake when reversing
- 10.5 Rear Collision Warning
 - 10.5.1 Rear Collision Warning
 - 10.5.2 Limitations of Rear Collision Warning
- 10.6 Connected Safety
 - 10.6.1 Connected Safety
 - 10.6.2 Activating and deactivating Connected Safety
 - 10.6.3 Limitations of Connected Safety
- 10.7 Assistance at risk of collision
 - 10.7.1 Assistance at risk of collision
 - 10.7.2 Detection of obstacles with assistance at risk of collision
 - 10.7.3 Speed reduction option with assistance at risk of collision
 - 10.7.4 Symbols and messages for assistance at risk of collision
 - 10.7.5 Limitations for assistance at risk of collision
 - 10.7.6 Collision Avoidance – steering assistance for evasive manoeuvres
 - 10.7.7 Assistance at risk of collision in crossing traffic
 - 10.7.8 Assistance at risk of collision in oncoming traffic
 - 10.7.9 Collision Avoidance to help avoid impact with a vehicle in the driver's blind spot
 - 10.7.10 Assistance at risk of run-off
- 10.8 Driver Alert Control
 - 10.8.1 Driver Alert
 - 10.8.2 Limitations of Driver Alert
- 10.9 Lane assistance
 - 10.9.1 Lane assistance
 - 10.9.2 Activating and deactivating lane assistance
 - 10.9.3 Difference between Pilot Assist and lane assistance
 - 10.9.4 Symbols and messages for lane assistance
 - 10.9.5 Display mode for lane assistance
 - 10.9.6 Limitations of Lane assistance
- 10.10 Electronic stability control
 - 10.10.1 Electronic stability control

- 10.10.2 Symbols and messages for electronic stability control
 - 10.11 Road Sign Information
 - 10.11.1 Road Sign Information
 - 10.11.2 Limitations of Road Sign Information
 - 10.11.3 Warning for speed limitation and speed camera from road sign information
 - 10.11.4 Display mode for road sign information
 - 10.12 Parking functions
 - 10.12.1 Parking assistance
 - 10.12.1.1 Park Assist
 - 10.12.1.2 Park Assist System front, rear and along the sides
 - 10.12.1.3 Activating and deactivating Parking Assistance System
 - 10.12.1.4 Limitations of park assist system
 - 10.12.1.5 Symbols and messages for park assist system and park assist camera
 - 10.12.2 Park assist camera
 - 10.12.2.1 Park assist camera
 - 10.12.2.2 Activating park assist camera
 - 10.12.2.3 Symbols and messages for park assist system and park assist camera
 - 10.12.2.4 Park assist lines for park assist camera
 - 10.12.2.5 Park assist camera locations and surveillance areas
 - 10.12.2.6 Sensor fields for park assist system
 - 10.13 Camera and radar unit
 - 10.13.1 Recommended maintenance for camera, sensor and radar units
 - 10.13.2 Symbols and messages for camera and radar units
 - 10.13.3 Limitations for camera and radar units
 - 10.13.4 Camera unit
 - 10.13.5 Radar units
 - 10.13.6 Type approval for radar units
 - 10.14 Driving support systems
 - 10.15 Warnings from various driver support systems
 - 10.16 Speed-dependent steering force
 - 10.17 Ready to drive notification
 - 10.18 Auto braking after a collision
11. Starting and driving
- 11.1 Starting and switching off the car
 - 11.1.1 Immobiliser
 - 11.1.2 Starting the car
 - 11.1.3 Using jump starting with another battery
 - 11.1.4 Switching off the car
 - 11.1.5 Ignition positions
 - 11.1.6 Selecting ignition mode
 - 11.2 Alcohol lock
 - 11.2.1 Alcohol lock
 - 11.3 Gearbox
 - 11.3.1 Kick-down function
 - 11.3.2 Launch function
 - 11.3.3 Gearbox
 - 11.3.4 Gear positions
 - 11.3.5 Changing gear with automatic gearbox
 - 11.3.6 Symbols and messages for the transmission
 - 11.3.7 All-wheel drive
 - 11.3.8 Gear selector inhibitor
 - 11.3.9 Gear shift indicator

- 11.4 Brakes
 - 11.4.1 Foot brake
 - 11.4.1.1 Brake assistance
 - 11.4.1.2 Braking on gritted roads
 - 11.4.1.3 Braking on wet roads
 - 11.4.1.4 Foot brake
 - 11.4.1.5 Brake system maintenance
 - 11.4.2 Parking brake
 - 11.4.2.1 Parking brake
 - 11.4.2.2 Activating and deactivating the parking brake
 - 11.4.2.3 Parking on a hill
 - 11.4.2.4 In the event of a fault in the parking brake
 - 11.4.3 Brake fluid – specifications
 - 11.4.4 Brake functions
 - 11.4.5 Automatic braking when stationary
 - 11.4.6 Activating and deactivating the automatic brake at a standstill
 - 11.4.7 Auto braking after a collision
 - 11.4.8 Regenerative braking
- 11.5 Drive modes
 - 11.5.1 Regenerative braking
 - 11.5.2 Launch function
 - 11.5.3 All-wheel drive
- 11.6 Start/stop function
 - 11.6.1 Start/stop function
 - 11.6.2 Activating and deactivating the start/stop function
- 11.7 Recommendations for driving
 - 11.7.1 Towing
 - 11.7.2 Braking on gritted roads
 - 11.7.3 Braking on wet roads
 - 11.7.4 Parking on a hill
 - 11.7.5 Petrol particle filter
 - 11.7.6 Petrol station
 - 11.7.7 Preparations for a long trip
 - 11.7.8 Overloading the starter battery
 - 11.7.9 Driving in water
 - 11.7.10 Winter driving
 - 11.7.11 Overheating in the engine and drive system
- 11.8 Towbar and trailer
 - 11.8.1 Towing capacity and towball load
 - 11.8.2 Towbar
 - 11.8.3 Specifications for towbar
 - 11.8.4 Towbar-mounted bicycle rack
 - 11.8.5 Extendable and retractable towbar
 - 11.8.6 Driving with a trailer
 - 11.8.7 Trailer stability assist
 - 11.8.8 Checking trailer lamps
- 11.9 Fuel
 - 11.9.1 Fuel gauge
 - 11.9.2 Handling of fuel
 - 11.9.3 Petrol
- 11.10 Refuelling
 - 11.10.1 Handling of fuel

- 11.10.2 Fuel consumption/electric consumption and CO₂ emissions
- 11.10.3 Petrol station
- 11.10.4 Fuel tank - volume
- 11.10.5 Filling fuel
- 11.10.6 Opening and closing the fuel filler flap
- 11.11 Emission control
 - 11.11.1 Petrol particle filter
- 11.12 HomeLink
 - 11.12.1 HomeLink®
 - 11.12.2 Using HomeLink®
 - 11.12.3 Programming HomeLink®
 - 11.12.4 Type approval for HomeLink®
- 11.13 Towing and recovery
 - 11.13.1 Towing
 - 11.13.2 Fitting and removing the towing eye
 - 11.13.3 Recovery
 - 11.13.4 Safety mode
 - 11.13.5 Starting and moving the car after safety mode
- 11.14 Damping
 - 11.14.1 Level control and shock absorption
- 11.15 Level control
 - 11.15.1 Level control and shock absorption
- 11.16 Operational disruption
- 11.17 Traffic accident
- 12. Sound, media and Internet
 - 12.1 Radio
 - 12.1.1 Radio
 - 12.1.2 Start radio
 - 12.1.3 RDS radio
 - 12.1.4 Setting radio favourites
 - 12.2 Media player
 - 12.2.1 Bluetooth Media Player
 - 12.3 Phone
 - 12.3.1 Phone connection
 - 12.3.1.1 Connecting a phone to the car
 - 12.3.1.2 Disconnecting a Bluetooth-connected phone
 - 12.3.1.3 Switch between Bluetooth-connected phones
 - 12.3.1.4 Removing devices connected to Bluetooth
 - 12.3.2 Apple CarPlay
 - 12.3.2.1 Apple® CarPlay®
 - 12.3.2.2 Using Apple® CarPlay®
 - 12.3.2.3 Tips for using Apple® CarPlay®
 - 12.3.3 Android Auto
 - 12.3.3.1 Android Auto®
 - 12.3.3.2 Using Android Auto®
 - 12.3.3.3 Tips for using Android Auto®
 - 12.3.4 Connecting to the Internet via Bluetooth
 - 12.3.5 Phone
 - 12.3.6 Managing contacts
 - 12.3.7 Managing phone calls
 - 12.3.8 Managing text messages
 - 12.3.9 Using a wireless charger

- 12.3.10 Certificate for wireless charger
 - 12.4 Apps
 - 12.4.1 Apps
 - 12.4.2 Downloading apps
 - 12.4.3 Deleting apps
 - 12.4.4 Volvo ID
 - 12.4.5 Creating a Volvo ID
 - 12.5 Internet connection
 - 12.5.1 Online services
 - 12.5.1.1 Connected Safety
 - 12.5.1.2 Apps
 - 12.5.1.3 Volvo ID
 - 12.5.1.4 Creating a Volvo ID
 - 12.5.2 Connecting to the Internet via Bluetooth
 - 12.5.3 Internet connection
 - 12.5.4 Problems with Internet connection
 - 12.5.5 Connecting to the Internet via Wi-Fi
 - 12.5.6 Markets with Car Modem Internet
 - 12.6 Audio and media
 - 12.7 Storage space on hard disk
 - 12.8 Sound settings
 - 12.9 Media playback
 - 12.10 Online connectivity and entertainment
 - 12.11 Approval of terms and conditions and data collection
13. Volvo Assistance and the Volvo Cars app
- 13.1 Volvo Assistance
 - 13.1.1 Volvo Assistance
 - 13.1.2 Emergency assistance with Volvo Assistance
 - 13.1.3 Automatic collision alarm with Volvo Assistance
 - 13.1.4 Prioritising between Volvo Assistance and the emergency call centre
 - 13.1.5 Stolen Vehicle Tracking with Volvo Assistance
 - 13.1.6 Volvo Assistance during a trip
 - 13.1.7 Customer service via Volvo Assistance
 - 13.1.8 Standby battery for Volvo Assistance
 - 13.1.9 Volvo Assistance abroad
 - 13.2 Volvo Cars app
 - 13.2.1 Getting started with the Volvo Cars app
 - 13.2.2 Devices compatible with the Volvo Cars app
 - 13.2.3 Contact between the Volvo Cars app and the car
 - 13.2.4 Volvo Cars app
 - 13.2.5 Connecting the Volvo Cars app to the car
 - 13.2.6 Booking a service with the Volvo Cars app
 - 13.2.7 Remote starting the car using the Volvo Cars app
 - 13.2.8 Lock function in the Volvo Cars app
 - 13.2.9 Shortcuts to the Volvo Cars app
 - 13.2.10 Remote starting climate control using the Volvo Cars app
 - 13.2.11 Remote starting air purification using the Volvo Cars app
 - 13.2.12 Using the Volvo Cars app with Apple Watch
 - 13.2.13 Disconnecting the link between the Volvo Cars app and the car
 - 13.2.14 Change of ownership when the Volvo Cars app is linked to the car
14. eCall
- 14.1 eCall

- 14.2 Emergency assistance with eCall
- 14.3 Automatic collision alarm with eCall
- 14.4 Roadside assistance
- 15. Navigation
 - 15.1 Map update
 - 15.1.1 Downloading maps
 - 15.2 Google Maps
 - 15.3 Using Google Maps
 - 15.4 Updating Google Maps
 - 15.5 Settings in Google Maps
 - 15.6 Electric car functions with Google Maps
 - 15.7 Google Maps in driver display
 - 15.8 Destination in Google Maps
 - 15.9 Online functions with Google Maps
 - 15.10 Getting directions with Google Maps
- 16. Wheels and tyres
 - 16.1 Changing wheels
 - 16.1.1 Changing wheel
 - 16.1.2 Jack
 - 16.1.3 Wheel bolts
 - 16.1.4 Spare wheel
 - 16.1.5 Handling the spare wheel
 - 16.1.6 Snow chains
 - 16.1.7 Winter tyres
 - 16.1.8 Punctures
 - 16.1.9 Tool kit
 - 16.2 Tyres
 - 16.2.1 Dimension designation for tyre
 - 16.2.2 Tyres' rotation direction
 - 16.2.3 Tread wear indicators on the tyres
 - 16.2.4 Dimension designation for wheel rim
 - 16.2.5 Minimum permitted tyre load index and speed rating for tyres
 - 16.3 Tyre pressure
 - 16.3.1 Tyre pressure monitoring
 - 16.3.1.1 Tyre pressure monitoring system
 - 16.3.1.2 See tyre pressure status in the centre display
 - 16.3.1.3 Action in the event of warning for low tyre pressure
 - 16.3.1.4 Saving a new reference value for tyre pressure monitoring
 - 16.3.1.5 Messages for tyre pressure monitoring
 - 16.3.2 Checking tyre pressure
 - 16.3.3 Adjusting tyre pressure
 - 16.3.4 Approved tyre pressures
 - 16.3.5 Location of tyre pressure label
 - 16.4 Emergency puncture repair
 - 16.4.1 Emergency puncture repair kit
 - 16.4.2 Inflating tyres with the compressor from the puncture repair kit
 - 16.4.3 Using a puncture repair kit
 - 16.5 Winter driving
 - 16.5.1 Snow chains
 - 16.5.2 Winter tyres
 - 16.5.3 Preparations for a long trip
 - 16.5.4 Winter driving

- 16.6 Tyres
- 16.7 Approved wheel and tyre sizes
- 17. Loading, storage and passenger compartment
 - 17.1 Loading
 - 17.1.1 Recommendations for loading
 - 17.1.2 Bag hooks
 - 17.1.3 Operating cargo cover
 - 17.1.4 Fitting and removing cargo cover
 - 17.1.5 Load retaining eyelets
 - 17.1.6 Fitting and removing safety grilles
 - 17.1.7 Fitting and removing the safety net
 - 17.1.8 Roof load and loading on load carriers
 - 17.1.9 Towbar-mounted bicycle rack
 - 17.2 Cargo area
 - 17.2.1 Safety net, safety grille and cargo cover
 - 17.2.1.1 Operating cargo cover
 - 17.2.1.2 Fitting and removing cargo cover
 - 17.2.1.3 Fitting and removing safety grilles
 - 17.2.1.4 Fitting and removing the safety net
 - 17.2.2 Cargo area
 - 17.2.3 Bag hooks
 - 17.2.4 First aid kit
 - 17.2.5 Load retaining eyelets
 - 17.2.6 Warning triangle
 - 17.2.7 Unlocking the tailgate with a key button
 - 17.2.8 Setting the max. opening for electrically operated tailgate
 - 17.2.9 Operating the tailgate with foot movement
 - 17.2.10 Unlocking the tailgate from inside the car
 - 17.2.11 Keyless unlocking of tailgate
 - 17.2.12 Fuses in cargo area
 - 17.3 Storage and passenger compartment
 - 17.3.1 Passenger compartment interior
 - 17.3.2 Electrical sockets
 - 17.3.3 Using electrical sockets
 - 17.3.4 Using the glovebox
 - 17.3.5 Sun visors
 - 17.3.6 Tunnel console
 - 17.3.7 USB ports
 - 17.3.8 Use USB ports to charge devices
 - 17.3.9 Fuses under glovebox
 - 17.4 Through-load hatch in the rear seat
- 18. Maintenance and service
 - 18.1 Car care
 - 18.1.1 Interior cleaning
 - 18.1.1.1 Cleaning the centre display
 - 18.1.1.2 Cleaning the driver display
 - 18.1.1.3 Cleaning the Head-up display
 - 18.1.1.4 Cleaning the leather steering wheel
 - 18.1.1.5 Cleaning the seatbelts
 - 18.1.1.6 Cleaning the interior
 - 18.1.1.7 Cleaning textile floor and entrance mats
 - 18.1.1.8 Cleaning interior plastic, metal and wood parts

- 18.1.1.9 Cleaning leather upholstery
- 18.1.1.10 Cleaning fabric upholstery and headlining
- 18.1.2 Exterior cleaning
 - 18.1.2.1 Cleaning the exterior lamps
 - 18.1.2.2 Cleaning the wiper blades
 - 18.1.2.3 Car paintwork
 - 18.1.2.4 Colour codes
 - 18.1.2.5 Touching up minor paintwork damage
 - 18.1.2.6 Cleaning the exterior
 - 18.1.2.7 Rustproofing
 - 18.1.2.8 Automatic car wash
 - 18.1.2.9 Cleaning exterior plastic, rubber and trim components
 - 18.1.2.10 Cleaning wheel rims
 - 18.1.2.11 Handwashing
 - 18.1.2.12 High-pressure washing
 - 18.1.2.13 Polishing and waxing
- 18.2 Wiper blades and washer fluid
 - 18.2.1 Wiper blades and washer fluid
 - 18.2.2 Setting the wiper blades in service position
 - 18.2.3 Topping up washer fluid
 - 18.2.4 Replacing the wiper blade, rear window
 - 18.2.5 Replacing windscreen wiper blades
- 18.3 Bulb replacement
 - 18.3.1 Bulb replacement
 - 18.3.2 Checking trailer lamps
- 18.4 Engine compartment
 - 18.4.1 Topping up washer fluid
 - 18.4.2 Brake fluid – specifications
 - 18.4.3 Opening and closing the bonnet
 - 18.4.4 Engine compartment overview
 - 18.4.5 Coolant
 - 18.4.6 Topping up coolant
 - 18.4.7 Engine oil
 - 18.4.8 Checking and filling with engine oil
 - 18.4.9 Engine oil – specifications
 - 18.4.10 Fuses in engine compartment
- 18.5 Tools and accessories
 - 18.5.1 Jack
 - 18.5.2 Emergency puncture repair kit
 - 18.5.3 First aid kit
 - 18.5.4 Warning triangle
 - 18.5.5 Tool kit
- 18.6 Fuses
 - 18.6.1 Fuses and central electrical units
 - 18.6.2 Replacing a fuse
 - 18.6.3 Fuses under glovebox
 - 18.6.4 Fuses in cargo area
 - 18.6.5 Fuses in engine compartment
- 18.7 Battery
 - 18.7.1 Replacing the battery in the key
 - 18.7.2 Overloading the starter battery
 - 18.7.3 Using jump starting with another battery

- 18.7.4 Batteries and power supply
- 18.7.5 Recycling the batteries
- 18.7.6 Symbols on the batteries
- 18.7.7 Starter battery
- 18.7.8 Support battery
- 18.8 Service
 - 18.8.1 Servicing the climate control system
 - 18.8.2 Volvo service programme
- 18.9 Recommended maintenance for camera, sensor and radar units
- 18.10 Software updates
- 18.11 Brake system maintenance
- 18.12 Operational disruption
- 18.13 Data transfer between car and workshop via Wi-Fi
- 18.14 Raising the car
- 19. Specifications
 - 19.1 Dimensions and weights
 - 19.1.1 Towing capacity and towball load
 - 19.1.2 Dimensions
 - 19.1.3 Weights
 - 19.1.4 Specifications for towbar
 - 19.2 Specifications for engine
 - 19.2.1 Engine specifications
 - 19.2.2 Adverse driving conditions for engine oil
 - 19.2.3 Engine oil – specifications
 - 19.3 Specifications for fluids and lubricants
 - 19.3.1 Topping up washer fluid
 - 19.3.2 Air conditioning – specifications
 - 19.3.3 Brake fluid – specifications
 - 19.3.4 Transmission fluid – specifications
 - 19.3.5 Fuel tank - volume
 - 19.3.6 Adverse driving conditions for engine oil
 - 19.3.7 Engine oil – specifications
 - 19.4 Specifications for wheels and tyres
 - 19.4.1 Approved tyre pressures
 - 19.4.2 Approved wheel and tyre sizes
 - 19.4.3 Minimum permitted tyre load index and speed rating for tyres
 - 19.5 Type designations
 - 19.6 Fuel consumption/electric consumption and CO₂ emissions



1. Owner information

1.1. Owner information

Owner's information is available in several different product formats. The owner's manual is available in the car's centre display and on the Volvo Cars support site. There is also a digital Quick Guide^[1] that can be accessed from the owner's manual in the centre display. There is a supplement in the glovebox referencing where to find the digital owner's manual.



The car's centre display

To access the owner's manual, tap on  followed by tapping on . Available here are options for visual navigation with exterior and interior images of the car. The information is searchable and is also divided into categories.

Note

Changing the language in the centre display may mean that some owner's information is not compliant with national or local laws and regulations. Do not switch to a language that is difficult to understand as this may make it difficult to find your way back through the screen structure.

 **Important**

The driver is always responsible that the vehicle is driven safely in traffic and that applicable laws and regulations are followed. It is also important that the car is maintained and handled in accordance with Volvo's recommendations in the owner's information.

If the information in the centre display and other sources differs, the information in the centre display applies.

Volvo Cars support site

More information on your car is available on the Volvo Cars website and support site.

Go to [volvocars.com/intl/support](https://www.volvocars.com/intl/support) [<https://www.volvocars.com/intl/support>] and select your country. The page is available for most markets.

The support site contains contact details to customer support and your nearest Volvo retailer.

^[1] Only applies to certain markets.

1.2. Reading the owner's manual

To help you get to know your new car, read the Owner's Manual before you drive it for the first time.

Reading the owner's manual is a way to become familiar with new functions, get advice on how to handle the car in different situations and learn how to make use of all the car's features. Please pay attention to the safety instructions contained in the owner's manual.

Development work is constantly underway in order to improve our product. Modifications may mean that information, descriptions and illustrations in the owner's manual differ from the equipment in the car. We reserve the right to make modifications without prior notice.

© Volvo Car Corporation

Options/accessories

In addition to standard equipment, the owner's manual also describes options (factory fitted equipment) and certain accessories (retrofitted extra equipment).

All, at the time of publication known, options and accessories are marked with an asterisk: *.

The equipment described in the owner's manual is not available in all cars - they have different equipment depending on adaptations for the needs of different markets and national or local laws and regulations.

The intention of this owner's information is to explain all possible functions, options and accessories included in a Volvo vehicle. It is not intended as an indication or guarantee that all of these features, functions and options are included in every vehicle. Some terminology used may not exactly match terminology used in sales, marketing and advertising materials.

In the event of uncertainty over what is standard or an option/accessory, contact a Volvo dealer.

Special texts in the Owner's Manual

Warning

Warning texts appear if there is a risk of injury.

Important

Important texts appear if there is a risk of damage.

Note

Note texts give advice or tips that facilitate the use of e.g. features and functions.

Decals

The car contains different types of decal which are designed to convey important information in a clear manner. The decals in the car have the following descending degree of importance for the warning/information.

Warning

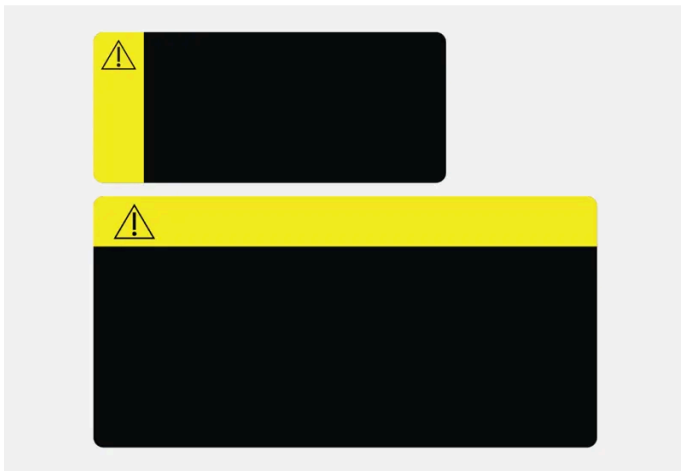

Yellow sign with warning symbol.

Indicates a potentially hazardous situation which, if not avoided, could result in death or serious injury.

Important

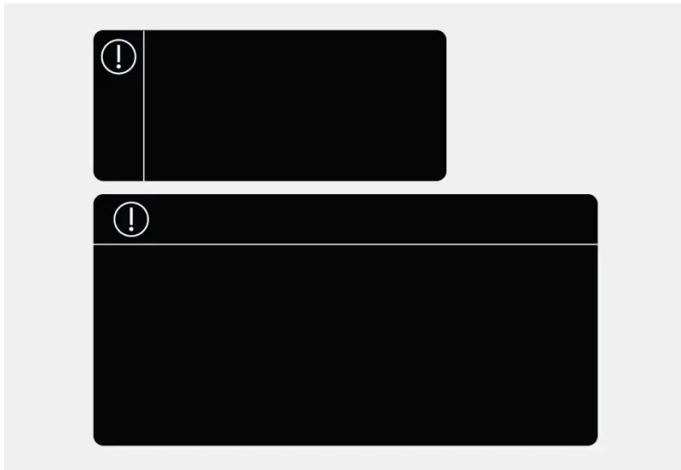

Sign with warning symbol.

Indicates a hazardous situation which, if not avoided, could result in minor or moderate damage to property.

Information

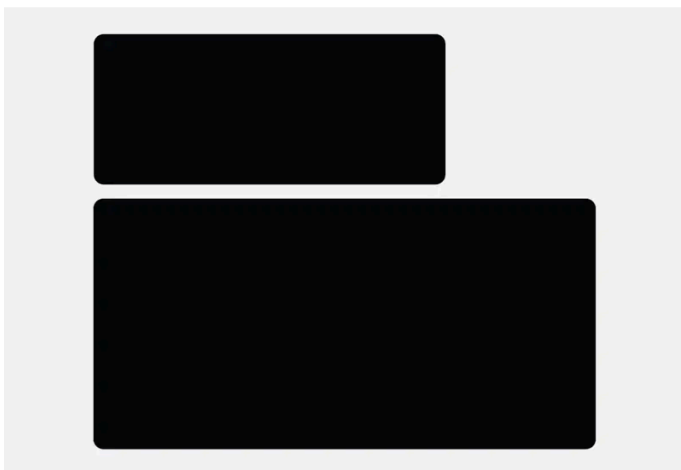

Decal without sign.

Indicates important information but no risk of personal injury or damage to property.

Note

It is not intended that the decals illustrated in the owner's manual should be exact replicas of those in the car. They are included to show their approximate appearance and location in the car. The information that applies to your particular car is available on the respective decals for your car.

Illustrations and video clips

Illustrations and video clips used in the owner's manual are sometimes schematic and are intended to provide an overall picture or example of a certain function. They may deviate from the car's appearance depending on equipment level and market.

* Option/accessory.

1.3. Complete owner's manual in centre display

The printed supplement only contains a selection of information. The complete and latest update of the information can be found in the car's centre display.





! Important

To learn about important safety instructions, and for as good an experience as possible, Volvo recommends that you read throughout all of the owner's information under each category in the centre display before driving for the first time.

! Important

The driver is always responsible that the vehicle is driven safely in traffic and that applicable laws and regulations are followed. It is also important that the car is maintained and handled in accordance with Volvo's recommendations in the owner's information.

Finding information in the car's centre display

Complete and up-to-date information for your car can always be found in the centre display. To access the owner's manual, tap on  followed by .

Find information by:

- using the search function
- navigating visually using exterior and interior images
- clicking through categories.



 **Note**

The digital owner's manual is not available while driving.

Changing the language in the centre display may mean that some owner information does not match national or local laws and regulations. Do not switch to a language that is difficult to understand, as this may make it difficult to find your way back through the structure on screen.

1.4. Navigate in the owner's manual in the centre display

The digital owner's manual can be accessed from the centre display.

To access the owner's manual, tap on  followed by .

There is a range of different options for finding information in the owner's manual.

Contents of the Owner's Manual

Homepage



Tap on the symbol to go back to the start page in the owner's manual.

Categories

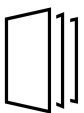

The articles in the owner's manual are structured into main categories and subcategories. The same article can be found in several appropriate categories so that it can be found more easily.

Visual navigation

Exterior and interior overview images of the car. Different parts are designated with hotspots that lead to articles about that part of the car.

1 Press **Exterior** or **Interior**.

- Exterior or interior images are shown with so-called hotspots in place. The hotspot leads to articles about the corresponding part of the car. Swipe horizontally over the screen to browse among the images.

- 2 Tap on a hotspot.
 - The title of the article about the area is shown.
- 3 Tap on the title to open the article.

To go back, press the back arrow.

Quick guide

Information to help you get started with the most commonly used functions in the car.

Video



Press the symbol to view brief instruction videos for various functions in the car.

Release notes

Read more about the current version and updates implemented.

Search function

Tap on the search field at the top of the owner's manual to access the search function from the homepage.

Use  at the top in the owner's manual to access the search function from other pages.

2. Your Volvo

2.1. Volvo ID

2.1.1. Volvo ID

Volvo ID is a personal ID that gives access to a wide range of services via a single username and password.

One example of a service when Volvo ID is needed is when checking the car on your phone using the Volvo Cars app.

Volvo ID is created from the car, volvoid.eu.volvocars.com/Account [https://volvoid.eu.volvocars.com/Account/] or the Volvo Cars app.

 **Note**

The services available may vary over time and depend on equipment level and market.

2.1.2. Creating a Volvo ID

A Volvo ID needs to be created in order to use the Volvo services connected to the car, e.g. via the Volvo Cars app.

Create a Volvo ID with the Volvo Cars app

- 1 Download the latest version of the Volvo Cars app^[1] to the phone.
 - 2 Select to create Volvo ID.
 - 3 The web page for creating a Volvo ID is shown.
 - 4 Enter a personal email address or mobile number.
 - 5 Follow the instructions that are automatically sent to the specified email address/mobile number.
- A Volvo ID has now been created and is ready for use.

Create a Volvo ID via the Volvo Cars website

The content of this manual represents the status of the user manual at the time of printing and may not be completely valid in future instances. For more information, refer to the first page for the complete disclaimer note.

- 1 Go to volvoid.eu.volvocars.com/Account [https://volvoid.eu.volvocars.com/Account/]. Select to create a Volvo ID.
- 2 Enter a personal email address or mobile number.
- 3 Follow the instructions that are automatically sent to the specified email address/mobile number.
 - A Volvo ID has now been created and is ready for use.

^[1] Available to download via e.g. Apple App Store or Google Play.

2.1.3. Problems logging in with Volvo ID

This article describes problems that may arise when logging in with Volvo ID. For example, if you have forgotten your password or your Volvo ID username.

Forgotten your password

To reset your password, follow the instructions below:

In the Volvo Cars app^[1]

- 1 Open the Volvo Cars app.
- 2 Select "Log in".
- 3 Press "Forgot password?" and follow the instructions shown.

You can also change your password at volvoid.eu.volvocars.com/Account [https://volvoid.eu.volvocars.com/Account/].

Login failure after creation of a new account

Sometimes there may be a delay in the process which can result in an account not being available directly after it has been created. Try again after 24 hours and if the problem remains, contact your local Volvo dealer or Volvo Cars customer service for further assistance.

What is my Volvo ID (username)?

Your Volvo ID is identical to the registered email address/mobile number.

Unlock your Volvo ID

Your account will be locked after 5 failed attempts to log in to the Volvo Cars app^[1]. You can easily unlock the account by clicking on **Forgotten password?** in the login screen.

Change of email address

If you change your email address and still have access to the old address you can log in with the old details and change your username yourself. If you no longer have access to the old address then you should create a new Volvo ID using the new address.

Login failure after changing Volvo ID (username)

Check that you have received a confirmation message in which your new username is confirmed. Once this has been done, you should be able to login with the new user name. If you did not receive the confirmation e-mail, your old username is probably still in place. Log in and try to change the username again.

Login failure after changed password

Try to login with your previous password. If this is not successful, try to reset the password.

Account registered to a different market

An account is registered to a specific market and cannot be moved to a different market. To be able to re-use the same email address/mobile number, we advise you to first delete your account for the old market and then create a new account for the new market.

E-mail failure

If you entered an email address as username and did not receive a confirmation email after registering, make sure that you entered a valid email address and that the email was not stopped by a spam filter. Try to register your e-mail address again.

More help

If you have not found a solution to a problem relating to Volvo ID and need more help, contact your local Volvo dealer or Volvo Cars Customer Service.

^[1] Applies to certain markets.

2.2. Type approvals and licences

2.2.1. License agreement for driver display

A license is an agreement for the right to operate a certain activity or the right to use someone else's entitlement according to the terms and conditions in the agreement. The following text is Volvo's agreement with the manufacturer or developer.

1.1 List of used Open Source Components

This table contains a list of open source software (OSS) components used within the product under the terms of the respective licenses. The source code corresponding to the open source components is also provided along with the product wherever mandated by the respective OSS license

SI No.	Name of OSS Component	Version of OSS Component	Name and Version of License (License text can be found in Appendix below)	Home Page	More Information
1	BidiReferenceCpp	26	Unicode Terms of Use	http://www.unicode.org/Public/PR4/OGRAMS/BidiReferenceCpp/	(C) Socionext Embedded Software Austria GmbH (SESA) Copyright (C) 1999-2009, ASMUS, Inc
2	FASTCRC32	1.2.8	License of Stephan brumme/ Zlib style License	http://stephan-brumme.com/	Copyright © 2011-2013 Stephan Brumme. All rights reserved, Copyright (C) 1995-2006, 2010, 2011, 2012 Mark Adler
3	Freescale IMX6 HDMI	5.0.11	BSD 3-clause "New" or "Revised" License	https://www.nxp.com/ [https://www.nxp.com/]	Copyright © 2009-2012, Freescale Semiconductor, Inc, Copyright © 2010-2012, Freescale Semiconductor, Inc.
4	FreeType Hashing	2.6.3	MIT License	https://sourceforge.net/p/canvasdraw/cd/642/tree/trunk/freetype/include/freetype/internal/fthash.h [http://sourceforge.net/p/canvasdraw/cd/642/tree/trunk/freetype/include/freetype/internal/fthash.h]	Copyright 2000 Computing Research Labs, New Mexico State University Copyright 2001-2015 Francesco Zappa Nardelli
5	Freetype Project - BDF	2.6.3	MIT License	https://sourceforge.net/projects/freetype/files/freetype2/2.6.3/ [http://www.freetype.org/]	Copyright (C) 2001-2014 by Francesco Zappa Nardelli. Copyright 2000 Computing Research Labs, New Mexico State University
6	Freetype Project - PCF	2.6.3	MIT License	https://sourceforge.net/projects/freetype/files/freetype2/2.6.3/ [http://www.freetype.org/]	Copyright 2000-2001, 2003 by Francesco Zappa Nardelli Copyright (C) 2000, 2001, 2002, 2003, 2006, 2010 by Francesco Zappa Nardelli Copyright (C) 2000-2004, 2006-2011, 2013, 2014 by Francesco Zappa Nardelli Copyright 2000-2010, 2012-2014 by Francesco Zappa Nardelli Copyright 2003 by Francesco Zappa Nardelli
7	Freetype Project - Pcfutil	2.6.3	Open Group License	https://sourceforge.net/projects/freetype/files/freetype2/2.6.3/ [http://www.freetype.org/]	Copyright 1990, 1994, 1998 The Open Group
8	HarfBuzz	1.3.1	MIT License	http://freedesktop.org/wiki/Software/HarfBuzz	Copyright © 2007 Chris Wilson Copyright © 2009,2010 Red Hat, Inc. Copyright © 2011, 2012 Google, Inc.

SI No.	Name of OSS Component	Version of OSS Component	Name and Version of License (License text can be found in Appendix below)	Home Page	More Information
9	Integrity Libnet	1.16	Internet Software Consortium-IBM License ISC License	https://github.com/lattera/glibc/blob/master/resolv/inetpton.c [http://netpton.c] [https://github.com/lattera/glibc/blob/master/resolv/inetpton.c]	Copyright © 1996 by Internet Software Consortium. Consortium, Copyright © 1995 by International Business Machines, Inc.
10	Khronos EGL Headers	1.4	MIT License	http://www.khronos.org/registry/egl/	Copyright © 2007-2013 The Khronos Group Inc. Copyright 2008 VMware, Inc. Copyright © 2013-2014 The Khronos Group Inc.
11	Khronos Group - OpenGL ES	2.0	SGI Free Software License B v2.0	http://www.khronos.org/opengles/	
12	libjpeg	6b	Independent JPEG Group License	http://www.ijg.org/	Copyright (C) 1991-1998, Thomas G. Lane.
13	libpng	1.4.22	libpng License	http://github.com/coapp-packages/libpng/	Copyright © 1998-2010 Glenn Randers-Pehrson Copyright © 2007, 2009 Glenn Randers-Pehrson Version 0.96 Copyright © 1996, 1997 Andreas Dilger Version 0.88 Copyright © 1995, 1996 Guy Eric Schalnat, Group 42, Inc.
14	Libunibreak	1.2.8	zlib License	https://github.com/adah1972/libunibreak [https://github.com/adah1972/libunibreak]	Copyright (C) 2008-2011 Wu Yongwei Copyright (C) 2012 Tom Hacoheh tom@stosb.com
15	Iz4 Compression algorithm	1.4.0	BSD 2-clause "Simplified" License	http://github.com/Cyan4973/iz4/	Copyright (C) 2011-2014, Yann Collet
16	md5	1.6	Public Domain	https://doxygen.reactos.org/d7/d04/sdk_2lib_23rdparty_2freetype_2src_2base_2md5_8c_source.html [https://doxygen.reactos.org/d7/d04/sdk_2lib_23rdparty_2freetype_2src_2base_2md5_8c_source.html]	
17	NetBSD	1.9	HPND like license IBM License BSD-4-Clause (University of California-Specific) BSD 3-clause "New" or "Revised" License BSD One Clause License	http://www.netbsd.org/	Copyright © 1998 Manuel Bouyer Copyright © 1996 Matt Thomas. Copyright 1997 Marshall Kirk McKusick. All Rights Reserved, Copyright © 1985, 1988, 1989, 1991, 1993, 1995 The Regents of the University of California Copyright © 1989, 1993 The Regents of the University of California Copyright © 1983, 1993 The Regents of the University of California Copyright 2000-2011 Green Hills Software Copyright (c) 1996 by Internet Software Consortium. Copyright (C) 1998 WIDE Project, Portions Copyright © 1995 by International Business Machines, Inc, Copyright (C) 1994, 1995, 1997 TooLs GmbH Copyright (C) 1994, 1995, 1997 Wolfgang Solfrank Copyright © 1995, 1999 Berkeley Software Design, Inc Portions Copyright © 1993 by Digital Equipment Corporation Copyright © 1992 Henry Spencer Copyright © 1997, 1998, 1999 The NetBSD Foundation, Inc Copyright © 1996 by Internet Software Consortium. Copyright (c) 1994 James A. Jegers(c) © UNIX System Laboratories, Inc.

SI No.	Name of OSS Component	Version of OSS Component	Name and Version of License (License text can be found in Appendix below)	Home Page	More Information
18	NetBSD_BSD4	1.9	BSD 4-clause "Original" or "Old" License	http://www.netbsd.org/	Copyright 2000-2011, 2000-2013 Green Hills Software, Copyright © 1994, 1998 Christopher G. Demetriou, Copyright © 1982, 1986, 1990, 1993, 1994 The Regents of the University of California. All rights reserved. © UNIX System Laboratories, Inc.
19	The FreeType Project - freetype2	2.6.3	Freetype Project License	http://sourceforge.net/projects/freetype/	Copyright 1996-2016 by David Turner, Robert Wilhelm, and Werner Lemberg, Copyright 2007-2016 by Rahul Bhalariao, Copyright 2009-2016 by Oran Agra and Mickey Gabel, Copyright 2008-2016 by David Turner, Robert Wilhelm, Werner Lemberg, and suzuki toshiya. Copyright 2000 Computing Research Labs, New Mexico State University, Copyright 2001-2015 Francesco Zappa Nardelli, Copyright 2004-2016 by Masatake YAMATO and Redhat K.K, Copyright 2007-2016 by Derek Clegg and Michael Toftdal, Copyright 2010-2016 by Joel Klinghed, Copyright 2007-2013 Adobe Systems Incorporated, Copyright 2007-2014 Adobe Systems Incorporated, Copyright 2004-2016 by Albert Chin-A-Young, Copyright 2013-2016 by Google, Inc, Copyright 2002-2016 by Roberto Alameda, Copyright 2003 Huw D M Davies for Codeweavers, Copyright 2007 Dmitry Timoshkov for Codeweavers
20	Vivante Driver software	viv5.0.11p7.4.i3	MIT License	http://www.vivante.com/	Copyright 2012 - 2016 Vivante Corporation, Santa Clara, California Copyright © 2007 The Khronos Group Inc Copyright © 2014 - 2016 Vivante Corporation Copyright 2012 Vivante Corporation, Sunnyvale, California Copyright © 2011 Intel Corporation Copyright (C) 1999-2001 Brian Paul
21	zlib	1.2.8	zlib License	http://www.zlib.net/	Copyright (C) 1995-2007 Mark Adler Copyright (C) 1995-2005 Jean-loup Gailly Copyright (C) 1995-2012 Mark Adler Copyright (C) 2003 Chris Anderson Copyright (C) 1998 Brian Raiter
22	RBTree.cpp	3.4.2	Public Domain	https://www.eu.socionext.com/	(C) Socionext Embedded Software Austria GmbH (SESA)

2. APPENDIX - LICENSE TEXT

2.1 HPND Like license

Portions Copyright (c) 1993 by Digital Equipment Corporation.

Permission to use, copy, modify, and distribute this software for any purpose with or without fee is hereby granted, provided that the above copyright notice and this permission notice appear in all copies, and that the name of Digital Equipment Corporation not be used in advertising or publicity pertaining to distribution of the document or software without specific, written prior permission.

THE SOFTWARE IS PROVIDED "AS IS" AND DIGITAL EQUIPMENT CORP. DISCLAIMS ALL WARRANTIES WITH REGARD TO THIS SOFTWARE, INCLUDING ALL IMPLIED WARRANTIES OF MERCHANTABILITY AND FITNESS. IN NO EVENT SHALL DIGITAL EQUIPMENT CORPORATION BE LIABLE FOR ANY SPECIAL, DIRECT, INDIRECT, OR CONSEQUENTIAL DAMAGES OR ANY DAMAGES WHATSOEVER RESULTING FROM LOSS OF USE, DATA OR PROFITS, WHETHER IN AN ACTION OF CONTRACT, NEGLIGENCE OR OTHER TORTIOUS ACTION, ARISING OUT OF OR IN CONNECTION WITH THE USE OR PERFORMANCE OF THIS SOFTWARE.

2.2 BSD 2-clause "Simplified" License

BSD Two Clause License

Redistribution and use in source and binary forms, with or without modification, are permitted provided that the following conditions are met: Redistributions of source code must retain the above copyright notice, this list of conditions and the following

disclaimer. Redistributions in binary form must reproduce the above copyright notice, this list of conditions and the following disclaimer in the documentation and/or other materials provided with the distribution.

THIS SOFTWARE IS PROVIDED BY THE AUTHOR "AS IS" AND ANY EXPRESS OR IMPLIED WARRANTIES, INCLUDING, BUT NOT LIMITED TO, THE IMPLIED WARRANTIES OF MERCHANTABILITY AND FITNESS FOR A PARTICULAR PURPOSE ARE DISCLAIMED. IN NO EVENT SHALL THE AUTHOR BE LIABLE FOR ANY DIRECT, INDIRECT, INCIDENTAL, SPECIAL, EXEMPLARY, OR CONSEQUENTIAL DAMAGES (INCLUDING, BUT NOT LIMITED TO, PROCUREMENT OF SUBSTITUTE GOODS OR SERVICES; LOSS OF USE, DATA, OR PROFITS; OR BUSINESS INTERRUPTION) HOWEVER CAUSED AND ON ANY THEORY OF LIABILITY, WHETHER IN CONTRACT, STRICT LIABILITY, OR TORT (INCLUDING NEGLIGENCE OR OTHERWISE) ARISING IN ANY WAY OUT OF THE USE OF THIS SOFTWARE, EVEN IF ADVISED OF THE POSSIBILITY OF SUCH DAMAGE.

2.3 IBM License

Portions Copyright (c) 1995 by International Business Machines, Inc.

International Business Machines, Inc. (hereinafter called IBM) grants permission under its copyrights to use, copy, modify, and distribute this Software with or without fee, provided that the above copyright notice and all paragraphs of this notice appear in all copies, and that the name of IBM not be used in connection with the marketing of any product incorporating the Software or modifications thereof, without specific, written prior permission.

To the extent it has a right to do so, IBM grants an immunity from suit under its patents, if any, for the use, sale or manufacture of products to the extent that such products are used for performing Domain Name System dynamic updates in TCP/IP networks by means of the Software. No immunity is granted for any product per se or for any other function of any product.

THE SOFTWARE IS PROVIDED "AS IS", AND IBM DISCLAIMS ALL WARRANTIES, INCLUDING ALL IMPLIED WARRANTIES OF MERCHANTABILITY AND FITNESS FOR A PARTICULAR PURPOSE. IN NO EVENT SHALL IBM BE LIABLE FOR ANY SPECIAL, DIRECT, INDIRECT, OR CONSEQUENTIAL DAMAGES OR ANY DAMAGES WHATSOEVER ARISING OUT OF OR IN CONNECTION WITH THE USE OR PERFORMANCE OF THIS SOFTWARE, EVEN IF IBM IS APPRISED OF THE POSSIBILITY OF SUCH DAMAGES.

2.4 BSD 3-clause "New" or "Revised" License

Copyright/Copyright holders – see List of Open Source Components

All rights reserved.

Redistribution and use in source and binary forms, with or without modification, are permitted provided that the following conditions are met:

Redistributions of source code must retain the above copyright notice, this list of conditions and the following disclaimer. Redistributions in binary form must reproduce the above copyright notice, this list of conditions and the following disclaimer in the documentation and/or other materials provided with the distribution. Neither the name of the [ORGANIZATION] nor the names of its contributors may be used to endorse or promote products derived from this software without specific prior written permission.

THIS SOFTWARE IS PROVIDED BY THE COPYRIGHT HOLDERS AND CONTRIBUTORS "AS IS" AND ANY EXPRESS OR IMPLIED WARRANTIES, INCLUDING, BUT NOT LIMITED TO, THE IMPLIED WARRANTIES OF MERCHANTABILITY AND FITNESS FOR A PARTICULAR PURPOSE ARE DISCLAIMED. IN NO EVENT SHALL THE COPYRIGHT OWNER OR CONTRIBUTORS BE LIABLE FOR ANY DIRECT, INDIRECT, INCIDENTAL, SPECIAL, EXEMPLARY, OR CONSEQUENTIAL DAMAGES (INCLUDING, BUT NOT LIMITED TO, PROCUREMENT OF SUBSTITUTE GOODS OR SERVICES; LOSS OF USE, DATA, OR PROFITS; OR BUSINESS INTERRUPTION) HOWEVER CAUSED AND ON ANY THEORY OF LIABILITY, WHETHER IN CONTRACT, STRICT LIABILITY, OR TORT (INCLUDING NEGLIGENCE OR OTHERWISE) ARISING IN ANY WAY OUT OF THE USE OF THIS SOFTWARE, EVEN IF ADVISED OF THE POSSIBILITY OF SUCH DAMAGE.

2.5 BSD 4-clause "Original" or "Old" License

Copyright/Copyright holders – see List of Open Source Components

All rights reserved.

Redistribution and use in source and binary forms, with or without modification, are permitted provided that the following conditions are met:

1. Redistributions of source code must retain the above copyright notice, this list of conditions and the following disclaimer.
2. Redistributions in binary form must reproduce the above copyright notice, this list of conditions and the following disclaimer in the documentation and/or other materials provided with the distribution.
3. All advertising materials mentioning features or use of this software must display the following acknowledgement: This product includes software developed by the organization.
4. Neither the name of the organization nor the names of its contributors may be used to endorse or promote products derived from this software without specific prior written permission.

THIS SOFTWARE IS PROVIDED BY COPYRIGHT HOLDER "AS IS" AND ANY EXPRESS OR IMPLIED WARRANTIES, INCLUDING, BUT NOT LIMITED TO, THE IMPLIED WARRANTIES OF MERCHANTABILITY AND FITNESS FOR A PARTICULAR PURPOSE ARE DISCLAIMED. IN NO EVENT SHALL {{COPYRIGHT HOLDER}} BE LIABLE FOR ANY DIRECT, INDIRECT, INCIDENTAL, SPECIAL, EXEMPLARY, OR CONSEQUENTIAL DAMAGES (INCLUDING, BUT NOT LIMITED TO, PROCUREMENT OF SUBSTITUTE GOODS OR SERVICES; LOSS OF USE, DATA, OR PROFITS; OR BUSINESS INTERRUPTION) HOWEVER CAUSED AND ON ANY THEORY OF LIABILITY, WHETHER IN CONTRACT, STRICT LIABILITY, OR TORT (INCLUDING NEGLIGENCE OR OTHERWISE) ARISING IN ANY WAY OUT OF THE USE OF THIS SOFTWARE, EVEN IF ADVISED OF THE POSSIBILITY OF SUCH DAMAGE.

2.6 BSD-4-Clause (University of California-Specific)

BSD-4-Clause (University of California-Specific)

Copyright/Copyright holders – see List of Open Source Components

Redistribution and use in source and binary forms, with or without modification, are permitted provided that the following conditions are met:

1. Redistributions of source code must retain the above copyright notice, this list of conditions and the following disclaimer.
2. Redistributions in binary form must reproduce the above copyright notice, this list of conditions and the following disclaimer in the documentation and/or other materials provided with the distribution.
3. All advertising materials mentioning features or use of this software must display the following acknowledgement: This product includes software developed by the University of California, Berkeley and its contributors.
4. Neither the name of the University nor the names of its contributors may be used to endorse or promote products derived from this software without specific prior written permission.

THIS SOFTWARE IS PROVIDED BY THE REGENTS AND CONTRIBUTORS "AS IS" AND ANY EXPRESS OR IMPLIED WARRANTIES, INCLUDING, BUT NOT LIMITED TO, THE IMPLIED WARRANTIES OF MERCHANTABILITY AND FITNESS FOR A PARTICULAR PURPOSE ARE DISCLAIMED. IN NO EVENT SHALL THE REGENTS OR CONTRIBUTORS BE LIABLE FOR ANY DIRECT, INDIRECT, INCIDENTAL, SPECIAL, EXEMPLARY, OR CONSEQUENTIAL DAMAGES (INCLUDING, BUT NOT LIMITED TO, PROCUREMENT OF SUBSTITUTE GOODS OR SERVICES; LOSS OF USE, DATA, OR PROFITS; OR BUSINESS INTERRUPTION) HOWEVER CAUSED AND ON ANY THEORY OF LIABILITY, WHETHER IN CONTRACT, STRICT LIABILITY, OR TORT (INCLUDING NEGLIGENCE OR OTHERWISE) ARISING IN ANY WAY OUT OF THE USE OF THIS SOFTWARE, EVEN IF ADVISED OF THE POSSIBILITY OF SUCH DAMAGE.

2.7 Freetype Project License

The FreeType Project LICENSE

2006-Jan-27

Copyright 1996-2002, 2006 by David Turner, Robert Wilhelm, and Werner Lemberg

Introduction

The FreeType Project is distributed in several archive packages; some of them may contain, in addition to the FreeType font engine, various tools and contributions which rely on, or relate to, the FreeType Project. This license applies to all files found in such packages, and which do not fall under their own explicit license. The license affects thus the FreeType font engine, the test programs, documentation and makefiles, at the very least. This license was inspired by the BSD, Artistic, and IJG (Independent JPEG Group) licenses, which all encourage inclusion and use of free software in commercial and freeware products alike. As a consequence, its main points are that:

We don't promise that this software works. However, we will be interested in any kind of bug reports. ('as is' distribution)

You can use this software for whatever you want, in parts or full form, without having to pay us. ('royalty-free' usage)

You may not pretend that you wrote this software. If you use it, or only parts of it, in a program, you must acknowledge somewhere in your documentation that you have used the FreeType code. ('credits')

We specifically permit and encourage the inclusion of this software, with or without modifications, in commercial products. We disclaim all warranties covering The FreeType Project and assume no liability related to The FreeType Project. Finally, many people asked us for a preferred form for a credit/disclaimer to use in compliance with this license. We thus encourage you to use the following text: "Portions of this software are copyright © 1996-2002, 2006 The FreeType Project (www.freetype.org). All rights reserved."

Definitions

Throughout this license, the terms 'package', 'FreeType Project', and 'FreeType archive' refer to the set of files originally distributed by the authors (David Turner, Robert Wilhelm, and Werner Lemberg) as the 'FreeType Project', be they named as alpha, beta or final release. 'You' refers to the licensee, or person using the project, where 'using' is a generic term including compiling the project's source code as well as linking it to form a 'program' or 'executable'. This program is referred to as 'a program using the FreeType engine'. This license applies to all files distributed in the original FreeType Project, including all source code, binaries and documentation, unless otherwise stated in the file in its original, unmodified form as distributed in the original archive. If you are unsure whether or not a particular file is covered by this license, you must contact us to verify this.

No Warranty

THE FREETYPE PROJECT IS PROVIDED 'AS IS' WITHOUT WARRANTY OF ANY KIND, EITHER EXPRESS OR IMPLIED, INCLUDING, BUT NOT LIMITED TO, WARRANTIES OF MERCHANTABILITY AND FITNESS FOR A PARTICULAR PURPOSE. IN NO EVENT WILL ANY OF THE AUTHORS OR COPYRIGHT HOLDERS BE LIABLE FOR ANY DAMAGES CAUSED BY THE USE OR THE INABILITY TO USE, OF THE FREETYPE PROJECT. Redistribution

Redistribution

This license grants a worldwide, royalty-free, perpetual and irrevocable right and license to use, execute, perform, compile, display, copy, create derivative works of, distribute and sublicense the FreeType Project (in both source and object code forms) and derivative works thereof for any purpose; and to authorize others to exercise some or all of the rights granted herein, subject to the following conditions:

Redistribution of source code must retain this license file ('FTL.TXT') unaltered; any additions, deletions or changes to the original files must be clearly indicated in accompanying documentation. The copyright notices of the unaltered, original files must be preserved in all copies of source files. Redistribution in binary form must provide a disclaimer that states that the software is based in part of the work of the FreeType Team, in the distribution documentation. We also encourage you to put an URL to the FreeType web page in your documentation, though this isn't mandatory. These conditions apply to any software derived from or based on the FreeType Project, not just the unmodified files. If you use our work, you must acknowledge us. However, no fee need be paid to us.

Advertising

Neither the FreeType authors and contributors nor you shall use the name of the other for commercial, advertising, or promotional purposes without specific prior written permission. We suggest, but do not require, that you use one or more of the following phrases to refer to this software in your documentation or advertising materials: 'FreeType Project', 'FreeType Engine', 'FreeType library', or 'FreeType Distribution'. As you have not signed this license, you are not required to accept it. However, as the FreeType Project is copyrighted material, only this license, or another one contracted with the authors, grants you the right to use, distribute, and modify it. Therefore, by using, distributing, or modifying the FreeType Project, you indicate that you understand and accept all the terms of this license.

Contacts

There are two mailing lists related to FreeType:

freetype@nongnu.org

Discusses general use and applications of FreeType, as well as future and wanted additions to the library and distribution. If you are looking for support, start in this list if you haven't found anything to help you in the documentation.

devel@nongnu.org

Discusses bugs, as well as engine internals, design issues, specific licenses, porting, etc.

Our home page can be found at: <http://www.freetype.org>

2.8 Independent JPEG Group License

The Independent JPEG Group's JPEG software README for release 6b of 27-Mar-1998

This distribution contains the sixth public release of the Independent JPEG Group's free JPEG software. You are welcome to redistribute this software and to use it for any purpose, subject to the conditions under LEGAL ISSUES, below. Serious users of this software (particularly those incorporating it into larger programs) should contact IJG at jpeg-info@uunet.uu.net to be added to our electronic mailing list. Mailing list members are notified of updates and have a chance to participate in technical discussions, etc. This software is the work of Tom Lane, Philip Gladstone, Jim Boucher, Lee Crocker, Julian Minguillon, Luis Ortiz, George Phillips, Davide Rossi, Guido Vollbeding, Ge' Weijers, and other members of the Independent JPEG Group. IJG is not affiliated with the official ISO JPEG standards committee.

LEGAL ISSUES

In plain English:

We don't promise that this software works. (But if you find any bugs, please let us know!) You can use this software for whatever you want. You don't have to pay us. You may not pretend that you wrote this software. If you use it in a program, you must acknowledge somewhere in your documentation that you've used the IJG code.

In legalese:

The authors make NO WARRANTY or representation, either express or implied, with respect to this software, its quality, accuracy, merchantability, or fitness for a particular purpose. This software is provided "AS IS", and you, its user, assume the entire risk as to its quality and accuracy. This software is copyright (C) 1991-1998, Thomas G. Lane. All Rights Reserved except as specified below.

Permission is hereby granted to use, copy, modify, and distribute this software (or portions thereof) for any purpose, without fee, subject to these conditions:

1. If any part of the source code for this software is distributed, then this README file must be included, with this copyright and no-warranty notice unaltered; and any additions, deletions, or changes to the original files must be clearly indicated in accompanying documentation.
2. If only executable code is distributed, then the accompanying documentation must state that "this software is based in part on the work of the Independent JPEG Group".
3. Permission for use of this software is granted only if the user accepts full responsibility for any undesirable consequences; the authors accept NO LIABILITY for damages of any kind.

These conditions apply to any software derived from or based on the IJG code, not just to the unmodified library. If you use our work, you ought to acknowledge us.

Permission is NOT granted for the use of any IJG author's name or company name in advertising or publicity relating to this software or products derived from it. This software may be referred to only as "the Independent JPEG Group's software".

We specifically permit and encourage the use of this software as the basis of commercial products, provided that all warranty or liability claims are assumed by the product vendor. `ansi2knr.c` is included in this distribution by permission of L. Peter Deutsch, sole proprietor of its copyright holder, Aladdin Enterprises of Menlo Park, CA. `ansi2knr.c` is NOT covered by the above copyright and conditions, but instead by the usual distribution terms of the Free Software Foundation; principally, that you must include source code if you redistribute it. (See the file `ansi2knr.c` for full details.)

However, since `ansi2knr.c` is not needed as part of any program generated from the IJG code, this does not limit you more than the foregoing paragraphs do. The Unix configuration script "configure" was produced with GNU Autoconf. It is copyright by the Free Software Foundation but is freely distributable. The same holds for its supporting scripts (`config.guess`, `config.sub`, `ltconfig`, `ltmain.sh`). Another support script, `install-sh`, is copyright by M.I.T. but is also freely distributable.

It appears that the arithmetic coding option of the JPEG spec is covered by patents owned by IBM, AT&T, and Mitsubishi. Hence arithmetic coding cannot legally be used without obtaining one or more licenses. For this reason, support for arithmetic coding has been removed from the free JPEG software. (Since arithmetic coding provides only a marginal gain over the unpatented Huffman mode, it is unlikely that very many implementations will support it.) So far as we are aware, there are no patent restrictions on the remaining code.

The IJG distribution formerly included code to read and write GIF files. To avoid entanglement with the Unisys LZW patent, GIF reading support has been removed altogether, and the GIF writer has been simplified to produce "uncompressed GIFs". This technique does not use the LZW algorithm; the resulting GIF files are larger than usual, but are readable by all standard GIF decoders. We are required to state that:

"The Graphics Interchange Format(c) is the Copyright property of CompuServe Incorporated. GIF(sm) is a Service Mark property of CompuServe Incorporated."

2.9 Internet Software Consortium-IBM License

Copyright (c) 1996 by Internet Software Consortium.

Permission to use, copy, modify, and distribute this software for any purpose with or without fee is hereby granted, provided that the above copyright notice and this permission notice appear in all copies.

THE SOFTWARE IS PROVIDED "AS IS" AND INTERNET SOFTWARE CONSORTIUM DISCLAIMS ALL WARRANTIES WITH REGARD TO THIS SOFTWARE INCLUDING ALL IMPLIED WARRANTIES OF MERCHANTABILITY AND FITNESS. IN NO EVENT SHALL INTERNET SOFTWARE CONSORTIUM BE LIABLE FOR ANY SPECIAL, DIRECT, INDIRECT, OR CONSEQUENTIAL DAMAGES OR ANY DAMAGES WHATSOEVER RESULTING FROM LOSS OF USE, DATA OR PROFITS, WHETHER IN AN ACTION OF CONTRACT, NEGLIGENCE OR OTHER TORTIOUS ACTION, ARISING OUT OF OR IN CONNECTION WITH THE USE OR PERFORMANCE OF THIS SOFTWARE.

Portions Copyright (c) 1995 by International Business Machines, Inc.

International Business Machines, Inc. (hereinafter called IBM) grants permission under its copyrights to use, copy, modify, and distribute this Software with or without fee, provided that the above copyright notice and all paragraphs of this notice appear in all copies, and that the name of IBM not be used in connection with the marketing of any product incorporating the Software or modifications thereof, without specific, written prior permission.

To the extent it has a right to do so, IBM grants an immunity from suit under its patents, if any, for the use, sale or manufacture of products to the extent that such products are used for performing Domain Name System dynamic updates in TCP/IP networks by means of the Software. No immunity is granted for any product per se or for any other function of any product.

THE SOFTWARE IS PROVIDED "AS IS", AND IBM DISCLAIMS ALL WARRANTIES, INCLUDING ALL IMPLIED WARRANTIES OF MERCHANTABILITY AND FITNESS FOR A PARTICULAR PURPOSE. IN NO EVENT SHALL IBM BE LIABLE FOR ANY SPECIAL, DIRECT, INDIRECT, OR CONSEQUENTIAL DAMAGES OR ANY DAMAGES WHATSOEVER ARISING OUT OF OR IN CONNECTION WITH THE USE OR PERFORMANCE OF THIS SOFTWARE, EVEN IF IBM IS APPRISED OF THE POSSIBILITY OF SUCH DAMAGES.

2.10 Khronos License

Copyright (c) 2013 The Khronos Group Inc.

** ** Permission is hereby granted, free of charge, to any person obtaining a ** copy of this software and/or associated documentation files (the ** "Materials"), to deal in the Materials without restriction, including ** without limitation the rights to use, copy, modify, merge, publish, ** distribute, sublicense, and/or sell copies of the Materials, and to ** permit persons to whom the Materials are furnished to do so, subject to ** the following conditions: ** ** The above copyright notice and this permission notice shall be included ** in all copies or substantial portions of the Materials. **

** THE MATERIALS ARE PROVIDED "AS IS", WITHOUT WARRANTY OF ANY KIND, ** EXPRESS OR IMPLIED, INCLUDING BUT NOT LIMITED TO THE WARRANTIES OF ** MERCHANTABILITY, FITNESS FOR A PARTICULAR PURPOSE AND NONINFRINGEMENT. ** IN NO EVENT SHALL THE AUTHORS OR COPYRIGHT HOLDERS BE LIABLE FOR ANY ** CLAIM, DAMAGES OR OTHER LIABILITY, WHETHER IN AN ACTION OF CONTRACT, ** TORT OR OTHERWISE, ARISING FROM, OUT OF OR IN CONNECTION WITH THE ** MATERIALS OR THE USE OR OTHER DEALINGS IN THE MATERIALS.

2.11 License of Stephan Brumme/ Zlib style License

This software is provided 'as-is', without any express or implied warranty. In no event will the author be held liable for any damages arising from the use of this software. Permission is granted to anyone to use this software for any purpose, including commercial applications, and to alter it and redistribute it freely, subject to the following restrictions: The origin of this software must not be misrepresented; you must not claim that you wrote the original software. If you use this software in a product, an acknowledgment in the product documentation would be appreciated but is not required. Altered source versions must be plainly marked as such, and must not be misrepresented as being the original software.

2.12 MIT License

The MIT License

Copyright/Copyright holders – see List of Open Source Components

Permission is hereby granted, free of charge, to any person obtaining a copy of this software and associated documentation files (the "Software"), to deal in the Software without restriction, including without limitation the rights to use, copy, modify, merge, publish, distribute, sublicense, and/or sell copies of the Software, and to permit persons to whom the Software is furnished to do so, subject to the following conditions:

The above copyright notice and this permission notice shall be included in all copies or substantial portions of the Software.

THE SOFTWARE IS PROVIDED "AS IS", WITHOUT WARRANTY OF ANY KIND, EXPRESS OR IMPLIED, INCLUDING BUT NOT LIMITED TO THE WARRANTIES OF MERCHANTABILITY, FITNESS FOR A PARTICULAR PURPOSE AND NONINFRINGEMENT. IN NO EVENT SHALL THE AUTHORS OR COPYRIGHT HOLDERS BE LIABLE FOR ANY CLAIM, DAMAGES OR OTHER LIABILITY, WHETHER IN AN ACTION OF CONTRACT, TORT OR OTHERWISE, ARISING FROM, OUT OF OR IN CONNECTION WITH THE SOFTWARE OR THE USE OR OTHER DEALINGS IN THE SOFTWARE.

2.13 Open Group License

Copyright 1996, 1998 The Open Group.

Permission to use, copy, modify, distribute, and sell this software and its documentation for any purpose is hereby granted without fee, provided that the above copyright notice appear in all copies and that both that copyright notice and this permission notice appear in supporting documentation. The above copyright notice and this permission notice shall be included in all copies or substantial portions of the Software.

THE SOFTWARE IS PROVIDED "AS IS", WITHOUT WARRANTY OF ANY KIND, EXPRESS OR IMPLIED, INCLUDING BUT NOT LIMITED TO THE WARRANTIES OF MERCHANTABILITY, FITNESS FOR A PARTICULAR PURPOSE AND NONINFRINGEMENT. IN NO EVENT SHALL THE OPEN GROUP BE LIABLE FOR ANY CLAIM, DAMAGES OR OTHER LIABILITY, WHETHER IN AN ACTION OF CONTRACT, TORT OR OTHERWISE, ARISING FROM, OUT OF OR IN CONNECTION WITH THE SOFTWARE OR THE USE OR OTHER DEALINGS IN THE SOFTWARE.

Except as contained in this notice, the name of The Open Group shall not be used in advertising or otherwise to promote the sale, use or other dealings in this Software without prior written authorization from The Open Group.

2.14 Public Domain

Public domain code is not subject to any license.

2.15 BSD One Clause License

BSD One Clause License

Copyright/Copyright holders – see List of Open Source Components

All rights reserved.

Redistribution and use in source and binary forms, with or without modification, are permitted provided that the following conditions are met:

* Redistributions of source code must retain the above copyright notice, this list of conditions and the following disclaimer.

THIS SOFTWARE IS PROVIDED BY THE COPYRIGHT HOLDERS AND CONTRIBUTORS "AS IS" AND ANY EXPRESS OR IMPLIED WARRANTIES, INCLUDING, BUT NOT LIMITED TO, THE IMPLIED WARRANTIES OF MERCHANTABILITY AND FITNESS FOR A PARTICULAR PURPOSE ARE DISCLAIMED. IN NO EVENT SHALL THE COPYRIGHT OWNER OR CONTRIBUTORS BE LIABLE FOR ANY DIRECT, INDIRECT, INCIDENTAL, SPECIAL, EXEMPLARY, OR CONSEQUENTIAL DAMAGES (INCLUDING, BUT NOT LIMITED TO, PROCUREMENT OF SUBSTITUTE GOODS OR SERVICES; LOSS OF USE, DATA, OR PROFITS; OR BUSINESS INTERRUPTION) HOWEVER CAUSED AND ON ANY THEORY OF LIABILITY, WHETHER

IN CONTRACT, STRICT LIABILITY, OR TORT (INCLUDING NEGLIGENCE OR OTHERWISE) ARISING IN ANY WAY OUT OF THE USE OF THIS SOFTWARE, EVEN IF ADVISED OF THE POSSIBILITY OF SUCH DAMAGE.

2.16 ISC License

ISC License (ISCL)

Copyright/Copyright holders – see List of Open Source Components

Permission to use, copy, modify, and/or distribute this software for any purpose with or without fee is hereby granted, provided that the above copyright notice and this permission notice appear in all copies.

THE SOFTWARE IS PROVIDED "AS IS" AND THE AUTHOR DISCLAIMS ALL WARRANTIES WITH REGARD TO THIS SOFTWARE INCLUDING ALL IMPLIED WARRANTIES OF MERCHANTABILITY AND FITNESS. IN NO EVENT SHALL THE AUTHOR BE LIABLE FOR ANY SPECIAL, DIRECT, INDIRECT, OR CONSEQUENTIAL DAMAGES OR ANY DAMAGES WHATSOEVER RESULTING FROM LOSS OF USE, DATA OR PROFITS, WHETHER IN AN ACTION OF CONTRACT, NEGLIGENCE OR OTHER TORTIOUS ACTION, ARISING OUT OF OR IN CONNECTION WITH THE USE OR PERFORMANCE OF THIS SOFTWARE.

2.17 SGI Free Software License B v2.0

ISC License (ISCL)

Copyright/Copyright holders – see List of Open Source Components

Permission is hereby granted, free of charge, to any person obtaining a copy of this software and associated documentation files (the "Software"), to deal in the Software without restriction, including without limitation the rights to use, copy, modify, merge, publish, distribute, sublicense, and/or sell copies of the Software, and to permit persons to whom the Software is furnished to do so, subject to the following conditions:

The above copyright notice including the dates of first publication and either this permission notice or a reference to <http://oss.sgi.com/projects/FreeB/> shall be included in all copies or substantial portions of the Software.

THE SOFTWARE IS PROVIDED "AS IS" AND THE AUTHOR DISCLAIMS ALL WARRANTIES WITH REGARD TO THIS SOFTWARE INCLUDING ALL IMPLIED WARRANTIES OF MERCHANTABILITY AND FITNESS. IN NO EVENT SHALL THE AUTHOR BE LIABLE FOR ANY SPECIAL, DIRECT, INDIRECT, OR CONSEQUENTIAL DAMAGES OR ANY DAMAGES WHATSOEVER RESULTING FROM LOSS OF USE, DATA OR PROFITS, WHETHER IN AN ACTION OF CONTRACT, NEGLIGENCE OR OTHER TORTIOUS ACTION, ARISING OUT OF OR IN CONNECTION WITH THE USE OR PERFORMANCE OF THIS SOFTWARE.

Except as contained in this notice, the name of Silicon Graphics, Inc. shall not be used in advertising or otherwise to promote the sale, use or other dealings in this Software without prior written authorization from Silicon Graphics, Inc.

2.18 Unicode Terms of Use

For the general privacy policy governing access to this site, see the Unicode Privacy Policy. For trademark usage, see the Unicode® Consortium Name and Trademark Usage Policy.

A. Unicode Copyright.

1. Copyright © 1991-2014 Unicode, Inc. All rights reserved.
2. Certain documents and files on this website contain a legend indicating that "Modification is permitted." Any person is hereby authorized, without fee, to modify such documents and files to create derivative works conforming to the Unicode® Standard, subject to Terms and Conditions herein.

3. Any person is hereby authorized, without fee, to view, use, reproduce, and distribute all documents and files solely for informational purposes in the creation of products supporting the Unicode Standard, subject to the Terms and Conditions herein.
4. Further specifications of rights and restrictions pertaining to the use of the particular set of data files known as the "Unicode Character Database" can be found in Exhibit 1.
5. Each version of the Unicode Standard has further specifications of rights and restrictions of use. For the book editions (Unicode 5.0 and earlier), these are found on the back of the title page. The online code charts carry specific restrictions. All other files, including online documentation of the core specification for Unicode 6.0 and later, are covered under these general Terms of Use.
6. No license is granted to "mirror" the Unicode website where a fee is charged for access to the "mirror" site.
7. Modification is not permitted with respect to this document. All copies of this document must be verbatim.

B. Restricted Rights Legend.

Any technical data or software which is licensed to the United States of America, its agencies and/or instrumentalities under this Agreement is commercial technical data or commercial computer software developed exclusively at private expense as defined in FAR 2.101, or DFARS 252.227-7014 (June 1995), as applicable. For technical data, use, duplication, or disclosure by the Government is subject to restrictions as set forth in DFARS 202.227-7015 Technical Data, Commercial and Items (Nov 1995) and this Agreement. For Software, in accordance with FAR 12-212 or DFARS 227-7202, as applicable, use, duplication or disclosure by the Government is subject to the restrictions set forth in this Agreement.

C. Warranties and Disclaimers.

1. This publication and/or website may include technical or typographical errors or other inaccuracies. Changes are periodically added to the information herein; these changes will be incorporated in new editions of the publication and/or website. Unicode may make improvements and/or changes in the product(s) and/or program(s) described in this publication and/or website at any time.
2. If this file has been purchased on magnetic or optical media from Unicode, Inc. the sole and exclusive remedy for any claim will be exchange of the defective media within ninety (90) days of original purchase.
3. EXCEPT AS PROVIDED IN SECTION C.2, THIS PUBLICATION AND/OR SOFTWARE IS PROVIDED "AS IS" WITHOUT WARRANTY OF ANY KIND EITHER EXPRESS, IMPLIED, OR STATUTORY, INCLUDING, BUT NOT LIMITED TO, ANY WARRANTIES OF MERCHANTABILITY, FITNESS FOR A PARTICULAR PURPOSE, OR NON-INFRINGEMENT. UNICODE AND ITS LICENSORS ASSUME NO RESPONSIBILITY FOR ERRORS OR OMISSIONS IN THIS PUBLICATION AND/OR SOFTWARE OR OTHER DOCUMENTS WHICH ARE REFERENCED BY OR LINKED TO THIS PUBLICATION OR THE UNICODE WEBSITE.

D. Waiver of Damages.

In no event shall Unicode or its licensors be liable for any special, incidental, indirect or consequential damages of any kind, or any damages whatsoever, whether or not Unicode was advised of the possibility of the damage, including, without limitation, those resulting from the following: loss of use, data or profits, in connection with the use, modification or distribution of this information or its derivatives.

E. Trademarks & Logos.

1. The Unicode Word Mark and the Unicode Logo are trademarks of Unicode, Inc. "The Unicode Consortium" and "Unicode, Inc." are trade names of Unicode, Inc. Use of the information and materials found on this website indicates your acknowledgement of Unicode, Inc.'s exclusive worldwide rights in the Unicode Word Mark, the Unicode Logo, and the Unicode trade names.
2. The Unicode Consortium Name and Trademark Usage Policy ("Trademark Policy") are incorporated herein by reference and you agree to abide by the provisions of the Trademark Policy, which may be changed from time to time in the sole

The content of this manual represents the status of the user manual at the time of printing and may not be completely valid in future instances. For more information, refer to the first page for the complete disclaimer note.

discretion of Unicode, Inc.

3. All third party trademarks referenced herein are the property of their respective owners.

F. Miscellaneous.

1. **Jurisdiction and Venue.** This server is operated from a location in the State of California, United States of America. Unicode makes no representation that the materials are appropriate for use in other locations. If you access this server from other locations, you are responsible for compliance with local laws. This Agreement, all use of this site and any claims and damages resulting from use of this site are governed solely by the laws of the State of California without regard to any principles which would apply the laws of a different jurisdiction. The user agrees that any disputes regarding this site shall be resolved solely in the courts located in Santa Clara County, California. The user agrees said courts have personal jurisdiction and agree to waive any right to transfer the dispute to any other forum.
2. **Modification by Unicode.** Unicode shall have the right to modify this Agreement at any time by posting it to this site. The user may not assign any part of this Agreement without Unicode's prior written consent.
3. **Taxes.** The user agrees to pay any taxes arising from access to this website or use of the information herein, except for those based on Unicode's net income.
4. **Severability.** If any provision of this Agreement is declared invalid or unenforceable, the remaining provisions of this Agreement shall remain in effect.
5. **Entire Agreement.** This Agreement constitutes the entire agreement between the parties.

2.19 libpng License

This copy of the libpng notices is provided for your convenience. In case of any discrepancy between this copy and the notices in the file png.h that is included in the libpng distribution, the latter shall prevail.

COPYRIGHT NOTICE, DISCLAIMER, and LICENSE:

The above copyright notice and this permission notice shall be included in all copies or substantial portions of the Software.

If you modify libpng you may insert additional notices immediately following this sentence. libpng versions 1.0.7, July 1, 2000, through 1.0.13, April 15, 2002, are Copyright (c) 2000-2002 Glenn Randers-Pehrson and are distributed according to the same disclaimer and license as libpng-1.0.6 with the following individuals added to the list of Contributing Authors:

Simon-Pierre Cadieux, Eric S. Raymond, Gilles Vollant

and with the following additions to the disclaimer:

There is no warranty against interference with your enjoyment of the library or against infringement. There is no warranty that our efforts or the library will fulfill any of your particular purposes or needs. This library is provided with all faults, and the entire risk of satisfactory quality, performance, accuracy, and effort is with the user.

libpng versions 0.97, January 1998, through 1.0.6, March 20, 2000, are Copyright (c) 1998, 1999 Glenn Randers-Pehrson, and are distributed according to the same disclaimer and license as libpng-0.96, with the following individuals added to the list of Contributing Authors:

Tom Lane, Glenn Randers-Pehrson, Willem van Schaik.

libpng versions 0.89, June 1996, through 0.96, May 1997, are Copyright (c) 1996, 1997 Andreas Dilger Distributed according to the same disclaimer and license as libpng-0.88, with the following individuals added to the list of Contributing Authors:

John Bowler, Kevin Bracey, Sam Bushe, Magnus Holmgren, Greg Roelofs, Tom Tanner.

libpng versions 0.5, May 1995, through 0.88, January 1996, are Copyright (c) 1995, 1996 Guy Eric Schalnat, Group 42, Inc. For the purposes of this copyright and license, "Contributing Authors" is defined as the following set of individuals:

The content of this manual represents the status of the user manual at the time of printing and may not be completely valid in future instances. For more information, refer to the first page for the complete disclaimer note.

Andreas Dilger, Dave Martindale, Guy Eric Schalnat, Paul Schmidt, Tim Wegner.

The PNG Reference Library is supplied "AS IS". The Contributing Authors and Group 42, Inc. disclaim all warranties, expressed or implied, including, without limitation, the warranties of merchantability and of fitness for any purpose. The Contributing Authors and Group 42, Inc. assume no liability for direct, indirect, incidental, special, exemplary, or consequential damages, which may result from the use of the PNG Reference Library, even if advised of the possibility of such damage. Permission is hereby granted to use, copy, modify, and distribute this source code, or portions hereof, for any purpose, without fee, subject to the following restrictions:

1. The origin of this source code must not be misrepresented.
2. Altered versions must be plainly marked as such and must not be misrepresented as being the original source.
3. This Copyright notice may not be removed or altered from any source or altered source distribution.

The Contributing Authors and Group 42, Inc. specifically permit, without fee, and encourage the use of this source code as a component to supporting the PNG file format in commercial products. If you use this source code in a product, acknowledgment is not required but would be appreciated. A "png_get_copyright" function is available, for convenient use in "about" boxes and the like:

```
printf("%s",png_get_copyright(NULL));
```

Also, the PNG logo (in PNG format, of course) is supplied in the files "pngbar.png" and "pngbar.jpg (88x31) and "pngnow.png" (98x31).

Libpng is OSI Certified Open Source Software. OSI Certified Open Source is a certification mark of the Open Source Initiative.

Glenn Randers-Pehrson

randeg@alum.rpi.edu

April 15, 2002

2.20 zlib License

Copyright/Copyright holders – see List of Open Source Components

This software is provided 'as-is', without any express or implied warranty. In no event will the authors be held liable for any damages arising from the use of this software.

Permission is granted to anyone to use this software for any purpose, including commercial applications, and to alter it and re-distribute it freely, subject to the following restrictions:

1. The origin of this software must not be misrepresented; you must not claim that you wrote the original software. If you use this software in a product, an acknowledgment in the product documentation would be appreciated but is not required.
2. Altered source versions must be plainly marked as such, and must not be misrepresented as being the original software.
3. This notice may not be removed or altered from any source distribution.

2.2.2. Type approval for HomeLink® *

The type approval for HomeLink[®] ^[1] can be read below.

Country/Area	Type approval
USA and Canada	This device complies with FCC rules part 15 and Industry Canada RSS-210. Operation is subject to the following two conditions: (1) This device may not cause harmful interference, and (2) This device must accept any interference that may be received including interference that may cause undesired operation.
Europe	Gentex Corporation hereby declares that HomeLink [®] Model UAHL5 complies with the Radio equipment directive 2014/53/EU. Wavelength within which the radio equipment functions: <ul style="list-style-type: none"> • 433.05MHz-434.79MHz <10mW E.R.P. • 868.00MHz-868.60MHz <25mW E.R.P. • 868.70MHz-868.20MHz <25mW E.R.P. • 869.40MHz-869.65MHz <25mW E.R.P. • 869.70MHz-870.00MHz <25mW E.R.P. Certificate holder address: Gentex Corporation, 600 North Centennial Street, Zeeland MI 49464, USA



* Option/accessory.





[1] Applies to certain markets.



2.2.3. Type approval for Radio Equipment Directive

Information on the Radio Equipment Directive is available at volvocars.com/intl/support [<https://www.volvocars.com/intl/support>].

2.2.4. Certificate for wireless charger

Country/Area	
Argentina:	
Brazil:	

Country/Area	
Canada:	<p>This device contains licence-exempt transmitter(s)/receiver(s) that comply with Innovation, Science and Economic Development Canada's licence-exempt RSS(s). Operation is subject to the following two conditions:</p> <p>(1) This device may not cause interference; and</p> <p>(2) This device must accept any interference, including interference that may cause undesired operation of the device.</p> <p>L'émetteur/récepteur exempt de licence contenu dans le présent appareil est conforme aux CNR d'Innovation, Sciences et Développement économique Canada applicables aux appareils radio exempts de licence. L'exploitation est autorisée aux deux conditions suivantes:</p> <p>(1) L'appareil ne doit pas produire de brouillage;</p> <p>(2) L'appareil doit accepter tout brouillage radioélectrique subi, même si le brouillage est susceptible d'en compromettre le fonctionnement.</p> <p>This equipment complies with radio frequency exposure limits set forth by the Innovation, Science and Economic Development Canada for an uncontrolled environment.</p> <p>This equipment should be installed and operated with a minimum distance of 20 cm between the device and the user or bystanders.</p> <p>This device must not be co-located or operating in conjunction with any other antenna or transmitter.</p> <p>Cet équipement est conforme aux limites d'exposition aux radiofréquences définies par la Innovation, Sciences et Développement économique Canada pour un environnement non contrôlé.</p> <p>Cet équipement doit être installé et utilisé avec un minimum de 20 cm de distance entre le dispositif et l'utilisateur ou des tiers.</p> <p>Ce dispositif ne doit pas être utilisé à proximité d'une autre antenne ou d'un autre émetteur.</p>
Indonesia:	
Israel:	<div style="border: 1px solid black; padding: 10px; text-align: center;"> <p>מספר אישור התאמה מטעם משרד התקשורת: 51-90830</p> <p>חל איסור לבצע פעולות במכשיר שיש בהן כדי לשנות את תכונותיו האלחוטיות של המכשיר, ובכלל זה שינויי תוכנה, החלפת אנטנה מקורית או הוספת אפשרות לחיבור לאנטנה חיצונית, בלא קבלת אישור משרד התקשורת, בשל החשש להפרעות אלחוטיות.</p> </div>
Philippines:	ESD-RCE-2231876
Taiwan:	 <p>NCC [?] / NCC statement: [?]</p>
Thailand:	 <p>[?]</p> 
The United Arab Emirates:	

Country/Area	
USA:	<p>FCC Statement:</p> <p>This device complies with Part 15 of the FCC rules. Operation is subject to the following two conditions:</p> <p>(1) This device may not cause harmful interference, and</p> <p>(2) This device must accept any interference received, including interference that may cause undesired operation.</p> <p>Please note that changes or modifications not expressly approved by the party responsible for compliance could void the user's authority to operate the equipment.</p> <p>This equipment has been tested and found to comply with the limits for a Class B digital device, pursuant to part 15 of the FCC Rules. These limits are designed to provide reasonable protection against harmful interference in a residential installation. This equipment generates, uses and can radiate radio frequency energy and, if not installed and used in accordance with the instructions, may cause harmful interference to radio communications. However, there is no guarantee that interference will not occur in a particular installation. If this equipment does cause harmful interference to radio or television reception, which can be determined by turning the equipment off and on, the user is encouraged to try to correct the interference by one or more of the following measures:</p> <ul style="list-style-type: none"> — Reorient or relocate the receiving antenna. — Increase the separation between the equipment and receiver. — Connect the equipment into an outlet on a circuit different from that to which the receiver is connected. — Consult the dealer or an experienced radio/TV technician for help. <p>This equipment complies with radio frequency exposure limits set forth by the FCC for an uncontrolled environment.</p> <p>This equipment should be installed and operated with a minimum distance of 20 cm between the device and the user or bystanders.</p> <p>This device must not be co-located or operating in conjunction with any other antenna or transmitter.</p>
Vietnam:	
Zambia:	



2.2.5. Type approval for remote control key system

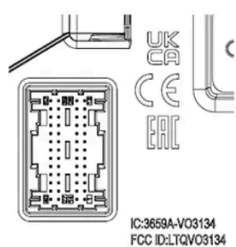
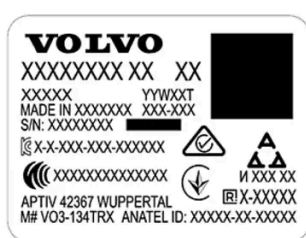

Type approval for the car's remote key system can be seen in the following tables.

Lock system keyless start (Passive Start) and keyless locking/unlocking (Passive Entry*)



CEM marking for the remote control key system. For supplementary type approval numbers, see following tables.

Country/Area	Type approval	
Argentina		See the illustration below the table.
Brazil	MT-3245/2015	 <p>0589-15-6830</p>  <p>(01) 0 7897843840961</p>

Country/Area	Type approval	
Europe	Delphi Deutschland GmbH, 42367 Wuppertal hereby declares that this VO3-134TRX conforms to the essential property requirements and other relevant provisions contained in directive 2014/53/EU (RED).	
The United Arab Emirates	ER37847/15 DA0062437/11	
Indonesia	Nomor: 38301/SDPPI/2015	
Jordan	TRC/LPD/2014/250	
Malaysia	RAAT/37A/1215/S(15-5198)	
Mexico	IFETEL: RLVDEVO15-0396	
Namibia	TA-2016-02	
Russia		
Serbia	P1614120100	
South Africa	TA-2014-1868	











Argentina

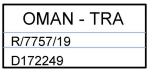

H-25867

Remote control key

Country/Area	Type approval	
Europe	Huf Hülsbeck & Fürst GmbH & Co. KG hereby declares that this type of radio equipment HUF8423MS conforms to directive 2014/53/EU. Wavelength: 433.92 MHz Maximum radiated transmission power: 10 mW Manufacturer: Huf Hülsbeck & Fürst GmbH & Co. KG, Steeger Str. 17, 42551 Velbert, Germany	

Country/Area	Type approval	
Argentina		See the illustration below the table.
Brazil	Anatel: 06768-19-06643 Modelo: HUF8423MS Este equipamento opera em caráter secundário isto é não tem direito a proteção contra interferência prejudicial, mesmo de estações do mesmo tipo, e não pode causar interferência a sistemas operando em caráter primário.	
Philippines	ESD-1919938C	
The United Arab Emirates		
Ghana	NCA Approved: ZRO-M8-7E3-138	
Indonesia ^[1]	Sertifikat Nomor: 86806/SDPPI/2022 PLG ID: 8093	
CU (Customs Union) Kazakhstan, Russia		
Morocco	AGREE PAR L'ANRT MAROC Numéro d'agrément: MR 20402 ANRT 2019 Date d'agrément: 10/07/2019	
Moldova		
Nigeria	Connection and use of this communication equipment is permitted by the Nigerian Communications Commission	
Oman		
Paraguay	HUF8423MS	
Serbia		
Singapore	Complies with IMDA Standards DA103787	
South Africa	TA-2019/772	
Taiwan	<p>????????????????????</p> <p>????????????????????</p> <p>.1</p> <p>????????????????????</p> <ul style="list-style-type: none"> ???????????????????? <p>.2</p> <p>????????????????????</p> <ul style="list-style-type: none"> ???????????????????? ???????????????????? <p>????????????????????</p> <ul style="list-style-type: none"> ?????? 	

Country/Area	Type approval	
Ukraine	Справжнім Huf Hülsbeck & Fürst GmbH & Co KG заявляє, що тип радіообладнання відповідає Технічному[HUF8423MS] регламенту радіообладнання; повний текст -декларації про відповідність доступний на веб :сайті за такою адресою Робоча частота: 433,92 ГГц	
Vietnam		
Belarus		
Zambia		 ZMB/ZICTA/TA/2019/7/105









Argentina



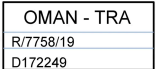

H-23694

Key Tag

Country/Area	Type approval	
Europe	Huf Hülsbeck & Fürst GmbH & Co. KG hereby declares that this type of radio equipment HUF8432MS conforms to directive 2014/53/EU. Wavelength: 433.92 MHz Maximum radiated transmission power: 10 mW Manufacturer: Huf Hülsbeck & Fürst GmbH & Co. KG, Steeger Str. 17, 42551 Velbert, Germany	
Argentina		See the illustration below the table.
Brazil	Anatel: 04362-16-06643 Modelo: HUF8432MS Este equipo opera em caráter secundário isto é não tem direito a proteção contra interferência prejudicial, mesmo de estações do mesmo tipo, e não pode causar interferência a sistemas operando em caráter primário.	 04362-16-06643

Country/Area	Type approval	
Ghana	NCA Approved: ZRO-M8-7E3-139	
Philippines	ESD-1919939C	
The United Arab Emirates		
CU (Customs Union) Kazakhstan, Russia		
Indonesia ^[1]	Sertifikat Nomor: 86808/SDPPI/2022 PLG ID: 8093	
Morocco	AGREE PAR L'ANRT MAROC Numéro d'agrément: MR 20403 ANRT 2019 Date d'agrément: 10/07/2019	
Moldova		
Nigeria	Connection and use of this communications equipment is permitted by the Nigerian Communications Commission	
Oman		
Paraguay	HUF8432MS	
Serbia		
Singapore	Complies with IMDA Standards DA103787	
South Africa	TA-2019-773	
Taiwan	<p>????????????????????</p> <p>????????????????????</p> <p>.1</p> <p>????????????????????</p> <ul style="list-style-type: none"> ???????????????????? <p>.2</p> <p>????????????????????</p> <ul style="list-style-type: none"> ???????????????????? ???????????????????? <p>????????????????????</p> <ul style="list-style-type: none"> ?????? 	

Country/Area	Type approval	
Ukraine	Справжнім Huf Hülsbeck & Furst GmbH & Co KG заявляє, що тип радіообладнання відповідає Технічному[HUF8432MS] регламенту радіообладнання; повний текст -декларації про відповідність доступний на веб :сайті за такою адресою Робоча частота: 433,92 ГГц	
Vietnam		
Belarus		
Zambia		

Argentina



H-23695

Central Electronic Module

Country/Area	Type approval	
Indonesia	Sertifikat Nomor: 85998/SDPPI/2022 PLG ID: 13809	

* Option/accessory.

^[1] Only applies to Indonesia.

2.2.6. Approval of terms and conditions and data collection

Messages about different terms and conditions and data collection can be shown in the centre display. Collection of data takes place to provide better car, safety and app functions, for example.

The first time you use your car, a guide opens in the centre display to assist you to make various settings. In connection with the guide, you are also prompted to give your agreement to different types of terms and conditions and the collection of information.

The content of this manual represents the status of the user manual at the time of printing and may not be completely valid in future instances. For more information, refer to the first page for the complete disclaimer note.

Prompts to give consent can also be shown in the event of, for example:

- First-time use of apps and services
- New user profiles
- Logging out from and deleting user profiles
- Change of ownership
- Resetting the settings

To access privacy settings:

- 1 Press  in the centre display.
- 2 Then press on **Privacy**.
- 3 Then select **Volvo privacy settings**, **Data sharing with Google** or **Legal information from Google**.

Some settings can only be made from a profile with administrative privileges.

Accept the internet terms of use^[1]

- 1 Press .
- 2 Select **Privacy**.
- 3 Select **Internet terms of service** and follow the instructions.

The terms of use must be accepted once per car in order to use the internet.

^[1] Applies to certain markets.

2.2.7. Candidate List Substance Information (CL) in accordance with the Reach Regulation, Article 33.1

In accordance with Article 33.1 of the REACH Regulation (Reg. EC 1907/2006),^[1] professional customers must be informed of Substances of Very High Concern (SVHC^[2]) in products supplied by Volvo Cars. The intention is to facilitate the safe handling of the constituent components affected in order to protect people and the environment.

Volvo Cars supports the underlying goals of the REACH regulation in general, and Article 33 in particular, which are consistent with our own commitment to promote the responsible manufacturing, handling and use of our products.

Presence of Candidate List Substances

The articles in the "Candidate List Substances Table" below contain substances at greater than 0.1% w/w in the candidate list (CL) for the specific car. The information on substances in the candidate list (CL) is based on the data obtained from our suppliers and our own product data.

General Safe Use Information for Articles

Every car from Volvo Cars is provided with an owner's manual, which includes safe use information for owners/drivers/users of the car. Volvo Cars information on repair and servicing of cars and genuine parts also includes safe use information for service personnel.

Where present in parts of this car, the Candidate List substances shown on the relevant "Candidate List Substances Table" for the specific car are incorporated in such a way that potential exposure to customers as well as risks for people or the environment can be minimised as long as the car and its parts are used as intended, and any repairs, servicing and maintenance are carried out following technical instructions for those activities, and industry standard good practices.

An end-of-life vehicle may only be disposed of legally in the European Union at an Authorised Treatment Facility (ATF). Vehicle parts should be disposed in accordance with locally applicable laws and local authority guidance.

Candidate List Substances Table

More details are available in a pdf file, see Support / Information about the car / Rules and regulations.

^[1] REACH - The European Union's chemicals legislation, which entered into force on 1 June 2007, Regulation (EC) No. 1907/2006 concerning the Registration, Evaluation, Authorisation and Restriction of Chemicals (REACH).

^[2] SVHC - Substances of Very High Concern, which are included in the current candidate list (CL).

2.3. Displays and controls by the driver in a left-hand drive car

The overviews show where the displays and controls near the driver are located.

Steering wheel and instrument panel

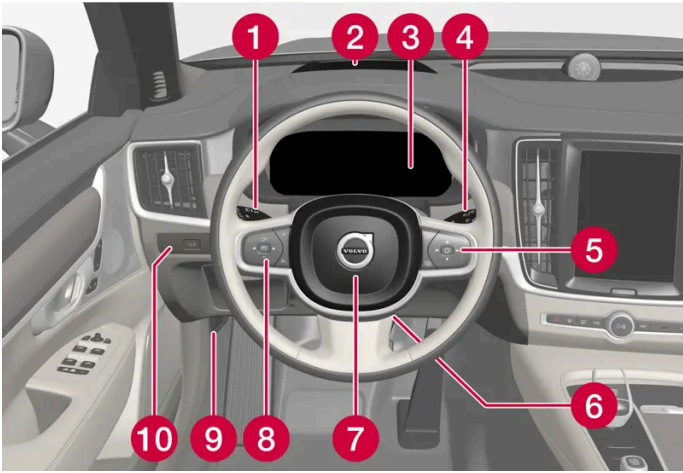

- 1 Position lamps, daytime running lights, dipped beam, main beam, direction indicators, front fog lamps/cornering lights*, rear fog lamp, resetting the trip meter
- 2 Head-up display*
- 3 Driver display
- 4 Wipers and washing, rain sensor*
- 5 Right-hand steering wheel keypad
- 6 Steering wheel adjustment
- 7 Horn
- 8 Left-hand steering wheel keypad
- 9 Bonnet opening
- 10 Unlocking/opening*/closing* of tailgate

Roof console

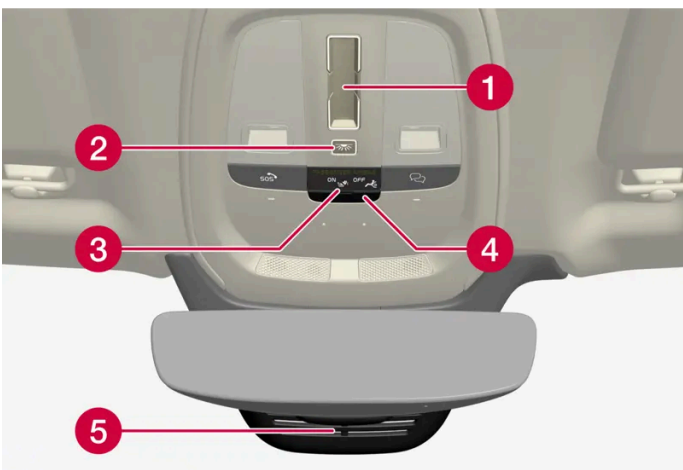

- 1 Panoramic roof*
- 2 Front reading lamps and interior lighting
- 3 Display in roof console,  button*
- 4 Flap for SIM card
- 5 Manual dimming of interior rearview mirror ^[1]

The content of this manual represents the status of the user manual at the time of printing and may not be completely valid in future instances. For more information, refer to the first page for the complete disclaimer note.

Centre and tunnel console

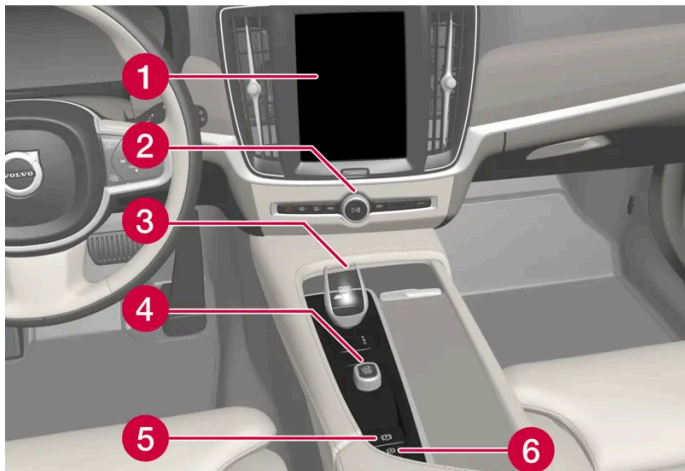

- 1 Centre display
- 2 Hazard warning flashers, defrosting, media
- 3 Gear selector
- 4 Start knob
- 5 Parking brake
- 6 Automatic brake when stationary

Driver's door

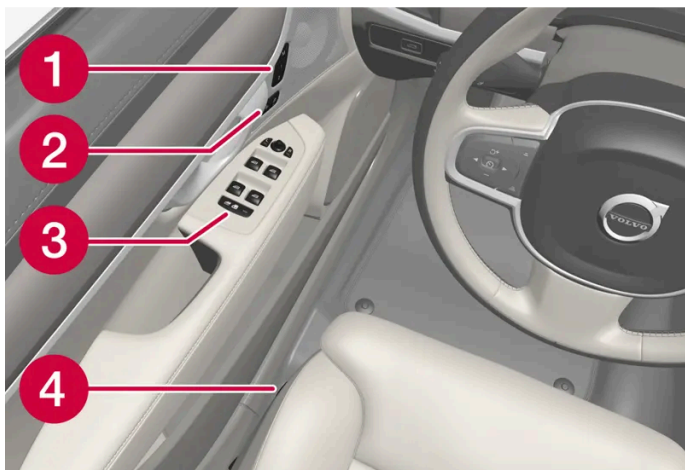

- 1 Memories for power front seat*, door mirror and head-up display* settings
- 2 Central locking
- 3 Power windows, door mirrors and child locks*
- 4 Adjusting front seat

* Option/accessory.

[1] There are no controls for manual dimming for cars with automatic dimming.

2.4. Displays and controls by the driver in a right-hand drive car

The overviews show where the displays and controls near the driver are located.

Steering wheel and instrument panel

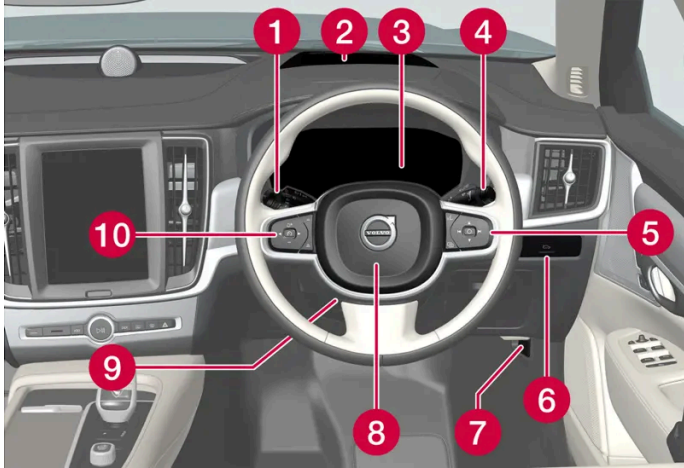

- 1 Position lamps, daytime running lights, dipped beam, main beam, direction indicators, front fog lamps/cornering lights*, rear fog lamp, resetting the trip meter
- 2 Head-up display*
- 3 Driver display
- 4 Wipers and washing, rain sensor*
- 5 Right-hand steering wheel keypad
- 6 Unlocking/opening*/closing* of tailgate
- 7 Bonnet opening
- 8 Horn
- 9 Steering wheel adjustment
- 10 Left-hand steering wheel keypad

Roof console

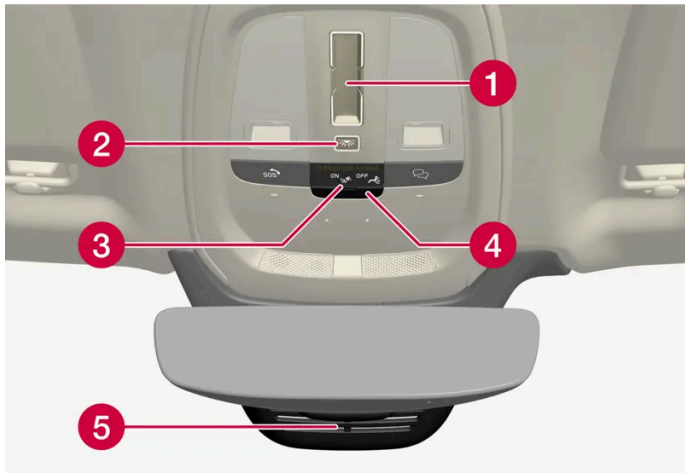

- 1 Panoramic roof*
- 2 Front reading lamps and interior lighting
- 3 Display in roof console,  button*
- 4 Flap for SIM card
- 5 Manual dimming of interior rearview mirror ^[1]

Centre and tunnel console

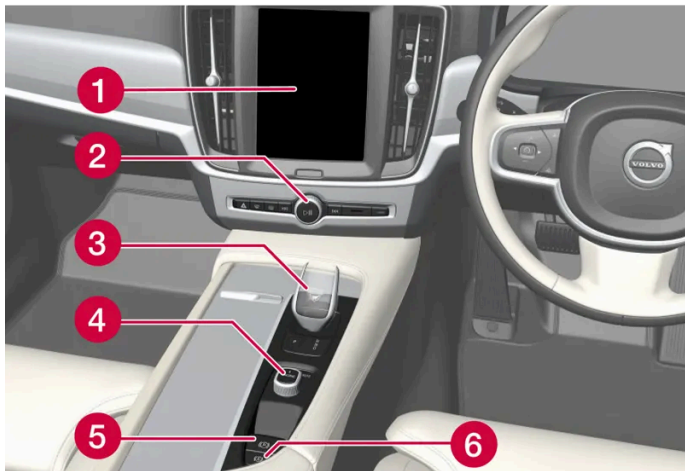

- 1 Centre display
- 2 Hazard warning flashers, defrosting, media
- 3 Gear selector
- 4 Start knob
- 5 Parking brake
- 6 Automatic brake when stationary

Driver's door

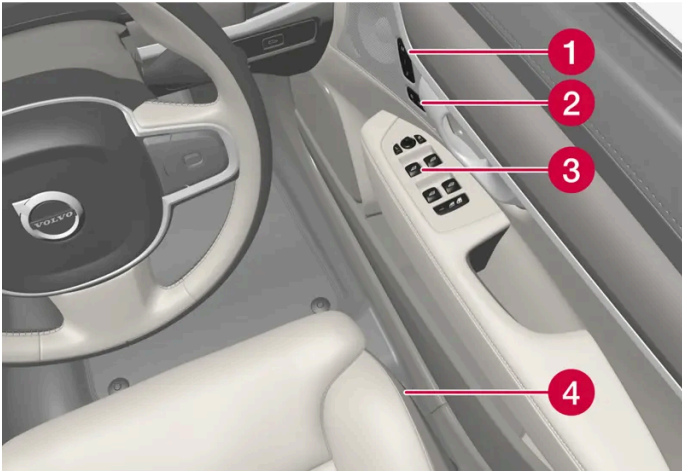

- 1 Memories for power front seat*, door mirror and head-up display* settings
- 2 Central locking
- 3 Power windows, door mirrors, electric child lock*
- 4 Adjusting front seat

* Option/accessory.

[1] There are no controls for manual dimming for cars with automatic dimming.

2.5. Connection of equipment to the car's diagnostic socket

Incorrect connection and installation of software or diagnostic tools may have a negative effect on the car's electronic system.

Volvo strongly recommends that Volvo owners only install Volvo approved original accessories, and that installation of accessories is only carried out by trained and qualified Volvo service technicians. Certain accessories only function when associated software is installed in the car's computer system.

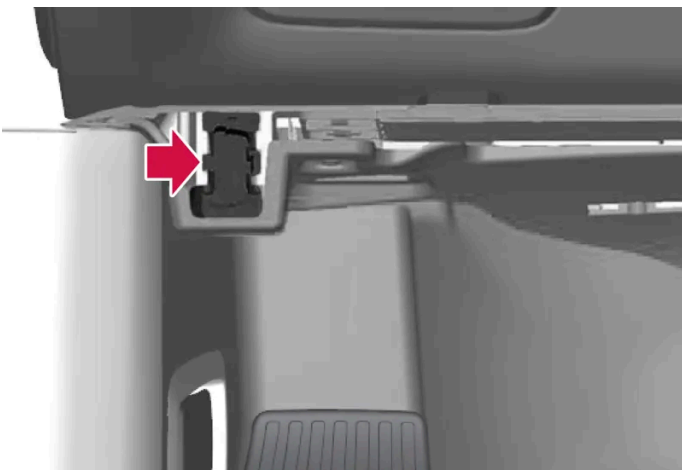

Data link connector (On-board Diagnostic, OBDII) is under the instrument panel on the driver's side.

 **Note**

Volvo Cars accepts no liability for the consequences if unauthorised equipment is connected to the On-board Diagnostic socket (OBDII). This socket should only be used by trained and qualified Volvo service technicians.

2.6. Driver distraction

The driver is responsible for doing everything possible to ensure the safety of themselves, their passengers and other road users. Part of this responsibility is avoiding distractions such as carrying out an activity that is not related to operating the car in a driving environment.

Your new Volvo is equipped with content-rich entertainment and communications systems. You may also have other portable electronic devices for your own convenience. Use these systems and devices in a safe manner in order to avoid distraction.

We wish to give the following warnings regarding such systems, to indicate Volvo's concern for your safety. Never use a device or function in the car in such a way that it will distract you from the task of driving safely. Distractions can lead to serious accidents. Apart from these general warnings, we offer the following advice regarding the new functions that may be in the car:

 **Warning**

- Never use a hand-held mobile phone while driving. In some areas it is forbidden for the driver to use a mobile phone while the car is moving.
- If the car is equipped with a navigation system you must only set and change the itinerary when the car is parked.
- Never program the audio system while the car is moving. Program the radio's presets when the car is parked and then use the programmed presets for faster and simpler use of the radio.
- Never use laptops or hand-held computers while the car is moving.

2.7. Environmental efficiency

Volvo Car Corporation is constantly working on the development of safer and more efficient products and solutions in order to reduce the negative impact on the environment.



Environmental care is one of Volvo Cars' core values and influences all operations. The environmental work is based on the whole life cycle of the car and takes into account the environmental impact it has, from design to scrapping and recycling. Volvo Cars' basic principle is that every new product developed must have less impact on the environment than the product it replaces.

Volvo's environmental management work has resulted in the development of more effective and less polluting drivelines. Personal environment is also important to Volvo - the air inside a Volvo is, for example, cleaner than the air outside thanks to the climate control system.

Your Volvo complies with stringent international environmental standards. All Volvo's manufacturing units must be ISO 14001 certified, and this supports a systematic approach to the operation's environmental issues, which leads to continuous improvement with reduced environmental impact. Holding the ISO certificate also means that environmental laws and regulations in force are complied with. Volvo also requires that its partners must also meet these requirements.

Fuel consumption

Since a large part of a car's total environmental impact stems from its use, the emphasis of Volvo Cars' environmental work is on reducing fuel consumption, carbon dioxide emissions and other air pollutants. Volvo cars have competitive fuel consumption in each of their respective classes. Lower fuel consumption generally results in lower emission of the greenhouse gas, carbon dioxide.

Contributing to a better environment

An energy-efficient and economical car can contribute to reduced environmental impact and also involve reduced costs for the owner of the car. As the driver, it is easy to reduce fuel consumption and thereby save money and contribute to a better environment - here is some advice:

- Plan for an effective average speed. Speeds above approx. 80 km/h (approx. 50 mph) and below 50 km/h (approx. 30 mph) lead to increased energy consumption.
- Follow the Service and Warranty Booklet's recommended intervals for service and maintenance of the car.
- Avoid letting the engine idle - switch off the engine when stationary for longer periods. Pay attention to local regulations.
- Plan the journey - a lot of unnecessary stops and uneven speed contribute to increased fuel consumption.
- Use preconditioning* before starting in cold conditions - it improves starting capacity and reduces wear in cold weather. The engine reaches normal operating temperature more quickly, which decreases consumption and reduces emissions.

Also remember to always dispose of environmentally hazardous waste, such as batteries and oil, in an environmentally safe manner. Consult a workshop in the event of uncertainty about how this type of waste should be discarded - an authorised Volvo workshop is recommended.

Efficient emission control

Your Volvo is manufactured following the concept "Clean inside and out" – a concept that encompasses a clean interior environment as well as highly efficient emission control. In many cases the exhaust emissions are well below the applicable standards.

Clean air in the passenger compartment

An air filter helps prevent dust and pollen entering the passenger compartment via the air intake.

The Interior Air Quality System (IAQS)* ensures that the incoming air is cleaner than the air in the traffic outside.

The system cleans the air in the passenger compartment from contaminants such as particles, hydrocarbons, nitrous oxides and ground-level ozone. If the outside air is contaminated then the air intake is closed and the air is recirculated. Such a situation may arise in heavy traffic, queues and tunnels for example.

IAQS is a part of the Clean Zone Interior Package (CZIP)*, which also includes a function that allows the fan to start when the car is unlocked with the key.

Interior

The material used in the interior of a Volvo is carefully selected and has been tested in order to be pleasant and comfortable. Some of the details are hand-made, such as the seams of the steering wheel that are sewn by hand. The interior is monitored in order not to emit strong odours or substances that cause discomfort in the event of e.g. high heat and bright light.

Volvo workshops and the environment

Regular maintenance creates the conditions for a long service life and low fuel consumption for your car. In this way you also contribute to a cleaner environment. When Volvo's workshops are entrusted with the service and maintenance of your car it becomes part of Volvo's system. Volvo makes clear demands regarding the way in which workshop premises shall be designed in order to prevent spills and discharges into the environment. The workshop staff have the knowledge and the tools required to guarantee good environmental care.

Recycling

Since Volvo works from a life cycle perspective, it is also important that the car is recycled in an environmentally sound manner. Almost all of the car can be recycled. The last owner of the car is therefore requested to contact a retailer for referral to a certified/approved recycling facility.

* Option/accessory.

2.8. Getting started with Google services

Connect your Google account to your user profile to get started with Google services.



Being logged in with a Google account enables Google services like Google Assistant and Google Maps to be more personalised. To open Google Play, a Google account must be connected to the user profile in question.

Creating a Google account

Go to accounts.google.com/signup [https://accounts.google.com/signup]. Enter name, and create or use an existing email and password. Enter your phone number and verify the account using the code sent to the phone.

Logging into the Google account in the centre display

- 1 Tap on , then tap on **Google**, and then **Google Assistant**. Tap on the profile symbol to log in.

- 2 Enter the email address linked to your Google account. Then tap on **Next**.
- 3 Enter the password linked to your Google account. Then tap on **Next**.

If there is a problem logging in, make sure the car is connected to the internet.

2.9. Change of market when importing or relocating

When you import a car or relocate a car to another country, it is important that you register the car in the new market in order, for example, for the online services to work correctly, as well as to ensure that the car complies with local requirements and laws.

Visit an authorised Volvo dealer

To get help to register the car, visit an authorised Volvo dealer.

If you do not do this then you may experience that apps, Volvo Assistance^[1], software downloads and other online services are affected and do not work correctly.

Creating a new Volvo ID in your new home market

When you relocate to another country you should create a Volvo ID in the new country.

If you have already created a Volvo ID in another country and want to use the same email address, you must first delete your Volvo ID in the region you originally created it. Alternatively, you can create a new Volvo ID using another e-mail address.

For cars with Volvo Assistance

Download the Volvo Cars app from the country where the car will be used and link the app to your car.

Note

Visit an authorised Volvo dealer if you have imported or relocated with your car to a new country.
Available services may vary depending on market and car model.

Note

If the car is exported to another market, Volvo is not responsible for any adaptations to the car in order to comply with requirements or laws that apply in the importing market. Read more in Service and Warranty or contact your Volvo workshop for more information.

^[1] Applicable only to markets that have access to Volvo Assistance.

2.10. Showing the car's identification number

All cars have a unique identification number, VIN ^[1]

- 1 Tap on Settings  at the bottom of the centre display.
- 2 Continue to **System** and then **About**.

Another way of finding VIN is:

- on the first page of the Service and warranty booklet
- in the car's registration document
- look on the dashboard through the car's windscreen.



VIN is positioned in a similar place on all models.

^[1] Vehicle Identification Number

2.11. Recording data

As part of Volvo's safety and quality assurance, certain information about the vehicle's operation, functionality and incidents are recorded in the car.

Event Data Recorder (EDR)

This vehicle is equipped with an "Event Data Recorder" (EDR). Its primary purpose is to register and record data related to traffic accidents or collision-like situations, such as times when the airbag deploys or the vehicle strikes an obstacle in the road. The data is recorded in order to increase understanding of how vehicle systems work in these types of situations. The EDR is designed to record data related to vehicle dynamics and safety systems for a short time, usually 30 seconds or less.

The EDR in this vehicle is designed to record data related to the following in the event of traffic accidents or collision-like situations:

- how the various systems in the car worked
- whether the driver and passenger seatbelts were fastened/tensioned
- the driver's use of the accelerator or brake pedal
- the travel speed of the vehicle.

This information can help us understand the circumstances in which traffic accidents, injuries and damage occur. The EDR only records data when a non-trivial collision situation occurs. The EDR does not record any data during normal driving conditions. Similarly, the system never registers who is driving the vehicle or the geographic location of the accident or near-miss situation. However, other parties, such as the police, could use the recorded data in combination with the type of personally identifiable information routinely collected after a traffic accident. Special equipment and access to either the vehicle or the EDR is required to be able to interpret the registered data.

In addition to the EDR, the car is equipped with a number of computers designed to continually check and monitor the function of the car. They can record data during normal driving conditions, but in particular register faults affecting the vehicle's operation and functionality, or upon activation of the vehicle's driver support function (e.g. City Safety and the auto brake function).

Some of the recorded data is required to enable service and maintenance technicians to diagnose and remedy any faults that occurred in the vehicle. The registered information is also needed to enable Volvo to satisfy legal requirements laid out in laws and by government authorities. Information registered in the vehicle is stored in its computers until the vehicle is serviced or repaired.

In addition to the above, the registered information can be used in aggregate form for research and product development with the aim of continuously improving the safety and quality of Volvo cars.

Volvo will not contribute to the above-described information being disclosed to third parties without the vehicle owner's consent. To comply with national legislation and regulations, Volvo may be forced to disclose information of this nature to the police or other authorities who may assert a legal right to access such. Special technical equipment which Volvo and workshops that have entered into agreements with Volvo have access to is required to be able to read and interpret the recorded data. Volvo is responsible that the information, which is transferred to Volvo during servicing and maintenance, is securely stored and managed and that its management complies with relevant legal requirements. For further information - contact a Volvo retailer.

TCAM

Vehicles equipped with TCAM can collect data on the vehicle's safety functions as well as other functions in the vehicle. Data are collected for product development, quality follow-up and safety work, as well as to improve and monitor the vehicle's quality and its safety functions. The purpose of data collection is also to manage Volvo Car Corporation's warranty undertakings, as well as to meet legal requirements related to engine emissions data.

2.12. Online connectivity and entertainment

The car has an intelligent interface and offers online connectivity with the digital world. An intuitive navigation structure makes it possible to receive relevant support, information and entertainment when it is necessary.

It covers all solutions in the car that are connected with entertainment, online connectivity, navigation and the user interface between driver and car.

Fair Use Policy

Your use of connectivity services that is part of your vehicle is subject to this Fair Use Policy.

When using this Service you agree not to

- submit content that is unlawful, obscene, libellous, threatening, harassing, hateful, racially or ethnically offensive or otherwise inappropriate
- use the Service in breach of any applicable law
- use the Service for commercial purposes.

Your access to the Service is part of a shared access. Volvo reserves the right to suspend your access to or use of the Service if your use involves very high volumes of data, disproportionate to other users. Volvo may also suspend your access for technical reasons or to protect other functions of your vehicle. Your access to connectivity services is covered by third party terms and conditions from the mobile network service provider.

Information when it is needed, where it is needed

The different displays in the car provide information at the right time. The information is shown in different locations based on how it should be prioritised by the driver.

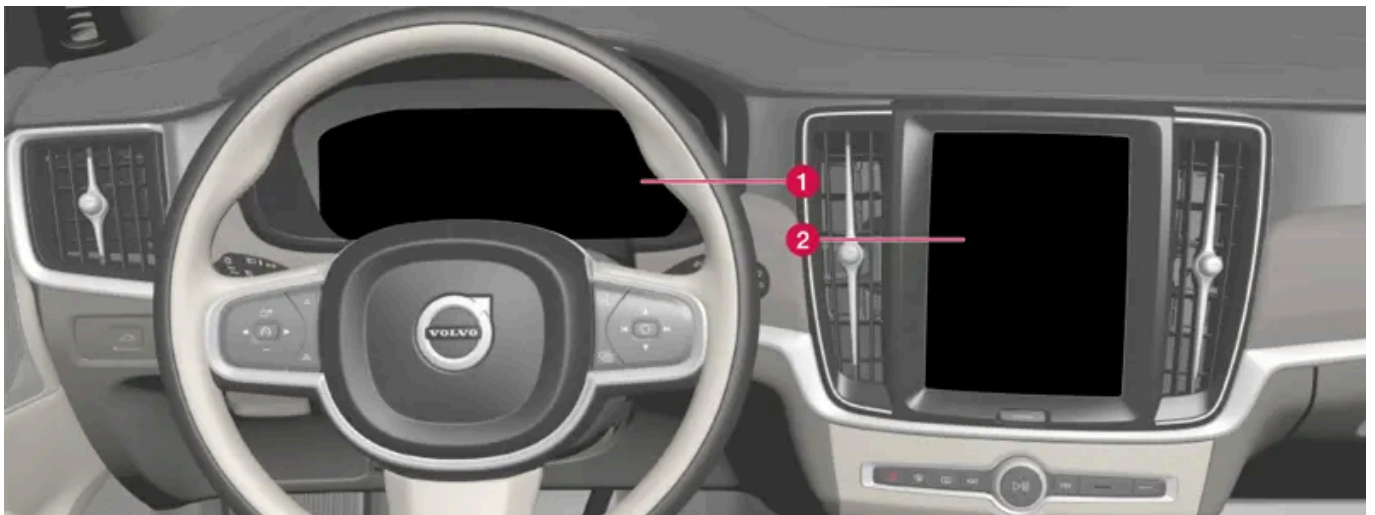

Different types of information are shown in different displays depending on how the information should be prioritised.

- 1 The driver display shows information on speed, road sign information, warning and indicator symbols, and information on the battery, for example. The driver display can also show incoming calls or information on what song tracks are being played back. The display is operated via the two steering wheel keypads.
- 2 Many of the car's primary functions are controlled from the centre display, e.g. the climate control system, the entertainment system and the seat position. The centre display also shows information on navigation and road sign information, for example. The information that is shown in the centre display can be acted on by the driver or someone else in the car when the opportunity arises.

Note

Wearing gloves may limit or prevent touch screen response.

Head-up display*



The head-up display shows selected information that the driver should deal with as soon as possible. Such information may, for example, include traffic warnings, speed information and navigation information. Road Sign Information and incoming phone calls are also shown in the head-up display. The display is operated via the right-hand steering wheel keypad and via the centre display.

Voice control system

The voice control system can be used without the driver needing to take his/her hands off the steering wheel. The system can understand natural speech. Use voice control to, for example, play back a song, call someone, increase the temperature or read out a text message.

* Option/accessory.

2.13. Important information on accessories and auxiliary equipment

The incorrect connection and installation of accessories and extra equipment can negatively affect the car's electronic system.

Volvo strongly recommends that Volvo owners only install genuine Volvo-approved accessories, and that installation of accessories is only carried out by trained and qualified Volvo service technicians. Certain accessories only function when associated software is installed in the car's computer system.

The equipment described in the owner's manual is not available in all cars - they have different equipment depending on adaptations for the needs of different markets and national or local laws and regulations.

Options or accessories described in this manual are marked with an asterisk. In the event of uncertainty over what is standard or an option/accessory, contact a Volvo dealer.

- Volvo original accessories are tested to ensure that they function with the car systems for performance, safety and emissions control. In addition, a trained and qualified Volvo service technician knows where accessories may or may not be

The content of this manual represents the status of the user manual at the time of printing and may not be completely valid in future instances. For more information, refer to the first page for the complete disclaimer note.

safely installed in your Volvo. Always seek the advice of a trained and qualified Volvo service technician before installing any accessories in or on your car.

- Accessories that are not approved by Volvo may not have been specifically tested for use with your car.
- Some of the car's performance or safety systems can be negatively affected if you install accessories that have not been tested by Volvo, or if you permit someone without experience of the car to install accessories.
- Damage that is caused by accessories installed in a non-approved or incorrect way is not covered by any new car warranty. More warranty information can be found in the Service and Warranty Booklet. Volvo does not accept any liability for deaths, personal injury or costs arising as a result of the installation of non-original accessories.

 **Warning**

The driver always bears the ultimate responsibility that the car is used safely and that laws and regulations in force are followed.

It is also important that the car has maintenance and service according to Volvo's recommendations, the owner's information and the Service and Warranty Booklet.

If there should be a difference between the information in the centre display and the information in other sources, it is always the information in the centre display that applies.

3. Safety

3.1. Seatbelts

3.1.1. Seatbelts

Heavy braking can have serious consequences if the seatbelts are not used.

It is important that the seatbelt lies against the body so it can provide good protection. Do not lean the backrest too far back. The seatbelt is designed to protect in a normal seating position.

 **Warning**

Remember not to clip or hook the seatbelt to hooks or other interior fittings, as this prevents the belt from tightening properly.

 **Warning**

The seatbelts and airbags interact. If a seatbelt is not used or is used incorrectly, this may diminish the protection provided by the airbag in the event of a collision.

 **Warning**

Never modify or repair the seatbelts yourself. Volvo recommends that an authorised Volvo workshop should be contacted.

If the seatbelt has been subjected to a major load, such as in conjunction with a collision, the entire seatbelt must be replaced. Some of the seatbelt's protective properties may have been lost even if the seatbelt does not appear damaged. The seatbelt must also be replaced if it shows signs of wear or damage. The new seatbelt must be type-approved and designed for installation at the same location as the replaced seatbelt.

3.1.2. Putting on and taking off seatbelts

Make sure that all passengers have fastened their seatbelts before starting to drive.

Putting on seatbelts

- 1 Pull out the seatbelt slowly and make sure it is not twisted or damaged.

Note

The seatbelt is equipped with an inertia reel that is locked in the following situations:

- if the belt is extended too quickly.
- during braking and acceleration.
- if the car leans heavily.
- when driving in sharper bends.

- 2 Lock the belt by inserting the locking tab in the intended buckle.

- > A loud "click" indicates that the belt has locked.

Warning

Always insert the tongue of the seatbelt into the buckle on the correct side. The seatbelts and buckles would otherwise possibly not function as intended in the event of a collision. There is a risk of serious injury.

- 3 In the front seats the seatbelt can be adjusted for height.



Press together the seat mounting and move the seatbelt up or down.

Position the belt as high as possible without it chafing against your throat.

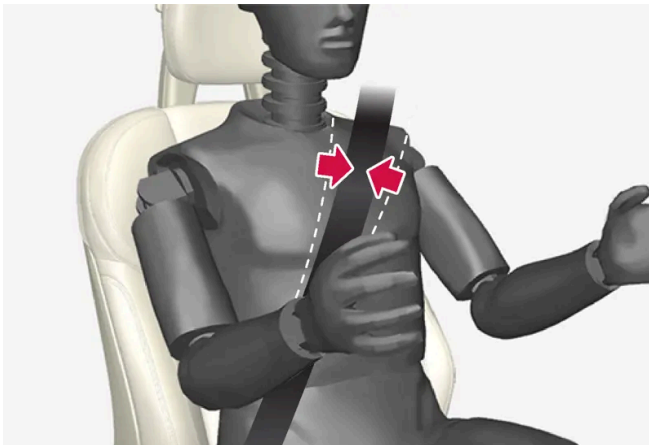

The seatbelt must pass over the shoulder (not down over the arm).

The content of this manual represents the status of the user manual at the time of printing and may not be completely valid in future instances. For more information, refer to the first page for the complete disclaimer note.

- 4 Tension the hip strap over the lap by pulling the diagonal shoulder belt up towards the shoulder.

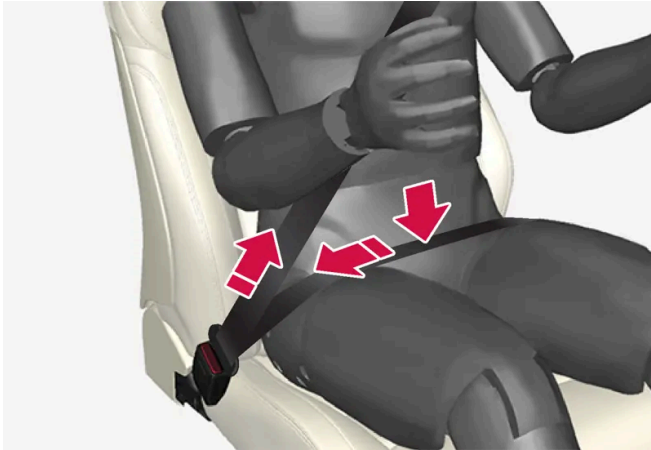

The hip strap must be positioned low down (not over the abdomen).

 **Warning**

Each seatbelt is designed for only one person.

 **Warning**

Remember not to clip or hook the seatbelt to hooks or other interior fittings, as this prevents the belt from tightening properly.

 **Warning**

Do not make any damages on seatbelts nor insert any foreign objects into a buckle. The seatbelts and buckles would then possibly not function as intended in the event of a collision. There is a risk of serious injury.

Taking off seatbelts

- 1 Press the red button on the seatbelt buckle and then let the belt retract.
- 2 If the seatbelt does not retract fully, feed it in by hand so that it does not hang loose.

3.1.3. Seatbelt tensioner

The car is fitted with standard seatbelt tensioners and electric seatbelt tensioners that can tension the seatbelts in critical situations and collisions.

Standard seatbelt tensioner

All the seatbelts are equipped with a standard seatbelt tensioner.

The seatbelt tensioner tensions the seatbelt in the event of a collision with sufficient force in order to more effectively restrain the occupant.

Electric seatbelt tensioner

The driver and front passenger seatbelts are equipped with an electric seatbelt tensioner.

The seatbelt pretensioner works together and can be activated together with the driver support systems for assistance at risk of collision and Rear Collision Warning*. In critical situations, such as panic braking, driving off the road (e.g. the car rolls into a ditch, lifts off the ground or hits something in the terrain), skidding, or risk of collision, the seatbelt can be tensioned by the seatbelt tensioner's electric motor.

The electric seatbelt tensioner helps to adjust the occupant to a better position, reducing the risk of striking the car's interior and improving the effect of safety systems, such as the car's airbags.

When the critical situation has come to an end, the seatbelt and the electric seatbelt pretensioner are restored automatically, but they can also be restored manually.

Important

If the passenger airbag is deactivated, the electric seatbelt tensioner on the passenger side will also be deactivated.

Warning

Never modify or repair the seatbelts yourself. Volvo recommends that an authorised Volvo workshop should be contacted.

If the seatbelt has been subjected to a major load, such as in conjunction with a collision, the entire seatbelt must be replaced. Some of the seatbelt's protective properties may have been lost even if the seatbelt does not appear damaged. The seatbelt must also be replaced if it shows signs of wear or damage. The new seatbelt must be type-approved and designed for installation at the same location as the replaced seatbelt.

* Option/accessory.

3.1.4. Resetting the electric seatbelt tensioner

The electric seatbelt tensioner is designed to be reset automatically, but the seatbelt tensioner can be reset manually if the belt remains extended.

- 1 Stop the car at a safe place.
 - 2 Unfasten the seatbelt and then refasten it.
- > The seatbelt and electric seatbelt tensioner are reset.

 **Warning**

Never modify or repair the seatbelts yourself. Volvo recommends that an authorised Volvo workshop should be contacted.

If the seatbelt has been subjected to a major load, such as in conjunction with a collision, the entire seatbelt must be replaced. Some of the seatbelt's protective properties may have been lost even if the seatbelt does not appear damaged. The seatbelt must also be replaced if it shows signs of wear or damage. The new seatbelt must be type-approved and designed for installation at the same location as the replaced seatbelt.

3.1.5. Door and seatbelt reminder

The system reminds unbelted occupants to wear a seatbelt, and also warns about an open door, bonnet or tailgate.

Information in the driver display

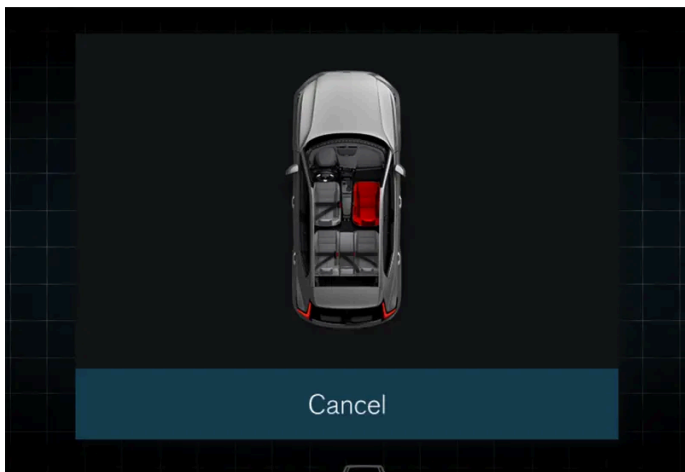

Graphic in the driver display.

The graphics in the driver display show the status of the seatbelts, bonnet, tailgate and doors.

The graphic can be acknowledged by pressing the  button on the right-hand steering wheel keypad.



As soon as the graphic has been acknowledged, or after a while if the graphic is not acknowledged, it can switch to a smaller format that appears at the top edge of the driver display.

Seatbelt reminder



Visual reminder in the roof console.

A visual reminder is given in the roof console and by means of the warning symbol in the driver display.

The type of visual reminder (fixed or flashing) and audible reminder (various signals) is dependent on the speed, driving time and distance.

i Note

The seatbelts built into child restraint systems are not included in the seatbelt reminder system.

Reminders or information are provided by graphics in different ways depending on the belt position.

For the front seat:

- a reminder is given when the driver or passenger is not wearing a seatbelt while the car is in motion
- a reminder is given when a seatbelt is removed while the car is in motion
- information is given on which seat belts are in use (or not).

For the rear seat:

- a reminder is given when a seatbelt is removed while the car is in motion
- information is given on which seat belts are in use (or not).

Reminders for doors, bonnet and tailgate

If the bonnet, tailgate or a door is not closed properly, the driver display's graphics show what is open. Stop the car in a safe place as soon as possible and close the source of the warning.

3.2. Airbags

3.2.1. Airbags

The car is equipped with a number of different airbags in order to assist in protecting driver and passengers.

Note

The detectors react differently depending on the nature of the collision and whether or not the seatbelts are fastened. Applies to all belt positions.

It is therefore possible that only one (or none) of the airbags may inflate in a collision. The detectors sense the force of the collision on the vehicle and the action is adapted accordingly so that none, one or more airbags are deployed.

Warning

The airbag system's control module is located in the centre console. If the centre console is drenched with water or other liquid, disconnect the cables to the starter battery. Do not attempt to start the car since the airbags may deploy. Recovering the car. Volvo recommends that it is transported to an authorised Volvo workshop.

Deployed airbags

If any of the airbags have deployed, the following is recommended:

- Recovering the car. Volvo recommends that it is transported to an authorised Volvo workshop. Do not drive with deployed airbags.
- Volvo recommends engaging an authorised Volvo workshop to handle the replacement of components in the car's safety systems.
- Seek medical attention if necessary.

Warning

Never drive with deployed airbags. They can make steering difficult. Other safety systems may also be damaged. The smoke and dust created when the airbags are deployed can cause skin and eye irritation/injury after intensive exposure. In case of irritation, wash with cold water. The rapid deployment sequence and airbag fabric may cause friction and skin burns.

3.2.2. Driver airbags

As a supplement to the seatbelts, the car is equipped with steering wheel airbag and knee airbag^[1] on the driver's side.



Steering wheel airbag and knee airbag^[1] on the driver's side in the front seat.

In the event of a frontal collision, the airbags help to protect the head, neck, face and chest of the driver as well as the knees and legs.

A sufficiently violent collision trips the sensors and the airbag/airbags is inflated. The airbag cushions the initial collision impact for the occupant. The airbag deflates when compressed by the collision. When this occurs, smoke escapes into the car. This is completely normal. The entire process, including inflation and deflation of the airbag, occurs within tenths of a second.

 **Warning**

The seatbelts and airbags interact. If the belt is not used or is used incorrectly, this may diminish the protection provided by the airbag in the event of a collision.

To minimise the risk of injury if the airbag deploys, passengers must sit as upright as possible with their feet on the floor and backs against the backrest.

 **Warning**

Volvo recommends that an authorised Volvo workshop should be contacted for repair. Defective work in the airbag system could cause malfunction and result in serious personal injury.

Steering wheel airbag location

This airbag is fitted into the centre of the steering wheel. The steering wheel is marked AIRBAG.

Knee airbag^[1] location

The airbag is folded up in the lower part of the instrument panel on the driver's side. Its cover panel is marked AIRBAG.

 **Warning**

Do not place or attach any object on the top or front of the panel where the knee airbag is stowed.

^[1] The car is only equipped with knee airbag in certain markets.

3.2.3. Passenger airbag

As a supplement to the seatbelts, the vehicle is equipped with an airbag on the passenger side in the front seat.



Passenger side front airbag.

In the event of a frontal collision, the airbag helps to protect the head, neck, face and chest of the passenger as well as the knees and legs.

A sufficiently violent collision trips the sensors and the airbag is inflated. The airbag cushions the initial collision impact for the occupant. The airbag deflates when compressed by the collision. When this occurs, smoke escapes into the car. This is completely normal. The entire process, including inflation and deflation of the airbag, occurs within tenths of a second.

 **Warning**

The seatbelts and airbags interact. If the belt is not used or is used incorrectly, this may diminish the protection provided by the airbag in the event of a collision.

To minimise the risk of injury if the airbag deploys, passengers must sit as upright as possible with their feet on the floor and backs against the backrest.

 **Warning**

Volvo recommends that an authorised Volvo workshop should be contacted for repair. Defective work in the airbag system could cause malfunction and result in serious personal injury.

Passenger airbag location

The airbag is folded up into a compartment above the glovebox. Its cover panel is marked AIRBAG.

 **Warning**

Do not put objects in front of or above the dashboard where the passenger airbag is located.

Label for passenger airbag



Label on the passenger side's sun visor.

The warning label for the passenger airbag is positioned as shown above.

 **Warning**

If the car is not equipped with a switch to activate/deactivate the passenger airbag, the airbag will always be activated.

 **Warning**

Never allow anybody to stand or sit in front of the front passenger seat.

Never use a rear-facing child seat on the front passenger seat if the airbag is activated.

Front-facing passengers (children and adults) must never sit on the front passenger seat if the passenger airbag is deactivated.

Failure to follow the advice given above can endanger life or lead to serious personal injury.

 **Warning**

NEVER use a rearward facing child restraint on a seat protected by an ACTIVE AIRBAG in front of it, DEATH or SERIOUS INJURY to the CHILD can occur.

3.2.4. Activating and deactivating passenger airbag*

The passenger airbag can be deactivated if the car is equipped with a switch, Passenger Airbag Cut Off Switch (PACOS).

The switch for the passenger airbag is located on the passenger end of the instrument panel and is accessible when the passenger door is open.

Check that the switch is in the required position.

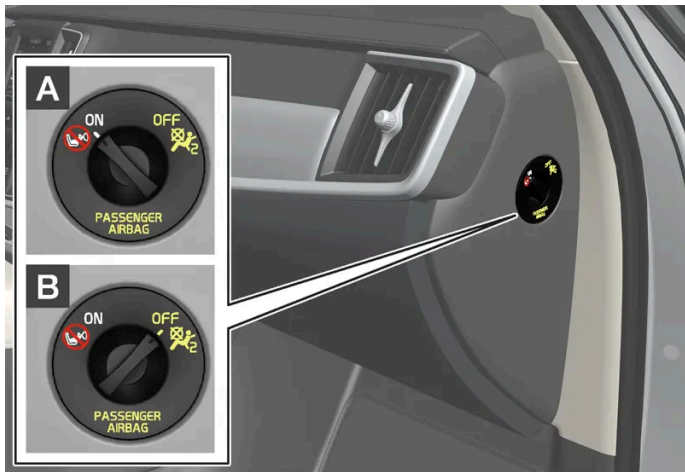

A ON - the airbag is activated and all front-facing passengers (children and adults) can sit safely on the passenger seat.

B OFF - the airbag is deactivated and children in rear-facing child seats can sit safely on the passenger seat.

 **Warning**

If the car is not equipped with a switch to activate/deactivate the passenger airbag, the airbag will always be activated.

Activating passenger airbag



1

Pull the switch outward and turn from OFF to ON.

➤ The driver display shows the message **Passenger airbag on**.

Note

If the passenger airbag has been activated/deactivated with the car in ignition position I or lower, a message is shown in the driver display and the following indicator in the roof console approx. 6 seconds after the car's electrical system has been set in ignition position II.

2 Confirm the message by pressing the right-hand steering wheel keypad's O button.



➤ A text message and a warning symbol in the roof console indicate that the airbag for the front passenger seat is activated.

Warning

Never use a rear-facing child seat on the front passenger seat when the airbag is activated.

The passenger airbag must always be activated when front-facing passengers (children and adults) are sitting in the front passenger seat.

Failure to follow the advice given above can endanger life or lead to serious personal injury.

Deactivating passenger airbag



1

Pull the switch outward and turn from ON to OFF.

➤ The driver display shows the message **Passenger airbag off**.

Note

If the passenger airbag has been activated/deactivated with the car in ignition position I or lower, a message is shown in the driver display and the following indicator in the roof console approx. 6 seconds after the car's electrical system has been set in ignition position II.

2 Confirm the message by pressing the right-hand steering wheel keypad's O button.



➤ A text message and a symbol in the roof console indicate that the airbag for the front passenger seat is deactivated.

Warning

Front-facing passengers (children and adults) must never sit on the passenger seat when the airbag is deactivated.

Failure to follow the advice given above can endanger life or lead to serious personal injury.

! Important

If the passenger airbag is deactivated, the electric seatbelt tensioner on the passenger side will also be deactivated.

* Option/accessory.

3.2.5. Inflatable curtains

The inflatable curtain, Inflatable Curtain (IC), helps to prevent the driver and passengers from striking their heads on the inside of the car during a collision.

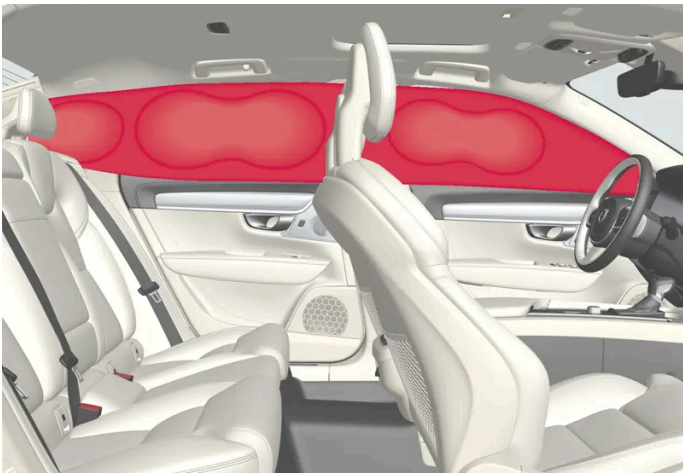

The inflatable curtain is mounted along both sides of the headlining and helps protect the driver and outer seat passengers of the car. The panels are labelled with IC AIRBAG.

A sufficiently violent collision trips the sensors and the inflatable curtain is inflated.

! Warning

Volvo recommends that an authorised Volvo workshop should be contacted for repair. Defective work in the inflatable curtain system can cause malfunction and result in serious personal injury.

! Warning

Never hang or attach heavy items onto the handles in the roof. The hooks are only designed for light coats and jackets (not for solid objects such as umbrellas).

Do not screw or install anything onto the car's headlining, door pillars or side panels. This could compromise the intended protection. Volvo recommends only using Volvo genuine parts that are approved for fitting within these areas.

 **Warning**

Leave 10 cm (4 inches) space between the load and the side windows if the car is loaded to above the top edge of the door windows. Otherwise, the intended protection of the inflatable curtain, which is concealed in the headlining, may be compromised.

 **Warning**

The inflatable curtain is a supplement to the seatbelts. Always use a seatbelt.

3.2.6. Near-side airbags

The near-side airbags on the driver's and passenger seats act to protect the chest and hips in the event of a collision.



The near-side airbags are fitted in the outer backrest frames of the front seats and help to protect the driver and passengers in the front seat.

A sufficiently violent collision trips the sensors and the near-side airbag is inflated. The airbag inflates between the occupant and the door panel and thereby cushions the initial impact. The airbag deflates when compressed by the collision. The near-side airbag is normally only deployed on the side of the collision.

 **Warning**

Volvo recommends that an authorised Volvo workshop should be contacted for repair. Defective work in the side airbag system could cause malfunction and result in serious personal injury.

 **Warning**

Do not put objects in the area between the outside of the seat and the door panel, since this area is required by the side airbag.

Volvo recommends the use only of car seat covers approved by Volvo. Other seat covers may impede the operation of the side airbags.

 **Warning**

Side airbags are a supplement the seatbelts. Always use a seatbelt.

Side airbags and child seats

The protection provided by the car to children seated in a child seat or on a booster cushion is not diminished by the side airbag.

3.3. Child safety

3.3.1. Mounting points for child seats

3.3.1.1. Lower mounting points for child seats

The car is equipped with lower mounting points for child seats in the front seat* and the rear seat.

The lower mounting points are designed to be used in conjunction with certain rear-facing child seats.

Always follow the manufacturer's installation instructions when connecting a child seat to the lower mounting points.

The location of the mounting points



Mounting point locations in the front seat.

The mounting points in the front seat* are located on the sides of the passenger seat's legroom.

The mounting points in the front seat may only be mounted if the vehicle is equipped with a switch to activate/deactivate the passenger airbag*.

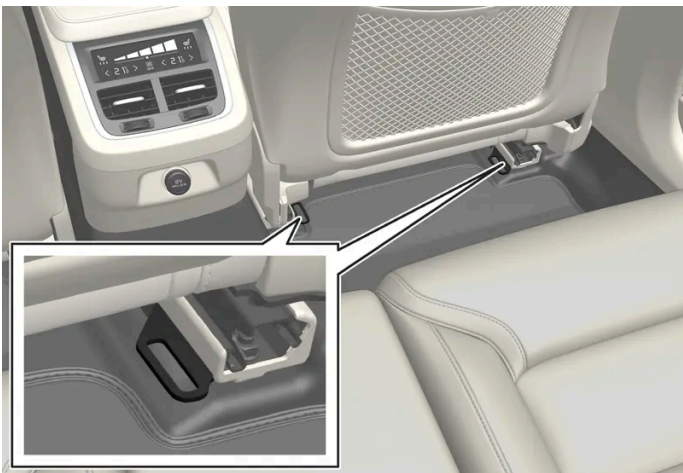

Mounting point locations in the rear seat.

The mounting points in the rear seat are located on the rear section of the front seat's floor rails.

i Note

Never store loose objects around a child restraint system's support leg. Make sure that loose parts of the child restraint system (e.g. fastening straps) are anchored as specified in the child restraint system's mounting instructions.

* Option/accessory.

3.3.1.2. i-Size/ISOFIX mounting points for child seats

The content of this manual represents the status of the user manual at the time of printing and may not be completely valid in future instances. For more information, refer to the first page for the complete disclaimer note.

The car is equipped with i-Size/ISOFIX mounting points for child seats in the rear seat.

i-Size/ISOFIX^[1] is a fixture system for car child seats that is based on an international standard.

Always follow the manufacturer's installation instructions when connecting a child seat to the i-Size/ISOFIX mounting points.

The location of the mounting points



Mounting point locations for the rear seat are indicated by symbols^[1] on the covers that conceal the mounting points.

The mounting points for i-Size/ISOFIX for the rear seat are located behind covers in the lower section of the rear seat's backrest, in the outer seats.

Lift the covers in order to access the mounting points. Locate the mounting points that may be positioned some way in behind the covers.

^[1] Names and symbols change depending on market.

3.3.1.3. Upper mounting points for child seats

The car is equipped with upper mounting points for child seats on the rear seat's outer seats.

The upper mounting points are primarily intended for use with front-facing child seats.

Always follow the manufacturer's installation instructions when connecting a child seat to the upper mounting points.

The location of the mounting points



Mounting point locations for the rear seat are indicated by symbols on the rear of the backrest.

The mounting points for the rear seat are located on the rear of the rear seat's outer seats.

Warning

The child seat's upper straps must be routed through the hole in the head restraint leg before they are tensioned at the mounting point. If this is not possible, follow the recommendations from the child seat manufacturer.

Note

Fold the head restraints in order to facilitate fitting this type of child seat in cars with folding head restraints on the outer seats, raise the head restraint after fitting.

The head restraint must always be raised when the child restraint system is used.

Note

In cars with a cargo cover over the luggage compartment, this must be removed before child seats can be attached to the securing points.

3.3.2. Integrated child seat

3.3.2.1. Integrated child seat *

The integrated child seats on the outer positions in the rear seat allow children to sit comfortably and safely.

The child seat is specially designed to provide children with good safety, together with the car's seatbelt. The seat cushion can be raised in two positions depending on the weight of the child.

The child seat is approved for children who weigh 15-36 kg (33-80 lbs) and are at least 95 cm (37 inches) tall.



Correct position, the seatbelt should be positioned in on the shoulder.

Check before driving that:

- the seat cushion is raised to the correct position for the weight of the child
- the seat cushion in locked in position
- the seatbelt is in contact with the child's body and is not slack or twisted
- the seatbelt does not lie across the child's throat or below the shoulder
- the lap section of the seatbelt is positioned low over the pelvis to provide optimal protection.

 **Warning**

Volvo recommends that repair or replacement of the integrated child seat is only performed by an authorised Volvo workshop. Do not make any modifications or additions to the child seat. If an integrated child seat has been subjected to a heavy load, e.g. in connection with a collision, then the seat cushion, seatbelt and backrest, or possibly the whole seat, must be replaced. Even if the child seat appears to be undamaged, it may not afford the same level of protection. This also applies if the seat cushion was in lowered position during a collision or similar. The seat cushion must also be replaced if it is heavily worn.

 **Warning**

If the instructions for the integrated child seat are not followed then the child could sustain serious injury in the event of an accident.

* Option/accessory.

3.3.2.2. Folding up the seat cushion in the integrated child seat *

The seat cushion should always be folded up when the integrated child seat is in use.

The seat cushion can be folded up in two positions. The position that should be used depends on the weight of the child.

	Lower position	Upper position
Weight	22-36 kg (50-80 lbs)	15-25 kg (33-55 lbs)

Lower position:

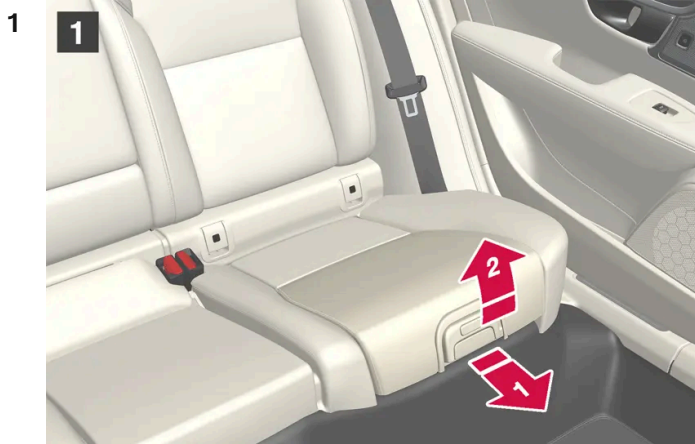

1
Pull the handle forwards and upwards to release the seat cushion.



2
Press the seat cushion backwards to lock.

Upper position, start from the lower position:



1
Press the button to release the seat cushion.

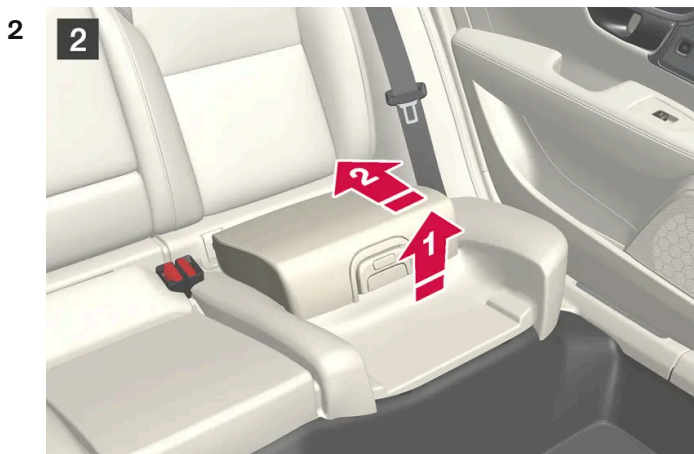

2
Lift the seat cushion up at the front edge and press it back against the backrest to lock.

 **Warning**

If the instructions for the integrated child seat are not followed then the child could sustain serious injury in the event of an accident.

 **Note**

It is not possible to adjust the seat cushion from the upper position to the lower position. From the upper position, the seat cushion must first be fully lowered into the rear seat, and then folded up to the lower position.

* Option/accessory.

3.3.2.3. Folding down the seat cushion in the integrated child seat*

The seat cushion should be folded down into the rear seat when the integrated child seat is not being used.

Note

It is not possible to adjust the seat cushion from the upper position to the lower position. From the upper position, the seat cushion must first be fully lowered into the rear seat, and then folded up to the lower position.



1
Pull the handle forwards to release the seat cushion.



2
Press down with your hand in the centre of the seat cushion in order to lock it.

 **Important**

Check that there are no loose objects (e.g. toys) left behind in the space under the child seat's seat cushion before lowering.

 **Note**

Before the rear backrest is lowered, the child seat's seat cushion must be lowered first.

* Option/accessory.

3.3.3. Child seat location

3.3.3.1. Table for location of child seats using the car's seatbelts

The table gives a recommendation for which child seats suit which locations, and for what size of child.

 **Note**

Always read the owner's manual section on installing a child seat before installing one in the car.

Weight	Front seat (with deactivated airbag, only rear-facing child seats) ^[1]	Front seat (with activated airbag, only front-facing child seats) ^[1]	Outer rear seat	Centre rear seat
Group 0 max 10 kg	U ^{[2], [3]}	X	U ^[3]	U ^[3]
Group 0+ max 13 kg	U ^{[2], [3]}	X	U ^[3]	U ^[3]
Group 1 9-18 kg	L ^[4]	UF ^{[2], [5]}	U, L ^[4]	U
Group 2 15-25 kg	L ^[4]	UF ^[2]	U ^{[6], [7], B*, [8], L^[4]}	U ^[6]
Group 3 22-36 kg	X	UF ^[2]	U ^{[7], [9], B*, [8]}	U ^[9]

U: Suitable for universal category restraints approved for use in this mass group.

UF: Suitable for front-facing universally approved child seats.

L: Suitable for particular child restraints. These restraints may be of the specific vehicle, restricted or semi-universal categories.

B: Built-in restraint approved for this mass group.

X: The seat is not suitable for children in this mass group.

 **Warning**

Never use a rear-facing child seat on the front passenger seat if the passenger airbag is activated.

- [1] The seat cushion extension must always be retracted for the installation of child seats.
 - [2] Adjust the backrest to a more upright position.
 - [3] Volvo recommends: Volvo infant seat (type approval E1 000008).
 - [4] Volvo recommends: Volvo rear-facing seat (type approval E5 04212).
 - [5] Volvo recommends rear-facing child seat for children in this mass group.
 - [6] Volvo recommends: Booster cushion with and without back (type approval E5 04216); Volvo booster seat (type approval E1 04301312).
 - [7] Volvo recommends: Römer KidFix XP (type approval E1 04301304).
- * Option/accessory.
- [8] Volvo recommends: Integrated child seat (type approval E5 04220).
 - [9] Volvo recommends: booster cushion with and without back (type approval E5 04216).

3.3.3.2. Child seat positioning

It is important to position the child seat in the right place in the car. The choice of location depends, amongst other things, on the type of child seat and whether the passenger airbag is activated.

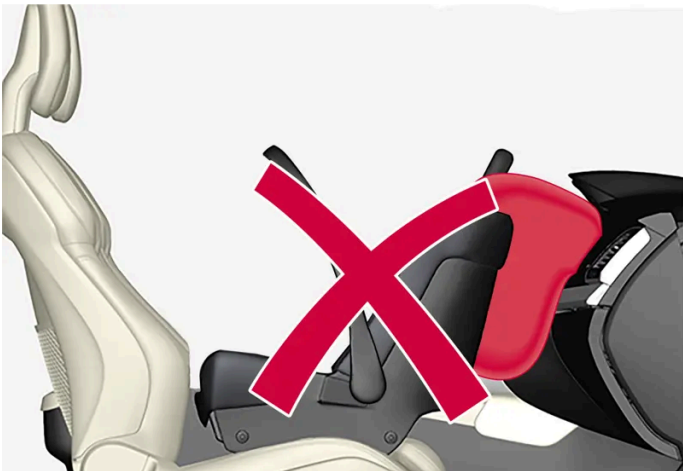

Rear-facing child seat and airbag are not compatible.

Always fit rear-facing child seats in the rear seat if the passenger airbag is activated. If a child is sitting on the front passenger seat then he/she could suffer serious injury if the airbag deploys.

If the passenger airbag is deactivated then rear-facing child seats can be fitted on the front passenger seat.

Note

Regulations regarding the placement of children in cars vary from country to country. Check what does apply.

Warning

Never allow anybody to stand or sit in front of the front passenger seat.

Never use a rear-facing child seat on the front passenger seat if the airbag is activated.

Front-facing passengers (children and adults) must never sit on the front passenger seat if the passenger airbag is deactivated.

Failure to follow the advice given above can endanger life or lead to serious personal injury.

Warning

NEVER use a rearward facing child restraint on a seat protected by an ACTIVE AIRBAG in front of it, DEATH or SERIOUS INJURY to the CHILD can occur.

Label for passenger airbag



Label on the passenger side's sun visor.

The warning label for the passenger airbag is positioned as shown above.

3.3.3.3. Child seat mounting

It is important to remember a number of things when a child restraint system is mounted and used, which depend on where the child restraint system is positioned.

 **Warning**

Booster cushions/child seats with steel braces or some other design that could rest on the seatbelt buckle's opening button must not be used, as they could cause the seatbelt buckle to open accidentally.

Do not secure the straps for the child seat into the seat's horizontal adjustment bar or in springs, rails or beams under the seat. Sharp edges may damage the straps.

Do not allow the upper section of the child seat to rest against the windscreen.

 **Note**

When using child safety equipment, it is important to read the installation instructions included.

In the event of questions when fitting child safety equipment, contact the manufacturer for clearer instructions.

 **Note**

Never leave a child seat loose in the car. Always secure it according to the instructions for the child seat, even when it is not in use.

 **Note**

Observe caution when fitting child restraint systems so that sharp edges or protruding parts of the child restraint system do not scratch the interior of the car.

Long-term installation and use of child seats may cause wear and tear on the car's fittings. Volvo recommends using the kick guard accessory to protect the car's fittings.

Regardless of location

- Only use child seats that are recommended by Volvo, are universally approved or are semi-universal, and where the car is included on the manufacturer's vehicle list.
- If the child seat is equipped with support legs, always fit the support leg/support legs directly to the floor. Never fit a support leg to a footrest or other object.
- When fitting adjustable, rear-facing child seats, the child seat must be adjusted so that the older the child is, the more upright the position is.

Installation in the front seat

- When using front-facing booster seats and loose booster cushions where the child uses the car's seatbelt, raise the front seat if necessary so that the seatbelt strap can be tensioned around the child's hips.
- When fitting rear-facing child seats, check that the passenger airbag is deactivated.
- When fitting front-facing child seats, check that the passenger airbag is activated.
- When fitting rear-facing child restraint systems, adjust the front seat to its lowest position unless otherwise specified in the relevant table for the location of child restraint systems.

- When fitting rear-facing child restraint systems, slide the front seat forward so that the child restraint system is in contact with or comes as close as possible to the instrument panel.
- ISOFIX child seats can only be fitted when the car is equipped with the ISOFIX console^[1] accessory.
- If the child seat is equipped with lower straps, Volvo recommends that the lower mounting points are used with these^[1].
- The ISOFIX guide can be used in order to facilitate installation of an ISOFIX-anchored child restraint system.

Installation in the rear seat

- A child seat with support legs must not be fitted in the centre seat.
- The outer seats are equipped with the ISOFIX fixture system and are approved for i-Size^[1].
- The outer seats are equipped with upper mounting points. Volvo recommends that child seat's upper straps should be pulled through the hole in the head restraint before being tensioned at the mounting point. If this is not possible, follow the recommendations from the child seat manufacturer.
- If the child seat is equipped with lower straps, never adjust the position of the seat in front after the straps have been fitted in the lower mounting points. Always remember to remove the lower straps when the child seat is not installed.



With the installation of an infant seat in the rear seat, Volvo recommends a distance of at least 50 mm (2 tum) from the front part of the infant seat to the rear part of the seat in front.

^[1] Varies depending on market.

3.3.3.4. Table for location of ISOFIX child seats

The table gives a recommendation for which ISOFIX child seats suit which locations, and for what size of child.

The child seat must be approved in accordance with UN Reg R44 and the car model must be included in the manufacturer's vehicle list.

Note

Always read the owner's manual section on installing a child seat before installing one in the car.

Weight	Size class ^[1]	Type of child seat	Front seat (with deactivated airbag, only rear-facing child seats) ^{[2], [3]}	Front seat (with activated airbag, only front-facing child seats) ^{[2], [3]}	Outer rear seat	Centre rear seat
Group 0 max 10 kg	E	Rear-facing infant seat	IL ^{[2], [4], X^[5]}	X	IL ^[4]	X
Group 0+ max 13 kg	E	Rear-facing infant seat	IL ^{[2], [4], [6], X^[5]}	X	IL ^[4]	X
	C	Rear-facing child seat				
	D	Rear-facing child seat				
Group 1 9-18 kg	A	Front-facing child seat	X	IL ^{[2], [6], [7], X^[5]}	IL ^{[7], IUF^[7]}	X
	B	Front-facing child seat				
	B1	Front-facing child seat				
	C	Rear-facing child seat	IL ^{[2], [6], X^[5]}	X	IL ^[8]	X
	D	Rear-facing child seat				
Group 2/ 3 15-36 kg	–	Front-facing child seat	X	IL	IL	X

IL: Suitable for particular ISOFIX child restraint systems. These child restraint systems are those of the specific vehicle, restricted or semi-universal categories.
IUF: Suitable for ISOFIX forward child restraint systems of universal category approved for use in the mass group.
X: Not suitable for ISOFIX child restraint systems.

Warning

Never use a rear-facing child seat on the front passenger seat if the passenger airbag is activated.

Note

If an i-Size/ISOFIX child seat has no size classification, the car model must be included on the vehicle list for the child seat.

Note

Volvo recommends contacting an authorised Volvo dealer for information about which i-Size/ISOFIX child seats Volvo recommends.

- [1] For child seats with the ISOFIX fixture system there is a size classification to help users choose the right type of child seat. The size class can be read on the child seat's label.
- [2] Works for the installation of ISOFIX child seats that are semi-universally approved (IL) if the car is equipped with the ISOFIX console accessory (the accessory range varies depending on market). There are no upper mounting points for child seats here.
- [3] The seat cushion extension must always be retracted for the installation of child seats.
- [4] Volvo recommends: Volvo infant seat secured using the ISOFIX fixture system (type approval E1 000008).
- [5] Applicable if the car is not fitted with an ISOFIX bracket.
- [6] Adjust the backrest so that the head restraint does not interfere with the child seat.
- [7] Volvo recommends rear-facing child seat for children in this mass group.
- [8] Volvo recommends: BeSafe iZi Kid X3 ISOfix (type approval E5 04200).

3.3.3.5. Table for location of i-Size child seats

The table gives a recommendation for which i-Size child seats suit which locations, and for what size of child.

The child seat must be approved in accordance with UN Reg R129.

Note

Always read the owner's manual section on installing a child seat before installing one in the car.

Type of child seat	Front seat (with deactivated airbag, only rear-facing child seats)	Front seat (with activated airbag, only front-facing child seats)	Outer rear seat	Centre rear seat
i-Size child seats	X	X	i-U ^[1]	X

i-U: Suitable for i-Size "universal" child seat, front-facing and rear-facing.
 X: Not suitable for universally approved child seats.

- [1] Volvo recommends that children travel in a rear-facing child seat until as late an age as possible, at least until 4 years of age.

3.3.4. Activating and deactivating child safety locks

The child safety lock prevents the rear doors from being opened from inside. With electric child safety locks, power window operation from the rear seat is also prevented.

The child lock can be either manual or electrical*.

Manual child lock

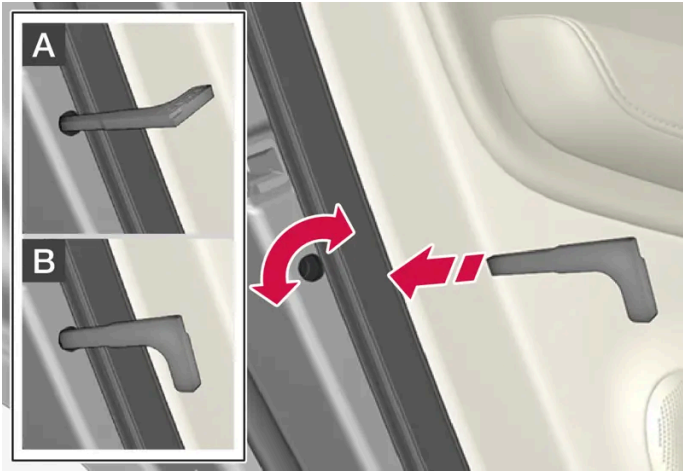

Manual child lock. Not to be confused with manual door locks.

- 1 Use the key's detachable key blade to turn the knob.

A The door is blocked against opening from the inside.

B The door can be opened from both the outside and the inside.

i Note

- A door's knob control only blocks that particular door - not both rear doors simultaneously.
- Cars with an electric child safety lock do not have a manual child lock.

Electric child lock*

The electric child lock can be activated and deactivated in all ignition positions above **0**. Activation and deactivation can be performed up to 2 minutes after switching off the car, provided that no door is opened.



Activation and deactivation button.

Rear child safety lock enabled

When the lamp in the button is illuminated, the child safety lock is enabled.

If the child lock is activated when the car is switched off, it will remain activated the next time the car is started.

- Rear doors cannot be opened from the inside.
- Rear power windows can only be operated from the driver's door.

Rear child safety lock disabled

When the lamp in the button is not illuminated, the child safety lock is disabled.

- Rear doors can be opened from the inside and power windows operated from the rear seat.

Symbols and messages

Symbol	Message	Specification
	Rear child lock activated	The child lock is activated.
	Rear child lock deactivated	The child lock is deactivated.

* Option/accessory.

3.3.5. Child safety

Children must always sit secure while travelling in the car.

Volvo has child safety equipment (child seats and attachment devices) which is designed for fitting in this particular car. Using Volvo's child safety equipment, you obtain good conditions for a child to travel safely in the car. In addition, the child safety equipment fits in well and is simple to use.

The equipment that should be used is selected taking account of the weight and size of the child.

Volvo recommends that children travel in a rear-facing child seat until as late an age as possible, at least until 4 years of age, and then in a front-facing child seat until the child is 140 cm (4 feet 7 inches) tall.

Note

Legal provisions about the type of child seat that must be used for children of different ages and heights vary from country to country. Check what does apply.

i Note

When using child safety equipment, it is important to read the installation instructions included.

In the event of questions when fitting child safety equipment, contact the manufacturer for clearer instructions.

Children of all ages and sizes must always sit correctly secured in the car. Never allow a child to sit on the knee of a passenger.

3.3.6. Child seats

Suitable child seats should always be used when children are travelling in the car.

Children should sit comfortably and safely. Make sure that the child seat is positioned, mounted and used correctly.

Look in the installation instructions for the child seat for the correct fitting.

i Note

When using child safety equipment, it is important to read the installation instructions included.

In the event of questions when fitting child safety equipment, contact the manufacturer for clearer instructions.

i Note

Never leave a child seat loose in the car. Always secure it according to the instructions for the child seat, even when it is not in use.

i Note

Observe caution when fitting child restraint systems so that sharp edges or protruding parts of the child restraint system do not scratch the interior of the car.

Long-term installation and use of child seats may cause wear and tear on the car's fittings. Volvo recommends using the kick guard accessory to protect the car's fittings.

i Note

For child restraint systems where the child uses the car's integrated seatbelt, read the owner's manual's recommendations about seatbelts.

3.3.7. Activating and deactivating passenger airbag*

The content of this manual represents the status of the user manual at the time of printing and may not be completely valid in future instances. For more information, refer to the first page for the complete disclaimer note.

The passenger airbag can be deactivated if the car is equipped with a switch, Passenger Airbag Cut Off Switch (PACOS).

The switch for the passenger airbag is located on the passenger end of the instrument panel and is accessible when the passenger door is open.

Check that the switch is in the required position.

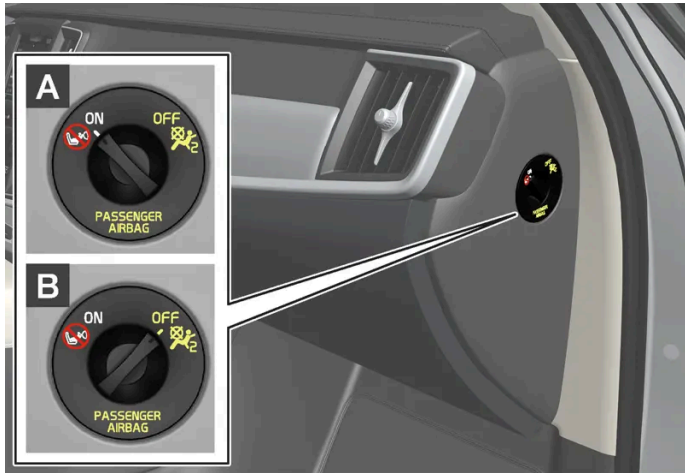

A ON - the airbag is activated and all front-facing passengers (children and adults) can sit safely on the passenger seat.

B OFF - the airbag is deactivated and children in rear-facing child seats can sit safely on the passenger seat.

 **Warning**

If the car is not equipped with a switch to activate/deactivate the passenger airbag, the airbag will always be activated.

Activating passenger airbag



1

Pull the switch outward and turn from OFF to ON.

➤ The driver display shows the message **Passenger airbag on**.

Note

If the passenger airbag has been activated/deactivated with the car in ignition position I or lower, a message is shown in the driver display and the following indicator in the roof console approx. 6 seconds after the car's electrical system has been set in ignition position II.

- 2 Confirm the message by pressing the right-hand steering wheel keypad's **O** button.



- A text message and a warning symbol in the roof console indicate that the airbag for the front passenger seat is activated.

Warning

Never use a rear-facing child seat on the front passenger seat when the airbag is activated.

The passenger airbag must always be activated when front-facing passengers (children and adults) are sitting in the front passenger seat.

Failure to follow the advice given above can endanger life or lead to serious personal injury.

Deactivating passenger airbag

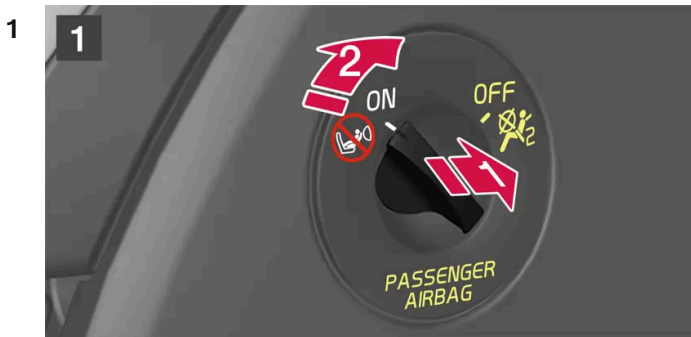

- 1 Pull the switch outward and turn from ON to OFF.

- The driver display shows the message **Passenger airbag off**.

Note

If the passenger airbag has been activated/deactivated with the car in ignition position I or lower, a message is shown in the driver display and the following indicator in the roof console approx. 6 seconds after the car's electrical system has been set in ignition position II.

- 2 Confirm the message by pressing the right-hand steering wheel keypad's **O** button.



- A text message and a symbol in the roof console indicate that the airbag for the front passenger seat is deactivated.

Warning

Front-facing passengers (children and adults) must never sit on the passenger seat when the airbag is deactivated. Failure to follow the advice given above can endanger life or lead to serious personal injury.

Important

If the passenger airbag is deactivated, the electric seatbelt tensioner on the passenger side will also be deactivated.

* Option/accessory.

3.4. Safety mode

3.4.1. Traffic accident

If your car is involved in a traffic accident, activate the hazard warning flashers and move the car into a safer position if possible.

The content of this manual represents the status of the user manual at the time of printing and may not be completely valid in future instances. For more information, refer to the first page for the complete disclaimer note.

Do not attempt to restart the car if there is a smell of fuel when the driver display shows the message **Safety mode See Owner's manual**. If so, leave the car at once!

Call the emergency services or roadside assistance as necessary.

Depending on the car's equipment, the car itself can detect an accident and contact the nearest emergency call centre. If the car does not have Volvo Assistance*, there is a European legal requirement, Pan-European eCall, that provides access to an automatic collision alarm and urgent assistance in emergency situations^[1].

- Think about safety when exiting the car!
- Use a reflective vest and position the warning triangle so that other road users are warned.

If you collide with a wild animal

Be careful, injured animals can feel trapped and then defend themselves.

Call the police to get help with humane killing if the animal is seriously injured, or move a dead animal away from the road so that it is not a danger to other road users.

* Option/accessory.

^[1] Applies to certain markets.

3.4.2. Safety mode

Safety mode is a protective state that is triggered when a collision may have damaged any of the car's vital functions, such as the fuel lines, sensors for any of the safety systems, or the brake system.

If the car has been in a collision, the message **Safety mode See Owner's manual** may be shown on the driver display with a warning symbol as long as the display is not damaged and the car's electrical system is still in working order. This message means that the car has reduced functionality.

Warning

Never, under any circumstances, attempt to restart the car if it smells of fuel when the **Safety mode See Owner's manual** message is shown in the driver display. Leave the car at once.

If the car is in safety mode, it is possible to attempt to reset the system in order to start and move the car for a short distance, if in a dangerous traffic situation for example.

Warning

Never attempt to repair your car or reset the electronics yourself if the car has been in safety mode. This could result in personal injury or the car not functioning as normal. Volvo recommends engaging an authorised Volvo workshop to check and restore the car to normal status after **Safety mode See Owner's manual** has been shown.

 **Warning**

If the car is in safety mode it must not be towed. It must be transported from its location. Volvo recommends that it is transported to an authorised Volvo workshop.

3.4.3. Starting and moving the car after safety mode

If the car is in safety mode, it is possible to attempt to reset the system in order to start and move the car for a short distance, if in a dangerous traffic situation for example.

Reset and start the car after safety mode

- 1 Check the general damage situation of the car and whether any fuel has been leaking. There must be no smell of fuel either.

If there is only minor damage and a check has revealed no fuel leaks, starting can be attempted.

 **Warning**

Never, under any circumstances, attempt to restart the car if it smells of fuel when the **Safety mode See Owner's manual** message is shown in the driver display. Leave the car at once.

- 2 Switch off the car manually.
 - 3 Then try to start the car.
- The car's electronics carry out a systems check and then try to resume normal status.

 **Important**

If the message **Safety mode See Owner's manual** is still shown on the display the car must not be driven or towed but a vehicle recovery service must then be used instead. Even if the car appears to be driveable, hidden damage may make the car impossible to control once moving.

Moving the car after safety mode

- 1 If the driver display shows the message **The car is now in normal mode** after a start attempt, the car can be carefully moved if standing in a dangerous position.
- 2 Do not move the car further than necessary.

Warning

If the car is in safety mode it must not be towed. It must be transported from its location. Volvo recommends that it is transported to an authorised Volvo workshop.

3.5. Safety

The vehicle is equipped with several safety systems that work together to protect the vehicle's driver and passengers in the event of an accident.

The car is equipped with a number of sensors that react in the event of an accident and activate different safety systems, such as different types of airbags and seatbelt tensioners. Depending on the specific accident situation, such as collisions at different angles, roll-over or driving off the road, the systems react in different ways to provide good protection.

There are also mechanical safety systems such as Whiplash Protection System. The car is also constructed so that a large part of the force of a collision is distributed to beams, pillars, floor, roof and other parts of the body.

The car's safety mode may be activated after a collision if an important function in the car has been damaged.

Warning symbol in driver display



The warning symbol is illuminated in the driver display when the car's electrical system is set in ignition position **II**. The symbol is extinguished after approx. 6 seconds if the car's safety system is fault-free.

Warning

If the warning symbol remains illuminated or is switched on during driving and the message **Drive to workshop SRS airbag Service urgent** is shown in the driver display, it means that part of one of the safety systems does not have full functionality. Volvo recommends that an authorised Volvo workshop should be contacted as soon as possible.

 **Warning**

Never modify or repair the car's various safety systems yourself. Defective work in one of the systems can cause malfunction and result in serious personal injury. Volvo recommends that an authorised Volvo workshop should be contacted.



If the specific warning symbol is broken then the general warning symbol is illuminated instead and the driver display shows the same message.

3.6. Pedestrian Protection System

The Pedestrian Protection System (PPS) is a system which, in certain frontal collisions, contributes to mitigating a pedestrian's impact with the car.

In certain frontal collisions with a pedestrian, the sensors in the front of the car react and the system is activated.

When PPS is activated, the following occur:

- The rear section of the bonnet is raised.
- An automatic alarm is sent via Volvo Assistance.

The sensors are active at a speed of approx. 25-50 km/h (15-30 mph).

The sensors are designed to detect a collision with an object that has similar properties to those of the human leg.

 **Note**

There may be objects in the traffic environment that prompt a signal to the sensors that is similar to a collision with a pedestrian. It is possible that the system will be activated in the event of a collision with such an object.

 **Warning**

Do not fit any accessories or change anything in the front. Incorrect intervention at the front may cause incorrect function in the system and lead to serious injury and damage to the car.

Volvo recommends that genuine wiper arms are used and that only genuine parts are used for them.

 **Warning**

Never modify or repair the system yourself. Volvo recommends that an authorised Volvo workshop should be contacted. Defective work in the system could cause malfunction and result in serious personal injury.

 **Warning**

Volvo recommends contacting an authorised Volvo workshop in the event of any damage to the front of the car in order to ensure that the system is intact.

Symbols in the driver display

Symbol	Specification
	PPS has been activated, or a fault has occurred in the system. Follow the recommendation shown.

 **Warning**

Never drive the car if the bonnet is blocking your view after the system has been activated. Instead, Volvo recommends that the car is towed.

3.7. Safety during pregnancy

It is important that the seatbelt is used correctly during pregnancy, and that pregnant drivers adjust their seating position.

Seatbelt

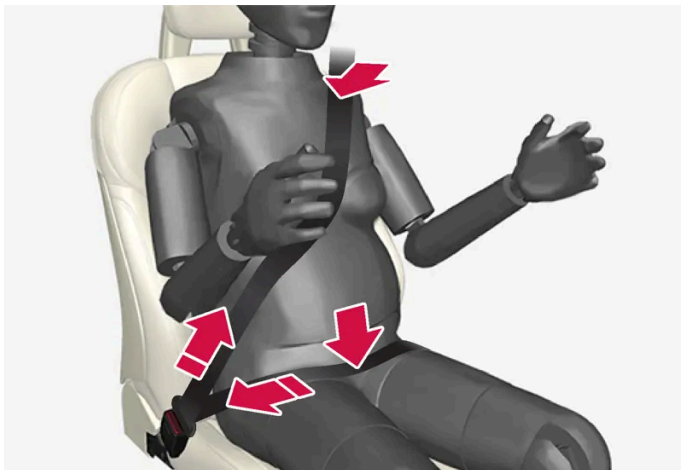

The diagonal section should wrap over the shoulder then be routed between the breasts and to the side of the abdomen.

The lap section should lay flat over the thighs and as low as possible under the abdomen. – It must never be allowed to ride upward. Remove the slack from the seatbelt and ensure that it fits as close to the body as possible. In addition, check that there are no twists in the seatbelt.

Seating position

As the pregnancy progresses, pregnant drivers must adjust the seat and steering wheel such that they can easily maintain control of the vehicle as they drive (which means that they must be able to easily operate the foot pedals and steering wheel). The aim should be to position the seat with as large a distance as possible between abdomen and steering wheel.

3.8. Whiplash Protection System

Whiplash Protection System (WHIPS) reduces the risk of whiplash injuries. The system consists of energy absorbing backrests and seat cushion, as well as a specially designed head restraint in the front seats.

WHIPS is deployed in the event of a rear-end collision, where the angle and speed of the collision and the nature of the colliding vehicle all have an influence.

When WHIPS is deployed, the front seat backrests are lowered backward and the seat cushions move downward to change the seating position of the driver and front seat passenger. Its movement helps to absorb some of the forces that can arise and cause whiplash.

Warning

WHIPS is a supplement to the seatbelts. Always use a seatbelt.

Warning

Never modify or repair the seat or WHIPS yourself. Volvo recommends that an authorised Volvo workshop should be contacted.

If the front seats have been subjected to a major load, such as in conjunction with a collision, the seats must be replaced. Some of the seats' protective properties may have been lost even if they do not appear damaged.

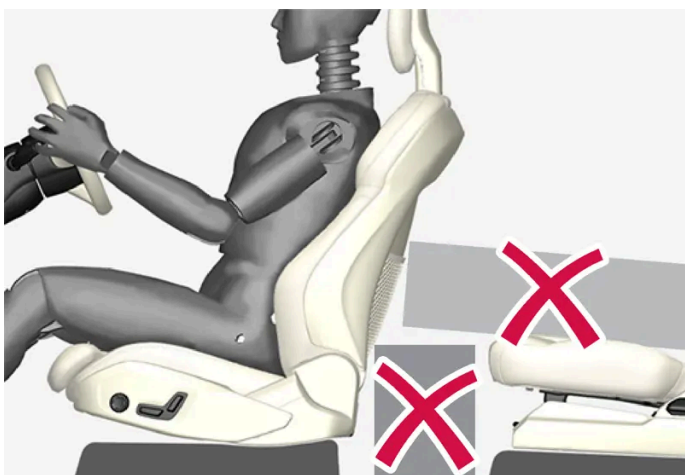

Do not leave any objects on the floor behind or under the front seats or in the rear seat that may prevent WHIPS from functioning.

 **Warning**

Do not squeeze rigid objects between the rear seat cushion and the front seat's backrest.

If a backrest in the rear seat is lowered then any load must be secured to prevent it from sliding up to the front seat backrest in the event of a collision.

 **Warning**

If a backrest in the rear seat is lowered or a rear-facing child seat is used in the rear seat, the corresponding front seat must be moved forward so that it does not make contact with the lowered backrest or child seat.

Seating position

For good protection from WHIPS the driver and passenger must have the correct seating position and make sure that the system's function is not obstructed.

Set the correct seating position in the front seat before driving starts.

Driver and front seat passenger should sit in the centre of the seat with as little space as possible between the head and the head restraint.

WHIPS and child seats

The protection provided by the car to children seated in a child seat or on a booster cushion is not diminished by WHIPS.

4. Displays and voice control

4.1. Driver display

4.1.1. Gauges and indicators in driver display

4.1.1.1. Fuel gauge

The fuel gauge in the driver display shows the fuel level in the tank.

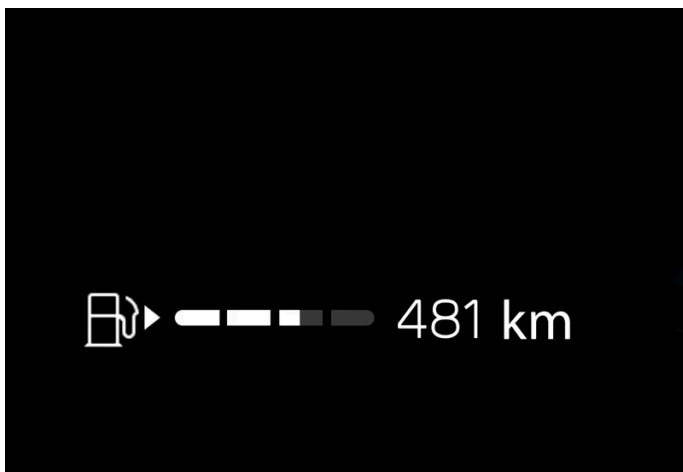

The white zone in the fuel gauge indicates the quantity of fuel in the tank.

When the fuel level is low, the fuel pump symbol illuminates and turns amber colour. Distance to empty tank is also indicated in the fuel gauge.

Distance to empty tank

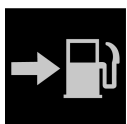

The trip computer calculates how far you can drive with the amount of fuel in the tank.

The calculation is based on the average fuel consumption over the last 30 km (20 miles) and the remaining amount of fuel.

When the gauge shows "----", there is not enough fuel left to be able to calculate the remaining mileage. Then, refuel as soon as possible.

 **Note**

There may be a slight deviation if the driving style has been changed.

An economic driving style generally results in a longer driving distance.

4.1.1.2. Outside temperature gauge

The temperature outside of the car is shown in the driver display. If the car has been stationary for a long time, the temperature value shown by the gauge may be too high.



When the temperature outside of the car is between $-5\text{ }^{\circ}\text{C}$ ($23\text{ }^{\circ}\text{F}$) and $+2\text{ }^{\circ}\text{C}$ ($36\text{ }^{\circ}\text{F}$) a snowflake symbol illuminates to warn of potentially slippery conditions.

Settings for the temperature gauge

- 1 Press .
- 2 Select **System**.
- 3 Press **Units**.
- 4 Change the settings you want.

4.1.1.3. Gear shift indicator

The gear shift indicator in the driver display shows the current gear during manual gearshifting and when it is appropriate to engage the next gear for optimum fuel economy.

For eco-driving during manual gear changing, it is important to drive in the right gear and to change gear in good time.

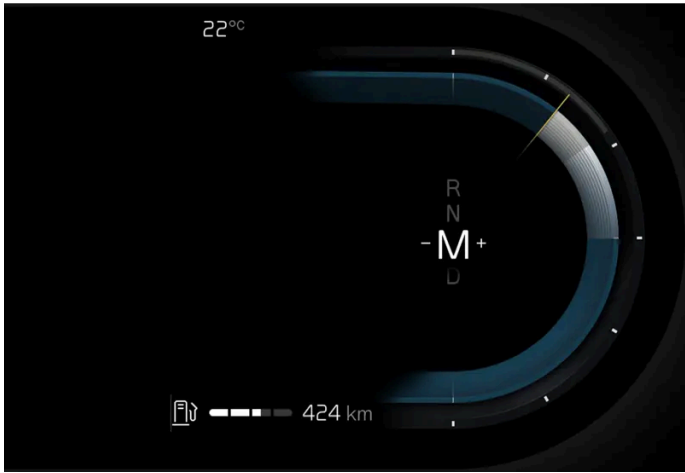

Gear shift indicator in the driver display.

The gear shift indicator shows the current gear in the driver display and indicates recommended shifting to a higher or lower gear by a flashing plus or minus sign.

4.1.2. Trip computer

4.1.2.1. Trip computer

The car's trip computer records values such as mileage, average consumption and average speed.

Information in the trip computer

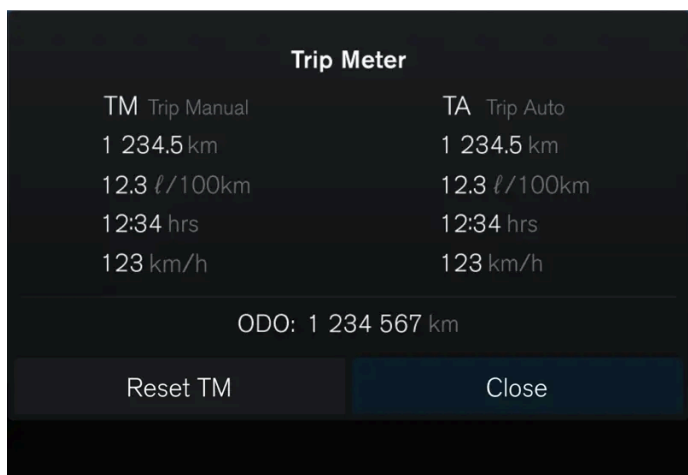

The values shown in the trip computer are as follows:

- Mileage
- Average consumption

The content of this manual represents the status of the user manual at the time of printing and may not be completely valid in future instances. For more information, refer to the first page for the complete disclaimer note.

- Driving time
- Average speed

Open trip computer

- 1 Press the  button on the steering wheel.
 - > Trip computer is opened.

Trip meter

There are two trip meters, TM and TA. ^[1]

TM can be reset manually and TA is reset automatically if the car is not used for at least four hours.

Odometer

The odometer records the car's total mileage. This value cannot be reset to zero.

Trip computer settings

Trip computer settings are made via the centre display.

- 1 Press .
- 2 Select **Controls**.
- 3 Change the settings you want.

^[1] Trip Manual and Trip Automatic

4.1.2.2. Resetting the trip meter

The trip meter can be reset to zero in the driver display or by using the left-hand stalk switch.

Reset all information in the trip meter TM to zero (mileage, average consumption, average speed and driving time).

Resetting to zero in the driver display

- 1 Press the **O** button on the steering wheel.
 - 2 Select **Reset TM** using the steering wheel buttons.
 - 3 Confirm with the **O** button to reset.
- The trip meter is reset.

Resetting using the stalk switch



- 1 Give a long press on the **RESET** button on the stalk switch.
- The trip meter is reset.

4.1.3. Driver display

The driver display shows information about the car and driving.

The driver display contains gauges, driver support functions, and indicator and warning symbols, among other things. The content of the driver display depends on the car's equipment, settings and which functions are active at that time.

The driver display is activated as soon as a door is opened. The driver display extinguishes after a while if it is not used. To reactivate it, proceed with one of the following:

- Activate ignition position I.
- Open one of the doors.

Warning

If the driver display should extinguish, not illuminate on activation/start or be fully or partially illegible, the car must not be used. You should visit a workshop immediately. Volvo recommends an authorised Volvo workshop.

Warning

In the event of a fault in the driver display the information on e.g. brakes, airbags or other safety systems may not be shown. In which case, the driver cannot check the status of the car's systems or receive current warnings and information.



Location in the driver display:

On the left	In the middle	On the right
Indicator and warning symbols	Indicator and warning symbols	Indicator and warning symbols
Speedometer	Temperature	Tachometer
Cruise control and speed limiter information	Messages, in some cases with graphics	Drive mode
Trip meter	Door and seatbelt information	Driving direction selected
–	Driver support functions	Regenerative braking ^[1]
–	App menu (activated via steering wheel keypad)	Fuel gauge

^[1] Only applies to mild hybrid.

4.1.4. Driver display settings

Change display mode or set what should be shown in the driver display.

App menu



 – Information on trip meter and odometer, among other things.

Managing the app menu

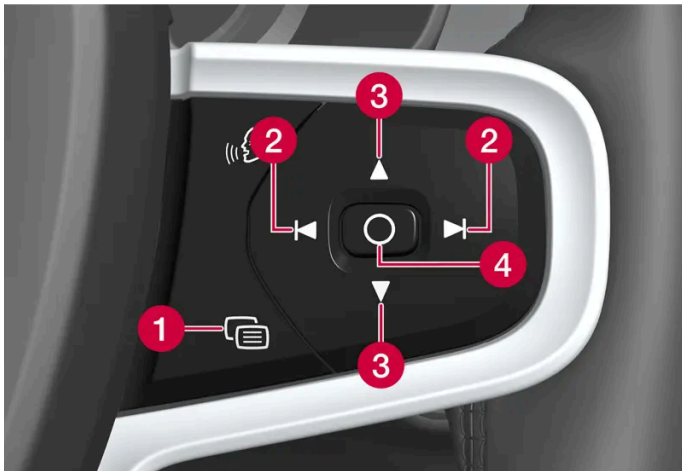

- 1 Close menu/change display mode
- 2 Left/right
- 3 Up/down
- 4 Open menu/confirm

The app menu closes after a period of inactivity or after certain options have been selected.

Display modes

The driver display has two different display modes that are changed via the  button on the right-hand side of the steering wheel.

- Calm - the middle section of the driver display is empty.
- Navigation* - a map is shown of the entire driver display.

Settings in the centre display

The content of this manual represents the status of the user manual at the time of printing and may not be completely valid in future instances. For more information, refer to the first page for the complete disclaimer note.

Driver display settings are made via the centre display.

- 1 Press .
- 2 Select **Controls**.
- 3 Change the settings you want.

These settings are personal and are saved to the active user profile.

* Option/accessory.

4.1.5. License agreement for driver display

A license is an agreement for the right to operate a certain activity or the right to use someone else's entitlement according to the terms and conditions in the agreement. The following text is Volvo's agreement with the manufacturer or developer.

1.1 List of used Open Source Components

This table contains a list of open source software (OSS) components used within the product under the terms of the respective licenses. The source code corresponding to the open source components is also provided along with the product wherever mandated by the respective OSS license

SI No.	Name of OSS Component	Version of OSS Component	Name and Version of License (License text can be found in Appendix below)	Home Page	More Information
1	BidiReferenceCpp	26	Unicode Terms of Use	http://www.unicode.org/Public/PR/OGRAMS/BidiReferenceCpp/	(C) Socionext Embedded Software Austria GmbH (SESA) Copyright (C) 1999-2009, ASMUS, Inc
2	FASTCRC32	1.2.8	License of Stephan brumme/ Zlib style License	http://stephan-brumme.com/	Copyright © 2011-2013 Stephan Brumme. All rights reserved, Copyright (C) 1995-2006, 2010, 2011, 2012 Mark Adler
3	Freescale IMX6 HDMI	5.0.11	BSD 3-clause "New" or "Revised" License	https://www.nxp.com/ [https://www.nxp.com/]	Copyright © 2009-2012, Freescale Semiconductor, Inc, Copyright © 2010-2012, Freescale Semiconductor, Inc.

SI No.	Name of OSS Component	Version of OSS Component	Name and Version of License (License text can be found in Appendix below)	Home Page	More Information
4	FreeType Hashing	2.6.3	MIT License	https://sourceforge.net/p/canvasdraw/cd/642/tree/trunk/freetype/include/freetype/internal/fthash.h [http://sourceforge.net/p/canvasdraw/cd/642/tree/trunk/freetype/include/freetype/internal/fthash.h]	Copyright 2000 Computing Research Labs, New Mexico State University Copyright 2001-2015 Francesco Zappa Nardelli
5	Freetype Project - BDF	2.6.3	MIT License	https://sourceforge.net/projects/freetype/files/freetype2/2.6.3/ [http://www.freetype.org/]	Copyright (C) 2001-2014 by Francesco Zappa Nardelli. Copyright 2000 Computing Research Labs, New Mexico State University
6	Freetype Project -PCF	2.6.3	MIT License	https://sourceforge.net/projects/freetype/files/freetype2/2.6.3/ [http://www.freetype.org/]	Copyright 2000-2001, 2003 by Francesco Zappa Nardelli Copyright (C) 2000, 2001, 2002, 2003, 2006, 2010 by Francesco Zappa Nardelli Copyright (C) 2000-2004, 2006-2011, 2013, 2014 by Francesco Zappa Nardelli Copyright 2000-2010, 2012-2014 by Francesco Zappa Nardelli Copyright 2003 by Francesco Zappa Nardelli
7	Freetype Project - Pcfutil	2.6.3	Open Group License	https://sourceforge.net/projects/freetype/files/freetype2/2.6.3/ [http://www.freetype.org/]	Copyright 1990, 1994, 1998 The Open Group
8	HarfBuzz	1.3.1	MIT License	http://freedesktop.org/wiki/Software/HarfBuzz	Copyright © 2007 Chris Wilson Copyright © 2009,2010 Red Hat, Inc. Copyright © 2011, 2012 Google, Inc.
9	Integrity Libnet	1.16	Internet Software Consortium-IBM License ISC License	https://github.com/lattera/glibc/blob/master/resolv/inetpton.c [http://github.com/lattera/glibc/blob/master/resolv/inetpton.c]	Copyright © 1996 by Internet Software Consortium. Consortium, Copyright © 1995 by International Business Machines, Inc.
10	Khronos EGL Headers	1.4	MIT License	http://www.khronos.org/registry/egl/	Copyright © 2007-2013 The Khronos Group Inc. Copyright 2008 VMware, Inc. Copyright © 2013-2014 The Khronos Group Inc.
11	Khronos Group - OpenGL ES	2.0	SGI Free Software License B v2.0	http://www.khronos.org/opengles/	
12	libjpeg	6b	Independent JPEG Group License	http://www.ijg.org/	Copyright (C) 1991-1998, Thomas G. Lane.
13	libpng	1.4.22	libpng License	http://github.com/coapp-package/libpng/	Copyright © 1998-2010 Glenn Randers-Pehrson Copyright © 2007, 2009 Glenn Randers-Pehrson Version 0.96 Copyright © 1996, 1997 Andreas Dilger Version 0.88 Copyright © 1995, 1996 Guy Eric Schalnat, Group 42, Inc.

SI No.	Name of OSS Component	Version of OSS Component	Name and Version of License (License text can be found in Appendix below)	Home Page	More Information
14	Libunibreak	1.2.8	zlib License	https://github.com/adah1972/libunibreak [https://github.com/adah1972/libunibreak]	Copyright (C) 2008-2011 Wu Yongwei Copyright (C) 2012 Tom Hacoen tom@stosb.com
15	Iz4 Compression algorithm	1.4.0	BSD 2-clause "Simplified" License	http://github.com/Cyan4973/iz4/	Copyright (C) 2011-2014, Yann Collet
16	md5	1.6	Public Domain	https://doxygen.reactos.org/d7/d04/sdk_2lib_23rdparty_2freetype_2src_2base_2md5_8c_source.html [https://doxygen.reactos.org/d7/d04/sdk_2lib_23rdparty_2freetype_2src_2base_2md5_8c_source.html]	
17	NetBSD	1.9	HPND like license IBM License BSD-4-Clause (University of California-Specific) BSD 3-clause "New" or "Revised" License BSD One Clause License	http://www.netbsd.org/	Copyright © 1998 Manuel Bouyer Copyright © 1996 Matt Thomas. Copyright 1997 Marshall Kirk McKusick. All Rights Reserved, Copyright © 1985, 1988, 1989, 1991, 1993, 1995 The Regents of the University of California Copyright © 1989, 1993 The Regents of the University of California Copyright © 1983, 1993 The Regents of the University of California Copyright 2000-2011 Green Hills Software Copyright (c) 1996 by Internet Software Consortium. Copyright (C) 1998 WIDE Project, Portions Copyright © 1995 by International Business Machines, Inc, Copyright (C) 1994, 1995, 1997 TooLs GmbH Copyright (C) 1994, 1995, 1997 Wolfgang Solfrank Copyright © 1995, 1999 Berkeley Software Design, Inc Portions Copyright © 1993 by Digital Equipment Corporation Copyright © 1992 Henry Spencer Copyright © 1997, 1998, 1999 The NetBSD Foundation, Inc Copyright © 1996 by Internet Software Consortium. Copyright (c) 1994 James A. Jegers(c) © UNIX System Laboratories, Inc.
18	NetBSD_BSD4	1.9	BSD 4-clause "Original" or "Old" License	http://www.netbsd.org/	Copyright 2000-2011, 2000-2013 Green Hills Software, Copyright © 1994, 1998 Christopher G. Demetriou, Copyright © 1982, 1986, 1990, 1993, 1994 The Regents of the University of California. All rights reserved. © UNIX System Laboratories, Inc.
19	The FreeType Project - freetype2	2.6.3	Freetype Project License	http://sourceforge.net/projects/freetype/	Copyright 1996-2016 by David Turner, Robert Wilhelm, and Werner Lemberg, Copyright 2007-2016 by Rahul Bhalaria, Copyright 2009-2016 by Oran Agra and Mickey Gabel, Copyright 2008-2016 by David Turner, Robert Wilhelm, Werner Lemberg, and suzuki toshiya. Copyright 2000 Computing Research Labs, New Mexico State University, Copyright 2001-2015 Francesco Zappa Nardelli, Copyright 2004-2016 by Masatake YAMATO and Redhat K.K, Copyright 2007-2016 by Derek Clegg and Michael Toftdal, Copyright 2010-2016 by Joel Klinghed, Copyright 2007-2013 Adobe Systems Incorporated, Copyright 2007-2014 Adobe Systems Incorporated, Copyright 2004-2016 by Albert Chin-A-Young, Copyright 2013-2016 by Google, Inc, Copyright 2002-2016 by Roberto Alameda, Copyright 2003 Huw D M Davies for Codeweavers, Copyright 2007 Dmitry Timoshkov for Codeweavers
20	Vivante Driver software	viv5.0.11p7.4.i3	MIT License	http://www.vivante.com/	Copyright 2012 - 2016 Vivante Corporation, Santa Clara, California Copyright © 2007 The Khronos Group Inc Copyright © 2014 - 2016 Vivante Corporation Copyright 2012 Vivante Corporation, Sunnyvale, California Copyright © 2011 Intel Corporation Copyright (C) 1999-2001 Brian Paul
21	zlib	1.2.8	zlib License	http://www.zlib.net/	Copyright (C) 1995-2007 Mark Adler Copyright (C) 1995-2005 Jean-loup Gailly Copyright (C) 1995-2012 Mark Adler Copyright (C) 2003 Chris Anderson Copyright (C) 1998 Brian Raiter

SI No.	Name of OSS Component	Version of OSS Component	Name and Version of License (License text can be found in Appendix below)	Home Page	More Information
22	RBTtree.cpp	3.4.2	Public Domain	https://www.eu.socionext.com/	(C) Socionext Embedded Software Austria GmbH (SESA)

2. APPENDIX - LICENSE TEXT

2.1 HPND Like license

Portions Copyright (c) 1993 by Digital Equipment Corporation.

Permission to use, copy, modify, and distribute this software for any purpose with or without fee is hereby granted, provided that the above copyright notice and this permission notice appear in all copies, and that the name of Digital Equipment Corporation not be used in advertising or publicity pertaining to distribution of the document or software without specific, written prior permission.

THE SOFTWARE IS PROVIDED "AS IS" AND DIGITAL EQUIPMENT CORP. DISCLAIMS ALL WARRANTIES WITH REGARD TO THIS SOFTWARE, INCLUDING ALL IMPLIED WARRANTIES OF MERCHANTABILITY AND FITNESS. IN NO EVENT SHALL DIGITAL EQUIPMENT CORPORATION BE LIABLE FOR ANY SPECIAL, DIRECT, INDIRECT, OR CONSEQUENTIAL DAMAGES OR ANY DAMAGES WHATSOEVER RESULTING FROM LOSS OF USE, DATA OR PROFITS, WHETHER IN AN ACTION OF CONTRACT, NEGLIGENCE OR OTHER TORTIOUS ACTION, ARISING OUT OF OR IN CONNECTION WITH THE USE OR PERFORMANCE OF THIS SOFTWARE.

2.2 BSD 2-clause "Simplified" License

BSD Two Clause License

Redistribution and use in source and binary forms, with or without modification, are permitted provided that the following conditions are met: Redistributions of source code must retain the above copyright notice, this list of conditions and the following disclaimer. Redistributions in binary form must reproduce the above copyright notice, this list of conditions and the following disclaimer in the documentation and/or other materials provided with the distribution.

THIS SOFTWARE IS PROVIDED BY THE AUTHOR "AS IS" AND ANY EXPRESS OR IMPLIED WARRANTIES, INCLUDING, BUT NOT LIMITED TO, THE IMPLIED WARRANTIES OF MERCHANTABILITY AND FITNESS FOR A PARTICULAR PURPOSE ARE DISCLAIMED. IN NO EVENT SHALL THE AUTHOR BE LIABLE FOR ANY DIRECT, INDIRECT, INCIDENTAL, SPECIAL, EXEMPLARY, OR CONSEQUENTIAL DAMAGES (INCLUDING, BUT NOT LIMITED TO, PROCUREMENT OF SUBSTITUTE GOODS OR SERVICES; LOSS OF USE, DATA, OR PROFITS; OR BUSINESS INTERRUPTION) HOWEVER CAUSED AND ON ANY THEORY OF LIABILITY, WHETHER IN CONTRACT, STRICT LIABILITY, OR TORT (INCLUDING NEGLIGENCE OR OTHERWISE) ARISING IN ANY WAY OUT OF THE USE OF THIS SOFTWARE, EVEN IF ADVISED OF THE POSSIBILITY OF SUCH DAMAGE.

2.3 IBM License

Portions Copyright (c) 1995 by International Business Machines, Inc.

International Business Machines, Inc. (hereinafter called IBM) grants permission under its copyrights to use, copy, modify, and distribute this Software with or without fee, provided that the above copyright notice and all paragraphs of this notice appear in all copies, and that the name of IBM not be used in connection with the marketing of any product incorporating the Software or modifications thereof, without specific, written prior permission.

To the extent it has a right to do so, IBM grants an immunity from suit under its patents, if any, for the use, sale or manufacture of products to the extent that such products are used for performing Domain Name System dynamic updates in TCP/IP networks by means of the Software. No immunity is granted for any product per se or for any other function of any product.

THE SOFTWARE IS PROVIDED "AS IS", AND IBM DISCLAIMS ALL WARRANTIES, INCLUDING ALL IMPLIED WARRANTIES OF MERCHANTABILITY AND FITNESS FOR A PARTICULAR PURPOSE. IN NO EVENT SHALL IBM BE LIABLE FOR ANY SPECIAL, DIRECT, INDIRECT, OR CONSEQUENTIAL DAMAGES OR ANY DAMAGES WHATSOEVER ARISING OUT OF OR IN CONNECTION WITH THE USE OR PERFORMANCE OF THIS SOFTWARE, EVEN IF IBM IS APPRISED OF THE POSSIBILITY OF SUCH DAMAGES.

2.4 BSD 3-clause "New" or "Revised" License

Copyright/Copyright holders – see List of Open Source Components

All rights reserved.

Redistribution and use in source and binary forms, with or without modification, are permitted provided that the following conditions are met:

Redistributions of source code must retain the above copyright notice, this list of conditions and the following disclaimer. Redistributions in binary form must reproduce the above copyright notice, this list of conditions and the following disclaimer in the documentation and/or other materials provided with the distribution. Neither the name of the [ORGANIZATION] nor the names of its contributors may be used to endorse or promote products derived from this software without specific prior written permission.

THIS SOFTWARE IS PROVIDED BY THE COPYRIGHT HOLDERS AND CONTRIBUTORS "AS IS" AND ANY EXPRESS OR IMPLIED WARRANTIES, INCLUDING, BUT NOT LIMITED TO, THE IMPLIED WARRANTIES OF MERCHANTABILITY AND FITNESS FOR A PARTICULAR PURPOSE ARE DISCLAIMED. IN NO EVENT SHALL THE COPYRIGHT OWNER OR CONTRIBUTORS BE LIABLE FOR ANY DIRECT, INDIRECT, INCIDENTAL, SPECIAL, EXEMPLARY, OR CONSEQUENTIAL DAMAGES (INCLUDING, BUT NOT LIMITED TO, PROCUREMENT OF SUBSTITUTE GOODS OR SERVICES; LOSS OF USE, DATA, OR PROFITS; OR BUSINESS INTERRUPTION) HOWEVER CAUSED AND ON ANY THEORY OF LIABILITY, WHETHER IN CONTRACT, STRICT LIABILITY, OR TORT (INCLUDING NEGLIGENCE OR OTHERWISE) ARISING IN ANY WAY OUT OF THE USE OF THIS SOFTWARE, EVEN IF ADVISED OF THE POSSIBILITY OF SUCH DAMAGE.

2.5 BSD 4-clause "Original" or "Old" License

Copyright/Copyright holders – see List of Open Source Components

All rights reserved.

Redistribution and use in source and binary forms, with or without modification, are permitted provided that the following conditions are met:

1. Redistributions of source code must retain the above copyright notice, this list of conditions and the following disclaimer.
2. Redistributions in binary form must reproduce the above copyright notice, this list of conditions and the following disclaimer in the documentation and/or other materials provided with the distribution.
3. All advertising materials mentioning features or use of this software must display the following acknowledgement: This product includes software developed by the organization.
4. Neither the name of the organization nor the names of its contributors may be used to endorse or promote products derived from this software without specific prior written permission.

THIS SOFTWARE IS PROVIDED BY COPYRIGHT HOLDER "AS IS" AND ANY EXPRESS OR IMPLIED WARRANTIES, INCLUDING, BUT NOT LIMITED TO, THE IMPLIED WARRANTIES OF MERCHANTABILITY AND FITNESS FOR A

PARTICULAR PURPOSE ARE DISCLAIMED. IN NO EVENT SHALL {{COPYRIGHT HOLDER}} BE LIABLE FOR ANY DIRECT, INDIRECT, INCIDENTAL, SPECIAL, EXEMPLARY, OR CONSEQUENTIAL DAMAGES (INCLUDING, BUT NOT LIMITED TO, PROCUREMENT OF SUBSTITUTE GOODS OR SERVICES; LOSS OF USE, DATA, OR PROFITS; OR BUSINESS INTERRUPTION) HOWEVER CAUSED AND ON ANY THEORY OF LIABILITY, WHETHER IN CONTRACT, STRICT LIABILITY, OR TORT (INCLUDING NEGLIGENCE OR OTHERWISE) ARISING IN ANY WAY OUT OF THE USE OF THIS SOFTWARE, EVEN IF ADVISED OF THE POSSIBILITY OF SUCH DAMAGE.

2.6 BSD-4-Clause (University of California-Specific)

BSD-4-Clause (University of California-Specific)

Copyright/Copyright holders – see List of Open Source Components

Redistribution and use in source and binary forms, with or without modification, are permitted provided that the following conditions are met:

1. Redistributions of source code must retain the above copyright notice, this list of conditions and the following disclaimer.
2. Redistributions in binary form must reproduce the above copyright notice, this list of conditions and the following disclaimer in the documentation and/or other materials provided with the distribution.
3. All advertising materials mentioning features or use of this software must display the following acknowledgement: This product includes software developed by the University of California, Berkeley and its contributors.
4. Neither the name of the University nor the names of its contributors may be used to endorse or promote products derived from this software without specific prior written permission.

THIS SOFTWARE IS PROVIDED BY THE REGENTS AND CONTRIBUTORS "AS IS" AND ANY EXPRESS OR IMPLIED WARRANTIES, INCLUDING, BUT NOT LIMITED TO, THE IMPLIED WARRANTIES OF MERCHANTABILITY AND FITNESS FOR A PARTICULAR PURPOSE ARE DISCLAIMED. IN NO EVENT SHALL THE REGENTS OR CONTRIBUTORS BE LIABLE FOR ANY DIRECT, INDIRECT, INCIDENTAL, SPECIAL, EXEMPLARY, OR CONSEQUENTIAL DAMAGES (INCLUDING, BUT NOT LIMITED TO, PROCUREMENT OF SUBSTITUTE GOODS OR SERVICES; LOSS OF USE, DATA, OR PROFITS; OR BUSINESS INTERRUPTION) HOWEVER CAUSED AND ON ANY THEORY OF LIABILITY, WHETHER IN CONTRACT, STRICT LIABILITY, OR TORT (INCLUDING NEGLIGENCE OR OTHERWISE) ARISING IN ANY WAY OUT OF THE USE OF THIS SOFTWARE, EVEN IF ADVISED OF THE POSSIBILITY OF SUCH DAMAGE.

2.7 Freetype Project License

The FreeType Project LICENSE

2006-Jan-27

Copyright 1996-2002, 2006 by David Turner, Robert Wilhelm, and Werner Lemberg

Introduction

The FreeType Project is distributed in several archive packages; some of them may contain, in addition to the FreeType font engine, various tools and contributions which rely on, or relate to, the FreeType Project. This license applies to all files found in such packages, and which do not fall under their own explicit license. The license affects thus the FreeType font engine, the test programs, documentation and makefiles, at the very least. This license was inspired by the BSD, Artistic, and IJG (Independent JPEG Group) licenses, which all encourage inclusion and use of free software in commercial and freeware products alike. As a consequence, its main points are that:

We don't promise that this software works. However, we will be interested in any kind of bug reports. ('as is' distribution)

You can use this software for whatever you want, in parts or full form, without having to pay us. ('royalty-free' usage)

The content of this manual represents the status of the user manual at the time of printing and may not be completely valid in future instances. For more information, refer to the first page for the complete disclaimer note.

You may not pretend that you wrote this software. If you use it, or only parts of it, in a program, you must acknowledge somewhere in your documentation that you have used the FreeType code. (‘credits’)

We specifically permit and encourage the inclusion of this software, with or without modifications, in commercial products. We disclaim all warranties covering The FreeType Project and assume no liability related to The FreeType Project. Finally, many people asked us for a preferred form for a credit/disclaimer to use in compliance with this license. We thus encourage you to use the following text: "Portions of this software are copyright © 1996-2002, 2006 The FreeType Project (www.freetype.org). All rights reserved."

Definitions

Throughout this license, the terms ‘package’, ‘FreeType Project’, and ‘FreeType archive’ refer to the set of files originally distributed by the authors (David Turner, Robert Wilhelm, and Werner Lemberg) as the ‘FreeType Project’, be they named as alpha, beta or final release. ‘You’ refers to the licensee, or person using the project, where ‘using’ is a generic term including compiling the project’s source code as well as linking it to form a ‘program’ or ‘executable’. This program is referred to as ‘a program using the FreeType engine’. This license applies to all files distributed in the original FreeType Project, including all source code, binaries and documentation, unless otherwise stated in the file in its original, unmodified form as distributed in the original archive. If you are unsure whether or not a particular file is covered by this license, you must contact us to verify this.

No Warranty

THE FREETYPE PROJECT IS PROVIDED ‘AS IS’ WITHOUT WARRANTY OF ANY KIND, EITHER EXPRESS OR IMPLIED, INCLUDING, BUT NOT LIMITED TO, WARRANTIES OF MERCHANTABILITY AND FITNESS FOR A PARTICULAR PURPOSE. IN NO EVENT WILL ANY OF THE AUTHORS OR COPYRIGHT HOLDERS BE LIABLE FOR ANY DAMAGES CAUSED BY THE USE OR THE INABILITY TO USE, OF THE FREETYPE PROJECT. Redistribution

Redistribution

This license grants a worldwide, royalty-free, perpetual and irrevocable right and license to use, execute, perform, compile, display, copy, create derivative works of, distribute and sublicense the FreeType Project (in both source and object code forms) and derivative works thereof for any purpose; and to authorize others to exercise some or all of the rights granted herein, subject to the following conditions:

Redistribution of source code must retain this license file (‘FTL.TXT’) unaltered; any additions, deletions or changes to the original files must be clearly indicated in accompanying documentation. The copyright notices of the unaltered, original files must be preserved in all copies of source files. Redistribution in binary form must provide a disclaimer that states that the software is based in part of the work of the FreeType Team, in the distribution documentation. We also encourage you to put an URL to the FreeType web page in your documentation, though this isn’t mandatory. These conditions apply to any software derived from or based on the FreeType Project, not just the unmodified files. If you use our work, you must acknowledge us. However, no fee need be paid to us.

Advertising

Neither the FreeType authors and contributors nor you shall use the name of the other for commercial, advertising, or promotional purposes without specific prior written permission. We suggest, but do not require, that you use one or more of the following phrases to refer to this software in your documentation or advertising materials: ‘FreeType Project’, ‘FreeType Engine’, ‘FreeType library’, or ‘FreeType Distribution’. As you have not signed this license, you are not required to accept it. However, as the FreeType Project is copyrighted material, only this license, or another one contracted with the authors, grants you the right to use, distribute, and modify it. Therefore, by using, distributing, or modifying the FreeType Project, you indicate that you understand and accept all the terms of this license.

Contacts

There are two mailing lists related to FreeType:

freetype@nongnu.org

Discusses general use and applications of FreeType, as well as future and wanted additions to the library and distribution. If you are looking for support, start in this list if you haven't found anything to help you in the documentation.

devel@nongnu.org

Discusses bugs, as well as engine internals, design issues, specific licenses, porting, etc.

Our home page can be found at: <http://www.freetype.org>

2.8 Independent JPEG Group License

The Independent JPEG Group's JPEG software README for release 6b of 27-Mar-1998

This distribution contains the sixth public release of the Independent JPEG Group's free JPEG software. You are welcome to re-distribute this software and to use it for any purpose, subject to the conditions under LEGAL ISSUES, below. Serious users of this software (particularly those incorporating it into larger programs) should contact IJG at jpeg-info@uunet.uu.net to be added to our electronic mailing list. Mailing list members are notified of updates and have a chance to participate in technical discussions, etc. This software is the work of Tom Lane, Philip Gladstone, Jim Boucher, Lee Crocker, Julian Minguillon, Luis Ortiz, George Phillips, Davide Rossi, Guido Vollbeding, Ge' Weijers, and other members of the Independent JPEG Group. IJG is not affiliated with the official ISO JPEG standards committee.

LEGAL ISSUES

In plain English:

We don't promise that this software works. (But if you find any bugs, please let us know!) You can use this software for whatever you want. You don't have to pay us. You may not pretend that you wrote this software. If you use it in a program, you must acknowledge somewhere in your documentation that you've used the IJG code.

In legalese:

The authors make NO WARRANTY or representation, either express or implied, with respect to this software, its quality, accuracy, merchantability, or fitness for a particular purpose. This software is provided "AS IS", and you, its user, assume the entire risk as to its quality and accuracy. This software is copyright (C) 1991-1998, Thomas G. Lane. All Rights Reserved except as specified below.

Permission is hereby granted to use, copy, modify, and distribute this software (or portions thereof) for any purpose, without fee, subject to these conditions:

1. If any part of the source code for this software is distributed, then this README file must be included, with this copyright and no-warranty notice unaltered; and any additions, deletions, or changes to the original files must be clearly indicated in accompanying documentation.
2. If only executable code is distributed, then the accompanying documentation must state that "this software is based in part on the work of the Independent JPEG Group".
3. Permission for use of this software is granted only if the user accepts full responsibility for any undesirable consequences; the authors accept NO LIABILITY for damages of any kind.

These conditions apply to any software derived from or based on the IJG code, not just to the unmodified library. If you use our work, you ought to acknowledge us.

Permission is NOT granted for the use of any IJG author's name or company name in advertising or publicity relating to this software or products derived from it. This software may be referred to only as "the Independent JPEG Group's software".

We specifically permit and encourage the use of this software as the basis of commercial products, provided that all warranty or liability claims are assumed by the product vendor. ansi2knr.c is included in this distribution by permission of L. Peter Deutsch, sole proprietor of its copyright holder, Aladdin Enterprises of Menlo Park, CA. ansi2knr.c is NOT covered by the above copyright and conditions, but instead by the usual distribution terms of the Free Software Foundation; principally, that you must include source code if you redistribute it. (See the file ansi2knr.c for full details.)

However, since ansi2knr.c is not needed as part of any program generated from the IJG code, this does not limit you more than the foregoing paragraphs do. The Unix configuration script "configure" was produced with GNU Autoconf. It is copyright by the Free Software Foundation but is freely distributable. The same holds for its supporting scripts (config.guess, config.sub, ltconfig, ltmain.sh). Another support script, install-sh, is copyright by M.I.T. but is also freely distributable.

It appears that the arithmetic coding option of the JPEG spec is covered by patents owned by IBM, AT&T, and Mitsubishi. Hence arithmetic coding cannot legally be used without obtaining one or more licenses. For this reason, support for arithmetic coding has been removed from the free JPEG software. (Since arithmetic coding provides only a marginal gain over the unpatented Huffman mode, it is unlikely that very many implementations will support it.) So far as we are aware, there are no patent restrictions on the remaining code.

The IJG distribution formerly included code to read and write GIF files. To avoid entanglement with the Unisys LZW patent, GIF reading support has been removed altogether, and the GIF writer has been simplified to produce "uncompressed GIFs". This technique does not use the LZW algorithm; the resulting GIF files are larger than usual, but are readable by all standard GIF decoders. We are required to state that:

"The Graphics Interchange Format(c) is the Copyright property of CompuServe Incorporated. GIF(sm) is a Service Mark property of CompuServe Incorporated."

2.9 Internet Software Consortium-IBM License

Copyright (c) 1996 by Internet Software Consortium.

Permission to use, copy, modify, and distribute this software for any purpose with or without fee is hereby granted, provided that the above copyright notice and this permission notice appear in all copies.

THE SOFTWARE IS PROVIDED "AS IS" AND INTERNET SOFTWARE CONSORTIUM DISCLAIMS ALL WARRANTIES WITH REGARD TO THIS SOFTWARE INCLUDING ALL IMPLIED WARRANTIES OF MERCHANTABILITY AND FITNESS. IN NO EVENT SHALL INTERNET SOFTWARE CONSORTIUM BE LIABLE FOR ANY SPECIAL, DIRECT, INDIRECT, OR CONSEQUENTIAL DAMAGES OR ANY DAMAGES WHATSOEVER RESULTING FROM LOSS OF USE, DATA OR PROFITS, WHETHER IN AN ACTION OF CONTRACT, NEGLIGENCE OR OTHER TORTIOUS ACTION, ARISING OUT OF OR IN CONNECTION WITH THE USE OR PERFORMANCE OF THIS SOFTWARE.

Portions Copyright (c) 1995 by International Business Machines, Inc.

International Business Machines, Inc. (hereinafter called IBM) grants permission under its copyrights to use, copy, modify, and distribute this Software with or without fee, provided that the above copyright notice and all paragraphs of this notice appear in all copies, and that the name of IBM not be used in connection with the marketing of any product incorporating the Software or modifications thereof, without specific, written prior permission.

To the extent it has a right to do so, IBM grants an immunity from suit under its patents, if any, for the use, sale or manufacture of products to the extent that such products are used for performing Domain Name System dynamic updates in TCP/IP networks by means of the Software. No immunity is granted for any product per se or for any other function of any product.

THE SOFTWARE IS PROVIDED "AS IS", AND IBM DISCLAIMS ALL WARRANTIES, INCLUDING ALL IMPLIED WARRANTIES OF MERCHANTABILITY AND FITNESS FOR A PARTICULAR PURPOSE. IN NO EVENT SHALL IBM BE LIABLE FOR ANY SPECIAL, DIRECT, INDIRECT, OR CONSEQUENTIAL DAMAGES OR ANY DAMAGES WHATSOEVER

The content of this manual represents the status of the user manual at the time of printing and may not be completely valid in future instances. For more information, refer to the first page for the complete disclaimer note.

ARISING OUT OF OR IN CONNECTION WITH THE USE OR PERFORMANCE OF THIS SOFTWARE, EVEN IF IBM IS APPRISED OF THE POSSIBILITY OF SUCH DAMAGES.

2.10 Khronos License

Copyright (c) 2013 The Khronos Group Inc.

** ** Permission is hereby granted, free of charge, to any person obtaining a ** copy of this software and/or associated documentation files (the ** "Materials"), to deal in the Materials without restriction, including ** without limitation the rights to use, copy, modify, merge, publish, ** distribute, sublicense, and/or sell copies of the Materials, and to ** permit persons to whom the Materials are furnished to do so, subject to ** the following conditions: ** ** The above copyright notice and this permission notice shall be included ** in all copies or substantial portions of the Materials. **

** THE MATERIALS ARE PROVIDED "AS IS", WITHOUT WARRANTY OF ANY KIND, ** EXPRESS OR IMPLIED, INCLUDING BUT NOT LIMITED TO THE WARRANTIES OF ** MERCHANTABILITY, FITNESS FOR A PARTICULAR PURPOSE AND NONINFRINGEMENT. ** IN NO EVENT SHALL THE AUTHORS OR COPYRIGHT HOLDERS BE LIABLE FOR ANY ** CLAIM, DAMAGES OR OTHER LIABILITY, WHETHER IN AN ACTION OF CONTRACT, ** TORT OR OTHERWISE, ARISING FROM, OUT OF OR IN CONNECTION WITH THE ** MATERIALS OR THE USE OR OTHER DEALINGS IN THE MATERIALS.

2.11 License of Stephan Brumme/ Zlib style License

This software is provided 'as-is', without any express or implied warranty. In no event will the author be held liable for any damages arising from the use of this software. Permission is granted to anyone to use this software for any purpose, including commercial applications, and to alter it and redistribute it freely, subject to the following restrictions: The origin of this software must not be misrepresented; you must not claim that you wrote the original software. If you use this software in a product, an acknowledgment in the product documentation would be appreciated but is not required. Altered source versions must be plainly marked as such, and must not be misrepresented as being the original software.

2.12 MIT License

The MIT License

Copyright/Copyright holders – see List of Open Source Components

Permission is hereby granted, free of charge, to any person obtaining a copy of this software and associated documentation files (the "Software"), to deal in the Software without restriction, including without limitation the rights to use, copy, modify, merge, publish, distribute, sublicense, and/or sell copies of the Software, and to permit persons to whom the Software is furnished to do so, subject to the following conditions:

The above copyright notice and this permission notice shall be included in all copies or substantial portions of the Software.

THE SOFTWARE IS PROVIDED "AS IS", WITHOUT WARRANTY OF ANY KIND, EXPRESS OR IMPLIED, INCLUDING BUT NOT LIMITED TO THE WARRANTIES OF MERCHANTABILITY, FITNESS FOR A PARTICULAR PURPOSE AND NONINFRINGEMENT. IN NO EVENT SHALL THE AUTHORS OR COPYRIGHT HOLDERS BE LIABLE FOR ANY CLAIM, DAMAGES OR OTHER LIABILITY, WHETHER IN AN ACTION OF CONTRACT, TORT OR OTHERWISE, ARISING FROM, OUT OF OR IN CONNECTION WITH THE SOFTWARE OR THE USE OR OTHER DEALINGS IN THE SOFTWARE.

2.13 Open Group License

Copyright 1996, 1998 The Open Group.

Permission to use, copy, modify, distribute, and sell this software and its documentation for any purpose is hereby granted without fee, provided that the above copyright notice appear in all copies and that both that copyright notice and this permission notice appear in supporting documentation. The above copyright notice and this permission notice shall be included in all copies or substantial portions of the Software.

The content of this manual represents the status of the user manual at the time of printing and may not be completely valid in future instances. For more information, refer to the first page for the complete disclaimer note.

THE SOFTWARE IS PROVIDED "AS IS", WITHOUT WARRANTY OF ANY KIND, EXPRESS OR IMPLIED, INCLUDING BUT NOT LIMITED TO THE WARRANTIES OF MERCHANTABILITY, FITNESS FOR A PARTICULAR PURPOSE AND NONINFRINGEMENT. IN NO EVENT SHALL THE OPEN GROUP BE LIABLE FOR ANY CLAIM, DAMAGES OR OTHER LIABILITY, WHETHER IN AN ACTION OF CONTRACT, TORT OR OTHERWISE, ARISING FROM, OUT OF OR IN CONNECTION WITH THE SOFTWARE OR THE USE OR OTHER DEALINGS IN THE SOFTWARE.

Except as contained in this notice, the name of The Open Group shall not be used in advertising or otherwise to promote the sale, use or other dealings in this Software without prior written authorization from The Open Group.

2.14 Public Domain

Public domain code is not subject to any license.

2.15 BSD One Clause License

BSD One Clause License

Copyright/Copyright holders – see List of Open Source Components

All rights reserved.

Redistribution and use in source and binary forms, with or without modification, are permitted provided that the following conditions are met:

* Redistributions of source code must retain the above copyright notice, this list of conditions and the following disclaimer.

THIS SOFTWARE IS PROVIDED BY THE COPYRIGHT HOLDERS AND CONTRIBUTORS "AS IS" AND ANY EXPRESS OR IMPLIED WARRANTIES, INCLUDING, BUT NOT LIMITED TO, THE IMPLIED WARRANTIES OF MERCHANTABILITY AND FITNESS FOR A PARTICULAR PURPOSE ARE DISCLAIMED. IN NO EVENT SHALL THE COPYRIGHT OWNER OR CONTRIBUTORS BE LIABLE FOR ANY DIRECT, INDIRECT, INCIDENTAL, SPECIAL, EXEMPLARY, OR CONSEQUENTIAL DAMAGES (INCLUDING, BUT NOT LIMITED TO, PROCUREMENT OF SUBSTITUTE GOODS OR SERVICES; LOSS OF USE, DATA, OR PROFITS; OR BUSINESS INTERRUPTION) HOWEVER CAUSED AND ON ANY THEORY OF LIABILITY, WHETHER IN CONTRACT, STRICT LIABILITY, OR TORT (INCLUDING NEGLIGENCE OR OTHERWISE) ARISING IN ANY WAY OUT OF THE USE OF THIS SOFTWARE, EVEN IF ADVISED OF THE POSSIBILITY OF SUCH DAMAGE.

2.16 ISC License

ISC License (ISCL)

Copyright/Copyright holders – see List of Open Source Components

Permission to use, copy, modify, and/or distribute this software for any purpose with or without fee is hereby granted, provided that the above copyright notice and this permission notice appear in all copies.

THE SOFTWARE IS PROVIDED "AS IS" AND THE AUTHOR DISCLAIMS ALL WARRANTIES WITH REGARD TO THIS SOFTWARE INCLUDING ALL IMPLIED WARRANTIES OF MERCHANTABILITY AND FITNESS. IN NO EVENT SHALL THE AUTHOR BE LIABLE FOR ANY SPECIAL, DIRECT, INDIRECT, OR CONSEQUENTIAL DAMAGES OR ANY DAMAGES WHATSOEVER RESULTING FROM LOSS OF USE, DATA OR PROFITS, WHETHER IN AN ACTION OF CONTRACT, NEGLIGENCE OR OTHER TORTIOUS ACTION, ARISING OUT OF OR IN CONNECTION WITH THE USE OR PERFORMANCE OF THIS SOFTWARE.

2.17 SGI Free Software License B v2.0

ISC License (ISCL)

Copyright/Copyright holders – see List of Open Source Components

Permission is hereby granted, free of charge, to any person obtaining a copy of this software and associated documentation files (the "Software"), to deal in the Software without restriction, including without limitation the rights to use, copy, modify, merge, publish, distribute, sublicense, and/or sell copies of the Software, and to permit persons to whom the Software is furnished to do so, subject to the following conditions:

The above copyright notice including the dates of first publication and either this permission notice or a reference to <http://oss.sgi.com/projects/FreeB/> shall be included in all copies or substantial portions of the Software.

THE SOFTWARE IS PROVIDED "AS IS" AND THE AUTHOR DISCLAIMS ALL WARRANTIES WITH REGARD TO THIS SOFTWARE INCLUDING ALL IMPLIED WARRANTIES OF MERCHANTABILITY AND FITNESS. IN NO EVENT SHALL THE AUTHOR BE LIABLE FOR ANY SPECIAL, DIRECT, INDIRECT, OR CONSEQUENTIAL DAMAGES OR ANY DAMAGES WHATSOEVER RESULTING FROM LOSS OF USE, DATA OR PROFITS, WHETHER IN AN ACTION OF CONTRACT, NEGLIGENCE OR OTHER TORTIOUS ACTION, ARISING OUT OF OR IN CONNECTION WITH THE USE OR PERFORMANCE OF THIS SOFTWARE.

Except as contained in this notice, the name of Silicon Graphics, Inc. shall not be used in advertising or otherwise to promote the sale, use or other dealings in this Software without prior written authorization from Silicon Graphics, Inc.

2.18 Unicode Terms of Use

For the general privacy policy governing access to this site, see the Unicode Privacy Policy. For trademark usage, see the Unicode® Consortium Name and Trademark Usage Policy.

A. Unicode Copyright.

1. Copyright © 1991-2014 Unicode, Inc. All rights reserved.
2. Certain documents and files on this website contain a legend indicating that "Modification is permitted." Any person is hereby authorized, without fee, to modify such documents and files to create derivative works conforming to the Unicode® Standard, subject to Terms and Conditions herein.
3. Any person is hereby authorized, without fee, to view, use, reproduce, and distribute all documents and files solely for informational purposes in the creation of products supporting the Unicode Standard, subject to the Terms and Conditions herein.
4. Further specifications of rights and restrictions pertaining to the use of the particular set of data files known as the "Unicode Character Database" can be found in Exhibit 1.
5. Each version of the Unicode Standard has further specifications of rights and restrictions of use. For the book editions (Unicode 5.0 and earlier), these are found on the back of the title page. The online code charts carry specific restrictions. All other files, including online documentation of the core specification for Unicode 6.0 and later, are covered under these general Terms of Use.
6. No license is granted to "mirror" the Unicode website where a fee is charged for access to the "mirror" site.
7. Modification is not permitted with respect to this document. All copies of this document must be verbatim.

B. Restricted Rights Legend.

Any technical data or software which is licensed to the United States of America, its agencies and/or instrumentalities under this Agreement is commercial technical data or commercial computer software developed exclusively at private expense as defined in FAR 2.101, or DFARS 252.227-7014 (June 1995), as applicable. For technical data, use, duplication, or disclosure by the Government is subject to restrictions as set forth in DFARS 202.227-7015 Technical Data, Commercial and Items (Nov 1995) and this Agreement. For Software, in accordance with FAR 12-212 or DFARS 227-7202, as applicable, use, duplication or disclosure by the Government is subject to the restrictions set forth in this Agreement.

C. Warranties and Disclaimers.

1. This publication and/or website may include technical or typographical errors or other inaccuracies . Changes are periodically added to the information herein; these changes will be incorporated in new editions of the publication and/or website. Unicode may make improvements and/or changes in the product(s) and/or program(s) described in this publication and/or website at any time.
2. If this file has been purchased on magnetic or optical media from Unicode, Inc. the sole and exclusive remedy for any claim will be exchange of the defective media within ninety (90) days of original purchase.
3. EXCEPT AS PROVIDED IN SECTION C.2, THIS PUBLICATION AND/OR SOFTWARE IS PROVIDED "AS IS" WITHOUT WARRANTY OF ANY KIND EITHER EXPRESS, IMPLIED, OR STATUTORY, INCLUDING, BUT NOT LIMITED TO, ANY WARRANTIES OF MERCHANTABILITY, FITNESS FOR A PARTICULAR PURPOSE, OR NON-INFRINGEMENT. UNICODE AND ITS LICENSORS ASSUME NO RESPONSIBILITY FOR ERRORS OR OMISSIONS IN THIS PUBLICATION AND/OR SOFTWARE OR OTHER DOCUMENTS WHICH ARE REFERENCED BY OR LINKED TO THIS PUBLICATION OR THE UNICODE WEBSITE.

D. Waiver of Damages.

In no event shall Unicode or its licensors be liable for any special, incidental, indirect or consequential damages of any kind, or any damages whatsoever, whether or not Unicode was advised of the possibility of the damage, including, without limitation, those resulting from the following: loss of use, data or profits, in connection with the use, modification or distribution of this information or its derivatives.

E. Trademarks & Logos.

1. The Unicode Word Mark and the Unicode Logo are trademarks of Unicode, Inc. "The Unicode Consortium" and "Unicode, Inc." are trade names of Unicode, Inc. Use of the information and materials found on this website indicates your acknowledgement of Unicode, Inc.'s exclusive worldwide rights in the Unicode Word Mark, the Unicode Logo, and the Unicode trade names.
2. The Unicode Consortium Name and Trademark Usage Policy ("Trademark Policy") are incorporated herein by reference and you agree to abide by the provisions of the Trademark Policy, which may be changed from time to time in the sole discretion of Unicode, Inc.
3. All third party trademarks referenced herein are the property of their respective owners.

F. Miscellaneous.

1. Jurisdiction and Venue. This server is operated from a location in the State of California, United States of America. Unicode makes no representation that the materials are appropriate for use in other locations. If you access this server from other locations, you are responsible for compliance with local laws. This Agreement, all use of this site and any claims and damages resulting from use of this site are governed solely by the laws of the State of California without regard to any principles which would apply the laws of a different jurisdiction. The user agrees that any disputes regarding this site shall be resolved solely in the courts located in Santa Clara County, California. The user agrees said courts have personal jurisdiction and agree to waive any right to transfer the dispute to any other forum.
2. Modification by Unicode. Unicode shall have the right to modify this Agreement at any time by posting it to this site. The user may not assign any part of this Agreement without Unicode's prior written consent.
3. Taxes. The user agrees to pay any taxes arising from access to this website or use of the information herein, except for those based on Unicode's net income.
4. Severability. If any provision of this Agreement is declared invalid or unenforceable, the remaining provisions of this Agreement shall remain in effect.
5. Entire Agreement. This Agreement constitutes the entire agreement between the parties.

2.19 libpng License

This copy of the libpng notices is provided for your convenience. In case of any discrepancy between this copy and the notices in the file png.h that is included in the libpng distribution, the latter shall prevail.

COPYRIGHT NOTICE, DISCLAIMER, and LICENSE:

The above copyright notice and this permission notice shall be included in all copies or substantial portions of the Software.

If you modify libpng you may insert additional notices immediately following this sentence. libpng versions 1.0.7, July 1, 2000, through 1.0.13, April 15, 2002, are Copyright (c) 2000-2002 Glenn Randers-Pehrson and are distributed according to the same disclaimer and license as libpng-1.0.6 with the following individuals added to the list of Contributing Authors:

Simon-Pierre Cadieux, Eric S. Raymond, Gilles Vollant

and with the following additions to the disclaimer:

There is no warranty against interference with your enjoyment of the library or against infringement. There is no warranty that our efforts or the library will fulfill any of your particular purposes or needs. This library is provided with all faults, and the entire risk of satisfactory quality, performance, accuracy, and effort is with the user.

libpng versions 0.97, January 1998, through 1.0.6, March 20, 2000, are Copyright (c) 1998, 1999 Glenn Randers-Pehrson, and are distributed according to the same disclaimer and license as libpng-0.96, with the following individuals added to the list of Contributing Authors:

Tom Lane, Glenn Randers-Pehrson, Willem van Schaik.

libpng versions 0.89, June 1996, through 0.96, May 1997, are Copyright (c) 1996, 1997 Andreas Dilger Distributed according to the same disclaimer and license as libpng-0.88, with the following individuals added to the list of Contributing Authors:

John Bowler, Kevin Bracey, Sam Bushe, Magnus Holmgren, Greg Roelofs, Tom Tanner.

libpng versions 0.5, May 1995, through 0.88, January 1996, are Copyright (c) 1995, 1996 Guy Eric Schalnat, Group 42, Inc. For the purposes of this copyright and license, "Contributing Authors" is defined as the following set of individuals:

Andreas Dilger, Dave Martindale, Guy Eric Schalnat, Paul Schmidt, Tim Wegner.

The PNG Reference Library is supplied "AS IS". The Contributing Authors and Group 42, Inc. disclaim all warranties, expressed or implied, including, without limitation, the warranties of merchantability and of fitness for any purpose. The Contributing Authors and Group 42, Inc. assume no liability for direct, indirect, incidental, special, exemplary, or consequential damages, which may result from the use of the PNG Reference Library, even if advised of the possibility of such damage. Permission is hereby granted to use, copy, modify, and distribute this source code, or portions hereof, for any purpose, without fee, subject to the following restrictions:

1. The origin of this source code must not be misrepresented.
2. Altered versions must be plainly marked as such and must not be misrepresented as being the original source.
3. This Copyright notice may not be removed or altered from any source or altered source distribution.

The Contributing Authors and Group 42, Inc. specifically permit, without fee, and encourage the use of this source code as a component to supporting the PNG file format in commercial products. If you use this source code in a product, acknowledgment is not required but would be appreciated. A "png_get_copyright" function is available, for convenient use in "about" boxes and the like:

```
printf("%s",png_get_copyright(NULL));
```

Also, the PNG logo (in PNG format, of course) is supplied in the files "pngbar.png" and "pngbar.jpg (88x31) and "pngnow.png" (98x31).

Libpng is OSI Certified Open Source Software. OSI Certified Open Source is a certification mark of the Open Source Initiative.

Glenn Randers-Pehrson

randeg@alum.rpi.edu

April 15, 2002

2.20 zlib License

Copyright/Copyright holders – see List of Open Source Components

This software is provided 'as-is', without any express or implied warranty. In no event will the authors be held liable for any damages arising from the use of this software.

Permission is granted to anyone to use this software for any purpose, including commercial applications, and to alter it and re-distribute it freely, subject to the following restrictions:

1. The origin of this software must not be misrepresented; you must not claim that you wrote the original software. If you use this software in a product, an acknowledgment in the product documentation would be appreciated but is not required.
2. Altered source versions must be plainly marked as such, and must not be misrepresented as being the original software.
3. This notice may not be removed or altered from any source distribution.

4.1.6. Messages in the driver display

The driver display can show messages to inform or assist the driver in the event of different events.

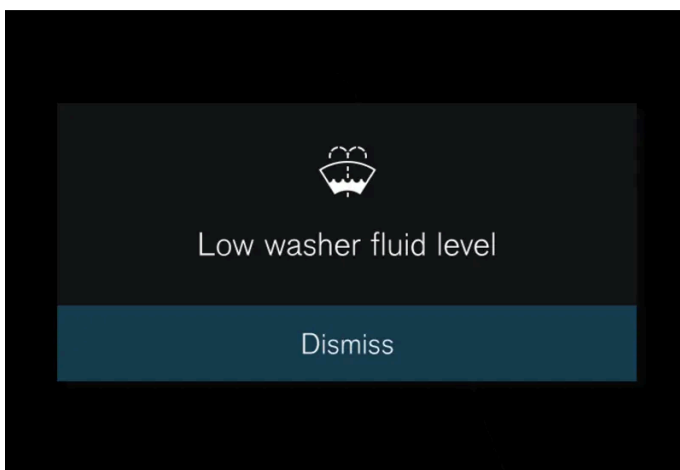

Messages are shown in the middle of the driver display. The composition may vary and is shown together with graphics, symbols or buttons for acknowledging the message or accepting a request, for example.

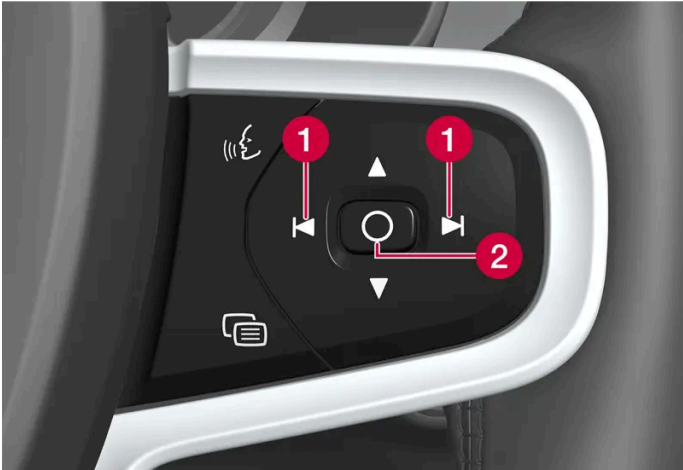

- 1 Left/right
- 2 Confirm

The message disappears from the driver display when it has been acknowledged/acted on. Certain selected messages can be seen in the notification view of the centre display.

Service messages

Shown below is a selection of service messages and their meanings.

Message	Specification
Do not drive ^[1]	Stop and contact a workshop. Serious risk of injury.
Book time for regular maintenance	Time for regular service - contact a workshop ^[1] . Shown before the next service date.
Time for regular maintenance	Time for regular service - contact a workshop ^[1] . Shown at the next service date.
Regular maintenance overdue	Time for regular service - contact a workshop ^[1] . Shown when the service date has passed.

^[1] Part of message, shown together with information on where the problem has arisen.

4.2. Centre display

4.2.1. Settings

4.2.1.1. Resetting user data

User data and system settings are restored via the centre display.

Settings that can be restored to their defaults:

- app settings
- network settings (only by admin)
- factory reset (only by admin) – profiles, user data, connected keys and personal settings are deleted.

In the event of a change of ownership, user data and system settings must be restored via factory reset.

Restoring settings via the centre display

- 1 Press .
- 2 Continue to **System, Reset option** to restore the desired setting.

The user profile must have administrative privileges in order to be able to reset network settings or reset the car to factory settings, which are obtained by clicking the **Become an admin** option in **Profile settings**. The owner profile always has administrator privileges.

A factory reset also requires all keys for the car to be inside the car.

4.2.1.2. Changing system units

Unit settings are made via the centre display.

- 1 Press .
- 2 Continue to **System, Units**.
- 3 Select the standard units desired for distance, speed and temperature, for example.
 - > The units in the driver display and centre display are changed.

4.2.1.3. Changing system language

Language settings are made via the centre display.

 **Note**

Changing the language in the centre display may mean that some owner's information is not compliant with national or local laws and regulations. Do not switch to a language that is difficult to understand as this may make it difficult to find your way back through the screen structure.

- 1 Press .
- 2 Continue to **System, Languages and input**.
- 3 Select the required language.
➤ The language in the driver display and centre display are changed.

Changing the system language also changes the language for Google Assistant. If a different language is required for Google Assistant then it can be selected separately in the menu for Google Assistant.

4.2.1.4. Settings for head-up display*

Adjust the position, brightness or rotation of the head-up display.

System settings

Settings can be defined when the car has started and a projected image is shown on the windscreen.

- 1 Press .
- 2 Select **Controls**.
- 3 Select the setting to be adjusted under **Displays**.

Adjusting the position or brightness

The information in the display is automatically adapted to the background lighting conditions. The brightness is also affected when the brightness in the car's other displays is adjusted.

Click on the setting to be adjusted.

1 You can use the steering wheel's right-hand keypad to adjust position or brightness.

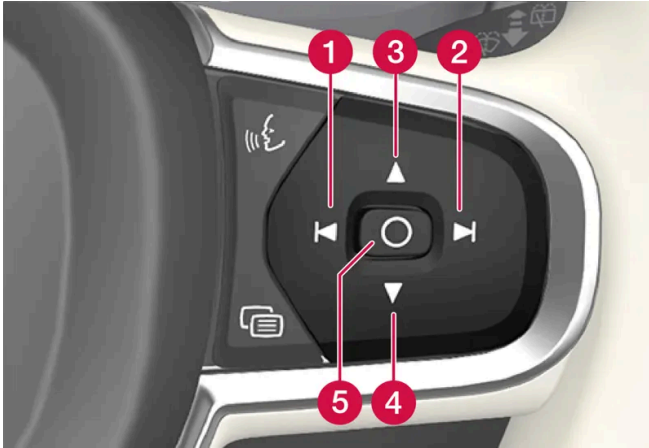

- 1 Reducing the brightness
- 2 Increasing the brightness
- 3 Raising the position
- 4 Lowering the position
- 5 Confirm

Rotation

The display may need to be rotated when replacing the windscreen or display unit.

Click on the setting to be adjusted.

1 You can use the steering wheel's right-hand keypad to rotate the display.

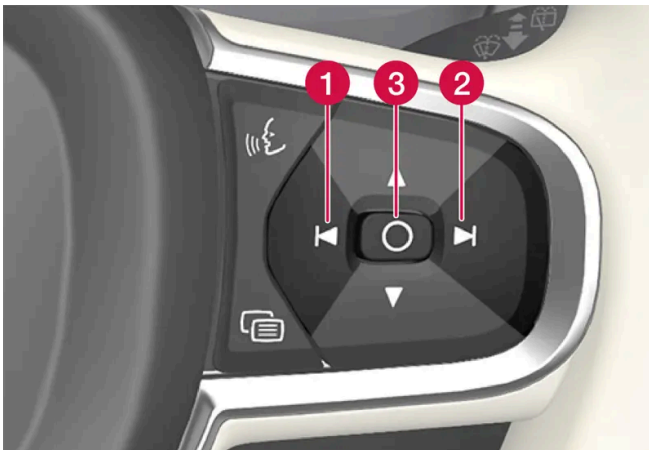

- 1 Rotate anticlockwise
- 2 Rotate clockwise
- 3 Confirm

* Option/accessory.

The content of this manual represents the status of the user manual at the time of printing and may not be completely valid in future instances. For more information, refer to the first page for the complete disclaimer note.

4.2.1.5. Settings for unlocking

It is possible to select different sequences for unlocking.

- 1 Press  in the centre display.
- 2 Press **Controls**.
- 3 Select setting for unlocking.

4.2.1.6. Setting the speed limit for Care Key

The speed limit for Care Key is set in the centre display.

The speed limit for Care Key can only be set from a profile with administrative privileges. To access the settings:

- 1 Press  in the centre display.
 - 2 Select **Profiles**.
 - 3 Select **Care key**.
 - 4 Activate **Speed limit** and select the desired maximum speed ^[1].
- The speed limit is activated when the car is used with Care Key.

The car must be unlocked using a key without limit in order to deactivate the function. The speed limit for Care Key can be deactivated via settings in the centre display. Care Key can then be used like a regular key.

Indication in driver display

An active speed limit is indicated by a symbol in the driver display as well as a message **Speed limitation cannot be exceeded Care Key in use**. A yellow dotted line on the speedometer shows the current speed limitation.

Symbol	Specification
	Speed limitation is active.

[1] A possible interval is 50-150 km/h (30-95 mph), with increments of 10 km/h (5 mph).

4.2.1.7. Settings for lock indication

It is possible to select various options for how the car confirms locking and unlocking in the settings menu in the centre display.

- 1 Press  in the centre display.
 - 2 Press **Controls**.
 - 3 Choose to activate or deactivate confirmation for locking/unlocking.
-

4.2.1.8. Settings for Keyless entry*

It is possible to select different sequences for Keyless entry.

- 1 Press  in the centre display.
- 2 Press **Controls**.
- 3 Select setting for unlocking.

* Option/accessory.

4.2.2. User profiles

4.2.2.1. User profiles

Many of the settings defined in the car can be saved to a personal user profile.

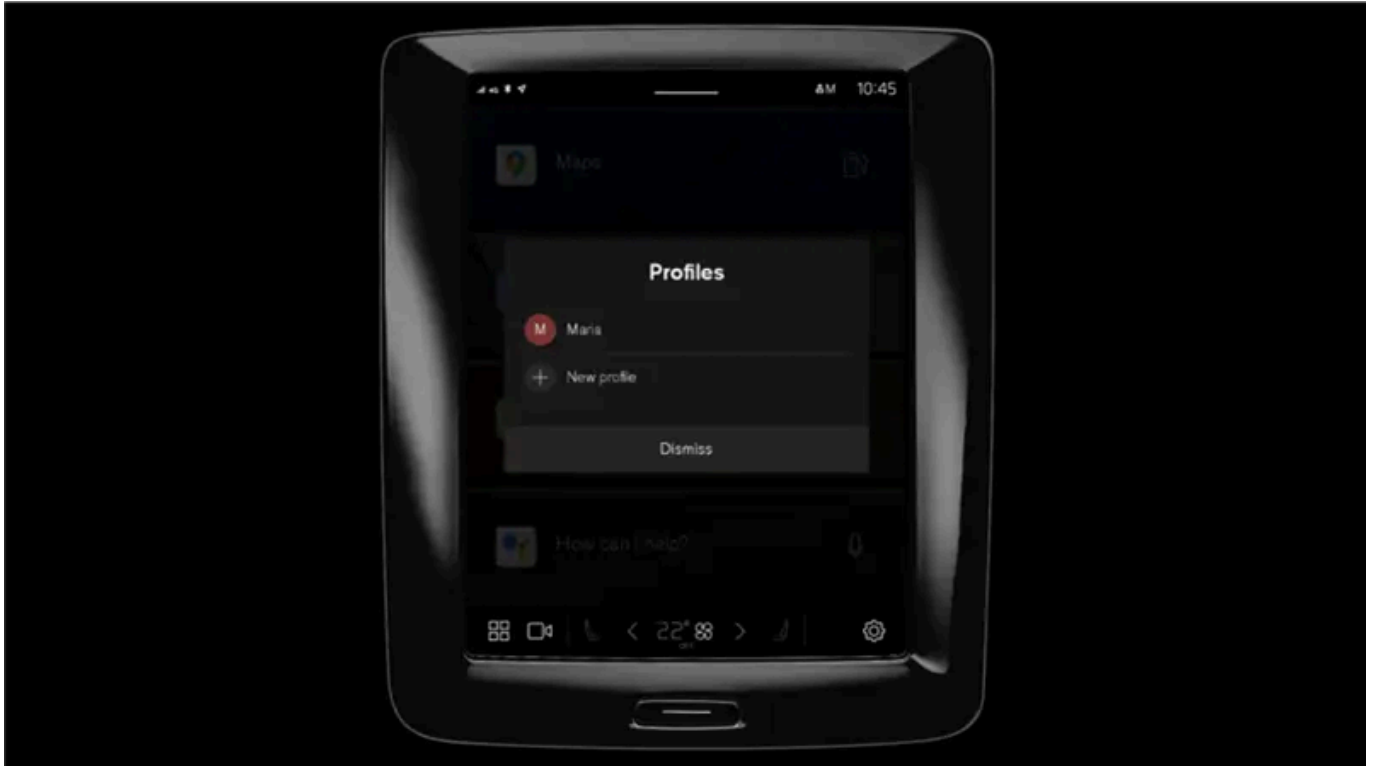

The **Owner** profile is pre-installed and active in the car on first use or after a factory reset.

The **Owner** profile has administrative privileges and cannot be deleted.

Drag down the notification view to access user profiles.

The status field shows a  symbol, together with the initials of the active profile. When the system is logged-out, no symbol/initials are shown in the status field.

Automatic profile selection

It is possible to connect your key to a profile. The profile, along with all of its settings, will then be selected automatically every time the specific key is identified during unlocking or opening the driver's door.

The last profile used is activated if a key is not linked with a specific profile.

General information about settings

Changes to the car's settings are saved in different ways depending on the category to which the settings belong. These settings may be personal, global or adapted for a drive cycle.

Personal preferences

Personal settings are saved to an active profile.

There are two kinds of personal settings:

- Car function settings – settings relating to driver support, driver side climate, the driver seat, the door mirrors, and interior and exterior lighting. These settings retain their values when a profile is added or when signing out from an active profile.

- Sound and media settings – settings relating to navigation, sound and media systems, apps and linked accounts. These settings return to default settings when a profile is added or when signing out from an active profile.

Global settings

The global settings are not changed when switching to a different profile. They remain the same regardless of which profile is active. Passenger side climate control, the passenger seat memory function, and certain system settings are examples of global settings.

Default drive cycle settings

A number of settings return to their defaults^[1] after a drive cycle.

The values for these settings can be adjusted while driving. After driving, it is returned to the default. At next drive cycle, the setting will have its default value again.

^[1] Default settings may vary depending on market

4.2.2.2. Link key to user profile

It is possible to connect your key to a profile. In this way, the profile, along with all of its settings, will then be selected automatically every time the specific key is identified during unlocking or opening the driver's door.

If the key has not been linked to a profile, the profile last used will be activated when the car is started. When the car is first started, the **Owner** profile is selected automatically.

Linking a key to a profile

Note

If the key was previously linked to another profile, the link is moved from the previous profile to the active profile.

- 1 Press .
- 2 Select **Profiles**.
- 3 Select **Connect key to profile** to connect a selected key to a profile.

It is only possible to connect a profile to the key that is currently being used in the car. If there are multiple keys in the car, the message **More than one key found. Place the key you want to connect on the backup reader.** will be displayed



Backup reader's location in the tunnel console.

Disconnecting a key from a profile

- 1 Press .
- 2 Select **Profiles**.
- 3 Select **Disconnect key from profile** to remove the active profile from the connected key.

It is possible to disconnect a key from a profile even if the key is not in the car.

4.2.2.3. Managing user profiles

It is possible to switch to another profile even if the key being used is linked to a different profile.

Creating a profile

- 1 Drag down the notification view to access user profiles.
- 2 Tap on the active profile.
- 3 Select **New profile**.
- 4 The profile is created.
- > The profile is set as the active profile.

You will be guided through an interactive flow to help you set up the new profile. There you can choose to pair a phone with the car or to link different accounts, such as Volvo ID, to the profile. It is also possible to skip certain steps and complete them later.

It is possible to create up to six different profiles.

Selecting a profile

- 1 Drag down the notification view to access user profiles.
 - 2 Tap on the active profile.
 - 3 Selectable profiles are displayed.
 - 4 Select the desired profile.
- The profile is selected and the system loads the settings for the selected profile.

Note

To cancel the moving of the seat when changing the profile, tap on any of the buttons on the seat part of the front seat.

Signing out a profile

- 1 Drag down the notification view to access user profiles.
 - 2 Select **Log out**.
- Signing out takes place from the profile and it is no longer possible to access the accounts linked with that profile.
- 3 The system is preset to a signed-out mode and settings changed are not saved to a profile.

Note

To create, select and logout of a user profile is only possible when the car is stationary.

4.2.2.4. Profile settings

From profile settings, it is possible to change profile name, add and remove linked keys, link different accounts (such as Volvo ID), activate the lock screen, and delete the active profile, among other things.

Activating the screen lock

When the screen lock is activated, a passcode is required to be able to use the active profile.

- 1 Press .
- 2 Select **Profiles**.
- 3 Select **Screen lock**.
- 4 Select the type of screen lock and then activate.
 - The screen lock will be shown in the centre display when switching to a profile, and also every time the system is restarted.

Deleting a profile

Settings that have been saved to one or more profiles can only be deleted if the car is stationary.

- 1 Press .
- 2 Select **Profiles**.
- 3 Select **Delete this profile**.
 - User information and connections linked to the profile are deleted.
- 4 The system is preset to a signed-out mode and settings changed are not saved to a profile.

Become an administrator

It is possible to set a profile as administrator.

- 1 Press .
- 2 Select **Profiles**.
- 3 Select **Become an admin**.

Changing the name of a profile

- 1 Press .

- 2 Select **Profiles**.
 - 3 Tap on **Edit** next to the current profile name.
 - 4 Change the profile name and confirm the change.
-

4.2.2.5. Link account to user profile

It is possible to add accounts to a selected user profile. Examples of accounts that can be added are Volvo ID and Google account.

Adding an account

- 1 Press .
- 2 Select **Profiles**.
- 3 Select **Accounts**.
- 4 Select to add account.
 - A list of accounts that can be added is shown.
- 5 Select the desired account.

Then follow the instructions shown. The instructions depend on the type of account selected.

4.2.3. Centre display

Many of the car's functions are controlled from the centre display. Presented here is the centre display and its options.



Home view

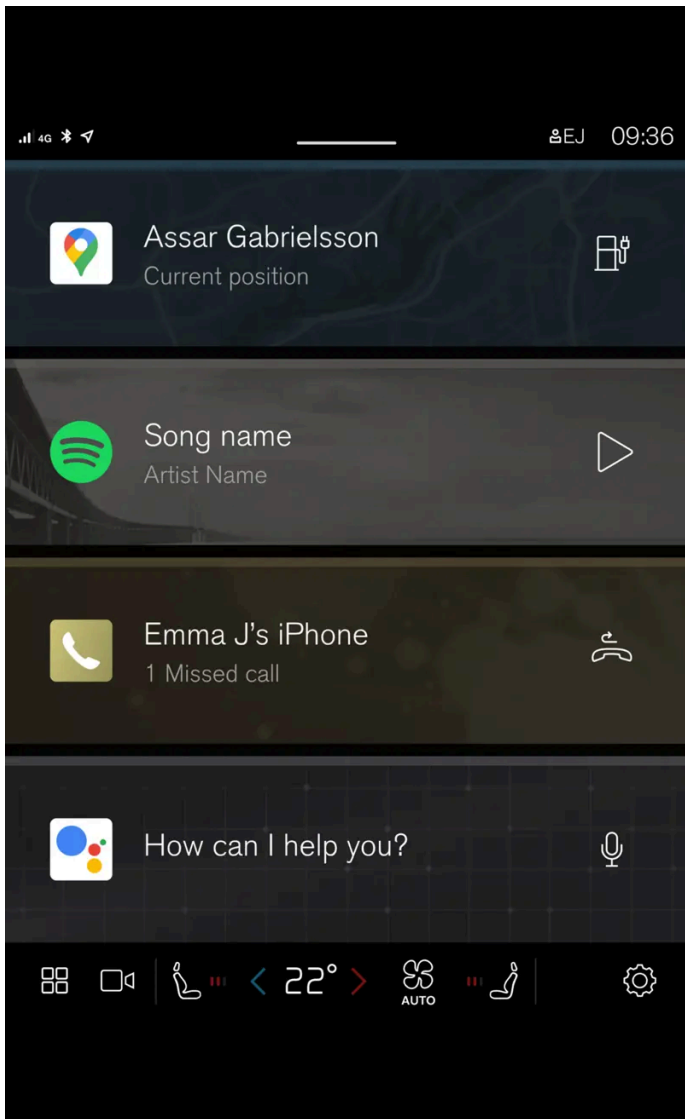

Home view is the first view that is shown when the screen is started.

Home view consists of four tiles that show the most recently used apps. The different views of the centre display, such as climate view, camera view, app view and notification view, are reached from home view.

Camera view

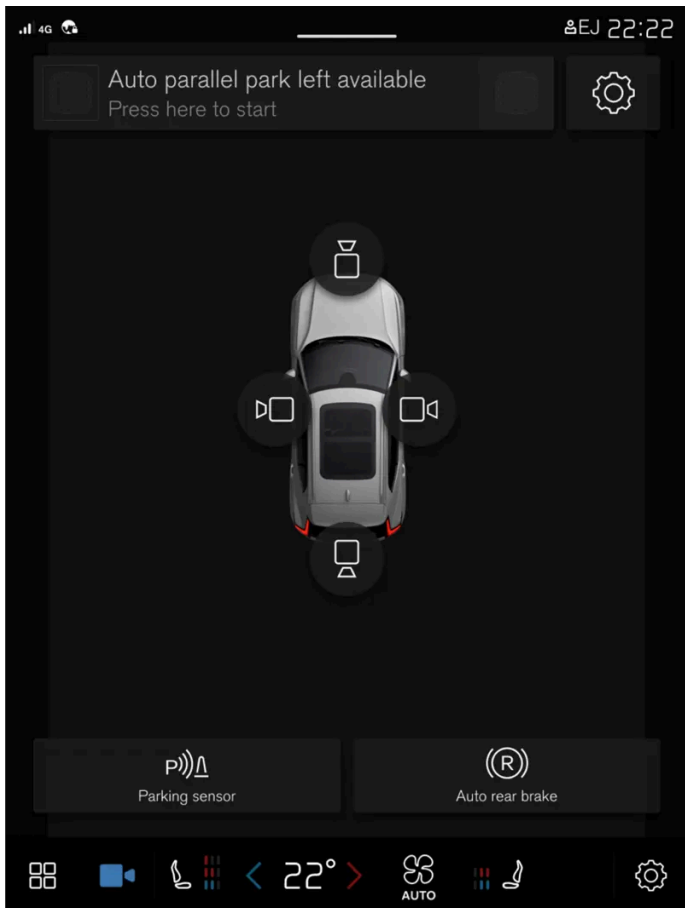

Camera view shows the park assist cameras (PAC^[1]), which displays a composite 360° view and separate views for each of the four cameras: rear, front, left or right camera view.

App view

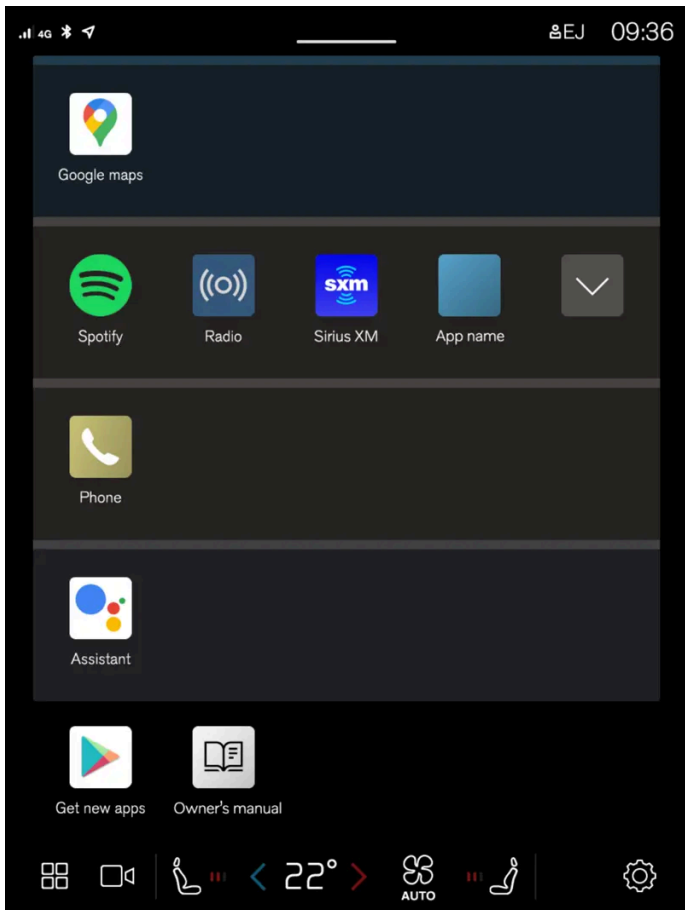

The view for apps that have been downloaded (third-party apps) or for the car's built-in functions.

i Note

If necessary, the climate control can be used to cool the media system in the centre display. In these cases, the message **Cooling infotainment system** is shown in the driver display.

[1] Park Assist Camera

4.2.4. Managing the centre display

Many of the car's functions are controlled and regulated from the centre display. The centre display is a touch screen that reacts to touch.

Using the touch screen functionality in the centre display

The screen reacts differently depending on whether it is touched by dragging, swiping, or tapping. Actions such as browsing between different views, marking objects and scrolling in a list can be performed by touching the screen in different ways.

The centre display is an optical touchscreen.

The content of this manual represents the status of the user manual at the time of printing and may not be completely valid in future instances. For more information, refer to the first page for the complete disclaimer note.

Two people can interact with the screen at the same time, e.g. to adjust the climate for the driver and passenger side respectively.

 **Important**

Do not use sharp objects on the screen as they may scratch it.

 **Note**

Wearing gloves may limit or prevent touch screen response.

Returning to home view from another view

- 1 Briefly press the home button below the centre display.
 - The last position of the home view is shown.

Using the controls in the centre display

The control is used for many of the car's functions. Regulate e.g. temperature by means of one of the following:

- drag the control to the desired temperature
- tap on + or – in order to raise or lower the temperature gradually
- tap on the desired temperature on the control.

4.2.5. Centre display views

The centre display is started automatically when the driver's door is opened.

Home view

Home view is the view that is shown when the screen is started. This consists of four subviews.

It is possible to choose which apps you want to be displayed in the home view's subviews. An app selected from app view is launched in the relevant subview in home view.

The subviews are dynamic and show the latest apps used, e.g. navigation, media or phone. Tap on the desired app to expand it, or swipe from the left in the tile to view additional apps.

Status field

The activities in the car are shown at the top of the screen. The status field shows active user profile, network and connection information and the clock, among other things.

Notification view

The car's notifications are collected together at the top of the screen.

Drag the tab down to access notification view. Missed calls or information regarding the car, for example, are shown here. If there is a new notification, the symbol for the notification view is blue. User profiles are also accessible from the notification view.

Leave notification view by tapping outside notifications or on the home button, or swipe up. The underlying view is then visible and available for use again.

Climate view

Buttons for app view, settings, and the most common climate settings, such as setting temperature and seat heating, are available at the bottom of the screen.

Tap on the temperature button at the bottom centre of the centre display to open the climate view with more setting options.

Press the home button to close the climate view.

Camera view

Camera view starts automatically when gear position R is used.

Camera view shows the park assist cameras (PAC^[1]), which displays a composite 360° view and separate views for each of the four cameras: rear, front, left or right camera view.

Camera view is closed automatically when the car is moving at a certain speed, or is closed by tapping on  or pressing the home button.

App view

Tap on  down in the centre display.

The app view provides access to the car's pre-installed and downloaded apps. From the app view, there is the option to download and install additional apps. The owner's manual is also available from here.

Tap on an app to open it in full screen mode.

User profiles

Drag down the notification view to access user profiles.

Many of the settings made in the car can be adapted according to the user's personal preferences and can be saved in different user profiles.

Settings that can be saved in a user profile include, amongst other things, screens, mirrors, front seats, navigation, audio and media system, language and voice control.

You can add profiles, log out, or switch between profiles in the notification view.

4.2.6. Managing subviews in centre display

Home view and app view in the centre display include subviews that can be expanded.

Expanding an app in home view

Expanding an app:

- 1 Tap on the desired app. When an app is opened, the other apps are suppressed temporarily.
The open app provides access to its basic functions.

Closing an app:

- 1 Briefly press the physical home button below the centre display.

Expanding a tile in the app view

Expanding a subview:

- 1 Press .
- > The subview is expanded and provides access to further apps.

Closing an expanded subview:

- 1 The subview can be closed in two ways.
 - Press .

- Briefly tap on the home button at the bottom of the centre display.



Home button for the centre display.

There is always the option to go back to home view by pressing the home button.

4.2.7. Symbols in the centre display's status bar

Overview of the symbols that can be shown in the centre display's status bar.

The status bar shows activities in progress and, in some cases, their status. Not all symbols are shown all the time due to the limited space in the status bar. Here are some examples.

Symbol	Specification
	Connected to the network.
LTE2G3G4G	Network type.
R	Roaming activated.
	Bluetooth device connected.
	Information sent to and from GPS.
15:45	Clock.
	Wireless phone charging.

4.2.8. Moving apps in the centre display

The app view is made up of four tiles where the apps can be moved and organised as preferred. Expand a tile for access to apps other than just the ones displayed.

New apps installed are placed in app view.

- 1 Open app view.
Press .
- 2 Tap on an app and hold it down.
➤ It is then possible to move it.
- 3 Drag the app to the preferred place in the app view.

Swipe across the screen to scroll up or down in the view.

 **Note**
A tile cannot be left empty without apps.

 **Note**
Apps cannot be added to locations that are already occupied.

4.2.9. Messages in the centre display

The following sample illustration shows how messages and notifications can be shown in the centre display in various contexts.

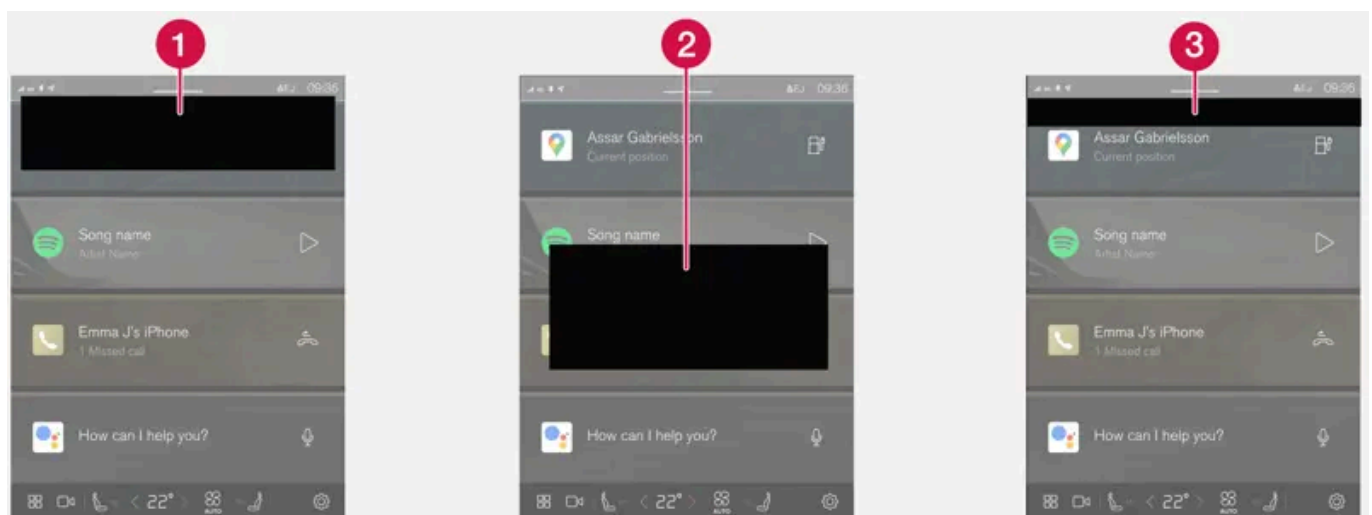

- 1 Appears at the top of the centre display. Requires direct action and can have up to three buttons that allow the user to deal with the message. Dismiss by sweeping right or left, the message is then saved in notification view.
- 2 Displayed as a window in the centre display and requires direct action. May have 1-3 buttons for action.

- 3 Appears for a few seconds at the top of the centre display. It is not possible to do anything with this notification, and it is not saved anywhere.

4.2.10. Keyboard in the centre display

The centre display keyboard makes it possible make entries using keys. It is also possible to "draw in" letters, numbers or words on the screen by hand.

The keyboard can be used to enter words or characters, e.g. to write text messages from the car, enter passwords or search for articles in the digital owner's manual.

The keyboard is only shown when entries can be made on the screen.



Press this button to hide the keyboard. If this is not possible, the button is not shown.



Press this button to enter text normally.



Press this button to draw in characters by hand.

Confirm the entered text by pressing the confirmation button above the keyboard. The appearance of the button may vary depending on context.

Entering words or characters by hand

- 1 Enter a word or character in the field for handwritten letters.
 - > Suggestions for words or characters are shown. The most suitable is shown at the top of the list.

Important

Do not use sharp objects on the screen as they may scratch it.

- 2 You can choose another word or character from the list by pressing on it. Otherwise you only need to wait for a moment.
 - > The word or character is then entered.

Letter or character variants

Letter or character variants e.g. **é** or **è** can be entered by pressing and holding the letter or character. A box containing available variants is shown and the required variant can be selected by pressing it once. The original letter or - character is used if no vari-

ant is selected.

4.2.11. Changing keyboard language in centre display

To make it possible to switch between different languages for the keyboard, the languages must first be added under **Settings**.

Adding or deleting languages in settings

The keyboard is automatically set to the same languages as the system language. The language for the keyboard can be adapted manually without affecting the system language.

- 1 Tap on  at the bottom of the centre display.
 - 2 Tap on **System, Languages and input, Keyboard**.
 - 3 Select one or more languages from the list.
- It is now possible to switch between the selected languages directly from the keyboard for text input.

If no languages have been actively selected under **Settings**, the keyboard retains the same language as the car's system language.

Switching between different languages in the keyboard



When a number of languages have been selected in **Settings**, the button in the keyboard is used to switch between the different languages.

To change keyboard language with list:

- 1 Give a long press on the button.
- A list opens.
- 2 Select the required language. If more than four languages have been selected, it is possible to scroll in the list from the keyboard.
- The keyboard is adapted to the selected language and other word suggestions are given.

To change the keyboard language without displaying the list:

Give a short press on the button.

The content of this manual represents the status of the user manual at the time of printing and may not be completely valid in future instances. For more information, refer to the first page for the complete disclaimer note.

- 1 > The keyboard is adapted to the next language in the list without displaying the list.

4.2.12. Date and time

The clock is shown in the centre display, and it is also possible to change the date and time settings there.

Clock location

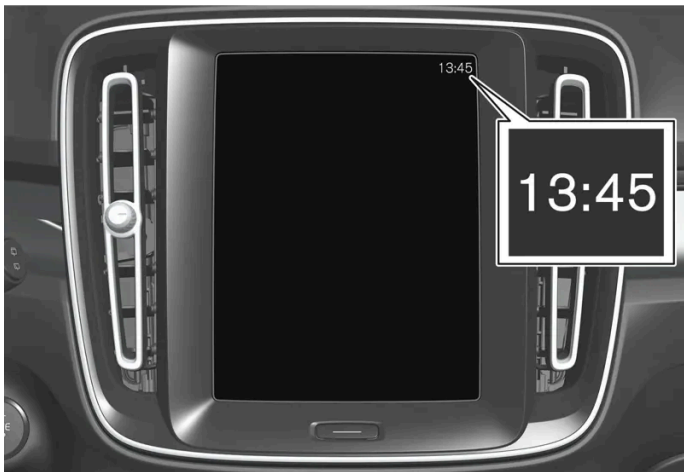

The clock is located at the top right of the centre display's status bar.

Date and time settings

- 1 Tap on  and then **System**, then select **Date and time**.
- 2 Select the desired settings.

Automatic date and time setting



Date and time are set automatically as standard, and time zone is adjusted automatically as standard based on the location of the car.

Adjust the date and time manually by disabling the automatic date and time setting. Adjust time zone manually by disabling the setting for automatic time zone. It is also possible to select the 24-hour or 12-hour clock.

4.2.13. Navigate in the owner's manual in the centre display

The digital owner's manual can be accessed from the centre display.

The content of this manual represents the status of the user manual at the time of printing and may not be completely valid in future instances. For more information, refer to the first page for the complete disclaimer note.

To access the owner's manual, tap on  followed by .

There is a range of different options for finding information in the owner's manual.

Contents of the Owner's Manual

Homepage



Tap on the symbol to go back to the start page in the owner's manual.

Categories

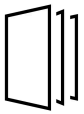

The articles in the owner's manual are structured into main categories and subcategories. The same article can be found in several appropriate categories so that it can be found more easily.

Visual navigation

Exterior and interior overview images of the car. Different parts are designated with hotspots that lead to articles about that part of the car.

- 1** Press **Exterior** or **Interior**.
 - Exterior or interior images are shown with so-called hotspots in place. The hotspot leads to articles about the corresponding part of the car. Swipe horizontally over the screen to browse among the images.
- 2** Tap on a hotspot.
 - The title of the article about the area is shown.
- 3** Tap on the title to open the article.

To go back, press the back arrow.

Quick guide

Information to help you get started with the most commonly used functions in the car.

Video



Press the symbol to view brief instruction videos for various functions in the car.

Release notes

Read more about the current version and updates implemented.

Search function

Tap on the search field at the top of the owner's manual to access the search function from the homepage.

Use  at the top in the owner's manual to access the search function from other pages.

4.3. Head-up display

4.3.1. Head-up display*

The head-up display can assist with driving as the driver can use it to project information from the driver display onto the windscreen and instead concentrate on the road.



The head-up display projects information from the driver display onto the windscreen in front of the driver. The information can only be seen from the driver's position.

Examples of information that can be shown:

- cruise control
- speed
- navigation
- telephone call
- traffic sign information ^[1]
- warnings

Activating and deactivating the head-up display

- 1 Press .

- 2 Select Controls.
- 3 Under **Displays**, activate or deactivate **Head-up display**.

 **Note**

The driver's ability to see the information in the head-up display is impaired by the following

- use of polarising sunglasses
- a driving position which means that the driver is not sitting centred in the seat
- objects on the display unit's cover glass
- unfavourable light conditions.

 **Important**

The display unit from which the information is projected is located in the instrument panel. To avoid damage to the display unit's cover glass - do not store any objects on the cover glass and make sure that no objects fall down onto it.

 **Note**

Certain visual defects may cause headaches and a feeling of stress during the use of the head-up display.

* Option/accessory.

^[1] The function is available in certain markets.

4.3.2. Settings for head-up display*

Adjust the position, brightness or rotation of the head-up display.

System settings

Settings can be defined when the car has started and a projected image is shown on the windscreen.

- 1 Press .
- 2 Select **Controls**.
- 3 Select the setting to be adjusted under **Displays**.

Adjusting the position or brightness

The information in the display is automatically adapted to the background lighting conditions. The brightness is also affected when the brightness in the car's other displays is adjusted.

Click on the setting to be adjusted.

- 1 You can use the steering wheel's right-hand keypad to adjust position or brightness.

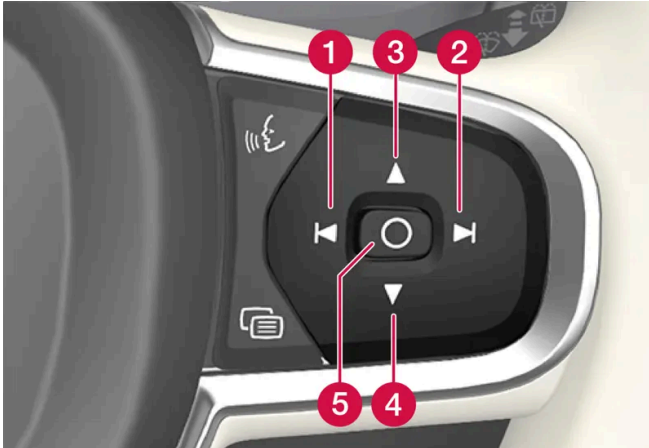

- 1 Reducing the brightness
- 2 Increasing the brightness
- 3 Raising the position
- 4 Lowering the position
- 5 Confirm

Rotation

The display may need to be rotated when replacing the windscreen or display unit.

Click on the setting to be adjusted.

- 1 You can use the steering wheel's right-hand keypad to rotate the display.

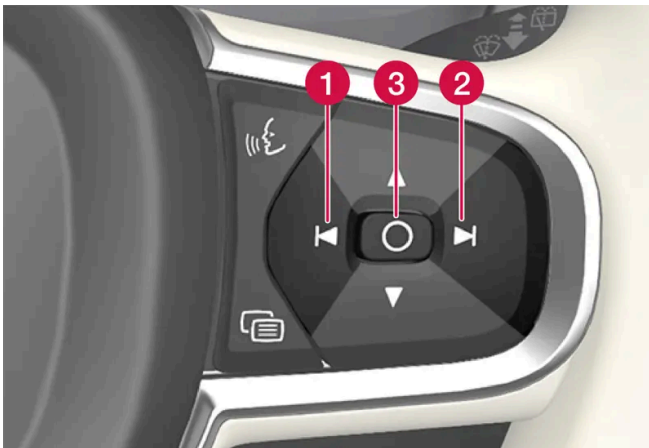

- 1 Rotate anticlockwise
- 2 Rotate clockwise
- 3 Confirm

* Option/accessory.

4.3.3. Cleaning the Head-up display*

Gently wipe the display's cover glass with a clean and dry microfibre cloth. If necessary, lightly moisten the microfibre cloth.

Never use strong stain removers. A special cleaning agent available from Volvo dealers can be used for more difficult cleaning.

* Option/accessory.

4.3.4. Using a stored position for seat, door mirrors and head-up display*

If the positions for the power* seat, the door mirrors and the head-up display* have been stored, they can be activated by using the memory buttons. ^[1]

Using a stored setting

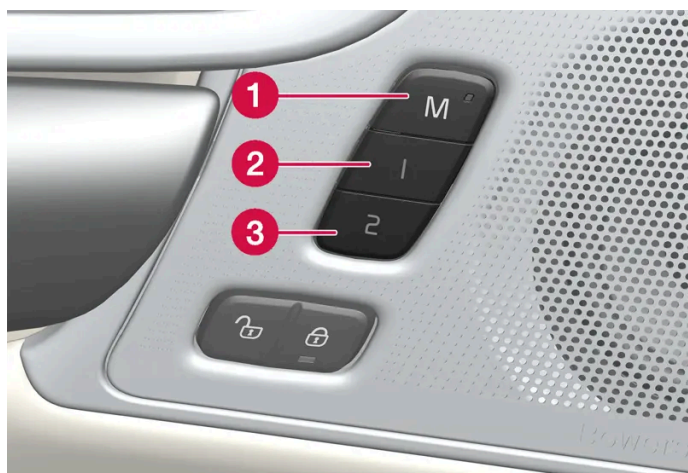

A stored setting can be used with the front door either open or closed:

Open front door

The content of this manual represents the status of the user manual at the time of printing and may not be completely valid in future instances. For more information, refer to the first page for the complete disclaimer note.

- 1 Depress one of the memory buttons 1 (2) or 2 (3) with a short press. Power seat, door mirrors and head-up display move and then stop at the positions stored in the selected memory button.

Closed front door

- 1 Hold one of the memory buttons 1 (2) or 2 (3) depressed until seat, door mirrors and head-up display stop in the positions that are stored in the selected memory button.

If the memory button is released, the movement of the seat, door mirrors and head-up display will be stopped.

Warning

- Because the driver's seat can be adjusted with the ignition off, children should never be left unattended in the vehicle.
- Movement of the seat can be STOPPED at any time by pressing any button on the power seat control panel.
- Do not adjust the seat while driving.
- Make sure there is nothing under the seats when they are being adjusted.

* Option/accessory.

^[1] The last position is also saved automatically in the active user profile and will be used next time the same profile is used again.

4.3.5. Storing position for seat, door mirrors and head-up display*

You can store the position for power* seat, door mirrors and head-up display* in the memory buttons. ^[1]

Store two different positions for the power* seat, the door mirrors and the head-up display* using the memory buttons. The

buttons are located on the inside of one of the front doors or both*.

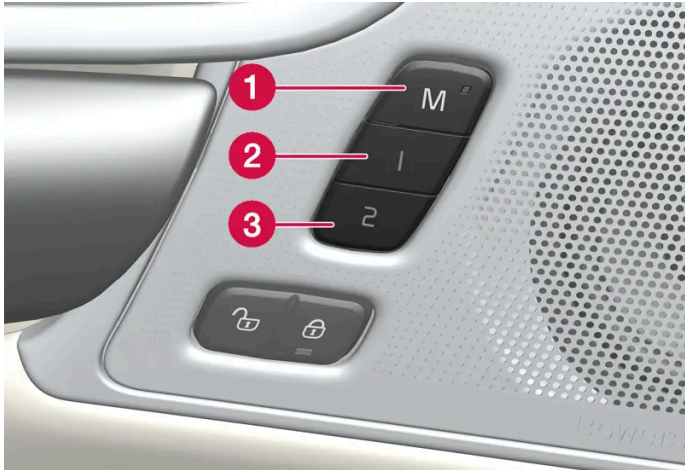

- 1 Button **M** for storing settings.
- 2 Memory button 1.
- 3 Memory button 2.

Storing a position

- 1 Adjust seat, door mirrors and head-up display to the desired position.
- 2 Press and hold the **M** button depressed. The light indicator in the button illuminates.
- 3 Press and hold the **1** or **2** button within three seconds.
 - When the position has been stored in the selected memory button, an acoustic signal can be heard and the light indicator in the **M** button extinguishes.

If none of the memory buttons is depressed within three seconds then the **M** button extinguishes and no storing takes place.

The seat, the door mirrors or the head-up-display must be readjusted before a new memory can be set.

Note

The stored positions are saved in the active profile.

* Option/accessory.

[1] The current position is also saved automatically in the active user profile.

4.4. Symbols and messages

The content of this manual represents the status of the user manual at the time of printing and may not be completely valid in future instances. For more information, refer to the first page for the complete disclaimer note.

4.4.1. Messages for BLIS*

A number of messages regarding BLIS^[1] can be shown in the driver display. Here are some examples.

Message	Specification
Blind spot sensor Service required	The system does not function as it should. A workshop should be contacted ^[2] .
Blind spot system off Trailer attached	BLIS and Cross Traffic Alert* have been deactivated as a trailer has been connected to the car's electrical system.

A text message can be cleared by briefly pressing the  button, located in the centre of the steering wheel's right-hand keypad.

If a message remains, contact a workshop - an authorised Volvo workshop is recommended.



* Option/accessory.

^[1] Blind Spot Information

^[2] An authorised Volvo workshop is recommended.

4.4.2. Symbols and messages for electronic stability control

A number of symbols and messages regarding electronic stability control (ESC^[1]) can be shown on the driver display. Here are some examples.

Symbol	Message	Specification
	Constant glow for approx. 2 seconds	System check when the engine is started.
	Flashing light	The system is being activated.
	ESC Service required	The system is disengaged. Stop the car at a safe place. Check whether the error was temporary or if it persists by switching off the engine and starting it again. If the problem persists, contact a workshop – an authorised Volvo workshop is recommended. The car can be driven but without the ESC functionality.

A text message can be cleared by briefly pressing the  button, located in the centre of the steering wheel's right-hand keypad.





If a message remains, contact a workshop - an authorised Volvo workshop is recommended.

^[1] Electronic Stability Control

4.4.3. Symbols and messages for Pilot Assist*

The content of this manual represents the status of the user manual at the time of printing and may not be completely valid in future instances. For more information, refer to the first page for the complete disclaimer note.

A number of symbols and messages regarding Pilot Assist^[1] can be shown. Here are some examples.

Symbol	Message	Specification
	The symbol is lit. The car symbol is lit when the car has a vehicle ahead to relate to.	The car is maintaining the stored/selected speed.
	Pilot Assist Service required The symbol is extinguished	The system does not function as it should. A workshop should be contacted. Pilot Assist has been set in standby mode.
	Steering wheel symbol extinguished	Indicates deactivated steering assistance. When Pilot Assist provides steering assistance, the steering wheel is lit up.
	Symbol for hands on the steering wheel	The system cannot detect whether the driver has his/her hands on the steering wheel. Place your hands on the steering wheel and actively steer the car. The system warns in different steps coupled with acoustic signals. The hazard warning flashers are activated if the car needs to slow down to a standstill.
	Radar sensor front Sensor blocked See Owner's manual, Front radar alignment incomplete or Front camera alignment incomplete	Clean in front of the radar unit's detectors.

A text message can be cleared by briefly pressing the  button, located in the centre of the steering wheel's right-hand keypad.





If a message remains, contact a workshop - an authorised Volvo workshop is recommended.

* Option/accessory.

^[1] This function can be either standard or optional, depending on market.

4.4.4. Symbols and messages for lane assistance

A number of symbols and messages regarding lane assistance (LKA^[1]) can be shown on the driver display. Here are some examples.

Symbol	Message	Specification
	Driver support system Reduced functionality Service required	The system does not function as it should. A workshop should be contacted ^[2] .
	Windscreen sensor blocked See Owner's manual	The ability of the camera to scan the roadway in front of the car is reduced.
	Apply steering Lane Keeping Aid	The steering assistance does not function if the driver does not have his/her hands on the steering wheel. Follow the instruction and steer the car.
		
	Lane Keeping Aid not available	Steering assistance is currently not available. Contact a workshop if the icon has not gone after a number of drive cycles.

A text message can be cleared by briefly pressing the  button, located in the centre of the steering wheel's right-hand keypad.

If a message remains, contact a workshop - an authorised Volvo workshop is recommended.

^[1] Lane Keeping Aid

^[2] An authorised Volvo workshop is recommended.

4.4.5. Display mode for lane assistance

Lane assistance (LKA^[1]) is visualised by symbols in the driver display depending on the situation.



Here are some examples of symbols and the situations in which they are shown:

Available



Available – One of the symbol's side lines is white.

Lane assistance reads one of the lane's side lines.

Unavailable



Unavailable – the lane lines in the symbol are extinguished.

The Lane assistance cannot detect the lane lines, the speed is too low or the road is too narrow.

Indication of steering assistance/warning





Steering assistance/warning – the lane lines in the symbol are coloured.

Lane assistance indicates that the system is giving a warning and/or attempting to steer the car back into the lane.

4.4.6. Symbols and messages for park assist system* and park assist camera*

Symbols and messages for Park Assist System and Park Assist Camera can be shown in the driver display and/or the centre display. Here are some examples.

Symbol	Message	Specification
	If the symbol is extinguished.	The rearward parking assistance sensors are deactivated , so there are no acoustic warnings and field marks for obstacles/objects.
	Cleaning needed Park Assist System sensors blocked	One or more of the function's sensors are blocked - check and correct as soon as possible.
	Park Assist System unavailable Service required	The system does not function as it should. A workshop should be contacted ^[1] .

A text message can be cleared by briefly pressing the  button, located in the centre of the steering wheel's right-hand keypad.

If a message remains, contact a workshop - an authorised Volvo workshop is recommended.

Warning



Pay additional attention while reversing when this symbol is shown if a trailer, bicycle rack or similar is mounted and electrically connected to the car.

Extinguished symbol indicates that the parking assistance sensors rearward are **switched off** and warn of any obstacles.

Defective park assist camera

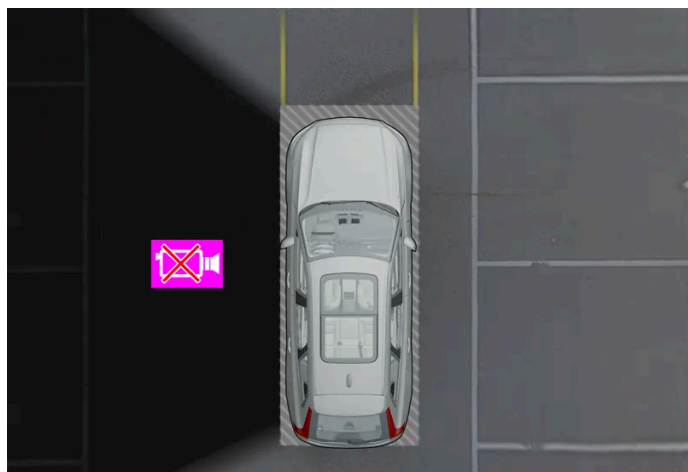

Example for showing when the car's left camera is non-operational.

If a camera sector is black it means that the camera is inoperative.

The content of this manual represents the status of the user manual at the time of printing and may not be completely valid in future instances. For more information, refer to the first page for the complete disclaimer note.

A black camera sector is also shown in the following instances, but then **without** the symbol for defective camera:

- open door
- open tailgate
- folded-in door mirror.





* Option/accessory.

[1] An authorised Volvo workshop is recommended.

4.4.7. Symbols in the centre display's status bar

Overview of the symbols that can be shown in the centre display's status bar.









The status bar shows activities in progress and, in some cases, their status. Not all symbols are shown all the time due to the limited space in the status bar. Here are some examples.

Symbol	Specification
	Connected to the network.
LTE 2G 3G 4G	Network type.
R	Roaming activated.
	Bluetooth device connected.
	Information sent to and from GPS.
15:45	Clock.
	Wireless phone charging.













4.4.8. Indicator and warning symbols

The indicator and warning systems alert the driver to the fact that a function is activated, a system is working, or a defect or serious error has occurred.



Red symbols

	<p>Warning</p> <p>The red warning symbol illuminates when a fault has been detected which could affect the safety or drivability of the car. An explanatory text is shown on the driver display at the same time.</p> <p>The warning symbol can also illuminate in conjunction with other symbols.</p>
	<p>Seatbelt reminder</p> <p>Illuminates or flashes when someone in the car is not wearing a seatbelt.</p>
	<p>Airbags</p> <p>An error has been detected in any of the car's safety systems.</p> <p>Read the message on the driver display and contact a workshop. Volvo recommends that an authorised Volvo workshop is contacted.</p>
	<p>Fault in brake system</p> <p>An error has occurred on the braking system.</p> <p>Read the message on the driver display and contact a workshop. Volvo recommends that an authorised Volvo workshop is contacted.</p>
	<p>Parking brake</p> <p>Light illuminated permanently: The parking brake is activated.</p> <p>Flashing: an error has occurred with the parking brake. Read the message in the driver display.</p>
	<p>Faults in the electrical system</p> <p>An error has occurred on the electrical system.</p> <p>Read the message on the driver display and contact a workshop. Volvo recommends that an authorised Volvo workshop is contacted.</p>
	<p>High engine temperature</p> <p>The engine temperature is too high. Read the message in the driver display.</p>
	<p>Assistance at risk of collision</p> <p>Warns of a risk of collision with other vehicles, pedestrians, cyclists or large animals.</p>
	<p>Low oil pressure</p> <p>The engine oil pressure is too low. Switch off the engine immediately and check the engine oil level, top up with oil if necessary.</p> <p>If the symbol lights up and the oil level is normal, read the message on the display and contact a workshop. Volvo recommends that an authorised Volvo workshop is contacted.</p>





Amber symbols

	<p>Information</p> <p>A fault has occurred in one of the car's systems. Read the message in the driver display. The information symbol can also illuminate in conjunction with other symbols.</p>
	<p>Fault in brake system</p> <p>An error has occurred on the braking system. Read the message in the driver display.</p>
	<p>ABS fault</p> <p>The system is disengaged. The car's regular brake system continues to work, but without the ABS function.</p>
	<p>Emissions system</p> <p>Emissions systems fault. Drive to a workshop for checking. Volvo recommends that an authorised Volvo workshop is contacted.</p>
	<p>Rear fog lamp</p> <p>The rear fog lamp is illuminated.</p>
	<p>Tyre pressure system</p> <p>Low tyre pressure. If there is a fault in the tyre pressure system, the symbol will flash for approx. one minute and then illuminate with a constant glow. This may be because the system cannot detect or warn of low tyre pressure.</p>
	<p>Fault in the headlamp system</p> <p>A fault has occurred on the headlamp system. Read the message in the driver display.</p>
	<p>Lane assistance intervenes</p> <p>Lane assistance intervenes left/right.</p>
	
	<p>Fault with lane assistance</p> <p>An fault has occurred in the lane assistance system.</p>
	<p>Stability system</p> <p>Light on permanently: a fault has occurred in the system. Flashing: the system is working.</p>
	<p>Assistance at risk of collision System not available</p> <p>The system for assistance at risk of collision is not available, or is operating with reduced performance.</p>











Blue symbols

	<p>Active main beam</p> <p>Active main beam is activated and switched on.</p>
	<p>Main beam</p> <p>Main beam is switched on.</p>

Green symbols

	<p>Automatic brake The function is activated and the service brake or parking brake is operating.</p>
	<p>Front fog lamps The front fog lamp is switched on.</p>
	<p>Position lamps The position lamps are switched on.</p>
 	<p>Left and right-hand direction indicator The direction indicator is being used.</p>



White/grey symbols

	<p>Active main beam Active main beam is activated, but does not come on.</p>
	<p>Cannot find the car key. Fault when reading key during start. Place the key on the key symbol in the cup holder and try again.</p>
	<p>Driver Alert Driver Alert is activated.</p>
	<p>Preconditioning Engine and compartment heater/air conditioning pre-condition the car.</p>
	<p>Lane assistance Grey line: Lane assistance is activated but the road line has not been detected. White line: Lane assistance is activated and the road line has been detected. In addition, the car must be within the speed range 65-200 km/h (40-125 mph) for lane assistance to be available.</p>
	
	
	
	<p>Lane assistance switched off Lane assistance is switched off.</p>
	<p>Rain sensor The rain sensor is activated.</p>

4.4.9. Symbols and messages for parking climate control*

A number of symbols and messages regarding parking climate control can be shown in the driver display.

Messages relating to parking climate control can also be displayed in a device which has the Volvo Cars* app.

Symbol	Message	Specification
	Parking climate Service required	Parking climate control is disengaged. Contact a workshop ^[1] to check the function as soon as possible.
	Parking climate Temporarily unavailable	Parking climate control is temporarily disengaged.

* Option/accessory.

^[1] An authorised Volvo workshop is recommended.

4.4.10. Overheating in the engine and drive system

Under certain conditions, e.g. hard driving in hilly terrain and hot climate, there is an increased risk of overheating the engine and drive system – in particular with a heavy load.



- In the event of overheating, the engine's power may be limited temporarily.
- Remove any auxiliary lamps from in front of the grille when driving in hot climates.
- If the temperature in the engine's cooling system becomes too high then a warning symbol is illuminated and the driver display shows the message **Stop safely High engine temperature**. Stop the car in a safe way and allow the engine to run at idling speed for several minutes and cool down.
- If the message **Turn off engine High engine temperature** or **Turn off engine Coolant level low** is shown, stop the car and switch off the engine.
- A built-in protection function is activated if the transmission overheats. A warning symbol illuminates and the driver display shows the **Reduce speed to lower temperature Transmission warm** or **Stop safely Transmission hot Wait for cooling** message. Follow the recommendation given, reduce speed or stop the car in a safe way and allow the engine to run at idling speed for several minutes to enable the gearbox to cool down.
- If the car overheats, the air conditioning may be switched off temporarily.
- Do not turn the engine off immediately you stop after a hard drive.

Note

It is normal for the engine's cooling fan to operate for a time after the engine has been switched off.

Symbols in the driver display

The content of this manual represents the status of the user manual at the time of printing and may not be completely valid in future instances. For more information, refer to the first page for the complete disclaimer note.



Symbol	Specification
	High engine temperature. Follow the recommendation given.
	Low level, coolant. Follow the recommendation given.
	Gearbox hot/overheated/cooled. Follow the recommendation given.

4.4.11. Symbols and messages for the transmission

If a fault should occur in the gearbox, a symbol and a message are shown in the driver display.

Important

To prevent damage to any drive system components, the working temperature of the gearbox is checked. If there is a risk of overheating, a warning symbol illuminates in the driver display and a text message is shown - follow the recommendation given.

Symbol	Specification
	An error has occurred in the transmission. Read the message in the driver display.
	Hot or overheated gearbox. Read the message in the driver display.
	Temporary fault on drivetrain. Read the message in the driver display.

4.5. Voice control

4.5.1. Voice control with Google Assistant

Google Assistant, which is integrated in the car, makes it possible to use your voice to control a range of functions, e.g. the climate control system, Google Maps for navigation, FM radio* and your phone.



What is Google Assistant?

Google Assistant is a digital assistant that makes it possible to use your voice to control various in-car functions and get help with other things such as searching for information, weather forecasts, managing your Google Calendar, etc.

The Assistant understands natural speech, i.e. you do not need any knowledge of specific commands to get the system to do different things. Instead, there is the option to speak freely with the system, which provides feedback in the form of responses to what was requested, or indicates whether what was said could not be understood.

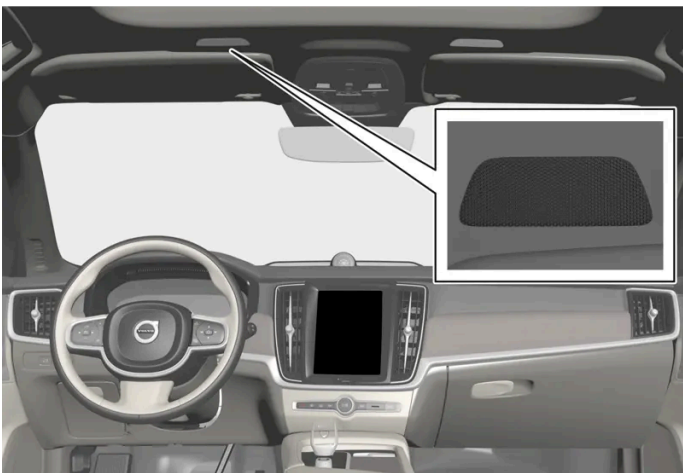

Voice control system microphone

Which areas can be controlled via Google Assistant?

Besides asking the Assistant for information searched for via Google, searching for weather forecasts or managing your Google Calendar^[1], a number of in-car functions can be controlled^[1] using voice commands. These include:

The content of this manual represents the status of the user manual at the time of printing and may not be completely valid in future instances. For more information, refer to the first page for the complete disclaimer note.

- media
- FM radio *
- phone and text messaging^[2]
- navigation via Google Maps
- climate

 **Note**

A poorer internet connection may limit the number of available functions.

 **Warning**

The driver always holds overall responsibility for driving the vehicle in a safe manner and complying with all applicable rules of the road.

* Option/accessory.

^[1] Requires Internet connection.

^[2] Text messages can only be dictated for phones with Android or iOS 13 or later.



4.5.2. Using voice control

Google Assistant makes it possible to use voice control to control different functions in the car or, for example, to ask for other information such as a weather forecast.



Starting Google Assistant

There are three different ways to start Google Assistant, as follows:

- by saying the voice command "Ok Google" or "Hey Google"^[1]
- by pressing briefly on the steering wheel button for voice control .
- by tapping on the microphone in the centre display .

The system shows that it is active and listening by means of a brief audible signal^[2] and a graphic confirmation in the centre display.

Example of voice control

After the system has started, different requests can be made by speaking freely. Here are some examples of how to use voice control.

- "Navigate home" – Show route description to the address stored in Maps as home address for the Google account used for login.
- "Read my messages." – Reads out text messages sent to the phone.
- "Raise the temperature" – Raises the temperature in the passenger compartment.
- "Play music" – Plays back music in selected media app.

Being logged in with a Google account means that the assistant is more personalised when the car is connected to the internet. For example, it is possible to call contacts stored in [contacts.google.com \[https://contacts.google.com/\]](https://contacts.google.com/) or ask about entries in Google Calendar.

i Note

Google Assistant is not yet available in all languages. Read more at [support.google.com \[https://support.google.com/\]](https://support.google.com/) for availability or, if possible, try another language.

i Note

The instructions above are general descriptions and include third-party suppliers. Availability, procedure and functionality are subject to change or variation.

[1] "Hey Google" only works in certain languages.

[2] When a voice command is used to start the system, you will only hear the audible signal if you pause before you continue your request.

4.6. Displays and controls by the driver in a left-hand drive car

The overviews show where the displays and controls near the driver are located.

Steering wheel and instrument panel

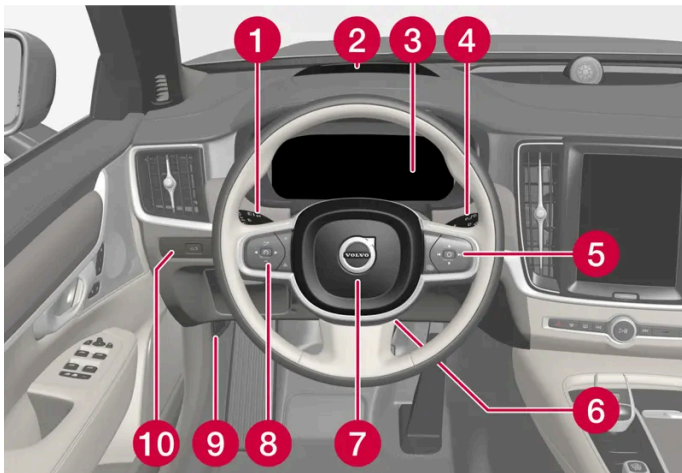



- 1 Position lamps, daytime running lights, dipped beam, main beam, direction indicators, front fog lamps/cornering lights*, rear fog lamp, resetting the trip meter
- 2 Head-up display*
- 3 Driver display
- 4 Wipers and washing, rain sensor*
- 5 Right-hand steering wheel keypad
- 6 Steering wheel adjustment
- 7 Horn

The content of this manual represents the status of the user manual at the time of printing and may not be completely valid in future instances. For more information, refer to the first page for the complete disclaimer note.

- 8 Left-hand steering wheel keypad
- 9 Bonnet opening
- 10 Unlocking/opening*/closing* of tailgate

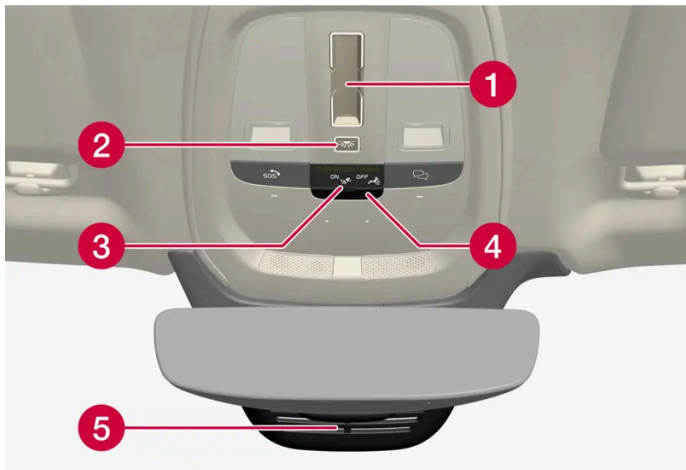
Roof console



- 1 Panoramic roof*
- 2 Front reading lamps and interior lighting
- 3 Display in roof console,  button*
- 4 Flap for SIM card
- 5 Manual dimming of interior rearview mirror ^[1]

Centre and tunnel console

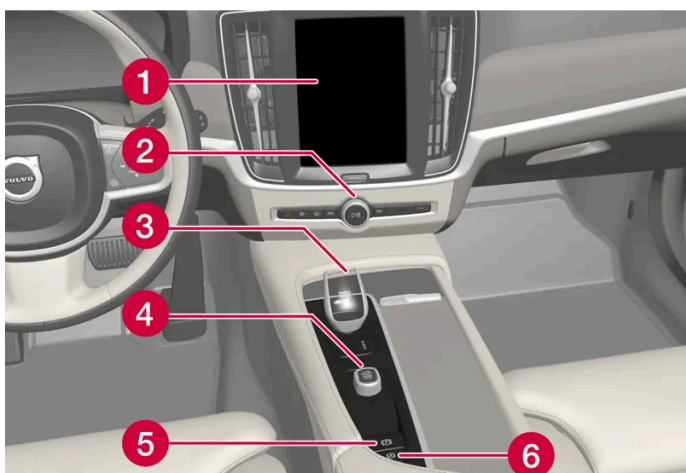

- 1 Centre display
- 2 Hazard warning flashers, defrosting, media
- 3 Gear selector
- 4 Start knob
- 5 Parking brake
- 6 Automatic brake when stationary

Driver's door

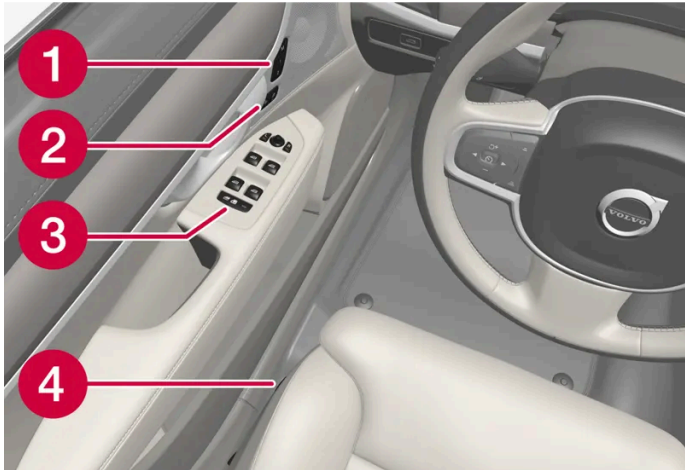

- 1 Memories for power front seat*, door mirror and head-up display* settings
- 2 Central locking
- 3 Power windows, door mirrors and child locks*
- 4 Adjusting front seat

* Option/accessory.

[1] There are no controls for manual dimming for cars with automatic dimming.

4.7. Displays and controls by the driver in a right-hand drive car

The overviews show where the displays and controls near the driver are located.

Steering wheel and instrument panel

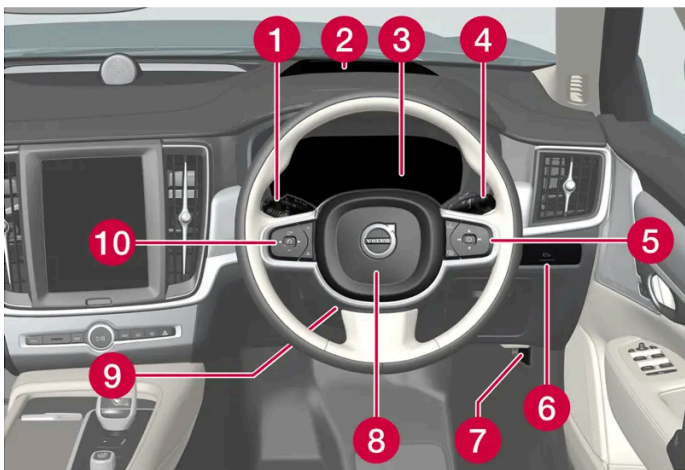

- 1 Position lamps, daytime running lights, dipped beam, main beam, direction indicators, front fog lamps/cornering lights*, rear fog lamp, resetting the trip meter

The content of this manual represents the status of the user manual at the time of printing and may not be completely valid in future instances. For more information, refer to the first page for the complete disclaimer note.

- 2 Head-up display*
- 3 Driver display
- 4 Wipers and washing, rain sensor*
- 5 Right-hand steering wheel keypad
- 6 Unlocking/opening*/closing* of tailgate
- 7 Bonnet opening
- 8 Horn
- 9 Steering wheel adjustment
- 10 Left-hand steering wheel keypad

Roof console

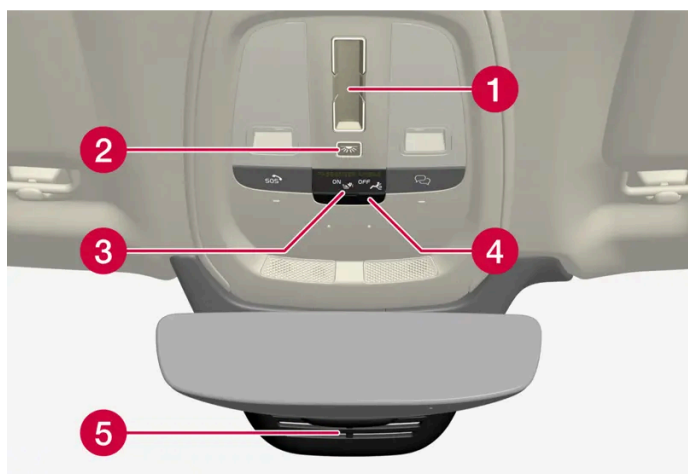

- 1 Panoramic roof*
- 2 Front reading lamps and interior lighting
- 3 Display in roof console, button*
- 4 Flap for SIM card
- 5 Manual dimming of interior rearview mirror ^[1]

Centre and tunnel console

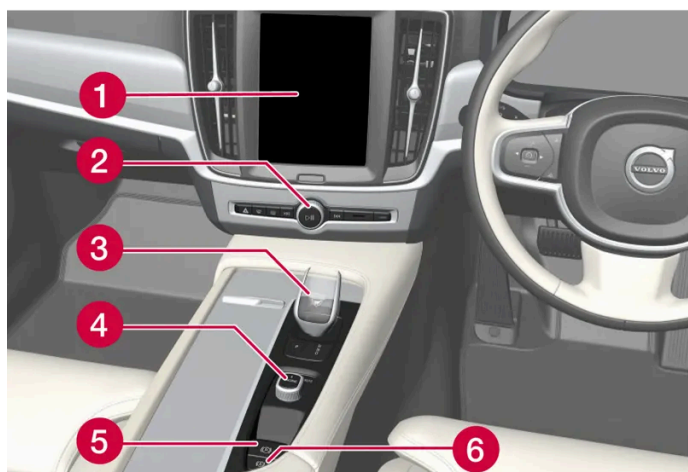

- 1 Centre display

The content of this manual represents the status of the user manual at the time of printing and may not be completely valid in future instances. For more information, refer to the first page for the complete disclaimer note.

- ② Hazard warning flashers, defrosting, media
- ③ Gear selector
- ④ Start knob
- ⑤ Parking brake
- ⑥ Automatic brake when stationary

Driver's door

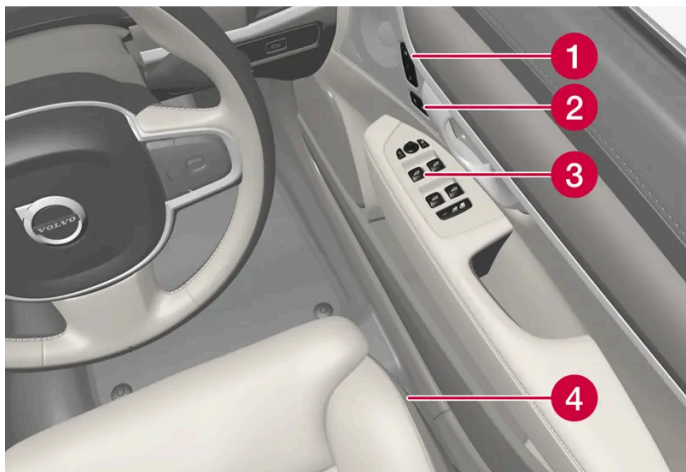

- ① Memories for power front seat*, door mirror and head-up display* settings
- ② Central locking
- ③ Power windows, door mirrors, electric child lock*
- ④ Adjusting front seat

* Option/accessory.

[1] There are no controls for manual dimming for cars with automatic dimming.

5. Lighting

5.1. Exterior lighting

5.1.1. Active bending lights *

Active bending lights are designed to provide additional illumination in bends and junctions. Cars with LED^[1] headlamps* can have active bending lights, depending on the car's equipment level.

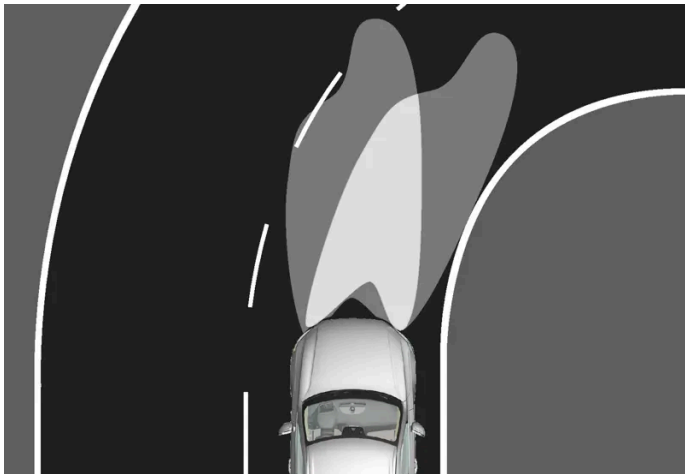

Headlamp pattern without active bending lights (left) and with active bending lights (right).

Active bending lights follow steering wheel movements to provide additional illumination in bends and junctions and can thereby provide the driver with improved visibility.

In the event of a fault in the function, the  symbol illuminates in the driver display at the same time as the driver display shows an explanatory text.

The active bending lights are only switched on in weak daylight or in darkness as well as when the stalk switch's rotating ring is in AUTO position. The car also needs to be in motion with the dipped beam activated.

* Option/accessory.

^[1] LED (Light Emitting Diode)

5.1.2. Active main beam



Active main beam uses the camera sensor in the upper edge of the windscreen. The camera sensor registers the headlamp beams from oncoming traffic or the rear lights of vehicles ahead, and then switches from main beam to dipped beam.



The symbol  represents active main beam.

The function can start while driving in the dark when the car's speed is approx. 20 km/h (approx. 12 mph) or higher. The function can also take streetlights into account. When the camera sensor no longer detects any oncoming car or car in front, main beam is switched on again after about a second.

Activate active main beam

Active main beam is activated and deactivated by turning the left-hand stalk switch to position . The rotating ring then returns to position **AUTO**. When active main beam is activated, the symbol  illuminates with a white glow in the driver display. When main beam is activated, the symbol shines blue.

If active main beam is deactivated while main beam is on, the lighting is immediately reset to dipped beam.

Active main beam does not need to be reactivated every time the car is started.

Adaptive functionality*

The active main beam has adaptive functionality^[1]. In this case, unlike what happens during conventional dimming, the light beam continues to illuminate with main beam on both sides of oncoming traffic or vehicles ahead – only the part of the light beam that points directly to the vehicle is dimmed.

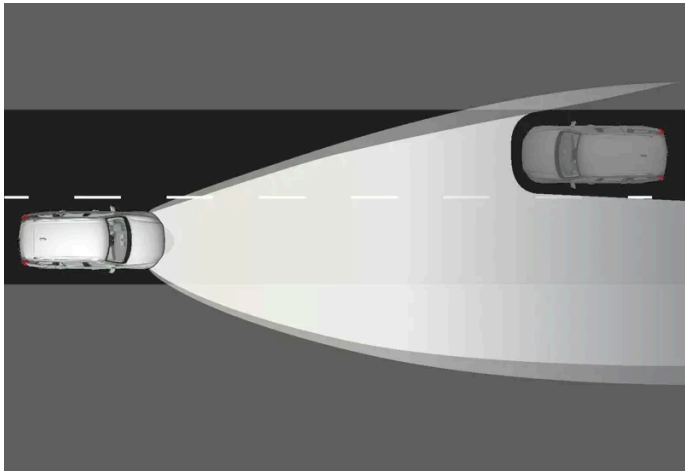

Adaptive functionality: Dipped beam directly towards oncoming vehicle, but continued main beam on both sides of the vehicle.

The main beam is partly dimmed, i.e. if the light beam shines with slightly more than dipped beam, the symbol  in the driver display shines blue.

On motorways or at high speed, the system may change from adaptive to automatic functionality.

Limitations for active main beam

The camera sensor on which the function is based has limitations.



If this symbol is shown in the driver display, together with the message **Active High Beam Temporarily unavailable**, then switching between main and dipped beam must be performed manually.



The same applies if this symbol is shown together with the message **Windscreen sensor blocked See Owner's manual**.

Active main beam may be temporarily unavailable e.g. in situations with dense fog or heavy rain. When active main beam becomes available again, or the windscreen sensors are no longer blocked, the message is extinguished and active main beam is reactivated.

Warning

Active main beam is an aid for using the optimum beam pattern when conditions are favourable.

The driver always bears responsibility for manually switching between main and dipped beam when traffic situations or weather conditions so require.

* Option/accessory.

^[1] Depending on the car's equipment level.

5.1.3. Using direction indicators

The car's direction indicators are operated with the left-hand stalk switch. The direction indicator lamps flash three times or continuously, depending on how far up or down the stalk switch is moved.

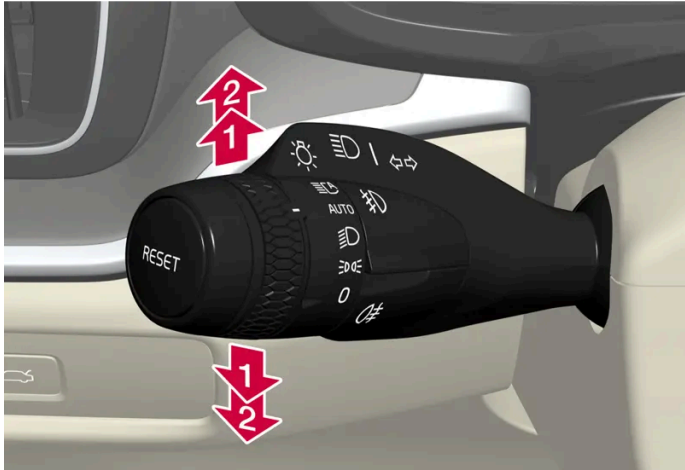

Direction indicators.

Short flash sequence

➡ Move the stalk switch up or down to the first position and release. The direction indicator lamps flash three times.

Note

This automatic flashing sequence can be stopped by moving the stalk switch immediately in the opposite direction.

Continuous flash sequence

➡ Move the stalk switch up or down to its end position.

The stalk switch remains in its position and is moved back manually, or automatically by the steering wheel movement.

Note

If the symbol for direction indicators in the driver display flashes more quickly than normal - see the message in the driver display.

5.1.4. Brake lights

The brake light automatically comes on during braking.

The brake light is illuminated when the brake pedal is depressed and when the car is braked automatically by one of the driver support systems.

5.1.5. Rear fog lamp

The rear fog lamp is considerably stronger than the normal rear lights and should only be used in reduced visibility due to fog, snow, smoke or dust so that other road users have an early warning of a vehicle ahead.

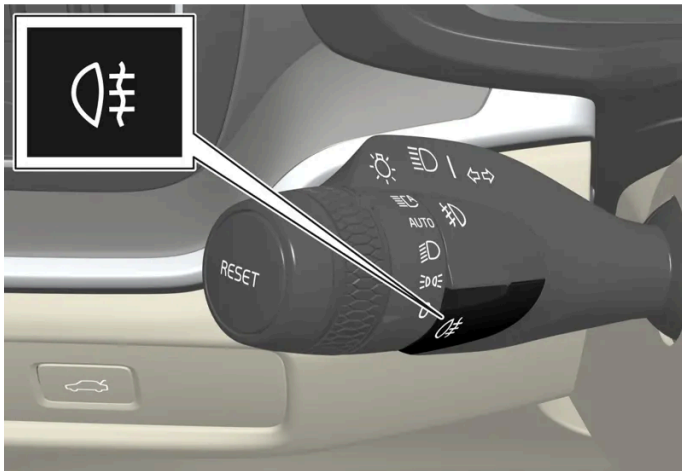

Button for rear fog lamp.

The rear fog lamp is a lamp at the rear of the car, on the driver's side.

The rear fog lamp can only be switched on when:

- ignition position II is active and the rotating ring on the stalk switch is in the **AUTO** or **☰D** position.
- ignition position II is active and the stalk switch's rotating ring is in **☰D** position and the front fog lamps are switched on.

Press the button to switch the lights on/off. The **☰D** symbol in the driver display illuminates when the rear fog lamp is switched on.

The rear fog lamp is switched off automatically when:

- the car is switched off or when the rotating ring on the stalk switch is set to the **0** position.
- the stalk switch's rotating ring is in position **☰D** and the front fog lamps are switched off.

i Note

Regulations on the use of rear fog lamps vary from country to country.



5.1.6. Front fog lamps and cornering lights *

The front fog lamps are activated manually when driving in fog and automatically when reversing in order to complement the reversing light.

If the car is fitted with cornering lights*, the front fog lamps come on automatically in dull daylight or darkness in order to light up the area diagonally in front of the car.



Button for front fog lamps.

The front fog lamps can only be switched on when the car's electrical system is in ignition position II and the rotating ring on the stalk switch is in position AUTO,  or .

Press the button to activate and deactivate. The  symbol illuminates in the driver display when the front fog lamps are switched on.

The front fog lamps switch off automatically when the car is switched off or when the rotating ring on the stalk switch is set to the  position.

 **Note**

Regulations on the use of fog lamps vary from country to country.

Cornering lights *

The front fog lamps can include the cornering lights function, which temporarily illuminates the area diagonally in front of the car in the direction the steering wheel is turned on a sharp bend, or in the direction shown by the direction indicators.

The function is activated in weak daylight or darkness when the stalk switch's rotating ring is in the AUTO or  position and the speed of the car is lower than approx. 30 km/h (approx. 20 mph).

In addition, both cornering lights are switched on as a supplement to the reversing lamp during reversing. They are extinguished when the car drives forward again.

* Option/accessory.

5.1.7. Dipped beam

The content of this manual represents the status of the user manual at the time of printing and may not be completely valid in future instances. For more information, refer to the first page for the complete disclaimer note.

When driving with the stalk switch's rotating ring in the **AUTO** position, dipped beam is activated automatically in weak daylight or darkness or when the car's electrical system is in ignition position II.

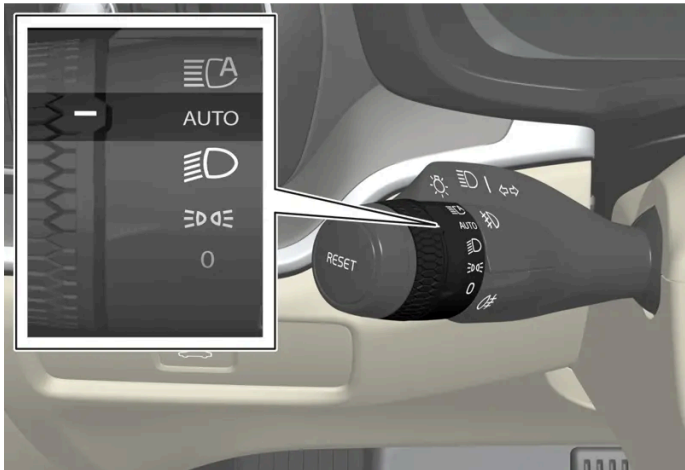

Stalk switch rotating ring in **AUTO** position.

With the stalk switch's rotating ring in **AUTO** position, dipped beam is also activated automatically if:

- the front fog lamps* are activated
- the rear fog lamp is activated
- the front and rear fog lamps are activated

With the stalk switch's rotating ring in the **D** position, dipped beam is always activated when the car's electrical system is in ignition position II.

Tunnel detection

The car detects when it is driven into a tunnel and switches from daytime running lights to dipped beam.

Note that the rotating ring in the left-hand stalk switch must be in **AUTO** mode for tunnel detection to work.

* Option/accessory.

5.1.8. Using main beam

Main beam is operated with the left-hand stalk switch. Main beam is the car's strongest lighting and should be used when driving in the dark for better visibility, as long as it does not dazzle other road users.

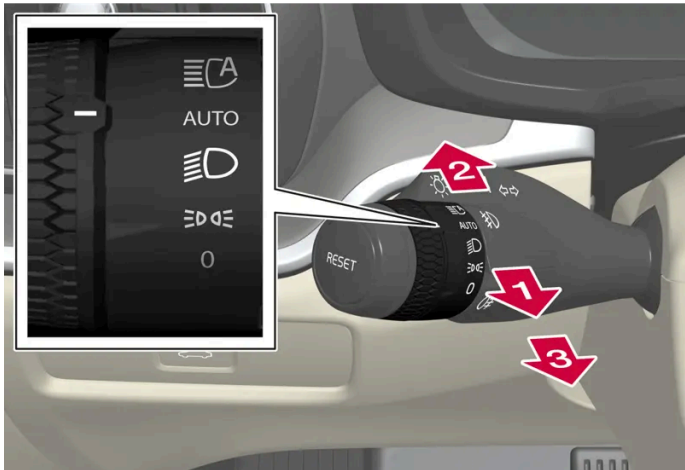

Steering wheel stalk switch with rotating ring.

Main beam flash

- ➔ Move the stalk switch backwards slightly to main beam flash position. Main beam comes on until the stalk switch is released.

Main beam

- ➔ Main beam can be activated when the steering wheel stalk switch's rotating ring is in position **AUTO**^[1] or . Activate main beam by moving the stalk switch forwards.
- ➔ Deactivate by moving the stalk switch backwards.

Note

When main beam has been activated, it can be deactivated by moving the stalk switch backwards to either **➔** position or **➔** position.

When main beam has been activated the symbol illuminates in the driver display.

^[1] When dipped beam is activated.

5.1.9. Using the guidance light

Some of the exterior lighting can be kept switched on to work as guidance light after the car has been locked.

To activate the function:

- 1 Make sure the car is switched off.

- 2 Move the left-hand stalk switch forward toward the instrument panel and release.
 - 3 Get out of the car and lock the door.
- The  symbol illuminates in the driver display to indicate that the function is activated and outer lighting is switched on: Position lamps, headlamp beams, number plate lighting and lighting in outer handles*.

The guidance light is illuminated for approximately 60 seconds.

* Option/accessory.

5.1.10. Adapting the headlamp pattern from the headlamps

This car does not need to reset the headlamp pattern when changing from right to left-hand traffic, and vice versa.

5.1.11. Emergency brake lights

Emergency brake lights are activated to alert vehicles behind about heavy braking.

The function means that the brake light flashes instead of - as in normal braking - shining with a constant glow.

The emergency brake lights are activated during heavy braking or if the ABS system is activated at high speeds.

After the driver brakes to a low speed and then releases the brake, the brake light returns to normal function and is extinguished.

The car's hazard warning flashers are activated at the same time. These flash until the driver accelerates the car to a higher speed again or switches off the car's hazard warning flashers.

5.1.12. Position lamps

Position lamps can be used so that other road users can see the car if it stops or is parked. The position lamp is switched on with the rotating ring on the stalk switch.



Stalk switch rotating ring in position lamps position.

Turn the rotating ring to the  position - the position lamps are switched on (number plate lighting is switched on at the same time).

If the car's electrical system is in ignition position II then the daytime running lights are switched on instead of the front position lamps. When the rotating ring is in this position, the rear position lamps are switched on regardless of the ignition position of the car's electrical system.

If the car is stationary but running, the rotating ring can be moved to the position lamp  position from another position to switch on only the position lamps instead of other lighting.

When driving for more than 30 seconds at max. 10 km/h (approx. 6 mph), or if the speed exceeds 10 km/h (approx. 6 mph), the daytime running lights are switched on. The driver should turn to a position other than .

If the tailgate is opened when it is dark outside, the rear position lamps come on (if not already switched on) to warn road users approaching from behind. This takes place irrespective of the position of the rotating ring or the ignition position of the car's electrical system.

Adaptive rear light function

The rear position lamps have an adaptive function. The brightness of the rear position lamps is adapted depending on the light conditions in the surroundings. When it is light outside, the rear position lamps are illuminate more brightly to make them more visible to other vehicles. When it is dark outside, the rear position lamps illuminate less brightly to avoid dazzling other vehicles.

Number plate lighting and trailer lighting are not affected by the adaptive function.

5.1.13. Welcome light

The welcome light comes on when the car is unlocked.

In daylight, position lamps, interior roof lamps, floor lights and cargo area lighting are activated. In weak daylight or darkness, number plate lighting and lighting in the outer handles are also activated* with their light source aimed towards the ground.

The lighting stays on for approx. 2 minutes if no doors are opened. If a door is opened within the activation time, the time for the interior lighting and lighting in the outer handles* will be extended.

The function can be activated and deactivated via the centre display.

* Option/accessory.

5.1.14. Hazard warning flashers

Hazard warning flashers warn other road users by means of all of the car's direction indicators being activated simultaneously. The function can be used to give a warning in the event of traffic hazards.



Button for hazard warning flashers.

Press the button to activate the hazard warning flashers.

The hazard warning flashers are automatically activated when the car brakes so powerfully that the emergency brake lights are activated and the speed is low. The hazard warning flashers start to flash after the emergency brake lights have stopped flashing and are then deactivated automatically when the car drives away again or are deactivated if the button is depressed.

The hazard warning flashers are automatically activated in the event of a collision.

i Note

Regulations for the use of hazard warning flashers may vary between countries.

5.1.15. Daytime running lights

The car has sensors that detect the light conditions in the surroundings. The daytime running light can only be activated when the car's electrical system is in ignition position II and the rotating ring on the stalk switch

is in position 0,  or AUTO. In position AUTO, the headlamps change automatically to dipped beam in weak daylight or darkness.



Stalk switch rotating ring in AUTO position.

If the stalk switch rotating ring is in the AUTO position, the daytime running lights (DRL ^[1]) are switched on when the car is driven in daylight. The car automatically changes lighting from daytime running light to dipped beam in weak daylight or darkness. Changing to dipped beam also takes place if the front fog lamp* and/or rear fog lamp are activated.

 **Warning**

This system help to save energy - it cannot determine in all situations when daylight is too weak or sufficiently strong, e.g. in mist and rain.

The driver is always responsible for ensuring that the car is driven with the correct beam pattern for the traffic situation and in accordance with applicable traffic regulations.

^[1] Daytime Running Lights

* Option/accessory.

5.1.16. Checking trailer lamps *

When connecting a trailer – check that the trailer lamps work before departure.

Checking trailer lamps *

Automatic checking

After a trailer is connected electrically, it is possible to ensure that the trailer lamps are working via an automatic lamp activation. The function helps the driver check that the trailer lamps are working before starting off.

- 1 When a trailer is connected to the towbar, the **Perform a trailer lamp check?** message is shown in the driver display.

- 2 Confirm the message by pressing the right-hand steering wheel keypad's **O** button.
 - The lamp check starts.
- 3 Exit the car to check lamp functionality.
 - All trailer lamps start to flash - then the lamps are switched on one at a time.
- 4 Visually check that all lamps available on the trailer are operational.
- 5 After a moment, all lamps on the trailer flash again.
 - The check is complete.

Rear fog lamp on trailer

When connecting a trailer, there may be instances when the rear fog lamp on the car does not illuminate. In these cases, rear fog lamp functionality is transferred to only the trailer. Therefore, in these cases, check when the rear fog lamp is activated that the trailer is equipped with rear fog lamp in order to drive the vehicle combination in a safe manner.

Symbols and messages in the driver display

If one or more of the trailer's direction indicators or brake light bulbs is broken, the driver display shows a symbol and a message. Other lights on the trailer must be checked manually by the driver before setting off.

Symbol	Message
	Right trailer turn indicator malfunction Left trailer turn indicator malfunction
	Trailer brake light malfunction

If any lamp for the trailer's direction indicators is broken, the driver display symbol for direction indicators will also flash more quickly than normal.

* Option/accessory.

5.2. Interior lighting

5.2.1. Interior lighting

The passenger compartment is equipped with several types of lighting, e.g. general interior lighting, adjustable interior lighting and reading lighting.

Front roof lighting

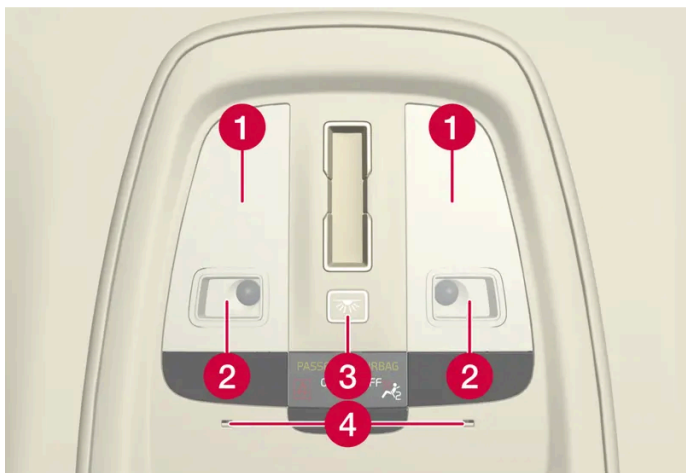

Lighting and controls in the roof console.

- 1 General interior lighting
- 2 Reading lamp
- 3 Button for passenger compartment lighting and automatic passenger compartment lighting
- 4 Ambience lights

Reading lighting

The reading lamps in the roof console are switched on or off by pressing each reading lamp gently and briefly. Brightness can be adjusted by pressing and holding the lamp.

Passenger compartment lighting

The floor lighting and general interior lighting are switched on or off with a short press on the button for passenger compartment lighting in the roof console.

Auto function for passenger compartment lighting

The automatic system is activated and deactivated by holding down the passenger compartment lighting button. When the button shines

- white, the automatic system is activated
- orange, the automatic system is deactivated.

When the automatic system is activated, the passenger compartment lighting is switched on as described below.

The passenger compartment lighting comes on when

- the car is unlocked
- a side door is opened.

The passenger compartment lighting goes off when

- the car is locked
- battery saver mode is activated.

The content of this manual represents the status of the user manual at the time of printing and may not be completely valid in future instances. For more information, refer to the first page for the complete disclaimer note.

Rear roof lighting

The rear area of the car has reading lighting, which is also used as general lighting.



Reading lamps above the rear seat.



In cars with a panorama roof*, the two lamp units are located on either side of the roof.

The reading lamps are switched on or off by gently and briefly pressing the lamp. Brightness can be adjusted by pressing and holding the lamp.

Glovebox lighting

Glovebox lighting is switched on and off respectively when the lid is opened or closed.

Sun visor mirror lighting*

The lighting for the mirror in the sun visor is switched on and off respectively when the cover is opened or closed.

Ground lighting*

The ground lighting is switched on or off when the corresponding door is opened or closed.

Door sill lighting

The door sill lighting is switched on or off when a door is opened or closed.

Lighting in the cargo area

The lighting in the cargo area is switched on or off when the tailgate is opened or closed.

Interior lighting

You can adjust a number of ambient light sources in the car's interior via the centre display.

Lighting in storage compartments in doors

The lighting in the storage compartments in the doors comes on when the car is unlocked and goes off when it is locked. You can precisely adjust brightness via the centre display.

Lighting in the tunnel console's front cup holder*

The lighting in the front cup holders is switched on when the car is unlocked and is switched off when the car is locked. You can precisely adjust brightness via the centre display.

* Option/accessory.

5.2.2. Adjusting interior lighting

The lamps inside the car come on differently depending on the ignition position used. You can adjust the interior lighting via the centre display.

Adjusting interior lighting via the centre display

- 1 Press  in the centre display.
- 2 Then tap on **Controls**.
- 3 Adjust the required setting for interior lighting.

5.3. Adjusting light functions via the centre display

Light functions can be adjusted and activated via the centre display.

- 1 Press  in the centre display.
- 2 Then tap on **Controls**.
- 3 Adjust the required function for interior or exterior lighting.

5.4. Lighting control

The different lighting controls are used to control both exterior and interior lighting. The left-hand stalk switch activates and adjusts the exterior lighting. You can both activate and adjust the exterior and interior lighting via the centre display.



Exterior lighting



Rotating ring in the left-hand stalk switch.

When the car's electrical system is in ignition position II, the following functions are available for the rotating ring's different positions:

Position	Specification
0	Daytime running lights. Main beam flash can be used.
	Daytime running lights and position lamps. Position lamps when the car is parked. ^[1] Main beam flash can be used.
	Dipped beam and position lamps. Main beam can be activated. Main beam flash can be used.
AUTO	Front daytime running lights and rear position lamps in daylight. Dipped beam and position lamps in weak daylight or darkness, or when the front fog lamp* and/or rear fog lamp are activated. The Active main beam function can be activated. Main beam can be activated when dipped beam is switched on. Main beam flash can be used.
	Active main beam on/off.

Volvo recommends that **AUTO** mode is used when the vehicle is driven.

Warning

The car's lighting system is not able to determine when daylight is too weak or sufficiently strong, e.g. in fog and rain, in all situations.

The driver is always responsible for ensuring that the car is driven with a beam pattern suitable for the traffic situation and in accordance with applicable traffic regulations.

Note

Outside lighting such as headlamps and rear lamps may temporarily have condensation on the inside of the lens. This is normal and all exterior lighting is designed to withstand this. Condensation is normally vented out of the lamp housing when the lamp has been switched on for a time.

Exterior and interior lighting

You can adjust the exterior and interior lighting in the centre display.

[1] If the car is stationary but running, the rotating ring can be moved to  position from another position to switch on only the position lamps instead of other lighting.

* Option/accessory.

6. Windows, glass and mirrors

6.1. Rearview mirrors

6.1.1. HomeLink® *

HomeLink®^{[1] [2]} is a programmable remote control integrated into the car's electrical system. It can control up to three different devices remotely, e.g. a garage door opener or alarm system, and hence replace the remote controls for these.

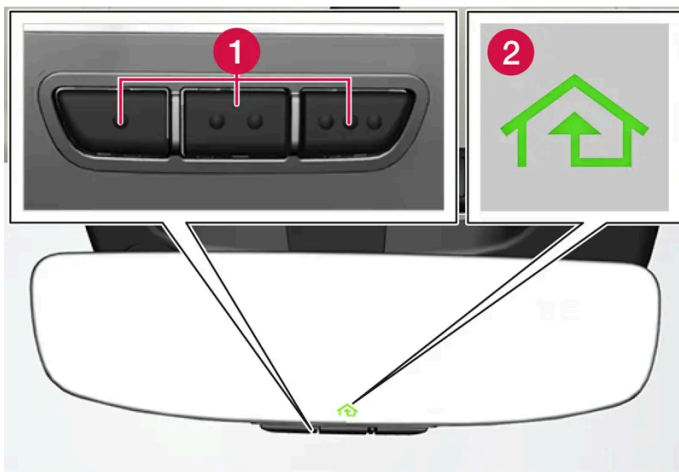

The figure is schematic - the version may vary.

- 1 Programmable buttons
- 2 Indicator lamp

HomeLink® is built into the interior rearview mirror and consists of three programmable buttons and one indicator lamp in the mirror glass.

Note

Save the original remote controls for future reprogramming (e.g. when changing to another car or for use in another vehicle).

It is also recommended that the programming for the buttons should be deleted when the car is sold.

More information

Visit homelink.com or call 00 8000 466 354 65 (or premium charge number +49 6838 907 277)^[3].

* Option/accessory.

[1] Applies to certain markets.

[2] HomeLink and the HomeLink house symbol are registered trademarks of Gentex Corporation.

[3] Note that the toll-free number may not be available depending on operator.

6.1.2. Rearview and door mirrors

The rearview mirrors and door mirrors can be used to give the driver better visibility to the rear.

Interior rearview mirror

The interior rearview mirror is equipped with HomeLink* and automatic dimming*.

The interior rearview mirror is adjusted by angling it manually.

Door mirrors



Both mirrors are bent to provide optimal vision. Objects may appear to be further away than they actually are.

The door mirror positions are adjusted with the joystick in the driver's door control panel.

There are also a number of automatic settings that can be linked to the memory function buttons for the power seat*.

* Option/accessory.

6.1.3. Angling adjustment of the door mirrors

To ensure better visibility to the rear, the door mirrors need to be set to the preferences of the driver.

There are a number of automatic settings that can also be linked to the memory function buttons for the power seat*.

Using controls for door mirrors

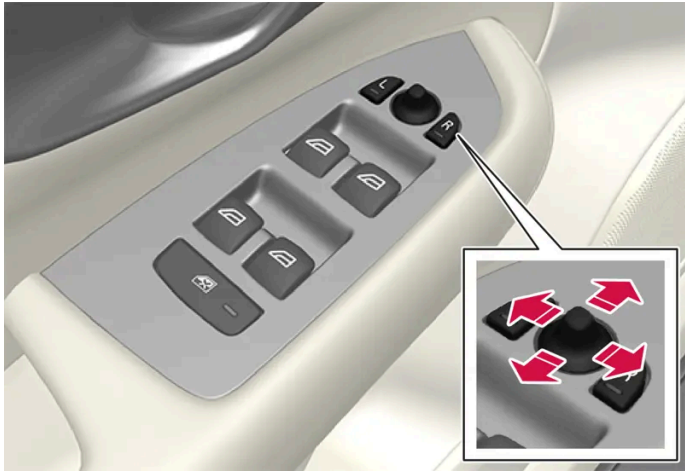

Controls for door mirrors.

The door mirror positions are adjusted with the joystick in the driver's door control panel. The car must be in usage mode Comfort or higher.

- 1 Press the L button for the left-hand door mirror or the R button for the right-hand door mirror. The light in the button illuminates.
- 2 Adjust the position with the joystick in the centre.
- 3 Press the L or R button again. The light should no longer be illuminated.

Fold in rearview mirrors electrically*

The mirrors can be retracted for parking/driving in narrow spaces.

- 1 Depress the L and R buttons simultaneously.
- 2 Release them after approximately 1 second. The mirrors automatically stop in the fully retracted position.

Fold out the mirrors by pressing down the L and R buttons simultaneously. The mirrors automatically stop in the extended position with the previous setting.

Automatic retraction when locking*

The door mirrors are automatically retracted/extended when the car is locked/unlocked using the key. The function can be deactivated via the centre display.

 **Note**

If the mirrors are retracted manually using the L and R buttons, and the car is then locked, the mirrors will not be extended automatically when the car is unlocked, even if this setting has been made. Extending must be carried out manually using the L and R buttons.

Resetting to neutral

Mirrors that have been moved out of position due to external influences, such as being frozen in the retracted position and manually unfolded, must be electrically reset to their original position for the electrical retraction/extension* to work properly.

- 1 Fold in the door mirrors by pressing down the L and R buttons simultaneously.
- 2 Fold them out again by pressing the L and R buttons simultaneously.
- 3 Repeat the above procedure as necessary.

The mirrors are reset to neutral position and electrical retraction and extension work again.

Angling during parking^[1]

A door mirror can be angled down for the driver to view the side of the road when parking, for example.

- 1 Engage reverse gear and press the L or R button.

Note that the button needs to be pressed twice. The button flashes when the door mirror is angled down. When reverse gear is engaged, the door mirror automatically returns to its original position.

Automatic angling during parking^[1]

With this setting, the door mirrors are automatically angled down when reverse gear is selected. The folded position is preset and cannot be adjusted.

- 1 Press  in the centre display.
- 2 Press **Controls**.
- 3 Select the desired setting under **Exterior mirrors tilt when reversing**.

You can make the door mirrors return to their original positions by pressing the L or R button twice.

* Option/accessory.

^[1] Only in combination with power seat with memory buttons*.

6.1.4. Adjusting rearview mirror dimming

Bright light from behind could be reflected in the rearview mirrors and dazzle the driver. Use dimming when disturbed by light from behind.

Automatic dimming*

If bright light comes from behind, the rearview mirrors automatically dim when it is dark outside or when the light is limited, for example when driving in tunnels.

It is possible to set whether automatic dimming should be active during driving or not via the centre display.

- 1 Press  in the centre display.
- 2 Press **Controls**.
- 3 Select the desired setting under **Mirror auto-dimming**.

Dimming is adjusted automatically using light sensors in the interior rearview mirror.

Note

If the sensors are obscured by e.g. parking permits, transponders, sun visors or objects in the seats or in the cargo area in such a way that light is prevented from reaching the sensors, then the dimming function of the interior rearview and door mirrors is reduced.

* Option/accessory.

6.1.5. Using a stored position for seat, door mirrors and head-up display*

If the positions for the power* seat, the door mirrors and the head-up display* have been stored, they can be activated by using the memory buttons.^[1]

Using a stored setting

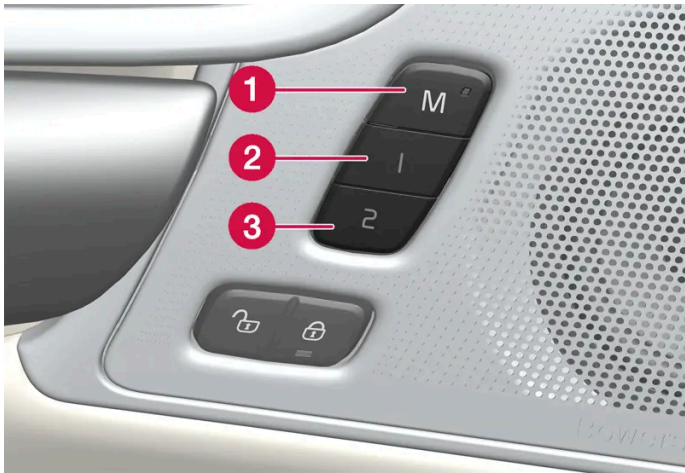

A stored setting can be used with the front door either open or closed:

Open front door

- 1 Depress one of the memory buttons 1 (2) or 2 (3) with a short press. Power seat, door mirrors and head-up display move and then stop at the positions stored in the selected memory button.

Closed front door

- 1 Hold one of the memory buttons 1 (2) or 2 (3) depressed until seat, door mirrors and head-up display stop in the positions that are stored in the selected memory button.

If the memory button is released, the movement of the seat, door mirrors and head-up display will be stopped.

Warning

- Because the driver's seat can be adjusted with the ignition off, children should never be left unattended in the vehicle.
- Movement of the seat can be STOPPED at any time by pressing any button on the power seat control panel.
- Do not adjust the seat while driving.
- Make sure there is nothing under the seats when they are being adjusted.

* Option/accessory.

[1] The last position is also saved automatically in the active user profile and will be used next time the same profile is used again.

6.1.6. Storing position for seat, door mirrors and head-up display*

You can store the position for power* seat, door mirrors and head-up display* in the memory buttons. ^[1]

Store two different positions for the power* seat, the door mirrors and the head-up display* using the memory buttons. The buttons are located on the inside of one of the front doors or both*.

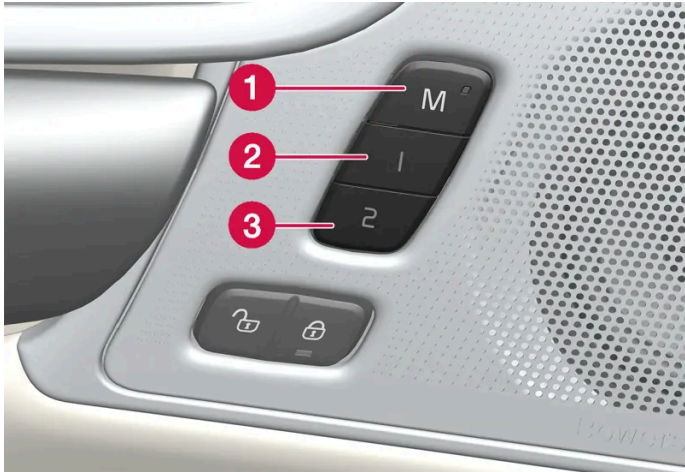

- 1 Button **M** for storing settings.
- 2 Memory button 1.
- 3 Memory button 2.

Storing a position

- 1 Adjust seat, door mirrors and head-up display to the desired position.
- 2 Press and hold the **M** button depressed. The light indicator in the button illuminates.
- 3 Press and hold the **1** or **2** button within three seconds.
 - When the position has been stored in the selected memory button, an acoustic signal can be heard and the light indicator in the **M** button extinguishes.

If none of the memory buttons is depressed within three seconds then the **M** button extinguishes and no storing takes place.

The seat, the door mirrors or the head-up-display must be readjusted before a new memory can be set.

Note

The stored positions are saved in the active profile.

* Option/accessory.

^[1] The current position is also saved automatically in the active user profile.

6.1.7. Activating and deactivating the heated rear window and door mirrors

The heated rear window and door mirrors are used to quickly remove mist and ice from the windows and mirrors.

Activating and deactivating heated rear window and door mirrors from centre console

In the centre console is a physical button for rapid access to the heated rear window and door mirrors.



Physical button in the centre console.

- 1 Press the button.
 - > Heated rear window and door mirrors are activated/deactivated and the button illuminates/extinguishes.

Activating and deactivating heated rear window and door mirrors from centre display

- 1 Open the climate view in the centre display by tapping on the temperature button at the bottom centre of the centre display.



Tap on the button for the heated rear window and door mirrors.

- > Heated rear window and door mirrors are activated/deactivated and the button illuminates/extinguishes.

6.1.8. Activating and deactivating automatic starting of the heated rear window and door mirrors

The heated rear window and door mirrors are used to quickly remove mist and ice from the windows and mirrors.

It is possible to set whether automatic starting of the heated rear window and door mirrors should be activated/deactivated when the driver is in the car when starting the car.^[1] With automatic starting activated, electric heating will start when there is a risk of ice or misting on the window. The heating switches off automatically when the windscreen/window is sufficiently warm and the ice or misting is gone.

- 1 Open the climate view in the centre display by tapping on the temperature button at the bottom centre of the centre display.
- 2 Press ...
- 3 Select the desired setting under **Auto rear defroster** to activate/deactivate automatic start of heated rear window and door mirrors.

^[1] Usage mode Drive

6.2. Windscreen and rear window

6.2.1. Damaged windscreen

It is important to repair a damaged windscreen as soon as possible. Minor damage due to stone chips, for example, can often be repaired without replacing the entire windscreen. Volvo recommends that you contact an authorised Volvo workshop if the windscreen is damaged.

Minor glass damage

If possible, repair the damage within 24 hours in order to avoid it getting worse. If there is minor damage to the windscreen, a windscreen stone chip sticker can protect the area from dust and dirt until it is repaired.

Major glass damage

In the event of major damage to the windscreen, the entire windscreen will need to be replaced.

 **Warning**

Do not drive the car if there is major damage to the windscreen. The damage can quickly get worse, obscure driver vision, and prevent the car from being driven safely.

Replacing the windscreen

It is important that the new windscreen and its installation meet Volvo's specifications for safety and compatibility with the car's functions. Volvo recommends an authorised Volvo workshop for windscreen replacement.

Replacing the windscreen in a car with Head-up display*

The windscreen in cars equipped with Head-up display is specially designed to be able to display the projected image. When replacing the windscreen, the correct type of glass needs to be used in order for the Head-up display to work.

* Option/accessory.

6.2.2. Wiper blades and washer fluid

Together with the washer fluid, the wipers aim to improve visibility as well as headlamp pattern.

The washer nozzles are heated* automatically in cold weather to prevent the washer fluid from freezing.

Information indicating that the washer fluid needs topping up appears in the driver display when there is approx. 1 litre (1 qt) of washer fluid remaining.



* Option/accessory.

6.2.3. Using the rear window wiper and rear window washer

The rear window wiper and rear window washer are designed to clean the rear window. Washing/wiping is started and settings are changed by means of the right-hand steering wheel stalk switch.

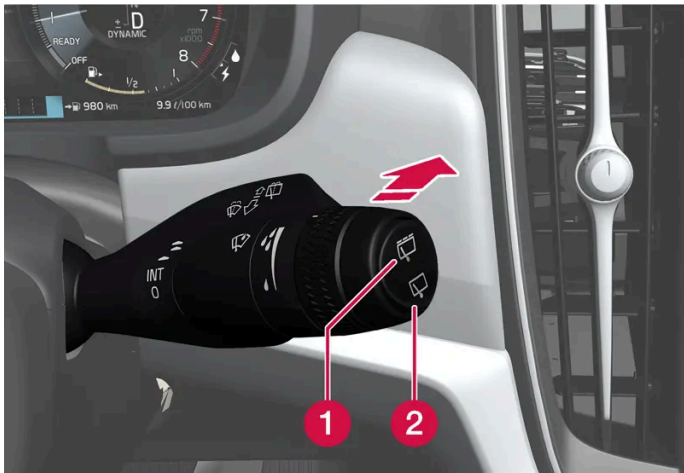
Activating the rear window wiper and rear window washer



- 1 Select  for intermittent wiping with the rear window wiper.
- 2 Select  for continuous speed with the rear window wiper.

- 1 Move the right-hand steering wheel stalk switch forward to start rear window washing and wiping.

Automatic rear windscreen wiping when reversing

Engaging reverse gear while the windscreen wipers are switched on initiates rear window wiping. The function stops when reverse gear is disengaged.

Note

In low outside temperature, the automatic rear window wiping when reversing is deactivated in order to avoid damage to the wiper arm.

6.2.4. Using the rain sensor

The rain sensor automatically starts the windscreen wipers based on how much water it detects on the windscreen. Rain sensor sensitivity can be adjusted with the thumbwheel on the right-hand stalk switch.

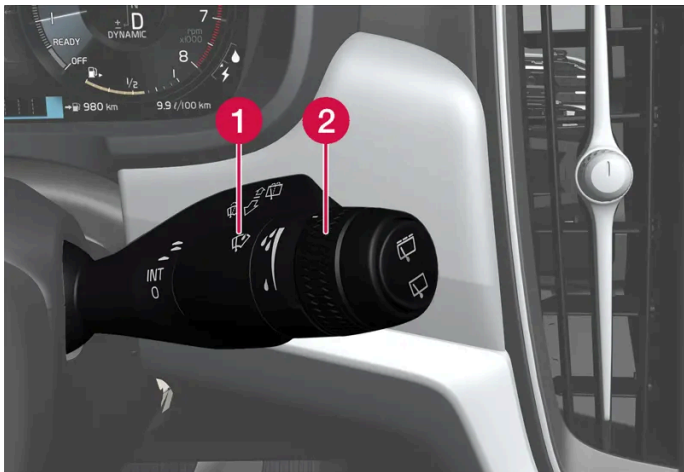

Right-hand stalk switch.

- 1 Rain sensor button
- 2 Thumbwheel sensitivity/frequency

When the rain sensor is activated, the rain sensor symbol  is shown in the driver display.

The rain sensor is automatically on or off when the car is started depending on rain sensor mode set when the car was switched off.

Activating the rain sensor

To activate the rain sensor, the windscreen wipers must be in position 0, or in the position for single sweep.

Activate the rain sensor by pressing the rain sensor button .

Move the lever down to make the wipers move.

Turn the thumbwheel upward for higher sensitivity and downward for lower sensitivity. An extra sweep is made when the thumbwheel is turned upward.

Deactivating the rain sensor

Deactivate the rain sensor by pressing the rain sensor button  or moving the stalk switch up to another wiper program.

The rain sensor is deactivated automatically when the car is switched off.

The rain sensor is deactivated automatically when wiper blades are set in service position. The rain sensor is reactivated when service mode has been deactivated.

Important

The windscreen wipers could start and be damaged in an automatic car wash. Switch off the rain sensor before washing the car. The symbol in the driver display extinguishes.

6.2.5. Using windscreen and headlamp washers

Windscreen and headlamp washers are designed to clean the windscreen and headlamps. Windscreen and headlamp washers are started using the right-hand stalk switch.

Starting windscreen and headlamp washers



Washing function, right-hand stalk switch.

- 1 Move the right-hand stalk switch toward the steering wheel to start the windscreen and headlamp washers.
 - The windscreen wipers will make several more sweeps once the stalk switch has been released.

! Important

Avoid activating the washer system when it is frozen or the washer reservoir is empty, otherwise there is a risk of damaging the pump.

Headlamp washing*

When activating windscreen washing, the headlamps are also cleaned automatically according to a defined interval, when the headlamps are switched on.

Reduced washing

If only approx. 1 litre (1 qt) of washer fluid remains in the reservoir and the message, Washer fluid **Refill washer fluid, level low**, together with the  symbol, is shown in the driver display, then the supply of washer fluid to the headlamps is switched off. This is to prioritise cleaning the windscreen and the visibility through it. The headlamps are only washed if main or dipped beam is switched on.

* Option/accessory.

6.2.6. Using windscreen wipers

The windscreen wipers are designed to clean the windscreen. Different settings for the windscreen wipers are set using the right-hand stalk switch.

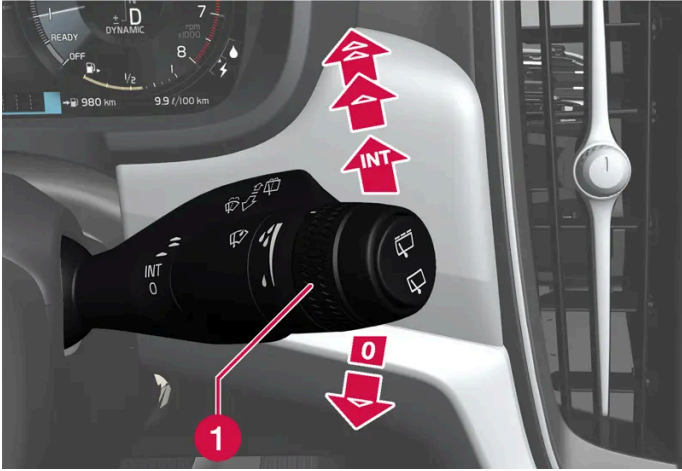

Right-hand stalk switch.

1 The thumbwheel is used to set rain sensor sensitivity and wiper swipe frequency.

Single sweep

- ▼ Lower the stalk switch and release to make one sweep.

Windscreen wipers off

- 0** Move the stalk switch to position 0 to switch off the windscreen wipers.

Intermittent wiping

- INT** Move the lever up to switch the wipers to intermittent wiping. Set the number of sweeps per time unit with the thumbwheel when intermittent wiping is selected.

Continuous wiping

- ▲ Raise the stalk switch for the wipers to sweep at normal speed.
- ▲ Raise the stalk switch further for the wipers to sweep at high speed.

! Important

Before activating the wipers - ensure that the wiper blades are not frozen in, and that any snow or ice on the windscreen and rear window is scraped away.

6.2.7. Activating and deactivating the heated rear window and door mirrors

The heated rear window and door mirrors are used to quickly remove mist and ice from the windows and mirrors.

Activating and deactivating heated rear window and door mirrors from centre console

In the centre console is a physical button for rapid access to the heated rear window and door mirrors.



Physical button in the centre console.

- 1 Press the button.
 - Heated rear window and door mirrors are activated/deactivated and the button illuminates/extinguishes.

Activating and deactivating heated rear window and door mirrors from centre display

- 1 Open the climate view in the centre display by tapping on the temperature button at the bottom centre of the centre display.



Tap on the button for the heated rear window and door mirrors.

- Heated rear window and door mirrors are activated/deactivated and the button illuminates/extinguishes.

6.2.8. Activating and deactivating automatic starting of the heated rear window and door mirrors

The heated rear window and door mirrors are used to quickly remove mist and ice from the windows and mirrors.

It is possible to set whether automatic starting of the heated rear window and door mirrors should be activated/deactivated when the driver is in the car when starting the car.^[1] With automatic starting activated, electric heating will start when there is a risk of ice or misting on the window. The heating switches off automatically when the windscreen/window is sufficiently warm and the ice or misting is gone.

- 1 Open the climate view in the centre display by tapping on the temperature button at the bottom centre of the centre display.
- 2 Press ...
- 3 Select the desired setting under **Auto rear defroster** to activate/deactivate automatic start of heated rear window and door mirrors.

^[1] Usage mode Drive

6.2.9. Activating and deactivating the heated windscreen *

A heated windscreen is used to quickly remove mist and ice from the window.

Activating and deactivating heated windscreen from centre console

In the centre console is a physical button for rapid access to the heated windscreen.



Physical button in the centre console.

1 Press the button repeatedly in order to switch between the three levels:

- Activated heated windscreen
- Activated heated windscreen and max defroster
- Deactivated.

➤ Heated windscreen and max defroster are activated/deactivated and the button illuminates/extinguishes.

Activating and deactivating heated windscreen from centre display

1 Open the climate view in the centre display by tapping on the temperature button at the bottom centre of the centre display.



Press the button for heated windscreen.

➤ Heated windscreen is activated/deactivated and the button illuminates/extinguishes.

***i* Note**

A triangular area at the end of each side of the windscreen is not electrically heated, where de-icing may take longer.

***i* Note**

The heated windscreen may affect the performance of transponders and other communication equipment.

* Option/accessory.

6.2.10. Activating and deactivating automatic start of heated windscreen*

A heated windscreen is used to quickly remove mist and ice from the window.

It is possible to set whether automatic start of heated windscreen should be activated/deactivated when the driver is in the car when starting the car ^[1]. With automatic start activated, heating will start when there is a risk of ice or misting on the

windscreen/window. The heating switches off automatically when the windscreen/window is sufficiently warm and the ice or misting is gone.

- 1 Open the climate view in the centre display by tapping on the temperature button at the bottom centre of the centre display.
- 2 Press ...
- 3 Select the desired setting under **Auto front defroster** to activate/deactivate automatic start of heated rear window and door mirrors.

* Option/accessory.

[1] Usage mode Drive

6.3. Side windows and panoramic roof

6.3.1. Power windows

Each door has a control panel for the electrically-driven power windows. The driver's door has controls for operating all windows and also to activate the child safety locks.

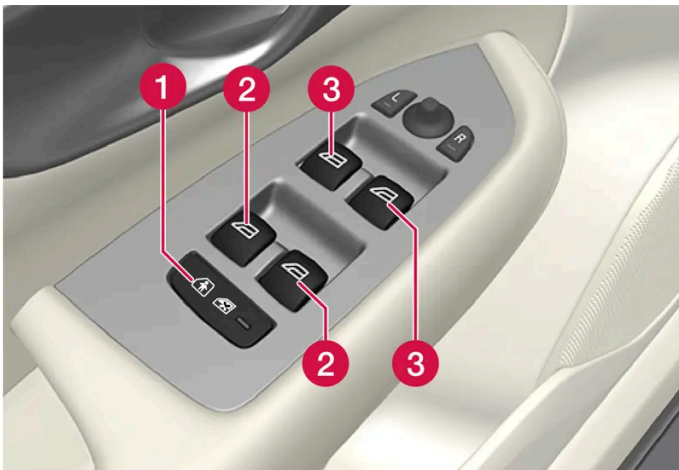

Driver's door control panel.

- 1 Electric child safety locks* that deactivate the controls in the rear doors to prevent doors or windows from being opened from the inside.
- 2 Controls for rear windows.
- 3 Controls for front windows.

 **Warning**

Children, other passengers or objects may be trapped by the moving parts.

- Always operate the windows with caution.
- Do not allow children to play with the controls.
- Never leave children alone in the car.
- Remember to always switch off the power supply to the power windows by setting the car's electrical system in ignition position 0, and then take the key with you when leaving the car.
- Never put an object or part of the body through the windows, even if the car's electrical system is fully disconnected.

* Option/accessory.

6.3.2. Operating power windows

Using the driver's door control panel, all power windows can be operated - using the control panels in the other doors operates the power window in the individual door.

The power windows are equipped with pinch protection. If any fault arises with the pinch protection, a reset sequence can be tested.

 **Warning**

Children, other passengers or objects may be trapped by the moving parts.

- Always operate the windows with caution.
- Do not allow children to play with the controls.
- Never leave children alone in the car.
- Remember to always switch off the power supply to the power windows by setting the car's electrical system in ignition position 0, and then take the key with you when leaving the car.
- Never put an object or part of the body through the windows, even if the car's electrical system is fully disconnected.



Operating the power windows.

- 1 Operating without auto. Move one of the controls gently up or down. The power windows move up or down as long as the control is held in position.
- 2 Operating with auto. Move one of the controls up or down to the end position and release it. The window runs automatically to its end position.

In order for the power windows to be used, the ignition position must be I or II. The power windows can be operated for a few minutes after the car has been switched off and after the ignition has been switched off - although not after a door has been opened. It is only possible to operate one control at a time.

It can also be operated using a key or keyless opening* with the door handle.

 **Warning**

Check that children or other passengers are not at risk of crushing when all the windows are closed with a key or keyless opening* with a door handle.

 **Note**

One way to reduce the pulsating wind noise when the rear windows are open is to also open the front windows slightly.

Note

The windows cannot be opened at speeds above approx. 180 km/h (approx. 112 mph), but they can be closed.

The driver always bears responsibility for following traffic regulations in force.

Note

It may not be possible to operate windows at low temperatures.

* Option/accessory.

6.3.3. Panoramic roof*

The panoramic roof is divided into two glass sections. The front section can be opened vertically at the rear edge (ventilation position) or horizontally (open position). The rear section is fixed roof glass.

The panoramic roof has a wind deflector and a sun blind made of perforated fabric and located under the glass roof to provide extra protection from factors such as strong sunlight.



The panoramic roof and sun blind are operated with a control located in the roof.

In order that the panoramic roof and the sun blind can be operated, the car must be in Comfort or Drive usage mode.

 **Warning**

Children, other passengers or objects may be trapped by the moving parts.

- Always operate the windows with caution.
- Do not allow children to play with the controls.
- Never leave children alone in the car.
- Remember to always switch off the power supply to the power windows by setting the car's electrical system in ignition position 0, and then take the key with you when leaving the car.
- Never put an object or part of the body through the windows, even if the car's electrical system is fully disconnected.

 **Important**

- Do not open the panoramic roof when load carriers are fitted.
- Do not place any heavy objects on the panoramic roof.

 **Important**

- Remove ice and snow before opening the panoramic roof. Take care not to scratch surfaces or damage strips.
- Do not operate the panoramic roof if it has frozen closed.

Wind deflector



The panoramic roof has a wind deflector that is raised when the panoramic roof is in the open position.

* Option/accessory.

6.3.4. Operating the panoramic roof*

The content of this manual represents the status of the user manual at the time of printing and may not be completely valid in future instances. For more information, refer to the first page for the complete disclaimer note.

The panoramic roof and sun blind are operated with a control in the roof panel and both are equipped with pinch protection.

 **Warning**

Children, other passengers or objects may be trapped by the moving parts.

- Always operate the windows with caution.
- Do not allow children to play with the controls.
- Never leave children alone in the car.
- Remember to always switch off the power supply to the power windows by setting the car's electrical system in ignition position 0, and then take the key with you when leaving the car.
- Never put an object or part of the body through the windows, even if the car's electrical system is fully disconnected.

 **Important**

- Do not open the panoramic roof when load carriers are fitted.
- Do not place any heavy objects on the panoramic roof.

 **Important**

- Remove ice and snow before opening the panoramic roof. Take care not to scratch surfaces or damage strips.
- Do not operate the panoramic roof if it has frozen closed.

In order that the panoramic roof and the sun blind can be operated, the car must be in Comfort or Drive usage mode.

It can also be operated using a key or keyless opening* with the door handle.

 **Warning**

Check that children or other passengers are not at risk of crushing when all the windows are closed with a key or keyless opening* with a door handle.

 **Important**

Check that the panoramic roof is properly closed when closing.

The panoramic roof and the sun blind are also equipped with pinch protection. If any fault arises with the pinch protection, a reset sequence can be tested.

Note

It may not be possible to operate windows at low temperatures.

Open and close the panoramic roof to/from ventilation position using the roof control

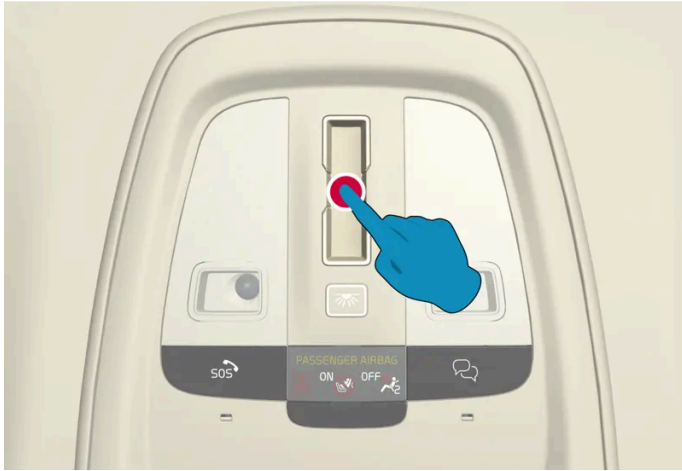

Ventilation position, vertically at the rear edge.

Open and close by tapping once anywhere on the touch-sensitive control.

When the ventilation position is selected the front glass cover is raised at its rear edge. If the sun blind is fully closed when ventilation position is selected, then it opens automatically approx. 150 mm (approx. 6 inches).

The sun blind follows automatically if the panoramic roof is closed from ventilation position.

Fully open and close the panoramic roof using the roof control

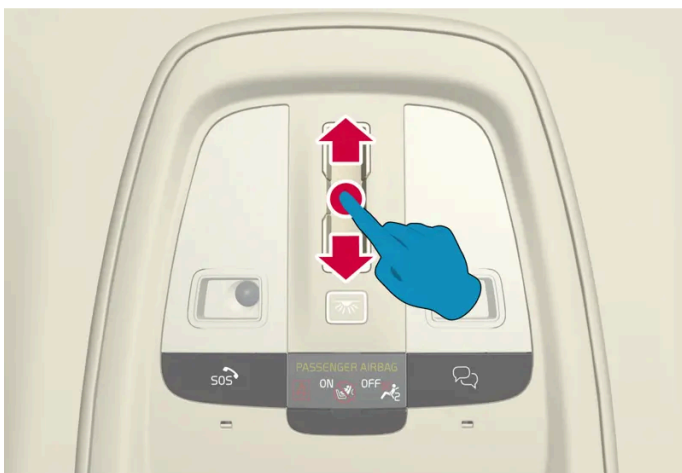

Make a smooth and continuous swiping motion backwards/forwards over the touch-sensitive control to fully open/close the panoramic roof. In the event of problems, try moving more quickly or more slowly.

Automatic operation

- 1 Open the sun blind to maximum position – swipe once backwards over the control.

The content of this manual represents the status of the user manual at the time of printing and may not be completely valid in future instances. For more information, refer to the first page for the complete disclaimer note.

- 2 Open the panoramic roof to comfort position – swipe backwards a second time over the control.
- 3 Open the panoramic roof to maximum position – swipe backwards a third time over the control.

Close by swiping forwards twice over the control.

Automatic operation - rapid opening or closing

The panoramic roof and sun blind can be opened or closed simultaneously:

- 1 Open – swipe twice backwards over the control. You do not need wait for the sun blind to fully open before you swipe a second time.

- 1 Close – swipe forwards twice over the control. You do not need wait for the sun blind to fully close before you swipe a second time.

* Option/accessory.

6.3.5. Automatic closing of the panoramic roof's* sun blind

With this function, the sun blind is closed automatically 15 minutes after the car has been locked if it is parked in hot weather. This is in order to lower the passenger compartment temperature and protect the car's upholstery from sun-fading.

The function is deactivated when the car is supplied from the factory and can be activated or deactivated in the centre display.

- 1 Tap on , **Controls, Auto-close sunroof curtain** and select the desired setting.

Note

The sun blind is also closed when all windows are closed using the key or keyless opening* with a door handle.

* Option/accessory.

6.3.6. Using the sun blind*

The sun blinds are built into each rear door.

Rear door – manually operated



The figure is schematic - the version may vary.

1 Hook with associated catch

- 1** Pull up the sun blind and attach it to the hook in the upper door frame.

The window can still be opened and closed with the sun blind up.

* Option/accessory.

6.4. Windows, glass and mirrors

The car contains several different windows, glass panes and mirrors. Some of the windows in the car are laminated.

The windscreen has laminated glass, and laminated glass is available as an option for certain other glass areas^[1]. Laminated glass is reinforced, which provides better protection against break-ins and improved sound insulation in the passenger compartment.

The panoramic roof* also has laminated glass^[1].



The content of this manual represents the status of the user manual at the time of printing and may not be completely valid in future instances. For more information, refer to the first page for the complete disclaimer note.

The symbol is shown on the windows where the glass is laminated.^[2]

^[1] Applies to certain models.

* Option/accessory.

^[2] Does not apply to the windscreen or panoramic roof* which are always laminated and thus do not have this symbol.

6.5. Pinch protection for windows and sun blinds

All power windows and sun blinds* have pinch protection which is deployed if they are blocked by any object while opening or closing.

In the event of blocking, the movement stops and then reverses automatically to approx. 50 mm (approx. 2 inches) from the blocked position (or to full ventilation position).

It is possible to force pinch protection when closing has been cancelled, e.g. when ice is formed, by continuing to press the control in one and the same direction.

If any fault arises with the pinch protection, a reset sequence can be tested.

Warning

If the starter battery is disconnected, the automatic opening and closing function must be reset to work properly. A reset must take place for pinch protection to work.

* Option/accessory.

6.6. Reset sequence for pinch protection

If a problem occurs with the electrical functions for the electric windows, a reset sequence can be tested.

Warning

If the starter battery is disconnected, the automatic opening and closing function must be reset to work properly. A reset must take place for pinch protection to work.

In the event of problems with the panoramic roof, contact a workshop^[1].

Reset the power window

- 1 Start with the window in closed position.
 - 2 Then operate the controls in the manual position 3 times upwards to closed position.
- > The system is initialised automatically.

If problems persist, contact a workshop.

[1] An authorised Volvo workshop is recommended.

6.7. Activating and deactivating max defroster

Max defroster is used to quickly remove mist and ice from windows.

Max defroster deactivates auto-regulation of the climate and air recirculation, activates air conditioning and changes the fan level to 5 and the temperature to HI.

i Note

Changing the fan level to 5 increases the noise level.

When max defroster is deactivated, the climate control system returns to the previous settings.

Activating and deactivating max defroster from centre console

There is a physical button in the centre console for quick access to max defroster.

For cars with heated windscreen*, the first press of the button activates the heating, and the next press activates max defroster. A third press deactivates both.



Physical button in the centre console.

Cars without heated windscreen:

- 1 Press the button.
 - Max defroster is activated/deactivated and the button lights up/goes off. The temperatures in the various climate zones are not synchronised while max defroster is activated.

Cars with heated windscreen:

- 1 Press the button repeatedly in order to switch between the three levels:
 - Activated heated windscreen
 - Activated heated windscreen and max defroster
 - Deactivated.
 - Heated windscreen and max defroster are activated/deactivated and the button illuminates/extinguishes.

 **Note**

Max defroster starts with a certain delay in order to avoid a short increase in fan level if the heated windscreen is deactivated by two quick presses of the button.

Activating and deactivating max defroster from centre display

- 1 Open the climate view in the centre display by tapping on the temperature button at the bottom centre of the centre display.



Tap on the max defroster button.

- Max defroster is activated/deactivated and the button lights up/goes off. The temperatures in the various climate zones are not synchronised while max defroster is activated.

* Option/accessory.

7. Seats and steering wheel

7.1. Front seat

7.1.1. Climate controls for front seat

7.1.1.1. Activating and deactivating heated front seat*

The seats can be heated in order to increase comfort for driver and passengers when it is cold.



Press the driver's side or passenger side seat button at the bottom of the centre display in order to open the control for seat heating.



Tap on the button for the heated seats repeatedly in order to switch the heating on/off and toggle between the three heating levels.

➤ The level changes and the button shows the set level.

 **Warning**

Heated seats must not be used by people who find it difficult to perceive an increase in temperature due to a lack of sensation or who otherwise have problems operating the controls for the heated seats.

* Option/accessory.

7.1.1.2. Activating and deactivating automatic start of heated front seat*

The seats can be heated in order to increase comfort for driver and passengers when it is cold.

It is possible to set whether automatic starting of the heated seats should be activated/deactivated when the driver is in the car when starting the car.^[1] With automatic starting activated, electric heating will start at an ambient temperature of 10 °C (50 °F) or lower.

- 1 Open the climate view in the centre display by tapping on the temperature button at the bottom centre of the centre display.
- 2 Press ...
- 3 Select the desired setting under **Auto driver seat heat** and **Auto passenger seat heat** to activate/deactivate automatic start of heated driver's and passenger seat.

* Option/accessory.

^[1] Usage mode Drive

7.1.1.3. Regulating fan level for front seat

The fan can be set to several different automatically controlled fan speeds for the front seat.^[1]

- 1 Open the climate view in the centre display by tapping on the temperature button at the bottom centre of the centre display.
- 2 Tap on the desired fan level; **OFF**, **1-5** or **Max**.
 - The fan level is changed and the selected level illuminates.

Important

If the fan is fully switched off then the air conditioning is not engaged, which results in a risk of misting on the insides of the windows.

 **Note**

The climate control system automatically adjusts the air flow within the selected fan level based on requirements. This means that the fan speed may change even though the fan level is the same.

High fan level in the rear seat may cause increased sound volume in the front seat.

^[1] For 2-zone climate, also rear seat.

7.1.1.4. Regulating temperature for front seat

The temperature can be set to the desired number of degrees for the front seat's ^[1] climate zones.

- 1 Tap on the temperature button at the bottom centre of the centre display to open the control. ^[2]
 - 2 Tap on the arrows to the side of the temperature to increase or decrease the temperature. There is also the option to tap directly on the arrows without first tapping on the temperature button, when the temperature is synchronised.
- The temperature changes and the button shows the set temperature.

 **Note**

Heating or cooling cannot be hastened by selecting a higher or lower temperature than the actual desired temperature.

^[1] For 2-zone climate, also the rear seat's.

^[2] If temperature synchronisation has been deactivated, the current temperature is shown on both the driver's side and the passenger side.

7.1.1.5. Synchronising temperature

The temperature in the car's different climate zones is synchronised by default with the temperature set on the driver's side, but it is possible to deactivate synchronisation and set the temperature separately for the various climate zones.

Deactivating temperature synchronisation

1 Tap on the temperature button at the bottom centre of the centre display to open the control.



Tap on the synchronisation button between the temperature controls.

- The temperature can now be set separately for the various climate zones. The temperature set is now displayed separately in the climate row on the driver's side and passenger side instead of just in the middle.

Synchronisation of the temperature can also be deactivated by changing the temperature on the passenger side.

Resetting synchronised temperature

1 Press the driver's side or passenger side temperature button at the bottom of the centre display in order to open the control.



Tap on the synchronisation button between the temperature controls.

- The temperature for all zones in the car is synchronised with the temperature set for the driver's side.

7.1.1.6. Activating and deactivating ventilated front seat*

The seats can be ventilated to provide increased comfort in a hot climate, for example.

The ventilation system consists of fans in the seats and backrests that draw air through the seat upholstery. The cooling effect increases the cooler the passenger compartment air becomes. The system can be activated when the engine is running.



Press the left or right-hand side's steering wheel and seat button in the climate row in the centre display in order to open the controls for seat and steering wheel.

If the car is not equipped with heated seats or heated steering wheel (for the driver's side), the button for ventilated seats is immediately available in the climate row.



Repeatedly press the button for ventilated seats in order to change between the three levels: **High**, **Medium** and **Low**.

- The level changes and the button shows the set level.

* Option/accessory.

7.1.2. Memory function for front seat

7.1.2.1. Using a stored position for seat, door mirrors and head-up display*

If the positions for the power* seat, the door mirrors and the head-up display* have been stored, they can be activated by using the memory buttons. ^[1]

Using a stored setting

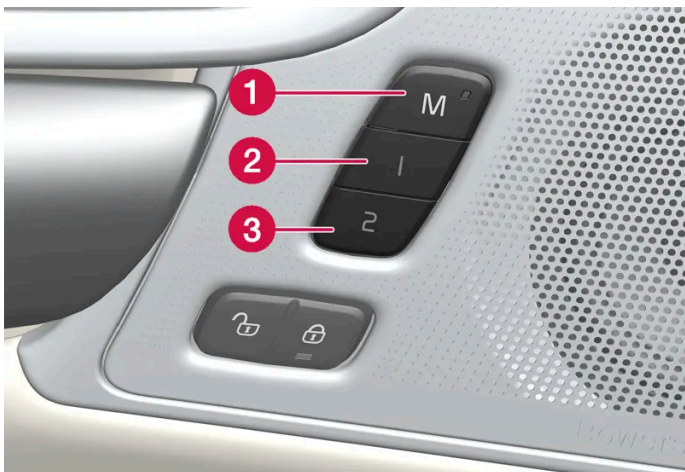

A stored setting can be used with the front door either open or closed:

Open front door

- 1 Depress one of the memory buttons 1 (2) or 2 (3) with a short press. Power seat, door mirrors and head-up display move and then stop at the positions stored in the selected memory button.

Closed front door

- 1 Hold one of the memory buttons 1 (2) or 2 (3) depressed until seat, door mirrors and head-up display stop in the positions that are stored in the selected memory button.

If the memory button is released, the movement of the seat, door mirrors and head-up display will be stopped.

Warning

- Because the driver's seat can be adjusted with the ignition off, children should never be left unattended in the vehicle.
- Movement of the seat can be STOPPED at any time by pressing any button on the power seat control panel.
- Do not adjust the seat while driving.
- Make sure there is nothing under the seats when they are being adjusted.

* Option/accessory.

^[1] The last position is also saved automatically in the active user profile and will be used next time the same profile is used again.

7.1.2.2. Storing position for seat, door mirrors and head-up display*

You can store the position for power* seat, door mirrors and head-up display* in the memory buttons. ^[1]

Store two different positions for the power* seat, the door mirrors and the head-up display* using the memory buttons. The

buttons are located on the inside of one of the front doors or both*.

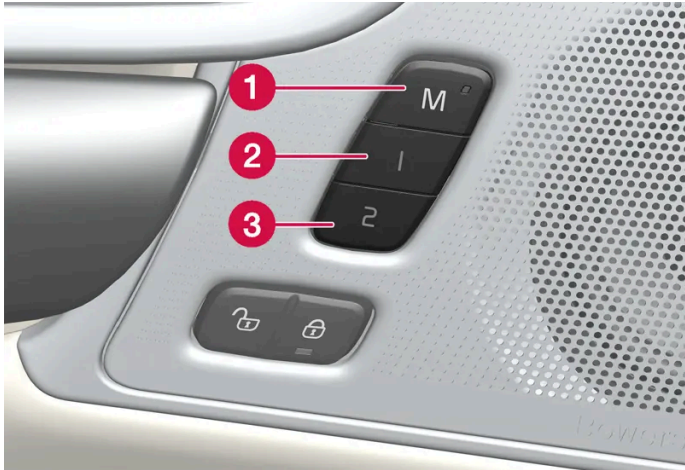

- 1 Button **M** for storing settings.
- 2 Memory button 1.
- 3 Memory button 2.

Storing a position

- 1 Adjust seat, door mirrors and head-up display to the desired position.
- 2 Press and hold the **M** button depressed. The light indicator in the button illuminates.
- 3 Press and hold the **1** or **2** button within three seconds.
 - When the position has been stored in the selected memory button, an acoustic signal can be heard and the light indicator in the **M** button extinguishes.

If none of the memory buttons is depressed within three seconds then the **M** button extinguishes and no storing takes place.

The seat, the door mirrors or the head-up-display must be readjusted before a new memory can be set.

Note

The stored positions are saved in the active profile.

* Option/accessory.

[1] The current position is also saved automatically in the active user profile.

7.1.3. Front seat

The content of this manual represents the status of the user manual at the time of printing and may not be completely valid in future instances. For more information, refer to the first page for the complete disclaimer note.

The seat has a range of adjustment options to increase your comfort.

7.1.4. Power* front seat

The car's front seats have a range of setting options in order to enhance comfort. The power seat can be moved forwards/backwards and upwards/downwards. The front edge of the seat cushion can be raised/lowered as well as adjusted in length* and the backrest inclination can be changed. The lumbar support* can be adjusted upward/downward/forward/backward. ^[1]

Seat adjustment can take place when the car is running and within a certain time after unlocking the door without the car running. Adjustment can also take place within a certain time after the car has been switched off.

! Important

The power seats have overload protection that is triggered if any seat is blocked by an object. If this happens, remove the object and then move the seat again.

* Option/accessory.

^[1] Applicable to four-way lumbar support*. Two-way lumbar support* is adjusted forwards/backwards.

7.1.5. Adjusting the power* front seat

Set the preferred seat position using the control on the front seat's seating section. To set the various comfort functions, turn the multifunction control ^[1] up/down.

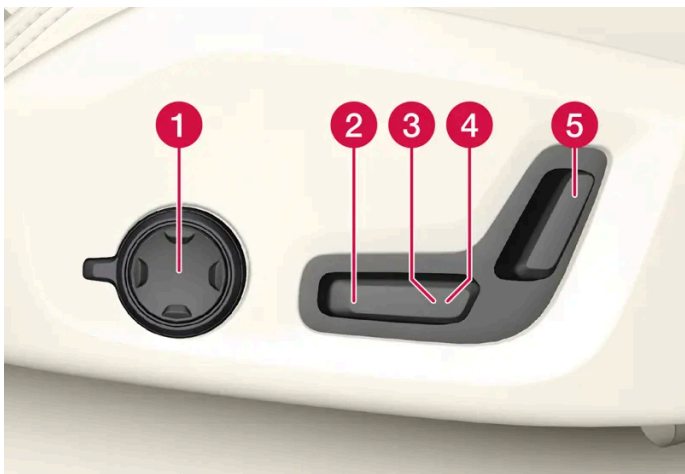

The illustration shows the controls from a car with four-way lumbar support*. Cars with two-way lumbar support* do not have the rotatable multifunction control.

1 In cars with four-way lumbar support*, turn the multifunction control ^[1] up/down to set the different comfort functions. In cars with two-way lumbar support*, use the round button to adjust the lumbar support forward/backward.

- 2 Raise/lower the seat cushion front edge by adjusting the control up/down.
- 3 Raise/lower the seat by means of adjusting the control up/down.
- 4 Move the seat forward/backward by adjusting the control forward/backward.
- 5 Change the backrest inclination by adjusting the control forward/backward.

Only one movement (forward/back/up/down) can be made at a time.

The backrests of the front seats cannot be lowered fully forward.

* Option/accessory.

[1] Not available in cars with two-way lumbar support*.

7.1.6. Adjusting the passenger seat from the driver's seat*

The front passenger seat can be adjusted from the driver's seat.

Activate the function via the centre display.

- 1 Press .
- 2 Select **Controls**.
- 3 Activate **Adjust passenger seat**.
- 4 From activation of the function, the driver must adjust the passenger seat within 10 seconds. If no adjustment is made within this time the function is deactivated.
- 5 The driver adjusts the passenger seat using the controls on the driver's seat:



- 1 Move the passenger seat forward/backward by adjusting the control forward/backward.
- 2 Change the passenger seat's backrest inclination by adjusting the control forward/backward.

* Option/accessory.

7.1.7. Manual front seat

The car's front seats have a range of setting options in order to enhance comfort.



- 1 Raise/lower the front edge of the seat cushion* by pumping up/down.^[1]
- 2 Change the length* of the seat cushion by pulling the lever up and moving the seat cushion forward/backward by hand.
- 3 Adjust the seat forward/backward by lifting the handle and adjusting the distance to the steering wheel and pedals. Check that the seat is locked after the position has been adjusted.
- 4 Change the lumbar support* by pressing the button upward/downward/forward/back.^[2]
- 5 Raise/lower the seat by means of adjusting the control up/down.
- 6 Change the backrest inclination by turning the control knob.

 **Warning**

Adjust the position of the driver's seat before setting off, never while driving. Make sure that the seat is in locked position in order to avoid personal injury in the event of heavy braking or an accident.

* Option/accessory.

^[1] Only applies to the driver's seat.

^[2] Applicable to four-way lumbar support*. Two-way lumbar support* is adjusted forwards/backwards.

7.1.8. Multifunction* front seat function overview

Enhance the seating comfort using the multi-function control*.

* Option/accessory.

7.1.9. Massage settings* in the front seat

The content of this manual represents the status of the user manual at the time of printing and may not be completely valid in future instances. For more information, refer to the first page for the complete disclaimer note.

Use the centre display to change settings. These settings are first activated via the multifunction control on the seat.



Multi-function control, located on the side of the seat's seating section.

Adjusting massage settings in the front seat

The front seat has massage in the backrest. The massage is performed by air cushions that can massage with different settings.

The massage function can only be activated when the car's engine is running.



- 1 Activate the multifunction control by turning the control up/down, or depress one of the four buttons on the multifunction control. The seat settings view is shown in the centre display.
- 2 Select **Massage** in the seat settings view.
- 3 To choose between the different massage functions shown in the centre display, make the selection directly in the centre display or by using the multifunction control.

Setting options for massage

The following setting options are available for massage:

- **On/Off:** Select **On/Off** to switch the massage function on/off.
- **Program 1-5:** There are 5 preset massage programs. Choose between **Wave, Wandering, Combined, Lower back** and **Shoulders**.
- **Intensity:** Choose between **1, 2** and **3**.
- **Speed:** Choose between **1, 2** and **3**.

Restarting massage

The massage function is deactivated automatically after 20 minutes. Reactivation of the function is performed manually.

- 1 Tap on **Restart**, which is shown in the centre display, to restart the selected massage program.
 - The massage program restarts. The message disappears if no action is taken.

* Option/accessory.

7.1.10. Adjusting the side support* in the front seat

Increase comfort in the front seat by adjusting the sides of the backrest.

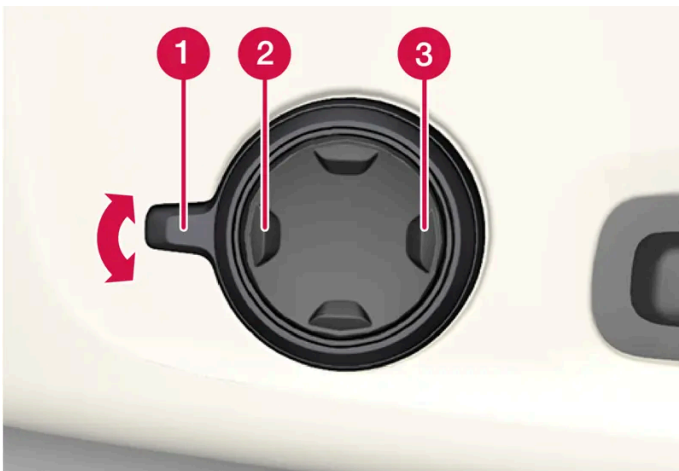

Multi-function button, located on the side of the seat base section.

The sides of the backrest can be adjusted to provide side support. Both the multi-function control on the seat and the centre display can be used in order to change the settings. The range of settings is shown in the centre display.

To adjust the side support:

- 1 Activate the multi-function control by turning the control **1** upwards/downwards. The seat settings view will be shown in the centre display.

- Press the front section of the four-way button to increase side support **2**.
- Press the rear section of the four-way button to decrease side support **3**.

* Option/accessory.

7.1.11. Adjusting the length of the seat cushion in the front seat *

Depending on equipment level selected, seat cushion length is adjusted either using the multifunction control* on the side of the seat's seat cushion, or manually using a control on the front of the seat cushion.

Adjusting the length of the seat cushion using the multifunction control

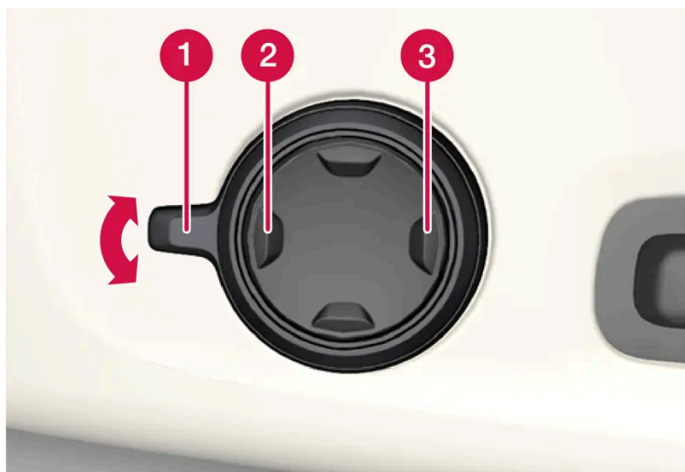

Multifunction control, located on the side of the seat cushion.

- 1** Activate the multi-function control by turning the control **1** upwards/downwards. The seat settings view will be shown in the centre display.
 - Press the front section of the four-way button **2** to extend the seat cushion.
 - Press the rear section of the four-way button **3** to retract the seat cushion.

Adjusting the length of the seat cushion manually

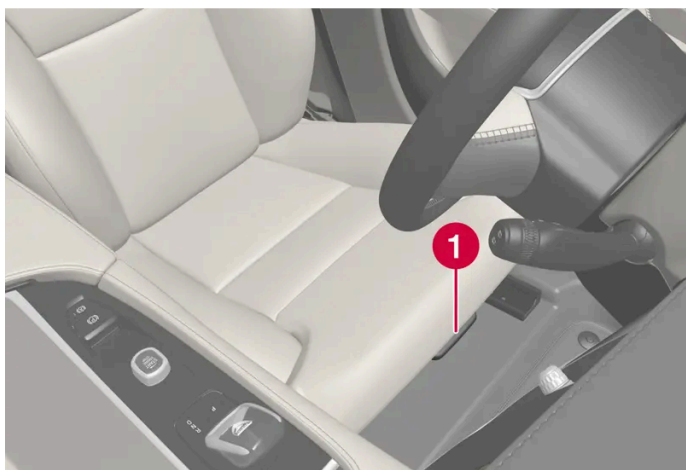

Control for seat cushion adjustment.

- 1 Grip the handle **1** on the front of the seat and pull upwards.
- 2 Adjust the length of the seat cushion.
- 3 Release the handle and make sure that the seat cushion has reached the correct position.

* Option/accessory.

7.1.12. Adjusting the lumbar support* in the front seat

The lumbar support is adjusted using a control on the side of the seat cushion.



Multifunction control in cars with four-way lumbar support*.



Control in cars with two-way lumbar support*.

The lumbar support is adjusted using the multifunction control in cars with four-way lumbar support*, or using the round button in cars with two-way lumbar support*. The control is located on the side of the seat's seating section. Depending on the equipment level selected, the lumbar support can be adjusted forward/back and up/down (four-way lumbar support) or forward/back (two-way lumbar support).

Adjust the lumbar support in the car using the four-way lumbar support

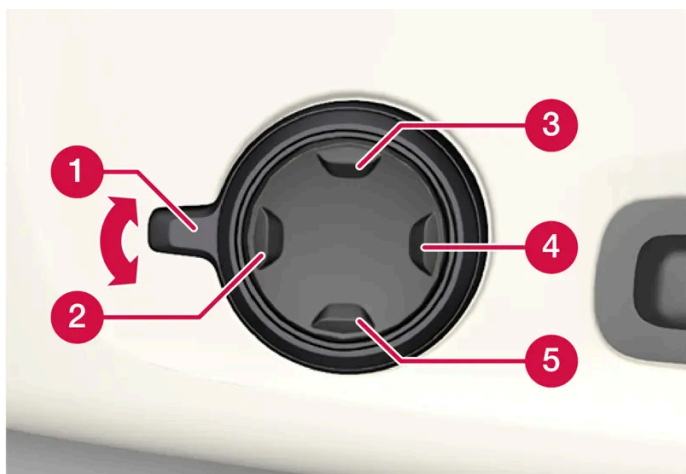

- 1 Activate the multi-function control by turning the control **1** upwards/downwards. The seat settings view will be shown in the centre display.
 - Press the round button up **3**/down **5** to move the lumbar support upwards/downwards.
 - Press the front section **2** of the button to increase lumbar support.
 - Press the rear section **4** of the button to decrease lumbar support.

Adjust the lumbar support in the car using the two-way lumbar support

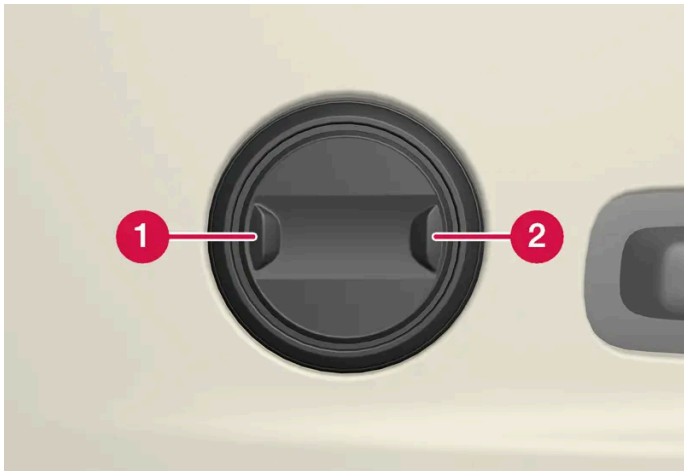

- 1 Press the front section **1** of the round button to increase lumbar support.
- 2 Press the rear section **2** of the round button to decrease lumbar support.

* Option/accessory.

7.2. Rear seat

7.2.1. Climate controls for rear seat

7.2.1.1. Activating and deactivating heated rear seat *

The seats can be heated in order to increase comfort for the passengers when it is cold.

With 2-zone climate:



Buttons for heated seats at the rear of the tunnel console.

Tap repeatedly on the physical buttons for the heated seats on the left and right-hand side at the rear of the tunnel console in order to switch the seat heating on/off and toggle between the three heating levels.

- The level changes and the LEDs in the button show the set level.

With 4-zone climate*:



Seat heating indication and controls on the climate panel at the rear of the tunnel console.

Press repeatedly on the left or right-hand side's buttons for heated seats on the tunnel console's climate panel to switch between the four heating levels.

- The level changes and the screen in the climate panel shows the set level.

 **Warning**

Heated seats must not be used by people who find it difficult to perceive an increase in temperature due to a lack of sensation or who otherwise have problems operating the controls for the heated seats.

* Option/accessory.

7.2.2. Rear seat

The car has five seats. The rear seat is divided into two folding parts, with one or two passenger seats respectively.

7.2.3. Adjusting the head restraints in the rear seat

Adjust the centre seat head restraint according to the height of the passenger. Fold down the outer seat head restraints* to improve rearward visibility.

Adjust the head restraint for the centre seat

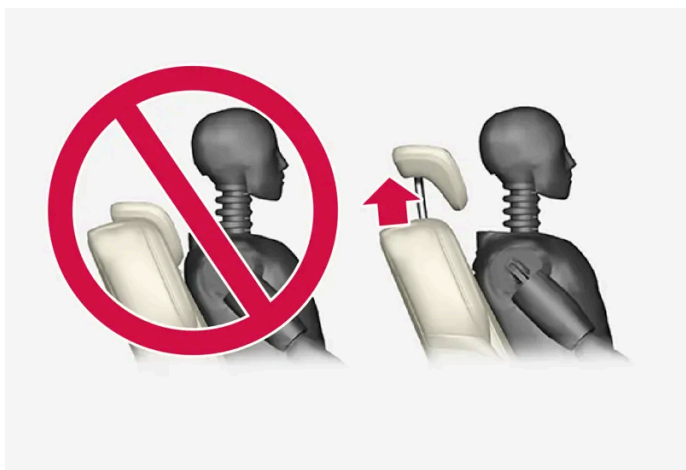

The centre seat's head restraint must be adjusted according to the passenger's height so that, if possible, the whole of the back of the head is covered. Slide it up manually as required.

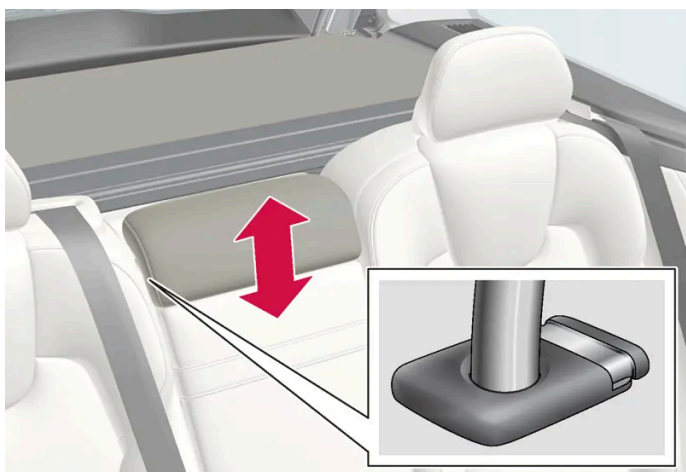

To lower the head restraint, the button (see illustration) must be depressed while the restraint is carefully moved down.

 **Warning**

The centre seat head restraint must be in its lowest position when the centre seat is not used. When the centre seat is used, the head restraint must be correctly adjusted to the height of the passenger so that it covers the whole of the back of the head if possible.

Fold down the rear seat's outer head restraints via the centre display*

The outer head restraints can be retracted via the centre display. Lowering the head restraint is possible when the car is in Passive usage mode.



- 1 Press  in the centre display.
- 2 Press **Controls**.
- 3 Select the desired setting under **Headrest fold**.

Move the head restraint back manually until a click is heard.

 **Warning**

Do not lower the outer head restraints if there are passengers in any of the outer rear seats.

 **Warning**

The head restraint must be in locked position after being folded up.

Fold down the rear seat's outer head restraints using handles

For cars with electronically controlled folding*, the outer head restraints can be folded using handles on the top side of the seat, see figure 1. Note that this method also folds the backrests. If only the head restraints shall be folded, e.g. to improve visibility, it can be performed from the centre display instead*. For cars without electric folding, the head restraints are fixed.



* Option/accessory.

7.2.4. Lowering the backrests in the rear seat

The rear seat's backrest is divided into two parts. The two parts can be folded forward individually.

 **Warning**

- Adjust the seat and fix it before driving away. Take care when adjusting the seat. Uncontrolled or careless adjustment can lead to trapping injuries.
- When loading long objects, they must always be strapped in securely to avoid injury and damage during sudden braking.
- Always switch off the car and apply the parking brake when loading and unloading the car.
- For cars with automatic gearbox, set the gear selector in P to prevent it from being moved by mistake.

 **Important**

There must be no objects on the rear seat when the backrest is to be folded down. The seat belts must not be connected either. Otherwise there is a risk of damaging the rear seat upholstery.

 **Important**

The seat cushion on the integrated child seat* must be in the lowered position before lowering the rear seat backrest. The armrest* for the centre seat must be raised before lowering the seat. The through-load hatch in the rear seat must be closed before lowering.

 **Note**



The front seats may need to be pushed forwards, and the backrests adjusted upwards, in order that the rear backrests can be fully folded forward.

Lowering the backrest

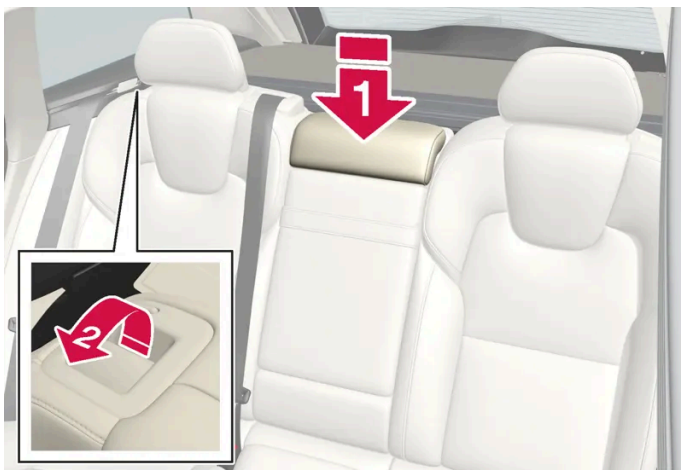
To facilitate folding of the rear seat, the car must be stationary and at least one rear door open.



Ensure that there are no occupants or objects in the rear seat.

- 1  Lower the centre seat's head restraint manually.
- 2  Pull the handles located on the car's left and right-hand backrests forwards to fold down the left and right-hand part of the rear seat respectively.
- 3 The backrest disengages from the lock and needs to be lowered manually to the horizontal position.

Raising the backrest

Raising the backrest to upright position is carried out manually:

- 1 Move the backrest up/back.
- 2 Press the backrest until the lock engages.
- 3 Raise the head restraints manually.
- 4 If necessary, raise the centre seat's head restraint.

 **Warning**

When the backrest has been raised, the red indicator should no longer be showing. If it is still showing then the backrest is not locked in place.

 **Warning**

Check that the backrests and head restraints in the rear seat are locked properly after being folded up.
The head restraints of the outer seats must always be raised when there are passengers on any of the rear seats.

* Option/accessory.

7.2.5. Through-load hatch in the rear seat

The hatch in the rear seat's backrest can be opened to transport long narrow items, e.g. skis.

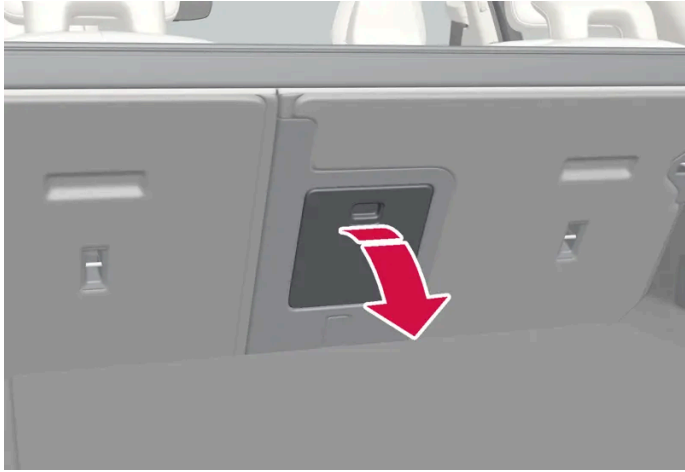

The figure is schematic - parts may vary depending on car model.

- 1 In the cargo area, grip the hatch's handle and fold down the hatch.
- 2 Fold forward the armrest in the rear seat.

7.3. Steering wheel

7.3.1. Speed-dependent steering force

Speed related power steering causes the steering wheel force to increase with the speed of the car so as to be able to give the driver enhanced sensitivity. On motorways the steering is firmer. When parking and at low speed steering is light and requires less effort.

Reduced power

In rare situations, the power steering may need to work at reduced power, and turning the steering wheel may then seem slightly heavier. This may occur when the power steering becomes too hot and it then needs temporary cooling. It may also occur if the power supply is disrupted.



In the event of reduced power, the message **Power steering assistance Temporarily reduced** is shown, as well as this symbol in the driver display.

While the power steering is working at reduced power, the driver support functions and steering assistance systems are not available.

 **Warning**

If the temperature increases too much, the servo may be forced to switch off completely. In such a situation, the driver display shows the **Stop safely Power steering failure** message, combined with a symbol.

Change the steering force level

- 1 Press  in the centre display.
- 2 Then tap on **Driving**.
- 3 Activating or deactivating **Steering feel firm**.

Steering wheel resistance selection can only be accessed if the car is stationary or is moving at low speed and in a straight line.

7.3.2. Steering wheel controls and horn

The steering wheel houses the horn and controls for e.g. the driver support systems and voice control.



Keypads* in the steering wheel.

- 1 Controls for driver support systems. ^[1]
- 2 Controls for voice control and menu, message and phone handling.

Horn



The horn is located in the centre of the steering wheel.

* Option/accessory.

^[1] Speed Limiter, Cruise Control, Adaptive Cruise Control*, Distance Warning* and Pilot Assist.

7.3.3. Adjusting the steering wheel

The steering wheel can be adjusted in different positions.

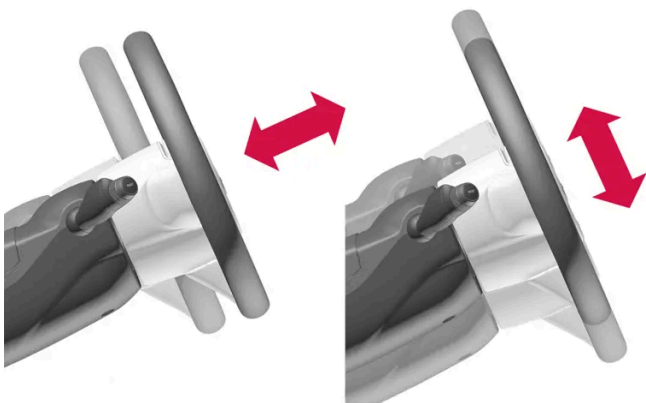

The steering wheel can be adjusted for height and for depth.

The steering wheel is adjusted in different ways depending on whether or not the car is equipped with knee airbag^[1].

Warning

Adjust and secure the steering wheel before driving away. The steering wheel must never be adjusted while driving.

Adjusting the steering wheel in a car with a knee airbag

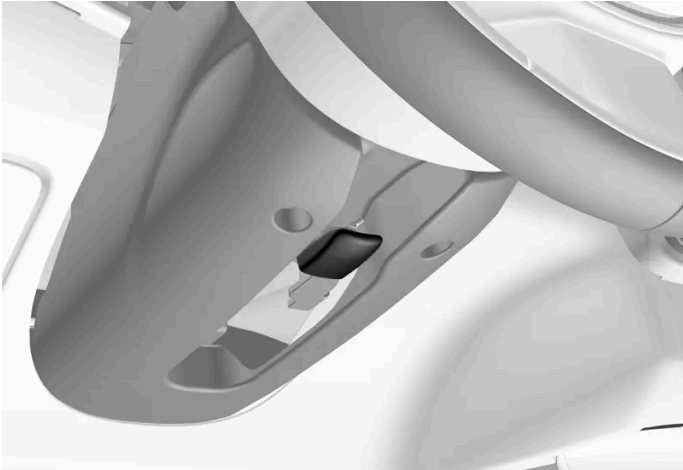

Lever for steering wheel adjustment.

- 1 Push the lever forward and down to release the steering wheel.
- 2 Adjust the steering wheel to the position that suits you.
- 3 Pull the lever back to fix the steering wheel in place. If the lever is stiff, press or raise the steering wheel slightly at the same time as you move the lever back.

Adjusting the steering wheel in a car without a knee airbag



Lever for steering wheel adjustment.

- 1 Pull the lever backwards to release the steering wheel.
- 2 Adjust the steering wheel to the position that suits you.
- 3 Push the lever forwards to secure the steering wheel. If the lever is stiff, press or raise the steering wheel slightly at the same time as you move the lever back.

^[1] The car is only equipped with knee airbag in certain markets.

7.3.4. Activating and deactivating the heated steering wheel*

The steering wheel can be heated in order to increase comfort for the driver when it is cold.



Tap on the driver's side seat button at the bottom of the centre display to display the control for steering wheel heating.



Tap on the button for the heated steering wheel repeatedly in order to switch the heating on/off and toggle between the three heating levels.

➤ The level changes and the button shows the set level.

* Option/accessory.

7.3.5. Activating and deactivating automatic start of heated steering wheel*

The steering wheel can be heated in order to increase comfort for the driver when it is cold.

It is possible to set whether automatic starting of the heated steering wheel should be activated/deactivated when the driver is in the car when starting the car.^[1] With automatic starting activated, electric heating will start at an ambient temperature of 10 °C (50 °F) or lower.

- 1 Open the climate view in the centre display by tapping on the temperature button at the bottom centre of the centre display.
- 2 Press **•••**.

3 Select the desired setting under **Auto steering wheel heat** to activate/deactivate automatic start of heated steering wheel.

* Option/accessory.

[1] Usage mode Drive

8. Climate control

8.1. Climate system controls

8.1.1. Climate controls for passenger compartment

8.1.1.1. Activating auto climate control

With auto climate control activated, multiple climate functions are controlled automatically.

- 1 Open the climate view in the centre display by tapping on the temperature button at the bottom centre of the centre display.
 - 2 Give a short or long press on **AUTO**.
 - Short press - air recirculation, air conditioning and air distribution are controlled automatically.
 - Long press - air recirculation, air conditioning and air distribution are controlled automatically, temperature and fan speed are changed to standard settings: 22 °C (72 °F) and level 3.
- Auto-regulation of the climate is activated and the button illuminates.

 **Note**

Temperature and fan speed can be changed without deactivating the automatically-regulated climate control system. The automatically-regulated climate control system is deactivated when the air distribution is changed manually or when maximum defroster is activated.

8.1.1.2. Regulating fan level for front seat

The fan can be set to several different automatically controlled fan speeds for the front seat. ^[1]

- 1 Open the climate view in the centre display by tapping on the temperature button at the bottom centre of the centre display.
 - 2 Tap on the desired fan level; **OFF**, **1-5** or **Max**.
- The fan level is changed and the selected level illuminates.

 **Important**

If the fan is fully switched off then the air conditioning is not engaged, which results in a risk of misting on the insides of the windows.

 **Note**

The climate control system automatically adjusts the air flow within the selected fan level based on requirements. This means that the fan speed may change even though the fan level is the same.

High fan level in the rear seat may cause increased sound volume in the front seat.

^[1] For 2-zone climate, also rear seat.

8.1.1.3. Activating and deactivating air conditioning

The air conditioning cools and dehumidifies incoming air as required.

When the air conditioning is activated, the climate control system automatically controls starting and switching off as required.

- 1 Open the climate view in the centre display by tapping on the temperature button at the bottom centre of the centre display.



Tap on the air conditioning button.

- Air conditioning is activated/deactivated and the button illuminates/extinguishes.

 **Note**

Close all side windows and the panoramic roof* so that the air conditioning should work as well as possible.

 **Note**

It is not possible to activate the air conditioning when the fan control is in **Off** position.

* Option/accessory.

8.1.1.4. Activating and deactivating air recirculation

Air recirculation shuts out bad air, exhaust gases, etc. from outside the car by the climate control system reusing the air in the passenger compartment.

- 1 Open the climate view in the centre display by tapping on the temperature button at the bottom centre of the centre display.



Tap on the air recirculation button.

- Air recirculation is activated/deactivated and the button illuminates/extinguishes.

 **Important**

If the air in the car is recirculated for too long then there is a risk of misting on the insides of the windows.

 **Note**

It is not possible to activate air recirculation when max defroster is activated.

 **Note**

If the air quality sensor detects that the outside air is contaminated, the air intake is closed and air recirculation is activated automatically.

8.1.1.5. Activating and deactivating time setting for air recirculation

Air recirculation shuts out bad air, exhaust gases, etc. from outside the car by the climate control system reusing the air in the passenger compartment.

It is possible set whether the air recirculation timer should be activated/deactivated. When the timer is activated, air recirculation is automatically switched off after 20 minutes.

- 1 Open the climate view in the centre display by tapping on the temperature button at the bottom centre of the centre display.
- 2 Press **⋮**.
- 3 Select the desired setting under **Recirculation timer** to activate/deactivate the timer for air recirculation.

8.1.1.6. Regulating temperature for front seat

The temperature can be set to the desired number of degrees for the front seat's ^[1] climate zones.

- 1 Tap on the temperature button at the bottom centre of the centre display to open the control. ^[2]
- 2 Tap on the arrows to the side of the temperature to increase or decrease the temperature. There is also the option to tap directly on the arrows without first tapping on the temperature button, when the temperature is synchronised.

The content of this manual represents the status of the user manual at the time of printing and may not be completely valid in future instances. For more information, refer to the first page for the complete disclaimer note.

- The temperature changes and the button shows the set temperature.

Note

Heating or cooling cannot be hastened by selecting a higher or lower temperature than the actual desired temperature.

^[1] For 2-zone climate, also the rear seat's.

^[2] If temperature synchronisation has been deactivated, the current temperature is shown on both the driver's side and the passenger side.

8.1.1.7. Synchronising temperature

The temperature in the car's different climate zones is synchronised by default with the temperature set on the driver's side, but it is possible to deactivate synchronisation and set the temperature separately for the various climate zones.

Deactivating temperature synchronisation

- 1 Tap on the temperature button at the bottom centre of the centre display to open the control.



Tap on the synchronisation button between the temperature controls.

- The temperature can now be set separately for the various climate zones. The temperature set is now displayed separately in the climate row on the driver's side and passenger side instead of just in the middle.

Synchronisation of the temperature can also be deactivated by changing the temperature on the passenger side.

Resetting synchronised temperature

- 1 Press the driver's side or passenger side temperature button at the bottom of the centre display in order to open the control.



Tap on the synchronisation button between the temperature controls.

- The temperature for all zones in the car is synchronised with the temperature set for the driver's side.

8.1.1.8. Changing air distribution

The air distribution can be changed manually if required.

- 1 Open the climate view in the centre display by tapping on the temperature symbol at the bottom centre of the centre display.
- 2 The air distribution buttons in the climate view are located in the centre around the **AUTO** button, from the top and down:
 - Air distribution - windscreen defroster vents
 - Air distribution - air vents in instrument panel and centre console
 - Air distribution - air vents in the floor

Press one or more of the air distribution buttons in order to open/close the corresponding air flow.

- The air distribution is changed and the buttons illuminate/extinguish.
If all air distribution buttons are deselected in manual mode, the climate control system returns to automatically regulated climate control.

8.1.2. Climate controls for seat and steering wheel

8.1.2.1. Activating and deactivating the heated steering wheel*

The steering wheel can be heated in order to increase comfort for the driver when it is cold.

1



Tap on the driver's side seat button at the bottom of the centre display to display the control for steering wheel heating.



Tap on the button for the heated steering wheel repeatedly in order to switch the heating on/off and toggle between the three heating levels.

➤ The level changes and the button shows the set level.

* Option/accessory.

8.1.2.2. Activating and deactivating automatic start of heated steering wheel*

The steering wheel can be heated in order to increase comfort for the driver when it is cold.

It is possible to set whether automatic starting of the heated steering wheel should be activated/deactivated when the driver is in the car when starting the car.^[1] With automatic starting activated, electric heating will start at an ambient temperature of 10 °C (50 °F) or lower.

- 1 Open the climate view in the centre display by tapping on the temperature button at the bottom centre of the centre display.
- 2 Press ⋮.
- 3 Select the desired setting under **Auto steering wheel heat** to activate/deactivate automatic start of heated steering wheel.

* Option/accessory.

^[1] Usage mode Drive

8.1.2.3. Activating and deactivating heated rear seat*

The seats can be heated in order to increase comfort for the passengers when it is cold.

With 2-zone climate:



Buttons for heated seats at the rear of the tunnel console.

Tap repeatedly on the physical buttons for the heated seats on the left and right-hand side at the rear of the tunnel console in order to switch the seat heating on/off and toggle between the three heating levels.

- The level changes and the LEDs in the button show the set level.

With 4-zone climate*:



Seat heating indication and controls on the climate panel at the rear of the tunnel console.

Press repeatedly on the left or right-hand side's buttons for heated seats on the tunnel console's climate panel to switch between the four heating levels.

- The level changes and the screen in the climate panel shows the set level.

 **Warning**

Heated seats must not be used by people who find it difficult to perceive an increase in temperature due to a lack of sensation or who otherwise have problems operating the controls for the heated seats.

* Option/accessory.

8.1.2.4. Activating and deactivating heated front seat*

The seats can be heated in order to increase comfort for driver and passengers when it is cold.



Press the driver's side or passenger side seat button at the bottom of the centre display in order to open the control for seat heating.



Tap on the button for the heated seats repeatedly in order to switch the heating on/off and toggle between the three heating levels.

➤ The level changes and the button shows the set level.

Warning

Heated seats must not be used by people who find it difficult to perceive an increase in temperature due to a lack of sensation or who otherwise have problems operating the controls for the heated seats.

* Option/accessory.

8.1.2.5. Activating and deactivating automatic start of heated front seat*

The seats can be heated in order to increase comfort for driver and passengers when it is cold.

It is possible to set whether automatic starting of the heated seats should be activated/deactivated when the driver is in the car when starting the car.^[1] With automatic starting activated, electric heating will start at an ambient temperature of 10 °C (50 °F) or lower.

- 1 Open the climate view in the centre display by tapping on the temperature button at the bottom centre of the centre display.
- 2 Press •••
- 3 Select the desired setting under **Auto driver seat heat** and **Auto passenger seat heat** to activate/deactivate automatic start of heated driver's and passenger seat.

* Option/accessory.

[1] Usage mode Drive

8.1.3. Climate controls for windows and mirrors

8.1.3.1. Activating and deactivating the heated rear window and door mirrors

The heated rear window and door mirrors are used to quickly remove mist and ice from the windows and mirrors.

Activating and deactivating heated rear window and door mirrors from centre console

In the centre console is a physical button for rapid access to the heated rear window and door mirrors.



Physical button in the centre console.

- 1 Press the button.
 - Heated rear window and door mirrors are activated/deactivated and the button illuminates/extinguishes.

Activating and deactivating heated rear window and door mirrors from centre display

- 1 Open the climate view in the centre display by tapping on the temperature button at the bottom centre of the centre display.



Tap on the button for the heated rear window and door mirrors.

- Heated rear window and door mirrors are activated/deactivated and the button illuminates/extinguishes.

8.1.3.2. Activating and deactivating automatic starting of the heated rear window and door mirrors

The heated rear window and door mirrors are used to quickly remove mist and ice from the windows and mirrors.

It is possible to set whether automatic starting of the heated rear window and door mirrors should be activated/deactivated when the driver is in the car when starting the car.^[1] With automatic starting activated, electric heating will start when there is a risk of ice or misting on the window. The heating switches off automatically when the windscreen/window is sufficiently warm and the ice or misting is gone.

- 1 Open the climate view in the centre display by tapping on the temperature button at the bottom centre of the centre display.
- 2 Press ...
- 3 Select the desired setting under **Auto rear defroster** to activate/deactivate automatic start of heated rear window and door mirrors.

^[1] Usage mode Drive

8.1.3.3. Activating and deactivating the heated windscreen *

A heated windscreen is used to quickly remove mist and ice from the window.

Activating and deactivating heated windscreen from centre console

In the centre console is a physical button for rapid access to the heated windscreen.



Physical button in the centre console.

- 1 Press the button repeatedly in order to switch between the three levels:
 - Activated heated windscreen
 - Activated heated windscreen and max defroster
 - Deactivated.

The content of this manual represents the status of the user manual at the time of printing and may not be completely valid in future instances. For more information, refer to the first page for the complete disclaimer note.

- Heated windscreen and max defroster are activated/deactivated and the button illuminates/extinguishes.

Activating and deactivating heated windscreen from centre display

- 1 Open the climate view in the centre display by tapping on the temperature button at the bottom centre of the centre display.



Press the button for heated windscreen.

- Heated windscreen is activated/deactivated and the button illuminates/extinguishes.

Note

A triangular area at the end of each side of the windscreen is not electrically heated, where de-icing may take longer.

Note

The heated windscreen may affect the performance of transponders and other communication equipment.

* Option/accessory.

8.1.3.4. Activating and deactivating automatic start of heated windscreen*

A heated windscreen is used to quickly remove mist and ice from the window.

It is possible to set whether automatic start of heated windscreen should be activated/deactivated when the driver is in the car when starting the car ^[1]. With automatic start activated, heating will start when there is a risk of ice or misting on the windscreen/window. The heating switches off automatically when the windscreen/window is sufficiently warm and the ice or misting is gone.

- 1 Open the climate view in the centre display by tapping on the temperature button at the bottom centre of the centre display.

- 2 Press ...
- 3 Select the desired setting under **Auto front defroster** to activate/deactivate automatic start of heated rear window and door mirrors.

* Option/accessory.

[1] Usage mode Drive

8.1.3.5. Activating and deactivating max defroster

Max defroster is used to quickly remove mist and ice from windows.

Max defroster deactivates auto-regulation of the climate and air recirculation, activates air conditioning and changes the fan level to 5 and the temperature to HI.

Note

Changing the fan level to 5 increases the noise level.

When max defroster is deactivated, the climate control system returns to the previous settings.

Activating and deactivating max defroster from centre console

There is a physical button in the centre console for quick access to max defroster.

For cars with heated windscreen*, the first press of the button activates the heating, and the next press activates max defroster. A third press deactivates both.



Physical button in the centre console.

Cars without heated windscreen:

- 1 Press the button.
 - Max defroster is activated/deactivated and the button lights up/goes off. The temperatures in the various climate zones are not synchronised while max defroster is activated.

Cars with heated windscreen:

- 1 Press the button repeatedly in order to switch between the three levels:
 - Activated heated windscreen
 - Activated heated windscreen and max defroster
 - Deactivated.
 - Heated windscreen and max defroster are activated/deactivated and the button illuminates/extinguishes.

Note

Max defroster starts with a certain delay in order to avoid a short increase in fan level if the heated windscreen is deactivated by two quick presses of the button.

Activating and deactivating max defroster from centre display

- 1 Open the climate view in the centre display by tapping on the temperature button at the bottom centre of the centre display.
- 2  Tap on the max defroster button.
 - Max defroster is activated/deactivated and the button lights up/goes off. The temperatures in the various climate zones are not synchronised while max defroster is activated.

* Option/accessory.

8.1.4. Climate controls

The content of this manual represents the status of the user manual at the time of printing and may not be completely valid in future instances. For more information, refer to the first page for the complete disclaimer note.

The climate control system's functions are controlled from physical buttons in the centre console, the centre display and the climate controls at the rear of the tunnel console*.

Physical buttons in centre console

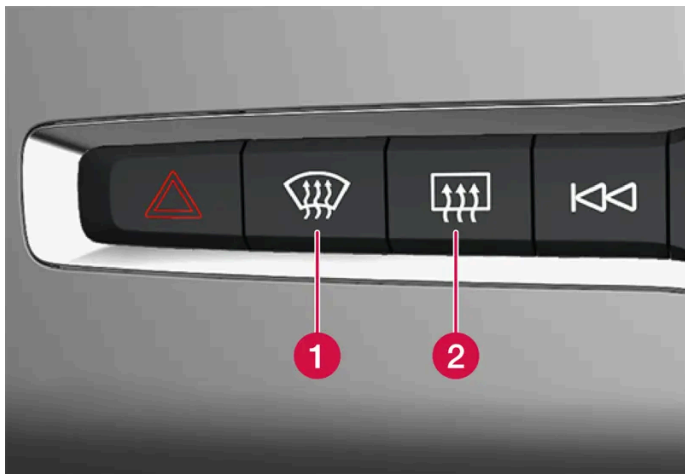

- 1 Button for heated windscreen* and max defroster.
- 2 Button for heated rear window and door mirrors.

Climate buttons in the centre display

The most common climate functions are always available at the bottom of the centre display.

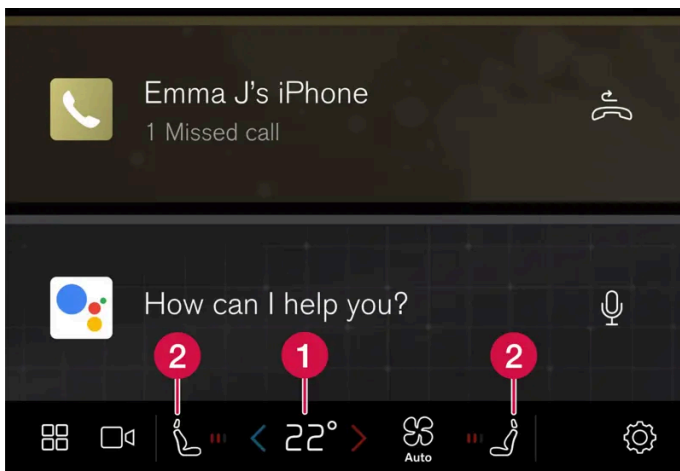

- 1 Temperature controls for driver and passenger side.^[1]
- 2 Controls for heated* driver and front passenger seats, as well as heated steering wheel*.

Climate view in centre display

Open the climate view in the centre display by tapping on the temperature button at the bottom centre of the centre display or on the fan symbol.

Main climate

Other main climate functions can also be controlled under **Main climate**, in addition to the climate functions always available in the centre display.



Controls for max defroster.



Controls for heated windscreen.



Controls for air conditioning.



Controls for air recirculation.



Controls for heated rear window and door mirrors.

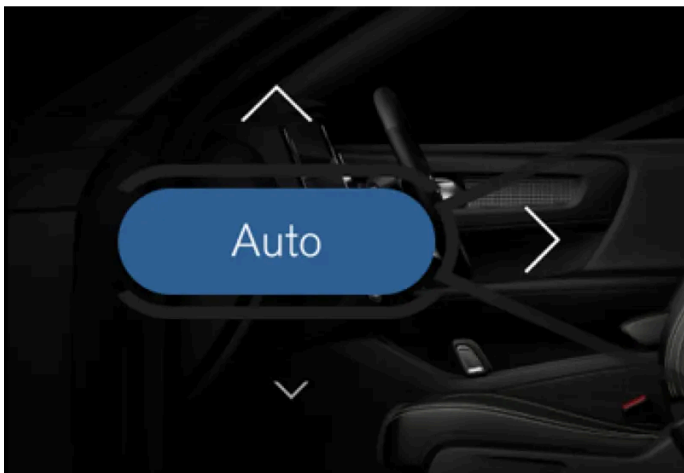

Button for auto regulating of climate and arrows for air distribution.

Parking climate

The car's parking climate can be regulated under **Parking**.

Settings

Further climatization settings can be defined under **•••**.

Physical buttons at the rear on the tunnel console *

There are physical buttons at the rear on the tunnel console in order to regulate the rear seat heating.

* Option/accessory.

[1] If temperature synchronisation has been deactivated, the current temperature is shown on both the driver's side and the passenger side.

8.2. Air distribution

8.2.1. Activating and deactivating air recirculation

Air recirculation shuts out bad air, exhaust gases, etc. from outside the car by the climate control system reusing the air in the passenger compartment.

- 1 Open the climate view in the centre display by tapping on the temperature button at the bottom centre of the centre display.



Tap on the air recirculation button.

- Air recirculation is activated/deactivated and the button illuminates/extinguishes.

 **Important**

If the air in the car is recirculated for too long then there is a risk of misting on the insides of the windows.

 **Note**

It is not possible to activate air recirculation when max defroster is activated.

 **Note**

If the air quality sensor detects that the outside air is contaminated, the air intake is closed and air recirculation is activated automatically.

8.2.2. Activating and deactivating time setting for air recirculation

Air recirculation shuts out bad air, exhaust gases, etc. from outside the car by the climate control system reusing the air in the passenger compartment.

It is possible set whether the air recirculation timer should be activated/deactivated. When the timer is activated, air recirculation is automatically switched off after 20 minutes.

- 1 Open the climate view in the centre display by tapping on the temperature button at the bottom centre of the centre display.
- 2 Press **•••**.
- 3 Select the desired setting under **Recirculation timer** to activate/deactivate the timer for air recirculation.

8.2.3. Activating and deactivating max defroster

Max defroster is used to quickly remove mist and ice from windows.

Max defroster deactivates auto-regulation of the climate and air recirculation, activates air conditioning and changes the fan level to **5** and the temperature to **HI**.

 **Note**

Changing the fan level to **5** increases the noise level.

When max defroster is deactivated, the climate control system returns to the previous settings.

Activating and deactivating max defroster from centre console

There is a physical button in the centre console for quick access to max defroster.

For cars with heated windscreen*, the first press of the button activates the heating, and the next press activates max defroster. A third press deactivates both.



Physical button in the centre console.

Cars without heated windscreen:

- 1 Press the button.
 - Max defroster is activated/deactivated and the button lights up/goes off. The temperatures in the various climate zones are not synchronised while max defroster is activated.

Cars with heated windscreen:

- 1 Press the button repeatedly in order to switch between the three levels:
 - Activated heated windscreen
 - Activated heated windscreen and max defroster
 - Deactivated.
 - Heated windscreen and max defroster are activated/deactivated and the button illuminates/extinguishes.

i Note

Max defroster starts with a certain delay in order to avoid a short increase in fan level if the heated windscreen is deactivated by two quick presses of the button.

Activating and deactivating max defroster from centre display

1 Open the climate view in the centre display by tapping on the temperature button at the bottom centre of the centre display.



Tap on the max defroster button.

- Max defroster is activated/deactivated and the button lights up/goes off. The temperatures in the various climate zones are not synchronised while max defroster is activated.

* Option/accessory.

8.2.4. Air distribution

The climate control system distributes the incoming air via a number of different vents in the passenger compartment.

Automatic and manual air distribution

With auto-regulated climate running the air distribution takes place automatically. If necessary, the air distribution can be controlled manually.

Adjustable air vents

Some of the air vents in the car are adjustable, which means that you can open/close the vent to aim the air flow.

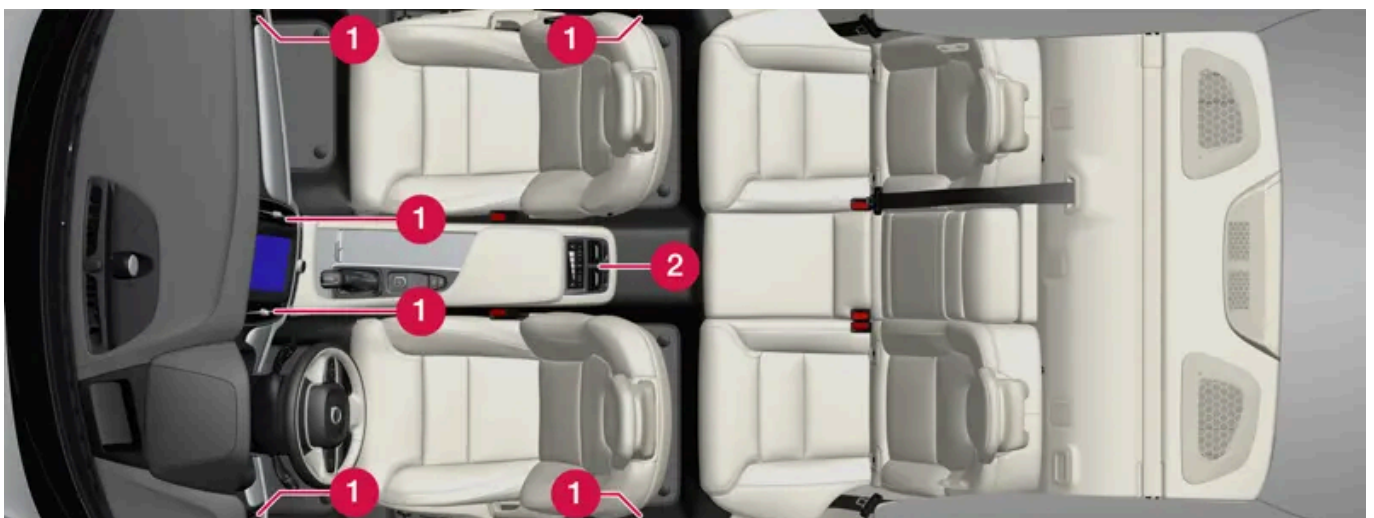

Location of adjustable air vents in the passenger compartment.

- 1 With 2-zone climate - four on the instrument panel and one on each of the door pillars between the front and rear doors.
- 2 Addition with 4-zone climate* - two at the rear of the tunnel console.

* Option/accessory.

8.2.5. Changing air distribution

The air distribution can be changed manually if required.

- 1 Open the climate view in the centre display by tapping on the temperature symbol at the bottom centre of the centre display.
- 2 The air distribution buttons in the climate view are located in the centre around the **AUTO** button, from the top and down:
 - Air distribution - windscreen defroster vents
 - Air distribution - air vents in instrument panel and centre console
 - Air distribution - air vents in the floor

Press one or more of the air distribution buttons in order to open/close the corresponding air flow.

- The air distribution is changed and the buttons illuminate/extinguish.
If all air distribution buttons are deselected in manual mode, the climate control system returns to automatically regulated climate control.
-

8.2.6. Opening, closing and aiming the air vents

Some air vents in the passenger compartment can be opened, closed and aimed individually.

If the car's outer vents are aimed at the side windows then misting can be eliminated.

If the car's outer vents are aimed inwards then, in a hot climate, a comfortable environment is obtained in the passenger compartment.

Opening and closing the air vents

Air vents on the instrument panel:

- 1 Turn the rotary knob in the middle of the air vent to open/close the air flow from the vent.
The air flow is at maximum when the marking on the knob is in vertical position.

Air vents on the door pillars and at the rear of the tunnel console*:

- 1 Roll the thumbwheel under the air vent in order to open/close the air flow from the vent.
The longer the white lines on the thumbwheel that are visible, the higher the air flow.

Aiming the air vents

- 1 Move the lever in the middle of the air vent horizontally/vertically to direct the air flow from the vent.

* Option/accessory.

8.3. Air quality

8.3.1. Air quality

The materials selected for the passenger compartment and the air purification system ensure that the air quality in the passenger compartment is high.

Materials in the passenger compartment

The interior of the passenger compartment is designed to be pleasant and comfortable, even for people with contact allergies and for asthma sufferers.

The carpets in both the passenger compartment and the cargo area are removable and easy to remove and clean.

Use cleaning agents and car care products recommended by Volvo to clean the interior.

Air purification system

In addition to the passenger compartment filter, the car is equipped with an air purification system that helps to maintain high air quality in the passenger compartment.

8.3.2. Advanced Air Cleaner*

The content of this manual represents the status of the user manual at the time of printing and may not be completely valid in future instances. For more information, refer to the first page for the complete disclaimer note.

Advanced Air Cleaner is a fully-automatic air purifier that collects contaminants in the form of small airborne particulate matter and exhaust gases in the passenger compartment filter, which improves the climate in the passenger compartment.

The function is started automatically when the fan is started.

Small airborne particulate matter is sometimes called PM_{2.5} (particles smaller than 2.5 µm), the content of such particles in the car is measured by one of the car's climate sensors. The content in the car is presented in the downloadable Air Quality app.

* Option/accessory.

8.3.3. CleanZone *

The CleanZone function checks and indicates whether or not all conditions have been met for good air quality in the passenger compartment.

If the conditions are not met, the text **CleanZone**, which is shown in the climate view, is white.

When all conditions have been met, this is indicated by the text changing colour to blue.

Conditions that need to be met:

- That all doors and the tailgate are closed.
- That all side windows and the panoramic roof* are closed.
- That the ventilation fan is activated.
- That the air recirculation is deactivated.

Note

CleanZone does not indicate that the air quality is good. It only indicates that the conditions for good air quality have been met.

* Option/accessory.

8.3.4. Clean Zone Interior Package *

Clean Zone Interior Package (CZIP) comprises a series of modifications that keep the passenger compartment even clearer from allergy and asthma-inducing substances, among other things.

The following is included:

- An enhanced fan function that means that the fan starts when the car is unlocked with the key. The fan fills the passenger compartment with fresh air. The function starts when required and is disengaged automatically after a time or when one of the passenger compartment doors is opened. The amount of time the fan runs is reduced gradually due to reduced need up until the car is 4 years old.
- The fully automatic air quality system Interior Air Quality System (IAQS).

* Option/accessory.

8.3.5. Interior Air Quality System *

Interior Air Quality System (IAQS) is a fully automatic air quality system that separates gases and particles to reduce the levels of odours and contaminants in the passenger compartment.

IAQS is a part of the Clean Zone Interior Package (CZIP) and cleans the air in the passenger compartment from contaminants such as particles, hydrocarbons, nitrous oxides and ground-level ozone.

If the air quality sensor senses that the outside air is contaminated, the air intake is closed and air recirculation is activated.

Note

In a cold climate recirculation is limited so as to prevent misting.

In the event of misting, the defrost functions for windscreen, side windows and rear window should be used.

* Option/accessory.

8.3.6. Passenger compartment filter

All air entering the car's passenger compartment is cleaned with a filter.

Replacing the passenger compartment filter

To maintain high climate system performance, the filter must be changed at regular intervals. Follow the Volvo Service Programme for the recommended replacement intervals. If the car is used in a severely contaminated environment, it may be necessary to replace the filter more often.

Note

There are different types of passenger compartment filter. Make sure that the correct filter is fitted.

8.3.7. Air purification *

Air purification of the car prior to departure is used to improve the air quality in the passenger compartment.

Air purification can be started directly from the centre display or in the Volvo Cars app, but also starts automatically when pre-conditioning ends.

This function uses the ventilation to blow fresh air into the passenger compartment and then circulates the air through the air conditioning system's passenger compartment filter.

The content of small particulate matter (PM_{2,5}) in the passenger compartment can be followed in the Volvo Cars app during the pre-cleaning cycle.

* Option/accessory.

8.3.8. Starting and switching off air purification *

Air purification improves the air quality in the passenger compartment prior to driving.

The function is started directly from the centre display or the Volvo Cars app.

- 1 Open the climate view in the centre display by tapping on the temperature button at the bottom centre of the centre display.
- 2 Press **Parking**.
- 3 Tap on **Start air purification** to start air purification directly.

Note

Air purification * starts automatically when preconditioning is completed.

Windows and doors must be closed for air purification to be possible.

* Option/accessory.

8.3.9. Air Quality app

The Air Quality app is a service that visualises the measured content of small airborne particulate matter inside and outside the car over time.

A climate sensor measures the content of PM_{2.5} particles (particles smaller than 2.5 µm) in the passenger compartment^[1]. The content of contaminants outside the car is measured by an external service and is based on modelled data.

^[1] The availability of pollen data varies depending on the market.

8.4. Parking climate

8.4.1. Pre-cleaning

8.4.1.1. Air purification *

Air purification of the car prior to departure is used to improve the air quality in the passenger compartment.

Air purification can be started directly from the centre display or in the Volvo Cars app, but also starts automatically when pre-conditioning ends.

This function uses the ventilation to blow fresh air into the passenger compartment and then circulates the air through the air conditioning system's passenger compartment filter.

The content of small particulate matter (PM_{2.5}) in the passenger compartment can be followed in the Volvo Cars app during the pre-cleaning cycle.

* Option/accessory.

8.4.1.2. Starting and switching off air purification *

Air purification improves the air quality in the passenger compartment prior to driving.

The function is started directly from the centre display or the Volvo Cars app.

- 1 Open the climate view in the centre display by tapping on the temperature button at the bottom centre of the centre display.
- 2 Press **Parking**.
- 3 Tap on **Start air purification** to start air purification directly.

 **Note**

Air purification* starts automatically when preconditioning is completed.
 Windows and doors must be closed for air purification to be possible.

* Option/accessory.

8.4.2. Parking climate *

Parking climate control is a generic term for various functions that improve the passenger compartment climate when the car is parked.



Functions belonging to the parking climate control are controlled from the **Parking** in climate view in the centre display. Open the climate view by tapping on the temperature symbol at the bottom centre of the centre display.

* Option/accessory.

8.4.3. Symbols and messages for parking climate control *

A number of symbols and messages regarding parking climate control can be shown in the driver display.

Messages relating to parking climate control can also be displayed in a device which has the Volvo Cars* app.

Symbol	Message	Specification
	Parking climate Service required	Parking climate control is disengaged. Contact a workshop ^[1] to check the function as soon as possible.
	Parking climate Temporarily unavailable	Parking climate control is temporarily disengaged.

* Option/accessory.

[1] An authorised Volvo workshop is recommended.

8.4.4. Climate comfort when parking*

The climate in the car's passenger compartment can be maintained while the car is parked, e.g. if the engine needs to be switched off but the driver or passenger(s) wants to remain in the car and maintain the level of climate comfort.

Starting climate comfort retention is only possible via direct start from the centre display.

The function utilises several systems in different cases:

- Residual heat from the engine, in a cold climate, heats the passenger compartment to comfort temperature.
- When it is warm, the ventilation cools the passenger compartment by blowing in air from outside the car.



Warning

Never leave children alone in the car, or people unable to exit the car without assistance.



Note

Climate comfort retention is switched off when the car is locked from the outside to avoid using residual heat unnecessarily. Use of the function is intended to maintain climate comfort when driver or passengers remain inside the car.

There is a limit to how long climate comfort can be maintained in a cold climate, which depends on the amount of residual heat available.

* Option/accessory.

8.4.5. Starting and switching off climate comfort when parking*

Climate comfort retention maintains the climate in the passenger compartment after driving. The function can use direct start from the centre display.



Open climate view in the centre display by pressing the symbol in the middle of the climate row.

2 Tap on **Use heat from drive** to start climate comfort.

➤ Climate comfort retention is started/switched off and the button illuminates/extinguishes.

 **Note**

It is not possible to start climate comfort retention if there is not enough residual heat in the engine to maintain the passenger compartment climate, or if the outside temperature is above approx. 20°C (68°F).

 **Note**

Climate comfort retention is switched off when the car is locked from the outside to avoid using residual heat unnecessarily. Use of the function is intended to maintain climate comfort when driver or passengers remain inside the car.

There is a limit to how long climate comfort can be maintained in a cold climate, which depends on the amount of residual heat available.

* Option/accessory.

8.5. Climate

The car is equipped with electronic climate control. The climate control system cools or heats as well as dehumidifies the air in the passenger compartment.

All climate control system functions are controlled from the centre display and physical buttons in the centre console.

Some functions for the rear seat can also be controlled from the climate controls* at the rear of the tunnel console.

Most climate functions can also be controlled using voice control. Some functions require an Internet connection for use with voice control.

 **Note**

If necessary, the climate control can be used to cool the media system in the centre display. In these cases, the message **Cooling infotainment system** is shown in the driver display.

* Option/accessory.

8.6. Servicing the climate control system

The air conditioning system must only be serviced and repaired by an authorised workshop.

Troubleshooting and repair

The air conditioning system contains fluorescent tracing agents. Ultraviolet light is used for leak detection.

Volvo recommends that an authorised Volvo workshop is contacted.

The car's climate control system uses R1234yf freon-free refrigerant. Information about the refrigerant is printed on a decal located on the inside of the bonnet.

 **Warning**

The air conditioning system contains pressurised refrigerant R1234yf. In accordance with SAE J2845 (Technician Training for Safe Service and Containment of Refrigerants Used in Mobile A/C System), service and repair of the refrigerant system must only be performed by trained and certified technicians in order to ensure the safety of the system.

8.7. Activating and deactivating ventilated front seat *

The seats can be ventilated to provide increased comfort in a hot climate, for example.

The ventilation system consists of fans in the seats and backrests that draw air through the seat upholstery. The cooling effect increases the cooler the passenger compartment air becomes. The system can be activated when the engine is running.

1



Press the left or right-hand side's steering wheel and seat button in the climate row in the centre display in order to open the controls for seat and steering wheel.

If the car is not equipped with heated seats or heated steering wheel (for the driver's side), the button for ventilated seats is immediately available in the climate row.



Repeatedly press the button for ventilated seats in order to change between the three levels: **High, Medium and Low.**

➤ The level changes and the button shows the set level.

* Option/accessory.

8.8. Climate control - sensors

The climate control system has a number of sensors to help control the climate in the car. Do not cover or block the sensors with clothing or other objects.

Sensor location

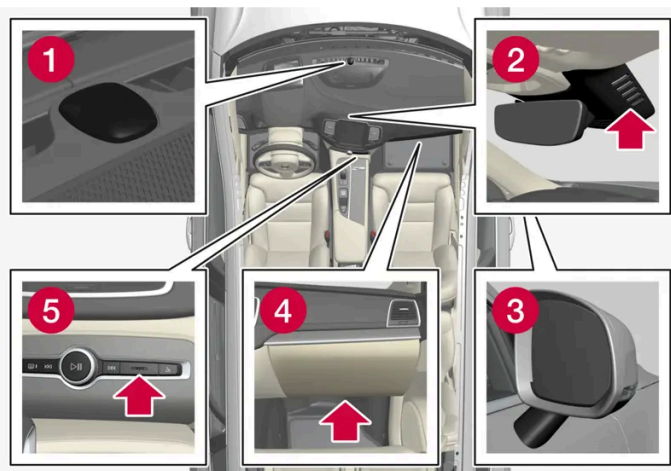

- 1 Sun sensor - on the upper side of the instrument panel.
- 2 Moisture sensor - in the casing by the interior rearview mirror.
- 3 Outside temperature sensor - in the right-hand door mirror.
- 4 Airborne particulate matter sensor* – on the underside of the glovebox.
- 5 Temperature sensor for the passenger compartment - by the physical buttons in the centre console.

With the Interior Air Quality System* there is also an air quality sensor that is fitted into the climate control system air intake.

* Option/accessory.

8.9. Climate zones

The number of climate zones that the car is divided into governs the options for setting different temperatures for different parts of the passenger compartment.

2-zone climate

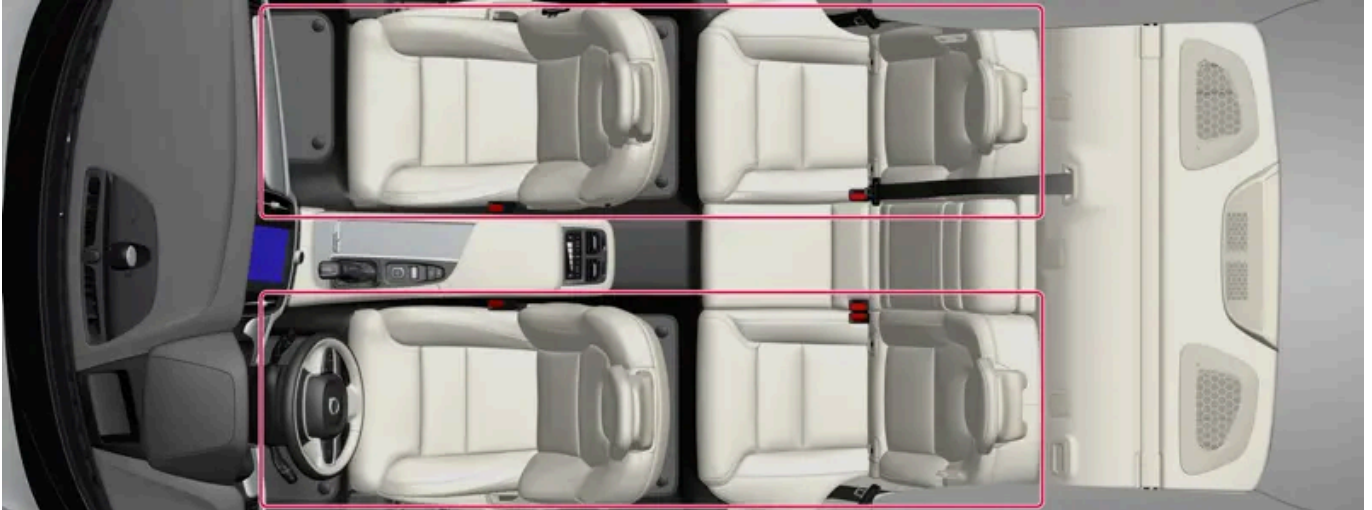

Climate zones with 2-zone climate.

With 2-zone climate, the temperature in the passenger compartment can be set separately for the left and right-hand sides.

4-zone climate *

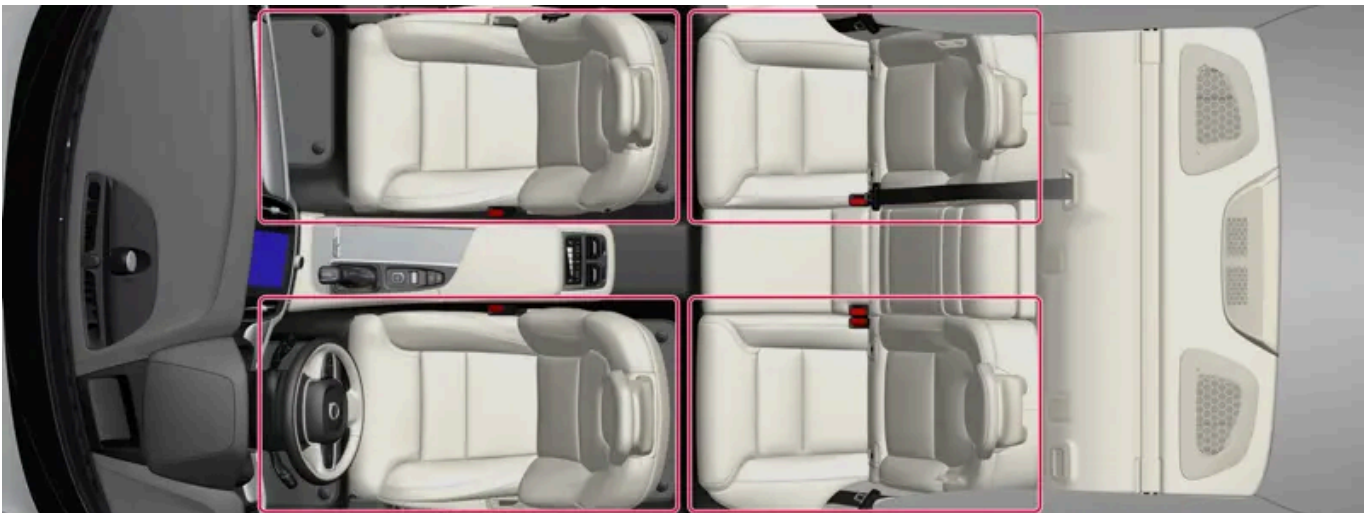

Climate zones with 4-zone climate.

With 4-zone climate the temperature in the passenger compartment can be set separately for the left and right-hand sides in both the front and rear seat.

* Option/accessory.

8.10. Perceived temperature

The climate control system regulates the climate in the passenger compartment based on the perceived temperature, not on actual temperature.

The temperature you select in the passenger compartment corresponds to the physically perceived temperature as affected by factors such as the ambient temperature, air speed, humidity, solar radiation, etc. in and around the car at the time.

The system includes a sun sensor which detects on which side the sun is shining into the passenger compartment. This means that the temperature can differ between the right and left-hand side's air vents despite the controls being set for the same temperature on both sides.

9. Key, locks and alarm

9.1. Key

9.1.1. User profiles

9.1.1.1. User profiles

Many of the settings defined in the car can be saved to a personal user profile.

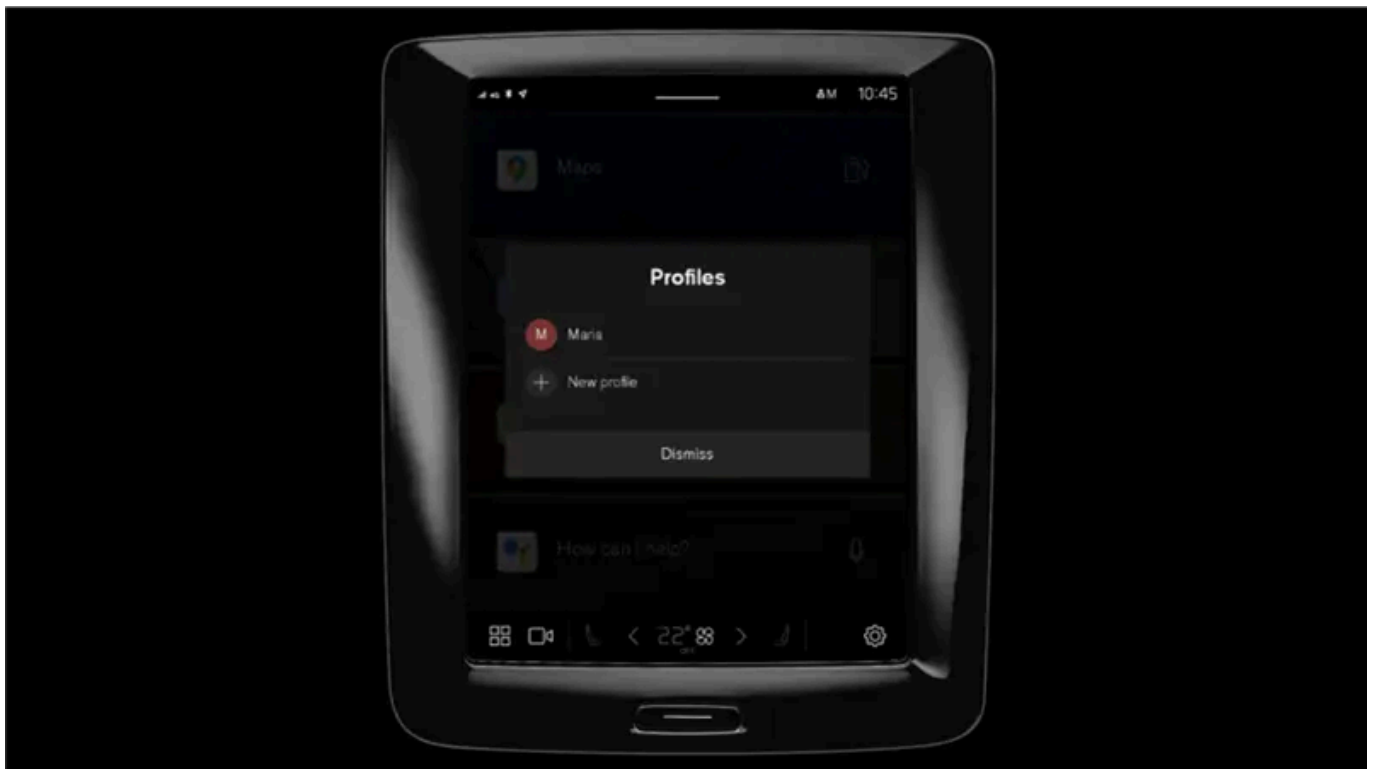

The **Owner** profile is pre-installed and active in the car on first use or after a factory reset.

The **Owner** profile has administrative privileges and cannot be deleted.

Drag down the notification view to access user profiles.

The status field shows a  symbol, together with the initials of the active profile. When the system is logged-out, no symbol/initials are shown in the status field.

Automatic profile selection

It is possible to connect your key to a profile. The profile, along with all of its settings, will then be selected automatically every time the specific key is identified during unlocking or opening the driver's door.

The last profile used is activated if a key is not linked with a specific profile.

General information about settings

Changes to the car's settings are saved in different ways depending on the category to which the settings belong. These settings may be personal, global or adapted for a drive cycle.

Personal preferences

Personal settings are saved to an active profile.

There are two kinds of personal settings:

- Car function settings – settings relating to driver support, driver side climate, the driver seat, the door mirrors, and interior and exterior lighting. These settings retain their values when a profile is added or when signing out from an active profile.
- Sound and media settings – settings relating to navigation, sound and media systems, apps and linked accounts. These settings return to default settings when a profile is added or when signing out from an active profile.

Global settings

The global settings are not changed when switching to a different profile. They remain the same regardless of which profile is active. Passenger side climate control, the passenger seat memory function, and certain system settings are examples of global settings.

Default drive cycle settings

A number of settings return to their defaults^[1] after a drive cycle.

The values for these settings can be adjusted while driving. After driving, it is returned to the default. At next drive cycle, the setting will have its default value again.

^[1] Default settings may vary depending on market

9.1.1.2. Link key to user profile

It is possible to connect your key to a profile. In this way, the profile, along with all of its settings, will then be selected automatically every time the specific key is identified during unlocking or opening the driver's door.

If the key has not been linked to a profile, the profile last used will be activated when the car is started. When the car is first started, the **Owner** profile is selected automatically.

Linking a key to a profile

Note

If the key was previously linked to another profile, the link is moved from the previous profile to the active profile.

- 1 Press .
- 2 Select **Profiles**.
- 3 Select **Connect key to profile** to connect a selected key to a profile.

It is only possible to connect a profile to the key that is currently being used in the car. If there are multiple keys in the car, the message **More than one key found. Place the key you want to connect on the backup reader.** will be displayed



Backup reader's location in the tunnel console.

Disconnecting a key from a profile

- 1 Press .
- 2 Select **Profiles**.
- 3 Select **Disconnect key from profile** to remove the active profile from the connected key.

It is possible to disconnect a key from a profile even if the key is not in the car.

9.1.1.3. Managing user profiles

It is possible to switch to another profile even if the key being used is linked to a different profile.

Creating a profile

- 1 Drag down the notification view to access user profiles.
- 2 Tap on the active profile.
- 3 Select **New profile**.
- 4 The profile is created.
 - The profile is set as the active profile.

You will be guided through an interactive flow to help you set up the new profile. There you can choose to pair a phone with the car or to link different accounts, such as Volvo ID, to the profile. It is also possible to skip certain steps and complete them later.

It is possible to create up to six different profiles.

Selecting a profile

- 1 Drag down the notification view to access user profiles.
- 2 Tap on the active profile.
- 3 Selectable profiles are displayed.
- 4 Select the desired profile.
 - The profile is selected and the system loads the settings for the selected profile.

Note

To cancel the moving of the seat when changing the profile, tap on any of the buttons on the seat part of the front seat.

Signing out a profile

- 1 Drag down the notification view to access user profiles.
- 2 Select **Log out**.
 - Signing out takes place from the profile and it is no longer possible to access the accounts linked with that profile.
- 3 The system is preset to a signed-out mode and settings changed are not saved to a profile.

 **Note**

To create, select and logout of a user profile is only possible when the car is stationary.

9.1.1.4. Profile settings

From profile settings, it is possible to change profile name, add and remove linked keys, link different accounts (such as Volvo ID), activate the lock screen, and delete the active profile, among other things.

Activating the screen lock

When the screen lock is activated, a passcode is required to be able to use the active profile.

- 1 Press .
- 2 Select **Profiles**.
- 3 Select **Screen lock**.
- 4 Select the type of screen lock and then activate.
 - The screen lock will be shown in the centre display when switching to a profile, and also every time the system is restarted.

Deleting a profile

Settings that have been saved to one or more profiles can only be deleted if the car is stationary.

- 1 Press .
- 2 Select **Profiles**.
- 3 Select **Delete this profile**.
 - User information and connections linked to the profile are deleted.
- 4 The system is preset to a signed-out mode and settings changed are not saved to a profile.

Become an administrator

It is possible to set a profile as administrator.

- 1 Press .
- 2 Select **Profiles**.
- 3 Select **Become an admin**.

Changing the name of a profile

- 1 Press .
- 2 Select **Profiles**.
- 3 Tap on **Edit** next to the current profile name.
- 4 Change the profile name and confirm the change.

9.1.1.5. Link account to user profile

It is possible to add accounts to a selected user profile. Examples of accounts that can be added are Volvo ID and Google account.

Adding an account

- 1 Press .
- 2 Select **Profiles**.
- 3 Select **Accounts**.
- 4 Select to add account.
 - A list of accounts that can be added is shown.
- 5 Select the desired account.

Then follow the instructions shown. The instructions depend on the type of account selected.

9.1.2. Immobiliser

The content of this manual represents the status of the user manual at the time of printing and may not be completely valid in future instances. For more information, refer to the first page for the complete disclaimer note.

The electronic immobiliser is an anti-theft device that prevents the car from being driven if the correct car key is not found.

The car can only be started with the correct key.

9.1.3. Keys

The car's physical keys are available in different variants. The car detects when a key is in the front part of the passenger compartment, and the car can then be started.



Available key types are standard key, Key Tag*, and Care Key.^[1]

The standard key and Care Key are equipped with buttons. Additional keys to the number included as standard can be ordered. For cars equipped with keyless locking and unlocking*, a slightly smaller, lighter and button-less key (Key Tag) can be pur-

chased as an accessory.

To start the car, a key needs to be within the front part of the passenger compartment.

For cars equipped with keyless locking and unlocking (Passive Entry)* the key can be anywhere in the car to start the car.

These keys can be linked to different user profiles to save personal preferences in the car.

Warning

The key contains a button cell battery. Keep new and used batteries out of the reach of children. If someone swallows a battery it may cause serious injury.

If damage is discovered, e.g. if the battery cover cannot be closed properly, then the product should not be used. Keep defective products out of the reach of children.

Standard key and its buttons



The key has four buttons - one on the left-hand side and three on the right-hand side.

Locking

One press on the button locks the car and arms the alarm*.

One long press closes all windows as well as the panoramic roof*.

Unlocking

One press on the button unlocks the car and disarms the alarm*. One long press opens all windows simultaneously. This can be used, for example, to quickly air a hot car before getting into it.

Tailgate

One press on the button disarms the alarm* and unlocks the tailgate. On cars with power operated tailgate*, the tailgate is opened or closed with one long press. An acoustic warning signal sounds when the tailgate is opened or closed.

Panic function

The panic function is used to attract attention in an emergency. Press and hold the button for at least 3 seconds or press it twice within 3 seconds to activate the car's direction indicators and the horn. The function can be switched off using the unlock button after it has been active for at least 5 seconds. Otherwise it is deactivated automatically after 2 minutes and 45 seconds.

Warning

If anyone is left in the car, make sure the power windows and panoramic roof* are de-energised by taking the key with you when you leave the car.

Note

A key that has been locked in the car is temporarily deactivated and cannot be used before the car has been unlocked using another valid key.

The double lock^[2] function is also deactivated.

Button-less key (Key Tag)*

A Key Tag can be ordered as an accessory for cars equipped with the keyless locking and unlocking function. Starting and keyless locking and unlocking work in the same way as with the standard key. The key is waterproof to a depth of approx. 10 metres (30 feet) for up to 60 minutes. It does not have extending key blade, and the battery cannot be replaced.

Care Key

You can set a speed limit that is active when the Care Key is used. The limitation is intended to encourage the car to be driven in a safe manner, e.g. when being loaned out.

If the active key is removed from the car



If the key is removed from the car when the engine is running, the warning message, **The car key is not detected.** See **Owner's Manual for more information.**, is shown in the driver display and an acoustic reminder sounds when the last door is closed.

The message disappears when the key is returned to the car, followed by a press of the right-hand keypad's **O** button, or when all doors have been closed.

Interference

Key functions for keyless starting and keyless locking and unlocking* can be disrupted by electromagnetic fields and screening.

Note

Avoid storing the car's keys close to metal objects or electronics (e.g. mobile phones, tablets, laptops or chargers). Preferably no closer than 10-15 cm (4-6 inches).

If there is still interference - use the key's detachable key blade to unlock. Then place the key in the back-up reader in the cup holder to disarm the alarm and allow the car to be started.

 **Note**

When the key shall be read by the back-up reader, make sure that the cup holder is separate from other nearby car keys, metal objects and electronics (e.g. mobile phones, tablets, laptops or chargers). These objects may disrupt the functions.

* Option/accessory.

^[1] The figure is schematic - parts may vary depending on car model.

^[2] Applies to the United Kingdom and Ireland.

9.1.4. Ordering additional keys

If a key is lost or you need more keys than the standard number, it is possible to order new keys. If the car is equipped with keyless locking and unlocking* a button-less key (Key Tag) can also be ordered.

A total of twelve keys can be programmed and used for one single car. If additional keys are ordered, additional driver profiles are added – one per new key. This also applies for the key tag.

If you lose a key

If you lose a key then a new one can be ordered through a Volvo dealer or an authorised Volvo workshop. The code of the missing key must be erased from the system as a theft prevention measure. Access to all remaining keys is required during a workshop visit.

* Option/accessory.

9.1.5. Replacing the battery in the key

The battery in the key can be replaced when it has discharged. The service life of the battery depends on how much the key is used. The Key Tag* battery cannot be replaced.

 **Note**

All batteries have a limited service life and must eventually be replaced (does not apply to Key Tag). The service life of the battery varies depending on how often the vehicle/key is used.



The key's battery needs to be replaced when the information symbol is illuminated and the **The car key battery is low**. See **Owner's Manual for replacement**. message is shown in the driver display.

Another sign that the battery level is low is decreased range for the key.

The battery in the Key tag (Key Tag)* cannot be replaced. When the battery is discharged, a new Key tag can be ordered from an authorised Volvo workshop.

! Important

Hand in a discharged Key Tag to an authorised Volvo workshop where it can be deleted from the car's system. The key can still be used to start the car via back-up start when the battery has been discharged.

Opening the key and changing its battery

! Important

Avoid touching the contact surfaces of a new battery with your fingers. This impairs the battery's functionality.

Hold the key so that its front with the Volvo logotype is facing up, and with the keyring bracket facing you.

There is a catch on the left of the keyring bracket. If it is on the wrong side then the front and rear have been mixed up when the battery was replaced on an earlier occasion.

1 **1**



Slide the catch by the keyring bracket to the side, and slide the front shell away from the bracket.

- The shell detaches and can be lifted off.
There is a further catch under the shell to detach the rear.

2 **2**



Slide the catch that was behind the front shell to the side, and slide the rear shell away from the key ring bracket.

The content of this manual represents the status of the user manual at the time of printing and may not be completely valid in future instances. For more information, refer to the first page for the complete disclaimer note.

- The shell detaches and can be lifted off.
The battery cover is under the shell.

3 **3**



Turn the battery cover anticlockwise to OPEN position. Use a screwdriver or a coin, for example.
Lift off the battery cover. If it is difficult to detach, you can prize it upward using a narrow tool.

4 **4**



The battery (+) side is facing upwards. Loosen the battery by pressing on its edge and then lifting it out.

5 **5**



Install a new battery with the (+) side up. Avoid touching the key's battery contacts with your fingers.

Position the edge of the battery under the two outer plastic catches.

Then press down on the battery so that it is held in place by the upper plastic catch.

i Note

Use batteries with the designation CR2032, 3 V.

Note

Volvo recommends that replacement batteries for the key meet UN Manual of Test and Criteria, Part III, sub-section 38.3. The batteries that are included or the batteries used for replacement by an authorised Volvo workshop will meet the same criterion.

6



Refit the battery cover and turn clockwise to CLOSE position.

7



Refit the rear shell in reverse order to how it was removed. There is no logotype on the rear shell. Press in the shell until you hear a click, and then slide it the last few millimetres to its original position.

- A further click will indicate that the shell is properly positioned and securely attached. There must be no gaps remaining.

8



Turn the key and refit the front shell in the same way as for the rear.

 **Warning**

Check that the battery is fitted correctly with the correct polarity. If the key shall not been used for a long time, remove the battery to avoid battery leakage and damage. Batteries with damage or leaks may cause corrosive injury on contact with the skin. Therefore, use protective gloves when handling damaged batteries.

- Keep batteries out of the reach of children.
- Do not leave batteries lying around since they can be swallowed by children or pets.
- Batteries must not: be dismantled, short-circuited or thrown into open flames.
- Do not try to charge non-rechargeable batteries. They may explode.
- Check battery operated products for signs of damage on a regular basis.

The key should not be used if anything indicates that the key or its battery has been damaged or has started to leak. Keep defective products out of the reach of children.

 **Important**

Used batteries must be recycled in an environmentally sound manner.

* Option/accessory.

9.1.6. Locking and unlocking with the key's buttons

You can use the key's buttons to lock or unlock the whole car. ^[1]



Locking with the key's buttons

- 1 Press the  button to lock the car.

The driver's door must be closed for the lock sequence to be activated^[2]. If any of the other doors or the tailgate is open, then these are not locked and their alarms armed* until they are closed. The alarm's movement detectors* are activated when all the doors and the tailgate are closed and locked.

Note

A key that has been locked in the car is temporarily deactivated and cannot be used before the car has been unlocked using another valid key.

The double lock^[3] function is also deactivated.

Locking when the tailgate is open

Note

If the car has been locked while the tailgate is open, be careful not to leave the key in the cargo area when the tailgate is closed^[2].

Unlocking with the key's buttons

- 1 Press the  button to unlock the car.

Automatic relocking

If none of the doors or the tailgate is opened within 2 minutes of unlocking, they are locked automatically. This function prevents the car from being left unlocked unintentionally.

If the key is not working

If the key's buttons stop working then its battery may be discharged – in which case, replace the battery or use the detachable key blade.

^[1] Also applies to the fuel filter flap.

* Option/accessory.

^[2] If the car is equipped with keyless locking/unlocking* then all side doors must be closed.

^[3] Applies to the United Kingdom and Ireland.

9.1.7. Care Key – speed limit key

A Care Key makes it possible for the owner of the car to limit the maximum speed of the car. The speed limit is intended to encourage the car to be driven in a safe manner such as when being loaned out, for example.



The button functions for Care Key are the same as for the standard key. The car and the key work as normal if no speed limit has been set. As with other keys, Care Key can be linked to a user profile in order to save personal settings in the car.

The speed limit can be set via the administrator user profile. The speed limit is activated when the car is unlocked using Care Key, or when the driver door is opened and the car detects a Care Key on the driver's side.

The option of setting a speed limit when using a specific key is intended to increase safety when entrusting the car to e.g. a young or unexperienced driver, valet parking, or a workshop.

9.1.8. Setting the speed limit for Care Key

The speed limit for Care Key is set in the centre display.

The speed limit for Care Key can only be set from a profile with administrative privileges. To access the settings:

- 1 Press  in the centre display.
 - 2 Select **Profiles**.
 - 3 Select **Care key**.
 - 4 Activate **Speed limit** and select the desired maximum speed^[1].
- The speed limit is activated when the car is used with Care Key.

The car must be unlocked using a key without limit in order to deactivate the function. The speed limit for Care Key can be deactivated via settings in the centre display. Care Key can then be used like a regular key.

Indication in driver display

An active speed limit is indicated by a symbol in the driver display as well as a message **Speed limitation cannot be exceeded Care Key in use**. A yellow dotted line on the speedometer shows the current speed limitation.

Symbol	Specification
	Speed limitation is active.

^[1] A possible interval is 50-150 km/h (30-95 mph), with increments of 10 km/h (5 mph).

9.1.9. Unlocking the tailgate with a key button

There is a button on the key to unlock the tailgate only.

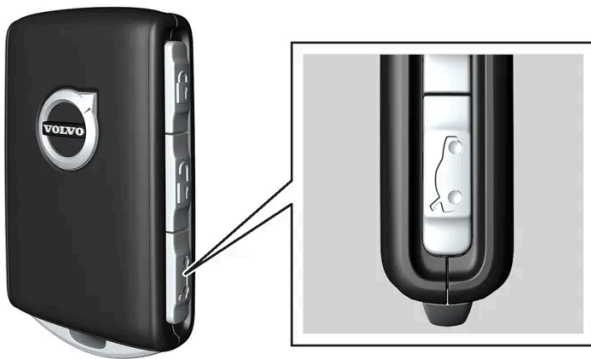

- 1 Press the key's  button.
 - > The tailgate is unlocked but remains closed.
The side doors are still locked and the alarm is armed*. The lock and alarm indicator on the instrument panel extinguishes in order to show that the entire car is not locked.
You can open the tailgate by gripping the rubberised pressure plate underneath its lower edge.
If the tailgate is not opened within 2 minutes then it is relocked and the alarm is re-armed.

Power operated tailgate*

- 1 Hold the key's  button depressed for a couple of seconds.

The content of this manual represents the status of the user manual at the time of printing and may not be completely valid in future instances. For more information, refer to the first page for the complete disclaimer note.

➤ The tailgate is unlocked and opened, while the side doors remain locked and their alarm functions armed*.

Note

If the system for the power operated tailgate* works continuously for a long time, it is deactivated in order not to overload it. It can be used again after a few minutes.

* Option/accessory.

9.1.10. Detachable key blade

The standard key contains a detachable key blade in metal with several different functions.

The key blade's unique code is provided by authorised Volvo workshops, which are recommended when ordering new key blades.

The key blade's application areas

Using the key's detachable key blade, the following are possible:

- the left-hand front door can be opened manually if central locking cannot be activated by pressing a button
- all doors are emergency-locked
- the rear doors' mechanical child lock can be activated and deactivated.

If the key blade has been used to unlock the car, the alarm can be disarmed and the car started by placing the key in the back-up reader in the tunnel console's cup holder.

The Key Tag accessory does not have a detachable key blade.

Taking out the key blade

Hold the key so that its front with the Volvo logotype is facing up, and with the keyring bracket facing you.

There is a catch on the left of the keyring bracket. If it is on the wrong side then the front and rear have been mixed up when they were assembled on an earlier occasion.

1 **1**



Slide the catch by the keyring bracket to the side, and slide the front shell away from the bracket.

➤ The shell detaches and can be lifted off.

2 **2**



Remove the key blade.

3 **3**



Refit the front shell in reverse order to how it was removed. Press in the shell until you hear a click, and then slide it the last few millimetres to its original position.

➤ A further click will indicate that the shell is properly positioned and securely attached. There must be no gaps remaining.

9.1.11. Locking and unlocking with the detachable key blade

The detachable key blade can be used to unlock one of the car's doors from the outside – such as if the battery in the key is discharged.

Unlocking with the key blade

Note

When the door is unlocked using the key blade and is then opened, the alarm is triggered. The alarm must be deactivated manually – it may be a good idea to read that section before opening the car.

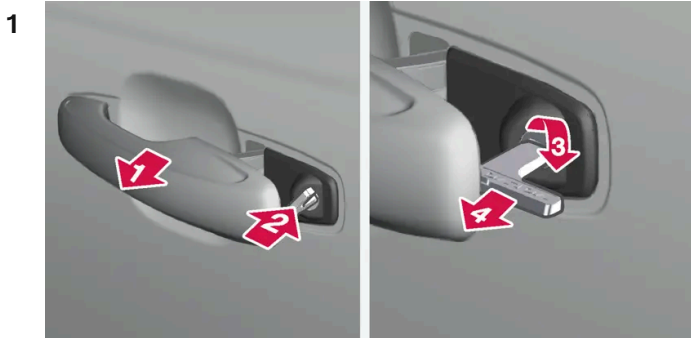

1 

Pull out the front door's handle on the left-hand side of the car to its end position.

2 

Insert the key.

3 

Turn clockwise 45 degrees so that the key is pointing straight back.

4 

Turn the key back 45 degrees to its starting position and remove it.

➤ The door can be opened using the handle.

Locking with the key blade

The left-hand front door can be locked using the detachable key blade.

Other doors have a lock reset on the end face that must be pressed in using the key blade. Then they are mechanically locked against opening from the outside, but can be opened from the inside.

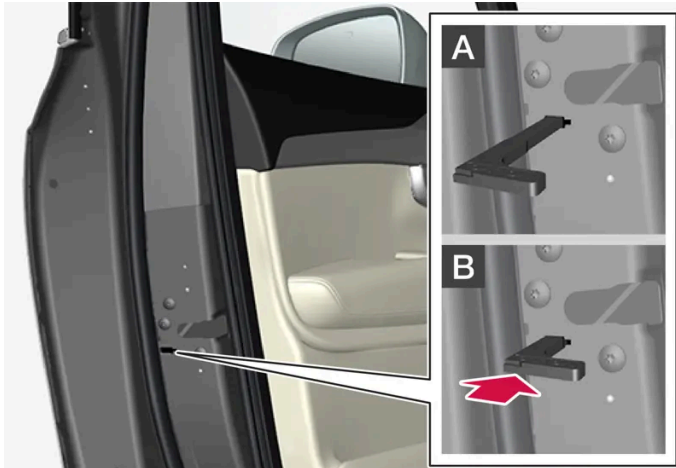

Manual locking of the door. Not to be mixed up with child locks.

- 1 Remove the detachable key blade from the key with buttons.
- 2 Insert the key blade in the hole for lock reset.
- 3 Press in the key until it bottoms – approximately 12 mm (0.5 inches).

A The door can be opened from both the outside and the inside.

B The door is blocked against opening from the outside. To return to position A, the inner door handle must be opened.

Note

- A door's lock reset only locks that particular door - not all doors simultaneously.
- A manually locked rear door with enabled child lock cannot be opened from either insider or outside. Unlocking is possible using the buttons on the key, the central locking button, the keyless locking system * or by using the Volvo Cars app.

* Option/accessory.

9.1.12. The key's range

In order for the key to work properly, it needs to be within a certain distance from the car.

Physical barriers between the key and the car may have an adverse effect on the range or completely block the signal.

Using the key's buttons

The key's functions that are controlled by pressing a button have a range of approx. 20 metres (65 feet) from the car.

If the car does not verify a button being pressed - move closer and try again.

For keyless* use

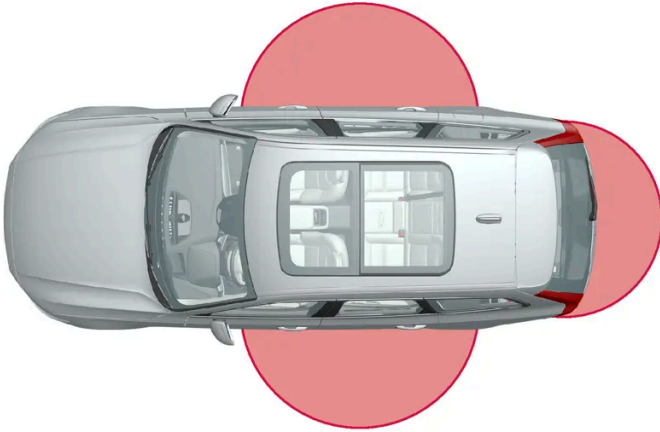

For keyless use, a key must be within a distance of approx. 1 to 1.5 metres (3 to 5 feet) from the car's doors or tailgate.

Note

The key functions may be disrupted by surrounding radio waves, buildings, topographical conditions, etc. The car can always be locked/unlocked with the key blade.

* Option/accessory.

9.1.13. Type approval for remote control key system



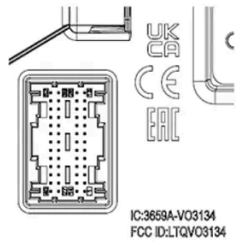
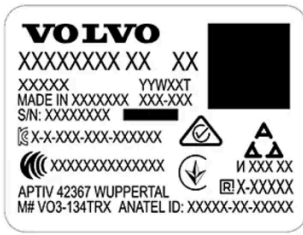

Type approval for the car's remote key system can be seen in the following tables.

Lock system keyless start (Passive Start) and keyless locking/unlocking (Passive

Entry*)



CEM marking for the remote control key system. For supplementary type approval numbers, see following tables.









Country/Area	Type approval	
Argentina		See the illustration below the table.
Brazil	MT-3245/2015	 <p>ANATEL 0589-15-6830 (01) 0 7897843840961</p>
Europe	Delphi Deutschland GmbH, 42367 Wuppertal hereby declares that this VO3-134TRX conforms to the essential property requirements and other relevant provisions contained in directive 2014/53/EU (RED).	
The United Arab Emirates	ER37847/15 DA0062437/11	
Indonesia	Nomor: 38301/SDPPI/2015	
Jordan	TRC/LPD/2014/250	
Malaysia	RAAT/37A/1215/S(15-5198)	
Mexico	IFETEL: RLVDEVO15-0396	
Namibia	TA-2016-02	 <p>CRAN Communications Regulatory Authority of Namibia</p>
Russia		
Serbia	P1614120100	
South Africa	TA-2014-1868	

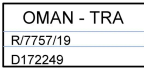

H-25867







Remote control key







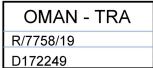

Country/Area	Type approval	
Europe	Huf Hülsbeck & Fürst GmbH & Co. KG hereby declares that this type of radio equipment HUF8423MS conforms to directive 2014/53/EU. Wavelength: 433.92 MHz Maximum radiated transmission power: 10 mW Manufacturer: Huf Hülsbeck & Fürst GmbH & Co. KG, Steeger Str. 17, 42551 Velbert, Germany	
Argentina		See the illustration below the table.
Brazil	Anatel: 06768-19-06643 Modelo: HUF8423MS Este equipamento opera em caráter secundário isto é não tem direito a proteção contra interferência prejudicial, mesmo de estações do mesmo tipo, e não pode causar interferência a sistemas operando em caráter primário.	
Philippines	ESD-1919938C	
The United Arab Emirates		
Ghana	NCA Approved: ZRO-M8-7E3-138	
Indonesia ^[1]	Sertifikat Nomor: 86806/SDPPI/2022 PLG ID: 8093	
CU (Customs Union) Kazakhstan, Russia		
Morocco	AGREE PAR L'ANRT MAROC Numéro d'agrément: MR 20402 ANRT 2019 Date d'agrément: 10/07/2019	
Moldova		

Country/Area	Type approval	
Nigeria	Connection and use of this communication equipment is permitted by the Nigerian Communications Commission	
Oman		
Paraguay	HUF8423MS	
Serbia		
Singapore	Complies with IMDA Standards DA103787	
South Africa	TA-2019/772	
Taiwan	<p>????????????????????</p> <p>????????????????????</p> <p>.1</p> <p>????????????????????</p> <ul style="list-style-type: none"> ???????????????????? <p>.2</p> <p>????????????????????</p> <ul style="list-style-type: none"> ???????????????????? ???????????????????? <p>????????????????????</p> <ul style="list-style-type: none"> ?????? 	
Ukraine	Справжнім Huf Hülsbeck & Fürst GmbH & Co KG заявляє, що тип радіообладнання відповідає Технічному[HUF8423MS] регламенту радіообладнання; повний текст -декларації про відповідність доступний на веб :сайті за такою адресою Робоча частота: 433,92 ГГц	
Vietnam		
Belarus		
Zambia		

H-23694

Key Tag

Country/Area	Type approval	
Europe	Huf Hülsbeck & Fürst GmbH & Co. KG hereby declares that this type of radio equipment HUF8432MS conforms to directive 2014/53/EU. Wavelength: 433.92 MHz Maximum radiated transmission power: 10 mW Manufacturer: Huf Hülsbeck & Fürst GmbH & Co. KG, Steeger Str. 17, 42551 Velbert, Germany	
Argentina		See the illustration below the table.
Brazil	Anatel: 04362-16-06643 Modelo: HUF8432MS Este equipo opera em caráter secundário isto é não tem direito a proteção contra interferência prejudicial, mesmo de estações do mesmo tipo, e não pode causar interferência a sistemas operando em caráter primário.	
Ghana	NCA Approved: ZRO-M8-7E3-139	
Philippines	ESD-1919939C	
The United Arab Emirates		
CU (Customs Union) Kazakhstan, Russia		
Indonesia ^[1]	Sertifikat Nomor: 86808/SDPPI/2022 PLG ID: 8093	
Morocco	AGREE PAR L'ANRT MAROC Numéro d'agrément: MR 20403 ANRT 2019 Date d'agrément: 10/07/2019	
Moldova		

Country/Area	Type approval	
Nigeria	Connection and use of this communications equipment is permitted by the Nigerian Communications Commission	
Oman		 <p>OMAN - TRA R/7758/19 D172249</p>
Paraguay	HUF8432MS	 <p>HUF8432MS CONATEL NR.2019-08-I-0448</p>
Serbia		 <p>005 19</p>
Singapore	Complies with IMDA Standards DA103787	
South Africa	TA-2019-773	
Taiwan	<p>????????????????????</p> <p>????????????????</p> <p>.1</p> <p>????????????????????</p> <ul style="list-style-type: none"> ???????????????????? <p>.2</p> <p>????????????????????</p> <ul style="list-style-type: none"> ???????????????????? ???????????????????? <p>????????????????????</p> <ul style="list-style-type: none"> ?????? 	
Ukraine	Справжнім Huf Hülsbeck & Fürst GmbH & Co KG заявляє, що тип радіообладнання відповідає Технічному[HUF8432MS] регламенту радіообладнання; повний текст -декларації про відповідність доступний на веб :сайті за такою адресою Робоча частота: 433,92 ГГц	
Vietnam		 <p>ICT</p>
Belarus		
Zambia		 <p>ZMB/ZICTA/TA/2019/7/121</p>

H-23695

Central Electronic Module

Country/Area	Type approval	
Indonesia	Sertifikat Nomor: 85998/SDPPI/2022 PLG ID: 13809	

* Option/accessory.

^[1] Only applies to Indonesia.

9.1.14. Antenna locations for the start and lock systems

An antenna for the keyless starting system and antennas for the keyless locking system* are built into the car.

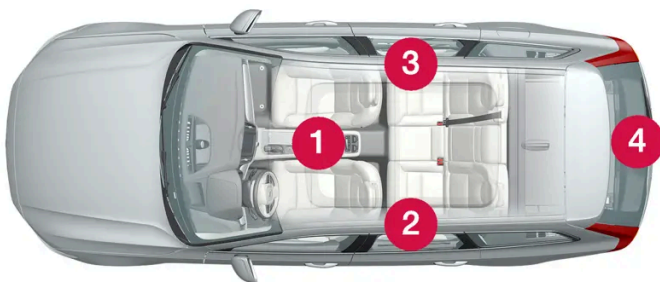

Antenna locations:

- 1 Under the cup holder in the front section of the tunnel console
- 2 In the upper front section of the left-hand rear door^[1]
- 3 In the upper front section of the right-hand rear door^[1]

 **Warning**

People with an implanted pacemaker should keep it at a distance of at least 22 cm (9 inches) away from the antennas to prevent interference between the pacemaker and the key system.

* Option/accessory.

^[1] Only in cars equipped with keyless locking and unlocking*.

9.1.15. Ignition positions

The car's electrical system can be set in different levels/positions and in this way make the different functions available.

In order to facilitate the use of a limited number of functions with the engine switched off, the car's electrical system can be set in three different levels – **0**, **I** and **II**. These levels are described with the denomination "ignition position" throughout the owner's manual.

The following table shows the functions available in each ignition position/level:

Level	Functions
0	<ul style="list-style-type: none">• Odometer, clock and temperature gauge are illuminated^[1].• Power* seats can be adjusted.• The centre display is started and can be used^[1].• The infotainment system can be used^[1]. <p>In this mode, the functions are controlled by time and are switched off automatically after a short while.</p>
I	<ul style="list-style-type: none">• Panoramic roof, power windows, 12V power socket in the passenger compartment, Bluetooth, navigation, phone, ventilation fan and windscreen wipers can be used.• Power seats can be adjusted.• 12 V power sockets* in the cargo area can be used. <p>Power is taken from the battery in this ignition position.</p>
II	<ul style="list-style-type: none">• The headlamps come on.• Warning/indicator lamps illuminate for 5 seconds.• Several other systems are activated. However, heating in seat cushions and the rear window can only be activated after the car has been started. <p>This ignition position consumes a lot of current from the battery and should therefore be avoided!</p>

^[1] Also activated when the door is opened.

* Option/accessory.

9.1.16. Selecting ignition mode

The car's electrical system can be set in different levels/positions and in this way make the different functions available.

Selecting ignition position



Start knob in the tunnel console.

- **Ignition position 0** – Unlock the car and store the key inside the car.

Note

To reach level I or II **without** starting the engine – do **not** depress the brake pedal when these ignition positions are to be selected.

- **Ignition position I** – Turn the start knob clockwise and release it. The control automatically returns to its starting position.
- **Ignition position II** – Turn the start knob clockwise and hold it in position for approx. 5 seconds. Then release the knob, which automatically returns to its starting position.
- **Back to ignition position 0** – To return to ignition position 0 from position I and II – Turn the start knob clockwise and release. The control automatically returns to its starting position.

9.2. Locking and unlocking

9.2.1. Keyless locking and unlocking

9.2.1.1. Operating the tailgate with foot movement*

The tailgate can be opened and closed using a foot movement* under the rear bumper. The function makes things easier when your hands are full.



If the car is equipped with keyless locking and unlocking* then you can unlock the tailgate using a foot movement.

The function with both opening and closing of the tailgate is also available when the car is equipped with power operated tailgate*.

Note

The foot-operated tailgate function is available in two versions:

- Opening and closing with foot movement
- Only unlocking with foot movement (lift up the tailgate manually to open it)

Note that the function for opening and closing with foot movement requires power operated tailgate*.

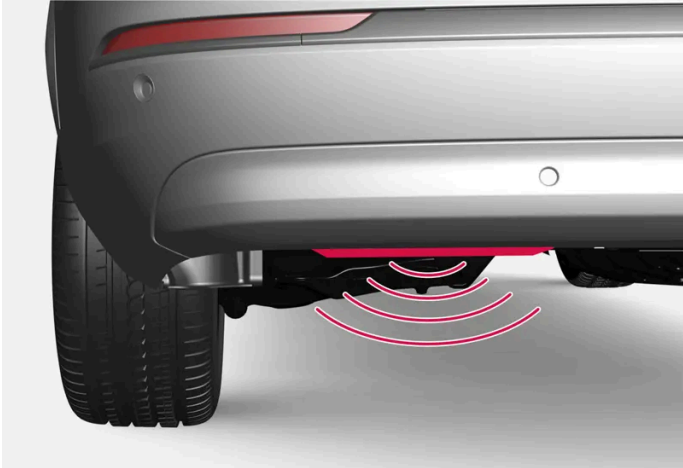

The sensor is located slightly to the left of the bumper.

One of the car's keys must be within range behind the car, approx. 1 metre (3 feet), for opening and closing to be possible. This also applies to an already unlocked car in order to avoid accidental opening e.g. in a car wash.

Opening and closing with foot movement

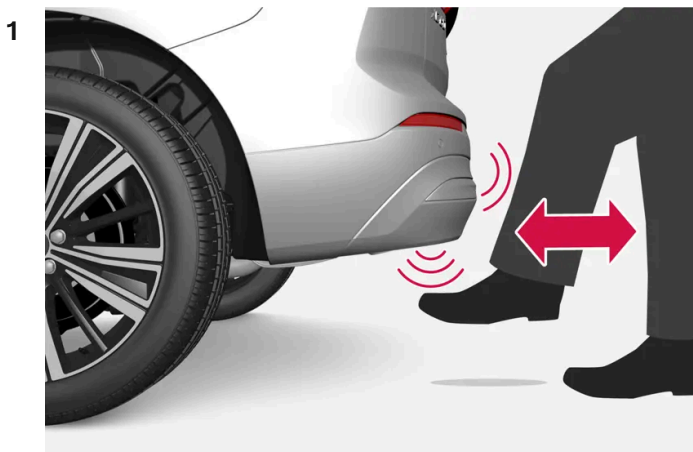

Make **one** forward kicking motion in the sensor area under the rear bumper. Then take a step back. The bumper must not be touched.

- A short acoustic signal sounds when opening or closing is activated - the tailgate is opened/closed.

If several kicking motions take place without a key sufficiently close, opening will not be possible until after a certain delay.

The content of this manual represents the status of the user manual at the time of printing and may not be completely valid in future instances. For more information, refer to the first page for the complete disclaimer note.

Do not leave your foot in the kicking motion under the car, this could cause activation to fail.

Cancelling opening or closing with foot movement

- 1 Make **one** forward kicking motion while opening or closing is in progress.
 - Opening or closing the tailgate is stopped.

The key does not need to be in the vicinity of the car to cancel opening or closing of the tailgate.

If the tailgate is stopped close to closed position, the next activation will open the tailgate.

i Note

Make sure you keep the area around the foot movement detector clean. A build-up of dirt, ice or snow may disrupt its function.

i Note

Pay attention to the possibility that the system may be activated in a car wash if the key is within range.

* Option/accessory.

9.2.1.2. Antenna locations for the start and lock systems

An antenna for the keyless starting system and antennas for the keyless locking system* are built into the car.

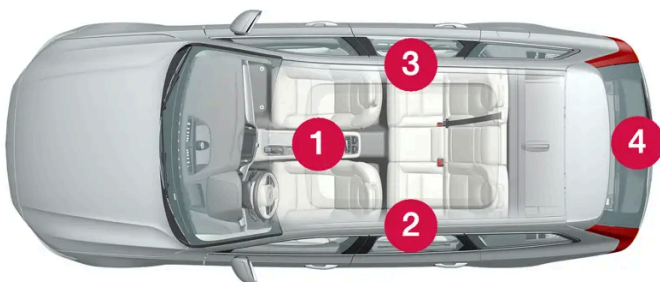

Antenna locations:

- 1 Under the cup holder in the front section of the tunnel console
- 2 In the upper front section of the left-hand rear door^[1]
- 3 In the upper front section of the right-hand rear door^[1]
- 4 In the cargo area^[1]

 **Warning**

People with an implanted pacemaker should keep it at a distance of at least 22 cm (9 inches) away from the antennas to prevent interference between the pacemaker and the key system.

* Option/accessory.

^[1] Only in cars equipped with keyless locking and unlocking*.

9.2.1.3. Keyless locking and unlocking with touch-sensitive surfaces*

With the keyless locking and unlocking function, there is no need to use the key's buttons – the key just needs to be near the car. The car is locked or unlocked via a touch-sensitive surface on the door handle.

Touch-sensitive surfaces

Door handle

The outside of the door handles contains a recess for locking, while the inside contains a touch-sensitive surface for unlocking.

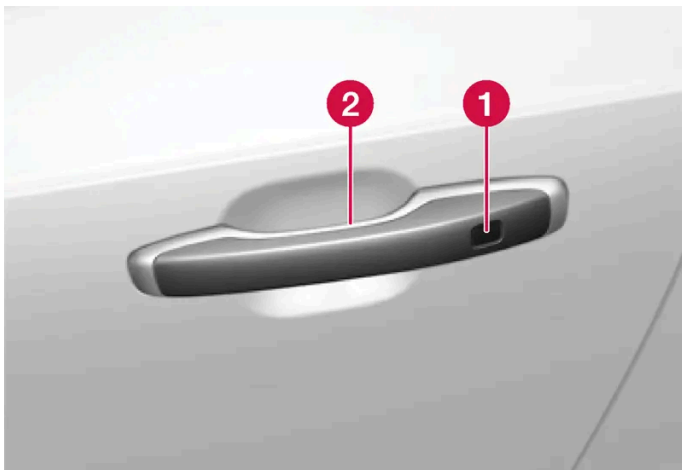

- 1 Touch-sensitive recess for locking
- 2 Touch-sensitive surface for unlocking

i Note

It is important that only one touch-sensitive surface is activated at a time. Gripping the handle while touching the lock surface risks giving double commands. This means that the requested activity (locking/unlocking) will not be executed, or will be executed with a delay.

Tailgate handle

The tailgate handle has a rubberised pressure plate underneath that is only used for unlocking.

i Note

Be aware that the system may be activated in connection with car washing if the key is in range.

* Option/accessory.

9.2.1.4. Keyless locking and unlocking*

With keyless locking and unlocking, it is sufficient to touch the door handle's touch-sensitive surfaces to lock or unlock the car. There must be a key in the vicinity of the car.

i Note

One of the car's keys must be within range for locking and unlocking to work.

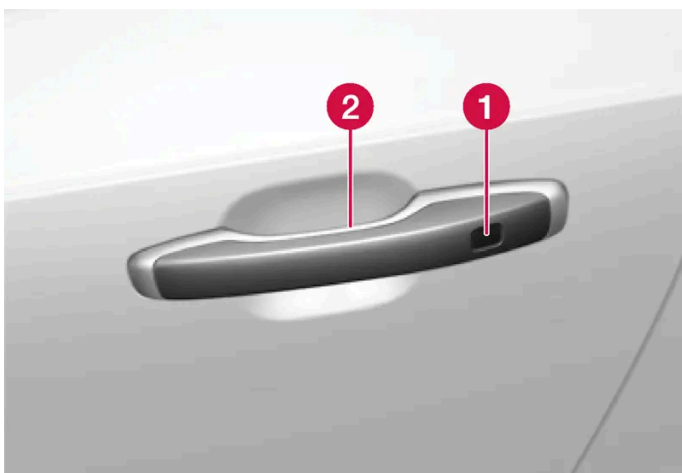

- 1** Touch-sensitive recess for locking
- 2** Touch-sensitive surface for unlocking

 **Note**

Be aware that the system may be activated in connection with car washing if the key is in range.

Keyless locking

You can activate keyless locking by touching the handle on the car when it is fully closed.

When the tailgate is open, you can also lock using the handles on the side doors. In such a case, the tailgate locks after being closed.

- 1 Touch the marked surface on the outside of a door handle after the door has been closed.
You can also lock the car using the keyless function by pressing the  button on the lower edge of the tailgate, and then closing it.

> The lock indicator on the instrument panel starts to flash to confirm that the car is locked.

Closing the windows with keyless locking

To simultaneously close all side windows and the panoramic roof* - hold a finger against the touch-sensitive recess on the outside of the door handle until they have closed.

Locking when the tailgate is open

If the car has been locked and the tailgate is still open, make sure that the key has not been left in the cargo area when the tailgate is closed.

 **Note**

If the key is detected inside the car, the tailgate will not lock when it is closed.

Keyless unlocking

- 1 Grasp a door handle or gently press the rubberised pressure plate beneath the tailgate handle to unlock the car.

> The lock indicator on the instrument panel stops flashing to indicate that the car is unlocked.

Automatic relocking

If the car has not been opened within 2 minutes after unlocking, it is relocked automatically. The function reduces the risk of the car being left unlocked unintentionally.

* Option/accessory.

9.2.1.5. Settings for Keyless entry*

It is possible to select different sequences for Keyless entry.

- 1 Press  in the centre display.
- 2 Press **Controls**.
- 3 Select setting for unlocking.

* Option/accessory.

9.2.1.6. Closing and locking tailgate with button*

The buttons on the tailgate's underside can close and lock the car automatically.



Location of the button/buttons on the underside of the tailgate.

 **Important**

During manual tailgate operation, open or close it slowly. Do not use force to open/close it if there is resistance. The tailgate may be damaged and stop working correctly.

Closing^[1]

- 1 Press the  button on the underside of the tailgate.
- The tailgate closes automatically and remains unlocked.

Note

- The button is active 24 hours after the hatch has been left open. Thereafter, it must be closed manually.
- If the flap has been open for more than 30 minutes, it will close at a slow speed.

Locking^[2]

- 1 Press the  button on the underside of the tailgate.
 - 2 Close the tailgate manually.
- The tailgate and the doors are locked^[3].

Closing and locking^[4]

- 1 Press the  button on the underside of the tailgate.
- The tailgate is closed automatically and the car is locked^[3].

Note

- One of the car's keys must be within range for locking and unlocking to work.
- When using keyless* locking or closing, three signals will sound if the key is not sufficiently close to the tailgate.

Cancel closing

- Press the button on the instrument panel.
- Press the key's button.
- Press the closing button on the underside of the tailgate^[1].
- Press the rubberised pressure plate on the tailgate handle.
- Using a foot movement*.

The tailgate's movement is interrupted and stops. With a further press on the rubberised pressure plate on the tailgate handle, the tailgate will open. If any of the other options are used, it will instead continue to close. The tailgate can also be operated manually.

If the tailgate is stopped close to closed position, the next activation will open the tailgate.

Pinch protection

If something is preventing the tailgate from opening or closing, the pinch protection is activated.

- During opening - movement is interrupted, the tailgate stops and a long acoustic signal sounds.
- During closing - movement is interrupted, the tailgate stops, a long acoustic signal sounds and the tailgate returns to the preprogrammed max. position.

If the car is moving when the pinch protection is activated, the tailgate stops where it is and the driver is informed by a message on the driver display.

Warning

Watch out for the risk of crushing when opening and closing.

Check that there is nobody near the tailgate before starting to open or close it as a crush injury may have severe consequences.

Always operate the tailgate with caution.

Pre-tensioned springs



The pre-tensioned springs for the power operated tailgate.

Warning

Do not open the pre-tensioned springs for the power operated tailgate. They are pre-tensioned with high pressure and can cause injury if opened.

* Option/accessory.

The content of this manual represents the status of the user manual at the time of printing and may not be completely valid in future instances. For more information, refer to the first page for the complete disclaimer note.

- [1] Applies to cars with power operated boot lid.
- [2] Applies to cars with the keyless locking/unlocking option.
- [3] All doors must be closed for locking the car.
- [4] Applies to cars with keyless locking/unlocking and power operated tailgate.

9.2.1.7. Keyless unlocking of tailgate *

With keyless locking and unlocking, it is sufficient to press lightly on the rubberised pressure plate underneath the tailgate's handle to unlock.

Note

One of the car's keys must be within range behind the car for unlocking to work.

The tailgate is held closed by an electrical lock.

To open:

- 1 Press gently on the rubberised pressure plate beneath the tailgate handle.
 - > The lock is released.
- 2 Lift by the outside handle in order to open the tailgate.

Important

- Handle the rubber panel with care to avoid damage to its electrical contact. Minimal force is required for activation.
- Do not exert the lifting force on the rubber panel when opening – lift the handle.

It is also possible to unlock the tailgate with a foot movement* under the rear bumper, see separate section.

Warning

Do not drive with an open tailgate! Toxic exhaust fumes could be drawn into the car through the cargo area.

* Option/accessory.

9.2.2. Keys

The car's physical keys are available in different variants. The car detects when a key is in the front part of the passenger compartment, and the car can then be started.



Available key types are standard key, Key Tag*, and Care Key. ^[1]

The standard key and Care Key are equipped with buttons. Additional keys to the number included as standard can be ordered. For cars equipped with keyless locking and unlocking*, a slightly smaller, lighter and button-less key (Key Tag) can be purchased as an accessory.

To start the car, a key needs to be within the front part of the passenger compartment.

For cars equipped with keyless locking and unlocking (Passive Entry)* the key can be anywhere in the car to start the car.

These keys can be linked to different user profiles to save personal preferences in the car.

 **Warning**

The key contains a button cell battery. Keep new and used batteries out of the reach of children. If someone swallows a battery it may cause serious injury.

If damage is discovered, e.g. if the battery cover cannot be closed properly, then the product should not be used. Keep defective products out of the reach of children.

Standard key and its buttons



The key has four buttons - one on the left-hand side and three on the right-hand side.

Locking

One press on the button locks the car and arms the alarm*.

One long press closes all windows as well as the panoramic roof*.

Unlocking

One press on the button unlocks the car and disarms the alarm*. One long press opens all windows simultaneously. This can be used, for example, to quickly air a hot car before getting into it.

Tailgate

One press on the button disarms the alarm* and unlocks the tailgate. On cars with power operated tailgate*, the tailgate is opened or closed with one long press. An acoustic warning signal sounds when the tailgate is opened or closed.

Panic function

The panic function is used to attract attention in an emergency. Press and hold the button for at least 3 seconds or press it twice within 3 seconds to activate the car's direction indicators and the horn. The function can be switched off using the unlock button after it has been active for at least 5 seconds. Otherwise it is deactivated automatically after 2 minutes and 45 seconds.

 **Warning**

If anyone is left in the car, make sure the power windows and panoramic roof* are de-energised by taking the key with you when you leave the car.

 **Note**

A key that has been locked in the car is temporarily deactivated and cannot be used before the car has been unlocked using another valid key.

The double lock^[2] function is also deactivated.

Button-less key (Key Tag)*

A Key Tag can be ordered as an accessory for cars equipped with the keyless locking and unlocking function. Starting and keyless locking and unlocking work in the same way as with the standard key. The key is waterproof to a depth of approx. 10 metres (30 feet) for up to 60 minutes. It does not have extending key blade, and the battery cannot be replaced.

Care Key

You can set a speed limit that is active when the Care Key is used. The limitation is intended to encourage the car to be driven in a safe manner, e.g. when being loaned out.

If the active key is removed from the car



If the key is removed from the car when the engine is running, the warning message, **The car key is not detected.** See **Owner's Manual for more information**., is shown in the driver display and an acoustic reminder sounds when the last door is closed.

The message disappears when the key is returned to the car, followed by a press of the right-hand keypad's **O** button, or when all doors have been closed.

Interference

Key functions for keyless starting and keyless locking and unlocking* can be disrupted by electromagnetic fields and screening.

 **Note**

Avoid storing the car's keys close to metal objects or electronics (e.g. mobile phones, tablets, laptops or chargers). Preferably no closer than 10-15 cm (4-6 inches).

If there is still interference - use the key's detachable key blade to unlock. Then place the key in the back-up reader in the cup holder to disarm the alarm and allow the car to be started.

 **Note**

When the key shall be read by the back-up reader, make sure that the cup holder is separate from other nearby car keys, metal objects and electronics (e.g. mobile phones, tablets, laptops or chargers). These objects may disrupt the functions.

* Option/accessory.

^[1] The figure is schematic - parts may vary depending on car model.

^[2] Applies to the United Kingdom and Ireland.

9.2.3. Locking and unlocking with the key's buttons

You can use the key's buttons to lock or unlock the whole car.^[1]



Locking with the key's buttons

- 1 Press the  button to lock the car.

The driver's door must be closed for the lock sequence to be activated^[2]. If any of the other doors or the tailgate is open, then these are not locked and their alarms armed* until they are closed. The alarm's movement detectors* are activated when all the doors and the tailgate are closed and locked.

Note

A key that has been locked in the car is temporarily deactivated and cannot be used before the car has been unlocked using another valid key.

The double lock^[3] function is also deactivated.

Locking when the tailgate is open

Note

If the car has been locked while the tailgate is open, be careful not to leave the key in the cargo area when the tailgate is closed^[2].

Unlocking with the key's buttons

- 1 Press the  button to unlock the car.

Automatic relocking

If none of the doors or the tailgate is opened within 2 minutes of unlocking, they are locked automatically. This function prevents the car from being left unlocked unintentionally.

If the key is not working

If the key's buttons stop working then its battery may be discharged – in which case, replace the battery or use the detachable key blade.

^[1] Also applies to the fuel filter flap.

* Option/accessory.

^[2] If the car is equipped with keyless locking/unlocking* then all side doors must be closed.

^[3] Applies to the United Kingdom and Ireland.

9.2.4. Settings for unlocking

It is possible to select different sequences for unlocking.

- 1 Press  in the centre display.
- 2 Press **Controls**.
- 3 Select setting for unlocking.

9.2.5. Unlocking the tailgate with a key button

There is a button on the key to unlock the tailgate only.

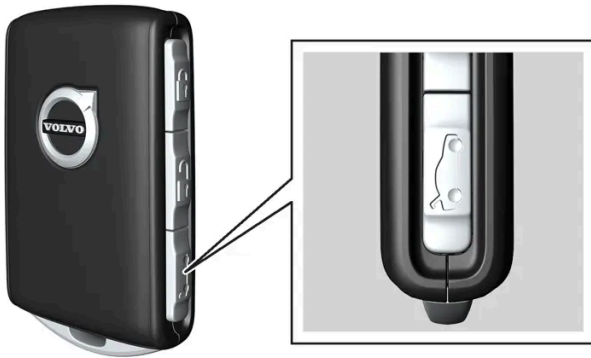

- 1 Press the key's  button.
 - > The tailgate is unlocked but remains closed.
The side doors are still locked and the alarm is armed*. The lock and alarm indicator on the instrument panel extinguishes in order to show that the entire car is not locked.
You can open the tailgate by gripping the rubberised pressure plate underneath its lower edge.
If the tailgate is not opened within 2 minutes then it is relocked and the alarm is re-armed.

Power operated tailgate*

- 1 Hold the key's  button depressed for a couple of seconds.
 - > The tailgate is unlocked and opened, while the side doors remain locked and their alarm functions armed*.

Note

If the system for the power operated tailgate* works continuously for a long time, it is deactivated in order not to overload it. It can be used again after a few minutes.

* Option/accessory.

9.2.6. Locking and unlocking with the detachable key blade

The detachable key blade can be used to unlock one of the car's doors from the outside – such as if the battery in the key is discharged.

Unlocking with the key blade

i Note

When the door is unlocked using the key blade and is then opened, the alarm is triggered. The alarm must be deactivated manually – it may be a good idea to read that section before opening the car.

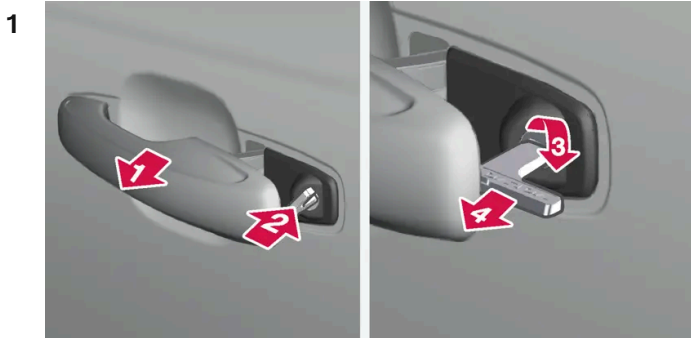

Pull out the front door's handle on the left-hand side of the car to its end position.



Insert the key.



Turn clockwise 45 degrees so that the key is pointing straight back.



Turn the key back 45 degrees to its starting position and remove it.

➤ The door can be opened using the handle.

Locking with the key blade

The left-hand front door can be locked using the detachable key blade.

Other doors have a lock reset on the end face that must be pressed in using the key blade. Then they are mechanically locked against opening from the outside, but can be opened from the inside.

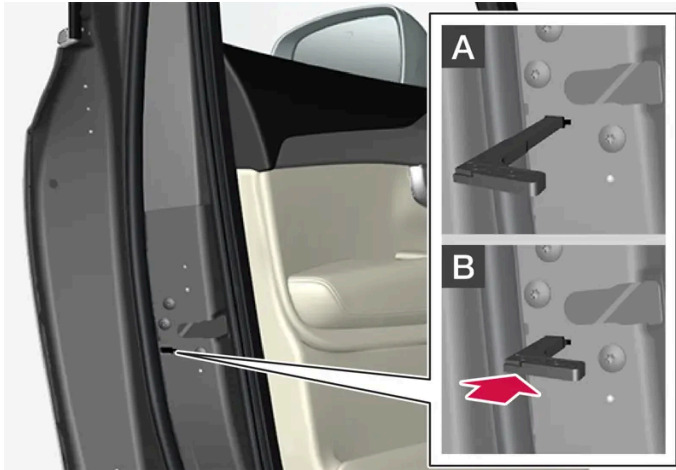

Manual locking of the door. Not to be mixed up with child locks.

- 1 Remove the detachable key blade from the key with buttons.
- 2 Insert the key blade in the hole for lock reset.
- 3 Press in the key until it bottoms – approximately 12 mm (0.5 inches).

A The door can be opened from both the outside and the inside.

B The door is blocked against opening from the outside. To return to position A, the inner door handle must be opened.

Note

- A door's lock reset only locks that particular door - not all doors simultaneously.
- A manually locked rear door with enabled child lock cannot be opened from either insider or outside. Unlocking is possible using the buttons on the key, the central locking button, the keyless locking system* or by using the Volvo Cars app.

* Option/accessory.

9.2.7. Automatic locking when driving

When the car starts to drive, the doors and tailgate are locked automatically for safety reasons.

The doors can still be opened from the inside during automatic locking when driving. Either all doors are unlocked, or just the door being opened, depending on the lock settings.

 **Note**

You will need to use the child lock to prevent a rear door from being opened from inside the car.

Automatic locking when driving can be deactivated or activated in the centre display:

- 1 Press .
- 2 Press **Controls**.
- 3 Select the setting for automatic locking when driving.

 **Note**

In the event of a collision, the car unlocks all doors for safety reasons. This only happens if any of the safety systems have deployed.

9.2.8. Double lock*

Double lock^[1] means that all of the car's opening handles are disengaged when the car is locked from the outside. None of the internal or external handles can then open the car until it has been unlocked again.

 **Warning**

Do not lock the car from the outside while there is anyone left in the car. Double lock means that the car cannot be unlocked or opened from the inside.

Double lock is activated when locking with a key button or with keyless locking*, and takes place with a delay of approx. 10 seconds after the doors have locked. If a door is opened within the delay time then the sequence is interrupted and the alarm is deactivated.

The car can only be unlocked with the key, keyless unlocking* or with the Volvo Cars app* when double lock is activated.

The front left door can also be unlocked with the detachable key blade. If the car is unlocked with the detachable key blade, the alarm will be triggered.

* Option/accessory.

^[1] Applies to the United Kingdom and Ireland.

9.2.9. Setting the max. opening for electrically operated tailgate*

Set the amount the tailgate should be opened if the car is, for example, parked in a garage with limited headroom.

To adjust max. opening

- 1 Open the tailgate manually - and stop it in the desired opening position.
- 2 Press and hold the  button on the bottom of the tailgate for approx. 3 seconds.
 - > Two acoustic signals sound to indicate that the set position has been saved.

Note

It is not possible to program an opening position lower than half-open tailgate.

Reset max. opening

- 1 Open the tailgate manually to the fully open position.
- 2 Press and hold the  button on the bottom of the tailgate for approx. 3 seconds.
 - > Two acoustic signals sound to indicate that the set position has been cleared.

* Option/accessory.

9.2.10. Locking and unlocking from inside the car

There are more lock buttons on the inside of the car. You can also use the door handles to unlock from the inside.

Central locking

The front door buttons for central locking lock or unlock the whole car.



Unlocking using a button in the front door

- 1 Press the  button to unlock all side doors and the tailgate.

Unlocking with the front door handles

- 1 Pull out and release one of the internal handles on the front side doors.
 - The car is unlocked. Only the selected door is unlocked, or all of the doors, depending on settings.

Locking using a button in the front door

- 1 Press the  button - both front doors must be closed.
 - All doors and the tailgate are locked.

Locking using a button in the rear door*



Locking button with indicator lamp in the rear door.

The rear door lock buttons lock their respective rear door.

Unlocking a rear door with the door handle

- 1 Pull the opening handle.
 - The rear door is unlocked and opened^[1].

* Option/accessory.

^[1] Provided that the child lock is not activated.

9.2.11. Unlocking the tailgate from inside the car

The tailgate can be unlocked from inside the car using a button beside the steering wheel on the instrument panel.



- 1 Press the  button on the instrument panel.
 - The tailgate is unlocked and can be opened from the outside.

With the power operated tailgate option*:

- 1 Hold the instrument panel's  button depressed for a couple of seconds.
 - > The tailgate is opened.
The same button can then be used to close the tailgate.

 **Note**

If the system for the power operated tailgate* works continuously for a long time, it is deactivated in order not to overload it. It can be used again after a few minutes.

* Option/accessory.

9.2.12. Locking and unlocking

The car can be locked and unlocked in several different ways.

The options are:

- with the key's buttons
- using the detachable key blade (if the battery in the key is discharged)
- keyless* (the car detects that a key is within range)
- from the inside of the car with the door handles and lock buttons
- with the Volvo Cars app
- automatic locking when the car is driven.

 **Note**

In the event of a collision, the car unlocks all doors for safety reasons. This only happens if any of the safety systems have deployed.

* Option/accessory.

9.2.13. Activating and deactivating child safety locks

The child safety lock prevents the rear doors from being opened from inside. With electric child safety locks, power window operation from the rear seat is also prevented.

The child lock can be either manual or electrical*.

Manual child lock

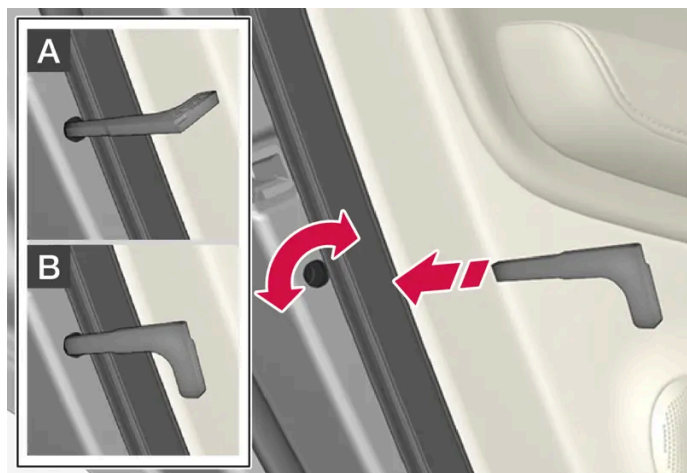

Manual child lock. Not to be confused with manual door locks.

- 1 Use the key's detachable key blade to turn the knob.

A The door is blocked against opening from the inside.

B The door can be opened from both the outside and the inside.

i Note

- A door's knob control only blocks that particular door - not both rear doors simultaneously.
- Cars with an electric child safety lock do not have a manual child lock.

Electric child lock*

The electric child lock can be activated and deactivated in all ignition positions above **0**. Activation and deactivation can be performed up to 2 minutes after switching off the car, provided that no door is opened.



Activation and deactivation button.

Rear child safety lock enabled

When the lamp in the button is illuminated, the child safety lock is enabled.

If the child lock is activated when the car is switched off, it will remain activated the next time the car is started.

- Rear doors cannot be opened from the inside.
- Rear power windows can only be operated from the driver's door.

Rear child safety lock disabled

When the lamp in the button is not illuminated, the child safety lock is disabled.

- Rear doors can be opened from the inside and power windows operated from the rear seat.

Symbols and messages

Symbol	Message	Specification
	Rear child lock activated	The child lock is activated.
	Rear child lock deactivated	The child lock is deactivated.

* Option/accessory.

9.2.14. Lock confirmation

When the car is locked or unlocked can be indicated in various ways. You can adjust how the car confirms locking or unlocking through the settings for lock indication and door mirrors.

Exterior indication

Locking

- The car's hazard warning flashers indicate locking by flashing and retracting the door mirrors^[1].

Unlocking

- The car's hazard warning flashers indicate unlocking by two flashes and extending the door mirrors^[1].

All doors, the tailgate and the bonnet must be closed for the car to indicate that it is locked. If locking takes place with just the driver door closed^[2], locking will take place but the lock indication with hazard warning flashers will only take place when all doors, the tailgate and the bonnet have been closed.

Lock and alarm indicator on the instrument panel

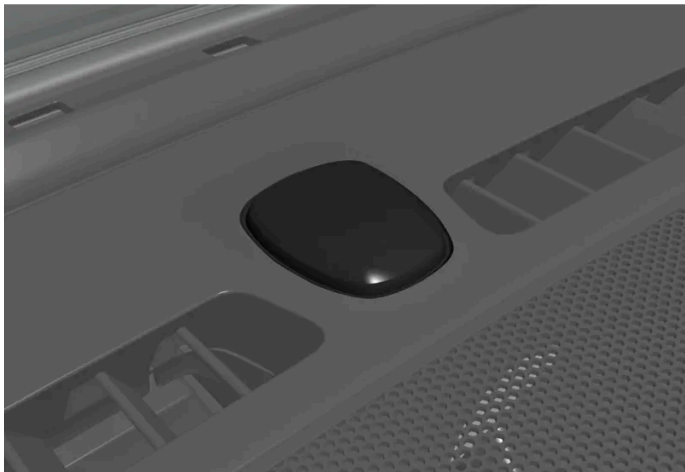

The indicator for locks and alarm is located in the centre of the instrument panel, close to the windscreen.

The lock and alarm indicator shows the status of the locking system:

- A long flash indicates locking.
- Short flashes indicate that the car is locked.
- Rapid flashes after disarming the alarm* indicate that the alarm has been triggered.

Indication in the door lock buttons

The inside of the car is equipped with lock buttons that include a lock symbol and a lock indicator lamp.



All of the doors are locked when the indicator lamps for the front doors are illuminated. The lamps are extinguished if any car door is opened.

The rear door indicator lamps* are extinguished if a rear door is unlocked.

Other indication

Depending on the car's settings, functions such as home safety light and guidance light, as well as automatic retraction and extension of door mirrors, can indicate locking or unlocking.

^[1] Only for cars with retractable power door mirrors.

* Option/accessory.

^[2] Not possible with keyless locking*.

9.2.15. Settings for lock indication

It is possible to select various options for how the car confirms locking and unlocking in the settings menu in the centre display.

- 1 Press  in the centre display.
 - 2 Press **Controls**.
 - 3 Choose to activate or deactivate confirmation for locking/unlocking.
-

9.3. Alarm

9.3.1. Alarm *

The alarm provides audible and visual warnings if anyone enters the car without a valid key, attempts to steal a tyre or tow the car away, or tampers with the car battery or alarm siren.

Alarm indicator

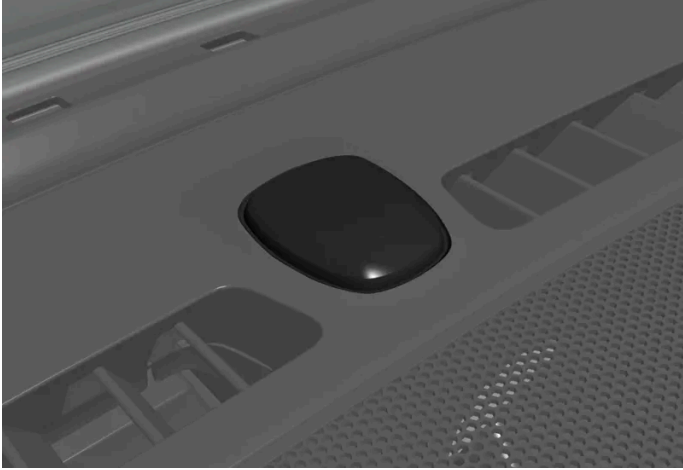

The indicator for locks and alarm is located in the centre of the instrument panel, close to the windscreen.

A red indicator light shows the status of the alarm system:

- Extinguished – alarm not armed.
- Flashes once every other second – alarm is armed.
- After the alarm has been disarmed, flashes rapidly for a maximum of 30 seconds or until ignition position I has been activated - the alarm has been triggered.

When armed, the alarm is triggered if:

- a door, the bonnet or the tailgate is opened^[1]
- a movement is detected in the passenger compartment (if fitted with a movement detector*)
- the car is raised or towed away (if fitted with a tilt detector*)
- the battery is disconnected
- the siren is disconnected.

Alarm signals

When the alarm has been triggered, the following happens:

- A siren sounds for 30 seconds or until the alarm is switched off.
- Hazard warning flashers flash for 5 minutes or until the alarm is switched off.

If the cause of alarm activation is not rectified, the alarm cycle is repeated up to 10 times^[1].

Movement and tilt sensors *

The alarm's movement detector reacts to movement inside the car^[2], while the tilt detector reacts if the inclination of the car changes. Reduced alarm level can be activated in order not to activate the alarm due to movement if the car is being transported, such as on a ferry.

To avoid triggering the alarm unintentionally:

- Close all windows when leaving the car.

- Close the panoramic roof.
- If the climate control is used – aim the airflow so that it does not point upwards in the passenger compartment.

It is also possible to reduce the alarm level in the centre display.

Symbols and messages

Symbol	Message	Specification
	Alarm system failure Service required	Contact a workshop – an authorised Volvo workshop is recommended.

Note

Do not attempt to repair or alter components in the alarm system yourself. All such attempts can affect the terms and conditions of the insurance and the performance of the alarm.

* Option/accessory.

[1] Applies to certain markets.

[2] Airflows from the climate control may be perceived as movement.

9.3.2. Activating and deactivating alarms *

The alarm is activated when the car is locked, and is deactivated when the car is unlocked. It is also possible to deactivate the alarm without a working key.

Activating and deactivating alarms

The alarm is activated when the car is locked, and is deactivated when the car is unlocked.

Note

It is not possible to lock the car without activating the alarm. If the car is parked on a ferry, for example, the function for reduced alarm level should be used instead.

Deactivate the alarm without a functioning key

The car can be unlocked and disarmed even if the key does not work, e.g. if the key's battery is discharged.

- 1 Open the driver's door with the detachable key blade.

➤ The alarm is triggered.



Place the key on the key symbol in the backup reader in the tunnel console's cup holder.

3 Turn the start knob clockwise and release it.

➤ The alarm is deactivated.

i Note

When the key shall be read by the back-up reader, make sure that the area is separate from other nearby car keys, metal objects and electronics (e.g. mobile phones, tablets, laptops or chargers). These objects may disrupt the functions.

Switching off a triggered alarm

A triggered alarm can be deactivated by pressing the unlock button on the key or by starting the car, provided that an authorised key is on the key symbol in the backup reader in the tunnel console's cup holder.

1 Press the key's unlock button or select ignition position I by turning the start knob clockwise and then releasing.

* Option/accessory.

9.3.3. Reduced alarm level*

Reduced alarm level switches off certain types of alarm sensors so that a false alarm is not triggered, e.g. when travelling on a car ferry.

The alarm's movement and tilt detectors are deactivated when reduced alarm level is activated. The alarm then does not react to movement inside the car or if the inclination of the car changes.

The function can be activated via the centre display when the unlocking the car.

Reduced alarm level is deactivated after each usage and must then be reactivated.

Activating reduced alarm level in the car's centre display

- 1 Select .
 - 2 Select **Controls**.
 - 3 Activate **Reduced alarm mode**.
- The function is active until the car is driven, and must then be reactivated.
Reduced alarm level can also be deactivated in the settings menu.

* Option/accessory.

10. Driver support

10.1. Cruise control functions

10.1.1. Cruise control

10.1.1.1. Cruise control

The cruise control (CC^[1]) helps the driver maintain an even speed, which can result in more relaxed driving on motorways and long, straight roads in regular traffic flows.

Using engine braking instead of the foot brake

With Cruise Control, speed is regulated with less frequent application of the foot brake. On a downhill gradient, it may sometimes be desirable to start moving a little faster and instead limit the acceleration by engine braking. In this case the driver can temporarily disable foot brake application by Cruise Control.

To do so, proceed as follows:

- 1 Depress the accelerator pedal about halfway down and release.
 - Cruise Control will disengage its automatic foot braking and then uses engine braking only.

Warning

- The function is supplementary driver support intended to facilitate driving and make it safer – it cannot handle all situations in all traffic, weather and road conditions.
- The driver is advised to read all sections in the Owner's Manual that relate to this function to learn about factors such as its limitations and what the driver should be aware of before using the system.
- Driver support functions are not a substitute for the driver's attention and judgement. The driver is always responsible for ensuring the car is driven in a safe manner, at the appropriate speed, with an appropriate distance to other vehicles, and in accordance with current traffic rules and regulations.

^[1] Cruise Control

10.1.1.2. Standby mode for cruise control

Cruise control (CC^[1]) can be deactivated and set in standby mode. This can take place automatically or be done by the driver.

Standby mode means that the function is selected in the driver display but not activated. The symbol in the driver display is extinguished and cruise control does not then regulate the speed.

Standby mode on driver intervention

Cruise control is deactivated and set to standby mode if any of the following occur:

- The foot brake is used.
- The gear selector is moved to **N** position.
- The driver maintains a speed higher than the stored speed for longer than 1 minute.

The driver must then control the speed himself/herself.

A temporary increase in speed with the accelerator pedal, e.g. during overtaking, does not affect the setting - the car returns to the last stored speed when the accelerator pedal is released.

Automatic standby mode

Activation of automatic standby mode can be due to one of the following:

- The wheels are losing traction.
- The engine speed is too low/high.
- Brake temperature is too high.
- Speed falls below 30 km/h (20 mph).

The driver must then control the speed himself/herself.

^[1] Cruise Control

10.1.1.3. Setting the stored speed for cruise control functions

It is possible to set stored speed for the speed limiter, cruise control and Pilot Assist* functions.

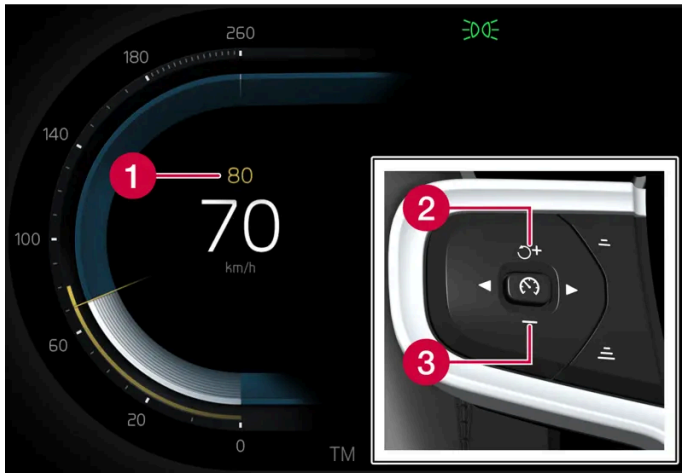

- 1 Stored speed
- 2 + : Increases the stored speed
- 3 - : Reduces stored speed

- 1 Change a set speed with short presses on the steering wheel buttons + (1) or - (2) or by pressing and holding them.
 - **Short** presses: Each press changes the speed in increments of +/- 5 km/h (+/- 5 mph).
 - **Press and hold**: Release the button when the speed indicator (3) has moved to the desired speed.
- The speed set after the last button press is stored in the memory.

Effect of the accelerator pedal

If the driver increases the car's speed using the accelerator pedal before pressing the steering wheel button + (1), the speed stored will be the car's speed when the button is depressed, provided the driver's foot is on the accelerator pedal at the moment when the button is depressed.

A temporary increase in speed with the accelerator pedal, e.g. during overtaking, does not affect the setting - the car returns to the last stored speed when the accelerator pedal is released.

Possible speed

Automatic gearbox

The driver support functions can follow another vehicle at speeds from 0 km/h up to the maximum speed of the car.

Pilot Assist can give steering assistance from almost stationary up to 140 km/h (87 mph).

Note that the lowest programmable speed is 30 km/h (20 mph) – even though it is capable of following another vehicle down to 0 km/h, a speed lower than 30 km/h (20 mph) cannot be selected/stored.

* Option/accessory.

10.1.2. Pilot Assist

10.1.2.1. Automatic braking with cruise control functions

The driver support Pilot Assist* has a special brake function in slow traffic and while stationary. In certain situations, the parking brake is applied in order to keep the car stationary.

Brake function in slow queues and while stationary

For shorter stops in connection with creep mode in slow traffic or at traffic lights, driving is automatically resumed if the stops do not exceed approx. 3 seconds - if it takes longer before the vehicle in front starts moving again then the driver support function is set in standby mode with automatic braking.

- 1 The function is reactivated in one of the following ways:
 - Press the steering wheel button .
 - Depress the accelerator pedal.
- > The function resumes following the vehicle ahead if it starts moving forward within approx. 6 seconds.

Warning

A significant increase in speed may follow when the speed is resumed with the  steering wheel button.

Warning

Driver supports only warn of obstacles which their radar unit has detected – hence a warning may not be given, or it may be given with a certain delay.

- Never wait for a warning or intervention. Apply the brakes when the situation requires.

Note

The driver supports can hold the car stationary for a maximum of 10 minutes – then the parking brake is applied and the function is disengaged.

Before the driver supports can be reactivated, the parking brake must be released.

Cessation of automatic braking

In some situations, automatic braking ceases on coming to a standstill and the function is set in standby mode. This means that the brakes are released and the car may start to roll - the driver must therefore intervene and brake the car himself/herself to keep it stationary.

This may take place in any of the following situations:

- The driver puts his/her foot on the brake pedal.
- The parking brake is applied.
- The gear selector is moved to P, N, or R position.
- The driver sets Pilot Assist in standby mode.

Automatic activation of parking brake

The Parking brake is applied if the function is holding the car stationary with the foot brake and:

- The driver opens the door or takes off his/her seatbelt.
- The function has kept the car stationary for more than approx. 10 minutes.
- The brakes have overheated.
- The driver switches the engine off.

* Option/accessory.

10.1.2.2. Setting the stored speed for cruise control functions

It is possible to set stored speed for the speed limiter, cruise control and Pilot Assist* functions.

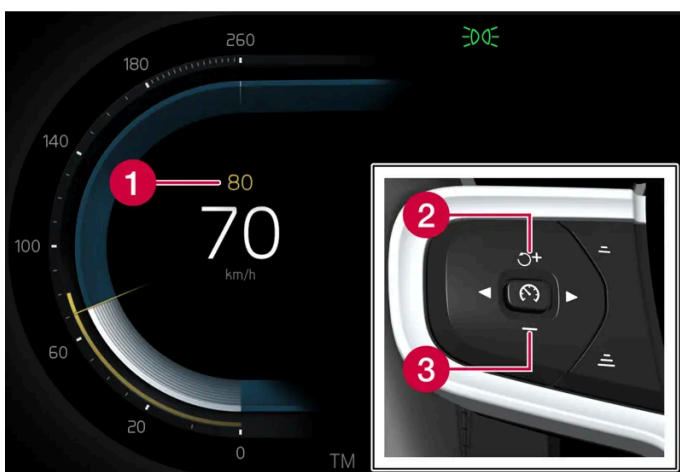

- 1 Stored speed
- 2 + : Increases the stored speed
- 3 - : Reduces stored speed

- 1 Change a set speed with short presses on the steering wheel buttons **+** (1) or **-** (2) or by pressing and holding them.
 - **Short** presses: Each press changes the speed in increments of +/- 5 km/h (+/- 5 mph).
 - **Press and hold**: Release the button when the speed indicator (3) has moved to the desired speed.
- > The speed set after the last button press is stored in the memory.

Effect of the accelerator pedal

If the driver increases the car's speed using the accelerator pedal before pressing the steering wheel button **+** (1), the speed stored will be the car's speed when the button is depressed, provided the driver's foot is on the accelerator pedal at the moment when the button is depressed.

A temporary increase in speed with the accelerator pedal, e.g. during overtaking, does not affect the setting - the car returns to the last stored speed when the accelerator pedal is released.

Possible speed

Automatic gearbox

The driver support functions can follow another vehicle at speeds from 0 km/h up to the maximum speed of the car.

Pilot Assist can give steering assistance from almost stationary up to 140 km/h (87 mph).

Note that the lowest programmable speed is 30 km/h (20 mph) – even though it is capable of following another vehicle down to 0 km/h, a speed lower than 30 km/h (20 mph) cannot be selected/stored.

* Option/accessory.

10.1.2.3. Change of target with cruise control functions

In combination with automatic gearbox, driver support Pilot Assist* has functionality for change of target at certain speeds.

Change of target

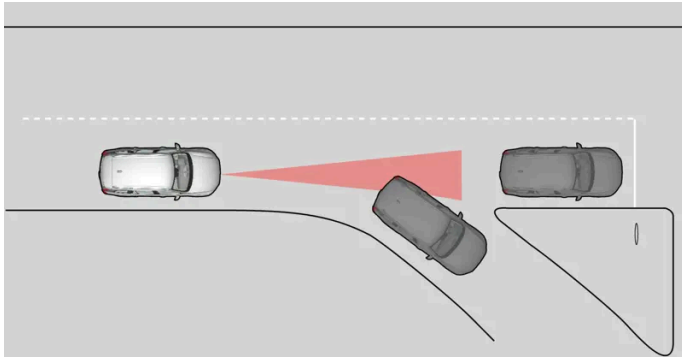

If the target vehicle in front suddenly turns then there may be stationary traffic in front.

When Pilot Assist is following another vehicle at speeds **below** 30 km/h (20 mph) and changes target vehicle from a moving to a stationary vehicle, Pilot Assist will slow down for the stationary vehicle.

Warning

When Pilot Assist is following another vehicle at speeds **in excess of** approx. 30 km/h (20 mph) and the target is changed from a moving vehicle to a stationary vehicle, Pilot Assist will **ignore** the stationary vehicle and instead accelerate to the stored speed.

- The driver must then intervene him/herself and brake.

Automatic standby mode with change of target

Pilot Assist is disengaged and set in standby mode:

- when the speed is below 5 km/h (3 mph) and Pilot Assist is uncertain whether the target object is a stationary vehicle or some other object, e.g. a speed bump.
- when the speed is below 5 km/h (3 mph) and the vehicle ahead turns off so that Pilot Assist no longer has a vehicle to follow.

* Option/accessory.

10.1.2.4. Pilot Assist*

Pilot Assist^[1] can help the driver to maintain a constant speed, combined with a preselected time interval from the vehicle ahead. Pilot Assist can also help the driver to keep the car within the lane markings.

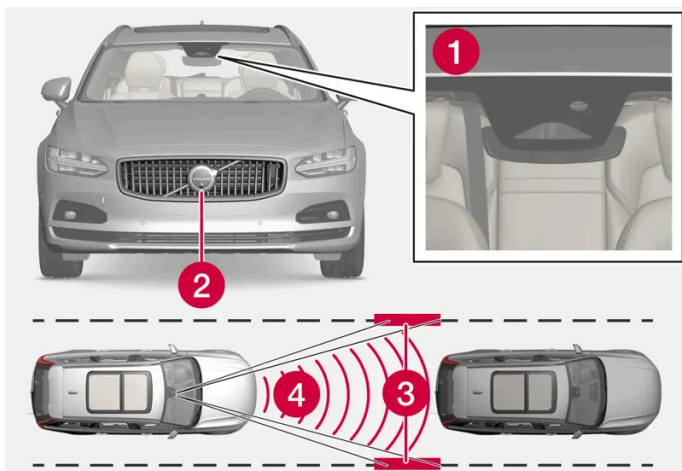

The camera and radar units measure the distance to the vehicle ahead and detect lane markings.

- 1 Camera unit
- 2 Radar unit
- 3 Reading edge markings
- 4 Reading distance

Get to know Pilot Assist

Pilot Assist helps to control your car and you may need to drive a few kilometres with Pilot Assist before you feel completely at home with the function. It is important to know about all of the function's applications and limitations in order to safely use all of the advantages.

The Pilot Assist function is primarily intended for use on motorways and similar major roads where it can contribute to more comfortable driving and a more relaxed driving experience.

The driver selects the desired speed and a time interval to the vehicle ahead. Pilot Assist scans the distance to the vehicle ahead and the lane's side markings on the road surface using the camera unit. The preset time interval is maintained with automatic speed adjustment whilst the steering assistance helps to position the car in the lane.

Pilot Assist regulates the speed with acceleration and braking. It is normal for the brakes to emit a low sound when they are being used to adjust the speed.

Pilot Assist strives to:

- regulate the speed smoothly. In situations that demand sudden braking the driver must brake himself/herself. This applies in cases of large speed differences or if the car in front brakes suddenly. Due to the limitations of the camera and radar unit, braking may come unexpectedly or not at all.
- follow the vehicle ahead in the same lane at a time interval set by the driver. If the radar unit cannot see any vehicle ahead then the car will instead maintain the maximum speed selected by the driver. This also takes place if the speed of the vehicle ahead increases and exceeds the selected maximum speed.

Position of the car in the lane *

When Pilot Assist helps to steer, it attempts to place the car halfway between the visible lane markings. For a smoother drive, it is a good idea to allow the car to find a good position. The driver can always adjust the position him/herself by increasing the steering input. It is important that the driver checks to make sure the car is positioned safely in the lane.

If Pilot Assist does not position the car in an appropriate way in the lane, it is recommended to turn Pilot Assist off or switch to Adaptive Cruise Control. This is done by pressing the right arrow on the steering wheel.

Steering assistance *

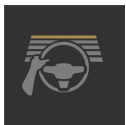

The current status of steering assistance is indicated by the colour of the steering wheel's symbol:

- Steering wheel lit up indicates active steering assistance
- Steering wheel extinguished (as in illustration) indicates deactivated steering assistance.

Pilot Assist steering assistance takes into account the speed of the preceding car and the lane markings. The driver can at any time adjust steering interventions from Pilot Assist and steer in another direction, e.g. to change lane or avoid an obstruction on the road. Resistance is then felt in the steering wheel as long as the steering assistance is active.

Temporary disabling of steering assistance



Warning

Pilot Assist steering assistance is automatically deactivated and is resumed without prior warning.

When the direction indicators are used, Pilot Assist steering assistance is temporarily disengaged. When the direction indicator is switched off, steering assistance is reactivated automatically if the lane's edge markings can still be detected.

If Pilot Assist is unable to interpret the lane clearly, e.g. if the camera unit does not see the lane's edge markings, Pilot Assist shuts off steering assistance temporarily. Adaptive Cruise Control continues to remain active. Steering assistance is resumed when the lane can be interpreted again. In these situations, slight vibration in the steering wheel may alert the driver to the fact that steering assistance has been deactivated temporarily.

Round bends and when the road splits

Pilot Assist interacts with the driver, who should therefore not wait for the steering assistance from Pilot Assist but should always be prepared to increase his/her own steering input, especially in bends.

When the car approaches an exit or if the lane splits, the driver should steer towards the desired lane so that Pilot Assist can detect the desired direction.

Hands on the steering wheel ^[2]



In order for Pilot Assist to function, the driver's hands must be on the steering wheel. It is also important for the driver always to carry on being active and alert when driving as Pilot Assist is unable to read all situations and the function may toggle between off and on without prior warning.



Warning

Do not wait for all levels of warning and assistance from the systems, but act immediately if any warning signal is triggered.

1. If Pilot Assist detects that the driver does not keep his/her hands on the steering wheel, the system gives a warning with a symbol and text message in the driver display in order to prompt the driver to actively steer the car.
2. If the driver's hands still cannot be detected on the steering wheel after a few seconds the prompt to actively steer the car is repeated supplemented by an acoustic signal.
3. If Pilot Assist cannot detect the driver's hands on the steering wheel after a further few seconds, the audible signal becomes intensive and the steering function is deactivated. Pilot Assist must then be restarted using the steering wheel button .
4. When Pilot Assist is switched off, additional audible and visual warnings are given and the car's system brakes the car. This braking takes place in a jerky fashion in order to attract the driver's attention ^[3] ^[2]
5. The system continues to brake the car to a stop in its own lane and the hazard warning flashers come on ^[4] ^[2]

Steep roads and/or heavy load

Bear in mind that Pilot Assist is primarily intended for use when driving on level road surfaces. The function may have difficulty in keeping the correct distance from the vehicle ahead when driving on steep downhill slopes – in which case, be extra attentive and ready to brake.

Do not use Pilot Assist if the car has a heavy load or if a trailer is connected to the car.

Pilot Assist will not provide steering assistance if anything is connected to the towbar connector.



Note

Pilot Assist will not provide steering assistance if something is connected to the towbar connector, like a trailer or a bicycle rack.

Read all warnings before use

 **Warning**

- The function is supplementary driver support intended to facilitate driving and make it safer – it cannot handle all situations in all traffic, weather and road conditions.
- The driver is advised to read all sections in the Owner's Manual that relate to this function to learn about factors such as its limitations and what the driver should be aware of before using the system.
- Driver support functions are not a substitute for the driver's attention and judgement. The driver is always responsible for ensuring the car is driven in a safe manner, at the appropriate speed, with an appropriate distance to other vehicles, and in accordance with current traffic rules and regulations.

 **Note**

This function uses the car's camera and radar units, which have certain general limitations.

 **Important**

Maintenance of driver support components must only be performed at a workshop – an authorised Volvo workshop is recommended.

 **Warning**

In certain situations, steering assistance may have difficulty helping the driver in the right way or it may be automatically deactivated – in which case, the use of steering assistance is not recommended. Examples of such situations may be that:

- the lane markings are unclear, worn, missing, or they cross each other, or if there are several sets of lane markings.
- the lane division is changed, e.g. when the lanes split or merge, as well as on slip roads.
- at roadworks and sudden changes in the roadway, e.g. when the lines may stop marking the correct route.
- edges or other lines than lane markings are present on or near the road, e.g. kerbs, joints or repairs to the road surface, edges of barriers, roadside edges or strong shadows.
- the lane is narrow or winding.
- the lane contains ridges or holes.
- weather conditions are poor, e.g. rain, snow or fog or slush or impaired view with poor light conditions, back-lighting, wet road surface etc.

The driver should also note that Pilot Assist has the following limitations:

- High kerbs, roadside barriers, temporary obstacles (traffic cones, safety barriers, etc.) are not detected. Alternatively, they may be detected incorrectly as lane markings, with a subsequent risk of contact between the car and such obstacles. The driver must ensure him/herself that the car is at a suitable distance from such obstacles.
- The camera and radar units do not have the capacity to detect all oncoming objects and obstacles in traffic environments, e.g. potholes, stationary obstacles or objects which completely or partially block the route.
- Pilot Assist does not "see" pedestrians, animals, etc.
- The functions steering assist is force limited, which means that Pilot Assist cannot always help the driver to steer and keep the car within the lane.
- In cars equipped with map data, the function has the option of using information from map data, which may involve varied performance.
- Pilot Assist is switched off if the power steering for speed related steering force is working with reduced power – e.g. during cooling due to overheating.

 **Warning**

Steering assistance must only be used if there are clear lane lines painted on each side of the lane. All other use involves increased risk of contact with surrounding obstacles that cannot be detected by the function.

 **Warning**

- This is not a collision avoidance system. The driver is always responsible and must intervene if the system does not detect a vehicle ahead.
- The function does not brake consistently for humans or animals, and neither for small vehicles such as bicycles and motorcycles. Nor for low trailers, oncoming, slow or stationary vehicles and objects.
- Do not use the function in demanding situations, such as in city traffic, at junctions, on slippery surfaces, with a lot of water or slush on the road, in heavy rain/snow, in poor visibility, on winding roads or on slip roads.

* Option/accessory.

[1] This function can be either standard or optional, depending on market.

[2] The function is available in certain markets.



[3] The function may vary between countries.

[4] Regulations for the use of hazard warning flashers may vary from country to country.

10.1.2.5. Display mode for Pilot Assist*

The following sample illustration shows how Pilot Assist* and Adaptive Cruise Control^[1] can be shown in the driver display.

Symbol indication

	Adaptive Cruise Control is active. Pilot Assist is selected but not available. The criteria for the function are not met.
	Pilot Assist is active.

Speed

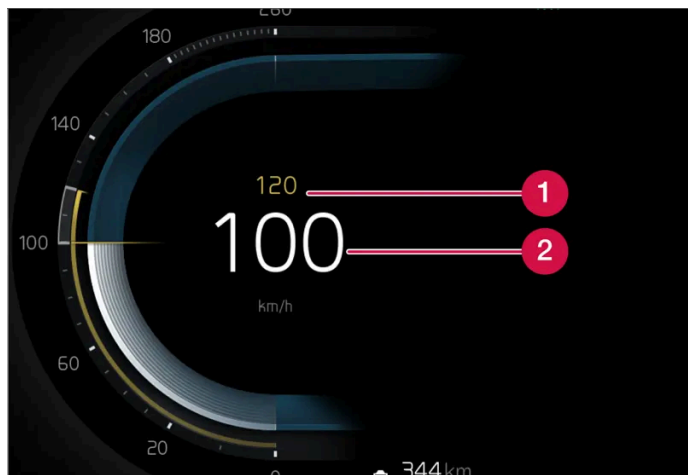



Indication of speeds.

1 Stored speed

2 Current speed of your car

Time interval





	When the symbol in the driver display shows a car, the time interval to the vehicle ahead is regulated.
	When no car is shown, the functions follow the saved speed.

* Option/accessory.

^[1] These functions can be either standard or optional, depending on market.

10.1.2.6. Symbols and messages for Pilot Assist *

A number of symbols and messages regarding Pilot Assist ^[1] can be shown. Here are some examples.

Symbol	Message	Specification
	The symbol is lit. The car symbol is lit when the car has a vehicle ahead to relate to.	The car is maintaining the stored/selected speed.
	Pilot Assist Service required The symbol is extinguished	The system does not function as it should. A workshop should be contacted. Pilot Assist has been set in standby mode.
	Steering wheel symbol extinguished	Indicates deactivated steering assistance. When Pilot Assist provides steering assistance, the steering wheel is lit up.
	Symbol for hands on the steering wheel	The system cannot detect whether the driver has his/her hands on the steering wheel. Place your hands on the steering wheel and actively steer the car. The system warns in different steps coupled with acoustic signals. The hazard warning flashers are activated if the car needs to slow down to a standstill.
	Radar sensor front Sensor blocked See Owner's manual, Front radar alignment incomplete or Front camera alignment incomplete	Clean in front of the radar unit's detectors.

A text message can be cleared by briefly pressing the  button, located in the centre of the steering wheel's right-hand keypad.

If a message remains, contact a workshop - an authorised Volvo workshop is recommended.

* Option/accessory.

^[1] This function can be either standard or optional, depending on market.

10.1.2.7. Standby mode for Pilot Assist *

Pilot Assist and Adaptive Cruise Control^[1] can be deactivated and set in standby mode. This can take place automatically or be done by the driver.

Standby mode means that the function is selected in the driver display but not activated. The functions do not control speed, distance from the vehicle ahead, or give steering assistance.

Standby mode on driver intervention

Pilot Assist is deactivated and set in standby mode if any of the following occurs:

- The foot brake is used.
- The gear selector is moved to **N** position.
- The direction indicators are used for longer than 1 minute.
- The driver maintains a speed higher than the stored speed for longer than 1 minute.

A temporary increase in speed with the accelerator pedal, e.g. during overtaking, does not affect the setting - the car returns to the last stored speed when the accelerator pedal is released.

Warning

- With Adaptive Cruise Control in standby mode, the driver must intervene and steer, regulating both speed and distance to the vehicle ahead.
- When Adaptive Cruise Control without steering assistance is in standby mode and the car comes too close to a vehicle ahead, the driver may be warned of the short distance by the Distance Warning* function instead.

Automatic standby mode

Warning

With automatic standby mode, the driver is warned via an acoustic signal and a message in the driver display.

- The driver must then regulate the car's speed, apply the brakes as needed, steer the car and maintain a safe distance to other vehicles.

Automatic standby mode may be engaged in the event of one of the following.

- One of the systems that Pilot Assist is dependent on stops working, e.g. stability control / anti-skid^[2].
- The driver opens the door.
- The driver takes off the seatbelt.
- The engine speed is too low/high.
- One or more wheels lose traction.
- The brake temperature is high.
- The parking brake is applied.
- Camera and radar units are covered by, for example, snow or heavy rainfall (camera lens/radio waves are blocked).
- The speed is below 5 km/h (3 mph) and Pilot Assist is uncertain whether the vehicle ahead is a stationary vehicle or an object, such as a speed bump.

The content of this manual represents the status of the user manual at the time of printing and may not be completely valid in future instances. For more information, refer to the first page for the complete disclaimer note.

- The speed is below 5 km/h (3 mph) and the vehicle ahead turns off so that Pilot Assist no longer has a vehicle to follow.

* Option/accessory.

[1] This function can be either standard or optional, depending on market.

[2] Electronic Stability Control

10.1.2.8. Setting time interval to vehicle ahead

It is possible to set the time interval to the vehicle ahead to be maintained by Pilot Assist*.



Control for time interval.

- 1 Decrease time interval
- 2 Increase time interval
- 3 Distance indicator

Press the steering wheel button (1) or (2) to increase or decrease the time interval.

➤ The distance indicator (3) shows the current time interval.

Different time intervals to the vehicle in front can be selected and shown in the driver display as 1-5 horizontal lines - the more lines the longer the time interval. One line represents about 1 second to the vehicle in front, 5 lines represents about 3 seconds.

Pilot Assist allows the time interval to vary significantly in certain situations in order to allow the car to follow the vehicle ahead smoothly and comfortably. At low speed, when the distances are short, Pilot Assist increases the time interval slightly.

 **Note**

When the symbol in the driver display shows a car and a steering wheel, Pilot Assist follows a vehicle in front at a preset time gap.

When only one steering wheel is shown, there is no vehicle within a reasonable distance ahead.

 **Note**

- The higher the speed the longer the calculated distance in metres for a given time interval.
- Only use the time intervals permitted by local traffic regulations.
- If the driver supports do not seem to respond with a speed increase when activated, it may be because the time window to the vehicle ahead is shorter than the set time window.

 **Warning**

- Only use a time window that suits the current traffic conditions.
- The driver should be aware that short time windows limit the amount of time available to react and take action in an unexpected traffic situation.

* Option/accessory.

10.1.2.9. Difference between Pilot Assist* and lane assistance

Pilot Assist is a comfort function that can help you to keep your car within its own lane and maintain a safe distance from vehicles in front of you. Lane assistance^[1] is a function which, in a similar way, can help you in some situations to reduce the risk of your car accidentally leaving its own lane.

Pilot Assist



Pilot Assist can help you to steer your car between the lane's markings, as well as maintaining a preset speed and time interval to the vehicle ahead. The function can also help to maintain an advantageous position in the lane using the lane's lane lines.

What does Pilot Assist do?

- Can help to keep the car within its lane by assisting steering in some cases.
- Can help to maintain a preset speed or the distance to the vehicle ahead by means of acceleration and braking operations.

How do I know when Pilot Assist is operational?

Symbols in the driver display in the car indicate when Pilot Assist is operational.

	Adaptive Cruise Control is active. Pilot Assist is selected but not available. The criteria for the function are not met.
	Pilot Assist is active.

Lane assistance

Lane assistance can provide steering assistance and/or give you an alert when the vehicle is about to leave its own lane unintentionally. This function is active in the speed range 65-180 km/h (40-112 mph) on roads with clearly visible lane lines.

What does lane assistance do?

- Lane assistance can provide the driver with steering assistance, steering the car back into its lane and/or providing warnings using steering wheel vibration.

How do I know when lane assistance is operational?

Symbols in the driver's display in the car show the status of the function.



LKA is available but neither the right nor the left line can be read or the conditions for LKA have not been met.



LKA is available and both the right and left line can be read.



Only the left line can be read.



Only the right line can be read.



LKA provides steering assistance, steering the car back into its lane and/or providing warnings using steering wheel vibration.



LKA provides steering assistance, steering the car back into its lane and/or providing warnings using steering wheel vibration.



LKA is switched off.



LKA is not available as a problem has been discovered.

 **Warning**

The driver always bears responsibility for ensuring that the car is driven safely. Before using this function, the driver is recommended to read all sections on the function in the owner's manual.

 **Warning**

- The function is supplementary driver support intended to facilitate driving and make it safer – it cannot handle all situations in all traffic, weather and road conditions.
- The driver is advised to read all sections in the Owner's Manual that relate to this function to learn about factors such as its limitations and what the driver should be aware of before using the system.
- Driver support functions are not a substitute for the driver's attention and judgement. The driver is always responsible for ensuring the car is driven in a safe manner, at the appropriate speed, with an appropriate distance to other vehicles, and in accordance with current traffic rules and regulations.

* Option/accessory.

^[1] Lane Keeping Aid(LKA)

10.1.2.10. Warning from cruise control functions in the event of a collision risk

The driver support system Pilot Assist* can warn the driver if the distance to the vehicle ahead suddenly becomes too short.

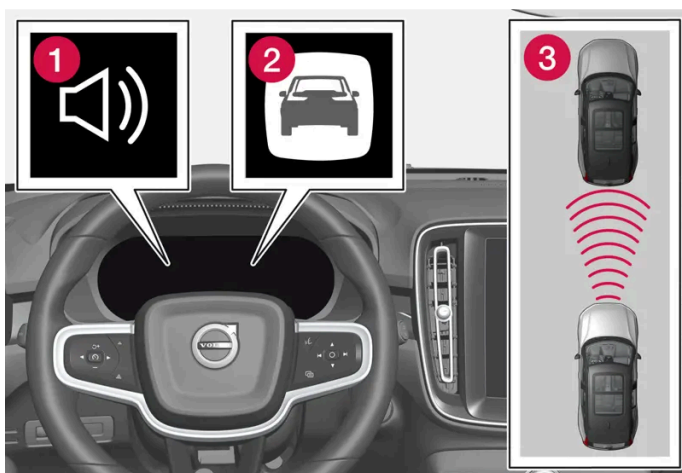

Audio and symbol for collision warning

- 1 Acoustic signal in the event of a risk of collision
- 2 Warning signal in the event of a risk of collision
- 3 Distance measurement with the camera and radar units

Pilot Assist uses approx. 40% of the foot brake's capacity. If the car needs to be braked more heavily than the driver support is capable of and the driver does not brake, the warning lamp and acoustic warning are activated to alert the driver that immediate intervention is required.

 **Warning**

The driver support systems only warn of vehicles which their radar unit has detected – hence a warning may not be given, or it may be given with a certain delay. Never wait for a warning. Apply the brakes when the situation requires.



Symbol for collision warning on the windscreen

In cars equipped with a head up display*, the warning is shown on the windscreen by a flashing symbol.

 **Note**

Strong sunlight, reflections, extreme light contrasts, the use of sunglasses, or if the driver is not looking straight ahead may make the visual warning signal in the windscreen difficult to recognise.

* Option/accessory.

10.1.3. Overtaking assistance

10.1.3.1. Overtaking Assistance*

Overtaking Assistance can help the driver when overtaking other vehicles. The function can be used with Pilot Assist*.

When Pilot Assist is following another vehicle and the driver indicates the intention to overtake by activating the direction indicator^[1], the systems can help by accelerating the vehicle towards the vehicle ahead **before** the driver's vehicle reaches the

overtaking lane.

The function then delays reducing speed in order to avoid premature braking when the driver's car is approaching a slower vehicle.

The function remains active until the driver's vehicle has cleared the overtaken vehicle.

 **Warning**

Be aware that this function can be activated in more situations than during overtaking, e.g. when a direction indicator is used to indicate a change of lane or exit to another road – the car will then accelerate briefly.

 **Warning**

- The function is supplementary driver support intended to facilitate driving and make it safer – it cannot handle all situations in all traffic, weather and road conditions.
- The driver is advised to read all sections in the Owner's Manual that relate to this function to learn about factors such as its limitations and what the driver should be aware of before using the system.
- Driver support functions are not a substitute for the driver's attention and judgement. The driver is always responsible for ensuring the car is driven in a safe manner, at the appropriate speed, with an appropriate distance to other vehicles, and in accordance with current traffic rules and regulations.

* Option/accessory.

^[1] On left flash only in left-hand-drive car, or right flash in right-hand-drive car.

10.1.3.2. Using Overtaking Assistance *

Overtaking assistance can be used with Pilot Assist* and Adaptive Cruise Control. There are a number of criteria if Overtaking Assistance is to be used.

The following conditions must exist for Overtaking Assistance to be activated:

- there must be a vehicle in front (the "target vehicle")
- your car's **current speed** is at least 70 km/h (43 mph)
- **the selected speed** must be high enough for overtaking to take place safely.

To start the Overtaking Assistance:

- 1 Activate the direction indicator.

Use the left-hand direction indicator in a left-hand drive car right in a right-hand drive car.

- Overtaking Assistance begins acceleration and reduces the time interval the vehicle ahead for a limited period in order to facilitate overtaking. If no overtake is executed, the time interval returns to the preset value.

 **Warning**

When using the Overtaking Assistance System, the driver should be aware that there may be undesired acceleration if the conditions suddenly change.

Some situations should therefore be avoided, such as if:

- the car is approaching an exit to turn-off in the same direction as overtaking would normally occur.
- the vehicle ahead slows down before the driver's car has crossed over into the overtaking lane.
- the traffic in the overtaking lane slows down.
- a right-hand drive car is driven in a county with left-hand traffic (or vice versa).





Situations of this type are avoided by temporarily setting Pilot Assist to standby mode.

* Option/accessory.

10.1.4. Cruise control functions

There are several driver support systems that can assist you while driving in order to maintain a suitable speed depending on situation. Here is a summary to make them more easily distinguishable from each other.

It is recommended that you read all sections in the Owner's Manual that relate to a function in order to learn about factors such as its limitations and what the driver should be aware of before using the system.

	Speed limiter ^[1]	Automatic speed limiter* ^[2]	Cruise control ^[3]	Adaptive Cruise Control ^[4]	Pilot Assist* ^[4]
Symbol in the driver display					
Brief description	The driver controls the speed with the accelerator pedal but is prevented by the speed limiter from mistakenly exceeding a preselected/preset maximum speed.	The automatic speed limiter uses speed information from the Road Sign Information function* to automatically adapt the maximum speed of the car.	The cruise control helps the driver to maintain an even speed, which can result in a more relaxed driving experience on, for example, motorways and long straight main roads in smooth traffic flows.	Adaptive Cruise Control can help the driver to maintain a constant speed, combined with a preselected time interval to the vehicle ahead.	Pilot Assist can help the driver to drive the car between the lane's side markings using steering assistance as well as to maintain an even speed, combined with a preselected time interval to the vehicle ahead.

^[1] Speed Limiter

* Option/accessory.

^[2] Automatic Speed Limiter

[3] Cruise Control

[4] This function can be either standard or optional, depending on market.

10.1.5. Steering wheel buttons for the cruise control functions

In the centre display, the selected cruise control function can be controlled with the left-hand steering wheel button. This applies to speed limiter (SL [1])* , automatic speed limiter (ASL [2]), cruise control (CC [3]), Pilot Assist*, Intelligent Speed Assist and Adaptive Cruise Control*.

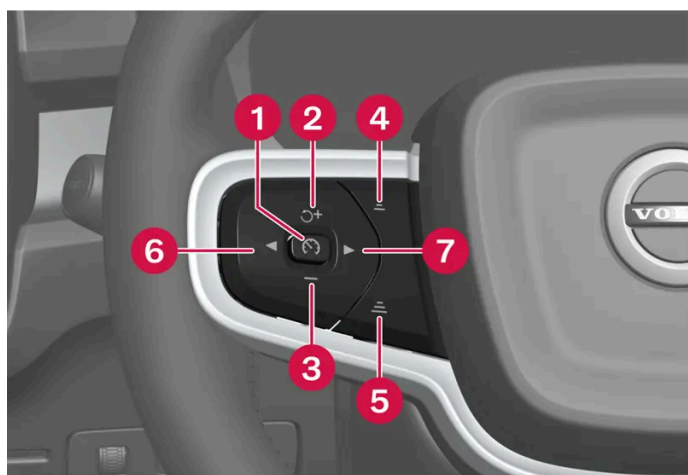

Cruise control function buttons

- 1 : **From standby mode** – Activates the selected function and stores the current speed. : **From active mode** – Sets the function to standby mode.
- 2 : **From standby mode** – Activates the selected function and resumes the stored speed. : **From active mode** – Increases the stored speed.
- 3 : Reduces stored speed.
- 4 : Reduces the time interval to vehicles ahead.
- 5 : Increases the time interval to vehicles ahead.
- 6 : Activates and deactivates Intelligent Speed Assist [4].
- 7 : Switches between Pilot Assist* and Adaptive Cruise Control*.

Warning

- The function is supplementary driver support intended to facilitate driving and make it safer – it cannot handle all situations in all traffic, weather and road conditions.
- The driver is advised to read all sections in the Owner's Manual that relate to this function to learn about factors such as its limitations and what the driver should be aware of before using the system.
- Driver support functions are not a substitute for the driver's attention and judgement. The driver is always responsible for ensuring the car is driven in a safe manner, at the appropriate speed, with an appropriate distance to other vehicles, and in accordance with current traffic rules and regulations.

[1] Speed Limiter

* Option/accessory.





[2] Automatic Speed Limiter

[3] Cruise Control

[4] The function is available in certain markets.

10.1.6. Selecting and activating cruise control functions

For a special preference of the cruise control function, it can be selected in the centre display before activation with steering wheel button. This applies to speed limiter, cruise control (CC^[1]), Pilot Assist* and Adaptive Cruise Control*.

- 1 Press  in the centre display.
- 2 Tap on **Driving** and activate the desired function.
- 3 When the desired function is selected – press the steering wheel button  to activate it.
 - The symbol in the driver display lights up – the function is started and the current speed is stored as the maximum speed.
- 4 If the function is set to standby mode – press the steering wheel button  to reactivate it.
 - The driver display's cruise control markings light up – the car then continues to follow the last speed stored.
- 5 Use the steering wheel button  to switch between Pilot Assist* and Adaptive Cruise Control*.

To always obtain Pilot Assist when activating cruise control functions for each new driving cycle:

- 1 Press  in the centre display.
- 2 Press **Driving**.
- 3 Activate **Pilot Assist as default**.

Warning

A significant increase in speed may follow when the speed is resumed with the  steering wheel button.

Criteria

Certain criteria have to be met to be able to start any of the functions.

Speed limiter and automatic speed limiter

- The speed limiter cannot be activated until after the engine has been started.
- The lowest maximum speed that can be stored is 30 km/h (20 mph).

Cruise control

- In order to start the cruise control from the standby mode, the car's current speed must be 30 km/h (20 mph) or higher.

Adaptive Cruise Control

- The driver's seatbelt must be buckled and the driver's door must be closed.
- There must be a vehicle (the "target vehicle") within reasonable distance in front of the car, or the current speed must be at least 15 km/h (9 mph).

Pilot Assist

- The driver's seatbelt must be buckled and the driver's door must be closed.
- The lane's edge markings must be clear and must be detected by the car.
- There must be a vehicle (the "target vehicle") within reasonable distance in front of the car, or the current speed must be at least 15 km/h (9 mph).
- The speed must not exceed 140 km/h (87 mph).
- The driver must keep his/her hands on the steering wheel.

^[1] Cruise Control

* Option/accessory.

10.1.7. Deactivating cruise control functions

The cruise control functions can be deactivated using a button on the steering wheel. The function then switches to standby mode. This applies to speed limiter (SL ^[1]), automatic speed limiter (ASL ^[2]), cruise control (CC ^[3]) and Pilot Assist*.

1 Press the steering wheel button .

- The symbol and indicators in the driver display are extinguished – the selected cruise control function is set in standby mode.

When a different function is selected in the centre display, the driver display's symbol and the marker indicating a previously selected function are hidden – the set/stored max speed is then deleted.

 **Warning**

When the cruise control functions are in standby mode, the driver must intervene and regulate both speed and distance to the vehicle ahead.

[1] Speed Limiter

[2] Automatic Speed Limiter

[3] Cruise Control

* Option/accessory.

10.1.8. Intelligent Speed Assist (ISA)

Intelligent Speed Assist helps the driver stay below the speed limit by means of different warnings and the option to limit the car's propulsion.

Get to know Intelligent Speed Assist

When the car exceeds the speed limit, Intelligent Speed Assist will warn the driver with an acoustic warning and the icon displaying the speed limit will flash. The acoustic warning starts a couple of seconds after the icon starts flashing and is adjusted according to the driver's driving behaviour. You can activate or deactivate the acoustic warning with the left steering wheel button .



Adaptive pedal response

In the centre display, you can replace the acoustic warning with adaptive pedal response, which helps the driver keep to the speed limit by limiting the car's propulsion. Pressing the accelerator pedal more firmly deactivates the function temporarily. You can still use the left steering wheel button  to activate or deactivate the function, whether you have selected pedal response or acoustic warning.

- 1 Press 
- 2 Select **Driver support>Intelligent speed assist**
- 3 Activate **Adaptive Pedal Response**

 **Note**

When Pilot Assist or Adaptive Cruise Control is used, the acoustic warning cannot be replaced by adaptive pedal response.

 **Note**

Your car is designed to comply with the requirements of the EU Regulation on Intelligent Speed Assistance. The aim of the regulation is to make driving safer with functions that encourage drivers to keep below the legal speed limit.

10.2. Distance Warning

10.2.1. Distance Warning*

The distance warning^[1] function can assist the driver to notice that the time interval to the vehicle ahead may be too short. This requires the car to be equipped with a head-up display* to be able to display Distance Warning.

In cars equipped with head-up display, a symbol is shown on the windscreen when the time interval to the vehicle ahead falls below a certain limit.

Distance warning is active at speeds above 30 km/h (20 mph) and only reacts to the vehicle ahead travelling in the same direction. No distance information is provided for oncoming, slow or stationary vehicles.

 **Note**

Strong sunlight, reflections, extreme light contrasts, the use of sunglasses, or if the driver is not looking straight ahead may make the visual warning signal in the windscreen difficult to recognise.

 **Note**

Distance warning is deactivated during the time that Pilot Assist* is active.

 **Warning**

Distance Warning will only react if the time interval to a vehicle ahead falls to below a certain limit – the speed of your own car is not affected.

 **Warning**

- The function is supplementary driver support intended to facilitate driving and make it safer – it cannot handle all situations in all traffic, weather and road conditions.
- The driver is advised to read all sections in the Owner's Manual that relate to this function to learn about factors such as its limitations and what the driver should be aware of before using the system.
- Driver support functions are not a substitute for the driver's attention and judgement. The driver is always responsible for ensuring the car is driven in a safe manner, at the appropriate speed, with an appropriate distance to other vehicles, and in accordance with current traffic rules and regulations.

* Option/accessory.

^[1] Distance Alert

10.2.2. Limitations of distance warning

Distance warning ^[1] may have limited functionality in certain situations. The function is only available in cars that can show information on the windscreen with a so-called head-up display*.

 **Warning**

- The size of a vehicle may affect its ability to be detected, which may mean that the warning is either illuminated after a shorter time interval or temporarily does not appear.
- Extremely high speeds can cause the warning to illuminate after a shorter time interval due to limitations in radar unit range.

 **Note**

This function uses the car's radar and/or camera units, which have some general limitations.

^[1] Distance Alert

* Option/accessory.

10.2.3. Setting time interval to vehicle ahead

It is possible to set the time interval to the vehicle ahead to be maintained by Pilot Assist* .

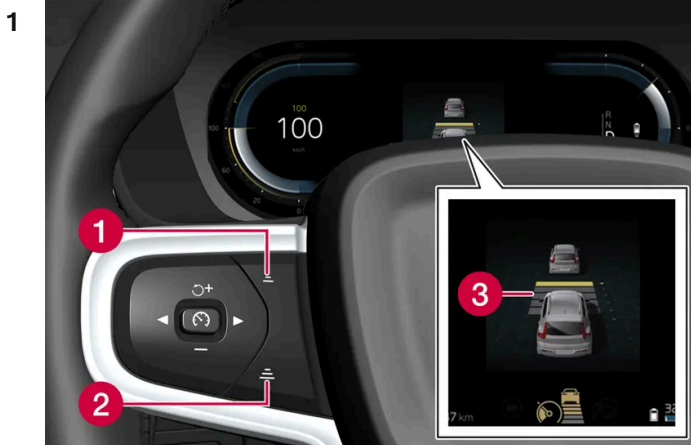

Control for time interval.

- 1 Decrease time interval
- 2 Increase time interval
- 3 Distance indicator

Press the steering wheel button (1) or (2) to increase or decrease the time interval.

➤ The distance indicator (3) shows the current time interval.

Different time intervals to the vehicle in front can be selected and shown in the driver display as 1-5 horizontal lines - the more lines the longer the time interval. One line represents about 1 second to the vehicle in front, 5 lines represents about 3 seconds.

Pilot Assist allows the time interval to vary significantly in certain situations in order to allow the car to follow the vehicle ahead smoothly and comfortably. At low speed, when the distances are short, Pilot Assist increases the time interval slightly.

i Note

When the symbol in the driver display shows a car and a steering wheel, Pilot Assist follows a vehicle in front at a preset time gap.

When only one steering wheel is shown, there is no vehicle within a reasonable distance ahead.

i Note

- The higher the speed the longer the calculated distance in metres for a given time interval.
- Only use the time intervals permitted by local traffic regulations.
- If the driver supports do not seem to respond with a speed increase when activated, it may be because the time window to the vehicle ahead is shorter than the set time window.

 **Warning**

- Only use a time window that suits the current traffic conditions.
- The driver should be aware that short time windows limit the amount of time available to react and take action in an unexpected traffic situation.

* Option/accessory.

10.2.4. Warning from cruise control functions in the event of a collision risk

The driver support system Pilot Assist* can warn the driver if the distance to the vehicle ahead suddenly becomes too short.

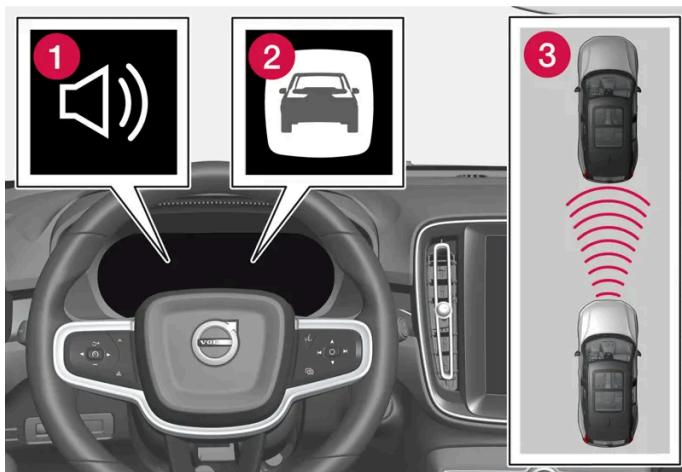

Audio and symbol for collision warning

- 1 Acoustic signal in the event of a risk of collision
- 2 Warning signal in the event of a risk of collision
- 3 Distance measurement with the camera and radar units

Pilot Assist uses approx. 40% of the foot brake's capacity. If the car needs to be braked more heavily than the driver support is capable of and the driver does not brake, the warning lamp and acoustic warning are activated to alert the driver that immediate intervention is required.

 **Warning**

The driver support systems only warn of vehicles which their radar unit has detected – hence a warning may not be given, or it may be given with a certain delay. Never wait for a warning. Apply the brakes when the situation requires.



Symbol for collision warning on the windscreen

In cars equipped with a head up display*, the warning is shown on the windscreen by a flashing symbol.

 **Note**

Strong sunlight, reflections, extreme light contrasts, the use of sunglasses, or if the driver is not looking straight ahead may make the visual warning signal in the windscreen difficult to recognise.

* Option/accessory.

10.3. Blind Spot Information

10.3.1. BLIS*

The BLIS^[1] function is intended to help the driver detect vehicles diagonally behind and to the side of the car so as to provide assistance in heavy traffic on roads with several lanes in the same direction.



Location of BLIS lamp

BLIS is a driver aid intended to give a warning of:

- vehicles in the car's blind spot
- quickly approaching vehicles in the left and right lanes closest to the car.

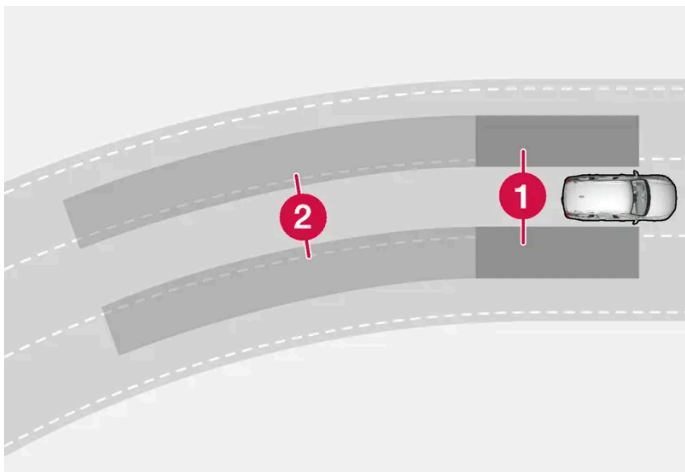

Principle of BLIS

- ❶ Zone in blind spot
- ❷ Zone for quickly approaching vehicle

The system is designed to react when:

- your car is overtaken by other vehicles
- another vehicle is approaching your own car at speed.

When BLIS detects a vehicle in Zone 1 or a quickly approaching vehicle in Zone 2, the indicator lamp on the door mirror on the right or left illuminates with a constant glow. If the driver activates the direction indicator on the same side as the warning, the indicator lamp will change over from a constant glow to flashing with a more intense light.

BLIS is active when the driver's vehicle is travelling at a speed above 12 km/h (7 mph).

BLIS reacts to passing vehicles driving up to 100 km/h (62 mph) faster than your vehicle.

The content of this manual represents the status of the user manual at the time of printing and may not be completely valid in future instances. For more information, refer to the first page for the complete disclaimer note.

 **Note**

The lamp illuminates on the side of the car where the system has detected the vehicle. If the car is overtaken on both sides at the same time then both lamps illuminate.

 **Warning**

- The function is supplementary driver support intended to facilitate driving and make it safer – it cannot handle all situations in all traffic, weather and road conditions.
- The driver is advised to read all sections in the Owner's Manual that relate to this function to learn about factors such as its limitations and what the driver should be aware of before using the system.
- Driver support functions are not a substitute for the driver's attention and judgement. The driver is always responsible for ensuring the car is driven in a safe manner, at the appropriate speed, with an appropriate distance to other vehicles, and in accordance with current traffic rules and regulations.

* Option/accessory.

^[1] Blind Spot Information

10.3.2. Messages for BLIS*

A number of messages regarding BLIS^[1] can be shown in the driver display. Here are some examples.

Message	Specification
Blind spot sensor Service required	The system does not function as it should. A workshop should be contacted ^[2] .
Blind spot system off Trailer attached	BLIS and Cross Traffic Alert* have been deactivated as a trailer has been connected to the car's electrical system.

A text message can be cleared by briefly pressing the  button, located in the centre of the steering wheel's right-hand keypad.

If a message remains, contact a workshop - an authorised Volvo workshop is recommended.

* Option/accessory.

^[1] Blind Spot Information

^[2] An authorised Volvo workshop is recommended.

10.3.3. Limitations of BLIS*

The BLIS^[1] function may have limitations in certain situations.



Keep the surface indicated clean – on both the left and right-hand sides of the car

Examples of limitations:

- Dirt, ice and snow covering the sensors may reduce the functions and deactivate alerts.
- The BLIS function is automatically deactivated if a trailer, bicycle rack or similar is connected to the car's electrical system.
- For good performance of BLIS, there should be no bicycle rack, luggage carrier or similar mounted on the car's towbar.

 **Warning**

- BLIS does not work on sharp bends.
- BLIS does not work when the car is reversing.

 **Note**

This function uses the car's radar units, which have certain general limitations.

* Option/accessory.

^[1] Blind Spot Information

10.4. Cross Traffic Alert

10.4.1. Warning and auto-brake when reversing*

There are systems in the car that can assist the driver to detect obstacles when reversing and even brake automatically if the driver does not manage to act in time.

The content of this manual represents the status of the user manual at the time of printing and may not be completely valid in future instances. For more information, refer to the first page for the complete disclaimer note.

The Rear Auto Brake (RAB) and Cross Traffic Alert (CTA)* functions are only active if the car rolls backwards or if reverse gear has been selected.

If obstacles are detected:

1. A warning signal and the parking assistance graphic illuminate to indicate the position of the obstacle.
2. If the driver ignores the warning and a collision is unavoidable, the car may be auto-braked, and an explanatory text message is shown for why the car was braked.

If the accelerator pedal is depressed forcefully then the car also reverses after braking automatically.

Warning

- The functions are supplementary driver supports intended to facilitate driving and make it safer – but they cannot handle all situations in all traffic, weather and road conditions.
- The driver is advised to read all sections in the owner's manual that relate to these functions to learn about factors such as limitations and what the driver should be aware of before using the functions.
- Driver support functions are not a substitute for the driver's attention and judgement. The driver is always responsible for ensuring the car is driven in a safe manner, at the appropriate speed, with an appropriate distance to other vehicles, and in accordance with current traffic rules and regulations.

Note

The functions use the car's camera and radar units, which have certain general limitations.

Obstacles immediately behind

Rear Auto Brake is intended to help the driver detect stationary obstacles that may be directly behind the car when it is being reversed.

This function is primarily designed to detect stationary obstacles that are higher than the rear bumper – and not moving vehicles, for example.

Brake intervention with Rear Auto Brake is active at speeds below 10 km/h (6 mph).

The auto brake needs to be deactivated before using an automatic car wash, and may also need to be deactivated to avoid unwanted intervention, e.g. when reversing in tall grass.

Obstacles from the side

Cross Traffic Alert is designed to help the driver detect traffic crossing behind the car when it is reversing.

This function is primarily designed to detect larger vehicles in motion. In favourable conditions it may also be able to detect smaller objects, such as cyclists and pedestrians.

Brake intervention with Cross Traffic Alert is active at speeds below 15 km/h (9 mph).

The auto brake needs to be deactivated before using an automatic car wash, and may also need to be deactivated to avoid unwanted intervention, e.g. when reversing in tall grass.

Examples of detection and limitations

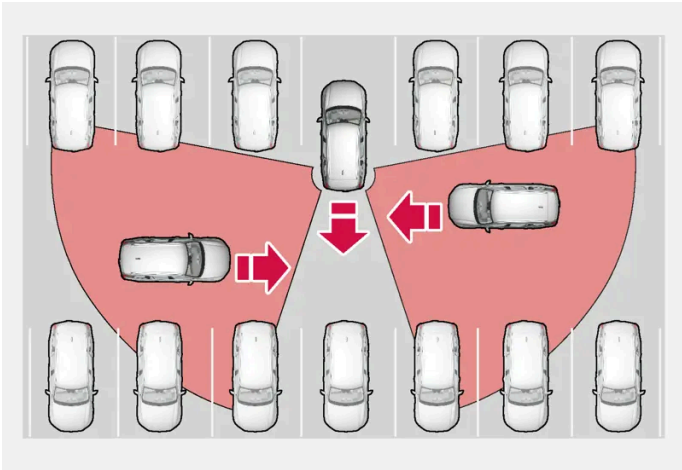

Examples of areas where the function can assist the driver to detect obstacles during reversing.

The function's sensors cannot detect moving traffic through other parked vehicles or bulky obstacles. Here are some examples of when approaching vehicles cannot therefore be detected until they are very close.

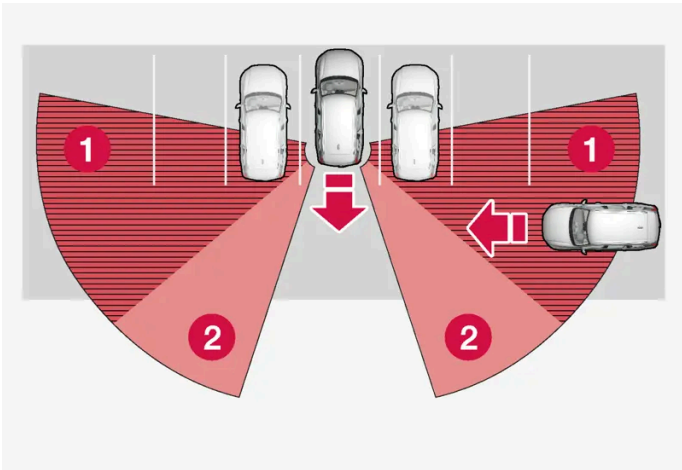

The car is parked deep inside a parking slot.

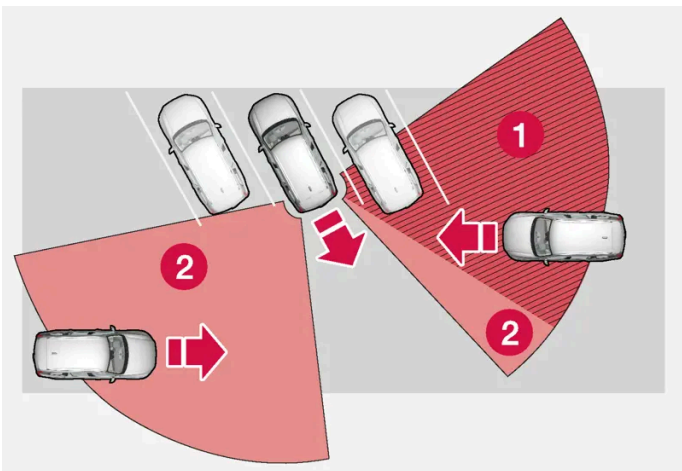

In an angled parking slot, the sensors may be completely blocked on one side.

- 1 Blind sector
- 2 Sector in which the function can detect

However, as your car slowly reverses, the angle it makes with the obstructing vehicle/object changes and the blind sector rapidly decreases.

Reversing with equipment connected to the towbar

RAB and CTA are deactivated automatically when a trailer, bicycle rack or similar is connected to the towbar connector. If the connected equipment has no electrical connection, RAB and CTA must be deactivated manually by pressing a button in the centre display.

* Option/accessory.

10.4.2. Activating and deactivating warning and auto-brake when reversing*

The driver can choose to deactivate auto-brake with Rear Auto Brake (RAB) and Cross Traffic Alert (CTA)*. The warning signal can be deactivated separately.

Warning signal



Activate or deactivate the warning signal with this button in the parking camera view.

- Illuminated button – the function is activated.
- Extinguished button – the function is deactivated.

Auto Brake



Activate or deactivate the auto-brake with this button in parking camera view.

- Illuminated button – the function is activated.
- Extinguished button – the function is deactivated.

The functions are activated automatically each time the engine is started.

* Option/accessory.

10.5. Rear Collision Warning

10.5.1. Rear Collision Warning*

The Rear Collision Warning^[1] (RCW) function can help the driver to avoid being hit by a vehicle approaching from behind.

Drivers in vehicles behind can be warned about an imminent collision by the function flashing intensively with the direction indicators.

If, at a speed below 30 km/h (20 mph), the function detects that the car is in danger of being hit from behind, the seatbelt tensioners may tension the front seatbelts. The Whiplash Protection System is also activated in the event of a collision.

Immediately before a collision from behind, this function may also activate the foot brake in order to reduce the forward acceleration of the car during the collision. However, the foot brake is only activated if the car is stationary. The foot brake releases immediately if the accelerator pedal is depressed.

This function is activated automatically each time the engine is started.

Warning

- The function is supplementary driver support intended to facilitate driving and make it safer – it cannot handle all situations in all traffic, weather and road conditions.
- The driver is advised to read all sections in the Owner's Manual that relate to this function to learn about factors such as its limitations and what the driver should be aware of before using the system.
- Driver support functions are not a substitute for the driver's attention and judgement. The driver is always responsible for ensuring the car is driven in a safe manner, at the appropriate speed, with an appropriate distance to other vehicles, and in accordance with current traffic rules and regulations.

* Option/accessory.

^[1] The function is not available in all markets.

10.5.2. Limitations of Rear Collision Warning*

In certain cases, the Rear Collision Warning (RCW)^[1] may have difficulty helping the driver in the event of a collision risk.

This can, for example, be if:

- the vehicle approaching from behind is detected too late
- the vehicle approaching from behind changes lane at the last moment
- a trailer, bicycle rack or similar is connected to the car's electrical system - the function is then deactivated automatically.

i Note

In certain markets, RCW does **not** give a warning with the direction indicators due to local traffic regulations - in such cases, this part of the function is deactivated.

i Note

This function uses the car's radar units, which have certain general limitations.

* Option/accessory.

[1] Rear collision warning.

10.6. Connected Safety

10.6.1. Connected Safety

Connected Safety^[1] communicates information between your own car and other vehicles via a cloud service^[2]. The function is intended to make a driver aware that there may be a potentially dangerous traffic situation further ahead on the same road.

The function can inform the driver whether another vehicle further ahead on the same road has activated its hazard warning flashers or detected slippery driving conditions. Information about slippery driving conditions is also given if your car detects slippery driving conditions.

Connected Safety can help the driver with the following:

- Alarm on hazard warning flashers
- Alarm on slippery driving conditions

Connected Safety communication between vehicles only works for vehicles equipped with the function. Connected Safety also needs to be actively approved via **Volvo privacy settings**.

Alarm on hazard warning flashers

If hazard warning flashers are activated on your vehicle, this information can be sent to other vehicles approaching your vehicle's position.



When your vehicle is approaching a vehicle with flashing hazard warning flashers, this symbol is shown on the driver display.

In vehicles with head-up display, the warning symbols for Connected Safety are also shown there.

Alarm on slippery driving conditions



If your vehicle detects a deterioration in friction between the tyres and the road surface, this symbol appears in the driver display. The information can then be sent to vehicles approaching your vehicle's position.



If your vehicle receives information about slippery road conditions from another vehicle, this symbol appears in the driver display.

In vehicles with head-up display, the warning symbols for Connected Safety are also shown there.

Warning

- The function is supplementary driver support intended to facilitate driving and make it safer – it cannot handle all situations in all traffic, weather and road conditions.
- The driver is advised to read all sections in the Owner's Manual that relate to this function to learn about factors such as its limitations and what the driver should be aware of before using the system.
- Driver support functions are not a substitute for the driver's attention and judgement. The driver is always responsible for ensuring the car is driven in a safe manner, at the appropriate speed, with an appropriate distance to other vehicles, and in accordance with current traffic rules and regulations.

^[1] Not available on all markets.

^[2] Data is transferred (data traffic) when using the cloud service, and this may involve a cost.

10.6.2. Activating and deactivating Connected Safety

For Connected Safety to be able to share information on road conditions with other vehicles, the function needs to be approved in **Volvo privacy settings**.

Privacy settings

Profile not logged-in:

- 1 Press  in the centre display.
- 2 Press **Privacy**
- 3 Then tap on **Privacy** and approve Connected Safety.

Profile logged-in:

- 1 Press  in the centre display.
- 2 Press **Profiles**.
- 3 Then tap on **Privacy** and approve Connected Safety.

If there is no Internet connection, your own car will still inform you, the driver, that slippery driving conditions have been detected by your own car. For Connected Safety to work fully, your own car needs to be connected to the Internet.

10.6.3. Limitations of Connected Safety

Information about vehicles with activated hazard warning flashers or which have detected slippery driving conditions is not always communicated between all vehicles within the same area.

This can be because for example:

- Poor or no contact with the Internet.

- Vehicles on slippery surfaces make manoeuvres that are too weak for low friction between tyres and road surface to be detectable, e.g. steering wheel movement, acceleration or braking.
- Vehicles that have low friction, or have activated their hazard warning flashers, do not have the functions activated.
- Vehicles that have low friction, or have activated their hazard warning flashers, are not equipped with the functions.
- There may be no warning due to missing or defective global positioning/satellite navigation.
- Detection of low friction or activation of hazard warning flashers has taken place on a road which is missing from Volvo Cars database.
- Connected Safety is not available in all markets and does not cover all areas - a retailer for Volvo has information on current areas.

 **Warning**

- In certain situations, the function may give incorrect warnings for slippery driving conditions.
- The function cannot always detect other vehicles with activated hazard warning flashers or detect all sections of road with slippery surfaces.

10.7. Assistance at risk of collision

10.7.1. Assistance at risk of collision

Assistance at risk of collision^{[1] [2]} can assist the driver to avoid or mitigate a collision with a warning, automatic braking and steering assistance.

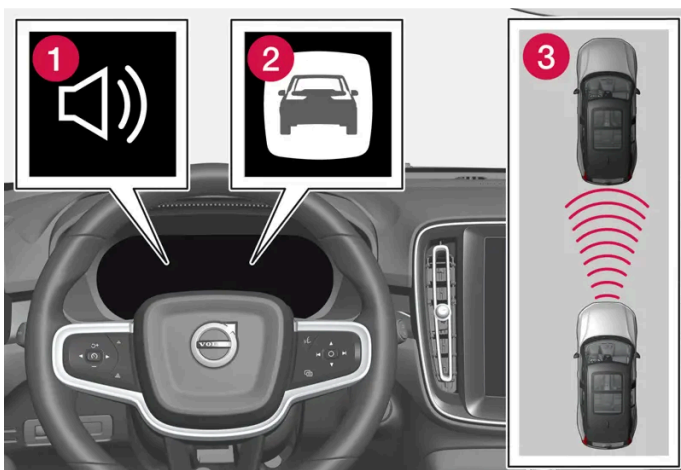

Audio and symbol for collision warning

- 1 Acoustic signal in the event of a risk of collision
- 2 Warning signal in the event of a risk of collision
- 3 Distance measurement with the camera and radar units

The driver or passengers are not normally aware of the function – it only intervenes in a situation where a collision is immediately imminent.

The function can help the driver to avoid a collision when driving in queues, e.g. when changes in the traffic ahead, combined with a lapse in attention, could lead to an incident. The function then activates a short, sharp braking procedure, normally stopping the car just behind the vehicle in front.

The function cannot be deactivated but is always activated.

Subfunctions

Assistance at risk of collision can perform the following steps if necessary:

- Collision warning
- Assisted braking
- Automatic braking
- Steering assistance

Step 1 – Collision warning

If there is a risk of collision with a pedestrian, cyclist, large animal or a vehicle then the driver's attention is alerted to it by means of a warning symbol as well as acoustic and brake pulse warnings. There is no brake pulse warning in the event of sudden driver braking or acceleration. The brake pulse frequency varies according to the car's speed.

Step 2 – Assisted braking

Assisted braking reinforces the driver's braking action if the system considers that the braking is not sufficient to avoid a collision.

Step 3 – Automatic braking

If the driver has not started to take evasive action and the risk of collision is imminent then the automatic braking function is deployed – this takes place irrespective of whether or not the driver brakes. Braking then takes place with full brake force in order to reduce collision speed, or with limited brake force if it is sufficient to avoid a collision.

The seatbelt tensioner can be activated in connection with the engagement of the automatic brake function.

The function is designed to be activated as late as possible in order to avoid unnecessary intervention. Automatic braking takes place only after or at the same time as the collision warning.

When brake assistance has prevented a collision with a stationary object, the car remains stationary in anticipation of positive action by the driver. If the car has been braked to avoid collision with a slower vehicle in front its speed is reduced to match that of the vehicle in front.

The driver can always interrupt a braking intervention by firmly depressing the accelerator pedal.

When the function is activated and brakes, the brake lights are switched on. The driver display shows a text message advising that the function is or has been active.

 **Warning**

The function must not be used by the driver to change his/her driving style – the driver must not rely on the function alone and allow it to do the braking.

Steering assistance

The function can help the driver reduce the risk of the car leaving its lane unintentionally or colliding with another vehicle or obstacle by actively steering the car back into its lane or swerving. Steering assistance does not occur in sequence but can take place regardless of when the other elements occur.

After automatic engagement, the driver display indicates that this has occurred via a text message.

 **Note**

It is always the driver who decides how much the car should steer – the car can never take command.

 **Warning**

- The function is supplementary driver support intended to facilitate driving and make it safer – it cannot handle all situations in all traffic, weather and road conditions.
- The driver is advised to read all sections in the Owner's Manual that relate to this function to learn about factors such as its limitations and what the driver should be aware of before using the system.
- Driver support functions are not a substitute for the driver's attention and judgement. The driver is always responsible for ensuring the car is driven in a safe manner, at the appropriate speed, with an appropriate distance to other vehicles, and in accordance with current traffic rules and regulations.

^[1] Collision Avoidance

^[2] The function is not available in all markets.

10.7.2. Detection of obstacles with assistance at risk of collision

Assistance at risk of collision^[1] can help the driver to detect different types of obstacle.

The function can detect pedestrians, cyclists or vehicles that are stationary or moving in the same direction as the car and are ahead. The function can also detect pedestrians, cyclists or large animals that are crossing the road in front of the car.

 **Warning**

Warnings and brake interventions could be late or not occur at all. The driver is always responsible that the vehicle is driven correctly and with a safety distance adapted to the speed.

Vehicles

In order for the function to be able to detect a vehicle in the dark, the vehicle's front and rear lights must be working and clearly illuminated.

Cyclists

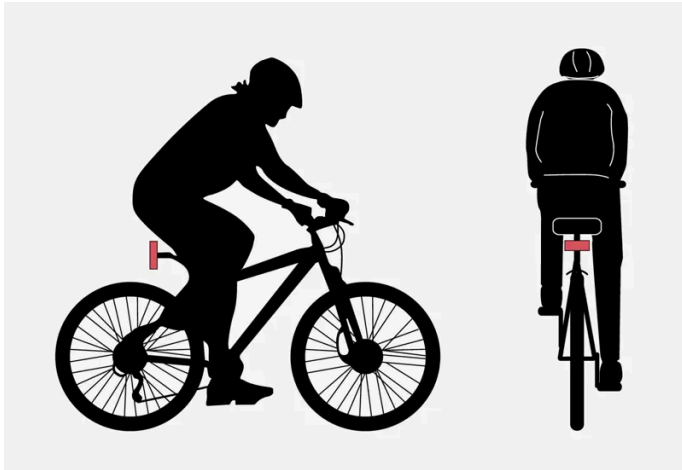

Examples of what the function interprets as a cyclist — with clear body outline and bicycle outline.

Good performance requires that the camera and radar units that detect a cyclist must receive the clearest possible information about the body and bicycle outline, requiring the ability to identify the bicycle, head, arms, shoulders, legs, upper and lower body plus a normal human pattern of movement.

If large parts of the cyclist's body or bicycle are not visible to the function's camera then the system cannot detect a cyclist.

For the function to be able to detect a cyclist, he/she must be an adult and riding a bicycle designed for adults.

Warning

The function is a supplementary driver support, but it cannot detect all cyclists in all situations and, for example, cannot see:

- partially obscured cyclists.
- cyclists if the background contrast for the cyclists is poor.
- cyclists wearing clothing that obscures the body outline.
- bicycles loaded with large objects.

Pedestrians

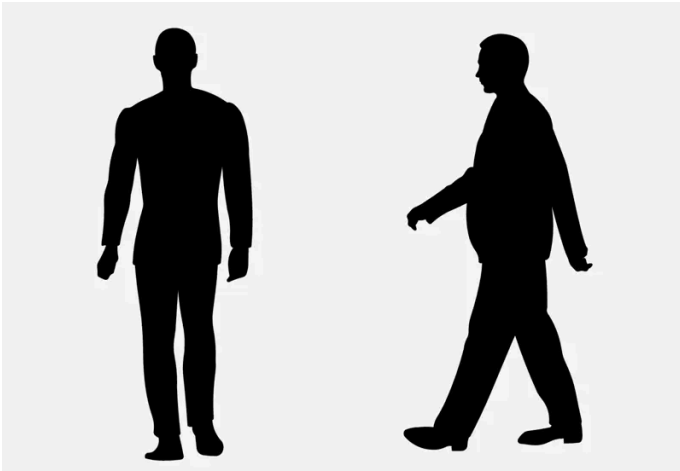

Examples of what the function regards as pedestrians with clear body outlines.

Good performance requires that the camera and radar units that detect a pedestrian must receive the clearest possible information about the body outline, requiring the ability to identify the head, arms, shoulders, legs, upper and lower body plus a normal human pattern of movement.

In order that it shall be possible to detect a pedestrian there must be a contrast with the background and this will be affected by such things as clothes, the background and the weather. With poor contrast the pedestrian may either be detected late or not at all, which may mean that warnings and braking are late or omitted.

The function can also detect pedestrians in the dark if they are illuminated by the car's headlamps.

Warning

The function is a supplementary driver support, but it cannot detect all pedestrians in all situations and, for example, cannot see:

- partially obscured pedestrians, people in clothing that hides their body contour or pedestrians shorter than 80 cm (32 tum).
- pedestrians if the background contrast for the pedestrians is poor.
- pedestrians who are carrying larger objects.

Large animals

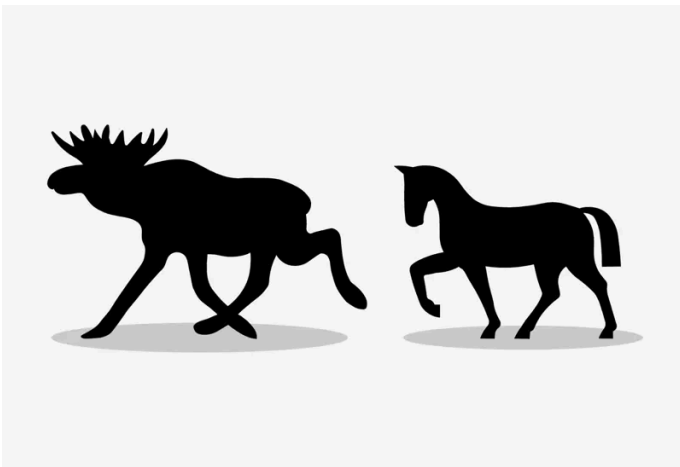

Examples of what the function interprets as large animals - standing still or walking slowly and with clear body outline.

Good performance requires that the system function that detects a large animal (e.g. elk and horse) must receive the clearest possible information about the body outline, requiring the ability to identify the animal directly from the side in combination with what is a normal pattern of movement for the animal.

If parts of the animal's body are not visible to the function's camera then the system cannot detect the animal.

The function can also detect large animals in the dark if they are illuminated by the car's headlamps.

Warning

The function is supplementary driver support, but it cannot detect all large animals in all situations and, for example, cannot see:

- partially obscured large animals.
- larger animals seen from the front or from behind.
- large animals that run or move quickly.
- large animals if the background contrast for the animals is poor.
- small animals such as dogs and cats, for example.

Warnings and brake interventions could be late or not occur at all. The driver is always responsible that the vehicle is driven correctly and with a safety distance adapted to the speed.

^[1] Collision Avoidance

10.7.3. Speed reduction option with assistance at risk of collision

Assistance at risk of collision^[1] can help to prevent a collision or reduce the collision speed.

If the speed difference between the driver's car and the obstacle is greater than the following specified speeds, the automatic brake function cannot prevent a collision but it can mitigate the consequences of a collision.

Vehicles

For a vehicle in front, brake assistance can reduce the speed by up to 60 km/h (37 mph).

Cyclists

For a cyclist, brake assistance can reduce the speed by up to 50 km/h (30 mph).

Pedestrians

For a pedestrian, brake assistance can reduce the speed by up to 45 km/h (28 mph).

Large animals

The content of this manual represents the status of the user manual at the time of printing and may not be completely valid in future instances. For more information, refer to the first page for the complete disclaimer note.





In the event of a risk of a collision with a large animal, brake assistance can reduce the car's speed by up to 15 km/h (9 mph).

The brake function for large animals is primarily intended to reduce the force of the impact at higher speeds and is most effective at speeds above 70 km/h (43 mph) but less effective at lower speed.

[1] Collision Avoidance

10.7.4. Symbols and messages for assistance at risk of collision

A number of symbols and messages regarding assistance at risk of collision [1] can be shown in the driver display. Here are some examples.

Symbol	Message	Specification
	Automatic intervention Collision Avoidance	When the function is activated, a message is shown to the driver indicating that the system has been activated.
	Collision Avoidance system unavailable	The system is temporarily out of order or is working with reduced performance.
	Collision Avoidance Reduced functionality Service required	The system does not function as it should. Contacting a workshop.
	Windscreen sensor blocked See Owner's manual	The ability of the camera to scan the roadway in front of the car is reduced.

A text message can be cleared by briefly pressing the  button, located in the centre of the steering wheel's right-hand keypad.

If a message remains, contact a workshop - an authorised Volvo workshop is recommended.

[1] Collision Avoidance

10.7.5. Limitations for assistance at risk of collision

Assistance at risk of collision [1] has certain limitations that a driver should be aware of.

Limitations for brake assistance

Extra equipment

Low-hanging objects, e.g. a flag/pennant for projecting load, or accessories such as auxiliary lamps and bull bars that are higher than the car bonnet limit the function since they may obstruct the camera or radar unit.

Skidding

The content of this manual represents the status of the user manual at the time of printing and may not be completely valid in future instances. For more information, refer to the first page for the complete disclaimer note.

On slippery road surfaces the braking distance is extended, which may reduce the capacity of the function to avoid a collision. In such situations, the anti-lock brakes and the stability control ESC^[2] are designed to give the best possible braking force with maintained stability.

Low speed

The function is not activated at very low speeds – below 4 km/h (3 mph) – and the system therefore does not intervene in situations where your car is approaching a vehicle ahead very slowly, e.g. when parking.

Active driver

Driver commands are always prioritised. The function does not intervene in situations where the driver is steering and accelerating in a decisive manner, even if a collision is unavoidable. Active and aware driving behaviour can therefore delay a collision warning and intervention in order to minimise unnecessary warnings.

Limitations for steering assistance

In certain situations the function may have limited functionality and fail to intervene in the following cases, for example:

- for small vehicles, such as motorcycles
- if the majority of the car has moved into the adjacent lane
- on roads/in lanes with unclear or non-existent lane markings
- outside the speed range 60-140 km/h (37-87 mph)
- steering assistance for evasive manoeuvres: outside the speed range 50–100 km/h (30–62 mph)
- as the steering servo for speed-dependent steering wheel resistance is working at reduced power – e.g. when cooling due to overheating.

Other demanding situations can include:

- road works
- winter road conditions
- narrow roads
- poor road surface
- a very “sporty” driving style
- poor weather with reduced visibility.

In these demanding situations, the function may have difficulty helping the driver correctly.

Important warnings

Warning

Driver supports only warn of obstacles which their radar unit has detected – hence a warning may not be given, or it may be given with a certain delay.

- Never wait for a warning or intervention. Apply the brakes when the situation requires.

 **Warning**

- Automatic braking can prevent a collision or reduce collision speed, but to ensure full brake performance the driver should always depress the brake pedal – even when the car brakes automatically.
- The warning and steering assistance are only activated if there is a high risk of collision – you must therefore never wait for a collision warning or for the function to intervene.
- The function does not activate any automatic brake interventions in the event of heavy acceleration.

 **Warning**

- Warnings and brake interventions could be implemented late or not at all if a traffic situation or external influences mean that the camera and radar units cannot detect pedestrians, cyclists, large animals or vehicles correctly.
- For vehicles to be detected at night, their headlamps and rear lamp cluster must be switched on and shining clearly.
- Warnings for stationary and slow-moving vehicles, as well as large animals, may be disengaged due to darkness or poor visibility.
- Warnings and brake interventions for pedestrians and cyclists are deactivated at vehicle speeds exceeding 80 km/h (50 mph).
- The system can provide effective warnings and brake interventions as long as the relative speed is below 50 km/h (30 mph).
- For stationary or slow-moving vehicles, warnings and brake interventions are effective at vehicle speeds up to 70 km/h (43 mph).
- Speed reduction for large animals is less than 15 km/h (9 mph) and can be achieved at vehicle speeds above 70 km/h (43 mph). The warning and brake intervention for large animals is less effective at lower speeds.
- Do not place, stick or mount anything on the outside or inside of the windscreen in front of or around the camera unit – this can interfere with camera-dependent functions.
- Objects, snow, ice or dirt in the area of the camera and radar units may reduce their functionality, fully deactivate them or give incorrect function response.

 **Note**

This function uses the car's camera and radar units, which have certain general limitations.

 **Important**

Maintenance of driver support components must only be performed at a workshop – an authorised Volvo workshop is recommended.

^[1] Collision Avoidance

^[2] Electronic Stability Control

10.7.6. Collision Avoidance – steering assistance for evasive manoeuvres

Steering assistance can assist the driver to steer away from an obstacle when it is not possible to avoid a collision by braking alone. Steering assistance is always enabled and cannot be deactivated.

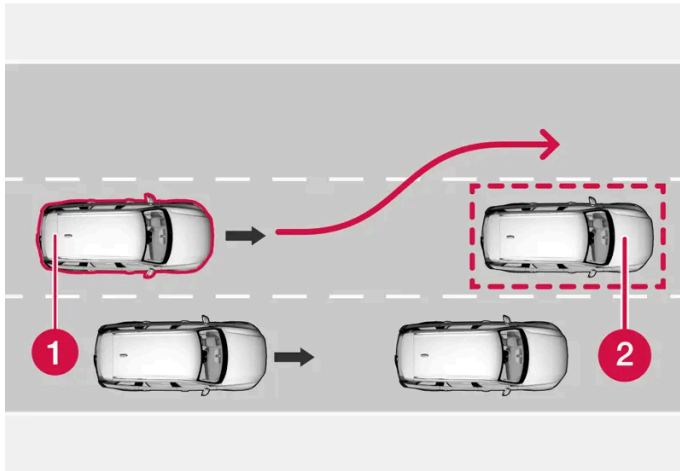

- 1 Your car steers away.
- 2 Slow/stationary obstacle.

The function engages by amplifying the driver's steering input, which only occurs after the driver has begun to take evasive action - and then only if the driver is not steering enough to avoid a collision.

In parallel with the amplified steering input, the brake system is also used to further amplify the steering input. The function also helps to straighten the car again after passing the obstacle.

The function can detect:

- vehicles
- cyclists
- pedestrians
- larger animals.

10.7.7. Assistance at risk of collision in crossing traffic

Assistance at risk of collision^[1] can assist the driver when turning and crossing the path of an oncoming vehicle at an intersection.

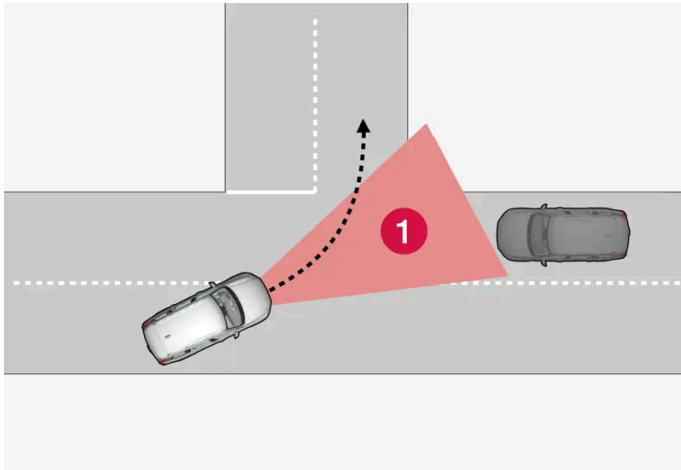

1 Sector in which the function can detect oncoming crossing vehicles.

For the function to detect an oncoming vehicle on a collision course, the oncoming vehicle must first enter the sector in which the function can analyse the situation.

In addition:

- your car's speed must be at least 4 km/h (3 mph).
- your car must turn to the left in markets with right-hand traffic (or to the right in left-hand traffic).
- the oncoming vehicle must have its headlamps switched on.

The function may have difficulty in assisting the driver if, for example:

- there are slippery driving conditions and stability control^[2] intervenes.
- an oncoming vehicle is detected too late.
- an oncoming vehicle is obscured by something.
- the oncoming vehicle has headlamps switched off.
- the oncoming vehicle drives in an unpredictable manner, for example, abruptly changes lanes at a late stage.

 **Warning**

Warnings and steering assistance due to an impending collision with an oncoming vehicle always come very late.

 **Note**

This function uses the car's camera and radar units, which have certain general limitations.

^[1] Collision Avoidance

^[2] Electronic Stability Control (ESC)

10.7.8. Assistance at risk of collision in oncoming traffic

Assistance at risk of collision^[1] can assist the driver to give steering assistance to avoid a collision with vehicles in the oncoming lane. The function can also reduce the speed of the car in order to reduce the force of an impact in the event of an encroachment into the car's own lane.

Meeting in own lane

If an oncoming vehicle enters your car's lane and a collision is unavoidable, the function can reduce the car's speed with a view to reducing the force of the impact.

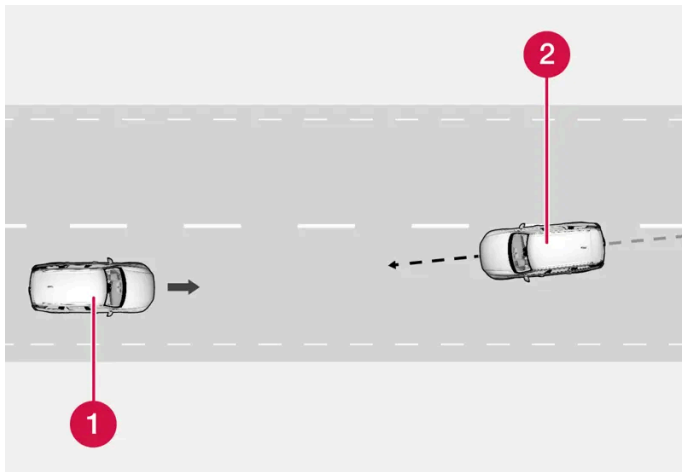

- 1 Your car
- 2 Oncoming vehicles

For this function to work, the following criteria must be met:

- your car must be travelling at more than 4 km/h (3 mph)
- the road section must be straight
- your car's lane must have clear lane markings
- your car must be positioned straight in its own lane
- the oncoming vehicle must be within your car's lane markings
- the oncoming vehicle must have its headlamps switched on
- this function can only handle "front to front" collisions
- this function can only detect vehicles with four wheels.

When drifting across to oncoming traffic

The function can help a distracted driver who does not notice that the car is drifting into the oncoming lane.

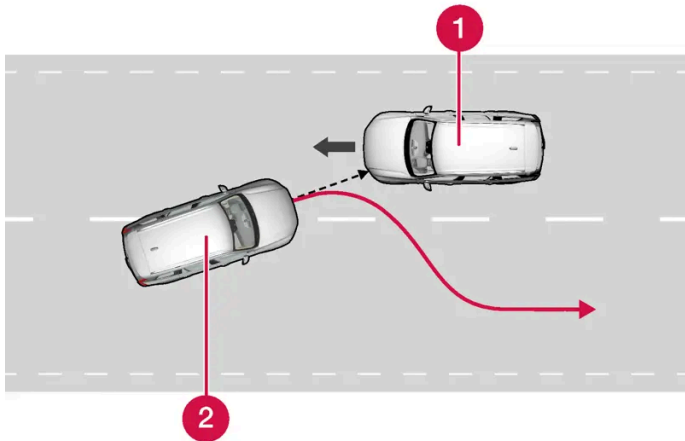

The function can assist by guiding the car back to its own lane.

1 Oncoming vehicles

2 Your car

The function is active within the speed range 60-140 km/h (37-87 mph) on roads with clearly visible lane markings/lines.

If the car is about to leave its own lane while an oncoming vehicle is approaching at the same time, the function can help the driver to steer the car back into its own lane.

However, the function does **not** intervene with steering assistance if the direction indicator is used. If the function detects that the driver is actively driving the car, activation of the function will be delayed.

When the function intervenes, a symbol and a message are shown in the driver display, and an acoustic signal can be heard as well.

 **Warning**

Warnings and steering assistance due to an impending collision with an oncoming vehicle always come very late.

 **Note**

This function uses the car's camera and radar units, which have certain general limitations.

[1] Collision Avoidance

10.7.9. Collision Avoidance to help avoid impact with a vehicle in the driver's blind spot *

Collision Avoidance^[1] can help a driver who does not notice that the car is about to leave its own lane while an oncoming vehicle is approaching at the same time, either from behind or in the blind spot.

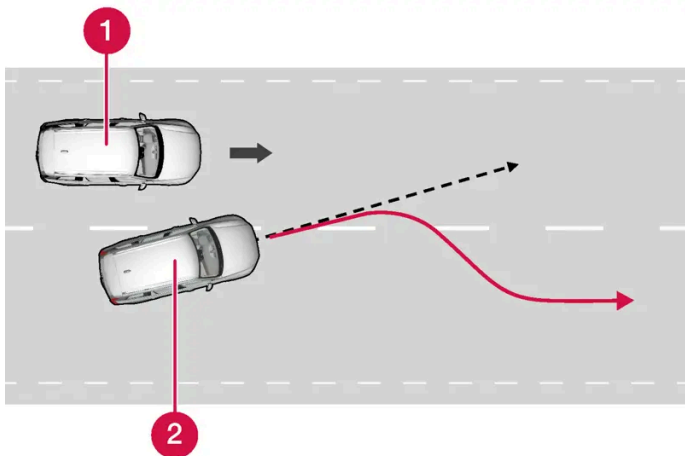

The function can assist by steering the car back to its own lane.

- 1 Other vehicle in the blind spot
- 2 Your car

The function can even assist if the driver intentionally changes lanes using direction indicators without noticing that another vehicle is approaching.

The function is active within the speed range 60-140 km/h (37-87 mph) on roads with clearly visible lane markings/lines.

The lamps in the door mirrors flash at the same time as the steering input. An acoustic signal can also be heard.

When the function intervenes, a message is shown in the driver display.

 **Warning**

Warnings and steering assistance due to an impending collision always come very late.

 **Note**

This function uses the car's camera and radar units, which have certain general limitations.

* Option/accessory.

^[1] Collision Avoidance

10.7.10. Assistance at risk of run-off

Assistance at risk of collision^[1] can help the driver and reduce the risk of the car accidentally leaving the road by actively steering the car back onto the road.

The function has two levels for intervention:

- Steering assistance only
- Steering assistance with brake intervention

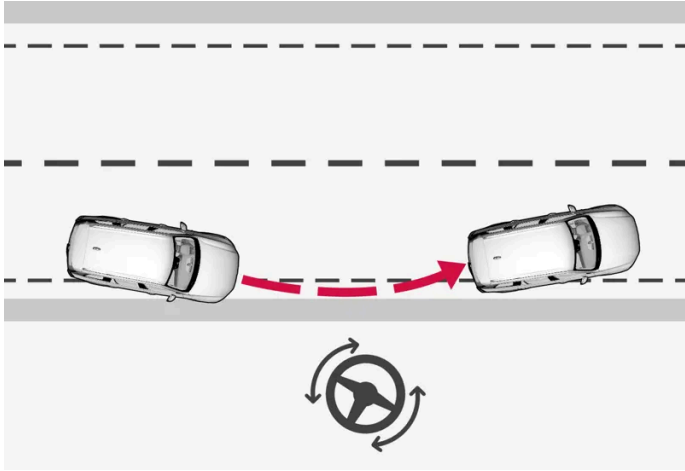

Intervention with steering assistance

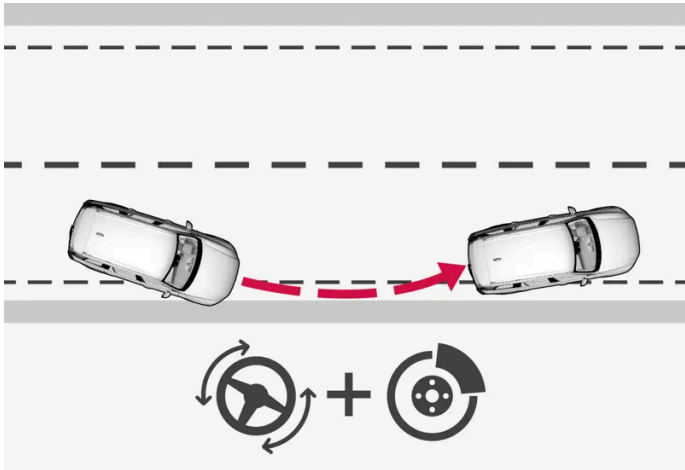

Intervention with steering assistance and braking

Brake intervention helps in situations where steering assistance alone is not sufficient. The brake force is adapted automatically depending on the situation at the time of road run-off.

The function is active within the speed range 65-140 km/h (40-87 mph) on roads with clearly visible lane markings/lines.

The car's camera unit scans the edges of the road and the painted lane markings. If the car is about to leave the side of the road, the car can be steered back onto the road and if the steering intervention is not enough to avoid run-off, the brakes are also activated.

However, there is no intervention from the function with either steering assistance or brake intervention if the direction indicators are used. If the function detects that the driver is actively driving the car, activation of the function will be delayed.

When the function intervenes, a message is shown in the driver display.

 **Warning**

Warnings and steering assistance due to an impending collision with an oncoming vehicle always come very late.

Note

This function uses the car's camera and radar units, which have certain general limitations.

[1] Collision Avoidance

10.8. Driver Alert Control

10.8.1. Driver Alert

The Driver Alert function is intended to help make the driver aware that he or she is starting to drive less consistently, e.g. if the driver becomes distracted or starts to fall asleep.

The objective for the function is to detect slowly deteriorating driving ability and it is primarily intended for major roads. The function is not intended for city traffic.

The function is activated when speed exceeds 65 km/h (40 mph) and remains active as long as the speed is over 60 km/h (37 mph).

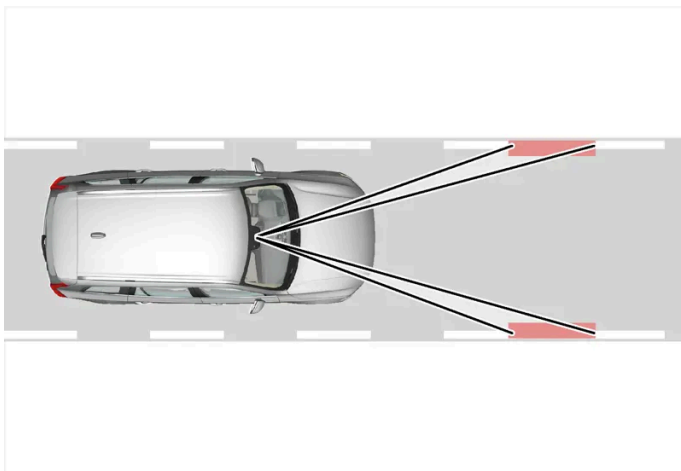

Driver Alert reads the position of the car in the lane.

A camera detects the edge markings painted on the carriageway and compares the alignment of the road with the driver's steering wheel movements.

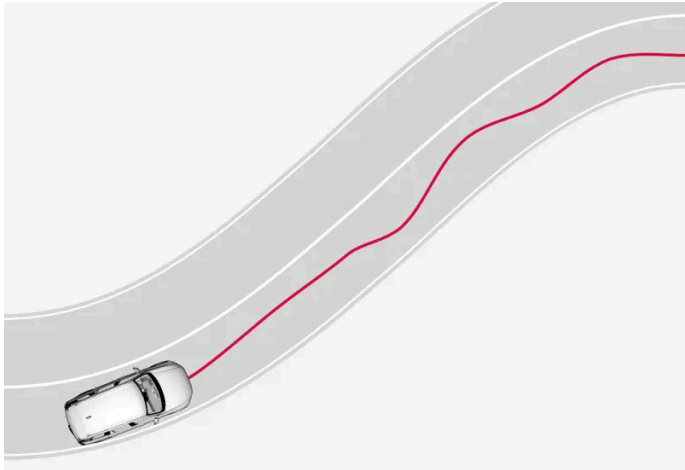

The car is being driven erratically in the lane.



If driving behaviour becomes noticeably inconsistent, the driver is alerted by this symbol in the driver display, combined with an acoustic signal and the text message **Time for a break Driver Alert**.

The warning is repeated after a time if driving behaviour has not improved.

 **Warning**

Driver Alert should not be used to extend a period of driving. The driver should instead plan for breaks at regular intervals and make sure they are well rested.

 **Warning**

An alarm from Driver Alert should be taken very seriously, as a sleepy driver is often not aware of his/her own condition.

If the alarm sounds or you feel fatigued:

- Stop the car safely as soon as possible and rest.

Studies have shown that it is just as dangerous to drive while tired as it is to drive under the influence of alcohol or other stimulants.

 **Warning**

- The function is supplementary driver support intended to facilitate driving and make it safer – it cannot handle all situations in all traffic, weather and road conditions.
- The driver is advised to read all sections in the Owner's Manual that relate to this function to learn about factors such as its limitations and what the driver should be aware of before using the system.
- Driver support functions are not a substitute for the driver's attention and judgement. The driver is always responsible for ensuring the car is driven in a safe manner, at the appropriate speed, with an appropriate distance to other vehicles, and in accordance with current traffic rules and regulations.

10.8.2. Limitations of Driver Alert

The Driver Alert function may have limitations in certain situations.

In some cases the system may issue a warning despite driving ability not deteriorating, for example:

- in strong side winds
- on rutted road surfaces.

Warning

In some cases, driving behaviour is not affected despite driver fatigue – e.g. when using the Pilot Assist* function – resulting in the driver not getting a warning from Driver Alert.

Note

This function uses the car's camera and radar units, which have certain general limitations.

* Option/accessory.

10.9. Lane assistance

10.9.1. Lane assistance

The function of the Lane Keeping Aid (LKA^[1]) is to help the driver to reduce the risk of the car accidentally leaving its own lane on motorways and similar major routes.

Lane Keeping Aid steers the car back into its lane and/or alerts the driver with vibrations in the steering wheel.

Lane Keeping Aid is active within the speed range 65–200 km/h (40–125 mph) on roads with clearly visible side lines.

On narrow roads the function may be unavailable, in which case it goes into standby mode. The function becomes available again when the road is wide enough.

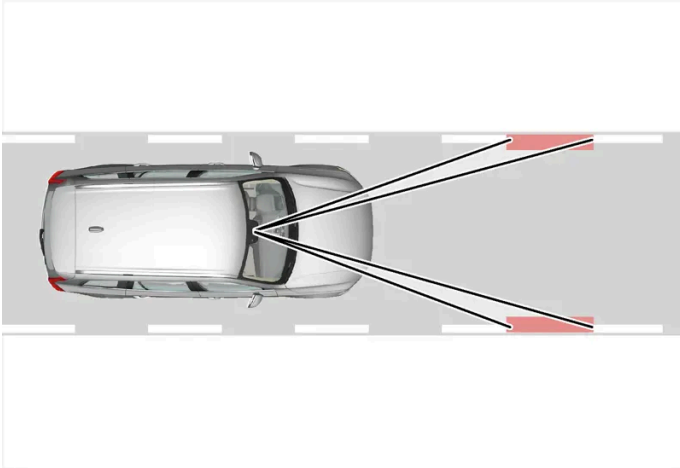

A camera reads the side lines of the road/lane.

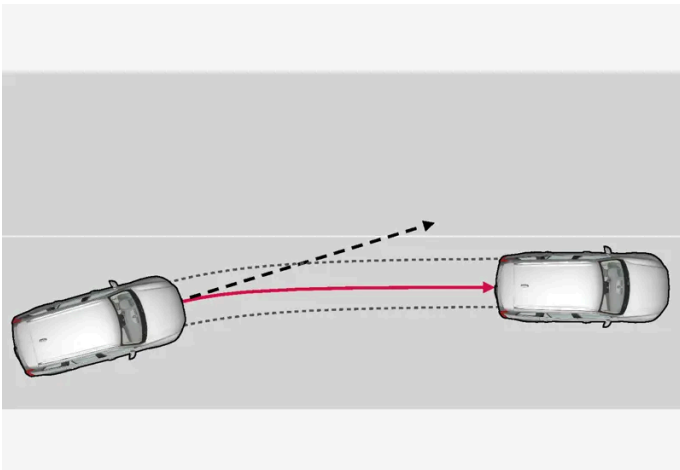

Lane assistance steers the car back into its lane.

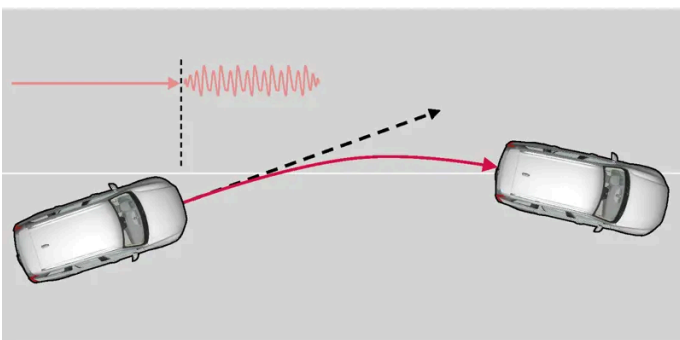

Lane assistance warns with steering wheel vibrations.

Lane assistance acts as follows:

- When the car is approaching a lane line, the function will actively steer the car back into its lane by applying a slight torque to the steering wheel.
- If the car is about to cross a lane line, the driver is warned by means of vibrations in the steering wheel.

The content of this manual represents the status of the user manual at the time of printing and may not be completely valid in future instances. For more information, refer to the first page for the complete disclaimer note.

Note

When a direction indicator/flasher is switched on, there are no steering corrections or alerts from lane assistance.

Warning

- The function is supplementary driver support intended to facilitate driving and make it safer – it cannot handle all situations in all traffic, weather and road conditions.
- The driver is advised to read all sections in the Owner's Manual that relate to this function to learn about factors such as its limitations and what the driver should be aware of before using the system.
- Driver support functions are not a substitute for the driver's attention and judgement. The driver is always responsible for ensuring the car is driven in a safe manner, at the appropriate speed, with an appropriate distance to other vehicles, and in accordance with current traffic rules and regulations.

Lane assistance does not intervene

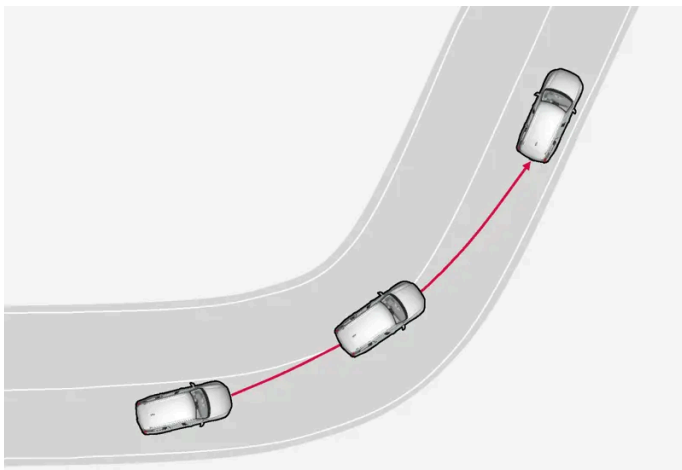

Lane assistance does not engage on sharp inside curves.

In some situations, lane assistance allows lane lines to be crossed without intervening with either steering assistance or a warning – e.g. when using the direction indicators or if the car is allowed to cut the corners in bends.

Hands on the steering wheel

For steering assistance with lane assistance to work, the driver must have his/her hands on the steering wheel, which the system will continue to monitor.

If the driver does not keep his/her hands on the steering wheel, a warning signal is heard and a message encourages the driver to steer the car actively:

- **Apply steering Lane Keeping Aid**

If the driver fails to comply with the request and start to steer, a warning sound is heard until the driver starts to steer the car again.

10.9.2. Activating and deactivating lane assistance

The lane assistance (LKA^[1]) function is activated automatically with each drive cycle – the driver can choose to have the function activated or deactivated. However, steering intervention will always be active for unbroken lines.

Activate or deactivate the function under settings.

- 1 Press  in the centre display.
- 2 Tap on **Driving** and activate the desired function.

10.9.3. Difference between Pilot Assist* and lane assistance

Pilot Assist is a comfort function that can help you to keep your car within its own lane and maintain a safe distance from vehicles in front of you. Lane assistance^[1] is a function which, in a similar way, can help you in some situations to reduce the risk of your car accidentally leaving its own lane.

Pilot Assist



Pilot Assist can help you to steer your car between the lane's markings, as well as maintaining a preset speed and time interval to the vehicle ahead. The function can also help to maintain an advantageous position in the lane using the lane's lane lines.

What does Pilot Assist do?

- Can help to keep the car within its lane by assisting steering in some cases.
- Can help to maintain a preset speed or the distance to the vehicle ahead by means of acceleration and braking operations.

How do I know when Pilot Assist is operational?

Symbols in the driver display in the car indicate when Pilot Assist is operational.

	Adaptive Cruise Control is active. Pilot Assist is selected but not available. The criteria for the function are not met.
	Pilot Assist is active.

Lane assistance

Lane assistance can provide steering assistance and/or give you an alert when the vehicle is about to leave its own lane unintentionally. This function is active in the speed range 65-180 km/h (40-112 mph) on roads with clearly visible lane lines.

What does lane assistance do?

- Lane assistance can provide the driver with steering assistance, steering the car back into its lane and/or providing warnings using steering wheel vibration.

How do I know when lane assistance is operational?

Symbols in the driver's display in the car show the status of the function.

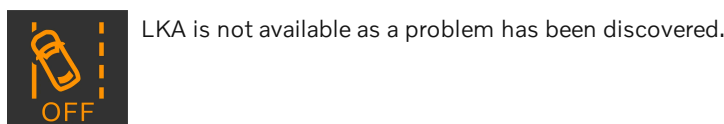
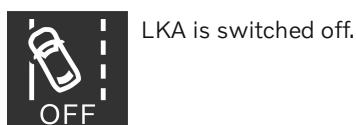
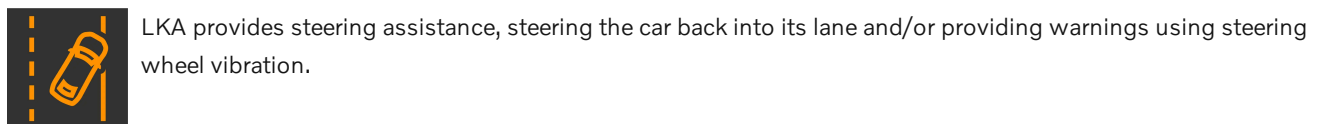
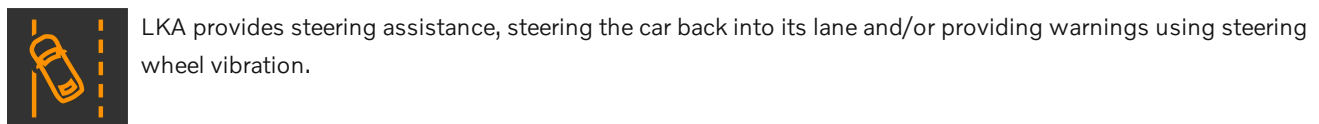
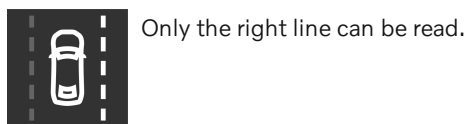
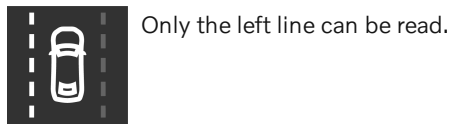
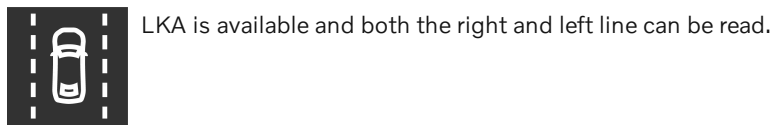
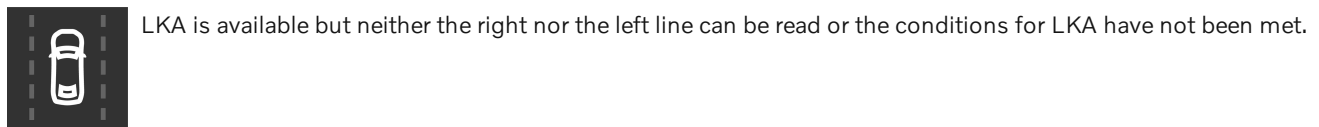

 **Warning**

The driver always bears responsibility for ensuring that the car is driven safely. Before using this function, the driver is recommended to read all sections on the function in the owner's manual.

 **Warning**





- The function is supplementary driver support intended to facilitate driving and make it safer – it cannot handle all situations in all traffic, weather and road conditions.
- The driver is advised to read all sections in the Owner's Manual that relate to this function to learn about factors such as its limitations and what the driver should be aware of before using the system.
- Driver support functions are not a substitute for the driver's attention and judgement. The driver is always responsible for ensuring the car is driven in a safe manner, at the appropriate speed, with an appropriate distance to other vehicles, and in accordance with current traffic rules and regulations.

* Option/accessory.

^[1] Lane Keeping Aid(LKA)

10.9.4. Symbols and messages for lane assistance

A number of symbols and messages regarding lane assistance (LKA ^[1]) can be shown on the driver display. Here are some examples.

Symbol	Message	Specification
	Driver support system Reduced functionality Service required	The system does not function as it should. A workshop should be contacted ^[2] .
	Windscreen sensor blocked See Owner's manual	The ability of the camera to scan the roadway in front of the car is reduced.
 	Apply steering Lane Keeping Aid	The steering assistance does not function if the driver does not have his/her hands on the steering wheel. Follow the instruction and steer the car.
	Lane Keeping Aid not available	Steering assistance is currently not available. Contact a workshop if the icon has not gone after a number of drive cycles.

A text message can be cleared by briefly pressing the  button, located in the centre of the steering wheel's right-hand keypad.

If a message remains, contact a workshop - an authorised Volvo workshop is recommended.

^[1] Lane Keeping Aid

[2] An authorised Volvo workshop is recommended.

10.9.5. Display mode for lane assistance

Lane assistance (LKA^[1]) is visualised by symbols in the driver display depending on the situation.



Here are some examples of symbols and the situations in which they are shown:

Available



Available – One of the symbol's side lines is white.

Lane assistance reads one of the lane's side lines.

Unavailable



Unavailable – the lane lines in the symbol are extinguished.

The Lane assistance cannot detect the lane lines, the speed is too low or the road is too narrow.

Indication of steering assistance/warning



Steering assistance/warning – the lane lines in the symbol are coloured.

Lane assistance indicates that the system is giving a warning and/or attempting to steer the car back into the lane.

[1] Lane Keeping Aid

10.9.6. Limitations of Lane assistance

In certain demanding conditions lane assistance (LKA^[1]) may have difficulty helping the driver correctly. In such cases it is recommended to switch off this function.

Examples of such conditions are:

- road works
- winter road conditions
- poor road surface
- a very “sporty” driving style
- poor weather with reduced visibility
- roads with unclear or non-existent side markings
- sharp edges or lines other than the lane's side markings
- as the steering servo for speed-dependent steering wheel resistance is working at reduced power – e.g. when cooling due to overheating.

The function is unable to detect barriers, rails or similar obstacles at the side of the carriageway.

Note

This function uses the car's camera and radar units, which have certain general limitations.

^[1] Lane Keeping Aid

10.10. Electronic stability control

10.10.1. Electronic stability control

Electronic Stability Control (ESC^[1]) helps the driver to avoid skidding and improves the car's traction.



The driver display shows this symbol when the system is engaged.

Braking from the system may be heard as a pulsing sound, and the car may accelerate more slowly than expected when applying the throttle.

The system consists of the following subfunctions:

- Stability function^[2]
- Spin control and traction control system

The content of this manual represents the status of the user manual at the time of printing and may not be completely valid in future instances. For more information, refer to the first page for the complete disclaimer note.

- Engine Drag Control
- Trailer stability assist

 **Warning**

- The function is supplementary driver support intended to facilitate driving and make it safer – it cannot handle all situations in all traffic, weather and road conditions.
- The driver is advised to read all sections in the Owner's Manual that relate to this function to learn about factors such as its limitations and what the driver should be aware of before using the system.
- Driver support functions are not a substitute for the driver's attention and judgement. The driver is always responsible for ensuring the car is driven in a safe manner, at the appropriate speed, with an appropriate distance to other vehicles, and in accordance with current traffic rules and regulations.

Stability function ^[2]

The function checks the driving and brake force of the wheels individually in order to stabilise the car.

Spin control and traction control system

Spin control is activate at all speeds, and prevents the wheels from slipping against the road surface during acceleration.

Traction control is active at low speeds, and can brake a slipping wheel to increase traction on the wheel on the opposite side.

Engine Drag Control

Engine Drag Control (EDC ^[3]) can prevent involuntary wheel lock-up, e.g. when engine braking on slippery road surfaces. Involuntary wheel locking while driving can, amongst other things, impair the driver's ability to steer the car.

Trailer stability assist* ^[4]

Trailer stability assist (TSA ^[5]) stabilises a car towing a trailer in situations where they begin snaking.

^[1] Electronic Stability Control

^[2] Also known as Active Yaw Control.

^[3] Engine Drag Control



* Option/accessory.

^[4] Trailer stability assist is included when the Volvo genuine towbar is installed.

^[5] Trailer Stability Assist

10.10.2. Symbols and messages for electronic stability control

A number of symbols and messages regarding electronic stability control (ESC^[1]) can be shown on the driver display. Here are some examples.

Symbol	Message	Specification
	Constant glow for approx. 2 seconds	System check when the engine is started.
	Flashing light	The system is being activated.
	ESC Service required	The system is disengaged. Stop the car at a safe place. Check whether the error was temporary or if it persists by switching off the engine and starting it again. If the problem persists, contact a workshop – an authorised Volvo workshop is recommended. The car can be driven but without the ESC functionality.

A text message can be cleared by briefly pressing the  button, located in the centre of the steering wheel's right-hand keypad.

If a message remains, contact a workshop - an authorised Volvo workshop is recommended.

^[1] Electronic Stability Control

10.11. Road Sign Information

10.11.1. Road Sign Information *

The Road Sign Information function can help the driver to observe speed-related road signs and certain prohibition signs^[1].

The function is available in certain markets.

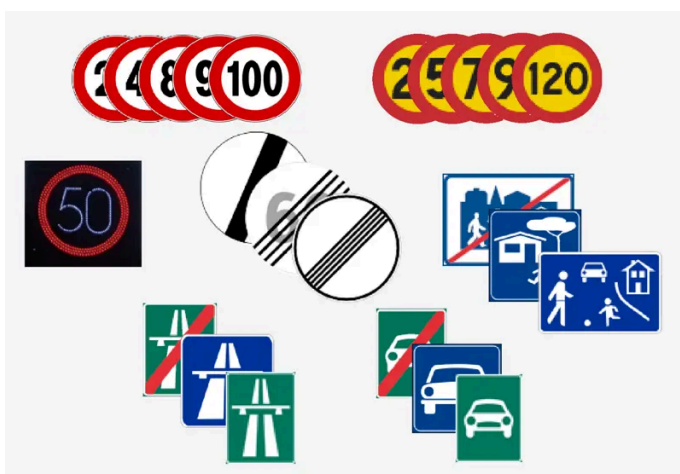

Examples of readable signs^[2].

RSI can provide information about such things as current speed, when a motorway or road is starting/ending, when overtaking is prohibited or when the direction of travel is one-way.

The content of this manual represents the status of the user manual at the time of printing and may not be completely valid in future instances. For more information, refer to the first page for the complete disclaimer note.

If the car passes a speed limit sign, it will be shown in the driver's display and the Head-up display*.

When the speed limit changes, there is an option of an acoustic warning. The function is activated in the centre display.^[3]

- 1 Press 
- 2 Select **Driver support**>**Safety assistance**
- 3 Activate **Sound for new speed limit**

Road Sign Information also includes subfunctions that can warn the driver if a speed limit has been exceeded or in connection with speed cameras.

 **Note**

In certain markets, the road sign information function is only available in combination with map data.

 **Warning**

- The function is supplementary driver support intended to facilitate driving and make it safer – it cannot handle all situations in all traffic, weather and road conditions.
- The driver is advised to read all sections in the Owner's Manual that relate to this function to learn about factors such as its limitations and what the driver should be aware of before using the system.
- Driver support functions are not a substitute for the driver's attention and judgement. The driver is always responsible for ensuring the car is driven in a safe manner, at the appropriate speed, with an appropriate distance to other vehicles, and in accordance with current traffic rules and regulations.

* Option/accessory.

^[1] Internet connection is required for Road Sign Information to work.

^[2] Road signs are market-dependent - illustrations in these instructions only show a few examples.

^[3] The function is only available for cars with Intelligent Speed Assist (ISA).

10.11.2. Limitations of Road Sign Information*

The Road Sign Information function may have limitations in certain situations.

The function is available in certain markets.

Examples of what can reduce the function are as follows:

- Faded signs
- Signs positioned on bends

The content of this manual represents the status of the user manual at the time of printing and may not be completely valid in future instances. For more information, refer to the first page for the complete disclaimer note.

- Rotated or damaged signs
- Signs positioned high above the roadway
- Fully/partially obscured or poorly positioned signs
- Signs completely or partly covered with frost, snow and/or dirt
- Digital road maps with outdated, incorrect or missing speed information ^[1]
- no Internet connection.
- approval for Google Maps ^[2].

Note

In certain markets, the road sign information function is only available in combination with map data.

Note

This function uses the car's camera and radar units, which have certain general limitations.

* Option/accessory.

^[1] Map data with speed information does not exist for all areas.

^[2] Read more at Maps Privacy center.

10.11.3. Warning for speed limitation and speed camera from road sign information*

Road Sign Information includes subfunctions that can warn the driver if a speed limit has been exceeded or in connection with speed cameras ^[1].

The function is available in certain markets.

Warning for speed limit



The speed warning is given by the driver display symbol flashing when the speed limit is exceeded. In addition to a visual warning, an acoustic warning will sound after the visual warning has started. This warning can also be replaced by adaptive pedal response.

Warning for speed camera



Cars equipped with Road sign information and map data ^[1] can give information on upcoming speed cameras in the driver display, provided that the navigation map for the current area contains information on speed cameras.

* Option/accessory.

[1] Information on speed cameras on the navigation map is not available for all markets/areas.

10.11.4. Display mode for road sign information *

The Road Sign Information function shows road signs in different ways depending on the sign and the situation. The following illustrations are examples.

The function is available in certain markets.



Example [1] of detected speed information.

When the function detects a road sign with an imposed speed limit, the driver display shows the sign as a symbol.

If the car is equipped with map data*, speed-related information is also obtained from map data, which means that the driver display can show or change information on the speed limit without having passed a speed-related sign.



An additional sign, such as "no overtaking", may be shown together with the speed limit symbol.



At a road entrance with no-entry signs, or with the prohibition confirmed with sign and map data, the driver is warned by a flashing symbol in the driver display and an acoustic warning. [2]

Speed limit or end of motorway

When the function detects an "indirect speed limit sign" stating the end of the current speed limit – e.g. at the end of a motorway – a symbol appears with the corresponding road sign in the driver's display.

If the car is equipped with map data*, direct speed limit signs are normally displayed – indirect speed limit signs are only displayed if map data has no information on the speed limit for the road section in question.

Example of indirect speed limit sign:

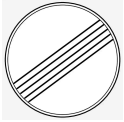

End of all restrictions.



End of motorway.

The driver display's symbol is extinguished shortly after and is re-illuminated when you next drive past a speed-related sign.

Changed speed limit

When passing a direct speed limit sign when a speed limit changes a symbol with the corresponding road sign appears in the driver's display.



Example of direct speed limit sign.

The driver display's symbol is extinguished shortly after and is re-illuminated when you next drive past a speed-related sign.

If the car is equipped with map data*, speed limit signs are shown in the driver display when map data contains information on the speed limit for the road section in question, even if no direct sign has been passed. If map data has no information, the sign is extinguished after a while.

Additional signs

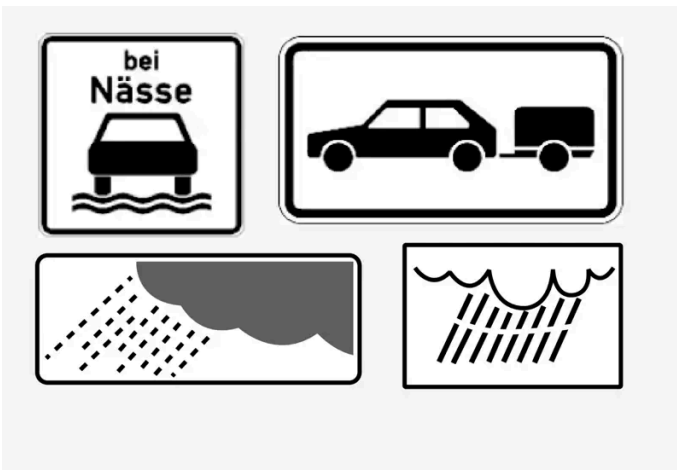

Examples of additional signs.

Sometimes different speed limits are signed for the same road - an additional sign then indicates the circumstances under which the different speeds apply. The road section may be particularly susceptible to accidents in rain and/or fog, for example.

An additional sign relating to rain is displayed only if the windscreen wipers are in use.

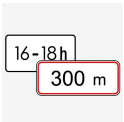

Some speed limits only apply after a certain distance or at a certain time of day. The driver's attention is drawn to this fact by means of a symbol for an additional sign below the speed symbol.

Sign for "School" and "Children at play"



The driver display can show a sign for School or Children at Play, if the data is available.

* Option/accessory.

^[1] Road signs are market-dependent - the illustrations in these instructions only show examples.

^[2] Applies to certain markets.

10.12. Parking functions

10.12.1. Parking assistance

10.12.1.1. Park Assist *

The Park Assist System uses sensors to assist the driver when manoeuvring in tight spaces by indicating the distance to obstacles through acoustic signals combined with a graphic in the centre display.

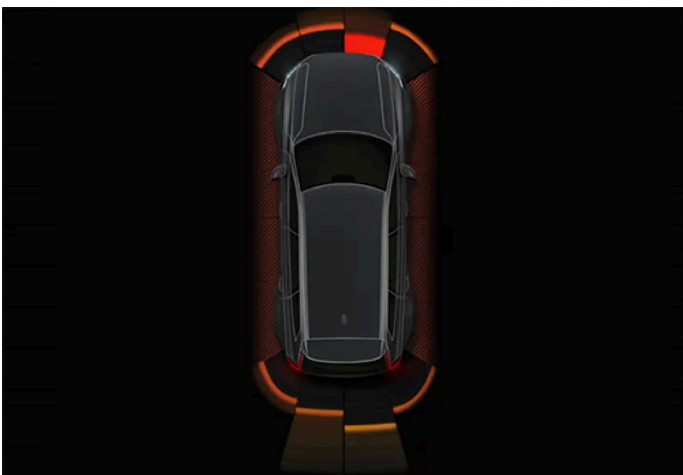

Example of screen view with obstacle zones and sensor sectors.

The centre display shows an overview of the relationship between the car and detected obstacles.

The highlighted sector indicates the location of the obstacle. The closer the car symbol is to a highlighted sector box at the front/back, the shorter the distance between the car and detected obstacle.

The side sectors change colour as the distance between the car and an object is reduced.



The shorter the distance to the obstacle, the faster the signal sounds. Other sound from the audio system is muted automatically.

The acoustic signal for obstacles ahead and to the sides is active when the car is moving but stops after the car has been stationary for approx. 2 seconds. The acoustic signal for obstacles behind is also active when the car is stationary.

At a distance within approx. 30 cm (1 foot) from an obstacle behind or in front of the car, the tone is constant and the active sensor field closest to the car symbol is filled.

At a distance within approx. 25 cm (0.8 foot) from an obstacle to the sides, the tone pulses intensively and the active sector field changes colour from orange to red.

The volume of the Park Assist can be adjusted in the Park Assist settings. To set the volume:

- 1 Activate the Park Assist function by driving close to an object or pressing the camera icon  at the bottom of the centre display.
- 2 Tap settings  in the top right corner of the camera view.^[1]
- 3 Adjust the volume as desired.

 **Note**

Except in the sector nearest to the car symbol, audible warnings are only given for objects directly in the path of the car.

 **Warning**

- The parking sensors are a complement to the driver's attention to the surroundings around the car. Their ability to detect obstacles at certain angles can be affected by the conditions during use.
- Pay particular attention if there are people and animals near the car.
- Bear in mind that the front of the car may swing out towards oncoming traffic during the parking manoeuvre.
- Objects/obstacles may be closer to the car than they appear to be on the screen.

 **Warning**

- The function is supplementary driver support intended to facilitate driving and make it safer – it cannot handle all situations in all traffic, weather and road conditions.
- The driver is advised to read all sections in the Owner's Manual that relate to this function to learn about factors such as its limitations and what the driver should be aware of before using the system.
- Driver support functions are not a substitute for the driver's attention and judgement. The driver is always responsible for ensuring the car is driven in a safe manner, at the appropriate speed, with an appropriate distance to other vehicles, and in accordance with current traffic rules and regulations.

* Option/accessory.

The content of this manual represents the status of the user manual at the time of printing and may not be completely valid in future instances. For more information, refer to the first page for the complete disclaimer note.

[1] If the settings symbol is not shown, gently tap on the centre display to activate the icons.

10.12.1.2. Park Assist System front, rear and along the sides*

Park Assist Pilot has different behaviour depending on which part of the car is approaching an obstacle.

Forwards

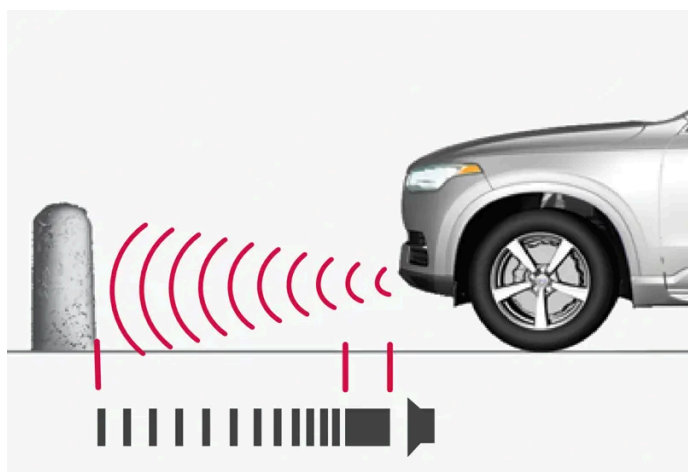

The warning signal has a constant acoustic signal at less than approx. 30 cm (1 foot) from an obstacle.

The Parking Assistance System's front detectors are activated automatically when the engine is started. They are active at speeds below 10 km/h (6 mph).

The measuring range is approx. 80 cm (2.5 feet) in front of the car.

i Note

Parking assistance is deactivated when the parking brake is used or **P** mode is selected in a car with an automatic gearbox.

! Important

When auxiliary lamps are fitted: Remember that these must not obscure the sensors - the auxiliary lamps may then be perceived as an obstacle.

Backwards

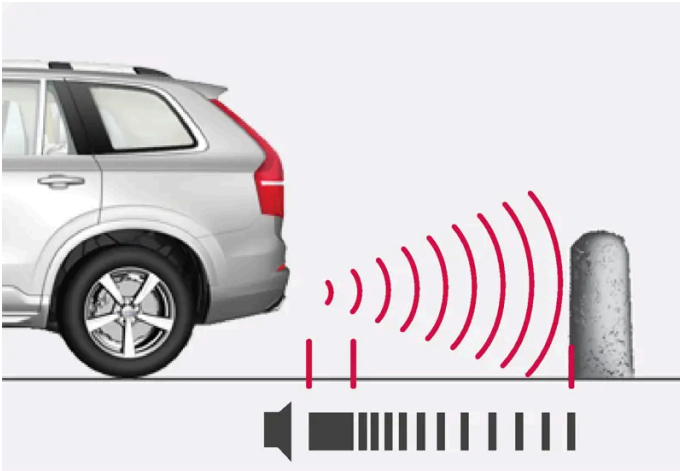

The warning signal has a constant tone at less than approx. 30 cm (1 foot) from an obstacle.

The sensors for reverse are activated if the car rolls backward without a gear engaged or when the gear lever is moved to reverse position.

The measuring range is approx. 1.5 metres (5 feet) behind the car.

When reversing with a trailer connected to the car's electrical system, parking assistance backward is deactivated automatically.

i Note

When reversing with e.g. a trailer or bike carrier on the towbar - without Volvo genuine trailer wiring - parking assistance may need to be switched off manually in order that the sensors do not react to them.

Along the sides

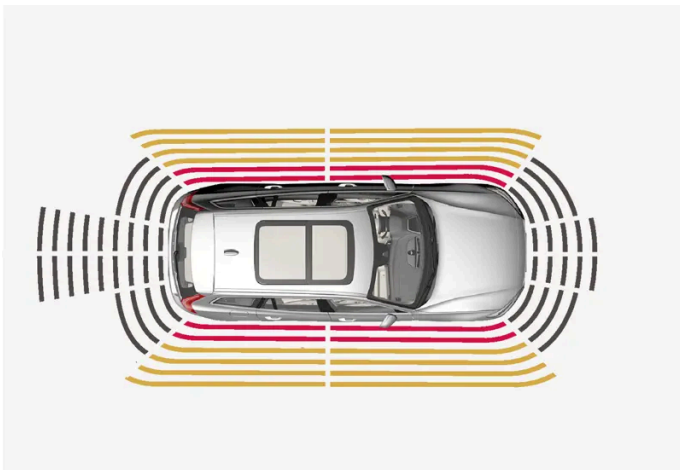

The warning signal pulses intensively at less than approx. 25 cm (0.8 foot) from an obstacle.

Parking assistance side sensors are activated automatically when the engine is started. They are active at speeds below 10 km/h (6 mph).

The measuring range is approx. 25 cm (0.8 foot) from the sides.

However, the detection range of the side sensors increases significantly when the steering angle of the front wheels is increased, and obstacles of up to approx. 90 cm (3 feet) located diagonally behind or in front of the vehicle are detected when the steering wheel is turned.

* Option/accessory.

10.12.1.3. Activating and deactivating Parking Assistance System *

The park assist function can be activated or deactivated.

The front and side parking assistance detectors are activated automatically when the engine is started. The rear detectors are activated if the car rolls backwards or when reverse gear is engaged.



Activate or deactivate the function with this button in parking camera view.

- Illuminated button – the function is activated.
- Extinguished button – the function is deactivated.

In cars equipped with a park assist camera *, Park Assist Pilot can also be activated or deactivated from the relevant camera view.

* Option/accessory.

10.12.1.4. Limitations of park assist system *

The Parking Assistance System cannot detect everything in all situations and may therefore have limited functionality in some cases.

A driver should be aware about the following examples of Park Assist Pilot's limitations:

Warning

- The ability of the park assist cameras to clearly reproduce the surroundings in all zones around the car can be affected by the conditions during use.
- Pay particular attention if there are people and animals near the car.
- Bear in mind that the front of the car may swing out towards oncoming traffic during the parking manoeuvre.
- Objects/obstacles may be closer to the car than they appear to be on the screen.

 **Warning**



Pay additional attention while reversing when this symbol is shown if a trailer, bicycle rack or similar is mounted and electrically connected to the car.

Extinguished symbol indicates that the parking assistance sensors rearward are **switched off** and warn of any obstacles.

 **Important**

Objects e.g. chains, thin glossy poles or low barriers may be in the "signal shadow" and are then temporarily not detected by the sensors - the pulsating tone may then unexpectedly stop instead of changing over to the expected constant tone.

The sensors cannot detect high objects, such as projecting loading docks.

- In such situations, pay extra attention and manoeuvre/reposition the car particularly slowly or stop the current parking manoeuvre - there may be a high risk of damage to vehicles or other objects since information from the sensors is not always reliable in such situations.

 **Important**

In certain conditions the parking assistance system may produce incorrect warning signals that are caused by external sound sources with the same ultrasonic frequencies that the system works with.

Examples of such sources include horns, wet tyres on asphalt, pneumatic brakes, exhaust noises from motorcycles, etc.

 **Note**

Since a towbar is configured with the car's electrical system, towbar protrusion is included when the function measures the distance to an object behind the car.

* Option/accessory.

10.12.1.5. Symbols and messages for park assist system * and park assist camera *

Symbols and messages for Park Assist System and Park Assist Camera can be shown in the driver display and/or the centre display. Here are some examples.

Symbol	Message	Specification
	If the symbol is extinguished.	The rearward parking assistance sensors are deactivated , so there are no acoustic warnings and field marks for obstacles/objects.

Symbol	Message	Specification
	Cleaning needed Park Assist System sensors blocked	One or more of the function's sensors are blocked - check and correct as soon as possible.
	Park Assist System unavailable Service required	The system does not function as it should. A workshop should be contacted ^[1] .

A text message can be cleared by briefly pressing the  button, located in the centre of the steering wheel's right-hand keypad.

If a message remains, contact a workshop - an authorised Volvo workshop is recommended.

 **Warning**



Pay additional attention while reversing when this symbol is shown if a trailer, bicycle rack or similar is mounted and electrically connected to the car.

Extinguished symbol indicates that the parking assistance sensors rearward are **switched off** and warn of any obstacles.

Defective park assist camera

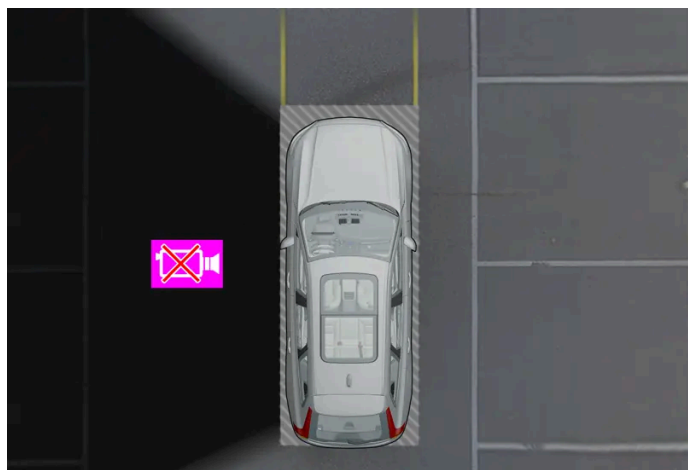

Example for showing when the car's left camera is non-operational.

If a camera sector is black it means that the camera is inoperative.

A black camera sector is also shown in the following instances, but then **without** the symbol for defective camera:

- open door
- open tailgate
- folded-in door mirror.

* Option/accessory.

^[1] An authorised Volvo workshop is recommended.

10.12.2. Park assist camera

10.12.2.1. Park assist camera *

Park assist camera can assist the driver when manoeuvring in tight spaces by indicating obstacles with a camera image and graphic in the centre display.

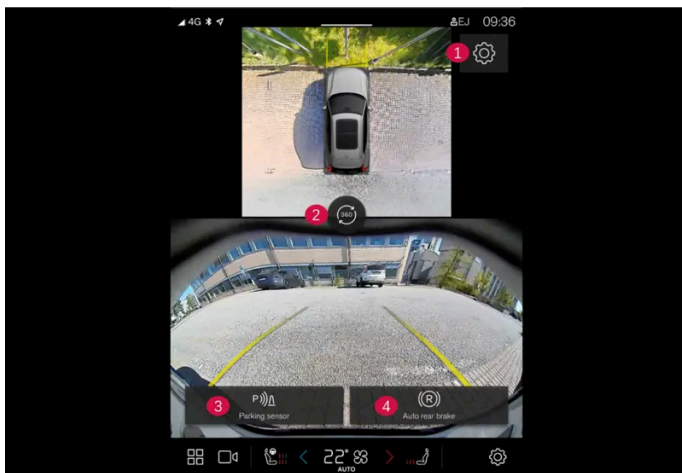

Example of camera view.

- 1 Settings
- 2 Activates all cameras in order to give a 360° view
- 3 Activates/deactivates the parking assistance sensors
- 4 Activates/deactivates auto brake when reversing*

The park assist camera is a support function which is activated automatically when reverse gear is selected or manually in the centre display.

Warning

- The ability of the park assist cameras to clearly reproduce the surroundings in all zones around the car can be affected by the conditions during use.
- Pay particular attention if there are people and animals near the car.
- Bear in mind that the front of the car may swing out towards oncoming traffic during the parking manoeuvre.
- Objects/obstacles may be closer to the car than they appear to be on the screen.

 **Warning**

- The function is supplementary driver support intended to facilitate driving and make it safer – it cannot handle all situations in all traffic, weather and road conditions.
- The driver is advised to read all sections in the Owner's Manual that relate to this function to learn about factors such as its limitations and what the driver should be aware of before using the system.
- Driver support functions are not a substitute for the driver's attention and judgement. The driver is always responsible for ensuring the car is driven in a safe manner, at the appropriate speed, with an appropriate distance to other vehicles, and in accordance with current traffic rules and regulations.

* Option/accessory.

10.12.2.2. Activating park assist camera *

The park assist camera is activated automatically when reverse gear is engaged or manually with one of the centre display's function buttons.

Camera view when reversing

When reverse gear is selected, the screen shows picture-in-picture mode.

Camera view for manual camera activation



Activate the parking camera with this button in the centre display – the screen then shows the 360° view.

- Illuminated button – the function is activated.
- Extinguished button – the function is deactivated.

Automatic deactivation of camera

The front view extinguishes at 25 km/h (16 mph) to avoid distracting the driver – it reactivates automatically if the speed drops to 22 km/h (14 mph) within 1 minute, on the condition that the speed has not exceeded 50 km/h (31 mph).

Other camera views are extinguished at 15 km/h (9 mph) and not reactivated.

* Option/accessory.

10.12.2.3. Symbols and messages for park assist system* and park assist camera*

Symbols and messages for Park Assist System and Park Assist Camera can be shown in the driver display and/or the centre display. Here are some examples.

Symbol	Message	Specification
	If the symbol is extinguished.	The rearward parking assistance sensors are deactivated , so there are no acoustic warnings and field marks for obstacles/objects.
	Cleaning needed Park Assist System sensors blocked	One or more of the function's sensors are blocked - check and correct as soon as possible.
	Park Assist System unavailable Service required	The system does not function as it should. A workshop should be contacted ^[1] .

A text message can be cleared by briefly pressing the  button, located in the centre of the steering wheel's right-hand keypad.

If a message remains, contact a workshop - an authorised Volvo workshop is recommended.

Warning



Pay additional attention while reversing when this symbol is shown if a trailer, bicycle rack or similar is mounted and electrically connected to the car.

Extinguished symbol indicates that the parking assistance sensors rearward are **switched off** and warn of any obstacles.

Defective park assist camera

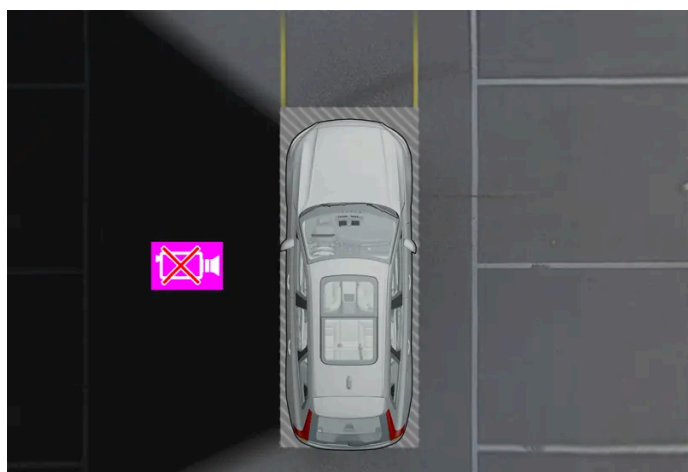

Example for showing when the car's left camera is non-operational.

If a camera sector is black it means that the camera is inoperative.

A black camera sector is also shown in the following instances, but then **without** the symbol for defective camera:

- open door
- open tailgate
- folded-in door mirror.

The content of this manual represents the status of the user manual at the time of printing and may not be completely valid in future instances. For more information, refer to the first page for the complete disclaimer note.

* Option/accessory.

[1] An authorised Volvo workshop is recommended.

10.12.2.4. Park assist lines for park assist camera *

The Park assist cameras indicate the position of the car in relation to its surroundings by displaying lines on the screen.

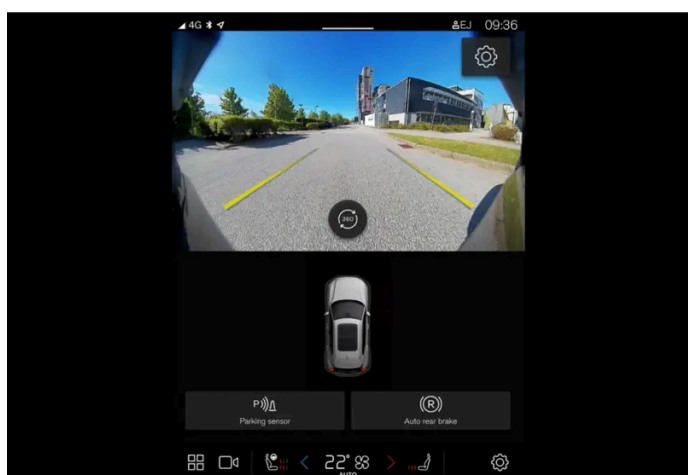

Example of park assist lines

Park assist lines show the intended route for the car's external dimensions with the current steering wheel angle - this can facilitate parallel parking, reversing into tight spaces and when connecting a trailer.

The lines on the screen are projected as if they were at ground level behind the car and respond directly to steering wheel movements, showing the driver the path the car will take - also when the car is turning.

These park assist lines include the car's most protruding parts, e.g. towbar, door mirrors and corners.

Note

- When reversing with a trailer which is not connected electrically to the car, the park assist lines on the display show the route the **car** will take – not the trailer.
- The screen shows no park assist lines when a trailer is connected electrically to the car's electrical system.

! Important

- Remember, that with the rear camera view selected, the monitor only displays the area behind the car. Be aware of the sides and front of the car when manoeuvring in reverse.
- The same applies vice versa - note what happens to the rear parts of the car when the front camera view is selected.
- Note that the park assist lines show the **shortest** route. Therefore, pay extra attention to the car's sides so that they do not go against/over something when the steering wheel is turned when driving forward or that the front sweeps against/over something when the steering wheel is turned when reversing.

Park assist lines in 360° view*

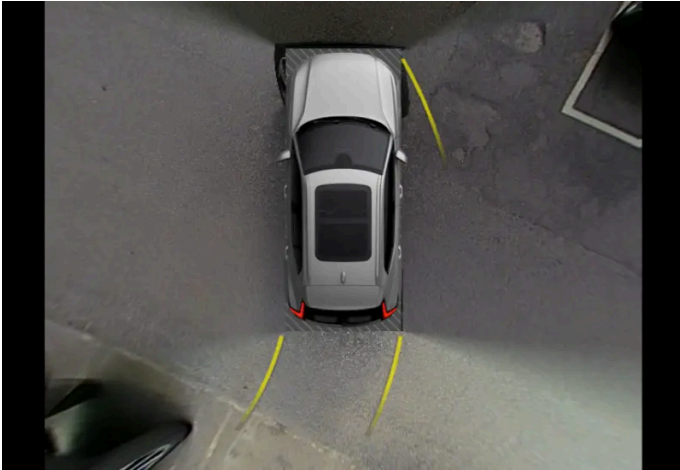

360° view with park assist lines

With the 360° view and 360° view in picture-in-picture mode, park assist lines appear – depending on the direction of travel – at the back, front and side of the car:

- When driving forwards: Front lines
- When reversing: Side lines and reversing lines

With front or rear camera selected or picture-in-picture mode, the park assist lines appear regardless of the car's direction of travel.

With one side camera selected the park assist lines only appear when reversing.

Towbar assist line

A park assist line for the towbar's intended trajectory can be shown and provide assistance when connecting a trailer. The function is activated in the settings for the parking camera.

Park assist lines for the towbar and the whole of the car cannot be shown at the same time.

* Option/accessory.

10.12.2.5. Park assist camera locations and surveillance areas*

The Park Assist cameras can show rear, front, left or right camera view individually. You can also have a composite 360° view that shows all sides.

360° view*

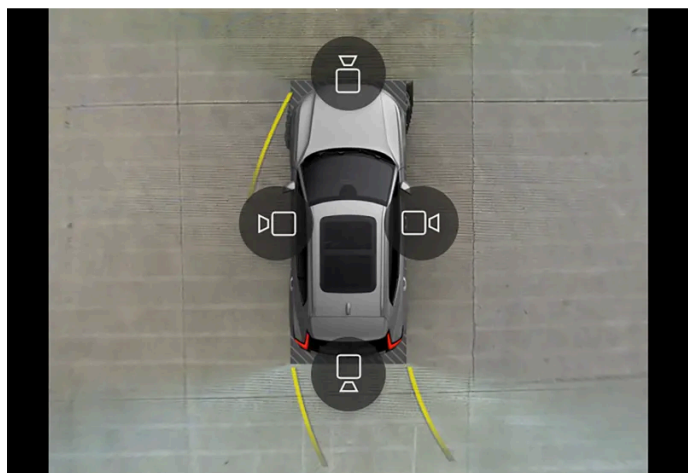

Example of how all camera symbols are shown in the 360° view.

The 360° view function activates all parking cameras, whereupon the four sides of the car are shown simultaneously in the centre display, which helps the driver to observe what is around the car when manoeuvring at low speed. From the 360° view, each camera view can be activated separately. Tap on the screen to show the camera symbols and select the desired view. The camera symbols will disappear after a short time without the screen being touched.

The cameras can be activated automatically or manually.

Backwards



The backwards-facing camera is fitted above the registration plate.

The backward-facing camera shows a wide area behind the car. For certain models, part of the bumper can be seen as well as the towbar in some cases.

Objects shown in the centre display may appear slightly tilted – this is normal.

Forwards



The forwards parking camera is located in the grille.

The front camera can be helpful on an exit road with limited visibility to the sides, e.g. when driving out of a garage. It is active at speeds up to 25 km/h (16 mph) - following which, the front camera is switched off.

If the car does not reach 50 km/h (30 mph) and the speed falls below 22 km/h (14 mph) within 1 minute after the forward-facing camera has been extinguished, the camera is reactivated.

The sides



The side cameras are positioned in each door mirror.

The side cameras can show what is along each side of the car.

* Option/accessory.

10.12.2.6. Sensor fields for park assist system *

If the car is equipped with the Park Assist System then the distance is shown in the Park Assist camera's 360° view with coloured fields for each sensor that registers an obstacle.

The content of this manual represents the status of the user manual at the time of printing and may not be completely valid in future instances. For more information, refer to the first page for the complete disclaimer note.

Sensor fields backwards and forwards

The fields for the front and reversing sensors change colour as the distance to the obstacle decreases – from yellow through orange to red.

Field colour reverse	Distance in metres (feet)
Yellow	0.6-1.5 (2.0-4.9)
Orange	0.3-0.6 (1.0-2.0)
Red	0-0.3 (0-1.0)

Field colour forwards	Distance in metres (feet)
Yellow	0.6-0.8 (2.0-2.6)
Orange	0.3-0.6 (1.0-2.0)
Red	0-0.3 (0-1.0)

For red sensor fields, the pulsating acoustic signal changes over to a constant tone.

Warning

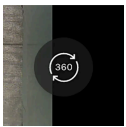

The sensor fields on the 360° symbol only show the direction to an obstacle. They do not show the distance to the obstacle.

Sensor field to the sides

Warning signals depend on the intended route of the car. When the steering wheel is turned, therefore, there may also be a warning for obstacles diagonally in front of or diagonally behind the car, not just straight ahead or directly behind.

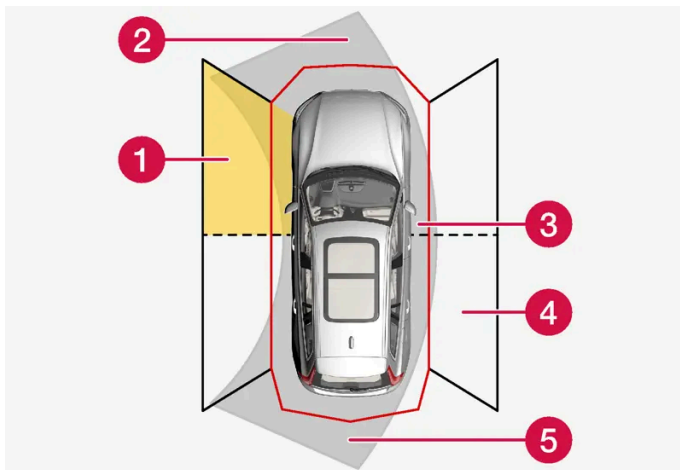

Parking sensor sectors where obstacles can be detected.

- 1 Left-hand side front sensor field
- 2 Obstacle sector in the car's intended route forwards – depending on steering wheel angle
- 3 Sector with red field colour and intensively pulsing tone
- 4 Right-hand side rear sensor field
- 5 Obstacle sector in the car's intended route in reverse – depending on steering wheel angle.

The content of this manual represents the status of the user manual at the time of printing and may not be completely valid in future instances. For more information, refer to the first page for the complete disclaimer note.

The colour of the side fields changes with reduced distance to the obstacle – from amber to red.

Colour of side fields	Distance in metres (feet)
Yellow	0,25–0,9 (0,8–3,0)
Red	0–0,25 (0–0,8)

In the case of red sensor fields, the acoustic signal changes from pulsing to intensively pulsing.

* Option/accessory.

10.13. Camera and radar unit

10.13.1. Recommended maintenance for camera, sensor and radar units

In order that the cameras, parking sensors and radar units shall work correctly, they must be kept clean of dirt, ice and snow, and be cleaned regularly with water and car shampoo.

- Do not affix any objects, tape or decals in the areas described below.
- Clean camera lenses regularly with lukewarm water and car shampoo - be careful not to scratch the lenses.
- Avoid fitting auxiliary lamps or similar in the grille as this may affect the performance of the front radar unit.
- Use only Volvo genuine emblems in the grille in front of the front radar unit so as not to affect the function of the front radar unit.

Radar unit locations



Location of front radar unit



Location of rear radar units

Location of the parking sensors

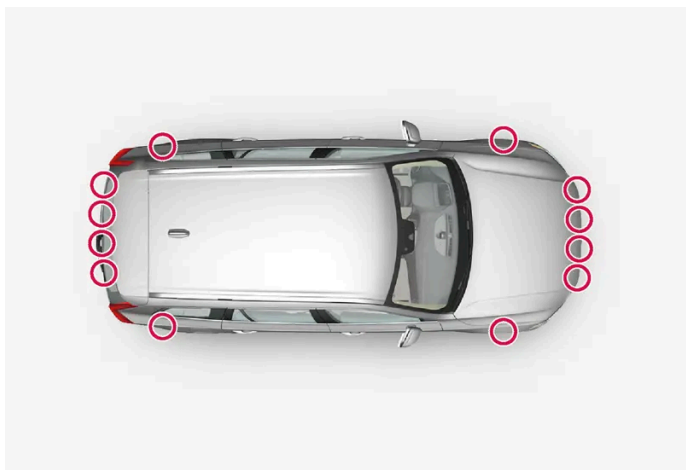

Location of the parking sensors around the car

i Note

Dirt, ice and snow covering the sensors may cause incorrect warning signals, reduced or no function.

Camera location



Location of front camera unit

Important

Maintenance of driver support components must only be performed at a workshop – an authorised Volvo workshop is recommended.

10.13.2. Symbols and messages for camera and radar units

Here are examples of some of the display messages and symbols regarding the camera and radar that can be shown in the driver display.

Detector blocked



If the driver display shows this symbol and a message, this means that the camera and radar units cannot detect other vehicles, cyclists, pedestrians and large animals in front of the car, and that the car's camera-based and radar-based functions may be disrupted.

The following table presents examples of possible causes for a message being shown, along with the appropriate action:

Cause	Action
The surface area in front of the radar unit is dirty or covered with ice or snow.	Clean the surface area in front of the radar unit from dirt, ice and snow.
The windscreen surface in front of the camera unit is dirty or covered with ice or snow.	Clean dirt, ice and snow from the windscreen surface in front of the camera unit.
Thick fog and heavy rain or snow block the radar signals or the camera view.	No action. Sometimes the unit does not work during heavy rain or snowfall.
Water or snow from the road surface swirls up and blocks the radar signals or camera view.	No action. Sometimes the unit does not work on a very wet or snow-covered road surface.
Strong oncoming light	No action. The camera unit is reset automatically in more favourable light conditions.

10.13.3. Limitations for camera and radar units

The camera and radar have certain limitations – which in turn also limits those functions that use the units. A driver should be aware about the following examples of limitations.

Common limitations for camera and radar

The camera and radar are aids for intelligent driving that cannot be called upon to achieve intelligent driving, and the necessary safety management must be implemented in order to avoid road safety risks or accidents caused by the driver's incorrect use of the camera and radar.

Blocked unit

Do not position, stick or install anything in front of or around the camera and radar units – this may disrupt camera and radar-based functions. This may result functions being reduced, being switched off completely or giving incorrect function responses.

Dashcams approved by Volvo may be installed outside the field of view of the front camera and must have a distance of at least 20 mm to the WEM^[1] cover. Dashcams may only be fitted to cars with a radar system installed in the front grill. It is important to note that the dashcam must comply with the ISO 11452 standards for electromagnetic compatibility (EMC) to ensure it functions properly and to prevent potential interference with the car's electronics. Failure to follow these requirements may cause the dashcam to malfunction and damage the car.

Damaged windscreen

The following rules are also applicable when a camera is fitted in the windscreen:

- If a scratch, crack or stone chip appears in front of the unit and covers an area of approx. 0.5 × 3.0 mm (0.02 × 0.12 inches) or more, a workshop^[2] must be contacted so that the windscreen can be replaced.
- Volvo recommends **not** repairing cracks, scratches or stone chips in the area in front of the unit – the entire windscreen should be replaced instead.
- Before replacing a windscreen, contact a workshop^[2] to verify that the correct windscreen has been ordered and will be fitted.
- The same type of windscreen wipers or windscreen wipers approved by Volvo must be fitted when the windscreen is replaced.
- When replacing the windscreen, the camera unit must be recalibrated by a workshop^[2] to ensure the functionality of all the camera-based systems in the car.

Note

If not rectified, it can lead to reduced performance for the driver support systems that use the camera and/or radar units. This may result functions being reduced, being switched off completely or giving incorrect function responses.

Further limitations for radar

Vehicle speed

The radar unit's ability to detect a vehicle ahead is greatly reduced if the speed of the vehicle ahead is very different to the speed of your own car.

Limited field of vision

The radar unit has a limited field of vision. In some situations another vehicle is not detected, or the detection is made later than expected.

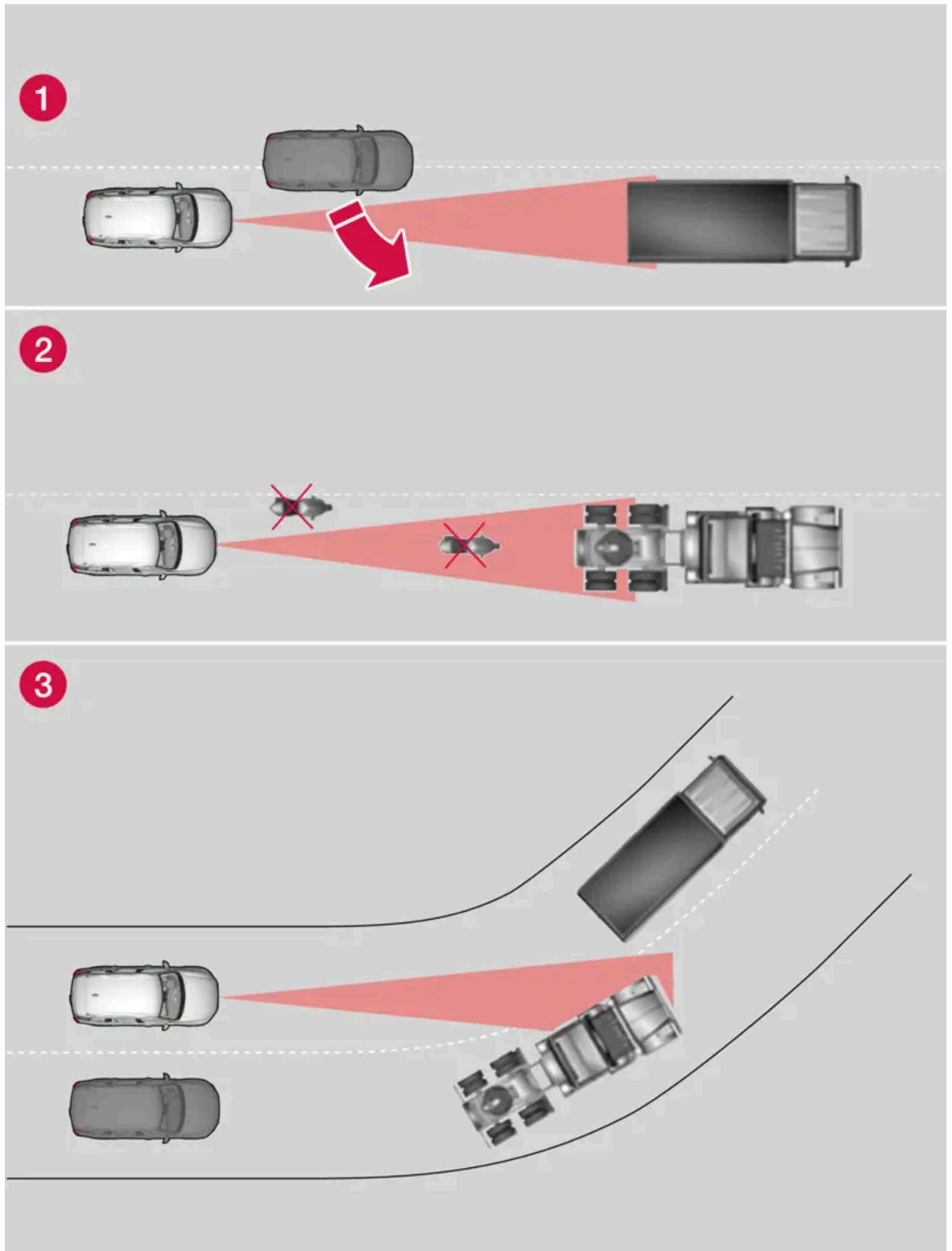

The radar unit's field of vision

- 1 Sometimes the radar unit is late at detecting vehicles at close distances - e.g. a vehicle that drives in between your car and the vehicle ahead.
- 2 Small vehicles, such as motorcycles, or vehicles not driving in the centre of the lane can remain undetected.
- 3 In bends, the radar unit may detect a different vehicle than intended or lose a detected vehicle from view.

Reduced function

In the event of heavy rain or slush or ice on the emblem, radar unit functions may be reduced, completely deactivated, or give incorrect function response.

Further limitations for camera

Impaired vision

The cameras have limitations similar to the human eye, i.e. may "see" worse in for example intense snowfall or rain, dense fog, heavy dust storms and snow flurries. Under such conditions, the functions of camera-dependent systems could be significantly reduced or temporarily disengaged.

Strong oncoming light, reflections in the carriageway, snow or ice on the road surface, dirty road surfaces or unclear lane markings can also significantly reduce camera function when it is used to scan the carriageway to detect pedestrians, cyclists, large animals and other vehicles.

Bicycle racks or other accessories mounted at the rear of the car may obscure the camera's view.

Further limitations for Park assist camera *

Blind sectors

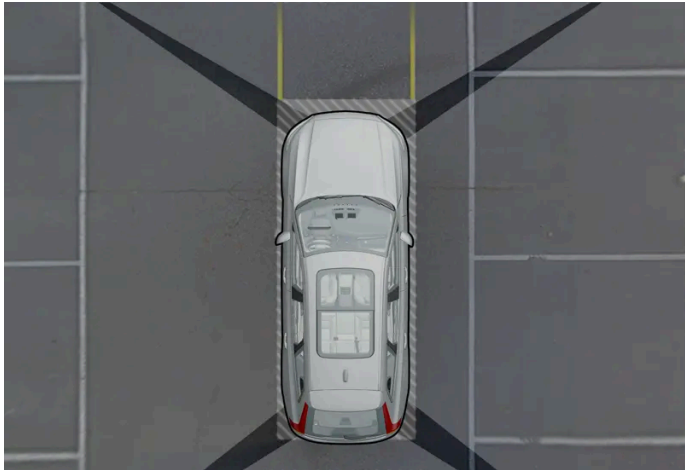

There are "blind" sectors between the cameras' fields of vision.

In the park assist camera's 360° view* obstacles/objects may "vanish" in the gaps between the individual cameras.

Warning

Pay attention to the possibility that, even if it only looks like a relatively small part of the image is obscured, a relatively large sector could be hidden from view. An obstacle could thereby go undetected until the car is very close to it.

Light conditions

The camera image is adjusted automatically according to prevailing light conditions. Because of this, the image may vary slightly in brightness and quality. Poor light conditions can result in reduced image quality.

[1] Window Electric Module.

[2] An authorised Volvo workshop is recommended.

* Option/accessory.

10.13.4. Camera unit

The camera unit is used by several driver support systems and has the task of for example detecting lane lines or traffic signs.



Location of the camera unit

The camera unit is used by the following functions:

- Pilot Assist*
- Lane assistance*
- Assistance at risk of collision
- Driver Alert*
- Road Sign Information*
- Active main beam*
- Park Assist*
- Ready to drive notification

Important

Do not attempt to access the camera using sharp or foreign objects through the air vents as this may damage the equipment.

* Option/accessory.

10.13.5. Radar units

The radar units are used by several driver support systems and monitor various areas around the car.



Location of front radar unit



Location of rear radar units

Modifying radar units may make them illegal to use.







Do not install auxiliary lamps or similar in front of the grille as this can affect the function of the radar unit.







Use only Volvo genuine emblems in the grille in front of the front radar unit so as not to affect the function of the front radar unit.







10.13.6. Type approval for radar units

The content of this manual represents the status of the user manual at the time of printing and may not be completely valid in future instances. For more information, refer to the first page for the complete disclaimer note.

Here you can find type approval for the car's radar units for Pilot Assist* and BLIS* ^[1].

Market	PA	BLIS	Symbol	Type approval
Botswana	✓			BOCRA/TA2019/4981
		✓		BOCRA/TA/2017/3372
Brazil	✓			Este equipamento não tem direito à proteção contra interferência prejudicial e não pode causar interferência em sistemas devidamente autorizados. 06354-19-12386
		✓		Este equipamento não tem direito à proteção contra interferência prejudicial e não pode causar interferência em sistemas devidamente autorizados. 03563-17-05364
Europe	✓			Hereby, Veoneer US, Inc. declares that the radio equipment type 77V12FLR is in compliance with Directive 2014/53/EU. Operational frequency band: 76-77 GHz Maximum Output Power: <55dBm EIRP The full text of the EU declaration of conformity is available at the following internet address: https://www.veoneer.com/en/regulatory Manufacturer: Veoneer US, Inc. 26360 American Drive Southfield, MI 48034 USA Phone: +1-248-223-0600
		✓		Hereby, Hella KgaA Hueck & Co. Declares that the radio equipment type RS4 is in compliance with Directive 2014/53/EU. The full text of the EU declaration of conformity is available at the following internet address: www.hella.com/vcc . Technical information: Frequency range: 24.05 ... 24.25 GHz Transmission power: 20 dBm (maximum) EIRP Manufacturer and Address: Manufacturer: Hella KGaA Hueck & Co. Address: Rixbecker Straße 75, 59552 Lippstadt, Germany
The United Arab Emirates (UAE)	✓			REGISTERED No: ER72325/19 DEALER No: 0020858/10
		✓		Registered No: ER53878/17 Dealer No: DA44932/15
Ghana	✓			NCA Approved: ZRO-1H-7E3-145
		✓		NCA Approved: 1R3-1M-7E1-0B7
Indonesia		✓	 Dilarang melakukan perubahan spesifikasi yang dapat menimbulkan gangguan fisik dan/atau elektromagnetik terhadap lingkungan sekitarnya	Certificate number: 81226/SDPPI/2022 13809
	✓			Certificate number: 79866/SDPPI/2022 13809
Israel	✓			See illustration 1 below the table.
		✓		See illustration 2 below the table.
Japan	✓			This device is granted pursuant to the Japanese Radio Law under the grant ID n° : R 215-JRA003 This device should not be modified (otherwise the granted designation number will become invalid). ???: R 215-JRA003 ??:
		✓		This device is granted pursuant to the Japanese Radio Law under the grant ID n° : R 204-750001 This device should not be modified (otherwise the granted designation number will become invalid). ???: R 204-750001 ??:

Market	PA	BLIS	Symbol	Type approval
China		✓		RS4 24.05-24.25GHz: 20mW
Malaysia	✓			HIDF15000171 Model: 77V12FLR Brand: Veoneer US, Inc.
		✓		CID F 15000578
Morocco	✓			AGREE PAR L'ANRT MAROC Numéro d'agrément: MR_20098_ANRT_2019 Date d'agrément: 2019_06_14
Mexico	✓			IFT: RLVVE7719-1064 La operación de este equipo está sujeta a las siguientes dos condiciones: (1) es posible que este equipo o dispositivo no cause interferencia perjudicial y (2) este equipo o dispositivo debe aceptar cualquier interferencia, incluyendo la que pueda causar su operación no deseada.
		✓		Radar de corto alcance RS4 Hella KGaA Hueck & Co IFETEL: RLVHERS17-0286 La operación de este equipo esta sujeta a las siguientes dos condiciones: (1) es posible que este equipo o dispositivo no cause interferencia perjudicial y (2) este equipo o dispositivo debe aceptar cualquier interferencia, incluyendo la que pueda causar su operación no deseada.
Moldova	✓	✓		
Nigeria	✓	✓		Connection and use of this communications equipment is permitted by the Nigerian Communications Commission.
Oman	✓			Registered No: R/7713/19 Dealer No: D172338
		✓		Registered No: R/3957/17 Dealer No: D080134
Paraguay	✓			NR: 2019-07-1-0397
Serbia	✓			IO11 19
		✓		IO11 17
Singapore	✓			DA 106706
		✓		DA 103238
UK	✓			Hereby, Veoneer US, Inc. declares that the radio equipment type 77V12FLR is in compliance with radio regulation 2017. Operational frequency band: 76 – 77 GHz/ Maximum output power: < 55 dBm e.i.r.p www.veoneer.com/en/regulatory [https://www.veoneer.com/en/regulatory/]

Market	PA	BLIS	Symbol	Type approval
		✓		Hereby, Hella GmbH & Co. KGaA declares that the radio equipment type RS4 is in compliance with Radio Equipment Regulations of the United Kingdom. The full text of the United Kingdom declaration of conformity is available at the following internet address: www.hella.com/vcc [https://www.hella.com/vcc] Technical information: Frequency band: 24.05 ... 24.25 GHz Transmission power: 20 dBm (max.) EIRP Manufacturer and Address: Hella GmbH & Co. KGaA Rixbecker Straße 75, 59552 Lippstadt, Germany
South Africa	✓			TA-2019/1378APPROVED
		✓		TA-2016/3407APPROVED
South Korea	✓			R-C-1VN-77V12FLR
		✓		R-CMM-HLA-RS4 [Placeholder text]
Taiwan	✓			CCAI19LP2310T1 [Placeholder text]
		✓		CCAB17LP0470T5 [Placeholder text]
Thailand	✓	✓		1) [Placeholder text] 2) [Placeholder text]
Ukraine	✓			UA RF: 1VEON2FLR справжнім VEONEER US, INC. заявляє, що тип радіообладнання 77V12FLR відповідає Технічному регламенту радіообладнання; повний текст декларації про відповідність доступний на веб-сайті за такою адресою: https://www.veoneer.com/en/regulatory
		✓		Цим HELLA GmbH & Co. KGaA заявляє, що радіотехнічне обладнання типу RS4 відповідає Технічному регламенту радіотехнічного обладнання та Директиві 2014/53/ЄС. Повний текст декларації про відповідність доступний за адресою: www.hella.com/vcc Частотний діапазон: 24,05 – 24,25 ГГц Потужність передачі: 20 дБм (макс.) EIRP
Vietnam	✓			77V12FLR
		✓		C0173191017AF04A2
Zambia	✓			ZMB/ZICTA/TA/2019/6/61
		✓		ZMB/ZICTA/TA/2017/6/7

Israel

Illustration 1 - Pilot Assist

51-81359



**מספר אישור התאמה מטעם משרד התקשורת:
חל איסור לבצע פעולות במכשיר שיש בהן כדי לשנות את
תכונותיו האלחוטיות של המכשיר, ובכלל זה שינויי תוכנה,
החלפת אנטנה מקורית או הוספת אפשרות לחיבור לאנטנה
חיצונית, בלא קבלת אישור משרד התקשורת, בשל החשש
להפרעות אלחוטיות**

Illustration 2 - BLIS

55-09136

**מספר אישור התאמה מטעם משרד התקשורת:
חל איסור לבצע פעולות במכשיר שיש בהן כדי לשנות את תכונותיו האלחוטיות של המכשיר, ובכלל
זה שינויי תוכנה, החלפת אנטנה מקורית או הוספת אפשרות לחיבור לאנטנה חיצונית, בלא קבלת
אישור משרד התקשורת, בשל החשש להפרעות אלחוטיות**

Type approval for radio equipment

Market	Symbol	Type approval
Europe		Hereby, Volvo cars, declares that all radio equipment's are in compliance with the essential requirements and other relevant provisions of Directive 2014/53/EU.
Japan		R 204-750001 This device is granted pursuant to the Japanese Radio Law and the Japanese Telecommunications Business Law. This device should not be modified (otherwise the granted designation number will become invalid).

For detailed information on type approval, go to [volvocars.com/intl/support](https://www.volvocars.com/intl/support) [<https://www.volvocars.com/intl/support>].

* Option/accessory.

[1] Blind Spot Information

10.14. Driving support systems

The car is equipped with different driver support systems which can assist the driver in different situations, either actively or passively.

For example, the systems can help the driver to:

- use steering assistance to reduce the risk of accidentally leaving the lane or colliding with another vehicle
- maintain a set speed
- maintain a certain time interval to the vehicle ahead
- prevent a collision by giving a warning to the driver and braking the car
- parking.

Some of the systems are fitted as standard while others are options – which alternative applies is market dependent.

Some of the systems have improved functionality when Google Maps is used.

Warning

The driver support systems are only supplementary aids - they cannot handle all situations in all conditions.

The driver always bears responsibility that the vehicle is driven safely and that applicable road traffic rules and regulations are followed.

10.15. Warnings from various driver support systems

If you notice that the car acts in an unexpected way then this may be due to one of the car's safety-related functions being activated.

What is happening in your car?

There are several functions in your car that can contribute actively to increasing safety in traffic, both for yourself and other road users. You have the option of viewing a list of some of the functions and what they may do – the aim of this is to ensure you are not surprised by the activation of any of the functions. If a function should be activated, you can also be informed of this via a text message in the driver display.

Note

Read the individual sections on each system in order to fully understand the functions and learn about important warnings.

Warning with the symbol, acoustic signals, visual signals or vibration

The driver support functions in your car can alert you in different ways. For example, with vibration in the steering wheel, brake pulse, with visual or acoustic signals or via symbols in the driver display.

Alerts can also be shown in the head-up display*.

Assistance at risk of collision

Assistance at risk of collision^[1] can assist the driver to avoid or mitigate a collision with a warning, automatic braking and steering assistance.

Your experience of the function may therefore differ depending on which subfunction is activated.

Assistance at risk of collision can perform the following steps if necessary:

- Collision warning
- Assisted braking
- Automatic braking
- Steering assistance

Lane Keeping Aid (LKA^[2])



Lane assistance can help you to reduce the risk of the car unintentionally leaving its own lane.

- Steering assistance: If the function detects that the car is approaching a lane line, you will feel a gentle steering action applied to the steering wheel. You must have both hands on the steering wheel for the function to work.
- Warning: If the function detects that the car is approaching a lane line, you will be alerted by vibration in the steering wheel.
- Both: You are alerted with vibration and a gentle steering action applied to the steering wheel.

Rear Collision Warning (RCW)*



Rear Collision Warning is a system that can help you avoid being hit by a vehicle approaching from behind. If the system detects a risk of rear-end collision, it can give a warning and take the following action, depending on the conditions.

- Intensive flashing with the direction indicators.
- At low speeds the function can tension the seatbelts by activating the seatbelt tensioners, and also activate the Whiplash Protection System.
- If the car is stationary, the foot brake can be activated.

Blind Spot Information (BLIS)

BLIS is designed to give a warning of rapidly approaching vehicles as well as vehicles diagonally behind and to the side of your vehicle so as to give you assistance in heavy traffic on roads with several lanes in the same direction.



- Alerts with an indicator lamp in the side mirror, with fixed glow and flashing light.

Driver Alert



The function is intended to attract the driver's attention if he/she starts to drive less consistently, e.g. if he/she becomes distracted or starts to fall asleep.

- Acoustic signal combined with a symbol in the driver display and a message.

Distance Warning* [\[3\]](#)

Distance Warning can alert you if the time interval to the vehicle ahead suddenly becomes too short.

- Warning symbol in the windscreen Head-up display. To have the function, the car must be equipped with a Head-up display*.

Warning and auto-brake when reversing



There are two functions that can assist the driver to prevent a collision while reversing.

- Cross Traffic Alert (CTA)* is designed to alert for crossing traffic when the car is being reversed.
- Rear Auto Brake (RAB) is intended to help the driver detect stationary obstacles that may be directly behind the car when it is being reversed.

If obstacles are detected:

1. A warning signal and the graphic for parking assistance illuminate to indicate the position of the obstacle.
2. If the driver does not pay attention to the warning and a collision is unavoidable, the car is auto-braked and an explanatory text message is shown for why the car was braked.

Electronic stability control (ESC)



Electronic Stability Control (ESC^[4]) helps the driver to avoid skidding and improves the car's traction. When the system intervenes, the symbol appears in the driver display with a flashing light. If a fault has occurred and the system is unavailable, the symbol appears permanently lit together with a text message.

 **Warning**

The functions described are supplementary aids - they cannot handle all situations in all conditions.

The driver always bears responsibility that the vehicle is driven safely and that applicable road traffic rules and regulations are followed.

Intelligent Speed Assist (ISA)



Intelligent Speed Assist helps the driver stay below the speed limit by means of different warnings and the option to limit the car's propulsion.

When the car's speed exceeds the speed limit displayed in the road sign information, Intelligent Speed Assist warns the driver by

- the icon displaying the speed limit starting to flash
- a warning sound.

The warning sound can be switched off with the left steering wheel button ◀ or replaced with adaptive pedal response.

* Option/accessory.

^[1] Collision Avoidance

^[2] Lane Keeping Aid

^[3] Distance Alert

^[4] Electronic Stability Control

10.16. Speed-dependent steering force

Speed related power steering causes the steering wheel force to increase with the speed of the car so as to be able to give the driver enhanced sensitivity. On motorways the steering is firmer. When parking and at low speed steering is light and requires less effort.

Reduced power

In rare situations, the power steering may need to work at reduced power, and turning the steering wheel may then seem slightly heavier. This may occur when the power steering becomes too hot and it then needs temporary cooling. It may also occur if the power supply is disrupted.



In the event of reduced power, the message **Power steering assistance Temporarily reduced** is shown, as well as this symbol in the driver display.

While the power steering is working at reduced power, the driver support functions and steering assistance systems are not available.

 **Warning**

If the temperature increases too much, the servo may be forced to switch off completely. In such a situation, the driver display shows the **Stop safely Power steering failure** message, combined with a symbol.

Change the steering force level

- 1 Press  in the centre display.
- 2 Then tap on **Driving**.
- 3 Activating or deactivating **Steering feel firm**.

Steering wheel resistance selection can only be accessed if the car is stationary or is moving at low speed and in a straight line.

10.17. Ready to drive notification

The car's system can help the driver to notice that the vehicle ahead is continuing to drive.

In order not to be stationary for too long and hold up the traffic, the **Ready to drive notification** function gives an acoustic signal and shows a symbol and message in the driver's display. The notification may not be given if the system detects pedestrians or cyclists in the vicinity of the car.

 **Warning**

However, the system cannot detect pedestrians and cyclists in all situations. The driver always bears responsibility for ensuring that the car is driven safely.

To activate or deactivate the function:

- 1 Press  in the centre display.

2 Tap on **Driving** and change the desired setting.

 **Warning**

- The function is supplementary driver support intended to facilitate driving and make it safer – it cannot handle all situations in all traffic, weather and road conditions.
- The driver is advised to read all sections in the Owner's Manual that relate to this function to learn about factors such as its limitations and what the driver should be aware of before using the system.
- Driver support functions are not a substitute for the driver's attention and judgement. The driver is always responsible for ensuring the car is driven in a safe manner, at the appropriate speed, with an appropriate distance to other vehicles, and in accordance with current traffic rules and regulations.

 **Note**

This function uses the car's radar and/or camera units, which have some general limitations.

10.18. Auto braking after a collision

In the event of a collision in which the activation level is reached for the pyrotechnic seatbelt tensioners or airbags, or if a collision with a large animal is detected, the car's brakes are automatically applied. This function is to prevent or reduce the effects of any subsequent collision.

After a serious collision there is a risk that it is no longer possible to control and steer the car. In order to avoid or mitigate a possible further collision with a vehicle or an object in the vehicle's path, the auto braking system is activated automatically and brakes the car in a safe manner.

Brake lights and hazard warning lights are activated during braking. When the car has stopped, the hazard warning lights continue to flash and the parking brake is applied.

If braking is not appropriate, e.g. if there is a risk of being hit by following traffic, the system can be overridden by the driver depressing the accelerator pedal.

The function assumes that the brake system is intact after the collision.

11. Starting and driving

11.1. Starting and switching off the car

11.1.1. Immobiliser

The electronic immobiliser is an anti-theft device that prevents the car from being driven if the correct car key is not found.

The car can only be started with the correct key.

11.1.2. Starting the car

The car is started using the ignition dial in the tunnel console when a key is in the car.

 **Warning**

Before starting:

- Fasten the seatbelt.
- Adjust the seat, steering wheel and mirrors.
- Make sure that the brake pedal can be fully depressed.



Start knob in the tunnel console.

Make sure the key is in the car^[1].

- 1 Put the seatbelt on.
- 2 Depress the brake pedal.^[2]
- 3 Turn the start knob clockwise and release it.
 - The car starts and the ignition dial automatically returns to its original position.
- 4 Change gear to D or R.

 **Important**

If the engine fails to start after 3 attempts - wait for 3 minutes before making a further attempt. Starting capacity increases if the battery is allowed to recover.

When the engine is started, the starter motor works until the engine is started or until its overheating protection triggers^[3].

Error messages

If the message **Car key not detected** is shown, place the key by the back-up reader. Then try to start the car again.



Backup reader's location in the tunnel console.

i Note

When the key is positioned by the back-up reader, make sure that there are no keys, metal objects or electronic apparatus by the back-up reader, (e.g. mobile phones, tablets, computers or chargers). Several keys close to one another by the back-up reader may cause interference with each other.

! Warning

Never remove the key from the car while driving or during towing.

! Warning

Always take the key out from the car when leaving the car and make sure the car's electrical system is in ignition position **0** – especially if there are children in the car.

i Note

The idling speed can be noticeably higher than normal for certain engine types during cold starting. This is done in order that the emissions system can reach normal operating temperature as quickly as possible, which minimises exhaust emissions and protects the environment.

^[1] For cars with passive start, the key needs to be located in the front part of the passenger compartment.

^[2] If the car is moving, the engine can be started by turning the start knob clockwise.

^[3] Does not apply to KERS cars where the alternator is used for starting.

11.1.3. Using jump starting with another battery

If the starter battery is discharged then the car can be started with current from another battery.

Jump starting requires access to another car's 12 V battery as well as jump leads.

! Important

The charging points in mild hybrid type cars are designed for only jump starting the car itself. Do not use the charging points of mild hybrids to start other cars – the fuse for the charging circuit may be overloaded so that it stops working.

In mild hybrid type cars, a discharged starter battery may be caused by an overloaded fuse which prevents charging. If the fuse has blown, the message **12 V battery fuse failure Service required** is shown in the driver display. Volvo recommends that an authorised Volvo workshop is contacted.

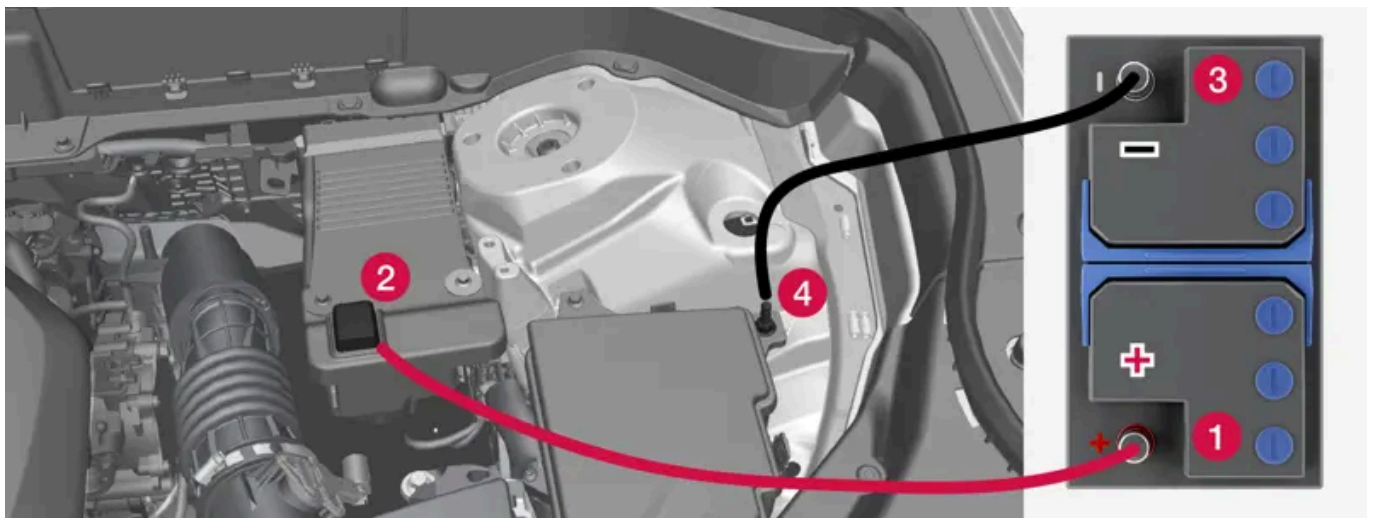

Charging points for jump starting own car. The appearance in the engine compartment may vary depending on car model and equipment level.

When jump starting the car, the following steps are recommended to avoid short circuits or other damage:

- 1 Set the car's electrical system in ignition position 0.
- 2 Check that the donor battery has a voltage of 12 V.
- 3 If the battery is installed in another car – switch off its engine and make sure that the cars do not touch each other.
- 4 Connect one of the red jump lead's clamps to the donor battery's positive terminal (1).

! Important

Connect the jump lead carefully to avoid a short circuit and contact with other components in the engine compartment.

- 5 Open the positive charging point's cover (2).
- 6 Attach the red jump lead's other clamp onto the car's positive charging point (2).

The content of this manual represents the status of the user manual at the time of printing and may not be completely valid in future instances. For more information, refer to the first page for the complete disclaimer note.

- 7 Connect one of the black jump lead's clamps to the donor battery's negative terminal (3).
- 8 Attach the black jump lead's other clamp onto the car's negative charging point (4).
- 9 Check that the jump lead clamps are affixed securely. Poor contact may cause sparks or the clamps to loosen during the starting attempt.
- 10 Start the engine of the donor car and allow it to run for a few minutes at a rotation speed higher than normal idle approx. 1500 rpm.
- 11 Start the engine in the car with the discharged battery.

 **Important**

Do not touch the connections between cable and car during the starting attempt. There is a risk of sparks forming.

- 12 Remove the jump leads in reverse order - first the black and then the red.
Make sure that neither of the black jump lead's clamps comes into contact with the car's positive charging point, the donor battery's positive terminal, or the clamp connected to the red jump lead.

 **Warning**

Mild hybrid type cars have components that work with 48 V voltage, which can be dangerous in the event of incorrect intervention. Do not touch components that are not clearly described in the owner's manual.

- 48 V support battery must never be used for jump starting.
- External electrical equipment must not, under any circumstances, be connected to the 48 V battery.
- The 48 V battery may only be serviced and replaced by a workshop – an authorised Volvo workshop is recommended.

 **Warning**

- The battery can generate oxyhydrogen gas, which is highly explosive. A spark can be formed if a jump lead is connected incorrectly, and this can be enough for the battery to explode.
- Do not connect the jump leads to any fuel system component or any moving part. Be careful of hot engine parts.
- The battery contains sulphuric acid, which can cause serious burns.
- If sulphuric acid comes into contact with eyes, skin or clothing, flush with large quantities of water. If acid splashes into the eyes - seek medical attention immediately.
- Never smoke near the battery.

Note

If the starter battery has such a low State Of Charge (SoC) that the car has no normal electrical functions and the engine is then jump-started with an external battery or a battery charger, the Start/stop function may continue to be activated. If the Start/stop function then auto-stops the engine shortly afterwards, there is a great risk that engine auto-start will fail because the battery has not had the time to recharge sufficiently.

If the car has been jump-started, or if there is insufficient time to charge the battery using a battery charger, the Start/stop function will be temporarily deactivated until the battery has been sufficiently recharged by the car. In an outside temperature of approx. +15 °C (approx. 60 °F), the battery needs to be charged for at least 1 hour by the car. In a lower outside temperature, the charging time may increase to 3–4 hours. The recommendation is to charge the battery if possible using an external battery charger.

11.1.4. Switching off the car

The car is switched off using the start knob in the tunnel console.



Start knob in the tunnel console.

To switch off the car:

- 1 Turn the start knob clockwise and release it.
 - The car switches off and the ignition dial automatically returns to its original position.

If the gear selector is not in position P or if the car rolls:

- 1 Turn the ignition dial clockwise and hold until the car is switched off.

11.1.5. Ignition positions

The car's electrical system can be set in different levels/positions and in this way make the different functions available.

In order to facilitate the use of a limited number of functions with the engine switched off, the car's electrical system can be set in three different levels – **0**, **I** and **II**. These levels are described with the denomination "ignition position" throughout the owner's manual.

The following table shows the functions available in each ignition position/level:

Level	Functions
0	<ul style="list-style-type: none">• Odometer, clock and temperature gauge are illuminated^[1].• Power* seats can be adjusted.• The centre display is started and can be used^[1].• The infotainment system can be used^[1]. <p>In this mode, the functions are controlled by time and are switched off automatically after a short while.</p>
I	<ul style="list-style-type: none">• Panoramic roof, power windows, 12V power socket in the passenger compartment, Bluetooth, navigation, phone, ventilation fan and windscreen wipers can be used.• Power seats can be adjusted.• 12 V power sockets* in the cargo area can be used. <p>Power is taken from the battery in this ignition position.</p>
II	<ul style="list-style-type: none">• The headlamps come on.• Warning/indicator lamps illuminate for 5 seconds.• Several other systems are activated. However, heating in seat cushions and the rear window can only be activated after the car has been started. <p>This ignition position consumes a lot of current from the battery and should therefore be avoided!</p>

^[1] Also activated when the door is opened.

* Option/accessory.

11.1.6. Selecting ignition mode

The car's electrical system can be set in different levels/positions and in this way make the different functions available.

Selecting ignition position



Start knob in the tunnel console.

- **Ignition position 0** – Unlock the car and store the key inside the car.

Note

To reach level I or II **without** starting the engine – do **not** depress the brake pedal when these ignition positions are to be selected.

- **Ignition position I** – Turn the start knob clockwise and release it. The control automatically returns to its starting position.
- **Ignition position II** – Turn the start knob clockwise and hold it in position for approx. 5 seconds. Then release the knob, which automatically returns to its starting position.
- **Back to ignition position 0** – To return to ignition position 0 from position I and II – Turn the start knob clockwise and release. The control automatically returns to its starting position.

11.2. Alcohol lock

11.2.1. Alcohol lock*

The function of the alcohol lock is to prevent the car from being driven by individuals under the influence of alcohol. Before the car can be started, a breath test must be performed to ensure that the driver is not under the influence of alcohol.

The car's system adapts when an alcohol lock is connected to the car. This way, the driver can easily receive messages from the alcohol lock directly in the driver display. Alcohol lock calibration takes place in accordance with each market's limit value in force for driving legally.

For information about a specific alcohol lock, please refer to the relevant alcohol lock manufacturer.

The content of this manual represents the status of the user manual at the time of printing and may not be completely valid in future instances. For more information, refer to the first page for the complete disclaimer note.

 **Warning**

The alcohol lock is an aid and does not exempt the driver from responsibility. It is always the responsibility of the driver to be sober and to drive the car safely.

Using an alcohol lock

The alcohol lock is activated automatically and is then ready for use when the car is unlocked.

In order to obtain correct function and as accurate a measurement result as possible:

- Avoid eating or drinking approx. 5 minutes before the breath test.
- Avoid excess windscreen washing - the alcohol in the washer fluid may result in an incorrect measurement result.

 **Note**

After a completed period of driving, the car can be restarted within 30 minutes without a new breath test.

Bypassing the alcohol lock

In the event of an emergency situation or if the alcohol lock is out of order, it is possible to bypass the alcohol lock in order to drive the car.

To deactivate the alcohol lock, see the alcohol lock manufacturer's instructions.

* Option/accessory.

11.3. Gearbox

11.3.1. Kick-down function

Kick-down can be used when maximum acceleration is needed such as for overtaking.

When the accelerator pedal is pressed all the way to the floor (beyond the position normally regarded as full acceleration) a lower gear is immediately engaged. This is known as kick-down.

If the accelerator is released from the kick-down position, the gearbox automatically changes up.

Safety function

To prevent over-revving of the engine, the gearbox control program has a protective downshift inhibitor.

The gearbox does not permit downshifting/kick-down which would result in an engine speed high enough to damage the engine. Nothing happens if the driver still tries to shift down in this way at high engine speed – the original gear remains engaged.

On kick-down the car can shift down one or more steps at a time, depending in engine speed. The car shifts up when the engine has reached its maximum engine speed in order to prevent engine damage.

11.3.2. Launch function*

Launch can be used when maximum acceleration is required from stationary.

Activate Launch

Make sure the car is stationary and the wheels are pointing straight forward.

- 1 Move to gear position D.
- 2 Depress the brake pedal fully.
- 3 Then fully depress the accelerator pedal.
- 4 Release the brake pedal within 2 seconds.

Note

If the Launch function does not work, wait a few minutes and let the drivetrain cool down to working temperature before retrying.

Important

The drivetrain is subject to wear and tear when using Launch and therefore the function is only available a limited number of times.

* Option/accessory.

11.3.3. Gearbox

The gearbox is part of the car's powertrain (power transmission) between engine and drive wheels. The function of the gearbox is to change the gear ratio depending on speed and power requirements.

The car has a seven or eight-speed automatic gearbox. The number of gear changes means that the engine's torque and power range can be used effectively.

Two of the gears are overdrive gears that save fuel when driving at constant engine speed. The driver display shows the selected gear position.

11.3.4. Gear positions

Gears are selected automatically so that you can drive as energy-efficiently as possible. The gearbox also has a manual gearshift mode.



Overview of gear lever and shift pattern in the driver display.

The driver display shows the selected gear position:

P, R, N, D or M.

11.3.5. Changing gear with automatic gearbox

Change gear position by pressing the spring-loaded gear selector forwards or backwards, or sideways for manual shifting.

Changing gear

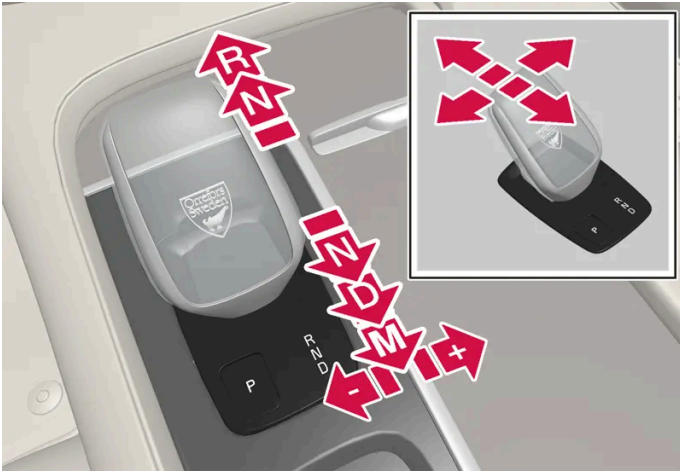

Overview of gear lever and gear positions.

i Note

It is possible to change between D/R at very low speed without your foot on the brake in order to facilitate parking, for example.

Gear positions

Parking – P



Overview of gear lever and position P.

Parking is activated with the P button located next to the gear selector.

The gearbox is mechanically blocked when the P position is engaged.

Select position P for parking. The car can start in position P. The car must be stationary when the P position is selected.

To park - first apply the parking brake and then select P position.

 **Warning**

Always use the parking brake when parking on an inclined surface. Engaging a gear or the automatic transmission's **P** position is not sufficient to hold the car stationary in all situations.

 **Note**

To be able to lock the car and arm the alarm, the gear position must be in **P**.

Help functions

The system will change to the **P** position automatically:

- if the car is switched off in **D** or **R** position when stationary.
- if the car is moving at low speed when the driver unbuckles the seatbelt and opens the driver's door without a pedal depressed.

To park a car without wearing the seatbelt and with the door open - exit the **P** position by selecting **R** or **D** again.

If the car is switched off in **N** position there is no automatic change-over to **P** position. This makes it possible to wash the car in an automatic car wash.

Reverse – **R**

Select position **R** to reverse. The car must be stationary when the **R** position is selected.

Neutral – **N**

The car freewheels in position **N**. Apply the parking brake if the car is stationary with the gear selector in the **N** position.

In order to change from **N** position to another gear position, the brake pedal must be depressed and the engine running.

Drive position - **D**

D is the normal driving position. Shifting up and down takes place automatically based on the level of acceleration and speed.

The car must be stationary when changing gear from **R** position to **D** position.

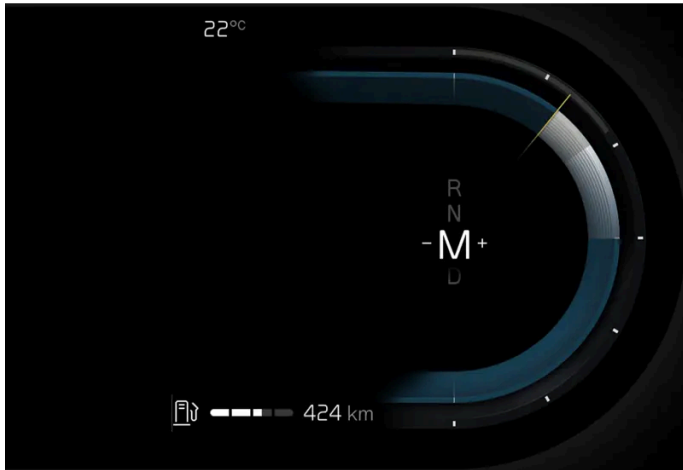

In M position, it is possible to change gear manually. The car engine-brakes when the accelerator pedal is released.

Position M is selected by moving the gear selector backwards from the D position.

- Press the gear selector to the right to "+" (plus) to change up one step and release it.
- Press the gear selector to the left to "-" (minus) to change down one step and release it.
- Press the gear selector backwards to return to the D position.



The gearbox automatically shifts down if the speed decreases to a level lower than appropriate for the selected gear, in order to avoid jerking and stalling.

11.3.6. Symbols and messages for the transmission

If a fault should occur in the gearbox, a symbol and a message are shown in the driver display.

Important

To prevent damage to any drive system components, the working temperature of the gearbox is checked. If there is a risk of overheating, a warning symbol illuminates in the driver display and a text message is shown - follow the recommendation given.

Symbol	Specification
	An error has occurred in the transmission. Read the message in the driver display.
	Hot or overheated gearbox. Read the message in the driver display.
	Temporary fault on drivetrain. Read the message in the driver display.

11.3.7. All-wheel drive *

All-wheel drive (AWD^[1]) means that the car is driving all four wheels at the same time, which improves traction.

To achieve the best possible traction, the motive force is distributed automatically to the wheels with the best grip. The system continuously calculates the need for torque to the rear wheels, and can immediately redistribute up to half of the motor's torque to the rear wheels.

All-wheel drive also has a stabilising effect at higher speeds. Under normal driving conditions, the majority of power is transmitted to the front wheels. When stationary, the all-wheel drive is always engaged in preparation for maximum traction during acceleration.

All-wheel drive characteristics vary depending on the selected drive mode.

* Option/accessory.

^[1] All-wheel drive

11.3.8. Gear selector inhibitor

The gear selector inhibitor prevents accidental changing between different gear positions in an automatic gearbox.

Automatic gear selector inhibitor

The automatic gear selector inhibitor has special safety systems.

From park position – P or neutral position – N

In order to move the gear selector from P or N position to another gear position, the engine must be running, the brake pedal must be depressed, the car stationary and the ignition position must be II.

If the gear selector is in the N position and the car has been stationary for at least 3 seconds (irrespective of whether the engine is running) then the gear selector is locked.

Message in the driver display

If the gear selector is inhibited a message is shown in the driver display, e.g. **Press brake pedal to activate gear lever.**

The gear selector is not inhibited mechanically.^[1]

^[1] Applies to cars with small gear lever

11.3.9. Gear shift indicator

The content of this manual represents the status of the user manual at the time of printing and may not be completely valid in future instances. For more information, refer to the first page for the complete disclaimer note.

The gear shift indicator in the driver display shows the current gear during manual gearshifting and when it is appropriate to engage the next gear for optimum fuel economy.

For eco-driving during manual gear changing, it is important to drive in the right gear and to change gear in good time.

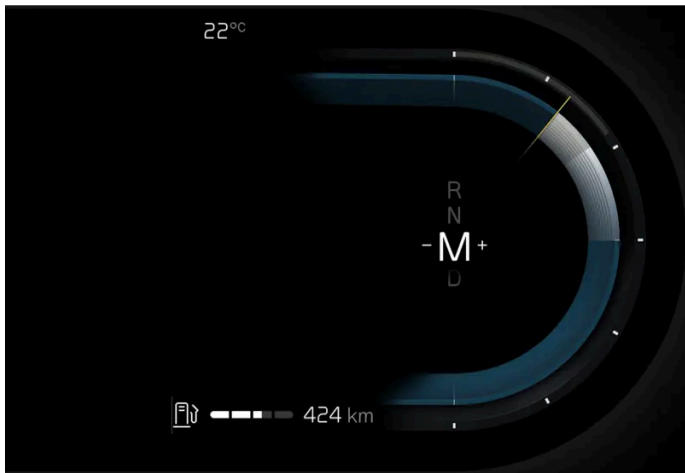

Gear shift indicator in the driver display.

The gear shift indicator shows the current gear in the driver display and indicates recommended shifting to a higher or lower gear by a flashing plus or minus sign.

11.4. Brakes

11.4.1. Foot brake

11.4.1.1. Brake assistance

The brake assist system (BAS^[1]) helps to increase brake force during braking, and can thereby shorten the braking distance.

The system detects the way in which the driver brakes and increases brake force where necessary. The brake force can be boosted up to the level when the ABS system is engaged.

Note

When BAS is activated, depress (hold) the brake pedal as long as necessary.

^[1] Brake Assist System

11.4.1.2. Braking on gritted roads

When driving on salted roads, a layer of salt may form on the brake discs and brake linings.

This may extend braking distance. You should therefore maintain a greater safety distance to vehicles in front. In addition, make sure you do the following:

- Brake now and again to remove any layer of salt. Make sure that other road users are not put at risk by the braking.

11.4.1.3. Braking on wet roads

When driving for a prolonged period of time in heavy rain without braking, the braking effect may be delayed slightly when next using the brakes.

This may also be the case after a car wash. It is then necessary to depress the brake pedal more forcefully. You should therefore maintain a greater distance to the vehicles in front.

Brake the car firmly after driving on wet roads or using a car wash. This warms up the brake discs, enabling them to dry faster and protecting them against corrosion. Bear in mind the current traffic situation when braking.

11.4.1.4. Foot brake

The foot brake is part of the brake system.

The car is equipped with two brake circuits. If a brake circuit is damaged, the brake pedal may engage deeper. Higher pressure on the pedal will therefore be needed to produce the normal braking effect.

The driver's brake pedal pressure is assisted by a brake servo.



Warning

The brake servo only works when the car is activated.

If the foot brake is used when the car is not activated, greater pedal pressure is required to brake the car.

In very hilly terrain or when driving with a heavy load the brakes should be relieved by using engine braking in manual gearshift mode. Engine braking is most efficiently used if the same gear is used downhill as up.





Anti-lock braking system

The content of this manual represents the status of the user manual at the time of printing and may not be completely valid in future instances. For more information, refer to the first page for the complete disclaimer note.

The car has anti-lock brakes (ABS^[1]), which prevents the wheels from locking while braking and allows maintained steering control.

After the car has been activated, a short test of the ABS system takes place. A further automatic test of the system may take place at low speed.

Symbols in the driver display

Symbol	Specification
	An error has occurred on the braking system. Read the message on the driver display and contact a workshop. Volvo recommends that an authorised Volvo workshop is contacted.
	An error has occurred in the pedal sensor.
	Constant glow for 2 seconds when the car is started: Automatic function check. Constant glow for more than 2 seconds: ABS fault. The car's regular brake system continues to work, but without ABS function.
	In the event of the message: Brake pedal characteristics changed Service required The brake pedal needs to be depressed past the normal braking position using a higher pressure to brake the car.

Warning

If both the warning lamps for brake fault and ABS fault illuminate at the same time, a fault has occurred in the brake system.

- If the level in the brake fluid reservoir is normal at this stage, drive carefully to the nearest workshop and have the brake system checked - an authorised Volvo workshop is recommended.
- If the brake fluid is below the MIN level in the brake fluid reservoir, do not drive further before topping up the brake fluid. The reason for the loss of brake fluid must be investigated.

^[1] Anti-lock Braking System

11.4.1.5. Brake system maintenance

Check brake system components regularly for wear.

To keep the car as safe and reliable as possible, follow the Volvo service intervals as specified in the Service and Warranty Booklet. After replacing brake linings and brake discs, braking effect is only adapted after they have been "worn in" for a few hundred kilometres (miles). Compensate for the reduced braking effect by depressing the brake pedal harder. Volvo recommends only fitting brake linings that are approved for your Volvo.

 **Important**

The wear on the brake system's components must be checked regularly.

Contact a workshop for information about the procedure or engage a workshop to carry out the inspection - an authorised Volvo workshop is recommended.

11.4.2. Parking brake

11.4.2.1. Parking brake

The parking brake prevents the car from rolling away from stationary by means of mechanically locking/blocking the rear wheels.



The control for the parking brake is located in the tunnel console between the seats.

A faint electric motor noise can be heard when the electrically-operated parking brake is being applied. The noise can also be heard during the automatic function checking of the parking brake.

If the car is stationary when the parking brake is activated, it only acts on the rear wheels. If it is activated when the car is moving then the normal foot brake is used, i.e. the brake acts on all four wheels. Brake function changes over to the rear wheels when the car is almost stationary.

11.4.2.2. Activating and deactivating the parking brake

Use the parking brake to prevent the car from rolling from stationary.

Activating the parking brake



- 1 Pull the control upward.
 - The symbol in the driver display illuminates when the parking brake is activated.
- 2 Check that the car is stationary.

Symbol in the driver display

Symbol	Specification
	The symbol is illuminated when the parking brake is activated. If the symbol flashes, it indicates a fault has occurred. Read the message in the driver display.

Automatic activation

The parking brake is activated automatically

- when gear position P is selected on a steep hill.
- if the automatic brake when stationary (Auto hold) function is activated and
 - the car has been stationary for a long time (5-10 minutes)
 - the car is switched off
 - the driver leaves the car.

Emergency brake

In an emergency, the parking brake can be activated when the car is in motion by pulling and holding up the control. The car is then braked heavily with the foot brake. Braking stops when the control is released, or if the accelerator pedal is depressed.

Note

An acoustic signal sounds while emergency braking is active at high speeds.

Deactivating the parking brake



Deactivate manually

To deactivate the parking brake, the engine needs to be running.

- 1 Depress the brake pedal firmly.
- 2 Press down the control.
 - > The parking brake releases and the symbol in the driver display extinguishes.

Deactivate automatically

- 1 Start the car.
- 2 Depress the brake pedal firmly. Select gear position D or R and depress the accelerator pedal.
 - > The parking brake releases and the symbol in the driver display extinguishes.

Note

For automatic deactivation, either the driver has to have put on their seatbelt or the driver door has to be closed.

11.4.2.3. Parking on a hill

Always make sure that the parking brake has been activated when parking on a hill.

 **Warning**

Always use the parking brake when parking on an inclined surface. Engaging a gear or the automatic transmission's P position is not sufficient to hold the car stationary in all situations.

If the car is parked facing uphill:

- Turn the wheels **away from** the kerb.

If the car is parked facing downhill:

- Turn the wheels **towards** the kerb.

Heavy load uphill

A heavy load, such as a trailer, can cause the car to roll backward when the parking brake is released automatically on a steep incline. Avoid this by pulling the control upwards while driving the car away. Release the control when the engine achieves traction.

11.4.2.4. In the event of a fault in the parking brake

Contact an authorised Volvo workshop if it is not possible to deactivate or activate the parking brake after several attempts.

An acoustic warning signal sounds when driving with the parking brake activated.

If the car must be parked before a possible fault is rectified, then the wheels must be turned as for parking on a hill and the gear selector must be in position P.



Low battery voltage

If the battery voltage is too low then the parking brake can be neither deactivated nor activated. Connect a donor battery if the battery voltage is too low.

Replacing the brake linings

The rear brake linings must be replaced at a workshop due to the design of the electrically-operated parking brake - an authorised Volvo workshop is recommended.

Symbols in the driver display

Symbol	Specification
	If the symbol flashes, it indicates a fault has occurred with the parking brake. See the message in the driver display.
	Fault in brake system. See the message in the driver display.
	Information message in driver display.

11.4.3. Brake fluid – specifications

Brake fluid is the medium in a hydraulic brake system that is used to transfer pressure from e.g. a brake pedal via a master brake cylinder, which in turn acts on the brake callipers.

Prescribed grade: Volvo Original or equivalent fluid compliant with a combination of Dot 4, 5.1 and ISO 4925 class 6.

Note

It is recommended that brake fluid is changed or filled by an authorised Volvo workshop.

11.4.4. Brake functions

The car's brakes are used to reduce the speed or prevent the car from rolling.

Besides the foot brake and parking brake, the car is equipped with several automatic brake assist functions. These can assist the driver by not needing to keep his/her foot on the brake pedal when at a traffic light, or when starting on an uphill gradient.

Depending on the car's equipment, the following auto braking functions are available:

- Automatic brake when stationary (Auto hold)
- Hill start assist (Hill Start Assist)
- Auto braking after a collision
- Regenerative braking
- Warning and auto-brake when reversing
- Assistance at risk of collision

11.4.5. Automatic braking when stationary

Automatic brake when stationary (Auto hold) means that the driver can release the brake pedal while maintaining braking effect when the car has stopped at traffic lights or a junction.

When the car has stopped, the brakes are activated automatically. The function can use either foot brake or parking brake to hold the car stationary and it works on all gradients. When driving off, the brakes are released automatically if the driver is wearing the seatbelt and/or the driver's door is closed.

Note



When braking to a standstill on an uphill or downhill slope, the brake pedal should be depressed a little harder before being released to ensure the car does not roll.

The parking brake is activated automatically

- if the car is switched off
- when the driver unbuckles the seatbelt and/or opens the driver's door.
- if the function Auto hold (brake when stationary) is activated and the car has been stationary for a while (approx. 5–10 minutes).

Auto hold can also change over to the parking brake in other situations.

Symbols in the driver display

Symbol	Specification
	The symbol is illuminated when the function uses the foot brake to keep the car stationary. Note that the foot brake may be active even if the symbol is not lit.
	The symbol is illuminated when the function uses the parking brake to keep the car stationary.

11.4.6. Activating and deactivating the automatic brake at a standstill

The automatic brake function at a standstill is activated using the button in the tunnel console.



- 1 Press the button in the tunnel console to activate or deactivate the function.
 - The indicator in the button illuminates when the function is activated. Activated function remains even when the car is started next time.

Applicable when switching off



If the function is active and holds the car with the foot brake (A-symbol illuminated in the driver display), the brake pedal must be depressed at the same time as the button is depressed in order to deactivate.

- The function remains deactivated until it is reactivated.
- When the function is deactivated, brake assist remains active to prevent the car from rolling backwards when starting on an uphill gradient.

11.4.7. Auto braking after a collision

In the event of a collision in which the activation level is reached for the pyrotechnic seatbelt tensioners or airbags, or if a collision with a large animal is detected, the car's brakes are automatically applied. This function is to prevent or reduce the effects of any subsequent collision.

After a serious collision there is a risk that it is no longer possible to control and steer the car. In order to avoid or mitigate a possible further collision with a vehicle or an object in the vehicle's path, the auto braking system is activated automatically and brakes the car in a safe manner.

Brake lights and hazard warning lights are activated during braking. When the car has stopped, the hazard warning lights continue to flash and the parking brake is applied.

If braking is not appropriate, e.g. if there is a risk of being hit by following traffic, the system can be overridden by the driver depressing the accelerator pedal.

The function assumes that the brake system is intact after the collision.

11.4.8. Regenerative braking*

The car recovers kinetic energy during braking in order to reduce fuel consumption and emissions.

The function is available in all drive modes together with gear position D or M.

Regeneration with the brake pedal

- 1 Depress the brake pedal.
 - The car brakes and regenerates energy.

Symbols in the driver display

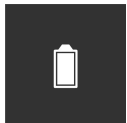

If the car is a mild hybrid, a battery symbol is shown on the right of the driver display.

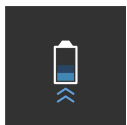

When the battery is being charged, e.g. during regenerative braking, this is indicated by this symbol.

* Option/accessory.

11.5. Drive modes

11.5.1. Regenerative braking*

The car recovers kinetic energy during braking in order to reduce fuel consumption and emissions.

The function is available in all drive modes together with gear position D or M.

Regeneration with the brake pedal

The content of this manual represents the status of the user manual at the time of printing and may not be completely valid in future instances. For more information, refer to the first page for the complete disclaimer note.

- 1 Depress the brake pedal.
 - > The car brakes and regenerates energy.

Symbols in the driver display



If the car is a mild hybrid, a battery symbol is shown on the right of the driver display.



When the battery is being charged, e.g. during regenerative braking, this is indicated by this symbol.

* Option/accessory.

11.5.2. Launch function*

Launch can be used when maximum acceleration is required from stationary.

Activate Launch

Make sure the car is stationary and the wheels are pointing straight forward.

- 1 Move to gear position D.
- 2 Depress the brake pedal fully.
- 3 Then fully depress the accelerator pedal.
- 4 Release the brake pedal within 2 seconds.

Note

If the Launch function does not work, wait a few minutes and let the drivetrain cool down to working temperature before retrying.

 **Important**

The drivetrain is subject to wear and tear when using Launch and therefore the function is only available a limited number of times.

* Option/accessory.

11.5.3. All-wheel drive *

All-wheel drive (AWD^[1]) means that the car is driving all four wheels at the same time, which improves traction.

To achieve the best possible traction, the motive force is distributed automatically to the wheels with the best grip. The system continuously calculates the need for torque to the rear wheels, and can immediately redistribute up to half of the motor's torque to the rear wheels.

All-wheel drive also has a stabilising effect at higher speeds. Under normal driving conditions, the majority of power is transmitted to the front wheels. When stationary, the all-wheel drive is always engaged in preparation for maximum traction during acceleration.

All-wheel drive characteristics vary depending on the selected drive mode.

* Option/accessory.

^[1] All-wheel drive

11.6. Start/stop function

11.6.1. Start/stop function

With the start/stop function, the engine switches off temporarily when the car has stopped e.g. at traffic lights or in a traffic queue, and then starts again when it is needed.

The start/stop function reduces fuel consumption, which in turn can contribute to an environmentally conscious driving style and reduced emissions.

Points to remember when using the start/stop function

For the start/stop function to work requires that a number of conditions are met.

The start/stop function is not activated

One or more criteria may mean that the engine is not switched off/the function is not activated.

- the driver has not fastened the seatbelt
- the car has not been able to reach a speed of approx. 10 km/h (6 mph) after starting, or the function has been activated a number of times successively
- the engine has not reached normal operating temperature
- the windscreen's electric heating is activated
- the environment in the passenger compartment deviates from the set values
- the driver is making large steering wheel movements
- the road is very steep
- the bonnet is opened
- the ABS system has been activated
- in the event of heavy braking (even without the ABS system having been activated)
- many starts during a short period of time have activated the starter motor's thermal protection
- the exhaust system's particulate filter is full
- a trailer is connected to the car's electrical system.

Note

High current take-off may lead to battery capacity falling below the lowest permitted level, which temporarily limits the start/stop function. The engine then starts automatically without the driver lifting his/her foot from the brake pedal.

The start/stop function is not deactivated

One or more criteria may mean that the engine is not started/the function is not deactivated.

- the driver has not fastened the seatbelt
- gear position P is engaged and the driver door is open.

The start/stop function is deactivated without the brake pedal being released

In the following cases, the function may be deactivated and the engine started without the driver releasing the brake pedal:

- high humidity in the passenger compartment forms misting on the windows
- the environment in the passenger compartment deviates from the set values
- the bonnet is opened
- the capacity of the battery has fallen below the minimum permissible level
- the driver's seatbelt is unbuckled and the gear selector is in position D or N
- the gear selector is moved from position D to position R or M
- the driver door is opened with the gear selector in position D.

 **Warning**

Do not open the bonnet when the start/stop function is active. Switch off the engine normally before raising the bonnet.

11.6.2. Activating and deactivating the start/stop function

The start/stop function is available when the car is started. When the function is activated, the engine is switched off temporarily. The engine then starts automatically when the function is deactivated or when the car requires this.

Activating the start/stop function

- 1 Depress and hold the brake pedal depressed.
 - The start/stop function is activated and the engine is switched off.

 **Note**

- In some cases, the start/stop function is activated before the car is completely stationary.
- When adaptive cruise control or Pilot Assist is activated, the start/stop function is activated for a few seconds after the car is completely stationary.

 **Note**

All of the car's normal systems, such as lighting and radio, work normally even when the start/stop function is activated. However, some equipment may have temporarily reduced function, such as the climate control's fan speed or loud-speaker volume.

Deactivating the start/stop function

- 1 Release the brake pedal or gently depress the accelerator pedal.
 - The start/stop function is deactivated and the engine starts.



 **Note**

When the start/stop function is activated and:

- the function for automatic brake when stationary (Auto hold) is activated, start of the engine is delayed until the accelerator pedal is depressed
- adaptive cruise control or Pilot Assist is activated, the engine starts when the accelerator pedal is depressed or by pressing the  button on the left-hand steering wheel keypad
- the car is facing uphill, hill start assist (HSA^[1]) engages to prevent the car from rolling backwards
- the car is facing downhill, release the brake pedal slightly. A small increase in speed starts the engine.

Symbols in the driver display

The driver display's tachometer indicates when the start/stop function is available, active or unavailable.

Symbol	Specification
	White – the function is available.
	Green – the function is activated.
	Grey – the function is not available.

If no symbol is shown in the driver display, the function is disabled.

^[1] Hill Start Assist

11.7. Recommendations for driving

11.7.1. Towing

During towing, the car is towed by another vehicle by means of a towline.

Find out the statutory maximum speed limit for towing before the towing begins.

Preparations and towing

 **Important**

Some gearbox variants prevent shifting out of the P position unless the engine is running. Contact an authorised Volvo workshop for assistance when towing, or summon professional help for recovery.

 **Important**

Note that the car must always be towed with the wheels rolling forward.

- Do not tow cars with automatic transmission at speeds higher than 80 km/h (50 mph) or for distances in excess of 80 km (50 miles).

 **Warning**

- Ignition position II must be active - in ignition position I all airbags are deactivated.
- Always keep the key in the car when it is being towed.

 **Warning**

The brake servo and power steering do not work when the engine is switched off - the brake pedal needs to be depressed about 5 times more heavily and the steering is considerably heavier than normal.

- 1 Activate the car's hazard warning flashers.
- 2 Secure the towline in the towing eye.
- 3 Set the car in ignition position II – turn the start knob clockwise without depressing the brake pedal, and hold the knob in place for approx. 4 seconds. Then release the knob, which automatically returns to its starting position.
- 4 Move the gear selector to neutral position and release the parking brake.
If the battery voltage is too low, the parking brake cannot be disengaged. Connect a donor battery if the battery voltage is too low.
> The towing vehicle can now start towing.
- 5 Keep the towline taut when the towing vehicle reduces speed by holding your foot gently pressed on the brake pedal - thereby avoiding unnecessary jerking.
- 6 Be prepared to brake to stop.

Jump starting

Do not tow the car to jump start the engine. Use a donor battery if the starter battery is discharged and the engine does not start.

 **Important**

The catalytic converter may be damaged during attempts to tow-start the engine.

11.7.2. Braking on gritted roads

When driving on salted roads, a layer of salt may form on the brake discs and brake linings.

This may extend braking distance. You should therefore maintain a greater safety distance to vehicles in front. In addition, make sure you do the following:

- Brake now and again to remove any layer of salt. Make sure that other road users are not put at risk by the braking.

11.7.3. Braking on wet roads

When driving for a prolonged period of time in heavy rain without braking, the braking effect may be delayed slightly when next using the brakes.

This may also be the case after a car wash. It is then necessary to depress the brake pedal more forcefully. You should therefore maintain a greater distance to the vehicles in front.

Brake the car firmly after driving on wet roads or using a car wash. This warms up the brake discs, enabling them to dry faster and protecting them against corrosion. Bear in mind the current traffic situation when braking.

11.7.4. Parking on a hill

Always make sure that the parking brake has been activated when parking on a hill.

 **Warning**

Always use the parking brake when parking on an inclined surface. Engaging a gear or the automatic transmission's **P** position is not sufficient to hold the car stationary in all situations.

If the car is parked facing uphill:

- Turn the wheels **away from** the kerb.

If the car is parked facing downhill:

- Turn the wheels **towards** the kerb.

Heavy load uphill

A heavy load, such as a trailer, can cause the car to roll backward when the parking brake is released automatically on a steep incline. Avoid this by pulling the control upwards while driving the car away. Release the control when the engine achieves traction.

11.7.5. Petrol particle filter

Petrol cars are fitted with particle filters^[1] for more efficient emission control.

Particles in the exhaust gases are collected in the petrol particle filter during normal driving. In normal driving conditions, passive regeneration takes place, which leads to the particles being oxidised and burned away. The filter is emptied in this way.

If the car is driven at low speed or with repeated cold starts in low outside temperature, active regeneration may be necessary. Regeneration of the particulate filter is automatic and normally takes 10-20 minutes. Fuel consumption may temporarily increase during regeneration.

When driving short distances at low speeds in a petrol car

The capacity of the emissions system is affected by how the car is driven. Driving varying distances and at different speeds is important in order to achieve performance that is as energy-efficient as possible.

Driving short distances at low speeds (or in cold climates) frequently, where the engine does not reach normal operating temperature, can lead to problems that can eventually cause a malfunction and trigger a warning message. If the vehicle is mostly driven in city traffic, it is important to regularly drive at higher speeds to allow the emissions system to regenerate.

- The car should be driven on A-roads at speeds in excess of 70 km/h (44 mph) between each refuelling.

^[1] Applicable to certain variants.

11.7.6. Petrol station

Use the car's navigation system* in order to find the route to the closest petrol station.

When stopping to refuel it is a good idea to make a general inspection of the car as well, such as checking tyre pressure, bulbs, wiper blades, topping up washer fluid, etc.

* Option/accessory.

11.7.7. Preparations for a long trip

Before a driving holiday or some other type of long journey, it is important to check the car's functions and equipment particularly carefully.

Check that

- the engine is working normally and that fuel consumption is normal
- there is no leakage of fluids
- braking effect on braking works as intended
- all lamps are working - adjust headlamp level if the car is heavily laden
- the tyres have sufficient tread depth and pressure. Change to winter tyres when driving to areas where there is a risk of snowy or icy road surfaces
- starter battery charging is good
- the wiper blades are in good condition
- a warning triangle and high-visibility vest are located in the car - legally required in certain countries

11.7.8. Overloading the starter battery

High power consumption without the car being able to charge the starter battery leads to low battery level and some electric functions being reduced or switched off. If the battery level decreases to below a certain limit, it is no longer possible to start the car without jump starting or charging the starter battery with an external charger.

There are several measures that reduce power consumption. Avoid using the ignition position II when the car is switched off. Instead, use ignition position I - which consumes less power. Do not use functions which use a lot of power when the car is not being driven. Examples of such functions are:

- ventilation fan
- headlamps
- windscreen wiper
- audio system
- accessories that are activated in the car.

If the battery level is low, a message is shown in the driver display. The energy-saving function then shuts down certain functions or reduces certain functions such as the ventilation fan and audio system.

- 1 In which case, charge the starter battery by starting the car and then running it for at least 15 minutes. Starter battery charging is more effective during driving than running at idling speed.

If the battery level continues to be low after the measures have been taken, the car should be checked at a workshop – an authorised Volvo workshop is recommended.

 **Note**

High current take-off may lead to low battery level, which temporarily limits the start/stop function. The engine can then be started automatically during a stop to charge the battery.

11.7.9. Driving in water

Wading means the car being driven through water e.g. on a flooded road. Driving in water must be performed with great caution.

While driving in water

Observe the following to prevent damage to the car when driving through water:

- The car can be driven through water to a maximum depth of 25 cm (9 inches).
- Do not drive faster than walking pace.
- Do not stop the car in the water. Drive forward carefully or reverse the car back out of the water.
- Extra caution should be exercised when passing through flowing water.
- Do not let the car stand with water over the sills for any long period of time - this could cause electrical malfunctions.

 **Important**

- Engine damage can occur if water enters the air filter.
- If water enters the transmission, it reduces the lubricating ability of the oil, which shortens the service life of related systems.
- Damage to any component, engine, transmission, turbocharger, differential or its internal components caused by flooding, hydrostatic locking or oil shortage, is not covered by the warranty.
- In the event of the engine stalling in water, do not try restart - tow the car from the water to a workshop - an authorised Volvo workshop is recommended. Risk of engine breakdown.

After driving in water

When the water has been passed, depress the brake pedal lightly and check that full brake function is achieved. Water and mud for example can make the brake linings wet resulting in delayed brake function.

If necessary, clean the contacts for the electric heater and trailer coupling after driving in water and mud.

11.7.10. Winter driving

The content of this manual represents the status of the user manual at the time of printing and may not be completely valid in future instances. For more information, refer to the first page for the complete disclaimer note.

For winter driving it is important to perform certain checks of the car in order to ensure that it can be driven safely.

Check the following in particular before a cold season:

- The engine coolant must contain 50% glycol. This mixture protects the engine against frost down to approx. -35°C (-31°F). To avoid health risks, different types of glycol must not be mixed.
- The fuel tank must be kept filled to prevent condensation.
- Engine oil viscosity is important. Oils with lower viscosity (thinner oils) facilitate starting in cold weather and also reduce fuel consumption while the engine is cold.
- The condition of the starter battery and charge level must be inspected. Cold weather places great demands on the starter battery and its capacity is reduced by the cold.
- The condition of the battery and its charge level must be inspected. Cold weather places higher demands on the battery and its capacity is reduced by the cold.
- Use washer fluid with antifreeze to avoid ice forming in the washer fluid reservoir.

See the separate section for engine oil recommendations.

Slippery driving conditions

To achieve optimum roadholding Volvo recommends using winter tyres on all wheels if there is a risk of snow or ice.

Note

The use of winter tyres is a legal requirement in certain countries. Studded tyres are not permitted in all countries.

Practise driving on slippery surfaces under controlled conditions to learn how the car reacts.

11.7.11. Overheating in the engine and drive system

Under certain conditions, e.g. hard driving in hilly terrain and hot climate, there is an increased risk of overheating the engine and drive system – in particular with a heavy load.

- In the event of overheating, the engine's power may be limited temporarily.
- Remove any auxiliary lamps from in front of the grille when driving in hot climates.
- If the temperature in the engine's cooling system becomes too high then a warning symbol is illuminated and the driver display shows the message **Stop safely High engine temperature**. Stop the car in a safe way and allow the engine to run at idling speed for several minutes and cool down.
- If the message **Turn off engine High engine temperature** or **Turn off engine Coolant level low** is shown, stop the car and switch off the engine.
- A built-in protection function is activated if the transmission overheats. A warning symbol illuminates and the driver display shows the **Reduce speed to lower temperature Transmission warm** or **Stop safely Transmission hot Wait for cooling**



message. Follow the recommendation given, reduce speed or stop the car in a safe way and allow the engine to run at idling speed for several minutes to enable the gearbox to cool down.

- If the car overheats, the air conditioning may be switched off temporarily.
- Do not turn the engine off immediately you stop after a hard drive.

 **Note**

It is normal for the engine's cooling fan to operate for a time after the engine has been switched off.

Symbols in the driver display

Symbol	Specification
	High engine temperature. Follow the recommendation given.
	Low level, coolant. Follow the recommendation given.
	Gearbox hot/overheated/cooled. Follow the recommendation given.

11.8. Towbar and trailer

11.8.1. Towing capacity and towball load

Towing capacity and towball load for driving with a trailer can be read in the tables.

Max. weight braked trailer

 **Note**

Use of vibration dampers on the towbar is recommended for trailers heavier than 1800 kg.

Engine	Engine code ^[1]	Max. weight braked trailer (kg)	Max. towball load (kg)
B5	B420T2	2000	100
B6 AWD	B420T	2200	100

 **Important**

When driving with a trailer, it is permitted to exceed the vehicle's gross vehicle weight (including towball load) by a maximum of 100 kg (220 lbs), provided that speed is limited to 100 km/h (62 mph). National legal requirements for the vehicle combination, such as speed, etc. must be observed.

 **Note**

If weight data is missing in the table, it will be updated at a later date.

Max. weight unbraked trailer

Unbraked trailer	
Max. weight (kg)	750
Max. towball load (kg)	50

^[1] The engine code, component number and serial number can be found on the engine.

11.8.2. Towbar*

The car can be equipped with a towbar that makes it possible to tow e.g. a trailer behind the car.

There may be different towbar variants available for the car. Contact a Volvo dealer for more information.

 **Important**

When the car is switched off, the constant battery voltage to the trailer connector can be switched off automatically in order not to drain the starter battery.

 **Important**

The towball needs regular cleaning and lubrication with grease in order to prevent wear.

 **Note**

When a stabiliser hitch is used, the towball must not be lubricated.

This also applies when fitting a bicycle rack that is clamped in around the towball.

Note

If the car is equipped with a towbar, there is no rear mounting for a towing eye.

* Option/accessory.

11.8.3. Specifications for towbar*

Dimensions and mounting points for towbar.

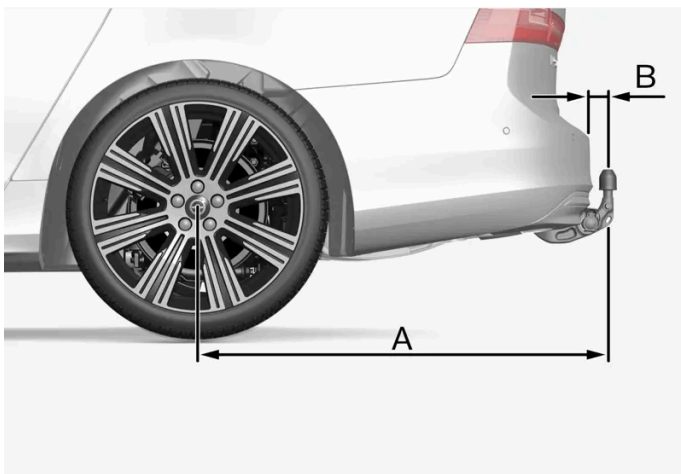

The illustration is generic and may vary depending on model.

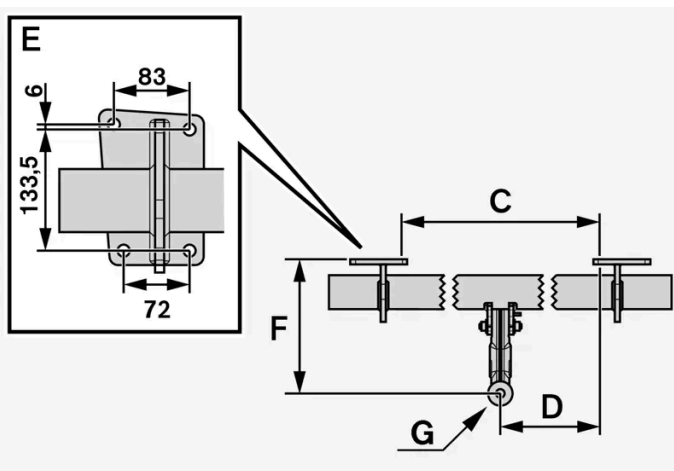

Dimensions, mounting points in mm (inches)	
A	1229 (48.4)
B	111.8 (4.4)
C	875 (34.4)
D	437.5 (17.2)
E	See the image above

Dimensions, mounting points in mm (inches)

F	310.5 (12.2)
G	Ball centre

* Option/accessory.

11.8.4. Towbar-mounted bicycle rack*

When using a bicycle rack, the bicycle racks that Volvo has developed are recommended.

This is in order to avoid damage to the car and in order to achieve the maximum possible safety during a journey. Volvo's bicycle racks are available for purchase at authorised Volvo dealers.

Carefully follow the instructions enclosed with the bicycle rack.

- Bicycle rack including load must weigh a maximum of 75 kg (165 pounds).
- Rear Auto Brake should be deactivated before driving with a bicycle rack.

Warning

Incorrect use of the bicycle rack may cause damage to the towbar and car.

The bicycle rack can loosen from the towbar if it

- is incorrectly fitted on the towball
- is overloaded, see the bicycle rack's instructions for maximum load weight
- is used for carrying something other than bicycles.

The car's driving characteristics are affected when a bicycle rack is fitted on the towbar. For example due to:

- increased weight
- reduced acceleration capacity
- reduced ground clearance
- changed braking capacity.

Recommendations for loading bicycles on the bicycle rack

The larger the distance between the load's centre of gravity and the towball, the greater the load on the towbar.

Load according to the following recommendations:

- Fit the heaviest bicycle furthest in, closest to the car.
- Keep the load symmetrical and as close to the centre of the car as possible e.g. by loading the bicycles facing alternately if several bicycles are loaded.

The content of this manual represents the status of the user manual at the time of printing and may not be completely valid in future instances. For more information, refer to the first page for the complete disclaimer note.

- Remove loose objects from the bicycle for transportation, e.g. bicycle basket, battery, child seat. Partly to reduce the load on the towbar and bicycle rack, and partly to reduce the wind resistance, which affects fuel consumption.
- Do not use protective covers on the bicycles. This may affect manoeuvrability, impair visibility and increase fuel consumption. It may also lead to an increased load on the towbar.

* Option/accessory.

11.8.5. Extendable and retractable towbar*

The retractable tow hook^[1] is easy to retract or extend as required. In the retracted position, the towbar is completely concealed.



 **Warning**

Follow the instructions for retracting and extending the towbar carefully.

 **Warning**

Do not press the extend/retract button if a trailer or accessory is attached to the tow bar.



A button for extending/retracting the towbar is located on the right-hand side at the rear of the cargo area. The indicator lamp in the button flashes or illuminates with a constant orange glow when retracting and extending are active.

Extending the towbar

- 1 Press and release the button in the cargo area – extending might not start if the button is pressed for too long.
 - The towbar is extended outward and downward in an unlocked position - the indicator lamp flashes orange.
- 2 Manoeuvre the towbar to its end position where it is secured and locked in.
 - The indicator lamp illuminates with a constant glow when the towbar is ready for use.

Warning

Avoid standing close to the bumper in the centre behind the car when extending the towing hitch.

Important

When the tow bar is activated by pressing a key and has been placed in the unlocked position:

Wait at least 2 seconds before the tow bar is moved to the locked position. If the tow bar does not remain in the locked position, wait another few seconds and try again.

Do not kick the tow bar.

Warning

Take care to secure the trailer's safety cable in the intended bracket.

Note

Power save mode activates after a while and the indicator lamp goes out. The system is reactivated by closing and opening the tailgate. This applies when retracting or extending the towbar.

If the car detects a connected trailer electrically, the indicator lamp stops illuminating with a constant glow. Towbar retraction and extension are then not possible.

Retracting the towbar

- 1 Press and release the button in the cargo area – retracting might not start if the button is pressed for too long.
 - The towbar is extended downward in an unlocked position - the indicator lamp flashes orange.
- 2 Lock the towbar by moving it back to its retracted position, where it is locked.
 - The indicator lamp will illuminate with a constant glow when the towbar is correctly retracted.

 **Important**

Make sure that there is no plug or adapter in the electrical socket when retracting the towbar.

 **Important**

When the tow bar is activated by pressing a key and has been placed in the unlocked position:

Wait at least 2 seconds before the tow bar is moved to the locked position. If the tow bar does not remain in the locked position, wait another few seconds and try again.

Do not kick the tow bar.

 **Important**

The towbar must always be retracted when not in use.

* Option/accessory.

[1] Only available on certain markets.

11.8.6. Driving with a trailer

When driving with a trailer, there are a number of points that are important to think about regarding the towbar, the trailer and how the load is positioned in the trailer.

Payload depends on the car's kerb weight. The total of the weight of the passengers and all accessories, e.g. towbar, reduces the car's payload by a corresponding weight.

The car is supplied with the necessary equipment for towing a trailer.

- The car's towbar must be of an approved type.

- Distribute the load on the trailer so that the weight on the towbar complies with the specified maximum towball load. Towball load is calculated as part of the car's payload.
- Increase the tyre pressure to the recommended pressure for a full load.
- The engine is loaded more heavily than usual when driving with a trailer.
- Do not tow a heavy trailer when the car is brand new. Wait until it has been driven at least 1000 km (620 miles).
- Follow the regulations in force for the permitted speeds and weights.
- Maintain a low speed when driving with a trailer up long, steep ascents.
- The maximum indicated trailer weight only applies to heights up to 1000 metres above sea level (3280 ft). At higher elevations, the engine output and the vehicle's climbing ability are reduced due to the reduced air density, and the maximum trailer load must therefore be reduced. The weight of the car and trailer must be decreased by 10% for each additional 1000 m (3280 ft) or part thereof.
- Avoid driving with a trailer on inclines of more than 12%.
- Rear Auto Brake should be deactivated before driving with a trailer.

 **Note**

Extreme weather conditions, driving with a trailer or driving at high altitudes, in combination with poorer fuel quality than recommended, are factors that considerably increase the car's fuel consumption.

Trailer weights

 **Warning**

Follow the stated recommendations for trailer weights. Otherwise, the car and trailer may be difficult to control in the event of sudden movement and braking.

 **Note**

The stated maximum permitted trailer weights are those permitted by Volvo. National vehicle regulations can further limit trailer weights and speeds. Towbars can be certified for higher towing weights than the car can actually tow.

When driving in hilly terrain

Under certain circumstances, there may be a risk of overheating when towing a trailer. If the engine and drive system overheats, a warning symbol comes on in the driver display and a message is displayed.

The automatic gearbox adapts the gears depending on load and engine speed.

Steep inclines

Do not lock the automatic gearbox in a higher gear than the engine "can cope with" - it is not always a good idea to drive at a high gear with low engine speed.

Parking on a hill

The content of this manual represents the status of the user manual at the time of printing and may not be completely valid in future instances. For more information, refer to the first page for the complete disclaimer note.

- 1 Depress the brake pedal.
- 2 Activate the parking brake.
- 3 Release the brake pedal.

Block the wheels with chocks when parking a car with hitched trailer on a hill.

Starting on a hill

- 1 Depress the brake pedal.
- 2 Select gear position D.
- 3 Pull and hold the parking brake control upwards while depressing the accelerator pedal.
- 4 Release the parking brake control when sufficient motor torque has been built up. The parking brake then releases and the car can be driven away without rolling backwards.

11.8.7. Trailer stability assist *

The function of trailer stability assist (TSA^[1]), which is included in the stability system ESC^[2], is to stabilise a car towing a trailer in situations where the car/trailer combination starts to snake. The function is available with towbar installation, contact a Volvo dealer for more information.

Reasons for snaking

The snaking phenomenon can occur with any car/trailer combination. Snaking normally occurs at high speeds. However, there is a risk of it occurring at lower speeds if the trailer is overloaded or the load is improperly distributed, e.g. too far back.

Triggering factors for snaking may, for example, include:

- Car with trailer subjected to a sudden and powerful side wind.
- Car with trailer drives on an uneven road surface or in a pothole.
- Sweeping steering wheel movements.

If snaking has started, it could be difficult or even impossible to suppress. This makes the car/trailer combination difficult to control and there is a risk that you could end up in the wrong lane or leave the carriageway.

Trailer stability assist function

The trailer stability assist function continually monitors the car's movements, particularly lateral movements. If snaking is detected, the front wheels are individually braked. This serves to stabilise the car/trailer combination. This is often enough to help the driver regain control of the car.

If snaking is not eliminated the first time that trailer stability assist intervenes, the car/trailer combination is braked with all wheels and the car's traction is reduced. Once snaking has been gradually suppressed and the car/trailer combination is stable once again, the system stops regulating and the driver once again has full control of the car.

Trailer stability assist may fail to intervene if the driver uses severe steering wheel movements to try to rectify the snaking because in such a situation the system cannot determine whether it is the trailer or the driver causing the snaking.



When Trailer Stability Assist (TSA) is operating, the ESC symbol flashes in the driver display.



Retrofitting a towbar requires an update of the car's software, contact a Volvo dealer.

* Option/accessory.

[1] Trailer Stability Assist

[2] Electronic Stability Control

11.8.8. Checking trailer lamps *

When connecting a trailer – check that the trailer lamps work before departure.

Checking trailer lamps *

Automatic checking

After a trailer is connected electrically, it is possible to ensure that the trailer lamps are working via an automatic lamp activation. The function helps the driver check that the trailer lamps are working before starting off.

- 1 When a trailer is connected to the towbar, the **Perform a trailer lamp check?** message is shown in the driver display.
- 2 Confirm the message by pressing the right-hand steering wheel keypad's **O** button.
 - > The lamp check starts.
- 3 Exit the car to check lamp functionality.
 - > All trailer lamps start to flash - then the lamps are switched on one at a time.
- 4 Visually check that all lamps available on the trailer are operational.

5 After a moment, all lamps on the trailer flash again.

➤ The check is complete.

Rear fog lamp on trailer

When connecting a trailer, there may be instances when the rear fog lamp on the car does not illuminate. In these cases, rear fog lamp functionality is transferred to only the trailer. Therefore, in these cases, check when the rear fog lamp is activated that the trailer is equipped with rear fog lamp in order to drive the vehicle combination in a safe manner.

Symbols and messages in the driver display

If one or more of the trailer's direction indicators or brake light bulbs is broken, the driver display shows a symbol and a message. Other lights on the trailer must be checked manually by the driver before setting off.

Symbol	Message
	Right trailer turn indicator malfunction Left trailer turn indicator malfunction
	Trailer brake light malfunction

If any lamp for the trailer's direction indicators is broken, the driver display symbol for direction indicators will also flash more quickly than normal.

* Option/accessory.

11.9. Fuel

11.9.1. Fuel gauge

The fuel gauge in the driver display shows the fuel level in the tank.

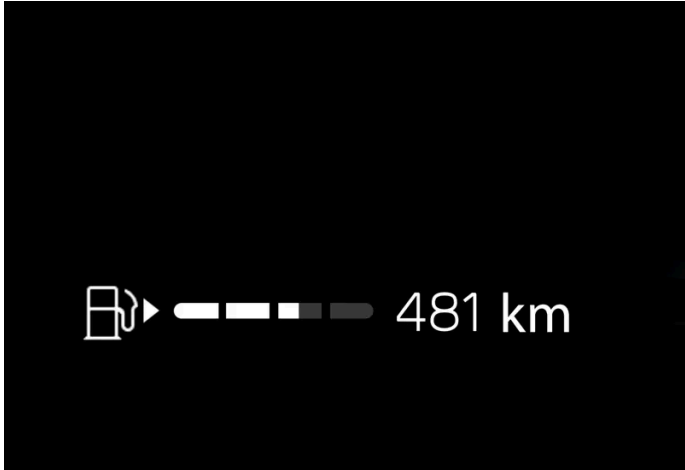

The white zone in the fuel gauge indicates the quantity of fuel in the tank.

When the fuel level is low, the fuel pump symbol illuminates and turns amber colour. Distance to empty tank is also indicated in the fuel gauge.

Distance to empty tank

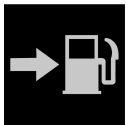

The trip computer calculates how far you can drive with the amount of fuel in the tank.

The calculation is based on the average fuel consumption over the last 30 km (20 miles) and the remaining amount of fuel.

When the gauge shows "----", there is not enough fuel left to be able to calculate the remaining mileage. Then, refuel as soon as possible.

Note

There may be a slight deviation if the driving style has been changed.

An economic driving style generally results in a longer driving distance.

11.9.2. Handling of fuel

Do not use fuel with a lower quality than that recommended by Volvo, as this will negatively affect engine power and fuel consumption.

 **Warning**

Always avoid inhaling fuel vapour and getting fuel splashes in the eyes.

In the event of fuel in the eyes, remove any contact lenses and rinse the eyes in plenty of water for at least 15 minutes and seek medical attention.

Never swallow fuel. Fuels such as petrol, bioethanol and mixtures of them and diesel are highly toxic and could cause permanent injury or be fatal if swallowed. Seek medical attention immediately if fuel has been swallowed.

 **Warning**

Fuel which spills onto the ground can be ignited.

Switch off the fuel-driven heater before starting to refuel.

Never carry an activated mobile phone when refuelling. The ring signal could cause spark build-up and ignite petrol fumes, leading to fire and injury.

 **Important**

Mixtures of various fuel types or use of fuels which are not recommended will invalidate Volvo's guarantees and any supplementary service agreements; this is applicable to all engines.

11.9.3. Petrol

It is important to use the correct fuel during refuelling. Petrol is available with different octane ratings that are adapted for different types of driving.

Only use petrol from well-known producers. Never use fuel of dubious quality. Petrol must fulfil the EN 228 standard.

Identifier for petrol

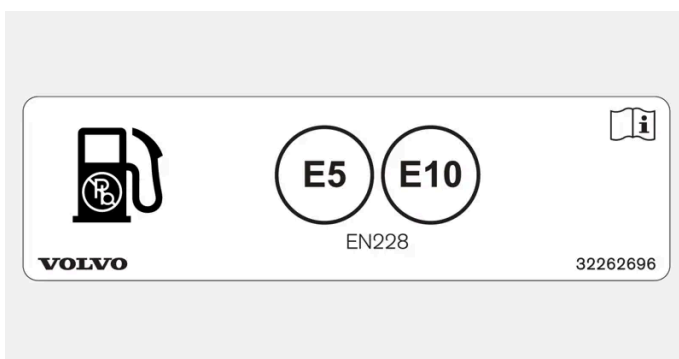

Decal on the inside of the fuel filler flap.

The identifier in accordance with the CEN standard EN16942 is located on the inside of the fuel filler flap, and will be on corresponding fuel pumps and their nozzles at filling stations throughout Europe by 12 October 2018 at the latest.

These are the identifiers that apply for current standard fuels in Europe. Petrol with the following identifiers may be used in cars with petrol engine.



E5 is a petrol with maximum 2.7% oxygen and maximum 5 volume % ethanol.



E10 is a petrol with maximum 3.7% oxygen and maximum 10 volume % ethanol.

 **Important**

- Fuel that contains up to 10 percent by volume ethanol is permitted.
- EN 228 E10 petrol (max 10 percent by volume ethanol) is approved for use.
- Ethanol higher than E10 (max. 10 percent by volume ethanol) is not permitted, e.g. E85 is not permitted.

Octane rating

- RON 95 can be used for normal driving.
- RON 98 is recommended for good power and low fuel consumption.
- An octane rating lower than RON 95 must not be used.

When driving in temperatures above +38 °C (100 °F), fuel with the highest octane rating is recommended for adapted performance and fuel economy.

 **Important**

- Use only unleaded petrol to avoid damaging the catalytic converter.
- Fuel containing metallic additives must not be used.
- Do not use any additives which have not been recommended by Volvo.

11.10. Refuelling

11.10.1. Handling of fuel

Do not use fuel with a lower quality than that recommended by Volvo, as this will negatively affect engine power and fuel consumption.

 **Warning**

Always avoid inhaling fuel vapour and getting fuel splashes in the eyes.

In the event of fuel in the eyes, remove any contact lenses and rinse the eyes in plenty of water for at least 15 minutes and seek medical attention.

Never swallow fuel. Fuels such as petrol, bioethanol and mixtures of them and diesel are highly toxic and could cause permanent injury or be fatal if swallowed. Seek medical attention immediately if fuel has been swallowed.

 **Warning**

Fuel which spills onto the ground can be ignited.

Switch off the fuel-driven heater before starting to refuel.

Never carry an activated mobile phone when refuelling. The ring signal could cause spark build-up and ignite petrol fumes, leading to fire and injury.





 **Important**

Mixtures of various fuel types or use of fuels which are not recommended will invalidate Volvo's guarantees and any supplementary service agreements; this is applicable to all engines.

11.10.2. Fuel consumption/electric consumption and CO₂ emissions

The information in the tables below is in accordance with WLTP (Worldwide Harmonised Light-Duty Vehicles Test Procedure), which is an international test method for vehicles.

The fuel consumption for a vehicle is measured in litres per 100 km and carbon dioxide emissions (CO₂) are measured in gram CO₂ per km.

Explanation	
	Urban driving (slow)
	Suburban driving (average speed)
	Extra-urban driving (fast)
	Motorway driving (very fast)
	Combined value (combined driving)

CO ₂	Gram CO ₂ /km
	Litres/100 km
	Low value
	High value

Note

If fuel consumption and emissions data are missing in the table, it will be updated at a later date.

	CO ₂		CO ₂		CO ₂		CO ₂		CO ₂		
B6 AWD(B420T)		271	11.9	179	7.9	150	6.6	170	7.5	179	7.9
		284	12.5	196	8.6	167	7.4	191	8.4	197	8.7

The values in the table above for fuel consumption and CO₂ emissions are based on special drive cycles (see below). The car's weight may increase depending on its equipment level. Together with how heavily the car is loaded, this affects fuel consumption and CO₂ emissions. According to WLTP, every car has unique fuel consumption and CO₂ emission values depending on how the car is equipped. These values range between the low value and high value in the table above. In many markets, you can find your car's unique fuel consumption and CO₂ emission values in the car's registration document.

There are several reasons for fuel consumption that is higher than the values in the table. Examples of these include:

- If the car is equipped with extra equipment that affects its weight or air resistance.
- Driving style.
- If the customer chooses wheels other than those mounted as standard on the basic version of the model, this could increase rolling resistance.
- High speed causes increased air resistance.
- Fuel quality, road and traffic conditions, weather and the condition of the car.

A combination of the examples above could increase consumption considerably.

There may be huge deviations in fuel consumption if comparing to the drive cycle profiles (see below), which are used in the certification of the car and on which consumption figures in the table are based. For further information, please refer to the referenced regulations.

 **Note**

Extreme weather conditions, driving with a trailer or driving at high altitudes, in combination with poorer fuel quality than recommended, are factors that considerably increase the car's fuel consumption.

WLTP standard

The WLTP standard (Worldwide Harmonised Light-Duty Vehicles Test Procedure) is a standard to calculate consumption values in the car. The WLTP standard represents the average driving conditions for everyday driving. In comparison with the previous standard (NEDC), WLTP takes into account more varied traffic situations and speeds, but also equipment and weight classes. Optional equipment that affects consumption is deactivated during testing, e.g. air conditioning, seat heating, etc. The new standard should provide more realistic figures when it comes to fuel consumption, carbon dioxide and emissions. The values are intended to allow comparison between different cars and not to represent your typical normal consumption.

Drive cycle profiles

A drive cycle simulates actual average driving of the car. The standard is based on four different drive cycle profiles, which are as follows:

- **Urban driving** – slow driving
- **Suburban driving** – average speed driving
- **Extra-urban driving** – fast driving
- **Motorway driving** – very fast driving.

Every drive cycle is determined by different conditions such as speed, time and mileage, for example.

The official value for combined driving, which is shown in the table, is a combination of the results from the four drive cycles, in accordance with legal requirements.

The exhaust gases are collected in order to extrapolate the carbon dioxide emissions (CO₂ emissions) during the four drive cycles. These were then analysed to determine the value for CO₂ emissions.

11.10.3. Petrol station

Use the car's navigation system* in order to find the route to the closest petrol station.

When stopping to refuel it is a good idea to make a general inspection of the car as well, such as checking tyre pressure, bulbs, wiper blades, topping up washer fluid, etc.

* Option/accessory.

11.10.4. Fuel tank - volume

The fuel tank's filling capacity can be read in the table below.

	All engines
Litres (approx)	60
US gallons (approx)	15,9

11.10.5. Filling fuel

The fuel tank is fitted with a coverless fuel filler system.

Refuelling the car at a petrol station

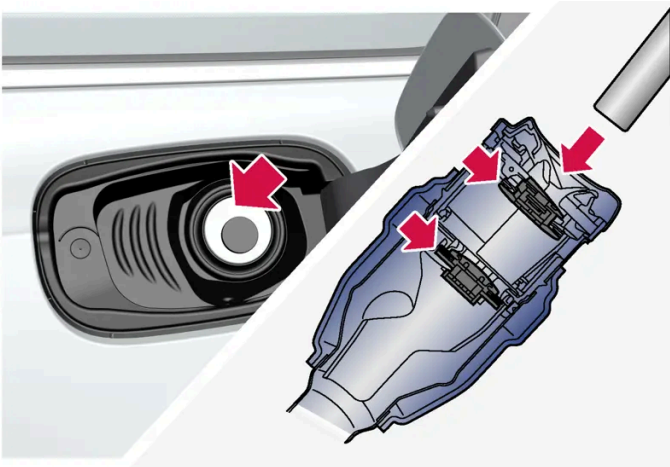

It is important to feed the pump nozzle past the filler pipe's two openable hatches before starting to fuel the car.

Fuelling instruction:

- 1 Switch off the car and open the fuel filler flap.

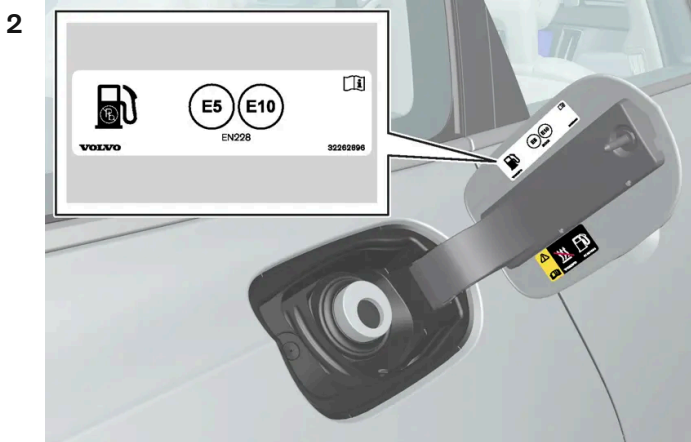

Choose fuel that is approved for use in the car in accordance with the identifier^[1] on the inside of the fuel filler flap. See information on approved fuels and the identifier in the section on "Petrol".

- 3 Insert the pump nozzle in the fuel filler opening. The filler pipe has two opening caps. The pump nozzle must be pushed past both caps before refuelling is started.
 - 4 Do not overfill the tank but fill until the pump nozzle cuts out the first time.
- The tank is full.

Note

Overfilled fuel in the tank can overflow in hot weather.

Topping up fuel from a fuel can

When filling with a fuel can, use the funnel located in the foam block under the floor hatch in the cargo area.

- 1 Open the fuel filler flap.
- 2 Insert the funnel in the fuel filler opening. The filler pipe has two opening caps. The funnel must be pushed past both caps before refuelling is started.

Applicable to cars with fuel-driven auxiliary heater*

Never use the fuel-driven heater when the car is in a filling station area.

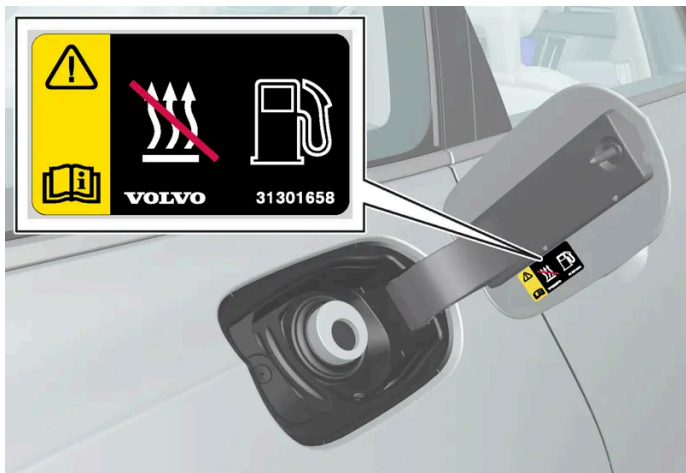

Decal on the inside of the fuel filler flap.

^[1] The identifier in accordance with the CEN standard EN16942 is located on the inside of the fuel filler flap, and will be on corresponding fuel pumps and their nozzles at filling stations throughout Europe by 12 October 2018 at the latest.

* Option/accessory.

11.10.6. Opening and closing the fuel filler flap

The car must be unlocked for the fuel filler flap to be opened^[1].

- 1 Open the fuel filler flap with a gentle press on the rear of the flap.
- 2 After refuelling is finished - close the flap with a gentle press.

* Option/accessory.

^[1] Only locking and unlocking with the key, keyless* or via the Volvo Cars app affects the status of the fuel filler flap.

11.11. Emission control

11.11.1. Petrol particle filter

Petrol cars are fitted with particle filters^[1] for more efficient emission control.

Particles in the exhaust gases are collected in the petrol particle filter during normal driving. In normal driving conditions, passive regeneration takes place, which leads to the particles being oxidised and burned away. The filter is emptied in this way.

If the car is driven at low speed or with repeated cold starts in low outside temperature, active regeneration may be necessary. Regeneration of the particulate filter is automatic and normally takes 10-20 minutes. Fuel consumption may temporarily increase during regeneration.

When driving short distances at low speeds in a petrol car

The capacity of the emissions system is affected by how the car is driven. Driving varying distances and at different speeds is important in order to achieve performance that is as energy-efficient as possible.

Driving short distances at low speeds (or in cold climates) frequently, where the engine does not reach normal operating temperature, can lead to problems that can eventually cause a malfunction and trigger a warning message. If the vehicle is mostly driven in city traffic, it is important to regularly drive at higher speeds to allow the emissions system to regenerate.

- The car should be driven on A-roads at speeds in excess of 70 km/h (44 mph) between each refuelling.

^[1] Applicable to certain variants.

11.12. HomeLink

11.12.1. HomeLink® *

HomeLink® ^[1] ^[2] is a programmable remote control integrated into the car's electrical system. It can control up to three different devices remotely, e.g. a garage door opener or alarm system, and hence replace the remote controls for these.

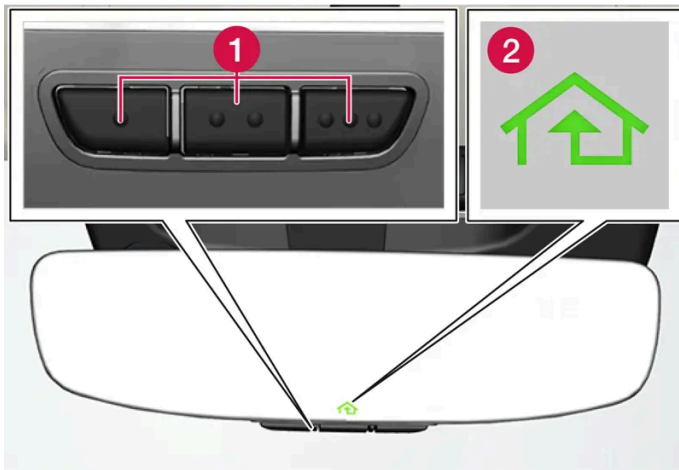

The figure is schematic - the version may vary.

- 1 Programmable buttons
- 2 Indicator lamp

HomeLink® is built into the interior rearview mirror and consists of three programmable buttons and one indicator lamp in the mirror glass.

i Note

Save the original remote controls for future reprogramming (e.g. when changing to another car or for use in another vehicle).

It is also recommended that the programming for the buttons should be deleted when the car is sold.

More information

Visit homelink.com or call 00 8000 466 354 65 (or premium charge number +49 6838 907 277) ^[3].

* Option/accessory.

^[1] Applies to certain markets.

^[2] HomeLink and the HomeLink house symbol are registered trademarks of Gentex Corporation.

^[3] Note that the toll-free number may not be available depending on operator.

11.12.2. Using HomeLink[®] *

When HomeLink[®] ^[1] is fully programmed it can be used in place of the separate original remote controls.

Depress the programmed button. The garage door, gate, alarm system or similar is activated (may take a few seconds). If the button is depressed for more than 20 seconds then the reprogramming is started. The indicator lamp illuminates or flashes when the button has been depressed. Naturally the original remote controls can still be used in parallel with HomeLink[®] if required.

Note

When the ignition has been switched off, HomeLink[®] works for at least 7 minutes.

Note

HomeLink[®] cannot be used if the car is locked and the alarm is armed* from the outside.

Warning

- If HomeLink[®] is used to control a garage door or gate, ensure that nobody is near the door or gate while it is in motion.
- Do not use HomeLink[®] for any garage door that does not have safety stop and safety reverse.

* Option/accessory.

^[1] Applies to certain markets.

11.12.3. Programming HomeLink[®] *

Program HomeLink[®] ^[1], reset programming or reprogram individual buttons.

Programming

- 1 Aim the remote control towards the HomeLink[®] button to be programmed and hold it approx. 2-8 cm (approx. 1-3 inches) from the button. Do not obstruct the indicator lamp on HomeLink[®].
 - 2 Press and hold depressed both the button on the remote control and the button to be reprogrammed on HomeLink[®].
 - 3 Do not release the buttons until the indicator lamp has switched from flashing slowly (approx. once per second) to either flashing quickly (approx. 10 times per second) or illuminating with a constant glow.
- **If the indicator lamp illuminates with a constant glow:** Indication that the programming has finished.
Press the programmed button twice to activate.

The content of this manual represents the status of the user manual at the time of printing and may not be completely valid in future instances. For more information, refer to the first page for the complete disclaimer note.

If the indicator lamp flashes quickly: The device to be programmed to HomeLink® may have a security function that requires extra steps.

Test by pressing the programmed button twice to see whether the programming is working. Otherwise, continue with the following steps.

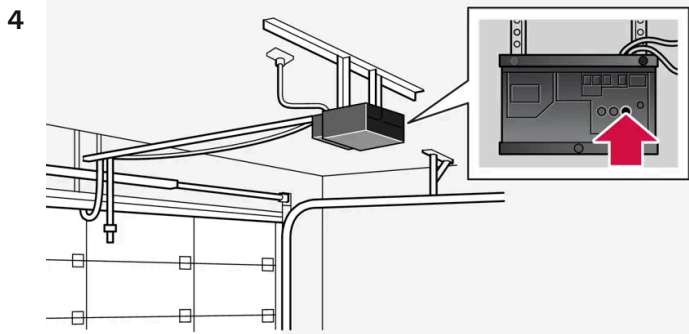

Locate programming button ^[2] on the receiver for the garage door or similar. It is normally located close to the antenna's bracket on the receiver.

- 5 Depress and release the receiver's programming button once.

The programming must be completed within 30 seconds of the button being depressed.

- 6 Press and release the button on HomeLink® that you want to program. Repeat the sequence of pressing/holding/releasing a second time and, depending on the receiver model, even a third time.

➤ Programming is finished.

i Note

The ability of some remote controls to program HomeLink® is improved at a distance of approx. 15–20 cm (approx. 6–12 inches).

Reprogramming individual buttons

- 1 Press the desired button and hold it depressed for approx. 20 seconds.
- 2 Once the indicator lamp on HomeLink® starts to flash slowly, programming can continue as normal.

i Note

If the button to be reprogrammed is not programmed with a new unit, it will resume the previously saved programming.

Resetting the HomeLink® buttons

It is only possible to reset all HomeLink® buttons at the same time. Individual buttons can only be reprogrammed.

- 1 Press and hold depressed the outer buttons on HomeLink® for approx. 10 seconds.
- When the indicator lamp changes over from a constant glow to starting to flash, the buttons are reset and ready to be reprogrammed.

Problems with programming

Visit homelink.com or call 00 8000 466 354 65 (or premium charge number +49 6838 907 277)^[3].

* Option/accessory.

^[1] Applies to certain markets.

^[2] Button designation and colour varies between manufacturers.

^[3] Note that the toll-free number may not be available depending on operator.

11.12.4. Type approval for HomeLink® *

The type approval for HomeLink®^[1] can be read below.

Country/Area	Type approval
USA and Canada	This device complies with FCC rules part 15 and Industry Canada RSS-210. Operation is subject to the following two conditions: (1) This device may not cause harmful interference, and (2) This device must accept any interference that may be received including interference that may cause undesired operation.
Europe	Gentex Corporation hereby declares that HomeLink® Model UAHL5 complies with the Radio equipment directive 2014/53/EU. Wavelength within which the radio equipment functions: <ul style="list-style-type: none"> • 433.05MHz-434.79MHz <10mW E.R.P. • 868.00MHz-868.60MHz <25mW E.R.P. • 868.70MHz-868.20MHz <25mW E.R.P. • 869.40MHz-869.65MHz <25mW E.R.P. • 869.70MHz-870.00MHz <25mW E.R.P. Certificate holder address: Gentex Corporation, 600 North Centennial Street, Zeeland MI 49464, USA

* Option/accessory.

^[1] Applies to certain markets.

11.13. Towing and recovery

11.13.1. Towing

During towing, the car is towed by another vehicle by means of a towline.

Find out the statutory maximum speed limit for towing before the towing begins.

Preparations and towing

Important

Some gearbox variants prevent shifting out of the P position unless the engine is running. Contact an authorised Volvo workshop for assistance when towing, or summon professional help for recovery.

Important

Note that the car must always be towed with the wheels rolling forward.

- Do not tow cars with automatic transmission at speeds higher than 80 km/h (50 mph) or for distances in excess of 80 km (50 miles).

Warning

- Ignition position II must be active - in ignition position I all airbags are deactivated.
- Always keep the key in the car when it is being towed.

Warning

The brake servo and power steering do not work when the engine is switched off - the brake pedal needs to be depressed about 5 times more heavily and the steering is considerably heavier than normal.

- 1 Activate the car's hazard warning flashers.
 - 2 Secure the towline in the towing eye.
 - 3 Set the car in ignition position II – turn the start knob clockwise without depressing the brake pedal, and hold the knob in place for approx. 4 seconds. Then release the knob, which automatically returns to its starting position.
 - 4 Move the gear selector to neutral position and release the parking brake.
If the battery voltage is too low, the parking brake cannot be disengaged. Connect a donor battery if the battery voltage is too low.
- The towing vehicle can now start towing.

- 5 Keep the towline taut when the towing vehicle reduces speed by holding your foot gently pressed on the brake pedal - thereby avoiding unnecessary jerking.
- 6 Be prepared to brake to stop.

Jump starting

Do not tow the car to jump start the engine. Use a donor battery if the starter battery is discharged and the engine does not start.

Important

The catalytic converter may be damaged during attempts to tow-start the engine.

11.13.2. Fitting and removing the towing eye

Use the towing eye for towing. The towing eye is screwed into a threaded socket behind a cover on the right-hand side of the bumper, front or rear.

Note

If the car is equipped with a towbar, there is no rear mounting for a towing eye.

Fitting the towing eye

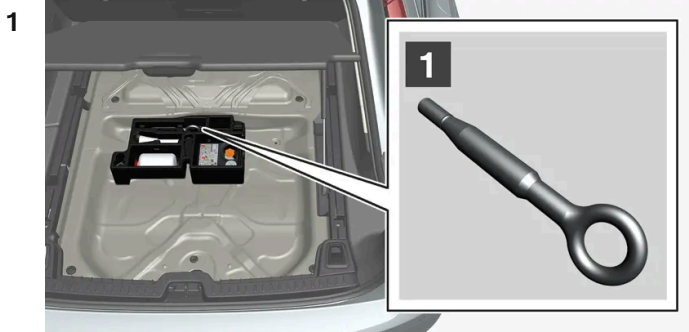

1

Take out the towing eye from the foam block under the floor in the cargo area.



2

Front: Remove the cover - press on the marking with a finger.

- The cover pivots around its centre line and can then be removed.

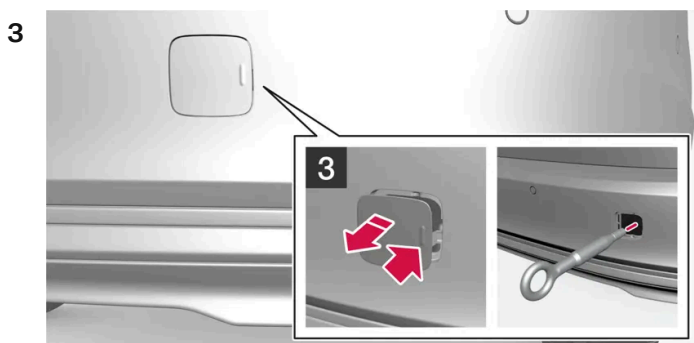

3

Rear: Remove the cover – press on the marking with a finger while you fold out the opposite side/corner.

- The cover pivots around its centre line and can then be removed.

4 Screw in the towing eye until it reaches its end stop.

Screw the eye in firmly. For example, thread through the wheel bolt wrench * and use it as a lever.

Important

It is important that the towing eye is firmly screwed into place - right in until it stops.

Points to remember before using the towing eye

- The towing eye may be used to pull the car up onto a recovery vehicle with a flatbed platform. The car's position and ground clearance determine whether it is possible.
- If the slope of the recovery vehicle's ramp is too steep, or if the ground clearance under the car is inadequate, then the car may be damaged if you try to pull it up using the towing eye.
- If necessary, raise the car by using the recovery vehicle's lifting device. Do not use the towing eye.

 **Warning**

No one/nothing is allowed to remain behind the recovery vehicle while the car pulled up onto the flatbed platform.

 **Important**

The towing eye is only designed for towing on roads - not for pulling the car unstuck or out of a ditch. Call a recovery service for recovery assistance.

Removing the towing eye

- 1 Unscrew and remove the towing eye after use and return it to its foam block.
Finish by refitting the cover onto the bumper.

* Option/accessory.

11.13.3. Recovery

For recovery, the car is taken away with the help of another vehicle.

Call a recovery service for recovery assistance.

The towing eye can be used to pull the car up onto a recovery vehicle with a flatbed platform.

If the car is equipped with air suspension*, this must be disabled before the car is raised. Deactivating the function via the centre display.

- 1 Press .
- 2 Select **Driving**.
- 3 Select to activate or deactivate air suspension.

The car's position and ground clearance determine whether it is possible to pull it up onto a flatbed platform. If the slope of the recovery vehicle's ramp is too steep, or if the ground clearance under the car is inadequate, then the car may be damaged if you try to pull it up. The car should then be lifted using the recovery vehicle's lifting device.

 **Warning**

No one/nothing is allowed to remain behind the recovery vehicle while the car pulled up onto the flatbed platform.

 **Important**

The towing eye is only designed for towing on roads - **not** for pulling the car unstuck or out of a ditch. Call a recovery service for recovery assistance.

 **Important**

Note that the car must always be transported with the wheels rolling forward.

Cars with all-wheel drive* recovered with front wheels raised must not be towed at a speed above 70 km/h (40 mph) or for a distance longer than 50 km (30 miles).

* Option/accessory.

11.13.4. Safety mode

Safety mode is a protective state that is triggered when a collision may have damaged any of the car's vital functions, such as the fuel lines, sensors for any of the safety systems, or the brake system.

If the car has been in a collision, the message **Safety mode See Owner's manual** may be shown on the driver display with a warning symbol as long as the display is not damaged and the car's electrical system is still in working order. This message means that the car has reduced functionality.

 **Warning**

Never, under any circumstances, attempt to restart the car if it smells of fuel when the **Safety mode See Owner's manual** message is shown in the driver display. Leave the car at once.

If the car is in safety mode, it is possible to attempt to reset the system in order to start and move the car for a short distance, if in a dangerous traffic situation for example.

 **Warning**

Never attempt to repair your car or reset the electronics yourself if the car has been in safety mode. This could result in personal injury or the car not functioning as normal. Volvo recommends engaging an authorised Volvo workshop to check and restore the car to normal status after **Safety mode See Owner's manual** has been shown.

 **Warning**

If the car is in safety mode it must not be towed. It must be transported from its location. Volvo recommends that it is transported to an authorised Volvo workshop.

11.13.5. Starting and moving the car after safety mode

If the car is in safety mode, it is possible to attempt to reset the system in order to start and move the car for a short distance, if in a dangerous traffic situation for example.

Reset and start the car after safety mode

- 1 Check the general damage situation of the car and whether any fuel has been leaking. There must be no smell of fuel either.

If there is only minor damage and a check has revealed no fuel leaks, starting can be attempted.

 **Warning**

Never, under any circumstances, attempt to restart the car if it smells of fuel when the **Safety mode See Owner's manual** message is shown in the driver display. Leave the car at once.

- 2 Switch off the car manually.
 - 3 Then try to start the car.
- The car's electronics carry out a systems check and then try to resume normal status.

 **Important**

If the message **Safety mode See Owner's manual** is still shown on the display the car must not be driven or towed but a vehicle recovery service must then be used instead. Even if the car appears to be driveable, hidden damage may make the car impossible to control once moving.

Moving the car after safety mode

- 1 If the driver display shows the message **The car is now in normal mode** after a start attempt, the car can be carefully moved if standing in a dangerous position.
- 2 Do not move the car further than necessary.

Warning

If the car is in safety mode it must not be towed. It must be transported from its location. Volvo recommends that it is transported to an authorised Volvo workshop.

11.14. Damping

11.14.1. Level control* and shock absorption

Level control and shock absorption are regulated automatically in the car.

With rear level control, the car maintains the same height at the rear while driving, regardless of load.

Shock absorption (Four-C)*

On cars equipped with Four-C, shock absorption is normally set for optimum comfort and is regulated continuously depending on the road surface, the car's acceleration, braking and cornering.

During parking^[1]

During parking, make sure you allow adequate space above and below the car since the car's ground clearance may vary e.g. depending on the outside temperature, how the car is loaded or the use of loading mode.

The level may also be adjusted some time after the car has been parked. This is to compensate for any changes in height that may occur due to temperature changes in the air springs when the car cools down.







During transport

During transport of the car on a ferry, train or truck, the car must be lashed around the tyres and not around other parts of the chassis. Changes in the level control may occur during transport, which could have a negative effect on the lashing.

Symbols and messages

If a fault arises with the level control, a message is shown in the driver display.

The content of this manual represents the status of the user manual at the time of printing and may not be completely valid in future instances. For more information, refer to the first page for the complete disclaimer note.

Symbol	Message	Specification
	Suspension Deactivated by user	The active self-levelling has been switched off manually by the user.
	Suspension Temporarily reduced performance	The performance of the active self-levelling has been temporarily reduced due to extensive system use.
	Suspension Service required	A fault has occurred. Visit a workshop ^[2] as soon as possible.
	Stop safely Suspension failure	A critical fault has occurred. The car's driving performance is significantly reduced, stop safely. Have the car towed to a workshop ^[2] if the message is shown when the car is stationary.
	Slow down Suspension Car too high	A fault has occurred. The car's driving performance is reduced, slow down until the symbol disappears. Contact a workshop ^[2] if the message is shown when the car is stationary.
	Suspension Auto adjusting car level	Level control of the car's rear axle to target height in progress.

* Option/accessory.

^[1] Applies to cars with air suspension

^[2] An authorised Volvo workshop is recommended.

11.15. Level control

11.15.1. Level control* and shock absorption

Level control and shock absorption are regulated automatically in the car.

With rear level control, the car maintains the same height at the rear while driving, regardless of load.

Shock absorption (Four-C)*

On cars equipped with Four-C, shock absorption is normally set for optimum comfort and is regulated continuously depending on the road surface, the car's acceleration, braking and cornering.

During parking^[1]

During parking, make sure you allow adequate space above and below the car since the car's ground clearance may vary e.g. depending on the outside temperature, how the car is loaded or the use of loading mode.







The level may also be adjusted some time after the car has been parked. This is to compensate for any changes in height that may occur due to temperature changes in the air springs when the car cools down.

During transport

During transport of the car on a ferry, train or truck, the car must be lashed around the tyres and not around other parts of the chassis. Changes in the level control may occur during transport, which could have a negative effect on the lashing.

Symbols and messages

If a fault arises with the level control, a message is shown in the driver display.

Symbol	Message	Specification
	Suspension Deactivated by user	The active self-levelling has been switched off manually by the user.
	Suspension Temporarily reduced performance	The performance of the active self-levelling has been temporarily reduced due to extensive system use.
	Suspension Service required	A fault has occurred. Visit a workshop ^[2] as soon as possible.
	Stop safely Suspension failure	A critical fault has occurred. The car's driving performance is significantly reduced, stop safely. Have the car towed to a workshop ^[2] if the message is shown when the car is stationary.
	Slow down Suspension Car too high	A fault has occurred. The car's driving performance is reduced, slow down until the symbol disappears. Contact a workshop ^[2] if the message is shown when the car is stationary.
	Suspension Auto adjusting car level	Level control of the car's rear axle to target height in progress.

* Option/accessory.

^[1] Applies to cars with air suspension

^[2] An authorised Volvo workshop is recommended.

11.16. Operational disruption

If you experience an operational disruption or deviation from the car's normal function then it may be due to a fault or the specific circumstances of the situation.

Some functions have limitations in particular situations and require that certain conditions are fulfilled in order to work. The driver display and centre display may show messages in order to inform about such a situation.

Find out more about fault-tracing and the limitations of various functions in related articles below.

If the car is not drivable

Activate the hazard warning flashers if the car has broken down or been forced to stop unexpectedly in a trafficked environment. Think about safety. If possible, move the car out of danger from traffic. Put on a reflective vest and then position the warning triangle so that other road users are warned in good time. Call roadside assistance if the cause cannot be remedied at your location.

11.17. Traffic accident

If your car is involved in a traffic accident, activate the hazard warning flashers and move the car into a safer position if possible.

Do not attempt to restart the car if there is a smell of fuel when the driver display shows the message **Safety mode See Owner's manual**. If so, leave the car at once!

Call the emergency services or roadside assistance as necessary.

Depending on the car's equipment, the car itself can detect an accident and contact the nearest emergency call centre. If the car does not have Volvo Assistance*, there is a European legal requirement, Pan-European eCall, that provides access to an automatic collision alarm and urgent assistance in emergency situations^[1].

- Think about safety when exiting the car!
- Use a reflective vest and position the warning triangle so that other road users are warned.

If you collide with a wild animal

Be careful, injured animals can feel trapped and then defend themselves.

Call the police to get help with humane killing if the animal is seriously injured, or move a dead animal away from the road so that it is not a danger to other road users.

* Option/accessory.

^[1] Applies to certain markets.

12. Sound, media and Internet

12.1. Radio

12.1.1. Radio *

It is possible to listen to both FM and DAB channels.



The radio can be operated via the centre display, the steering wheel keypad or voice control.



More radio apps can be downloaded from Google Play.

Linking between DAB and FM

The function makes it possible to change from an FM or DAB channel with poor or no reception to the same channel in another channel group (ensemble) with better reception, within DAB and/or between DAB and FM. DAB to DAB, DAB to FM and FM to DAB are all supported. Linking can be activated under Settings in the radio app.

Sorting

When DAB/FM linking is activated, the channel list only contains channels with good reception, and duplicates with poorer reception are removed, irrespective of whether it is an FM or DAB broadcast. When DAB/FM linking is not activated, DAB and FM channels are located in their own tabs.

Quick commands

When the app is used, it can also be controlled via quick commands in the home view.

Radio messages ^[1]

Different types of radio messages, e.g. traffic news and societally important information, can be set under settings in the radio app.

* Option/accessory.

^[1] Applies to certain markets.

12.1.2. Start radio *

The radio app can be started via the centre display or with voice control.

Starting from the centre display



Start the radio app from the home view ^[1] or app view .

2 Select the desired radio channel from the list of available radio channels, or from your favourites.

Starting with voice control

It is also possible to start FM radio using voice control by stating a frequency ^[2].

* Option/accessory.

^[1] The app can be accessed from the home view if it is one of the last apps used.

^[2] When using voice control, only FM frequencies can be stated, not names of radio channels.

12.1.3. RDS radio *

RDS (Radio Data System) means that the radio automatically changes to the strongest transmitter. RDS provides the ability to receive e.g. traffic information and to search for certain programme types.

RDS links FM transmitters into a network. An FM transmitter in such a network sends information that gives an RDS radio the following functions:

- Switch automatically to a stronger transmitter if reception in the area is poor.
- Search for programme category, e.g. programme types or traffic information.
- Receive text information on current radio programme.

 **Note**

Some radio stations do not use RDS or only selected parts of its functionality.

When broadcasting news or traffic messages, the radio can switch stations, interrupting the audio source currently in use. The radio returns to the previous audio source and volume when the set programme type is no longer broadcast.

* Option/accessory.

12.1.4. Setting radio favourites*

It is possible to add a radio channel to the list of radio favourites that are shown as a separate tab in the radio app.

Radio Favourites

To save radio channels to your list of favourites, proceed as follows:

- 1 Open the radio app from the home view or app view.
- 2 Tap on the star  next to the radio channel that you want to add to your list of radio favourites. The star is then filled in blue to confirm the selection.
 - The radio channel is added to your list of favourites.

DAB channels sort into alphabetical order from the top, followed by the FM channels sorted by frequency.

To delete a radio channel from your list of favourites, tap on the star again. The blue fill disappears to confirm that the radio channel has been deleted from the list of favourites.

It is also possible to select and deselect favourites via the Now playing view which is accessed by expanding the Now playing field to full screen mode.

* Option/accessory.

12.2. Media player

12.2.1. Bluetooth Media Player

If a phone or other device is connected to the car via Bluetooth, media from the devices can be played back in the Bluetooth Media Player.



Start the Bluetooth Media Player app from the home view or the app view . When the app is used, it can also be controlled via quick commands in the home view.

 **Note**

In order to stream media from a phone via Bluetooth, you must first start the Bluetooth Media Player.

Other third party apps for media playback can also be downloaded to the car.

Starting the Bluetooth Media Player via voice control

You can also control the media player using voice control.

12.3. Phone



12.3.1. Phone connection

12.3.1.1. Connecting a phone to the car

Connect a phone to the car with Bluetooth to make calls, send and receive messages, and play back media.

Search phone from car

Activate Bluetooth in the phone and check in the settings that the phone is visible to other devices.

- 1 If a phone is not already connected, tap on . Otherwise go to settings  at the bottom of the centre display and then tap on **Connectivity** and **Bluetooth**. If the phone is not already listed^[1], select **Pair new device**.
 - Available Bluetooth devices are listed. The list is updated as new devices are detected.
- 2 Tap on the name of the phone to be connected.
- 3 Check that the numerical code shown in the car matches the code in the phone and, if so, confirm.
- 4 On the phone, choose to accept or reject any options for phone contacts and messages.
 - The phone is connected for both media and telephony as standard^[2].
- 5 Press **Done**.

 **Note**

- The message function must be activated in certain phones.
- If contacts and messages are not shown in the car despite activation of the function, disconnect the phone and then reconnect it.
- Not all phones are fully compatible and may therefore not show contacts and messages in the car.

 **Note**

If the phone's operating system is updated then the connection may be broken. In which case, delete the phone from the car and then connect again.

^[1] The phones previously connected are directly visible under Bluetooth and can then be selected from there.

^[2] Later, it will be possible to choose which device should be used for telephony and/or media, such as if a passenger wants to use his/her phone as media device to play back music.

12.3.1.2. Disconnecting a Bluetooth-connected phone

It is possible to disconnect a phone connected to Bluetooth, and it will then no longer be connected to the car.

- When the phone is out of range of the car it is automatically disconnected. If disconnection occurs during an active call, then the call will be continued on the phone.
- It is also possible to disconnect the phone by manually deactivating Bluetooth.

Disconnecting via the centre display

- 1 Tap on  at the bottom of the display.
 - 2 Press **Connectivity**.
 - 3 Under **Bluetooth**, tap on the row with the phone's name to disconnect both telephony and media.
- The phone is no longer connected to the car.

It is also possible to select whether the phone should be connected as only phone or media device by tapping on the respective icon.

12.3.1.3. Switch between Bluetooth-connected phones

It is possible to switch between a number of Bluetooth-connected phones.

You can do this by opening the phone app and pressing .

It is also possible to change between phones as follows:

- 1 Tap on  at the bottom of the display.
- 2 Press **Connectivity**.
- 3 Under **Bluetooth**, tap on the name of the phone to be connected.
- 4 Select whether it should be used for both telephony and media.

12.3.1.4. Removing devices connected to Bluetooth

It is possible to remove phones from the list of registered Bluetooth devices, for example.

- 1 Tap on  at the bottom of the display.
 - 2 Press **Connectivity**.
 - 3 Under **Bluetooth**, tap on the arrow after the phone's name.
 - 4 Press **Forget device**.
- > The phone is no longer registered to the car.

12.3.2. Apple CarPlay

12.3.2.1. Apple[®] CarPlay[®] *



CarPlay^[1] gives you the option to listen to music, make phone calls, get directions, send/receive messages and use Siri[®], all while you stay focused on your driving.

CarPlay works with selected iPhone[®] [2] models. If the car does not already have support for CarPlay then it is possible to install it afterwards. Contact a Volvo dealer to install CarPlay.

Information about which apps are supported and which iPhone models are compatible is available on Apple's website: www.apple.com/ios/carplay/ [https://www.apple.com/ios/carplay/]. Please note that Volvo does not accept responsibility for the content of CarPlay.

When using map navigation via CarPlay, directions are shown in the driver display. A route description must be active for the map to be displayed.

When navigation is started through Apple CarPlay, ongoing native turn-by-turn route guidance will be ended.

The CarPlay apps can be controlled via the centre display, your iPhone or with the steering wheel's right-hand keypad. The apps can be voice-controlled using Siri. A long press on the steering wheel button  starts voice control using Siri and a short press activates the car's own voice control. If Siri breaks off too early, hold the steering wheel button  depressed.

* Option/accessory.

[1] Availability may vary depending on market.

[2] Apple, CarPlay, iPhone and Siri are registered trademarks owned by Apple Inc.

12.3.2.2. Using Apple[®] CarPlay[®] *

To use CarPlay [1], Siri[®] voice control must be activated in your iPhone[®] [2]. The device also needs an Internet connection for all functions to work.

Connect an iPhone and start CarPlay

Note

CarPlay can only be used if Bluetooth is deactivated in the car. A phone or media player connected to the car via Bluetooth will therefore not be available when CarPlay is active.

- 1 Connect an iPhone with support for CarPlay to the USB port with a white frame [3]. If CarPlay has been used from the phone previously then CarPlay is opened automatically.
- 2 If it is the first time that the phone is connected, read and accept the conditions for connection.
 - > CarPlay opens and compatible apps are shown.
- 3 Tap on the desired app.
 - > The app starts.

CarPlay runs in the background if another app is started. To show CarPlay again – tap on the CarPlay app in the app view.

* Option/accessory.

[1] Availability may vary depending on market.

[2] Apple, CarPlay, iPhone and Siri are registered trademarks owned by Apple Inc.

[3] A USB-C to lightning cable is required.

12.3.2.3. Tips for using Apple[®] CarPlay[®] *

Here are some useful tips for using CarPlay[®] [1].

- Update your iPhone[®] [2] with the latest version of the iOS operating system and ensure that the apps have been updated.
- In the event of a problem with CarPlay, disconnect your iPhone from the USB port and reconnect. Otherwise, try to close the app on the device that is not working and then restart the app, or try closing all apps and restart your device.
- Using Siri[®] it is possible to write/dictate and read out messages. Messages are read out and dictated in the language selected in the settings for Siri. When you write/dictate messages, no text will be shown in the centre display, but the text is shown in your iPhone.
- If the device is connected to the car via Bluetooth, the connection will be interrupted when CarPlay is used.
- CarPlay only works with iPhone.

Note

Availability and functionality may vary depending on market.

* Option/accessory.

[1] Availability may vary depending on market.

[2] Apple, CarPlay, iPhone and Siri are registered trademarks owned by Apple Inc.

12.3.3. Android Auto

12.3.3.1. Android Auto[®] *

Android Auto[®] [1] gives you the option to listen to music, make phone calls, get directions and use car-adapted apps from an Android device [2]. Android Auto works with selected Android devices.

Information about which apps are supported and which Android devices are compatible is available at:



www.android.com/auto/ [<https://www.android.com/auto/>]. For third-party apps, see Google Play. Note that Volvo is not re-

The content of this manual represents the status of the user manual at the time of printing and may not be completely valid in future instances. For more information, refer to the first page for the complete disclaimer note.

sponsible for the content in Android Auto.

When using map navigation via Android Auto, directions are shown in the driver display. A route description must be active for the map to be displayed.

When navigation is started through Apple Android Auto, ongoing native turn-by-turn route guidance will be ended.

The Android Auto apps can be controlled via the centre display, your Android device or with the steering wheel's right-hand keypad. The apps can be voice controlled using Google Assistant. A long press on the steering wheel button  starts voice control using Android Auto and a short press activates the car's own voice control. If Android Auto is broken off too early, hold the steering wheel button  depressed.

* Option/accessory.

^[1] Availability may vary depending on market.

^[2] Google[®], Android[®], Android Auto[®] and Google Assistant are registered trademarks of Google.

12.3.3.2. Using Android Auto[®] *

To use the Android Auto[®] ^[1] app, the app must be installed on the Android[®] device. The device also needs an Internet connection for all functions to work.

Connect an Android device and start Android Auto

- 1 Connect an Android device with support for Android Auto to the USB port with a white frame ^[2]. If Android Auto has been used from the phone previously then Android Auto is opened automatically.
- 2 If it is the first time that the phone is connected, read and accept the conditions for connection.
 - Android Auto opens and compatible apps are shown.
- 3 Tap on the desired app.
 - The app starts.

Android Auto runs in the background if another app is started. To show Android Auto again, tap on the Android Auto app in the app view.

* Option/accessory.

^[1] Availability may vary depending on market.

^[2] A USB-C to lightning cable is required.

12.3.3.3. Tips for using Android Auto[®] *

Here are some useful tips for using Android Auto[®] [1].

- Update your Android[®] [2] with the latest version of the Android operating system and ensure that the apps have been updated.
- In the event of a problem with Android Auto, disconnect your Android device from the USB port and reconnect it. Otherwise, try to close the app on the device that is not working and then restart the app, or try closing all apps and restart your device.
- Using Google Assistant it is possible to write, dictate or have messages read out loud.
- Android Auto only works with Android devices.

Note

Availability and functionality may vary depending on market.



* Option/accessory.

[1] Availability may vary depending on market.

[2] Google[®], Android[®], Android Auto[®] and Google Assistant are registered trademarks of Google.

12.3.4. Connecting to the Internet via Bluetooth

Create an Internet connection via Bluetooth by sharing a phone's Internet access.

- 1 Make sure that your phone supports tethering and that this function is activated.
 - 2 Connect your phone to the car via Bluetooth. Go to settings  at the bottom of the centre display and then tap on **Connectivity** and select **Bluetooth**.
 - 3 If the phone has been connected previously, tap on  for the phone you want to use. Otherwise, first select **Pair new device**.
 - 4 Approve, via the message shown, that the connection should take place.
- > The car is connected to the Internet.

Note

The telephone and network provider must support tethering (internet connection sharing), and the subscription must include data.

12.3.5. Phone

A phone with Bluetooth can be connected wirelessly to the car.

When a phone has been connected and linked to the car as a phone device, it can be used make calls, send/receive messages, and play back media wirelessly.

The phone is operated from the centre display, but also partly via voice control.

12.3.6. Managing contacts

When a phone is connected to the car, contacts can be managed directly in the centre display.

When a phone is connected to the car using Bluetooth and is selected as phone device, contacts are shown in the phone app under their own tab.

Before the contacts are shown in the car, sharing of contacts must be accepted in the phone.

Browse through your contacts by swiping up or down.

It is possible to show the phone's favourites in the car.^[1]

The contacts are not shown

It may take a while before the contacts are loaded. If they are still not shown after a while, try disconnecting and reconnecting the phone.

 **Note**



Not all phones are fully compatible with the car. In such cases, contacts cannot be displayed in the car.

^[1] Some phones cannot synch favourites. In which case, it is possible to manually add favourites in the car.

12.3.7. Managing phone calls

It is possible to make and receive calls when the phone is connected to the car via Bluetooth. The phone must be connected as phone device.



Making a call from the phone app

- 1 Open the phone app from the home view or app view .
- 2 Choose a contact from **Favourites**, **Recents** or **Contacts**. Alternatively, enter a telephone number using the keypad.
- 3 Tap on the contact to make a call.
- 4 Tap on  to end the call.

You can also make calls using voice control.

Receiving a call

Incoming phone calls are shown and managed via the centre display.

- 1 Tap on  or  to answer or decline a phone call.
- 2 Tap on  to end the call.

Receiving a new call during a current call

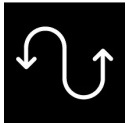

If a new call comes in during a current call, the new call can be answered via the centre display. The original call is parked when the new call is answered. Switch between the calls by tapping on the symbols that represent them.

Switching off the microphone



Tap on the microphone symbol to switch off the microphone. The person on the call will not hear what is being said in the car.

Toggling between car and phone speakers

Tap on **CarPhone** to toggle the sound between the speakers in the car and the phone speaker.

Using the keypad during a current call

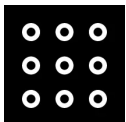

If the keypad needs to be used during a current call, it can be opened by tapping on its symbol in the centre display. To exit the keypad view and return to call view, tap on the same symbol again.

Missed calls

Missed calls are shown in the home view where it is also possible to call back. Missed calls are also shown in the notification view at the top of the centre display.

12.3.8. Managing text messages

It is possible to receive and send text messages, in the form of SMS, when the phone is connected to the car.

To be able to manage text messages in the car, the phone must be connected via Bluetooth^[1] as phone device and the user must have approved in the phone's Bluetooth settings that notifications should be shown.

Sending text messages

You can dictate a new message by asking the voice control system to send a message to a named contact or a phone number.

Receiving text messages

When the phone is connected to the car, a notification is shown at the top of the centre display when a new text message is received. Choose whether to play back the message by tapping on the screen or using voice control.

It is also possible to choose to mute the conversation. In which case, no more notifications for the conversation are shown while driving.

Replying to text messages

When a text message has been read out, it is possible to dictate a reply^[2]. Follow the instructions given by the voice control system.

Text messages are not shown

If new text messages are shown on the phone but not in the centre display, try disconnecting and reconnecting the phone.

^[1] Text messages can only be managed in the car if the phone is compatible.

^[2] Only applies to phones with Android or iOS 13 or later.

12.3.9. Using a wireless charger*

On the rubber panel in the tunnel console, there is a wireless charger that supports wireless charging of Qi-certified or Qi-compatible units, e.g. a phone.



To charge the unit, it must support wireless charging and it must be Qi-certified or Qi-compatible. Contact the manufacturer of your unit to find out if it is Qi-certified.

 **Warning**

Wireless charging can affect the operation of an implanted pacemaker or other medical devices. If you have one, it is recommended to consult with your doctor before using the wireless charging system.



Wireless charger in the tunnel console.

Activating and deactivating the wireless charger

The wireless charger can be activated and deactivated from the centre display. The default mode is that the charger is not activated.

- 1 Go to settings  at the bottom of the centre display and then tap on **Controls**.
- 2 Select to activate or deactivate the wireless charger.
- 3 Confirm that the charger is to be activated.

Use the wireless charger

- 1 Check that the charger is activated.
 - 2 Remove all other objects from the charger.
 - 3 Place the unit to be charged in the middle of the charger.
- The unit starts to charge and the  symbol is shown at the top of the centre display.

 **Important**

Avoid storing cards or other objects with NFC (Near Field Communication), e.g. bank cards for contactless payment, with the unit to be charged. It can damage these types of objects and interfere with the charging.

 **Note**

- The charging process may vary depending on the type of unit to be charged. For example, the time before charging starts or before the unit is fully charged can vary.
- Units may become hot during charging. This is normal.

If the unit does not charge:

- Check in the centre display that the charger is activated.
- Check that the charger is free from other objects.
- Check that the unit supports wireless charging (Qi).
- Lift the unit and place it back in the middle of the charger.
- Remove any shell or protector that may be on the unit.
- Check that the car is running.
- Check that the unit has not slid off the charger while driving.
- If any of the doors are opened, charging is interrupted for several seconds.
- If the unit's temperature becomes too high during charging the charging function is deactivated.
- Inactivate the function for NFC (Near Field Communication) if the unit has one.

If an object on the charger is preventing charging, a message is shown on the centre display.

 **Important**





Keep the unit and charger free of other objects while charging to avoid overheating.



* Option/accessory.

12.3.10. Certificate for wireless charger

Country/Area	
Argentina:	
Brazil:	

The content of this manual represents the status of the user manual at the time of printing and may not be completely valid in future instances. For more information, refer to the first page for the complete disclaimer note.

Country/Area	
Canada:	<p>This device contains licence-exempt transmitter(s)/receiver(s) that comply with Innovation, Science and Economic Development Canada's licence-exempt RSS(s). Operation is subject to the following two conditions:</p> <p>(1) This device may not cause interference; and</p> <p>(2) This device must accept any interference, including interference that may cause undesired operation of the device.</p> <p>L'émetteur/récepteur exempt de licence contenu dans le présent appareil est conforme aux CNR d'Innovation, Sciences et Développement économique Canada applicables aux appareils radio exempts de licence. L'exploitation est autorisée aux deux conditions suivantes:</p> <p>(1) L'appareil ne doit pas produire de brouillage;</p> <p>(2) L'appareil doit accepter tout brouillage radioélectrique subi, même si le brouillage est susceptible d'en compromettre le fonctionnement.</p> <p>This equipment complies with radio frequency exposure limits set forth by the Innovation, Science and Economic Development Canada for an uncontrolled environment.</p> <p>This equipment should be installed and operated with a minimum distance of 20 cm between the device and the user or bystanders.</p> <p>This device must not be co-located or operating in conjunction with any other antenna or transmitter.</p> <p>Cet équipement est conforme aux limites d'exposition aux radiofréquences définies par la Innovation, Sciences et Développement économique Canada pour un environnement non contrôlé.</p> <p>Cet équipement doit être installé et utilisé avec un minimum de 20 cm de distance entre le dispositif et l'utilisateur ou des tiers.</p> <p>Ce dispositif ne doit pas être utilisé à proximité d'une autre antenne ou d'un autre émetteur.</p>
Indonesia:	
Israel:	<div style="border: 1px solid black; padding: 10px; text-align: center;"> <p>מספר אישור התאמה מטעם משרד התקשורת: 51-90830</p> <p>חל איסור לבצע פעולות במכשיר שיש בהן כדי לשנות את תכונותיו האלחוטיות של המכשיר, ובכלל זה שינויי תוכנה, החלפת אנטנה מקורית או הוספת אפשרות לחיבור לאנטנה חיצונית, בלא קבלת אישור משרד התקשורת, בשל החשש להפרעות אלחוטיות.</p> </div>
Philippines:	ESD-RCE-2231876
Taiwan:	 <p>NCC [?] / NCC statement: [?]</p>
Thailand:	 <p>[?]</p> 
The United Arab Emirates:	

Country/Area	
USA:	<p>FCC Statement:</p> <p>This device complies with Part 15 of the FCC rules. Operation is subject to the following two conditions:</p> <p>(1) This device may not cause harmful interference, and</p> <p>(2) This device must accept any interference received, including interference that may cause undesired operation.</p> <p>Please note that changes or modifications not expressly approved by the party responsible for compliance could void the user's authority to operate the equipment.</p> <p>This equipment has been tested and found to comply with the limits for a Class B digital device, pursuant to part 15 of the FCC Rules. These limits are designed to provide reasonable protection against harmful interference in a residential installation. This equipment generates, uses and can radiate radio frequency energy and, if not installed and used in accordance with the instructions, may cause harmful interference to radio communications. However, there is no guarantee that interference will not occur in a particular installation. If this equipment does cause harmful interference to radio or television reception, which can be determined by turning the equipment off and on, the user is encouraged to try to correct the interference by one or more of the following measures:</p> <ul style="list-style-type: none"> — Reorient or relocate the receiving antenna. — Increase the separation between the equipment and receiver. — Connect the equipment into an outlet on a circuit different from that to which the receiver is connected. — Consult the dealer or an experienced radio/TV technician for help. <p>This equipment complies with radio frequency exposure limits set forth by the FCC for an uncontrolled environment.</p> <p>This equipment should be installed and operated with a minimum distance of 20 cm between the device and the user or bystanders.</p> <p>This device must not be co-located or operating in conjunction with any other antenna or transmitter.</p>
Vietnam:	
Zambia:	

12.4. Apps

12.4.1. Apps

The app view provides access to the car's pre-installed and downloaded apps.

Tap on the app view icon  at the bottom of the centre display to access the app view and start the radio*, navigation system and phone^[1], for example.



Some basic apps are always available. More apps such as web radio and music services can be downloaded when the car is connected to the Internet.

Certain apps are only available for use if the car is connected to the Internet.

All the apps used should be updated to the latest version. This gives access to the latest updates and functions.

Apps close down

If an app closes down unexpectedly, try the following:

- open the app again
- check whether an update is available for the app:
 - Open the app view  and tap on Google Play. Tap on  and select your apps to see if any of them need to be updated. If so, update to the latest version.

The content of this manual represents the status of the user manual at the time of printing and may not be completely valid in future instances. For more information, refer to the first page for the complete disclaimer note.

- restart the system with a long press (approximately 20 seconds) on the home button
- uninstall and reinstall the app.

* Option/accessory.

^[1] The last apps used can always be accessed from the home view.

12.4.2. Downloading apps

New apps can be downloaded and installed when the car is connected to the Internet.



Google Play offers a range of different apps suitable for use in the car.

The car must be stationary in order to download apps, that is, it must be in the Comfort usage mode.

- 1 Open app view .
- 2 Press Google Play.
 - A Google account must be linked to the current user profile in order for Google Play to open.
- 3 Search for the app ^[1] you want, then select it.
- 4 Press **Install**.
- 5 Follow the on-screen instructions to complete the installation.

Note

Sometimes the app needs access to different functions such as address book or positioning in order for the app to work as intended. In which case, a prompt to authorise this will be shown.

^[1] Only car-adapted apps are available.

12.4.3. Deleting apps

There are different options for uninstalling apps ^[1].

Uninstalling apps via the app view

- 1 Open app view .
- 2 Tap on and hold down the app to be deleted so that a wastepaper basket is displayed at the bottom.
- 3 Drag the app to the wastepaper basket, then release it.
- 4 Confirm the deletion.

Uninstalling apps via Settings

- 1 Go to Settings  at the bottom of the centre display.
- 2 Select **Privacy**.
- 3 Go to **Applications**.
- 4 Choose to show all installed apps and then select the app to be uninstalled.
- 5 Select to uninstall the app and confirm the removal.

Note

If the app to be removed is alone in the tile, it must be uninstalled via Settings.

* Option/accessory.

^[1] Apps provided with the car, so-called basic apps, cannot be uninstalled. For example, the phone or radio* apps.

12.4.4. Volvo ID

Volvo ID is a personal ID that gives access to a wide range of services via a single username and password.

One example of a service when Volvo ID is needed is when checking the car on your phone using the Volvo Cars app.

Volvo ID is created from the car, volvoid.eu.volvocars.com/Account [https://volvoid.eu.volvocars.com/Account/] or the Volvo Cars app.

 **Note**

The services available may vary over time and depend on equipment level and market.

12.4.5. Creating a Volvo ID

A Volvo ID needs to be created in order to use the Volvo services connected to the car, e.g. via the Volvo Cars app.

Create a Volvo ID with the Volvo Cars app

- 1 Download the latest version of the Volvo Cars app^[1] to the phone.
 - 2 Select to create Volvo ID.
 - 3 The web page for creating a Volvo ID is shown.
 - 4 Enter a personal email address or mobile number.
 - 5 Follow the instructions that are automatically sent to the specified email address/mobile number.
- A Volvo ID has now been created and is ready for use.

Create a Volvo ID via the Volvo Cars website

- 1 Go to volvoid.eu.volvocars.com/Account [<https://volvoid.eu.volvocars.com/Account/>]. Select to create a Volvo ID.
 - 2 Enter a personal email address or mobile number.
 - 3 Follow the instructions that are automatically sent to the specified email address/mobile number.
- A Volvo ID has now been created and is ready for use.

^[1] Available to download via e.g. Apple App Store or Google Play.

12.5. Internet connection

12.5.1. Online services

12.5.1.1. Connected Safety

Connected Safety^[1] communicates information between your own car and other vehicles via a cloud service^[2]. The function is intended to make a driver aware that there may be a potentially dangerous traffic situation further ahead on the same road.

The function can inform the driver whether another vehicle further ahead on the same road has activated its hazard warning flashers or detected slippery driving conditions. Information about slippery driving conditions is also given if your car detects slippery driving conditions.

Connected Safety can help the driver with the following:

- Alarm on hazard warning flashers
- Alarm on slippery driving conditions

Connected Safety communication between vehicles only works for vehicles equipped with the function. Connected Safety also needs to be actively approved via **Volvo privacy settings**.

Alarm on hazard warning flashers

If hazard warning flashers are activated on your vehicle, this information can be sent to other vehicles approaching your vehicle's position.



When your vehicle is approaching a vehicle with flashing hazard warning flashers, this symbol is shown on the driver display.

In vehicles with head-up display, the warning symbols for Connected Safety are also shown there.

Alarm on slippery driving conditions



If your vehicle detects a deterioration in friction between the tyres and the road surface, this symbol appears in the driver display. The information can then be sent to vehicles approaching your vehicle's position.



If your vehicle receives information about slippery road conditions from another vehicle, this symbol appears in the driver display.

In vehicles with head-up display, the warning symbols for Connected Safety are also shown there.

 **Warning**

- The function is supplementary driver support intended to facilitate driving and make it safer – it cannot handle all situations in all traffic, weather and road conditions.
- The driver is advised to read all sections in the Owner's Manual that relate to this function to learn about factors such as its limitations and what the driver should be aware of before using the system.
- Driver support functions are not a substitute for the driver's attention and judgement. The driver is always responsible for ensuring the car is driven in a safe manner, at the appropriate speed, with an appropriate distance to other vehicles, and in accordance with current traffic rules and regulations.

^[1] Not available on all markets.

^[2] Data is transferred (data traffic) when using the cloud service, and this may involve a cost.

12.5.1.2. Apps

The app view provides access to the car's pre-installed and downloaded apps.

Tap on the app view icon  at the bottom of the centre display to access the app view and start the radio*, navigation system and phone^[1], for example.



Some basic apps are always available. More apps such as web radio and music services can be downloaded when the car is connected to the Internet.

Certain apps are only available for use if the car is connected to the Internet.

All the apps used should be updated to the latest version. This gives access to the latest updates and functions.

Apps close down

If an app closes down unexpectedly, try the following:

- open the app again
- check whether an update is available for the app:
 - Open the app view  and tap on Google Play. Tap on  and select your apps to see if any of them need to be updated. If so, update to the latest version.
- restart the system with a long press (approximately 20 seconds) on the home button
- uninstall and reinstall the app.

* Option/accessory.

^[1] The last apps used can always be accessed from the home view.

12.5.1.3. Volvo ID

Volvo ID is a personal ID that gives access to a wide range of services via a single username and password.

One example of a service when Volvo ID is needed is when checking the car on your phone using the Volvo Cars app.

Volvo ID is created from the car, volvoid.eu.volvocars.com/Account [https://volvoid.eu.volvocars.com/Account/] or the Volvo Cars app.

Note

The services available may vary over time and depend on equipment level and market.

12.5.1.4. Creating a Volvo ID

A Volvo ID needs to be created in order to use the Volvo services connected to the car, e.g. via the Volvo Cars app.

Create a Volvo ID with the Volvo Cars app

- 1 Download the latest version of the Volvo Cars app^[1] to the phone.
 - 2 Select to create Volvo ID.
 - 3 The web page for creating a Volvo ID is shown.
 - 4 Enter a personal email address or mobile number.
 - 5 Follow the instructions that are automatically sent to the specified email address/mobile number.
- A Volvo ID has now been created and is ready for use.



Create a Volvo ID via the Volvo Cars website

- 1 Go to volvoid.eu.volvocars.com/Account [https://volvoid.eu.volvocars.com/Account/]. Select to create a Volvo ID.
 - 2 Enter a personal email address or mobile number.
 - 3 Follow the instructions that are automatically sent to the specified email address/mobile number.
- A Volvo ID has now been created and is ready for use.

^[1] Available to download via e.g. Apple App Store or Google Play.

12.5.2. Connecting to the Internet via Bluetooth

Create an Internet connection via Bluetooth by sharing a phone's Internet access.

- 1 Make sure that your phone supports tethering and that this function is activated.
 - 2 Connect your phone to the car via Bluetooth. Go to settings  at the bottom of the centre display and then tap on **Connectivity** and select **Bluetooth**.
 - 3 If the phone has been connected previously, tap on  for the phone you want to use. Otherwise, first select **Pair new device**.
 - 4 Approve, via the message shown, that the connection should take place.
- > The car is connected to the Internet.

Note

The telephone and network provider must support tethering (internet connection sharing), and the subscription must include data.

12.5.3. Internet connection

When the car is connected to the Internet, you can listen to Internet radio and music services via apps, for example.





The car can be connected to the Internet via a Bluetooth connected telephone or a Wi-Fi network. For certain markets, the car can also be connected via the car's built-in modem ^[1]. If the car is connected to the internet via several different sources at the same time, the connection is firstly via Wi-Fi; secondly via Bluetooth-connected phone; and lastly via the car's built-in modem.

^[1] Certain markets require the terms and conditions to be accepted for internet connection via modem.



12.5.4. Problems with Internet connection

Internet connection status is shown in the upper left-hand corner of the centre display. The appearance of the symbol may vary in different situations.

Symbol for connection

	The car has full connection.
	The car has a connection to the mobile network but cannot establish a working internet connection.
	The car is connected to the mobile network but the internet connection is limited.
	The car does not have a connection to the mobile network or the internet.

If the car loses its Internet connection.

- **Switching the mobile data off and on** - If the car's internet connection suddenly disappears for no apparent reason, it may help to switch mobile data off and on.
 1. Go to settings  at the bottom of the centre display and then tap on **Connectivity**.
 2. Switch **Car SIM data**, **Wi-Fi** and **Bluetooth** off and then back on to restart the connection.
- **Restart the system** – Restart the system by holding down the home button depressed for 20 seconds.
- **Restart the modem** – Restart the car's modem by holding the Max defroster  button depressed for 20 seconds.

Note



It can take up to two minutes for the internet connection to be restored after the modem has been restarted.

Warning

When the car's modem is restarted, the function for automatic collision alarm may be deactivated, so the car should be parked during restart.

Check there is consent to connect to the internet

Internet connection requires consent to work. Check that this setting has been saved correctly.

- 1 Connect the car to the internet by connecting to an external Wi-Fi network, for example by tethering from a mobile phone.
- 2 Go to the app view  and then open settings .
- 3 Select **Privacy and data sharing** and then **Internet terms of service**. Wait until the supplier's page is displayed.
- 4 Go back to settings  and select **Network and internet**.

- 5 Switch **Wi-Fi** off and check that **Car SIM data** is switched on.
- 6 Go back to settings , select **Privacy and data sharing** again and then **Internet terms of service**.
- 7 Agree to the terms of use.

In the event of problems with connection via Bluetooth-connected phone

If you experience difficulties when connecting a phone to the car via Bluetooth

- Check that the phone battery is sufficiently charged and that the phone is switched on.
- Check that you have Bluetooth switched on in both the phone and the car.
- Check that you have established a Bluetooth connection and have connected the car to the phone to be used.
- If possible, try to connect another phone to the car via Bluetooth in order to check whether the problem is in the device or in the car.

If the problem persists:

1. Clear all previously added phones in the Bluetooth settings in the car.
2. Restart the phone you want to connect.
3. Try to connect the phone again.

In the event of problems with connection via the car's built-in modem ^[1]

If connection via the car's built-in modem works poorly due to poor coverage, for example, try connecting via Wi-Fi networks or Bluetooth-connected phone instead.

Note

If you connect to the Internet through several different sources at the same time, such as if the car has Internet via built-in modem, and you access the Internet via a Bluetooth-connected phone, these sources are used in the following order of priority. Firstly, connection via Wi-Fi networks is used; secondly, via a Bluetooth-connected phone; and thirdly, via the car's built-in modem.

^[1] Connection via the built-in modem is only available in certain markets.

12.5.5. Connecting to the Internet via Wi-Fi

The car can be connected to a Wi-Fi network if required.

If the car is, for example, parked outside a house with a Wi-Fi network, or if you share the Internet via a mobile phone, it is possible to connect the car to the network.

If you share the Internet via the mobile phone, remember to first enable internet sharing on the phone.

To connect the car to a Wi-Fi network:

- 1 Go to settings  at the bottom of the centre display and then tap on **Connectivity**.
- 2 Tap on the row for **Wi-Fi** in order to show a list of available networks. Not all networks are allowed to connect. If the network you want to connect is not on the list of available networks, see the following details.
- 3 Select the desired network, enter the password and connect.

 **Note**

These are the identified requirements for making the Wi-Fi access points available for use with Android:

- WPA2 with password (CCMP).
 - A password is required.
- Not allowed/possible:
 - Network without encryption (open network).
 - WPA3.
 - WEP.
 - WPA (with TKIP).
 - WPS (Wi-Fi Protected Setup) enabled routers. Also possible with a WPA2 connection (most home routers are WPS enabled). If your home router has WPS functionality enabled, it will not be available due to limited security when managing WPS access. To connect to a WPA2 network with WPS, disable WPS on the router.

12.5.6. Markets with Car Modem Internet

Listed here are the markets that provide Internet via the built-in car modem.

The markets listed offer Internet via the car's built-in modem for 4 years^[1] from the date of purchase of the car. Data roaming works within the EU.

Country
Australia
Austria
Belgium
Canada
China
Czech Republic
Denmark

Country
Finland
France
Germany
Greece
Hong Kong
Hungary
Iceland
India
Indonesia
Ireland
Israel
Italy
Japan
Korea
Luxembourg
Malaysia
Mexico
Netherlands
New Zealand
Norway
Poland
Portugal
Puerto Rico
Romania
Singapore
Slovakia
Spain
Sweden
Switzerland
Taiwan ^[2]
Thailand ^[2]
Turkey
UK
USA

^[1] The time may vary depending on market and car model.

^[2] The 2022 and 2023 EX40 models and the 2023 EC40 model come with free connected services for 4 years. For other car models, connected services are free for 1 year.

12.6. Audio and media

The car's audio system takes account of, for example, the position of the listener and the speed of the car. The centre display provides access to radio* and music apps, and additional third-party apps in music and media can be downloaded via Google Play.

Connect a phone or other device via Bluetooth. Choose whether you want it as a media device to play back music and/or as a phone device to, for example, make calls and show contacts.



USB-ports for charging devices.

Control the functions with your voice, steering wheel keypad or the centre display.

Use the USB ports to charge devices.

* Option/accessory.

12.7. Storage space on hard disk

It is possible to view how much free space there is on the car's hard disk.

Check available space by means of the following:

- 1 Tap on settings  at the bottom of the display.
- 2 Select **System**.
- 3 Continue to **Storage**.

12.8. Sound settings

The sound reproduction quality is preset, but can be adjusted as well.

Volume

The volume is normally adjusted using the volume control underneath the centre display or with the right-hand steering wheel keypad. This applies, for example, during playback of music, radio*, ongoing phone calls and active traffic messages.

When adjusting the volume, an expandable menu opens in the centre display. The volume for incoming calls, notifications and media player, for example, can be changed here.

For more sound settings, go to settings  and tap on **Sound**.

Sound reproduction

The sound system is pre-calibrated by means of digital signal processing. This calibration takes into account speakers, amplifiers, passenger compartment acoustics, listener position, etc. There is also dynamic calibration that takes into account the position of the volume control and the speed of the car.

* Option/accessory.

12.9. Media playback

Regardless of the media app used, a Now playing field is shown in the centre display.

Among other things, it is possible to pause and change track in the Now playing field. Additional settings are possible if the Now playing field is expanded to full screen mode.

Opening the Now Playing view

Tap on the arrow in the Now Playing field to expand the field to the Now Playing view. This view gives access to more settings, which may vary depending on the type of app being used. Minimise the Now playing view by tapping on the arrow again.

12.10. Online connectivity and entertainment

The car has an intelligent interface and offers online connectivity with the digital world. An intuitive navigation structure makes it possible to receive relevant support, information and entertainment when it is necessary.

It covers all solutions in the car that are connected with entertainment, online connectivity, navigation and the user interface between driver and car.

Fair Use Policy

Your use of connectivity services that is part of your vehicle is subject to this Fair Use Policy.

The content of this manual represents the status of the user manual at the time of printing and may not be completely valid in future instances. For more information, refer to the first page for the complete disclaimer note.

When using this Service you agree not to

- submit content that is unlawful, obscene, libellous, threatening, harassing, hateful, racially or ethnically offensive or otherwise inappropriate
- use the Service in breach of any applicable law
- use the Service for commercial purposes.

Your access to the Service is part of a shared access. Volvo reserves the right to suspend your access to or use of the Service if your use involves very high volumes of data, disproportionate to other users. Volvo may also suspend your access for technical reasons or to protect other functions of your vehicle. Your access to connectivity services is covered by third party terms and conditions from the mobile network service provider.

Information when it is needed, where it is needed

The different displays in the car provide information at the right time. The information is shown in different locations based on how it should be prioritised by the driver.

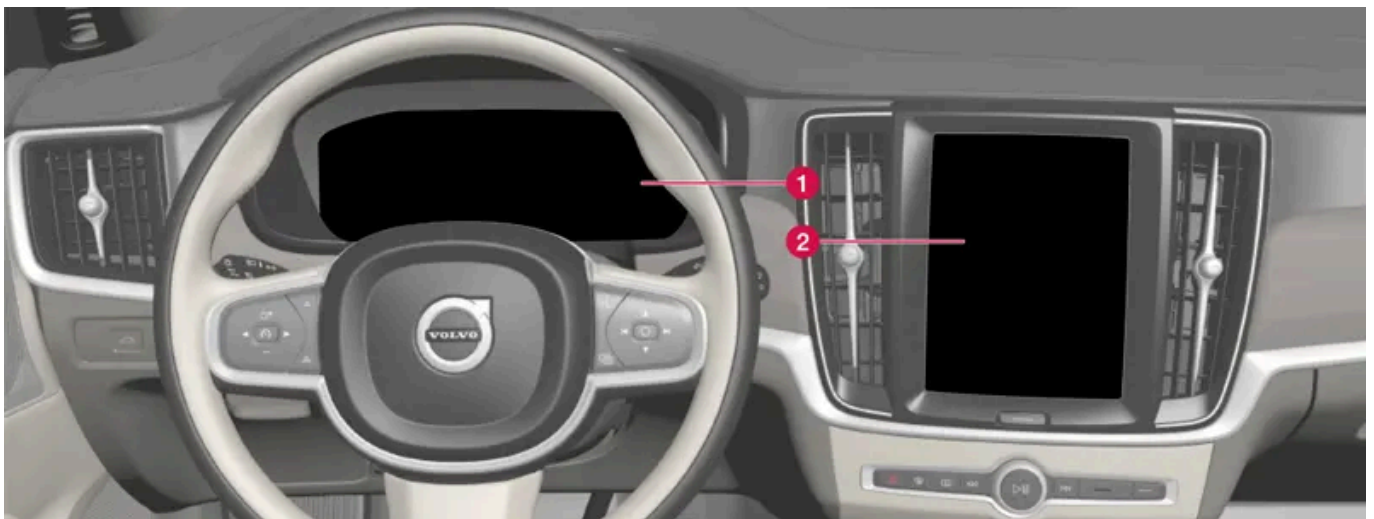

Different types of information are shown in different displays depending on how the information should be prioritised.

- 1 The driver display shows information on speed, road sign information, warning and indicator symbols, and information on the battery, for example. The driver display can also show incoming calls or information on what song tracks are being played back. The display is operated via the two steering wheel keypads.
- 2 Many of the car's primary functions are controlled from the centre display, e.g. the climate control system, the entertainment system and the seat position. The centre display also shows information on navigation and road sign information, for example. The information that is shown in the centre display can be acted on by the driver or someone else in the car when the opportunity arises.

Note

Wearing gloves may limit or prevent touch screen response.

Head-up display*



The head-up display shows selected information that the driver should deal with as soon as possible. Such information may, for example, include traffic warnings, speed information and navigation information. Road Sign Information and incoming phone calls are also shown in the head-up display. The display is operated via the right-hand steering wheel keypad and via the centre display.

Voice control system

The voice control system can be used without the driver needing to take his/her hands off the steering wheel. The system can understand natural speech. Use voice control to, for example, play back a song, call someone, increase the temperature or read out a text message.

* Option/accessory.

12.11. Approval of terms and conditions and data collection

Messages about different terms and conditions and data collection can be shown in the centre display. Collection of data takes place to provide better car, safety and app functions, for example.

The first time you use your car, a guide opens in the centre display to assist you to make various settings. In connection with the guide, you are also prompted to give your agreement to different types of terms and conditions and the collection of information.

Prompts to give consent can also be shown in the event of, for example:

- First-time use of apps and services
- New user profiles
- Logging out from and deleting user profiles
- Change of ownership
- Resetting the settings

To access privacy settings:

- 1 Press  in the centre display.
- 2 Then press on **Privacy**.
- 3 Then select **Volvo privacy settings**, **Data sharing with Google** or **Legal information from Google**.

Some settings can only be made from a profile with administrative privileges.

Accept the internet terms of use^[1]

- 1 Press .
- 2 Select **Privacy**.
- 3 Select **Internet terms of service** and follow the instructions.

The terms of use must be accepted once per car in order to use the internet.

^[1] Applies to certain markets.

13. Volvo Assistance and the Volvo Cars app

13.1. Volvo Assistance

13.1.1. Volvo Assistance

The  and SOS buttons in the roof can provide extra security and assistance, such as if the car doesn't start, in the event of a puncture, or in connection with an accident or other emergency situation, for example.



The functions are available via the  and SOS buttons in the car's roof.

In the event of an accident, emergency assistance such as ambulance or police can be sent to the car. Roadside assistance can be called for less urgent problems, such as a puncture.

Note

The SOS button must only be used in the event of accident, illness or an external threat against the car and its passengers. The SOS function is only intended for emergency situations. Abuse may lead to supplementary charges.

You can use the  button for other assistance, e.g. questions on the use of the car or if you need roadside assistance.

System for Volvo Assistance

The buttons in the roof are linked to the car's safety and alarm systems as well as other systems in the car, such as locking and climate control. The car has a built-in modem for communication with Volvo Assistance and the Volvo Cars app. GNSS (Global Navigation Satellite System) is used to locate the car.

Processing of personal data

The content of this manual represents the status of the user manual at the time of printing and may not be completely valid in future instances. For more information, refer to the first page for the complete disclaimer note.

Certain information, including personal data, will need to be processed in order for you to be able to make use of all the functions in connection with the service. Read more about terms and conditions and privacy at [volvocars.com/intl/legal](https://www.volvocars.com/intl/legal) [<https://www.volvocars.com/intl/legal>].

Contacting Volvo Assistance

To contact Volvo Assistance, use the car's  button or the Volvo Cars app.

Note

All calls with Volvo Assistance may be recorded.

13.1.2. Emergency assistance with Volvo Assistance

Press the SOS button to contact Volvo Assistance, or an emergency call centre, in an emergency situation.

Volvo Assistance ^[1]

To summon help in case of illness, external threats to the car or passengers, Volvo Assistance can be alerted manually by depressing the SOS button for at least 2 seconds. The car calls Volvo Assistance and a message is sent containing the car's position, among other things.

- 1 Volvo Assistance tries to establish verbal contact with the car's driver and to find out the extent of the emergency situation and the need for help.
- 2 Volvo Assistance then contacts the necessary assistance (police, ambulance, recovery, etc.).

If verbal contact cannot be established, Volvo Assistance contacts the relevant authorities that assist with appropriate action.

Prioritise public emergency number ^[1]

It is possible to set up the system so that the car calls a public emergency call centre instead of Volvo Assistance. See the separate instructions.

Emergency call centre ^[2]

To summon help in case of illness, external threats to the car or passengers, an emergency call centre can be alerted manually by depressing the SOS button for at least 2 seconds.

- 1 The emergency call centre tries to establish verbal contact with the car's driver and to find out the extent of the emergency situation and the need for help.
- 2 The emergency call centre sends the necessary assistance (police, ambulance, towing, etc.).

Note

The SOS button must only be used in the event of accident, illness or an external threat against the car and its passengers. The SOS function is only intended for emergency situations. Abuse may lead to supplementary charges.

You can use the  button for other assistance, e.g. questions on the use of the car or if you need roadside assistance.

Note

The SOS button must only be used in the event of accident, illness or an external threat against the car and its passengers. The SOS function is only intended for emergency situations. Abuse may lead to supplementary charges.

You can use the  button for other assistance, e.g. questions on the use of the car or if you need roadside assistance.

Emergency number

When the collision alarm is activated the system attempts to establish contact with the country's Volvo Assistance. If this is not possible, then the call is routed to the designated emergency number for the area where the car is located.

^[1] Available services vary depending on market.

^[2] Applies to markets where Volvo Assistance is not offered.

13.1.3. Automatic collision alarm with Volvo Assistance

If a collision occurs, the car reports this automatically to Volvo Assistance, or an emergency call centre, which can send out emergency assistance.

Volvo Assistance ^[1]

When the car's safety system is triggered, e.g. in an accident in which the activation level is reached for seatbelt pretensioners or airbags, the car automatically calls Volvo Assistance and a message is sent containing the position of the car, among other things.

- 1 Volvo Assistance tries to establish verbal contact with the car's driver and to find out the extent of the collision and the need for help.
- 2 Volvo Assistance then contacts the necessary assistance (police, ambulance, recovery, etc.).

If verbal contact cannot be established, Volvo Assistance contacts the relevant authorities that assist with appropriate action.

Prioritise public emergency number^[1]

It is possible to set up the system so that the car calls a public emergency call centre instead of Volvo Assistance. See the separate instructions.

Emergency call centre^[2]

When the car's safety system is triggered, e.g. in an accident in which the activation level is reached for seatbelt tensioners or airbags, a signal will be automatically sent directly to an emergency call centre.

- 1 The emergency call centre tries to establish verbal contact with the car's driver and to find out the extent of the collision and the need for help.
- 2 The emergency call centre sends the necessary assistance (police, ambulance, towing, etc.).

Emergency number

When the collision alarm is activated the system attempts to establish contact with the country's Volvo Assistance. If this is not possible, then the call is routed to the designated emergency number for the area where the car is located.

^[1] Available services vary depending on market.

^[2] Applies to markets where Volvo Assistance is not offered.

13.1.4. Prioritising between Volvo Assistance and the emergency call centre

Choose whether the car should call Volvo Assistance or the emergency call centre in an emergency situation.

^[1]

It is possible to set whether the car should contact Volvo Assistance or the public emergency call centre when the automatic collision alarm is triggered or when the SOS button is pressed.

The car's factory setting is to primarily contact Volvo Assistance.

To change this:

- 1 Tap on  at the bottom of the centre display and select **Controls**.
- 2 Under **More**, deactivate **SOS button calls Volvo Cars emergency services**.

 **Note**

When contact with Volvo Assistance is given priority, more information is transmitted from the car and more extensive help can be given than if the public emergency call centre is the primary contact. If contact with Volvo Assistance cannot be established, the car contacts the public emergency call centre instead.

If, on the other hand, the public emergency call centre is given priority and it is not possible to establish contact, no attempt is made to reach Volvo Assistance instead.

^[1] Available services vary depending on market.

13.1.5. Stolen Vehicle Tracking with Volvo Assistance

If car theft is suspected, Volvo Assistance can be contacted via the Volvo Cars app to attempt to locate the car.^[1]

If theft or other unauthorised use of the car has been discovered, then the car's owner along with the police and Volvo Assistance can agree to track the car.

 **Note**

This also applies if the car was opened and stolen with the associated key.

The following needs to be done:

- 1 Contact Volvo Assistance and tell them you want help tracking the car. The tracking starts.
- 2 Make a police report.
- 3 Contact Volvo Assistance again and notify them of the police case number.
- 4 Volvo Assistance informs the police of the car's position.

 **Note**

A condition for the car to be tracked is that the matter is reported to the police. Volvo Assistance will only give information to the police.

^[1] Available services vary depending on market.

13.1.6. Volvo Assistance during a trip

If you have a puncture, run out of fuel or your battery is discharged, for example, you can summon assistance with the  button or the Volvo Cars app.

If you hold down the  button in the roof for at least 2 seconds, verbal contact will be established between Volvo Assistance and the driver. The aim of this is to agree on what assistance is required. A message with the car's position is sent to Volvo Assistance.

 **Note**

The SOS button must only be used in the event of accident, illness or an external threat against the car and its passengers. The SOS function is only intended for emergency situations. Abuse may lead to supplementary charges.

You can use the  button for other assistance, e.g. questions on the use of the car or if you need roadside assistance.

Roadside assistance costs

Roadside assistance costs are included for the first X^[1] years when you buy a new Volvo. After this time has passed, in most of the markets, Roadside Assistance is offered free of charge providing the car has been serviced regularly at an authorised Volvo workshop. A Volvo dealer can inform you about the status of your roadside assistance agreement.

You can get help to get you back on the road even if your Roadside Assistance agreement has expired. In this case, you will be asked to pay the cost for the service that is sent out to you.

 **Note**

If you do not have a valid road assistance agreement, additional recovery costs may apply.

^[1] Varies depending on market.

13.1.7. Customer service via Volvo Assistance

For questions on using the car, the  button can be used to make contact with Volvo Assistance.^[1]

An operator is available to answer 24 hours a day.

You can also reach Volvo Assistance via the Volvo Cars app's  tab.

^[1] Available services vary depending on market.

13.1.8. Standby battery for Volvo Assistance *

If the main battery is de-energised then the standby battery for Volvo Assistance is used so that the system can still be used.

The standby battery has a limited service life. When the battery needs service or replacement, a message, **eCall Service required**, is shown in the driver display.

If the message remains, contact an authorised Volvo workshop.

* Option/accessory.

13.1.9. Volvo Assistance abroad

The assistance services may vary when driving between countries.

When you press the SOS button you are always connected to Volvo Assistance or an emergency call centre in the market where the car is located.

When you press the  button you are always connected to your home country's Volvo Assistance.

For more information, contact a Volvo dealer.

13.2. Volvo Cars app

13.2.1. Getting started with the Volvo Cars app *

There are certain preparations you need to complete in order to get started with the Volvo Cars app.

Exploring the Volvo Cars app

Before you collect your car from the dealer, we recommend that you download the free Volvo Cars app and test in demo mode. The demo mode allows you to explore the majority of functions and provides information on how the app is used.

Volvo ID and linking the Volvo Cars app to the car

In order to use the Volvo Cars app, you need a Volvo ID. When a Volvo ID has been created, the app needs to be linked to the car.

Buying a used car with digital services

When buying a used car with digital services, it is important to delete data from the previous owner and add your own details to make the service work. Visit a Volvo dealer for assistance.

* Option/accessory.

13.2.2. Devices compatible with the Volvo Cars app*

The Volvo Cars app is compatible with various mobile devices and operating systems.

The Volvo Cars app is available for iPhone, iPad and Apple Watch as well as Android phones. The app can be downloaded free-of-charge from the Apple App Store or Google Play.

For the Volvo Cars app to work as well as possible, ensure that you have updated the app to the latest version available for your device. More information on the technical requirements for the version and operating system as well as compatibility for device models is available from where you download apps.

Note

Volvo reserves the right to stop supporting older versions of apps and discontinue them from existing app stores at any time.

Internet connection

The app communicates with the car via the Internet, and so your mobile device must have an Internet connection^[1] to be able to execute your commands.

* Option/accessory.

^[1] Data is transferred (data traffic) when using the Internet, and this may involve a cost.

13.2.3. Contact between the Volvo Cars app* and the car

The car's systems that have contact with the Volvo Cars app are programmed to close when the car is not used for a long period.

After a few days, the system is deactivated to save the battery. At which point, it is not possible to use certain app functions. The system will be fully available again as soon as the car has been started.

Warning

The system's services only work in areas where Volvo Assistance's partners have mobile coverage and where the technology permits.

Just as with mobile phones, atmospheric disturbances or sparse transmitter coverage may lead to connection being impossible, e.g. in sparsely populated areas.

* Option/accessory.

13.2.4. Volvo Cars app*

Using the Volvo Cars app^[1], you can maintain contact with your car via different app functions.^[2]

There is the option to lock or unlock the car and start the climate control in the car before departure, for example.^[3]

Downloading the Volvo Cars app

The Volvo Cars app can be downloaded free-of-charge from the Apple App Store or Google Play. You can try out several of the app's functions without linking it to a car by running it in demo mode.

Internet connection required

When you use the Volvo Cars app, your mobile device will send and receive data via the Internet. If you do not have a data plan, then your mobile network operator may charge you for that data. If you use the app abroad, you may be charged for data roaming. For more information, contact your mobile service provider.

Note

Data sharing for the roof buttons needs to be enabled for remote control of car functions, such as climate control and locking/unlocking, to work.

* Option/accessory.

^[1] Applies to certain markets.

^[2] Requires that both car and mobile device have mobile coverage or other Internet connection.

^[3] Available functions may vary depending on market and car model.

13.2.5. Connecting the Volvo Cars app* to the car

To be able to use the services in the Volvo Cars app, the app needs to be connected to the car first.

When a main user (administrator) has linked his/her app to the car, more users of the car can be added.

Connect the Volvo Cars app to the car

Make sure your car is in an area with mobile coverage and that your mobile device has an Internet connection.



Ensure that you have your Volvo ID and the Vehicle Identification Number. A Volvo ID can be created when logging in to the Volvo Cars app, and you can find the Vehicle Identification Number in the windscreen or centre display, for example.

If you are the main user (administrator), all of the car's keys need to be taken with you. For other users, one of the car's keys is sufficient. The first user to link his/her app to the car must be logged-in to the Owner profile and be carrying all of the car's keys.

- 1 Sit in the car.
- 2 Sign in to the Volvo Cars app with your Volvo ID and follow the instructions in the app. If you have already a car connected in the app and want to add a further one, select , **Connected cars** and **Add a car**.

Note

It is recommended that every user creates a personal Volvo ID in order to enjoy a more customised experience and support.

- 3 Make sure that data sharing for the Volvo Cars app is enabled. In the centre display, tap on , select **Privacy, Volvo privacy settings** and then **Volvo Cars app**.
- 4 Go to , select **Profiles** and then **Volvo Cars app devices** in order to access the menu for connecting the app to the car.
- 5 Follow the instructions in the centre display and the Volvo Cars app.

Difference between administrator and non-administrator in the Volvo Cars app

The car's **Owner** profile must be linked to the app before linking can take place for another profile. To be allocated the administrator role requires that all of the car's keys are in the car when the app is linked.

A user that is administrator in the app can

- see which mobiles or other devices are linked with the car
- remove own and other linked phones/devices from the car.

A user that is not administrator in the app can

- see that own phone/device is linked with the car
- remove own phone/device.

Switching between several connected cars in the Volvo Cars app

If you have connected several cars to the Volvo Cars app, switch between these as follows:

- 1 Go to the  tab.
- 2 Select **Connected cars**.
- 3 Highlight the car in question and select **Switch to this car**.

Tips for using the Volvo Cars app

If you experience disruptions with the Volvo Cars app, ensure that the car to which the app is linked is outdoors in an open area with mobile coverage, and that your mobile device has a good Internet connection. If the disruptions persist, read more in the section with frequently asked questions about the Volvo Cars app at [volvocars.com/intl/support](https://www.volvocars.com/intl/support) [<https://www.volvocars.com/intl/support>] or contact Volvo's Customer Service.

If the car is a used car, you should check that access to Volvo Assistance is activated in the car.

* Option/accessory.

13.2.6. Booking a service with the Volvo Cars app*

Service of the car can be booked via the Volvo Cars app.^[1]

Book a service

- 1 In the  tab, tap on **Maintenance**.
- 2 Select **Book service**.
- 3 Select which workshop should perform the service.
- 4 Select whether you want to buy any extra services^[2], e.g. to control the air conditioning.
- 5 Enter date and time for service and whether you require a courtesy car^[3]. Some workshops can also offer pick-up and delivery of the car booked for service.
- 6 Fill in any comments and confirm the booking.

The content of this manual represents the status of the user manual at the time of printing and may not be completely valid in future instances. For more information, refer to the first page for the complete disclaimer note.

- 7 Select whether you want to add the booking to the calendar.



Once a service has been booked, this is shown under **Maintenance** in the  tab.

Click on the booking in order to:

- see details about the booking
- save the booking to the calendar (with the option to add a reminder)
- cancel the service
- contact the workshop via email or phone.

Messages about service in the Volvo Cars app

When it is time for service for the car, this is shown in the Volvo Cars app

- with a message in the  tab
- and under **Maintenance** in the  tab.

While a service is in progress, estimated completion time is shown in the Volvo Cars app.

* Option/accessory.

[1] Applies to certain markets.

[2] Available services depend on workshop.

[3] Applies to certain workshops.

13.2.7. Remote starting the car using the Volvo Cars app*

Using the Volvo Cars app, the car can be started remotely in order to heat or cool the car to a comfortable temperature. [1]

Points to remember for remote start of the car

The following requirements must be met before the function is used:

- The car is locked.
- There are no car keys in the car.
- The bonnet is locked.
- The car is parked and the gearbox is in Park.
- The engine is not running.
- The car is under supervision.
- There are no people or animals in or around the car.

- The car is not parked inside an enclosed space/area without sufficient ventilation.
- There is no risk to anyone who is in direct contact with the car (e.g. during a service in a workshop or children playing near the car).
- By law, use of the function is permitted at the set time.



The system will also check the following before starting the car:

- Engine status is OK (no critical fault codes).
- Sufficient fuel level (more than 8 litres (2.11 US gallons)).

You will also find user recommendations in the Volvo Cars app.

Remote starting the car

Start by ensuring that the car is in a location where it can be started in accordance with local environmental regulations and laws.

- 1 Go to the  tab and tap on the  icon.
- 2 Enter within how many (1-15) minutes you plan to start to travel. Confirm that you want to start the car and identify yourself using the phone's unlock method, e.g. with PIN code, password, pattern, TouchID or FaceID.

Note

For safety reasons, it is not possible to drive the car after it has been remote started via the Volvo Cars app. The function will be active until you depress the brake pedal and turn the ignition dial.

It is possible activate the function in the Volvo Cars app twice in succession, after that the car has to be started with the key before you can activate the function via the app again.

If it is cold when the car is started remotely, functions such as seat heating, heated rearview mirrors and rear window are also activated automatically.

Remote starting the climate control

It is also possible to start the climate control remotely without starting the car.^[2] Read about starting the climate control remotely in a separate section.

* Option/accessory.

^[1] Applies to certain markets.

^[2] Applies to plug-in hybrids and cars equipped with fuel heater.

13.2.8. Lock function in the Volvo Cars app*

The Volvo Cars app shows the current lock status, and you can both lock and unlock the car remotely.

You can find the lock function in the  tab.

Note

If the incorrect lock status is shown, open the lock function from the  tab and wait for 15-20 seconds.

* Option/accessory.

13.2.9. Shortcuts to the Volvo Cars app*

You can create shortcuts to the functions offered in the Volvo Cars app.

3D Touch

Using 3D Touch you have access to shortcuts for some functions in the Volvo Cars app^[1].

Press firmly on the app icon on your phone to access, among other things, shortcuts to the following functions: Start climate control and Unlock the doors.

Sharing addresses to the Volvo Cars app

Some third party apps facilitate sharing addresses to the Volvo Cars app^[2].

* Option/accessory.



^[1] Applies to certain iPhone models. See manufacturer's website for more information.

^[2] Varies depending on phone model and version of operating system.

13.2.10. Remote starting climate control using the Volvo Cars app*

If the car is equipped with the climate control package, * you can start the climate control system immediately or set a time when the car will be used.^[1] In the latter case, the climate control system starts automatically to adjust the temperature of the passenger compartment before departure.

Direct-starting climate control

- 1 Go to the  tab and tap on .
 - 2 Press **Start**.
- The climate control starts and runs for 30 minutes.

For cars with automatic transmission, there is also the option to remote start the car to reach comfort temperature more quickly. Read about remote start of the car in a separate section.

Setting the timer for climate control

A timer can be set so that the climate control starts automatically in order to heat the passenger compartment prior to departure. There is the option to set up to 8 different timers. Each timer can be set by selecting the time and day of the week, as well as whether the setting should be repeated weekly.

Set the timers from  in the  tab.

Other climate settings

Heating the driver's seat, passenger seat and steering wheel^[2] is automatically activated in cold weather.



* Option/accessory.

^[1] Applies to certain markets.

^[2] Applicable to cars fitted with steering wheel heating.

13.2.11. Remote starting air purification using the Volvo Cars app*

Using the Volvo Cars app, you can remote start the car's air purification* to improve the air quality before departure.

- 1 Go to the  tab and tap on  (air purification).
- 2 Press **Start**.

* Option/accessory.

13.2.12. Using the Volvo Cars app* with Apple Watch

You can use an Apple Watch to access some of the Volvo Cars app's functions, e.g. start/stop parking climate control and lock/unlock the car.

If the Volvo Cars app is installed on a phone and connected to the car, the app functions will automatically be available in the Apple Watch that is paired with your phone.

Functions that can be controlled from Apple Watch^[1]:

- Parking climate control (start/stop).
- Car remote start (start/stop).
- Doors (lock/unlock).
- Find the car by activating the car's horn and/or direction indicators for a couple of seconds.
- See estimated range.
- See the car's position on a map.

Pairing Apple Watch with your phone

For instructions on how to pair an Apple Watch with your phone, as well as technical requirements for this, see Apple's website.

Technical requirements

Technical requirements for applicable operating system and information about compatibility for different mobile models can be found on the information page in the relevant app store.

* Option/accessory.

^[1] Available functions may vary over time.

13.2.13. Disconnecting the link between the Volvo Cars app* and the car

Before the Volvo Cars app is uninstalled, you must ensure that the link between the app and the car is disconnected or that ownership of your car has been terminated in the correct way in the app. If the Volvo Cars app is simply deleted, problems may arise when connecting to the car in the future.

Terminate ownership in the Volvo Cars app

If you sell your car, ownership and the link between the Volvo Cars app and the car must be terminated via the administrator's account in the app. If you do not have access to the app, contact your Volvo dealer and explain that you want to sell your car.

To terminate ownership and remove the link:

- 1 Go to **Connected cars** in the  tab.
 - 2 Select the relevant car.
 - 3 Press **I no longer own this Volvo** and follow the instructions in the app.
- User history and other user accounts will be deleted once you have terminated the ownership. In addition, an automatic factory reset of the car takes place, so that profiles, user data, linked keys and personal settings, etc., are removed.

Volvo ID is personal and therefore does not need to be changed or deleted if the car is sold.

Contact your Volvo dealer if you want to delete your contact details from the dealer's system.

Disconnecting the link between the connected phone and the car

The link between a connected phone and the car can be disconnected either from the Volvo Cars app or from the car's centre display. Users with administrator privileges can view and disconnect all phones connected to the car. Other users can only view and disconnect their own phone.

Via the Volvo Cars app

- 1 Go to **Connected cars** in the  tab.
- 2 Select the relevant car.
- 3 Press **Disconnect** next to the unit you want to decouple and follow the instructions in the app.

Via the centre display

- 1 Go to .
- 2 Select **Profiles**.
- 3 Select **Volvo Cars app devices**.
- 4 Tap on the phone you wish to disconnect and select **Unpair this phone**.

* Option/accessory.

13.2.14. Change of ownership when the Volvo Cars app* is linked to the car

The content of this manual represents the status of the user manual at the time of printing and may not be completely valid in future instances. For more information, refer to the first page for the complete disclaimer note.

In the event of a change of ownership, there are some steps that need to be taken to unlink the previous owner and give the new owner the option to connect the Volvo Cars app to the car.

Selling the car

The previous owner needs to remove the link between the car and the Volvo Cars app. When the ownership is ended, an automatic factory reset of the car takes place, so that profiles, user data, linked keys and personal settings, etc., are removed.

Buying a car

The new owner needs to connect the Volvo Cars app to the car.

Change of owner when changing country

Further action is necessary when a car is purchased and imported into another country. Contact a dealer for information.

* Option/accessory.

14. eCall

14.1. eCall

The car can detect an accident and contact an emergency call centre itself. ^[1]

For cars without access to Volvo Assistance*, there is a European legal requirement, Pan-European eCall, that provides access to an automatic collision alarm and urgent assistance in emergency situations.

^[1] Applies to certain markets.

* Option/accessory.

14.2. Emergency assistance with eCall

Press the SOS button to contact an emergency call centre in an emergency situation. ^[1]

To summon help in case of illness, external threats to the car or passengers, an emergency call centre can be alerted manually by depressing the SOS button for at least 2 seconds. The emergency call centre is notified and told of the car's position ^[1], etc., and attempts to establish verbal contact with the driver in order to agree what assistance is needed.

 **Note**

The SOS button is only designed for emergencies and must only be used in the event of an accident, illness or an external threat to the car and its passengers. The  button must be used in the event of problems with the car.

^[1] Applies to certain markets.

14.3. Automatic collision alarm with eCall

If a collision occurs, the car reports this automatically to an emergency call centre, which can send out emergency assistance. ^[1]

When the car's safety system is triggered, e.g. in an accident in which the activation level is reached for seatbelt tensioners or airbags, a signal will be sent automatically to an emergency call centre.

- 1 A message, containing car position^[1], etc., is sent automatically from the car to the emergency call centre.
- 2 The emergency call centre establishes verbal contact with the car's driver and tries to find out the extent of the collision and the need for help.
- 3 The emergency call centre sends the necessary assistance (police, ambulance, towing, etc.).

If verbal contact cannot be established, the emergency call centre knows the car's position and can assist with appropriate action.

^[1] Applies to certain markets.

14.4. Roadside assistance

Summon assistance if you have problems with the car by pressing the  button in the car's roof.^[1]

Press the  button in the car's roof for at least 2 seconds if you have a puncture, run out of fuel or your battery runs out of charge, for example. Verbal contact is established with a roadside assistance company that can send help to the car.

^[1] Applies to certain markets.

15. Navigation

15.1. Map update

15.1.1. Downloading maps

Map data is saved automatically in order to ensure access to maps in Google Maps even when the car has a poor or no online connection.

Maps automatically downloads maps based on the current position and travel pattern of the car. These maps can be used when the car is not online to:

- provide map data to the car's safety and navigation functions
- provide access to Maps in areas with limited or no online connection.

It is also possible to select a map area manually and download.

 **Note**

The instructions above are general descriptions and include third-party suppliers. Availability, procedure and functionality are subject to change or variation.

15.2. Google Maps

The Google Maps app includes maps and provides access to e.g. traffic information, directions and information on where to find suitable charging stations.



It is possible to use Maps when the car is connected to the Internet and when it is not, but more services are available when you are connected to the Internet.

Same information in the car as on other devices

Linking your Google account to the active user profile also personalises the services for you to a greater extent. Destinations set on other devices are shown, such as home, work, favourites and last searches. If anything is changed on a device it is also changed in Maps, provided that the device and the car are logged in to the same Google account.

Voice control

Maps can also be controlled with voice control using the Google assistant^[1].

Note

The instructions above are general descriptions and include third-party suppliers. Availability, procedure and functionality are subject to change or variation.

Warning

Observe the following.

- Direct all your attention to the road and make sure that all your concentration is on driving.
- Follow applicable traffic legislation and drive with good judgment.
- Due to weather conditions or time of year affecting the road conditions, some recommendations may be less reliable.

^[1] The Google assistant is not yet available in all languages.

15.3. Using Google Maps

Maps is shown and is operated in the centre display as well as the driver display using the steering wheel keypad. Maps can also be operated using voice control.

Opening and closing Maps



To open Maps, tap on its icon in the centre display. To close the app, tap on the home button.

Open mode shows the map and current traffic information.

Shortcuts

The navigation tile has shortcuts, each of which initiates a search in Maps: Examples of shortcuts:

- Petrol station
- Restaurant

When a route has been entered in Maps, there is an extra shortcut to terminate the ongoing guidance.

Note

The instructions above are general descriptions and include third-party suppliers. Availability, procedure and functionality are subject to change or variation.

 **Warning**

Observe the following.

- Direct all your attention to the road and make sure that all your concentration is on driving.
- Follow applicable traffic legislation and drive with good judgment.
- Due to weather conditions or time of year affecting the road conditions, some recommendations may be less reliable.

15.4. Updating Google Maps

It is advisable to ensure that Maps is updated to the latest version.

When an updated version of Maps is available, this will be found on Google Play. If there are any differences in access rights between two versions of the app, the system will ask the user for approval.

The latest version ensures that you have the latest updates and functions. To update Maps, your car needs to be connected to the Internet and there needs to be an active Google account linked to the user profile.

When an update is available for Maps, a notification will be displayed where you can choose to update.

15.5. Settings in Google Maps

The majority of the settings for Maps are made directly in the app under settings. Here is a list of some examples.

Level of voice guidance

Set the amount of voice guidance, e.g. if you only want to hear traffic information and not the next manoeuvre.

Alternative route

Set so that road tolls and motorways, for example, are avoided in route directions.

 **Note**

The instructions above are general descriptions and include third-party suppliers. Availability, procedure and functionality are subject to change or variation.

Other settings

Volume for voice guidance

Turn the volume control under the centre display or the steering wheel's right-hand keypad. An expandable menu is opened in the centre display. Set the volume for voice guidance.

Language and units

If you want to use other languages or units in Maps, these can be changed from the settings in app view . This setting will change the language and units in all displays in the car, not just in Maps.

Note

Changing the language in the centre display may mean that some information in the owner's manual is not compliant with national or local laws and regulations. Do not switch to a language that is difficult to understand as this may make it difficult to find your way back through the screen structure.

15.6. Electric car functions with Google Maps

Some functions in Maps are unique to electric cars. Some of them are listed here, with a brief description.

The functions mentioned are only examples. For the latest information on which functions are available as well as how they work, go to g.co/mapsincarcars [<https://g.co/mapsincarcars>].

The functions related to battery level are based on historical use of the car, where influencing factors include, for example, use of electric equipment, speed and driving style.

Filtering on charging stations

By default, the map only displays compatible charging stations.

Battery level on arrival

Maps can show the estimated battery level on arrival at a destination.

Estimated minimum charging time

When charging stations have been added as intermediate destinations in an itinerary, Maps indicates the estimated minimum charging time at the charging station in question in order to clarify the total travelling time and the ETA ^[1].

Suggestions for adding charging stations

Guidance is started when the car is estimated as not reaching the final destination with the current battery level, Maps will suggest to add charging stations at suitable locations in order to reach the final destination.

Note

The instructions above are general descriptions and include third-party suppliers. Availability, procedure and functionality are subject to change or variation.

15.7. Google Maps in driver display

The driver display can show guidance to a destination with instructions as well as a map. A map can still be shown if no destination is set.

Depending on selected display mode in the driver display, different amounts of map and guidance information is shown. Examples of information in the driver display:

- Arrows showing the next manoeuvre
- Distance to manoeuvre
- Name of the next road
- Road number and exit number
- Lane information

Guidance points, known as Turn-by-Turn, result in clear guidance via the driver display and minimise the need for the driver to look away from the road.

15.8. Destination in Google Maps

It is possible to enter several destination types in Maps.

Different destination types can be entered in the search field. Besides addresses, it is possible to enter a specific destination, such as a museum, and ask for directions to the destination. It is also possible to execute more general searches, e.g. for charging stations, restaurants and hotels, and then select one of the search results as a destination and get directions to the destination.

If a Google account is linked to the car, destinations such as home, work, favourites and last searches that are set on other devices can be shown in Maps.

 **Note**

A poorer connection may have a negative effect on the functions.

15.9. Online functions with Google Maps

The car needs an Internet connection for full Maps functionality. A few functions that are accessible when the car is online are listed here.

Maps is updated regularly with traffic information and information from car parks, charging stations and the connected Google account.

The functions mentioned are only examples. For the latest information on which functions are available as well as how they work, go to g.co/mapsincar [<https://g.co/mapsincar>].

Traffic information

If the traffic is moving slowly, orange or red lines are shown, depending on how slowly the traffic is moving. If the car loses its Internet connection, the coloured lines disappear after a few minutes as the information is no longer up to date. Updated traffic information is displayed again when the connection has been re-established. The map also shows information on different types of obstacles, such as roadworks or accidents.

In the event of accidents or other obstacles along the ongoing route, and if another faster route is available, Maps will suggest an alternative route.

Alternative route

When a desired destination has been entered, a route is suggested as well as alternative routes. These suggestions are based on factors such as system settings, traffic information, estimated distance and travelling time. An alternative route is selected from the list of suggested routes, or by steering the car as indicated in the alternative route, which is known as decide by steering.

Change route while driving, Google Maps redirects you dynamically based on current traffic patterns, so that you can avoid traffic congestion.

Note

The instructions above are general descriptions and include third-party suppliers. Availability, procedure and functionality are subject to change or variation.

15.10. Getting directions with Google Maps

Enter your destination in the search field and allow Maps to create the directions.

- 1 Open Maps in home view or app view .
- 2 Enter an address or location in the search field.
 - A route is suggested and marked blue on the map. Alternative routes are indicated in grey. Road selection may be affected if, for example, road tolls and motorways are set to be avoided.
- 3 If another road is preferable, tap on the icon for route overview and select an alternative route.

4 Start navigation.

- Instructions in the driver display and voice guidance^[1] start.

Maps can also be voice-controlled using Google Assistant^[2].

Note

The instructions above are general descriptions and include third-party suppliers. Availability, procedure and functionality are subject to change or variation.

Take a look at g.co/mapsincar [https://g.co/mapsincar] for more information.

Warning

Observe the following.

- Direct all your attention to the road and make sure that all your concentration is on driving.
- Follow applicable traffic legislation and drive with good judgment.
- Due to weather conditions or time of year affecting the road conditions, some recommendations may be less reliable.

Adding intermediate destinations in an existing route

- 1 Select a shortcut.
 - 2 Select intermediate destination.
- The route is reconfigured.

Travel information in the navigation tile

When a route has been entered into Maps, the navigation tile shows the following travel information for the next intermediate destination on the journey:

- Travel time
- Distance to an intermediate destination
- Estimated time of arrival, ETA^[3]
- The name of the next intermediate destination
- Unique information for electric cars, e.g. estimated battery level at arrival.

It is possible to terminate ongoing guidance directly from the tile.

The information displayed relates to the next intermediate destination. The trip's final destination is not shown until there are no further intermediate destinations.

[1] Voice guidance can be deactivated in settings in the Maps app via the centre display.

[2] Google Assistant is not yet available in all languages.

[3] Estimated Time of Arrival

16. Wheels and tyres

16.1. Changing wheels

16.1.1. Changing wheel

Wheel changes must always be performed correctly. Instructions on how a wheel is removed and mounted and what is important to remember are provided below. Check that the tyre dimension is approved for use on the car.

 **Warning**

- If a wheel must be changed in a trafficked environment, passengers must stand in a safe place.
- Use a jack* designed for the car when changing tyres. Use supports to secure the car for all other work.
- Never crawl under the car or reach under with a part of your body when it is raised on a jack.
- Passengers must leave the car when it is raised on the jack.

 **Important**

If a jack* is included with the car, it is only designed for occasional, short-term use, such as when changing a wheel after a puncture. Only the jack belonging to the specific model is to be used to jack up the car. If the car is to be jacked up more often, or for a longer time than is required just to change a wheel, use of a garage jack is recommended. In this instance, follow the instructions for use that come with the equipment.

When the jack is not in use it should be stored in its storage space under the cargo area floor. Crank the jack down for it to fit.

Removing a wheel

Read through all instructions before beginning. Take out the tools needed before jacking up the car.

- 1 Activate the hazard warning flashers and set out a warning triangle if a wheel shall be changed in a trafficked location.
- 2 Make sure that the parking brake is activated and engage gear position P.
- 3 Chock in front of and behind the wheels that remain on the ground. Use, for example, heavy wooden blocks or large stones.

- 4 Screw together the towing eye with the wheel wrench * to the stop position.



- 5 Remove the plastic caps from the wheel bolts using a suitable tool or pull off the wheel cap.



- 6 With the car still on the ground, use the wheel bolt wrench/towing eye to undo the wheel bolts $\frac{1}{2}$ -1 turn by pressing downwards (anticlockwise). Always start with the lockable wheel bolts*.
- 7 Follow the instructions for how to safely raise the car with the jack.
- 8 Raise the car high enough to allow the wheel to be removed to move freely. Remove the wheel bolts and lift off the wheel.

Mounting a wheel

- 1 Clean the surfaces between wheel and hub.
- 2 Put on the wheel. Ensure that the correct dimension is fitted in the correct position for cars with different front and rear tyre or wheel dimensions. Tighten the wheel bolts thoroughly.
Do **not** use lubricant on the threads of the wheel bolts.
- 3 Lower the car so that the wheels cannot rotate.
- 4 Tighten the wheel bolts crosswise. It is important that the wheel bolts are tightened properly. Tighten to 140 Nm

(103 foot-pound). Check the tightening torque with a torque wrench.



5 Depending on tyre equipment:

- Place the wheel cap back over the wheel nuts by making sure it fits using guide markers, then press it into place.
- Refit the plastic caps over the wheel bolts.

6 Check the tyre pressure and save the new tyre pressure in the system for tyre pressure monitoring*.

 **Warning**

The wheel bolts may need to be re-tightened several days after the wheel change. Temperature differences and vibration may mean that they are not attached equally as tightly.

 **Note**

- After a tyre has been inflated, always refit the dust cap in order to avoid damage to the valve from gravel, dirt, etc.
- Only use plastic dust caps. Metal dust caps can rust and become difficult to unscrew.

* Option/accessory.

16.1.2. Jack*

The jack can be used to raise the car, for example, to change to a wheel.



! Important

If a jack* is included with the car, it is only designed for occasional, short-term use, such as when changing a wheel after a puncture. Only the jack belonging to the specific model is to be used to jack up the car. If the car is to be jacked up more often, or for a longer time than is required just to change a wheel, use of a garage jack is recommended. In this instance, follow the instructions for use that come with the equipment.

When the jack is not in use it should be stored in its storage space under the cargo area floor. Crank the jack down for it to fit.

The jack needs to be cranked together to the correct position in order to have space.

i Note

Applies to cars with level control*: If the car is equipped with air suspension, this must be disabled before the car is raised.

* Option/accessory.

16.1.3. Wheel bolts

Wheel bolts are used to attach the wheels to the hubs.

Only use rims that are tested and approved by Volvo and which are Volvo genuine accessories.

Check the tightening torque of the wheel bolts with a torque wrench.

Do **not** use lubricant on the threads of the wheel bolts.

 **Warning**

The wheel bolts may need to be re-tightened several days after the wheel change. Temperature differences and vibration may mean that they are not attached equally as tightly.

 **Important**

The wheel bolts must be tightened to 140 Nm. (103 foot-pound). Overtightening or loose tightening may damage the nuts and the bolts.

Lockable wheel bolt kit*

To loosen or tighten the lockable wheel bolts – turn the wrench in the lock bolt until it fully engages in the code grooves. Always start with the lockable wheel bolts if the wheel shall be removed. When fitting the wheel, finish with the lock screw.

 **Important**

Remember not to use bending force when you loosen/tighten the wheel bolts. This could damage the code groove in the lock bolt and the wheel wrench and so make it impossible to fit/remove the wheel.

When the wheel wrench* is not in use it must be stored in its place in the foam block under the cargo area floor. It is important to remember this if the car is due to visit a workshop in order to have the tool available. If you lose the wrench, contact your Volvo dealer.

* Option/accessory.

16.1.4. Spare wheel*

The spare wheel, the Temporary Spare type, can be used to temporarily replace a punctured normal wheel.

The spare wheel is only designed for temporary use. Replace it with a normal wheel as soon as possible.

The car's driving characteristics can be changed when the spare wheel is used and the ground clearance is reduced. Do not wash the car in an automatic car wash if the Temporary Spare is being used.

Recommended tyre pressure must be maintained regardless of the position of the temporary spare wheel on the car.

If the spare wheel is damaged, a new one can be purchased from a Volvo dealer.

 **Warning**

- Never drive faster than 80 km/h (50 mph) with a spare wheel fitted on the car.
- The car must never be driven fitted with more than one "Temporary Spare" wheel.
- The car may have different driving characteristics while driving with the spare wheel. The spare wheel must be replaced with a normal wheel as soon as possible.
- The spare wheel is smaller than the normal wheel, which affects the car's ground clearance. Look out for high kerbs and do not machine-wash the car.
- Follow the manufacturer's recommended tyre pressure for the spare wheel.
- On all-wheel drive cars, the drive on the rear axle can be disengaged.
- If the spare wheel is fitted to the front axle then it is not possible to use snow chains at the same time.
- The spare wheel must not be repaired.

 **Important**

The car must not be driven with tyres of different dimensions or with a spare tyre other than the one the car is approved for. Using tyres of different dimensions can cause serious damage to the car's transmission due to the different rolling circumferences.

Cars designed for different front and rear tyre or wheel dimensions must have the same type and make of tyres on the front and rear axles.

* Option/accessory.

16.1.5. Handling the spare wheel*

Follow these instructions for handling the spare wheel.

Taking out the spare wheel



The illustration is generic and appearance may differ.

The spare wheel is located under the cargo area floor in the spare wheel well. The spare wheel is secured with the same bolt that attaches in the body. The foam block contains all the tools for changing a wheel.

- 1 Fold up the cargo area floor.
- 2 Undo the retaining screw.
- 3 Lift out the spare wheel.

Storing the punctured tyre

- 1 Screw back the mounting screw that held the spare wheel in place.

Important

Do not attempt to unscrew the lower part of the mounting screw if it is secured in the body. There is a risk it may break.

If the lower attachment of the mounting screw does loosen from the body underneath the spare wheel, refit it in the hole and turn clockwise to reattach it.

Warning

For cars with 48V battery, the screw is attached in the battery box instead of the body. If the lower part of the mounting screw remains fitted when the spare wheel has been removed, it should be removed to avoid risk of crushing when the damaged tyre is put back in place.

- 2 Put the tools back in their right place in the foam block.

- 3 Then fold down the cargo area floor and place the punctured tyre in the cargo area.

* Option/accessory.

16.1.6. Snow chains

Use of snow chains and winter tyres can help to improve the traction in winter conditions.

Volvo recommends that snow chains are not used on wheel dimensions greater than 18 inches.

Warning

Use Volvo genuine snow chains or equivalent chains designed for the car model, and tyre and rim dimensions. Only **single-sided** snow chains are permitted.

In the event of uncertainty about the snow chains, Volvo recommends contacting an authorised Volvo workshop. The wrong snow chains may cause serious damage to the car and lead to an accident.

Using snow chains may result in malfunction of the tyre pressure monitoring system* ^[1].

Important

Snow chains can be used on the car with the following restrictions:

- Always follow the mounting instructions from the manufacturer carefully. Fit the chains as tensioned as possible and tension them at regular intervals.
- Snow chains must only be used on the front wheels (also applies to all-wheel drive cars).
- In some cases, snow chains must NOT be used, such as if accessory, aftermarket or "special" tyres and wheels are fitted that have a different size to the original tyres and wheels. Sufficient distance must be maintained between the chains and brakes, suspension and body components.
- Check local regulations with regard to using snow chains before fitting them.
- Never exceed the chain manufacturer's specified maximum speed. You must never exceed 50 km/h (30 mph) under any circumstances.
- Avoid bumps, holes or sharp turns when driving with snow chains.
- Avoid driving on bare ground as this wears out both the snow chains and tyres.
- Driving with snow chains may have a negative effect on the car's driving characteristics. Avoid fast or sharp turns, as well as braking with locked wheels.
- Some types of chain that are firmly tensioned affect brake components and must therefore NOT be used.

You can obtain more information on snow chains from a Volvo dealer.

* Option/accessory.

[1] Indirect Tyre Pressure Monitoring System (ITPMS)

16.1.7. Winter tyres

Winter tyres are adapted for winter road conditions.

Volvo recommends winter tyres with particular dimensions. Tyre dimensions are dependent on engine variant. When driving on winter tyres, the correct type of tyres must be fitted to all four wheels.

A tyre that meets the minimum values for traction on snow has the following symbol on the tyre label.



The tyre label for a tyre that meets the relevant minimum values for traction on ice must include the following symbol:



Studded tyres are not included in tyre marking.

Tips for changing to winter tyres

When summer and winter wheels are changed, mark which side of the car they were mounted on, for example **L** for left and **R** for right.

Contact a Volvo dealer for advice about which wheel rim and tyre types are most suitable.

Studded tyres

Studded winter tyres should be run in gently for 500-1000 km (300-600 miles), so the studs settle properly into the tyres. This gives the tyre, and especially the studs, a longer service life.

i Note

Laws regarding the use of studded tyres may vary. Always follow local laws and regulations.

Tread depth

Road conditions with ice, slush and low temperatures place considerably higher demands on tyres than summer conditions. Volvo therefore recommends not to drive on winter tyres that have a tread depth of less than 4 mm (0.15 inches).

16.1.8. Punctures

Activate the hazard warning flashers if the car has a puncture in a trafficked environment.

Think about safety. If possible, move the car out of danger from traffic. Call roadside assistance if necessary.

If possible, exit the car from the side with least traffic.

Put on a reflective vest and then position the warning triangle so that other road users are warned in good time.

Dealing with a puncture

The car is equipped with either a puncture repair kit for temporary tyre repair or a spare wheel*, see the respective section for user instructions.

* Option/accessory.

16.1.9. Tool kit

Tools that can be useful during towing, wheel changes or similar are found in the car's cargo area.



Examples of tools that may be in the car.

- 1 Jack*
- 2 Tool for removing the plastic caps from the wheel bolts
- 3 Funnel for filling fluids
- 4 Wheel wrench* and towing eye

If the car is fitted with a spare wheel*, there is a jack and a wheel bolt wrench instead of emergency puncture repair kit.

* Option/accessory.

16.2. Tyres

16.2.1. Dimension designation for tyre

Designations for tyre dimension, load index and speed rating.

The car has an approval for the complete vehicle with certain combinations of wheel rims and tyres.

Designation of dimensions

All tyres have a dimension designation, such as: 255/40 R19 100 W.

255	Tyre width (mm)
40	Ratio between tyre wall height and tyre width (%)
R	Radial ply
19	Rim diameter in inches
100	Codes for the maximum permitted tyre load, tyre load index (LI)
W	Speed rating for maximum permitted speed, speed rating (SS). (In this case 270 km/h (168 mph).)

Load index

Each tyre has a certain capacity to carry a load, a load index (LI). The car's weight determines the load capacity required of the tyres.

Speed rating

Each tyre can withstand a certain maximum speed. Tyre speed rating, SS (Speed Symbol), must at least correspond with the car's top speed. The table below shows the maximum permitted speed for each speed rating (SS). The only exception to these regulations is winter tyres^[1], where a lower speed rating may be used. If such a tyre is selected, the car must not be driven more quickly than the tyre is rated for. For example, cars with Q rating tyres must be driven at speeds not exceeding 160 km/h (100 mph). The road conditions and applicable road traffic rules determine how quickly the car can be driven, not the speed rating of the tyres.

Note

The maximum permitted speed is specified in the table.

Q	160 km/h (100 mph) (used only on winter tyres)
T	190 km/h (118 mph)
H	210 km/h (130 mph)
V	240 km/h (149 mph)
W	270 km/h (168 mph)
Y	300 km/h (186 mph)

 **Warning**

The lowest permitted load index (LI) and speed rating (SS) for the tyres for each respective engine variant are shown by the specifications. If a tyre with too low a load index or speed rating is used, it may overheat and be damaged.

[1] Both those with metal studs and those without.

16.2.2. Tyres' rotation direction

Tyres with a tread pattern which are designed to only turn in one direction have the direction of rotation marked with an arrow.

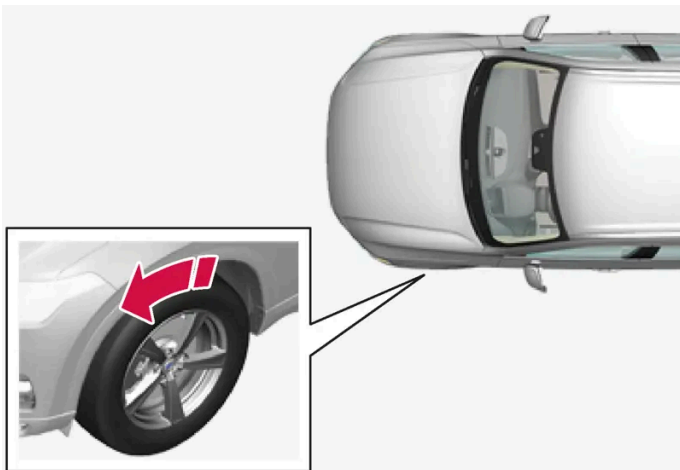

The arrow shows the tyre's direction of rotation.

- Tyres must rotate in the same direction during their entire service life.
- Tyres should only be switched between front and rear positions, never between left and right-hand sides, or vice versa.
- If the tyres are fitted incorrectly, the car's braking characteristics and capacity to force rain and slush out of the way are adversely affected.
- The tyres with the deepest tread depth should always be fitted to the rear of the car in order to reduce the risk of oversteer skidding.
- On cars with different front and rear tyre or wheel dimensions, it is not permitted to change position between front and rear wheels.
- Volvo recommends that the rear tyres do not have substantially less tread depth than the front tyres in order to reduce the risk of oversteer skidding when driving on wet roads.

 **Note**

Make sure that the front and rear axles have the same type, dimension and make of tyres.

Cars with different front and rear tyre dimensions must have the same type and make of tyres on the front and rear axles.

16.2.3. Tread wear indicators on the tyres

Tread wear indicators show the status of the tyre's tread depth.

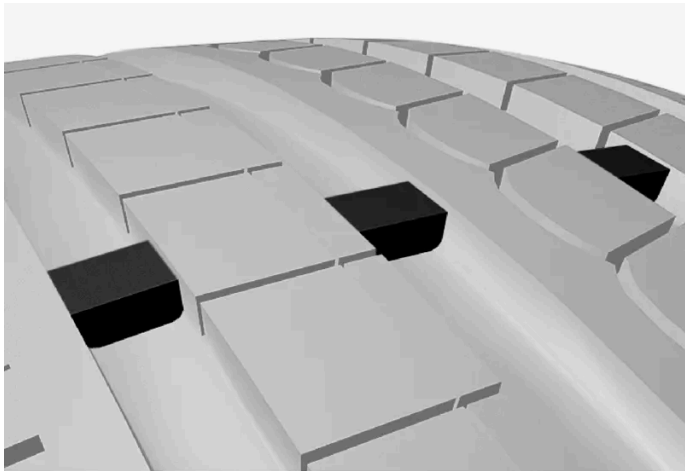

A tread wear indicator is a narrow elevation across the longitudinal grooves of the tyre's tread pattern. On the side of the tyre are the letters TWI (Tread Wear Indicator). When the tyre's tread depth is down to 1.6 mm (1/16 inch), the tread will be level in height with the tread wear indicators. Change to new tyres as soon as possible. Remember that tyres with little tread depth provide very poor grip in rain and snow.

16.2.4. Dimension designation for wheel rim

Wheel and rim dimensions are designated in accordance with the examples in the table below.

The car has an approval for the complete vehicle with certain combinations of wheel rims and tyres.

All wheel rims have a dimension designation, for example: 8.5Jx19x47.5.

8.5	Rim width in inches
J	Rim flange profile
19	Rim diameter in inches
47.5	Off-set in mm (distance from half wheel width to wheel contact surface against the hub)

16.2.5. Minimum permitted tyre load index and speed rating for tyres

The table below shows minimum permitted load index (LI) and speed rating (SS) for tyres.

Engine	Minimum permitted load index (LI) ^[1]	Minimum permitted speed rating (SS) ^[2]
B5 (B420T2)	96	H

^[1] The tyre's load index must be at least equal to or greater than indicated in the table.

^[2] The tyre's speed rating must be at least equal to or greater than indicated in the table.

16.3. Tyre pressure

16.3.1. Tyre pressure monitoring

16.3.1.1. Tyre pressure monitoring system *

The tyre pressure monitoring system^[1], gives a warning with an indicator symbol in the driver display when the pressure in one or more of the car's tyres is too low.



This symbol illuminates to indicate low tyre pressure. Check the tyre pressure in the **Car status** app in the centre display.

If there is a fault in the system the tyre pressure warning symbol flashes for approximately one minute and then remains illuminated.

System description

The tyre pressure monitoring system measures differences in rotation speed between the different wheels via the ABS system in order to be able to determine whether they have the correct tyre pressure. If the tyre pressure is too low, the tyre's diameter is changed and, as a result, so is its rotation speed. By comparing the tyres with each other the system can determine whether one or more tyres have pressure that is too low.

General information on the tyre pressure monitoring system

In the information below, the tyre pressure monitoring system is generally referred to as TPMS.

Each tyre, including the spare wheel*, should be checked once a month. When checking, the tyre should be cold and have the air pressure recommended by the car manufacturer specified on the tyre pressure label or in the tyre pressure table. If the car has tyres of a different size than that recommended by the manufacturer, find out what the correct air pressure level is for these.

As an extra safety feature, the car is equipped with a tyre pressure monitoring system (TPMS), which shows when the air pressure in one or more tyres is too low. When the indicator symbol for low air pressure is lit, stop and check the tyres as soon as possible and inflate to the correct air pressure.

Driving with tyres that have tyre pressure that is too low may cause the tyre to overheat, which can cause a tyre failure. Low tyre pressure also reduces fuel efficiency as well as tyre service life, and can affect car handling and stopping ability. Note that TPMS

The content of this manual represents the status of the user manual at the time of printing and may not be completely valid in future instances. For more information, refer to the first page for the complete disclaimer note.

does not replace regular tyre maintenance. It is the driver's responsibility to maintain correct tyre pressure, even if the limit for low tyre pressure has not been reached so that the indicator symbol illuminates.

The car is also equipped with a TPMS system fault indicator, which indicates when the system is not functioning correctly. The TPMS system fault indicator is combined with the indicator symbol for low tyre pressure. When the system detects a fault, the symbol in the driver display will flash for about one minute and then remain illuminated. This procedure will be repeated when the car is started until the fault has been rectified. When the symbol is illuminated, the system's ability to detect or warn of low tyre pressure may be affected.

A TPMS system fault can occur for several reasons, such as after changing to a spare tyre, or changing tyres or wheels that prevent TPMS from functioning correctly.

Always check the indicator symbol for TPMS after changing one or more tyres in order to ensure the new tyre or wheel is working correctly with TPMS.

To bear in mind

- Always save a new tyre pressure in the system after changing a tyre or adjusting tyre pressure.
- The use of snow chains may affect the tyre pressure monitoring system. This is indicated by a symbol and message in the driver display. When the snow chains are removed, all tyres should be checked and adjusted to the recommended tyre pressure. After that, the new tyre pressure needs to be saved in the tyre pressure monitoring system.
- If you change to tyres of a different size to the ones fitted at the factory, the system must be reset by storing a new tyre pressure for these tyres in order for the system to work correctly.
- If a spare wheel* is used, it is possible that the tyre pressure monitoring system will not work correctly due to the differences between the wheels.
- The system does not replace the need for regular tyre inspection and maintenance.
- It is not possible to switch off the tyre pressure monitoring system.

Warning

- Incorrect tyre pressure may lead to tyre failure, which could result in the driver losing control of the car.
- The system cannot indicate sudden tyre damage in advance.

* Option/accessory.

^[1] Indirect Tyre Pressure Monitoring System (iTPMS)

16.3.1.2. See tyre pressure status in the centre display*

With the system for tyre pressure monitoring^[1], tyre pressure status can be viewed in the centre display.

Checking status

Several minutes driving above 35 km/h (22 mph) are required for the system to become active.

- 1 Press  in the centre display.
- 2 Tap on **Car status** to view the tyre pressure status.

* Option/accessory.

^[1] Indirect Tyre Pressure Monitoring System (iTPMS)

16.3.1.3. Action in the event of warning for low tyre pressure

When the system for tyre pressure^[1] warns that tyre pressure is too low, action is required.



Check and rectify the tyre pressure when the indicator symbol for the system is illuminated and the message for low tyre pressure message is shown.

- 1 Switch off the car.
- 2 Check the tyre pressure in all four tyres with a tyre pressure gauge.
- 3 Inflate the tyres to the correct pressure, see the decal on the door pillar on the driver's side showing the recommended pressure for factory fitted tyres.
- 4 Always save a new tyre pressure in the system via the centre display after the tyre pressure has been adjusted. This can only be done when the car is running and stationary.

Note that the indicator symbol does not extinguish until storing a new tyre pressure has been started.

Several minutes of driving are required at a speed above 35 km/h (22 mph) in order for the system to be able to store the new reference value.

Note

To avoid incorrect tyre pressure, the pressure should be checked on cold tyres. "Cold tyres" means the tyres are the same temperature as the ambient temperature (approx. 3 hours after the car has been driven). After a few kilometres of driving, the tyres warm up and the pressure increases.

 **Note**

- After a tyre has been inflated, always refit the dust cap in order to avoid damage to the valve from gravel, dirt, etc.
- Only use plastic dust caps. Metal dust caps can rust and become difficult to unscrew.

 **Warning**

- Incorrect tyre pressure may lead to tyre failure, which could result in the driver losing control of the car.
- The system cannot indicate sudden tyre damage in advance.

^[1] Indirect Tyre Pressure Monitoring System (iTPMS)

16.3.1.4. Saving a new reference value for tyre pressure monitoring*

In order for the system for tyre pressure monitoring^[1] to work correctly, a reference value for the tyre pressure must be saved. This must take place every time the tyres are changed or the tyre pressure is changed so that the system can warn about low pressure correctly.

Perform the following procedure to store a new tyre pressure as a reference value in the system:

- 1 Switch off the car.
- 2 Inflate the tyres to the correct pressure, see the decal on the door pillar on the driver's side showing the recommended pressure for factory fitted tyres.
- 3 Start the car.
- 4 Press  in the centre display.
- 5 Press **Car status**.
- 6 Press **Store pressure**. The car must be running and stationary when storing a tyre pressure.

 **Note**

The **Store pressure** button is used to save new reference values for tyre pressures in the tyre pressure monitoring system. For safety reasons, it is only available (selectable) when the car is stationary and the engine is running.

- 7 The tyre pressure must be saved after adjusting tyre pressure or changing tyres. Adjust the tyre pressure to the recommended values and press **Confirm** to save the tyre pressure.

 **Note**

To avoid mistaken activation of the **Store pressure** function, it is necessary to confirm in a second step that the tyre pressure should be saved.

- 8 Drive the car until the new tyre pressure has been saved. The new tyre pressure is stored when the car is driven at a speed above 35 km/h (22 mph).
- When sufficient data have been collected for the system to be able to detect low tyre pressure, the animation showing the progress of storing the new reference value disappears from the centre display.

If storing fails, a message is shown.

 **Warning**

The exhaust gases contain carbon monoxide, which is invisible and odourless, but highly toxic. The procedure to save a new tyre pressure must therefore always be performed outdoors or in a workshop with exhaust extraction.

* Option/accessory.

^[1] Indirect Tyre Pressure Monitoring System (iTPMS)

16.3.1.5. Messages for tyre pressure monitoring*

A number of messages for the tyre pressure monitoring system^[1] can be shown. Here are some examples.

Centre display: Storing pressure is required due to updated software	The software has been updated and the tyre pressure needs to be saved again. Check the tyre pressures and inflate if necessary ^[2] .
Driver display: TPMS unavailable Open Car Status app to Store Pressure	The indicator symbol flashes and changes to constant glow after approximately 1 minute. See car status in the centre display for more information.
Driver display: Tyre pressure low Check Car Status app in center display	The indicator symbol switches on to indicate that there is low tyre pressure in one or more tyres. See car status in the centre display for more information ^[2] .
Driver display: Tyre pressure system Temporarily unavailable	The indicator symbol flashes and changes to constant glow after approx. 1 minute. The system is currently unavailable, activated shortly.
Driver display: Tyre pressure system Service required	The indicator symbol flashes and changes to constant glow after approx. 1 minute. Certain TPMS malfunctions may require the driver to switch off and lock the vehicle for 6 minutes for the control module to reset. If the system still does not work correctly, contact a workshop ^[3] .

* Option/accessory.

^[1] Indirect Tyre Pressure Monitoring System (iTPMS)

^[2] Always save a new tyre pressure in the system after the tyre pressure has been adjusted.

The content of this manual represents the status of the user manual at the time of printing and may not be completely valid in future instances. For more information, refer to the first page for the complete disclaimer note.

^[3] An authorised Volvo workshop is recommended.

16.3.2. Checking tyre pressure

Correct tyre pressure helps to improve driving stability, save energy consumption and extend the service life of the tyres.

Tyre pressure decreases over time, this is a natural phenomenon. Tyre pressure also varies depending on ambient temperature. Driving on tyres with tyre pressure that is too low could result in the tyres overheating and being damaged. Tyre pressure affects travelling comfort, road noise and driving characteristics.

Check the tyre pressures monthly. Use the recommended tyre pressure for cold tyres in order to maintain good tyre performance. Tyre pressure that is too low or too high may cause uneven wear on the tyres.

Warning

- Under-inflation is the most common cause of tyre failure. This may result in severe tyre cracking, tread separation, or "blow-out", with reduced control of the vehicle, which may lead to increased risk of injury.
- Tyres with pressure that is too low reduce the load capacity of the car.

Cold tyres

The tyre pressure must be checked when the tyres are cold. Tyres are considered cold when they have the same temperature as the surrounding air. This temperature is normally reached when the car has been parked for at least three hours.

After having driven approximately 1.6 km (1 mile) these tyres are considered as warm. If you have to drive further than this to inflate the tyres, first check and record the tyre pressure. Then inflate to a suitable tyre pressure when you arrive at the pump.

When the outside temperature changes, the tyre pressure also changes. A decrease in temperature of 10 degrees causes the tyre pressure to decrease 7 kPa (1 psi). Check the tyre pressure regularly and adjust to the correct pressure, which is specified on the car's tyre information decal or certification label.

If you check the tyre pressure when the tyres are warm then you must never release any air. The tyres are warm due to driving and it is normal for the pressure to increase above the recommended pressure for cold tyres. A warm tyre with tyre pressure equal to or below the recommendation for cold tyres may have a pressure that is far too low.

16.3.3. Adjusting tyre pressure

Tyre pressure decreases over time, this is a natural phenomenon. The tyre pressure must therefore sometimes be adjusted in order to maintain the recommended tyre pressure.

Use the recommended tyre pressure for cold tyres in order to maintain good tyre performance and even tread wear.

i Note

To avoid incorrect tyre pressure, the pressure should be checked on cold tyres. "Cold tyres" means the tyres are the same temperature as the ambient temperature (approx. 3 hours after the car has been driven). After a few kilometres of driving, the tyres warm up and the pressure increases.

- 1 Remove the cap from the valve on one tyre and then press down the tyre pressure gauge firmly onto the valve.
- 2 Inflate the tyre to the correct pressure, see the decal on the door pillar on the driver's side showing the recommended pressure for factory fitted tyres.
- 3 Refit the dust cap.

i Note

- After a tyre has been inflated, always refit the dust cap in order to avoid damage to the valve from gravel, dirt, etc.
- Only use plastic dust caps. Metal dust caps can rust and become difficult to unscrew.

- 4 Check the tyre visually for any implanted nails or other objects that could puncture the tyre and cause leakage.
- 5 Check the sidewalls for any cavities, cuts, bumps or other irregularities.
- 6 Repeat this for all tyres, including the spare tyre*.

i Note

If you have over-inflated, release air by pressing in the metal pin in the centre of the valve. Then check the pressure again using the tyre pressure gauge.

Some spare tyres require a higher tyre pressure than other tyres. Check in the tyre pressure table or on the tyre pressure label.

* Option/accessory.

16.3.4. Approved tyre pressures

Approved tyre pressures for each engine alternative can be found in the table.

Note

All engines, tyres or combinations of these are not always available in all markets.

Tyre dimension	Speed	Load, 1-3 persons		Max. load		ECO pressure ^[1]
		Front kPa (psi) ^[2]	Rear kPa (psi)	Front kPa (psi)	Rear kPa (psi)	Front/rear kPa (psi)
245/45 R18 255/40 R19	0-180 km/h (0-112 mph)	230 (33)	230 (33)	280 (41)	280 (41)	280 (41)
255/35 R20	0-180 km/h (0-112 mph)	240 (35)	240 (35)	280 (41)	280 (41)	280 (41)
245/35 R21	0-180 km/h (0-112 mph)	250 (36)	250 (36)	280 (41)	280 (41)	280 (41)
Temporary Spare Tyre	max 80 km/h (max 50 mph)	420 (60)	420 (60)	420 (60)	420 (60)	–

^[1] Economical driving.

^[2] In certain countries the "bar" unit is used alongside the SI unit "Pascal": 1 bar = 100 kPa.

16.3.5. Location of tyre pressure label

The tyre pressure label on the driver's side door pillar (between frame and rear door) shows which pressures the tyres should have at different loads and speed conditions.

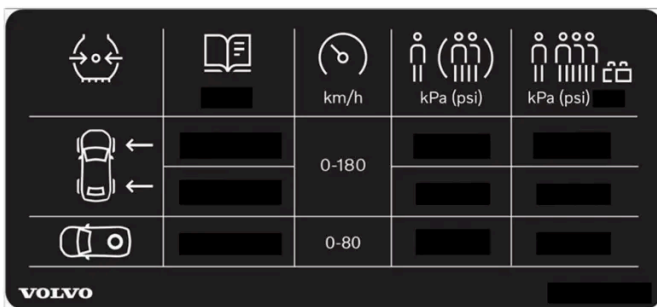

Tyre pressure label

The decal displays the designation for the factory-fitted tyres on the car, as well as load limits and tyre pressure.

Note

It is not intended that the decals illustrated in the owner's manual should be exact replicas of those in the car. They are included to show their approximate appearance and locations in the car. The information that applies to your particular car can be found on the decal on the car.

Improved fuel economy with ECO pressure

For a light load (max. 3 people) and a speed of up to 180 km/h (112 mph), the ECO pressures can be chosen for more economic energy consumption. However, the lower comfort pressures are recommended instead if improved noise and travelling comfort are desired.

16.4. Emergency puncture repair

16.4.1. Emergency puncture repair kit

The emergency puncture repair kit (TMK^[1]) is used to seal a puncture as well as to check and adjust the air pressure in the tyre.

Cars equipped with spare tyre* do not have the emergency puncture repair kit.

The puncture repair kit consists of a compressor and a bottle with sealing fluid. The sealing works as a temporary repair.

i Note

The sealing fluid is effective at sealing tyres with tread punctures but has limited ability to seal tyres with sidewall punctures. Do not use the emergency puncture repair kit on tyres displaying larger slits, cracks or similar damage.

i Note

The compressor is intended for temporary emergency puncture repair and is approved by Volvo.

Location

The puncture repair kit is located in the foam block under the cargo area floor.



Sealing fluid expiry date

The bottle of sealing fluid must be replaced if the bottle's expiry date has passed (see the decal on the bottle). Treat the old bottle as environmentally hazardous waste.

[1] Temporary Mobility Kit

* Option/accessory.

16.4.2. Inflating tyres with the compressor from the puncture repair kit

The car's original tyres can be inflated using the compressor in the emergency puncture repair kit.

- 1 The compressor must be switched off. Make sure that the switch is in position 0 (Off), and take out the electrical cable and the air hose.
- 2 Unscrew the tyre's dust cap and screw in the air hose's valve connection to the bottom of the thread on the tyre's air valve.

Check that the pressure reducing valve on the air hose is fully screwed in.

- 3 Connect the electrical cable to the closest 12 V socket and start the car.

 **Warning**

Inhaling car exhaust fumes could result in danger to life. Never leave the engine running in sealed areas or areas that lack sufficient ventilation.

 **Warning**

Do not leave children in the car without supervision when the car is running.

- 4 Start the compressor by flicking the switch to position I (On).

5  **Important**

Risk of overheating. The compressor must not run for more than 10 minutes.

Inflate the tyre to the pressure specified on the tyre pressure label on the driver side door pillar. Release air using the pressure reducing valve if the tyre pressure is too high.

- 6 Switch off the compressor. Detach the air hose and the electrical cable.

Refit the dust cap on the tyre.

The content of this manual represents the status of the user manual at the time of printing and may not be completely valid in future instances. For more information, refer to the first page for the complete disclaimer note.

7
8 If necessary, save a new tyre pressure in the system for tyre pressure monitoring.*

i Note

- After a tyre has been inflated, always refit the dust cap in order to avoid damage to the valve from gravel, dirt, etc.
- Only use plastic dust caps. Metal dust caps can rust and become difficult to unscrew.

i Note

The compressor is an electrical device. Follow local regulations related to waste management.

* Option/accessory.

16.4.3. Using a puncture repair kit

The emergency puncture repair kit (TMK^[1]) can be used to seal a puncture. Read through all instructions before use.

Overview



- 1 Electrical cable
- 2 Air hose
- 3 Pressure reducing valve
- 4 Protective cap
- 5 Label, maximum permitted speed
- 6 Bottle holder (orange cap)

- 7 Pressure gauge
- 8 Sealing fluid bottle
- 9 Switch

Connecting

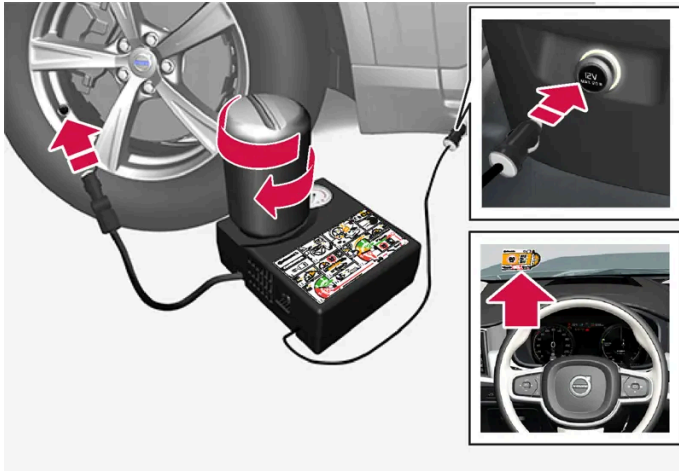

Note

Do not break the bottle's seal before use. The seal is broken automatically when the bottle is screwed in.

Warning

Please keep the following points in mind when using the tyre sealing system:

- The sealing fluid bottle contains ethane-1,2-diol and natural rubber latex. This substance is harmful if swallowed.
- The contents of this bottle may cause allergic skin reactions or otherwise be potentially harmful to the respiratory tract, the skin, the central nervous system, and the eyes.

Precautions:

- Store out of the reach of children.
- Harmful if ingested.
- Avoid prolonged or repeated contact with the skin. If sealing fluid has come into contact with your clothes, remove them.
- Wash thoroughly after handling.

First aid:

- Skin: Wash affected areas of skin with soap and water. Get medical attention if symptoms occur.
- Eyes: Flush with plenty of water for least 15 minutes, occasionally lifting the upper and lower eyelids. Get medical attention if symptoms occur.
- Inhalation: Move the exposed person to fresh air. If irritation persists, get medical attention.
- Ingestion: Do NOT induce vomiting unless directed to do so by medical personnel. Get medical attention.
- Disposal: Dispose of this material and its container at a hazardous or special waste collection point.

 **Warning**

Do not remove the bottle or air hose while the puncture repair kit is being used.

 **Note**

If the puncture was caused by a nail or similar, leave it in the tyre. It helps to seal the hole.

1 Preparations

Set up the warning triangle and activate the hazard warning lights if a tyre is being sealed in a trafficked location.

- 2 Detach the decal for maximum permitted speed that is affixed on one side of the compressor. Affix it visibly on the wind-screen as a reminder to observe the speed limit. You should not drive faster than 80 km/h (50 mph) after the emergency tyre repair kit has been used.
- 3 Check that the switch is in position 0 (Off) and locate the electrical cable and the air hose.
- 4 Unscrew the orange-coloured cap from the compressor and unscrew the cork from the sealing fluid bottle.
- 5 Screw in the bottle to the bottom of the bottle holder.

The bottle and the bottle holder are equipped with a reverse catch to prevent sealant leakage. When the bottle is screwed in it cannot be unscrewed from the bottle holder again. The bottle must be removed at a workshop^[2].

 **Warning**

Do not unscrew the bottle, it is equipped with a reverse catch to prevent leakage.

- 6 Unscrew the tyre's dust cap and screw in the air hose's valve connection to the bottom of the thread on the tyre's air valve.

Check that the pressure reducing valve on the air hose is fully screwed in.

7 Begin puncture repair

Connect the electrical cable to the closest 12 V socket and start the car.

 **Note**

Make sure that none of the other 12 V sockets is in use when the compressor is operating.

 **Warning**

Do not leave children in the car without supervision when the car is running.

 **Warning**

Inhaling car exhaust fumes could result in danger to life. Never leave the engine running in sealed areas or areas that lack sufficient ventilation.

- 8 Start the compressor by flicking the switch to position I (On).

When the compressor starts, the pressure can increase up to 6 bar (88 psi), but the pressure drops after about 30 seconds.

 **Warning**

Never stand next to the tyre when the compressor is running. If cracks or unevenness arise then the compressor must be switched off immediately. The journey should not be continued. Call roadside assistance for recovery to a tyre centre. Volvo recommends an authorised tyre centre.

- 9 Inflate the tyre for 7 minutes.

 **Important**

The compressor must not be operated for longer than 10 minutes - risk of overheating.

- 10 Switch off the compressor to check the pressure on the pressure gauge. Minimum pressure is 1.8 bar (26 psi) and maximum is 3.5 bar (51 psi). Release air by pressing the pressure reducing valve if the tyre pressure is too high.

 **Warning**

If the pressure is below 1.8 bar (26 psi) then the hole in the tyre is too big. The journey should not be continued. Call roadside assistance for recovery to a tyre centre. Volvo recommends an authorised tyre centre.

- 11 Switch off the compressor and detach the electrical cable.
- 12 Unscrew the air hose from the tyre valve and refit the dust cap on the tyre.

 **Note**

- After a tyre has been inflated, always refit the dust cap in order to avoid damage to the valve from gravel, dirt, etc.
- Only use plastic dust caps. Metal dust caps can rust and become difficult to unscrew.

- 13 Fit the protective cap on the air hose in order to avoid leakage of the remaining sealing fluid. Place the equipment in the cargo area.
- 14 As soon as possible, drive at least 3 km (2 miles) at a maximum speed of 80 km/h (50 mph) so that the sealing fluid can seal the tyre, and then perform a follow-up check.

 **Warning**

Sealant will spurt out of the puncture during the first few rotations of the tyre. Make sure that nobody is standing near the car and gets the sealing fluid splashed onto them when the car is driven away. The distance should be at least 2 metres (7 feet).

15 Follow-up inspection

Connect the air hose on the tyre valve and screw in the valve connection to the bottom of the tyre valve's thread. The compressor must be switched off.

16 Read the tyre pressure on the pressure gauge.

- If it is below 1.3 bar (19 psi) then the tyre is insufficiently sealed. The journey should not be continued. Call roadside assistance for recovery.
- If the tyre pressure is higher than 1.3 bar (19 psi), the tyre must be inflated to the pressure specified in accordance with the tyre pressure label on the driver's side door pillar (1 bar = 100 kPa = 14.5 psi). Release air using the pressure reducing valve if the tyre pressure is too high.

 **Warning**

Check the tyre pressure regularly.

Volvo recommends that the car is driven to the nearest authorised Volvo workshop for the replacement/repair of the damaged tyre. Advise the workshop that the tyre contains sealing fluid.

The sealing fluid bottle and hose must be replaced after use. Volvo recommends that these replacements be performed by an authorised Volvo workshop.

 **Warning**

Maximum mileage with tyres containing sealing fluid is 200 km (120 miles).

 **Note**

The compressor is an electrical device. Follow local regulations related to waste management.

^[1] Temporary Mobility Kit

^[2] An authorised Volvo workshop is recommended.

16.5. Winter driving

16.5.1. Snow chains

Use of snow chains and winter tyres can help to improve the traction in winter conditions.

Volvo recommends that snow chains are not used on wheel dimensions greater than 18 inches.

Warning

Use Volvo genuine snow chains or equivalent chains designed for the car model, and tyre and rim dimensions. Only **single-sided** snow chains are permitted.

In the event of uncertainty about the snow chains, Volvo recommends contacting an authorised Volvo workshop. The wrong snow chains may cause serious damage to the car and lead to an accident.

Using snow chains may result in malfunction of the tyre pressure monitoring system* ^[1].

Important

Snow chains can be used on the car with the following restrictions:

- Always follow the mounting instructions from the manufacturer carefully. Fit the chains as tensioned as possible and tension them at regular intervals.
- Snow chains must only be used on the front wheels (also applies to all-wheel drive cars).
- In some cases, snow chains must NOT be used, such as if accessory, aftermarket or "special" tyres and wheels are fitted that have a different size to the original tyres and wheels. Sufficient distance must be maintained between the chains and brakes, suspension and body components.
- Check local regulations with regard to using snow chains before fitting them.
- Never exceed the chain manufacturer's specified maximum speed. You must never exceed 50 km/h (30 mph) under any circumstances.
- Avoid bumps, holes or sharp turns when driving with snow chains.
- Avoid driving on bare ground as this wears out both the snow chains and tyres.
- Driving with snow chains may have a negative effect on the car's driving characteristics. Avoid fast or sharp turns, as well as braking with locked wheels.
- Some types of chain that are firmly tensioned affect brake components and must therefore NOT be used.

You can obtain more information on snow chains from a Volvo dealer.

* Option/accessory.

^[1] Indirect Tyre Pressure Monitoring System (ITPMS)

16.5.2. Winter tyres

The content of this manual represents the status of the user manual at the time of printing and may not be completely valid in future instances. For more information, refer to the first page for the complete disclaimer note.

Winter tyres are adapted for winter road conditions.

Volvo recommends winter tyres with particular dimensions. Tyre dimensions are dependent on engine variant. When driving on winter tyres, the correct type of tyres must be fitted to all four wheels.

A tyre that meets the minimum values for traction on snow has the following symbol on the tyre label.



The tyre label for a tyre that meets the relevant minimum values for traction on ice must include the following symbol:



Studded tyres are not included in tyre marking.

Tips for changing to winter tyres

When summer and winter wheels are changed, mark which side of the car they were mounted on, for example **L** for left and **R** for right.

Contact a Volvo dealer for advice about which wheel rim and tyre types are most suitable.

Studded tyres

Studded winter tyres should be run in gently for 500-1000 km (300-600 miles), so the studs settle properly into the tyres. This gives the tyre, and especially the studs, a longer service life.

Note

Laws regarding the use of studded tyres may vary. Always follow local laws and regulations.

Tread depth

Road conditions with ice, slush and low temperatures place considerably higher demands on tyres than summer conditions. Volvo therefore recommends not to drive on winter tyres that have a tread depth of less than 4 mm (0.15 inches).

16.5.3. Preparations for a long trip

Before a driving holiday or some other type of long journey, it is important to check the car's functions and equipment particularly carefully.

Check that

- the engine is working normally and that fuel consumption is normal

- there is no leakage of fluids
 - braking effect on braking works as intended
 - all lamps are working - adjust headlamp level if the car is heavily laden
 - the tyres have sufficient tread depth and pressure. Change to winter tyres when driving to areas where there is a risk of snowy or icy road surfaces
 - starter battery charging is good
 - the wiper blades are in good condition
 - a warning triangle and high-visibility vest are located in the car - legally required in certain countries
-

16.5.4. Winter driving

For winter driving it is important to perform certain checks of the car in order to ensure that it can be driven safely.

Check the following in particular before a cold season:

- The engine coolant must contain 50% glycol. This mixture protects the engine against frost down to approx. -35°C (-31°F). To avoid health risks, different types of glycol must not be mixed.
- The fuel tank must be kept filled to prevent condensation.
- Engine oil viscosity is important. Oils with lower viscosity (thinner oils) facilitate starting in cold weather and also reduce fuel consumption while the engine is cold.
- The condition of the starter battery and charge level must be inspected. Cold weather places great demands on the starter battery and its capacity is reduced by the cold.
- The condition of the battery and its charge level must be inspected. Cold weather places higher demands on the battery and its capacity is reduced by the cold.
- Use washer fluid with antifreeze to avoid ice forming in the washer fluid reservoir.

See the separate section for engine oil recommendations.

Slippery driving conditions

To achieve optimum roadholding Volvo recommends using winter tyres on all wheels if there is a risk of snow or ice.

Note

The use of winter tyres is a legal requirement in certain countries. Studded tyres are not permitted in all countries.

Practise driving on slippery surfaces under controlled conditions to learn how the car reacts.

16.6. Tyres

The function of the tyres is to carry load, provide grip on the road surface, dampen vibration and protect the wheel from wear.

The tyres greatly affect the car's driving characteristics. The type of tyre, dimensions, tyre pressure and speed rating are important for how the car performs.

The car is fitted with tyres according to the tyre information sticker found on the driver's side door pillar (between the front door and the rear door).

Warning

A damaged tyre may lead to loss of control over the car.

Recommended tyres

On delivery, the car is equipped with Volvo original tyres that have the VOL ^[1] marking on the side of the tyres. These tyres are carefully adapted to the car. In the event of changing tyres, it is therefore important that the new tyres also have this marking in order for the car's driving characteristics, comfort and energy consumption to be maintained.

New tyres

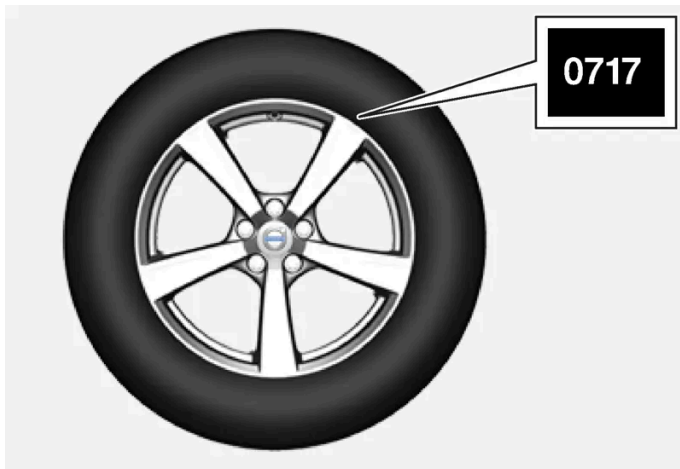

Tyres are perishable. After a few years they begin to harden at the same time as the friction capacity/characteristics gradually deteriorate. For this reason, aim to get as fresh tyres as possible when you replace them. This is especially important with regard to winter tyres. The last four digits in the sequence mean the week and year of manufacture. This is the tyre's DOT marking (Department of Transportation), and this is stated with four digits, for example 0717. The tyre is then manufactured in week 07, year 2017.

Tyre age

All tyres older than 6 years old should be checked by an expert even if they seem undamaged. Tyres age and decompose, even if they are hardly ever or never used. The function can therefore be affected. This applies to all tyres that are stored for future use. Examples of external signs which indicate that the tyre is unsuitable for use are cracks or discolouration.

Tyre economy

The content of this manual represents the status of the user manual at the time of printing and may not be completely valid in future instances. For more information, refer to the first page for the complete disclaimer note.

- Maintain the correct tyre pressure.
- Avoid fast starts, heavy braking and squealing tyres.
- Tyre wear increases with speed.
- Correct wheel alignment is very important.
- Unbalanced wheels worsen tyre economy and travelling comfort.
- The tyres should rotate in the same direction during their entire service life.
- When you change tyres, the tyres with the deepest tyre tread can be fitted on the rear axle in order to reduce the risk of oversteer skidding during aquaplaning, cornering or sudden braking on wet roads.
- If you drive over kerbstones or deep holes you can damage the tyres and/or wheel rims permanently.
- On cars with different front and rear tyre or wheel dimensions, it is not permitted to change position between front and rear wheels.

Tyre rotation

Driving style, tyre pressure, climate and road condition affect how quickly the tyres age and wear. Correct tyre pressure results in more even wear.

To avoid major differences in tread depth, and to prevent wear patterns forming on the tyres, the front and rear wheels can be switched with each other. A suitable distance for the first change is approx. 5000 km (approx. 3100 miles) and then at 10000 km (approx. 6200 miles) intervals.

Volvo recommends that an authorised Volvo workshop is contacted for checking if you are uncertain about tread depth. If significant differences in wear (> 1 mm difference in tread depth) between tyres have already occurred, then the least worn tyres should be fitted on the rear. Understeer skidding is normally easier to correct than oversteer skidding. This is why it is important for the rear wheels not to lose grip before the front wheels.

Important

Cars with different tyre or wheel dimensions on the front and rear axles must always have the wider tyres and/or wheels on the rear axle. It is therefore not permitted to change between front and rear wheels in order to obtain a more even tyre wear between front and rear tyres, for example.

Storing wheels and tyres

When you store complete wheels (tyres fitted on wheel rims) they should be hung up or positioned lying on their sides on the floor.

Tyres not fitted on rims must be stored lying on their sides or standing upright, but not hung up.

Important

Tyres should be stored in a cool, dry and dark place. They should never be stored near solvents, petrol, oils, etc.

 **Warning**

- Wheel rim size and tyre size for your Volvo are specified to meet stringent requirements for stability and driving characteristics. Unapproved combinations of wheel rim size and tyre size may have a negative effect on the car's stability and driving characteristics.
- Any damage caused by the fitting of unapproved combinations of wheel rim size and tyre size is not covered by the new car warranty. Volvo accepts no liability for death, personal injury or any costs caused by such installations.

^[1] There may be deviations for certain tyre dimensions.

16.7. Approved wheel and tyre sizes

In certain countries not all approved sizes are indicated by the registration document or other documents. The following table shows all approved combinations of wheel rims and tyres.

✓ = Approved

Engine	245/45R18 8x18x42	255/40R19 8,5x19x47	255/35R20 8,5x20x47,5	245/35R21 8,5x21x44,5
B5 (B420T2)	✓	✓	✓	✓

17. Loading, storage and passenger compartment

17.1. Loading

17.1.1. Recommendations for loading

There are a number of things that are important to bear in mind when loading the car.

Payload depends on the car's kerb weight. The total of the weight of the passengers and all accessories reduces the car's payload by a corresponding weight.

 **Warning**

The car's driving properties change depending on the weight and positioning of the load.

Loading in the cargo area

Good things to remember when loading:

- Position the load firmly against the rear seat's backrest.
- Heavy objects should be placed as low as possible. Avoid placing heavy loads on lowered backrests.
- Cover sharp edges with something soft to avoid damaging the upholstery.
- Secure all loads to the load retaining eyelets with straps or web lashings.

 **Warning**

A loose object weighing 20 kg (44 pounds) can, in a frontal collision at a speed of 50 km/h (30 mph) carry the impact of an item weighing 1000 kg (2200 pounds).

 **Warning**

Leave 10 cm (4 inches) space between the load and the side windows if the car is loaded to above the top edge of the door windows. Otherwise, the intended protection of the inflatable curtain, which is concealed in the headlining, may be compromised.

 **Warning**

Always secure the load. During heavy braking the load may otherwise shift, causing injury to the car's occupants.

Cover sharp edges and sharp corners with something soft.

Switch off the engine and apply the parking brake when loading/unloading long items. Otherwise you may accidentally knock the gear lever or gear selector with the load into a drive position - and the car could then move off.

Increasing the space in the cargo area

To expand the cargo area and simplify loading, the rear seat's backrest can be lowered. Note that objects must not prevent the function of the WHIPS system for the front seats if any of the rear seat's backrests is folded down.

A through-load hatch in the rear seat can be folded down for carrying long and narrow loads.

17.1.2. Bag hooks

Bag hooks keep carrier bags in place and prevent them from overturning and spreading their contents across the cargo area.

Along the sides



There are two bag hooks in the side panel on each side of the cargo area.

There are two bag hooks in the side panel on each side of the cargo area.

 **Important**

The bag hooks may be loaded with a maximum of 5 kg (11 lbs).

Under the floor hatch *



There are two bag hooks and an elastic strap^[1] in the cover, which is part of the floor hatch in the cargo area. The strap can be fitted in four different positions.

Lift up the cover in order to use the bag hooks. Fasten the bags in a suitable position with the enclosed elastic strap. If the bags have handles and are a suitable height - hang them in the hooks.

* Option/accessory.

^[1] It is possible to reorder additional elastic straps at a Volvo dealer.

17.1.3. Operating cargo cover *

There are two extended positions for the cargo cover - a full-cover position and a loading position, where it is partially extended to make it easier to reach further into the cargo area.

Full-cover position

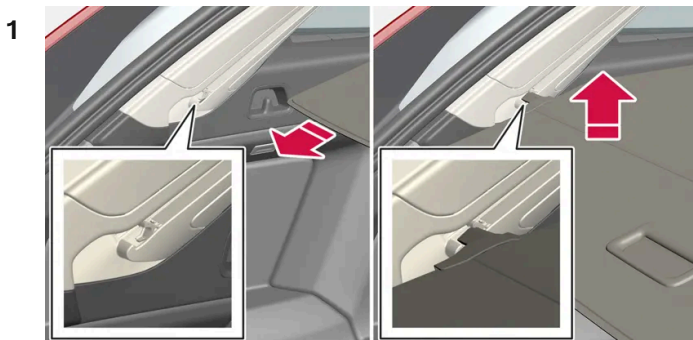

Grip the handle and pull out the cargo cover so that it slides over the side panels in the cargo area. Pull to the end position.

- 2 Guide the cover's attachment pins into the grooves in the side panels. Release, while at the same time angling the handle slightly upwards so that the attachment pins hook in.
- The cargo cover is locked in the full-cover position.

 **Important**

Do not load objects on top of the cargo cover.

Loading mode

From the full-cover position:

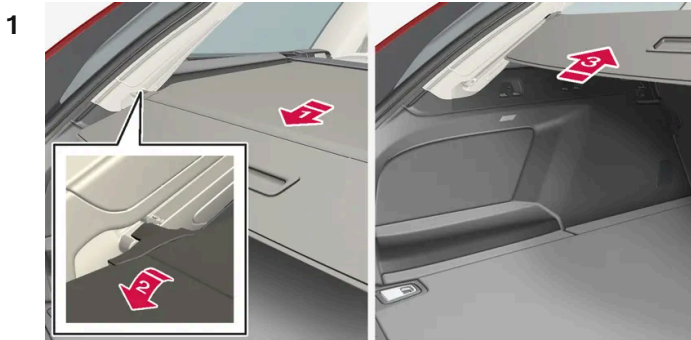

Grasp the handle and pull it back until it stops.



Angle the cover down.



Move the cover and its attachment pins carefully forward and up over the hooks.

- The cover retracts until it stops in the loading position.

Returning to full-cover position from loading position:

- 1 Grip the handle and pull the cargo cover out to the end position.
 - 2 Release the handle so that the attachment pins hook into the hooks.
- The cover is locked in the full-cover position.

With an automatic* cargo cover, the cover will be retracted from full-cover position to loading position every time the tailgate is opened, and extended again when the tailgate is closed. The cargo cover detects if something is obstructing its movement and then retracts automatically.

 **Warning**

Pay attention to the risk of crushing when opening and closing with the automatic* cargo cover.

 **Important**

If the cargo area is loaded with a bulky load then the automatic* cargo cover is moved to retracted position in order to avoid it making contact with the load.

 **Note**

The cargo cover may not operate automatically in low passenger compartment temperatures.

Retracting

1 From the full-cover position:

Lift up the handle and pull it backward to disengage the cargo cover's attachment pins and then release.

From loading position:

Grip the handle and pull out the cargo cover in the grooves - pull to the full-cover position. Lift up the handle and pull it backward to disengage the attachment pins and then release.

2 Retract the cover with its attachment pins outside of the side panels until it stops in the retracted position.

Remember that a retracted cargo cover may obstruct rearward visibility.

* Option/accessory.

17.1.4. Fitting and removing cargo cover*

In the extended position, the cargo cover prevents visual access to the cargo area.

Fitting cargo cover

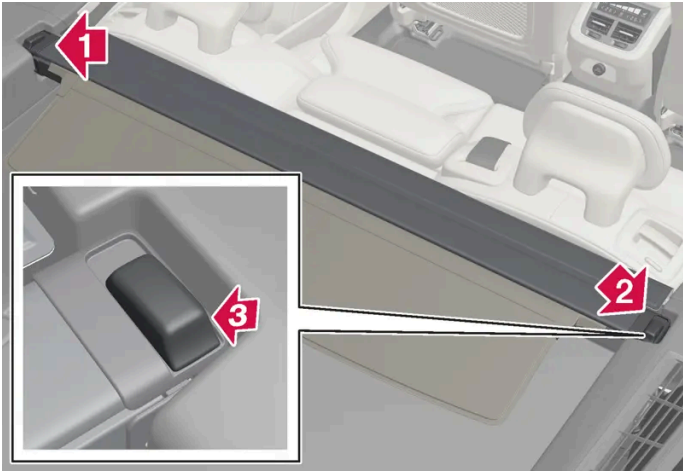

1  Insert one of the cargo cover's end pieces in the recess in the side panel in the cargo area.

2  Then insert the other end piece in the recess in the side panel on the opposite side.

3  Press down the end pieces on both sides - one by one.

➤ "When a ""click"" is heard and the red marking on each end piece has disappeared, the cargo cover is attached - check that it is affixed securely."



Fold the cargo cover's front panel forward to eliminate the space between the cargo cover and the rear seat's backrests.

Important

The cover plate has two plastic parts that act as support to hold it in place.

The plastic parts must not be used to hang bags on. They are not designed for this purpose and may break.

If the safety net* shall be used at the same time as the cargo cover then the safety net must be fitted first.

Removing cargo cover

In retracted position:

- 1 Depress the button on one of the retracted cargo cover's end pieces and lift out that end.
- 2 Angle the cover up/out carefully.
 - The other end piece loosens automatically and the cover can be lifted out of the cargo area.

* Option/accessory.

17.1.5. Load retaining eyelets

Use the load retaining eyelets to attach straps in order to anchor items in the cargo area.

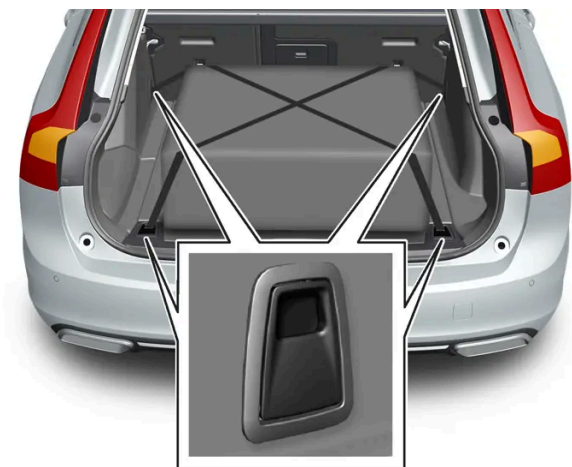

Warning

Hard, sharp and heavy objects that are loose or protrude may cause injury during heavy braking.

Always secure large and heavy objects with a seatbelt or cargo retaining straps.

17.1.6. Fitting and removing safety grilles *

The safety grille prevents loads or pets in the cargo area from being thrown forward in the passenger compartment under heavy braking.

The safety grille is crash-tested in accordance with the ECE R17 legal requirement and fulfils Volvo's strength requirements.



For safety reasons, the safety grille must always be attached and anchored correctly.

 **Warning**

Under no circumstances may anybody remain in the cargo area while the car is moving. This is to avoid injury in the event of heavy braking or an accident.

Installation

 **Important**

The safety grille must only be used in the rear position (behind the rear seat) described here.

Before first installing the safety grille, the existing plastic roof mountings must be replaced with steel roof mountings. Volvo recommends that replacing roof mountings is performed at an authorised Volvo workshop or retailer.

- 1 Fold the rear seat's backrest forward.
- 2 Make sure that the safety grille is turned in the right direction. Lift in the safety grille through one of the rear side doors.



Position the safety grille's brackets on the roof mountings.

The next step is facilitated if two people hold the safety grille in the right position.

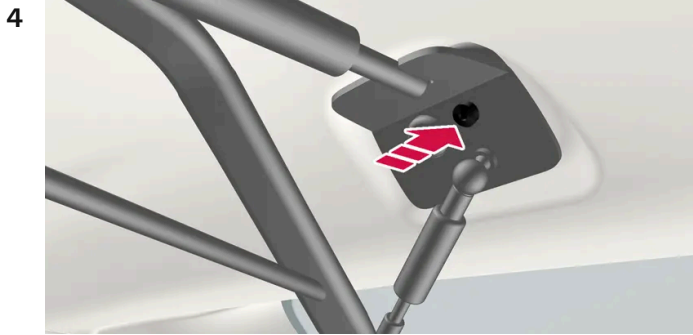

Insert the supplied screw and tighten using the supplied 6 mm Allen key. Repeat on the other side. Recommended tightening torque: 20 Nm (15 foot-pounds).

➤ Check that the safety grille is properly fitted.

5 Restore the backrest to the upright position.

For more information about the tools required and methods for fitting/removal, see the installation instructions^[1] that were included with the initial purchase.

 **Important**

The safety grille cannot be folded up or down when a cargo cover is fitted.

* Option/accessory.

^[1] Installation instructions no. 31659257.

17.1.7. Fitting and removing the safety net*

The safety net prevents loads from being thrown forward in the passenger compartment in the event of sudden braking.

The safety net is fitted into four mounting points.

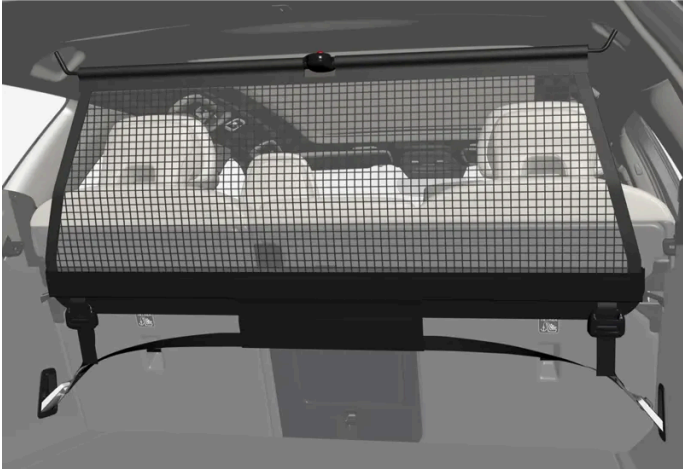

For reasons of safety, the safety net must always be fastened and anchored as described below.

The net is made of a strong nylon fabric and can be secured two different locations in the car:

- Front fitting - behind the front seats.
- Rear fitting - behind the rear seat.

 **Warning**

Loads in the luggage compartment must be anchored well, and also using a correctly fitted safety net.

Fitting the safety net

 **Warning**

Check that the safety net's upper mountings are correctly fitted and that the puller-straps are securely hooked on.
Damaged safety nets must not be used.

 **Note**

With forward mounting, the safety net is most easily mounted via the rear doors.

- 1 Unfold the safety net and make sure that the split upper rod in the net is locked in its extended position.
- 2 Hook one retaining hook of the net into the front or rear roof mounting with the anchoring strap locks turned towards you.
- 3 Hook the net's second attachment hook to the roof bracket on the opposite side.

The telescopically sprung attachment hooks make it easier to fit.

Take care to press forward the net's retaining hooks for each respective roof mounting's front end position.

The content of this manual represents the status of the user manual at the time of printing and may not be completely valid in future instances. For more information, refer to the first page for the complete disclaimer note.

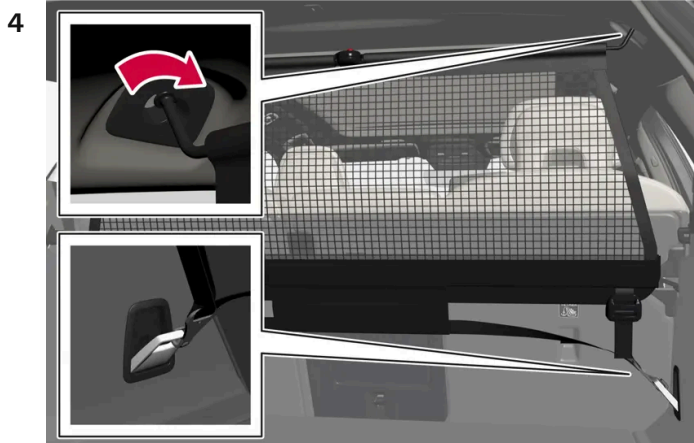

For rear fitting:

With the net fitted in the rear roof mountings, hook the safety net's puller-straps into the front load retaining eyelets in the cargo area.



For front fitting:

With the net fitted in the front roof mountings, hook the puller-straps into the outer eyes on the rear of all seat slide rails. The procedure is facilitated if the backrests are straightened and the seats are moved forward slightly.

Pay attention to make sure that you do not exert hard pressure on the net when the seat and backrest are moved back again. Only adjust until the seat or backrest makes contact with the net.

 **Important**

If a seat or backrest is pushed backwards hard into the safety net, the net and roof mounts may be damaged.

5 Tension the safety net with the anchoring straps.

Removing the safety net

The safety net can be easily removed and folded up.

- 1 Reduce safety net tension by pressing the button in the anchoring strap lock and feeding out a little of the anchoring strap on each side.
- 2 Press in the catches and detach both of the anchoring strap's hooks.
- 3 Undo the upper attachments and release the net from the roof mountings.
- 4 Press the red button on the rod to enable folding and then roll up the net. Store the net in its case.

* Option/accessory.

17.1.8. Roof load and loading on load carriers

For loading on the car's roof, the load carriers that Volvo have developed are recommended.

This is to reduce the risk of damage to the car. Volvo's load carriers are available for purchase at authorised Volvo retailers.

Carefully follow the installation instructions supplied with the carriers.

- Distribute the load evenly over the load carriers. Put the heaviest objects at the bottom.
- Check periodically that the load carriers and load are properly secured. Lash the load securely with retaining straps.
- If the load is longer than the car at the front, e.g. a canoe or kayak, fit the towing eye to its front socket and attach the bungee to this.
- The size of the area exposed to the wind, and therefore fuel consumption, increase with the size of the load.
- Drive gently. Avoid quick acceleration, heavy braking and hard cornering.

Warning

The car's centre of gravity and driving characteristics are altered by roof loads.

Follow the car's specifications with regard to weights and maximum permitted load.

17.1.9. Towbar-mounted bicycle rack *

When using a bicycle rack, the bicycle racks that Volvo has developed are recommended.

This is in order to avoid damage to the car and in order to achieve the maximum possible safety during a journey. Volvo's bicycle racks are available for purchase at authorised Volvo dealers.

Carefully follow the instructions enclosed with the bicycle rack.

- Bicycle rack including load must weigh a maximum of 75 kg (165 pounds).

The content of this manual represents the status of the user manual at the time of printing and may not be completely valid in future instances. For more information, refer to the first page for the complete disclaimer note.

- Rear Auto Brake should be deactivated before driving with a bicycle rack.

 **Warning**

Incorrect use of the bicycle rack may cause damage to the towbar and car.

The bicycle rack can loosen from the towbar if it

- is incorrectly fitted on the towball
- is overloaded, see the bicycle rack's instructions for maximum load weight
- is used for carrying something other than bicycles.

The car's driving characteristics are affected when a bicycle rack is fitted on the towbar. For example due to:

- increased weight
- reduced acceleration capacity
- reduced ground clearance
- changed braking capacity.

Recommendations for loading bicycles on the bicycle rack

The larger the distance between the load's centre of gravity and the towball, the greater the load on the towbar.

Load according to the following recommendations:

- Fit the heaviest bicycle furthest in, closest to the car.
- Keep the load symmetrical and as close to the centre of the car as possible e.g. by loading the bicycles facing alternately if several bicycles are loaded.
- Remove loose objects from the bicycle for transportation, e.g. bicycle basket, battery, child seat. Partly to reduce the load on the towbar and bicycle rack, and partly to reduce the wind resistance, which affects fuel consumption.
- Do not use protective covers on the bicycles. This may affect manoeuvrability, impair visibility and increase fuel consumption. It may also lead to an increased load on the towbar.

* Option/accessory.

17.2. Cargo area

17.2.1. Safety net, safety grille and cargo cover

17.2.1.1. Operating cargo cover*

There are two extended positions for the cargo cover - a full-cover position and a loading position, where it is partially extended to make it easier to reach further into the cargo area.

Full-cover position

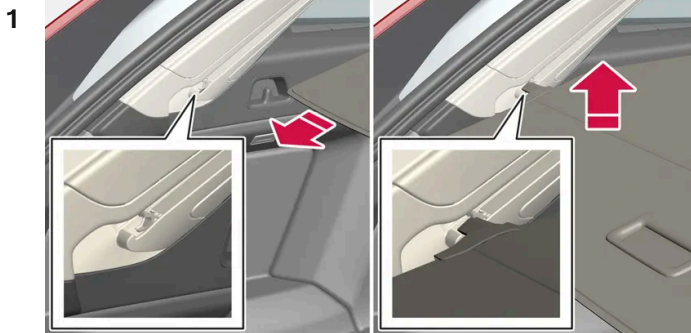

Grip the handle and pull out the cargo cover so that it slides over the side panels in the cargo area. Pull to the end position.

- 2 Guide the cover's attachment pins into the grooves in the side panels. Release, while at the same time angling the handle slightly upwards so that the attachment pins hook in.

➤ The cargo cover is locked in the full-cover position.

! Important

Do not load objects on top of the cargo cover.

Loading mode

From the full-cover position:

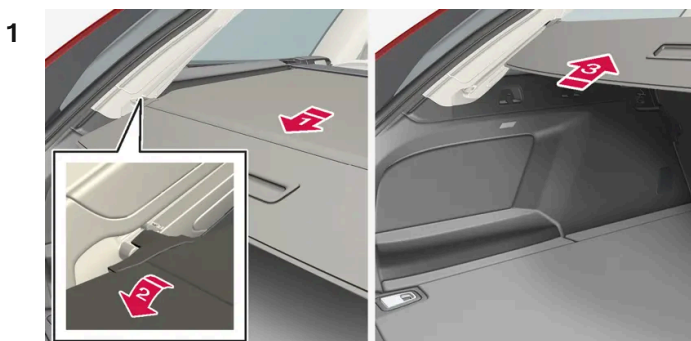

Grasp the handle and pull it back until it stops.

2 

Angle the cover down.

3 

Move the cover and its attachment pins carefully forward and up over the hooks.

➤ The cover retracts until it stops in the loading position.

Returning to full-cover position from loading position:

1 Grip the handle and pull the cargo cover out to the end position.

2 Release the handle so that the attachment pins hook into the hooks.

➤ The cover is locked in the full-cover position.

With an automatic* cargo cover, the cover will be retracted from full-cover position to loading position every time the tailgate is opened, and extended again when the tailgate is closed. The cargo cover detects if something is obstructing its movement and then retracts automatically.

 **Warning**

Pay attention to the risk of crushing when opening and closing with the automatic* cargo cover.

 **Important**

If the cargo area is loaded with a bulky load then the automatic* cargo cover is moved to retracted position in order to avoid it making contact with the load.

 **Note**

The cargo cover may not operate automatically in low passenger compartment temperatures.

Retracting

1 From the full-cover position:

Lift up the handle and pull it backward to disengage the cargo cover's attachment pins and then release.

From loading position:

Grip the handle and pull out the cargo cover in the grooves - pull to the full-cover position. Lift up the handle and pull it backward to disengage the attachment pins and then release.

The content of this manual represents the status of the user manual at the time of printing and may not be completely valid in future instances. For more information, refer to the first page for the complete disclaimer note.

- 2 Retract the cover with its attachment pins outside of the side panels until it stops in the retracted position.

Remember that a retracted cargo cover may obstruct rearward visibility.



* Option/accessory.

17.2.1.2. Fitting and removing cargo cover*

In the extended position, the cargo cover prevents visual access to the cargo area.

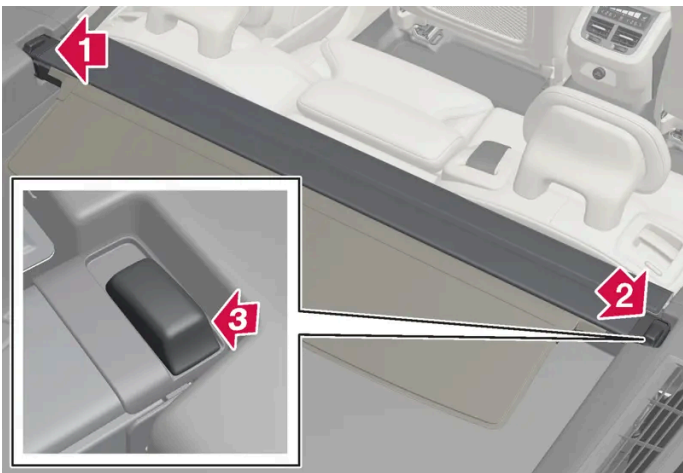
Fitting cargo cover



- 1  Insert one of the cargo cover's end pieces in the recess in the side panel in the cargo area.
- 2  Then insert the other end piece in the recess in the side panel on the opposite side.
- 3  Press down the end pieces on both sides - one by one.

- "When a "click" is heard and the red marking on each end piece has disappeared, the cargo cover is attached - check that it is affixed securely."

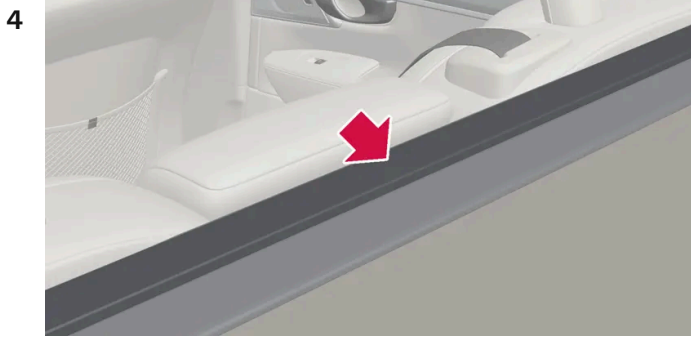

Fold the cargo cover's front panel forward to eliminate the space between the cargo cover and the rear seat's backrests.

 **Important**

The cover plate has two plastic parts that act as support to hold it in place.

The plastic parts must not be used to hang bags on. They are not designed for this purpose and may break.

If the safety net* shall be used at the same time as the cargo cover then the safety net must be fitted first.

Removing cargo cover

In retracted position:

- 1 Depress the button on one of the retracted cargo cover's end pieces and lift out that end.
 - 2 Angle the cover up/out carefully.
- The other end piece loosens automatically and the cover can be lifted out of the cargo area.

* Option/accessory.

17.2.1.3. Fitting and removing safety grilles *

The safety grille prevents loads or pets in the cargo area from being thrown forward in the passenger compartment under heavy braking.

The safety grille is crash-tested in accordance with the ECE R17 legal requirement and fulfils Volvo's strength requirements.



For safety reasons, the safety grille must always be attached and anchored correctly.

 **Warning**

Under no circumstances may anybody remain in the cargo area while the car is moving. This is to avoid injury in the event of heavy braking or an accident.

Installation

 **Important**

The safety grille must only be used in the rear position (behind the rear seat) described here.

Before first installing the safety grille, the existing plastic roof mountings must be replaced with steel roof mountings. Volvo recommends that replacing roof mountings is performed at an authorised Volvo workshop or retailer.

- 1 Fold the rear seat's backrest forward.
- 2 Make sure that the safety grille is turned in the right direction. Lift in the safety grille through one of the rear side doors.



Position the safety grille's brackets on the roof mountings.

The next step is facilitated if two people hold the safety grille in the right position.

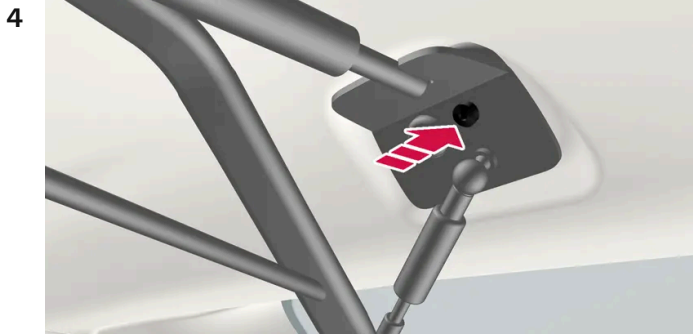

Insert the supplied screw and tighten using the supplied 6 mm Allen key. Repeat on the other side. Recommended tightening torque: 20 Nm (15 foot-pounds).

➤ Check that the safety grille is properly fitted.

5 Restore the backrest to the upright position.

For more information about the tools required and methods for fitting/removal, see the installation instructions^[1] that were included with the initial purchase.

 **Important**

The safety grille cannot be folded up or down when a cargo cover is fitted.

* Option/accessory.

^[1] Installation instructions no. 31659257.

17.2.1.4. Fitting and removing the safety net*

The safety net prevents loads from being thrown forward in the passenger compartment in the event of sudden braking.

The safety net is fitted into four mounting points.

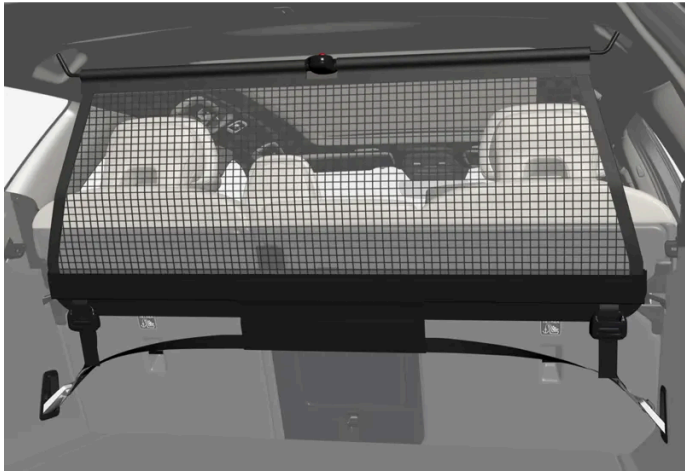

For reasons of safety, the safety net must always be fastened and anchored as described below.

The net is made of a strong nylon fabric and can be secured two different locations in the car:

- Front fitting - behind the front seats.
- Rear fitting - behind the rear seat.

 **Warning**

Loads in the luggage compartment must be anchored well, and also using a correctly fitted safety net.

Fitting the safety net

 **Warning**

Check that the safety net's upper mountings are correctly fitted and that the puller-straps are securely hooked on.
Damaged safety nets must not be used.

 **Note**

With forward mounting, the safety net is most easily mounted via the rear doors.

- 1 Unfold the safety net and make sure that the split upper rod in the net is locked in its extended position.
- 2 Hook one retaining hook of the net into the front or rear roof mounting with the anchoring strap locks turned towards you.
- 3 Hook the net's second attachment hook to the roof bracket on the opposite side.

The telescopically sprung attachment hooks make it easier to fit.

Take care to press forward the net's retaining hooks for each respective roof mounting's front end position.

The content of this manual represents the status of the user manual at the time of printing and may not be completely valid in future instances. For more information, refer to the first page for the complete disclaimer note.

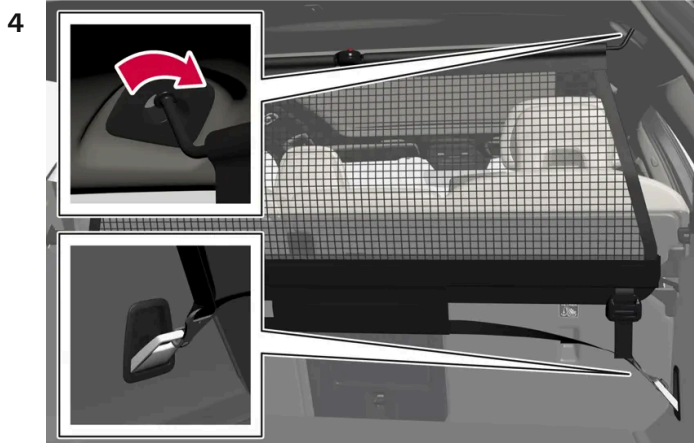

For rear fitting:

With the net fitted in the rear roof mountings, hook the safety net's puller-straps into the front load retaining eyelets in the cargo area.



For front fitting:

With the net fitted in the front roof mountings, hook the puller-straps into the outer eyes on the rear of all seat slide rails. The procedure is facilitated if the backrests are straightened and the seats are moved forward slightly.

Pay attention to make sure that you do not exert hard pressure on the net when the seat and backrest are moved back again. Only adjust until the seat or backrest makes contact with the net.

 **Important**

If a seat or backrest is pushed backwards hard into the safety net, the net and roof mounts may be damaged.

5 Tension the safety net with the anchoring straps.

Removing the safety net

The safety net can be easily removed and folded up.

- 1 Reduce safety net tension by pressing the button in the anchoring strap lock and feeding out a little of the anchoring strap on each side.
- 2 Press in the catches and detach both of the anchoring strap's hooks.
- 3 Undo the upper attachments and release the net from the roof mountings.
- 4 Press the red button on the rod to enable folding and then roll up the net. Store the net in its case.

* Option/accessory.

17.2.2. Cargo area

The car has a flexible cargo area that makes it possible to transport and secure large objects.



Cargo area with elastic strap as well as storage space under the cargo floor.

By folding down the backrests in the rear seat, the cargo area can become quite spacious. Use load retaining eyelets or bag holders to secure the load, and the extendable cargo cover* to conceal the load if desired.

The car's towing eye and puncture repair kit or spare wheel* are stored under the cargo area floor.

* Option/accessory.

17.2.3. Bag hooks

Bag hooks keep carrier bags in place and prevent them from overturning and spreading their contents across the cargo area.

Along the sides



There are two bag hooks in the side panel on each side of the cargo area.

There are two bag hooks in the side panel on each side of the cargo area.

Important

The bag hooks may be loaded with a maximum of 5 kg (11 lbs).

Under the floor hatch *



There are two bag hooks and an elastic strap^[1] in the cover, which is part of the floor hatch in the cargo area. The strap can be fitted in four different positions.

Lift up the cover in order to use the bag hooks. Fasten the bags in a suitable position with the enclosed elastic strap. If the bags have handles and are a suitable height - hang them in the hooks.

* Option/accessory.

^[1] It is possible to reorder additional elastic straps at a Volvo dealer.

17.2.4. First aid kit *

The first aid kit contains first aid equipment.

Store the first aid kit in the cargo area behind the elastic strap, if the car is equipped with one of these.

* Option/accessory.

17.2.5. Load retaining eyelets

Use the load retaining eyelets to attach straps in order to anchor items in the cargo area.

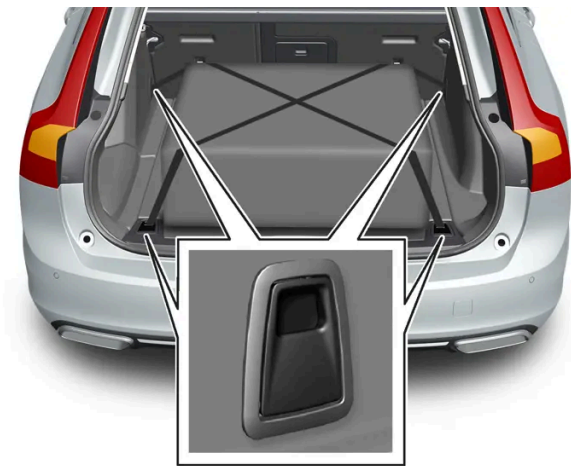

Warning

Hard, sharp and heavy objects that are loose or protrude may cause injury during heavy braking.

Always secure large and heavy objects with a seatbelt or cargo retaining straps.

17.2.6. Warning triangle

Use the warning triangle to warn other road users if the car is stationary in traffic.

Also activate the hazard warning flashers.

Storage spaces

The warning triangle is located under the panel on the inside of the tailgate.

Folding up the warning triangle

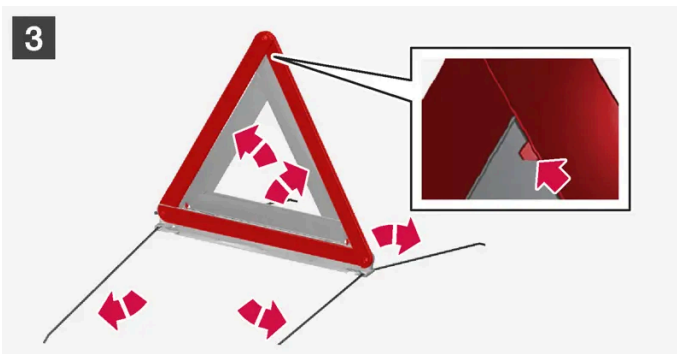
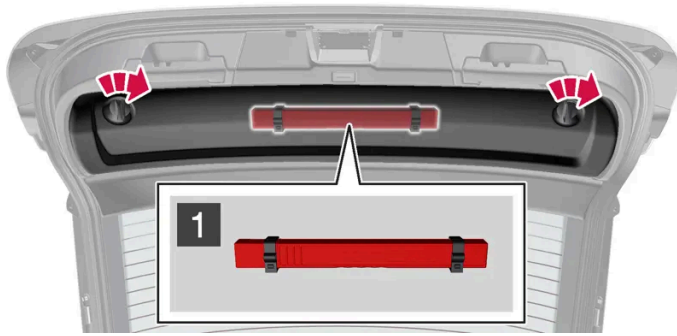

- 1** **1**
Detach the panel on the inside of the tailgate by first turning the two knobs a quarter turn and then unhooking the panel. Place the panel to one side.
Open the latch and take out the case.
- 2** **2**
Remove the warning triangle from the case, unfold it and put the ends together.
- 3** **3**
Fold out the warning triangle's support legs.

Follow the regulations for the use of a warning triangle. Position the warning triangle in a suitable place with regard to traffic.

Make sure that the warning triangle and case are properly secured in their storage space and that the hatch is fully closed after use.

17.2.7. Unlocking the tailgate with a key button

There is a button on the key to unlock the tailgate only.

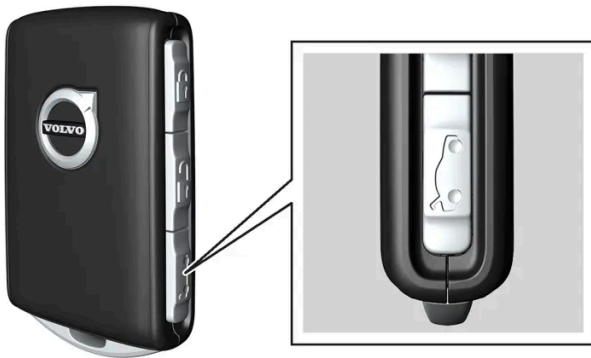

- 1 Press the key's  button.
 - > The tailgate is unlocked but remains closed.
The side doors are still locked and the alarm is armed*. The lock and alarm indicator on the instrument panel extinguishes in order to show that the entire car is not locked.
You can open the tailgate by gripping the rubberised pressure plate underneath its lower edge.
If the tailgate is not opened within 2 minutes then it is relocked and the alarm is re-armed.

Power operated tailgate*

- 1 Hold the key's  button depressed for a couple of seconds.
 - > The tailgate is unlocked and opened, while the side doors remain locked and their alarm functions armed*.

Note

If the system for the power operated tailgate* works continuously for a long time, it is deactivated in order not to overload it. It can be used again after a few minutes.

* Option/accessory.

17.2.8. Setting the max. opening for electrically operated tailgate*

Set the amount the tailgate should be opened if the car is, for example, parked in a garage with limited headroom.

To adjust max. opening

- 1 Open the tailgate manually - and stop it in the desired opening position.
- 2 Press and hold the * button on the bottom of the tailgate for approx. 3 seconds.
 - Two acoustic signals sound to indicate that the set position has been saved.

 **Note**

It is not possible to program an opening position lower than half-open tailgate.

Reset max. opening

- 1 Open the tailgate manually to the fully open position.
- 2 Press and hold the * button on the bottom of the tailgate for approx. 3 seconds.
 - Two acoustic signals sound to indicate that the set position has been cleared.

* Option/accessory.

17.2.9. Operating the tailgate with foot movement*

The tailgate can be opened and closed using a foot movement* under the rear bumper. The function makes things easier when your hands are full.



If the car is equipped with keyless locking and unlocking* then you can unlock the tailgate using a foot movement.

The function with both opening and closing of the tailgate is also available when the car is equipped with power operated tailgate*.

(i) Note

The foot-operated tailgate function is available in two versions:

- Opening and closing with foot movement
- Only unlocking with foot movement (lift up the tailgate manually to open it)

Note that the function for opening and closing with foot movement requires power operated tailgate*.

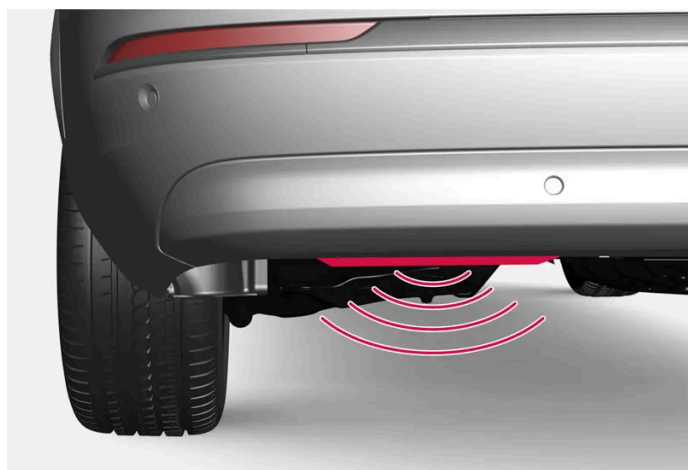

The sensor is located slightly to the left of the bumper.

One of the car's keys must be within range behind the car, approx. 1 metre (3 feet), for opening and closing to be possible. This also applies to an already unlocked car in order to avoid accidental opening e.g. in a car wash.

Opening and closing with foot movement

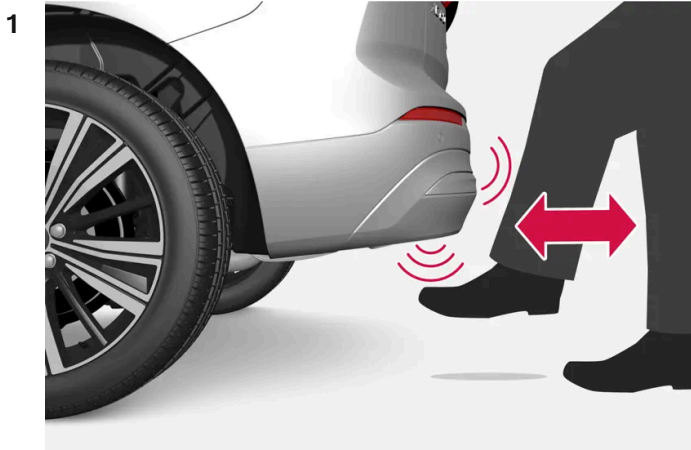

Make **one** forward kicking motion in the sensor area under the rear bumper. Then take a step back. The bumper must not be touched.

- A short acoustic signal sounds when opening or closing is activated - the tailgate is opened/closed.

If several kicking motions take place without a key sufficiently close, opening will not be possible until after a certain delay.

Do not leave your foot in the kicking motion under the car, this could cause activation to fail.

Cancelling opening or closing with foot movement

- 1 Make **one** forward kicking motion while opening or closing is in progress.

- Opening or closing the tailgate is stopped.

The key does not need to be in the vicinity of the car to cancel opening or closing of the tailgate.

If the tailgate is stopped close to closed position, the next activation will open the tailgate.

Note

Make sure you keep the area around the foot movement detector clean. A build-up of dirt, ice or snow may disrupt its function.

i Note

Pay attention to the possibility that the system may be activated in a car wash if the key is within range.

* Option/accessory.

17.2.10. Unlocking the tailgate from inside the car

The tailgate can be unlocked from inside the car using a button beside the steering wheel on the instrument panel.



- 1 Press the  button on the instrument panel.
 - > The tailgate is unlocked and can be opened from the outside.

With the power operated tailgate option*:

- 1 Hold the instrument panel's  button depressed for a couple of seconds.
 - > The tailgate is opened.
The same button can then be used to close the tailgate.

i Note

If the system for the power operated tailgate* works continuously for a long time, it is deactivated in order not to overload it. It can be used again after a few minutes.

* Option/accessory.

17.2.11. Keyless unlocking of tailgate *

The content of this manual represents the status of the user manual at the time of printing and may not be completely valid in future instances. For more information, refer to the first page for the complete disclaimer note.

With keyless locking and unlocking, it is sufficient to press lightly on the rubberised pressure plate underneath the tailgate's handle to unlock.

 **Note**

One of the car's keys must be within range behind the car for unlocking to work.

The tailgate is held closed by an electrical lock.

To open:

- 1 Press gently on the rubberised pressure plate beneath the tailgate handle.
 - > The lock is released.
- 2 Lift by the outside handle in order to open the tailgate.

 **Important**

- Handle the rubber panel with care to avoid damage to its electrical contact. Minimal force is required for activation.
- Do not exert the lifting force on the rubber panel when opening – lift the handle.

It is also possible to unlock the tailgate with a foot movement* under the rear bumper, see separate section.

 **Warning**

Do not drive with an open tailgate! Toxic exhaust fumes could be drawn into the car through the cargo area.

* Option/accessory.

17.2.12. Fuses in cargo area

Fuses in the cargo area protect, amongst other things, power seats*, airbags and seatbelt tensioners.

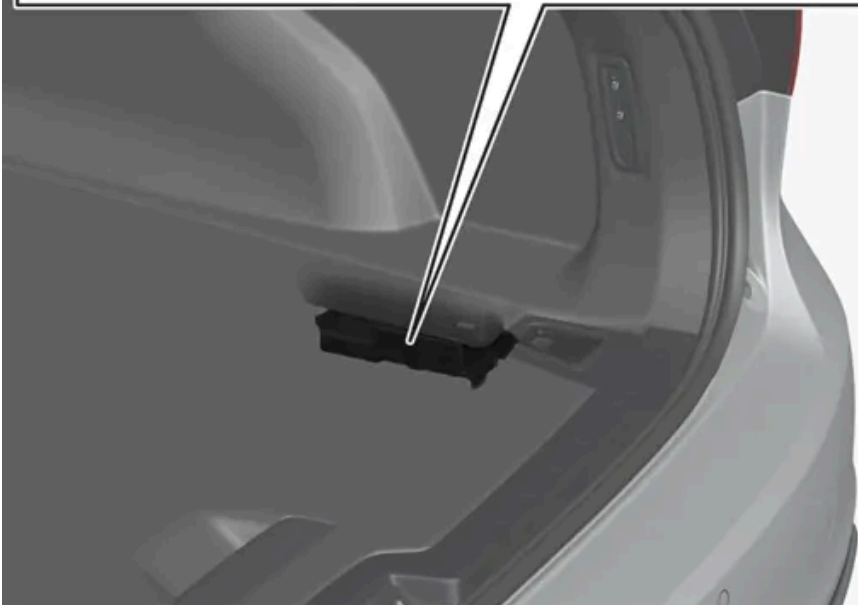
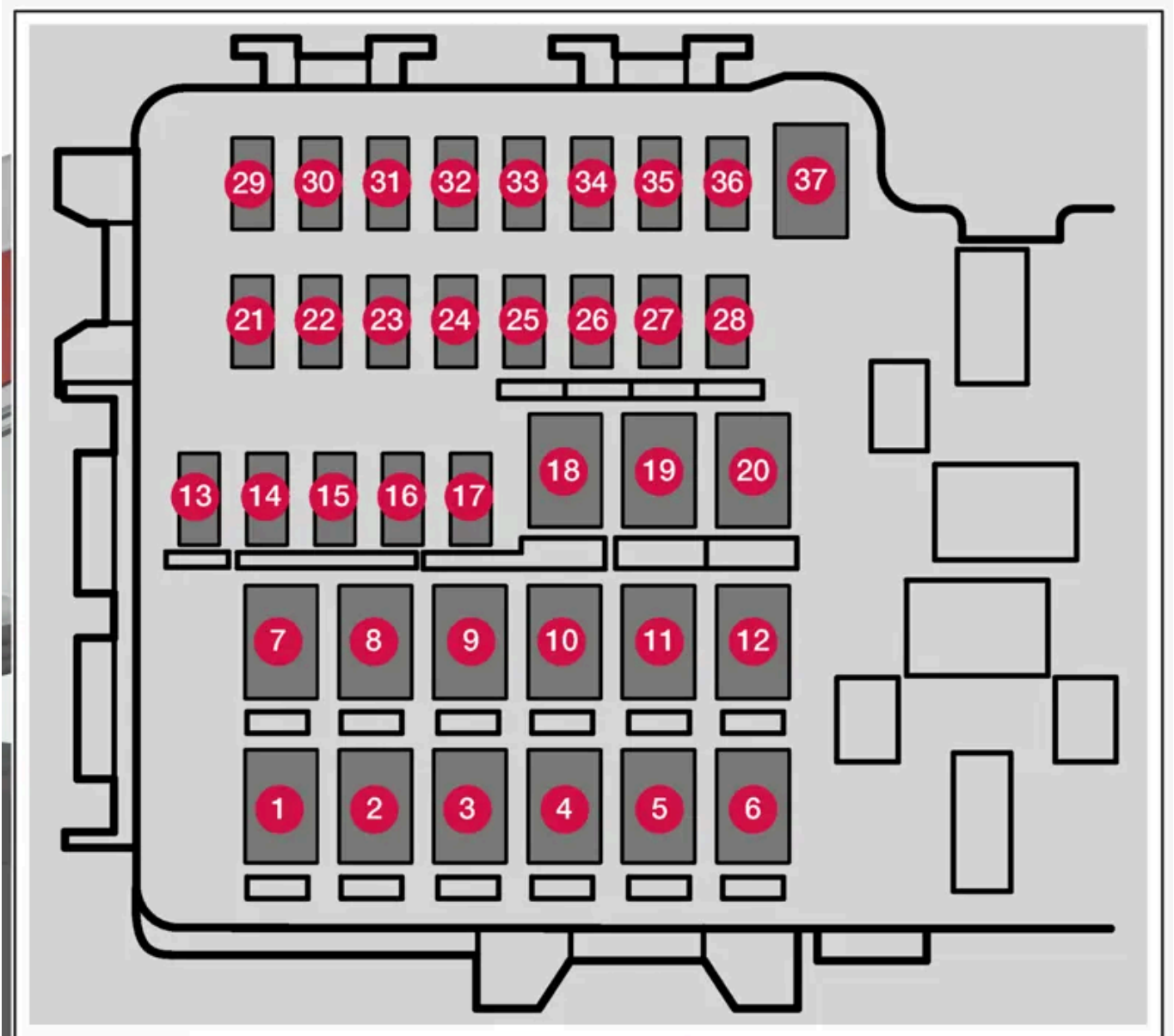

The central electrical unit is located behind the panel on the right-hand side.

Special pliers are housed on the inside of the cover to facilitate replacement of tripped fuses.

The **fuse box in the engine compartment** also provides space for several spare fuses.

Positions

Fuse locations are shown on the inside of the cover. Functions and components in the fuse table cover several models and engine alternatives. A fuse description can therefore apply to fewer than those in the table, or be completely missing, depending on how the car is equipped.

If a position has multiple table values, it is due to variations in equipment level. In which case, follow the value of the fuse being replaced. In the event of doubt – contact a workshop. An authorised Volvo workshop is recommended.

	Function	Ampere	Type
1	Rear window defroster	30	MCASE ^[1]
2	Central electronic module	40	MCASE ^[1]
3	Compressor, air suspension*	40	MCASE ^[1]
4	–	–	MCASE ^[1]
5	–	–	MCASE ^[1]
6	–	–	MCASE ^[1]
7	Door module, right rear	20	MCASE ^[1]
8	–	–	MCASE ^[1]
9	Power operated tailgate*	25	MCASE ^[1]
10	Door module, right rear	20	MCASE ^[1]
11	Towbar control module*	40	MCASE ^[1]
12	Seatbelt pretensioner, right	40	MCASE ^[1]
13	Internal relay coils	5	Micro
14	–	–	Micro
15	Door module, left rear	20	Micro
16	–	–	Micro
17	–	–	Micro
18	Towbar control module*	25	MCASE ^[1]
	Accessory module	40	
19	Door module, left front	20	MCASE ^[1]
20	Seatbelt pretensioner, left	40	MCASE ^[1]
21	–	–	Micro
22	Rear lighting (backup)	10	Micro
23	–	–	Micro
24	–	–	Micro
25	Supply when the ignition is switched on	10	Micro
26	–	–	Micro
27	–	–	Micro
28	Seat heating, left rear*	15	Micro
29	Actuator, exhaust system	5	Micro

	Function	Ampere	Type
30	Blind Spot Information (BLIS)*	5	Micro
31	-	-	Micro
32	-	-	Micro
33	-	-	Micro
34	-	-	Micro
35	Control module All Wheel Drive (AWD)*	15	Micro
36	Seat heating, right rear*	15	Micro
37	-	-	MCase ^[1]

* Option/accessory.

^[1] This type of fuse should be replaced by a workshop. An authorised Volvo workshop is recommended.

17.3. Storage and passenger compartment

17.3.1. Passenger compartment interior

Overview of the passenger compartment's interior and storage locations.

Front seat

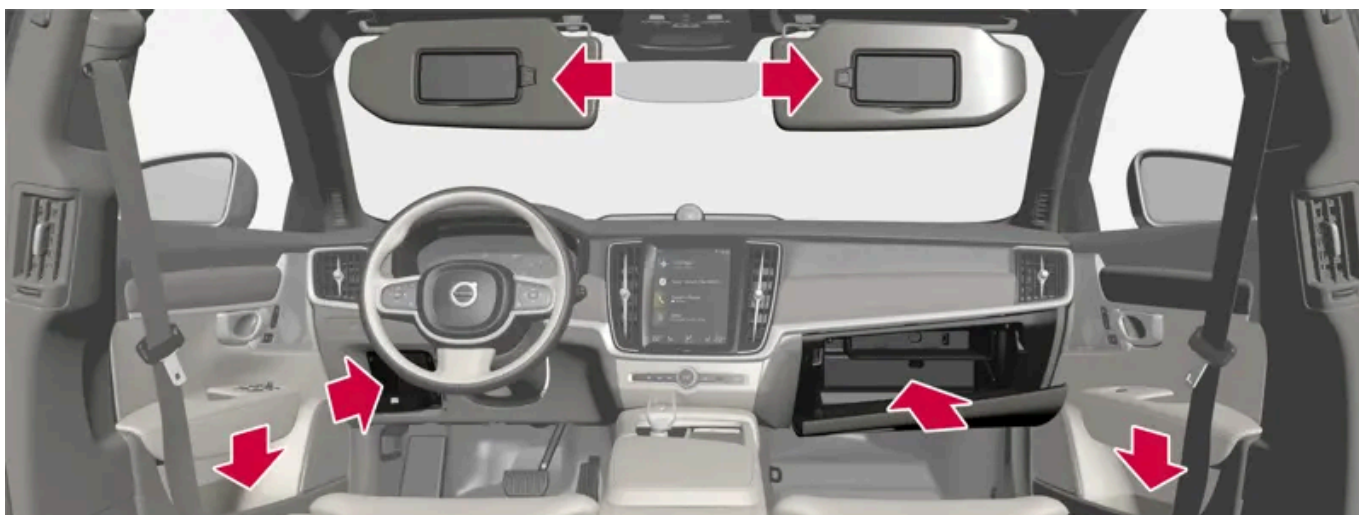

Storage compartment in the door panel and by the steering wheel, glovebox and sun visors.

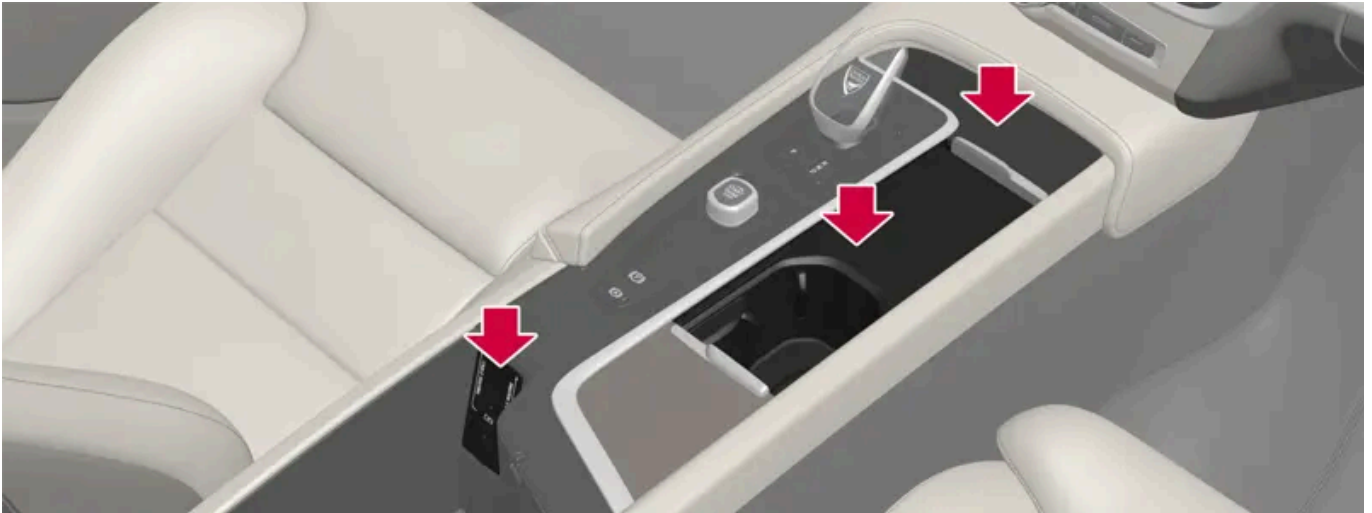

Storage spaces with cup holder, wireless phone charger*, electrical socket, as well as USB ports in the tunnel console.

Rear seat

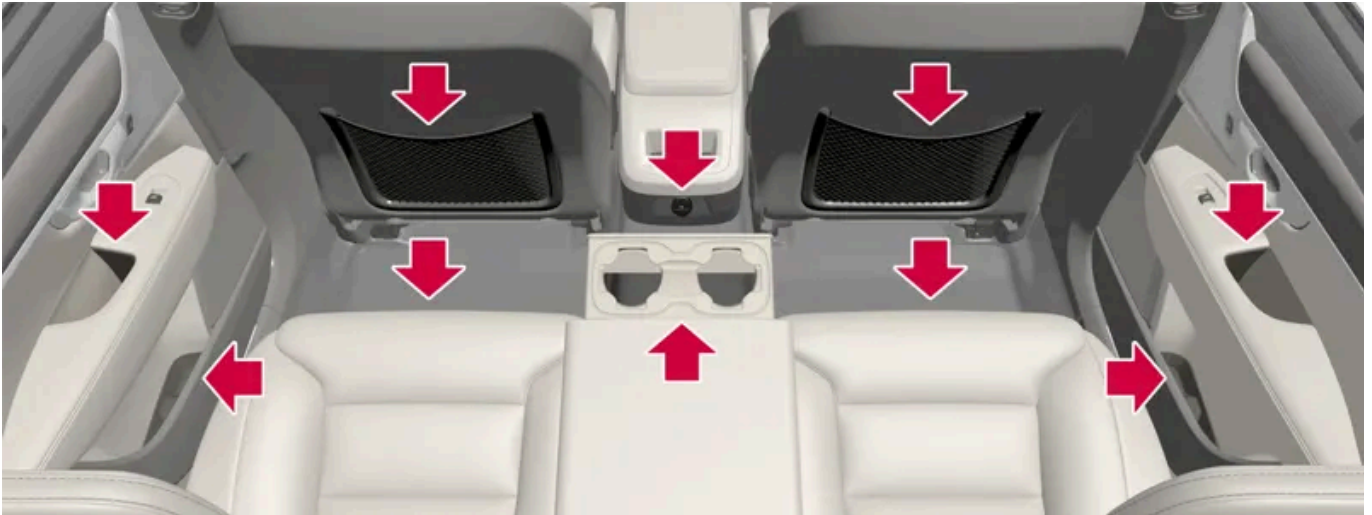

Storage compartment in the door panel, cup holder* in the centre seat backrest, storage pocket* on the front seat backrest, as well as USB ports in the tunnel console.

Warning

Keep loose objects such as phones, cameras, remote controls for accessories, etc. in the glove compartment or other compartments. Otherwise they may injure people in the car in the event of sudden braking or a collision.

Important

Keep in mind that high gloss surfaces, for example, are easily scratched by metal objects. Do not place keys, phones and other items on sensitive surfaces.

* Option/accessory.

17.3.2. Electrical sockets

There is one 12V electrical socket in the tunnel console and one 12V electrical socket* in the luggage compartment/cargo area.

If a problem occurs with an electrical socket, contact a workshop - an authorised Volvo workshop is recommended.

12 V electrical socket

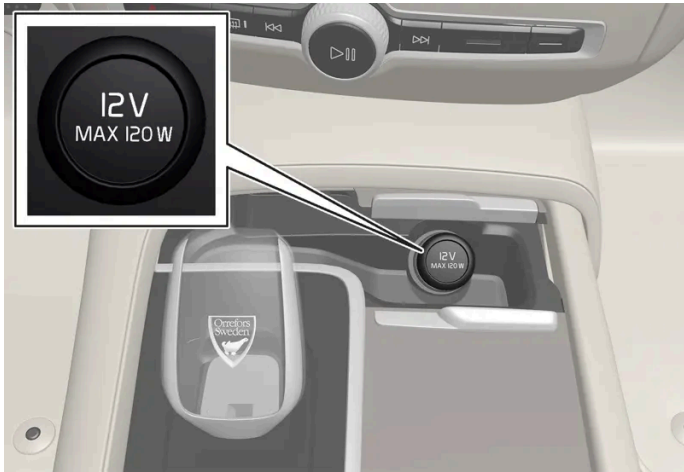

The tunnel console's front electrical socket for cars with wireless phone charger*.



The tunnel console's front electrical socket for cars without wireless phone charger*.

The 12 V sockets can be used for various accessories designed for this, such as music players, cooler boxes and mobile phones.



12 V electrical socket in cargo area*.

* Option/accessory.

17.3.3. Using electrical sockets

12 V sockets can be used for various accessories designed for this, such as music players, cooler boxes and mobile phones.

For the sockets to supply current, the car's electrical system must be set in the lowest ignition position I. The sockets are then active as long as the starter battery level does not become too low.

If the engine is switched off and the car is locked, the sockets are deactivated. If the engine is switched off and the car is not locked, or is locked with double lock temporarily deactivated, then the sockets continue to be active for a further seven minutes.

i Note

Remember that use of the electrical socket with the engine switched off entails a risk of discharging the starter battery, which can limit functionality.

Accessories that are connected to the electrical sockets may be activated even when the car's electrical system is disconnected or if preconditioning is used. For this reason, disconnect the connectors when they are not in use in order to avoid the starter battery being discharged.

 **Warning**

- Do not use accessories with large or heavy connectors - they can damage the socket or come loose when driving.
- Do not use accessories that can cause interference to the car's radio receiver or electrical system for example.
- Position the accessory so that it is not at risk of injuring the driver or passengers in the event of heavy braking or collision.
- Keep an eye on connected accessories as they can generate heat that can burn passengers or the interior.

Using 12 V sockets

- 1 Remove the blanking plug (tunnel console) or fold down the cover (cargo area) in front of the socket and plug in the accessory's connector.
- 2 Unplug the accessory's connector and refit the blanking plug (tunnel console) or fold up the cover (cargo area) when the socket is not in use or if the socket is left unattended.

 **Important**

Maximum socket output is 120 W (10 A) per socket.

17.3.4. Using the glovebox

The glovebox is located on the passenger side. Among other things, the car's printed owner's information can be stored in the glovebox. There is also space for a pen and card holder.



17.3.5. Sun visors

There are sun visors in the roof in front of the driver seat and the front seat passenger seat which can be folded down and angled out to the side when necessary.



The figure is schematic - the design may vary.

The mirror lighting* is switched on automatically when the guard is lifted up.

The mirror frame incorporates a holder for e.g. cards or tickets.

* Option/accessory.

17.3.6. Tunnel console

The tunnel console is located between the front seats.

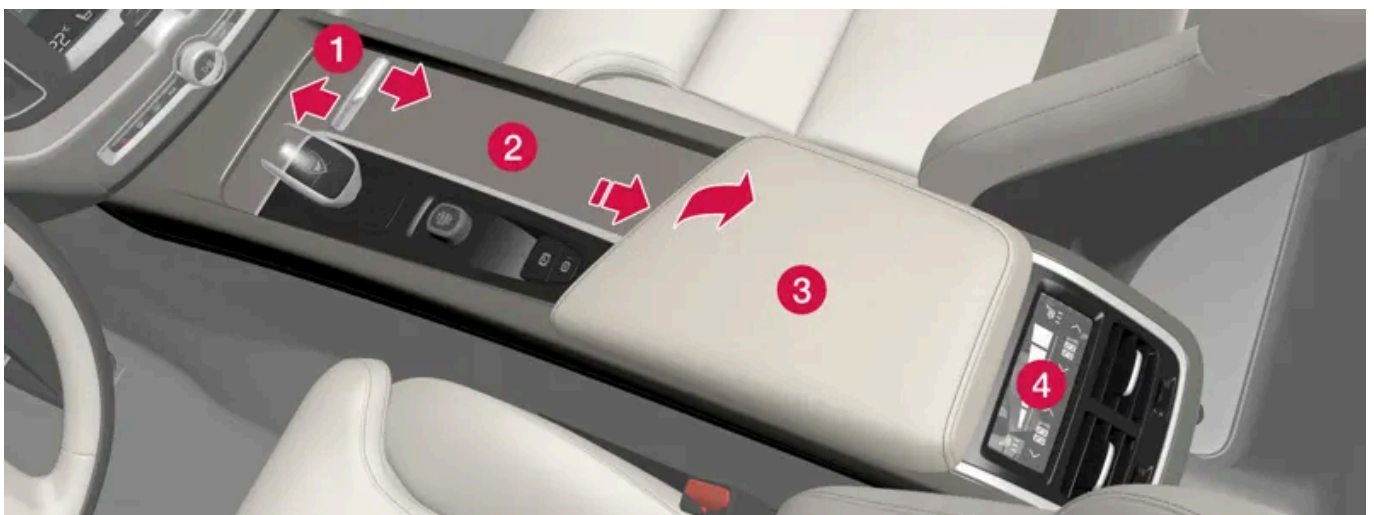

- 1 Storage compartment hatch* and 12 V socket^[1]. The hatch is opened/closed with a push on the handle.
- 2 Storage compartment with cup holder and wireless phone charger*.
- 3 Storage compartment and USB ports under the armrest.
- 4 Storage compartment on the right side of the console.

4 Climate controls for the rear seat climate functions* or storage compartment. There are also USB ports underneath.

 **Warning**

Keep loose objects such as phones, cameras, remote controls for accessories, etc. in the glove compartment or other compartments. Otherwise they may injure people in the car in the event of sudden braking or a collision.

 **Important**

Keep in mind that high gloss surfaces, for example, are easily scratched by metal objects. Do not place keys, phones and other items on sensitive surfaces.

 **Note**

One of the detectors for the alarm* is located under the tunnel console's cup holder. Avoid leaving coins, keys and other metal objects in the cup holder, since this may trigger the alarm.

 **Note**

The USB ports can be used for charging a phone or tablet, for example. Only the front USB port can be used to play media in the car's audio system.

* Option/accessory.

^[1] If the car does not have wireless phone charger, the 12V socket is in the centre storage compartment.

17.3.7. USB ports

There are two USB ports (type C) under the centre display. There are also two USB ports (type C) in the rear part of the tunnel console.



USB ports (type C), front seat.



USB ports (type C) in the tunnel console, rear seat.

The USB ports can be used to charge a phone or tablet, for example.

17.3.8. Use USB ports to charge devices

The USB ports can be used to charge a phone or tablet, for example.

The USB ports can be used when the car is in Comfort or Drive mode.

The ports are switched off automatically when the driver leaves the car. If the car remains unlocked or is locked with a reduced alarm level, the ports remain active for a further approx. 10 minutes.

 **Note**

Accessories that are connected to the ports may be activated even when the car's electrical system is disconnected or if preconditioning is used. For this reason, unplug accessories when they are not in use.

Some devices may become hot during charging. This is normal.

 **Warning**

Position the accessory so that it is not at risk of injuring the driver or passengers in the event of heavy braking or collision.

Use USB ports to charge devices

- 1 Fold down the cover in front of the port and plug in the accessory's connector.
- 2 Unplug the accessory's connector and fold up the cover when the port is not in use or is left unattended.

Technical specification for USB-C port

- Type C socket
- Version 3.1
- Voltage supply 5 V
- Current supply max. 3.0 A

17.3.9. Fuses under glovebox

The fuses in the fuse box under the glovebox protect components such as electrical sockets, displays and door modules.

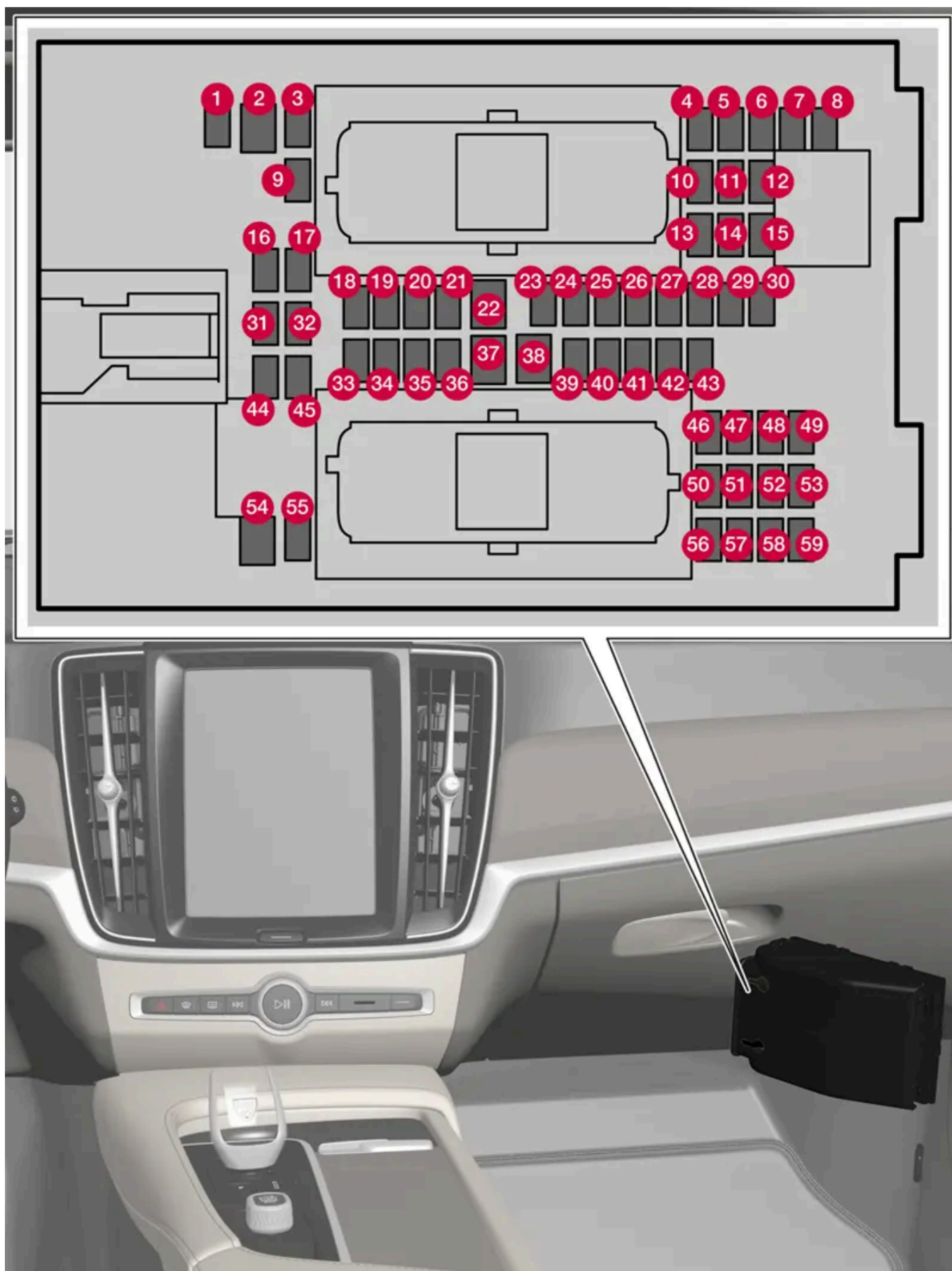

The central electrical unit is located behind the floor mat/side panel.

The content of this manual represents the status of the user manual at the time of printing and may not be completely valid in future instances. For more information, refer to the first page for the complete disclaimer note.

The **fuse box in the engine compartment** provides space for several spare fuses.

Positions

The positions of the fuses are shown on the inside of the cover. Functions and components in the fuse table cover several models and engine alternatives. A fuse description can therefore apply to fewer than those in the table, or be completely missing, depending on how the car is equipped.

If a position has multiple table values, it is due to variations in equipment level. In which case, follow the value of the fuse being replaced. In the event of doubt – contact a workshop. An authorised Volvo workshop is recommended.

	Function	Ampere	Type
1	Control module, 48 V battery	10	Micro
2	–	–	MCase ^[1]
3	–	–	Micro
4	Movement detector	5	Micro
5	–	–	Micro
6	Driver display	5	Micro
7	Keypad, centre console	5	Micro
8	Sun sensor Toll collection transponder	5	Micro
9	–	–	Micro
10	Infotainment system	15	Micro
11	Steering wheel module	5	Micro
12	Control module, start knob and parking brake	5	Micro
13	Heated steering wheel*	15	Micro
14	Airborne Particulate Matter Sensor (APMS)	5	Micro
15	–	–	Micro
16	–	–	Micro
17	Control module, rear lighting	15	Micro
18	Control module, climate control	10	Micro
19	Steering lock	7.5	Micro
20	Diagnostic port OBD-II	10	Micro
21	Centre display	5	Micro
22	Fan module, climate control, front	40	MCase ^[1]
23	USB hub	5	Micro
24	Controls lighting Passenger compartment lighting Dimming, interior rearview mirror* Rain and light sensors* Power front seats* Control panels, rear doors Fan module, climate control Ioniser Keypad, tunnel console at legroom rear seat*	7.5	Micro
25	Camera, front*	5	Micro

	Function	Ampere	Type
26	Roof console*	20	Micro
27	Head-up display*	5	Micro
28	Passenger compartment lighting	5	Micro
29	Wireless charging plate*	5	Micro
30	Display roof console Control module, camera wide-angle	5	Micro
31	–	–	Micro
32	–	–	Micro
33	–	–	Micro
34	Fuse box, cargo area	10	Micro
35	Control module, online car Control module, Volvo Services	5	Micro
36	–	–	Micro
37	Audio control device (amplifier)	40	MCas ^[1]
38	–	–	MCas ^[1]
39	Antenna module (TCAM)	5	Micro
40	Control module, seat comfort, front*	5	Micro
41	Alcohol lock* –	5 –	Micro
42	Rear window wiper	15	Micro
43	Control module, fuel pump	15	Micro
44	Converter 48 V Engine start module	5	Micro
45	Control module, driver support functions (active safety)	5	Micro
46	Seat heating, driver's side front	15	Micro
47	Seat heating, passenger side front	15	Micro
48	Coolant pump	7.5	Micro
49	Air cleaner	5	Micro
50	Power driver's seat*	20	Micro
51	Module, active damping*	20	Micro
52	Opening the boot lid/tailgate with foot motion*	5	Micro
53	Infotainment system	10	Micro
54	–	–	MCas ^[1]
55	–	–	Micro
56	Electrically operated front passenger seat*	20	Micro
57	–	–	Micro
58	–	–	Micro
59	–	–	Micro

^[1] This type of fuse should be replaced by a workshop. An authorised Volvo workshop is recommended.

* Option/accessory.

17.4. Through-load hatch in the rear seat

The hatch in the rear seat's backrest can be opened to transport long narrow items, e.g. skis.

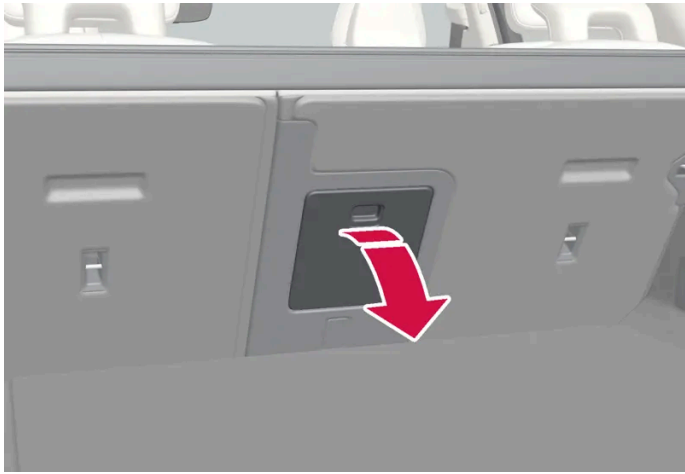

The figure is schematic - parts may vary depending on car model.

- 1 In the cargo area, grip the hatch's handle and fold down the hatch.
- 2 Fold forward the armrest in the rear seat.

18. Maintenance and service

18.1. Car care

18.1.1. Interior cleaning

18.1.1.1. Cleaning the centre display

Dirt, stains and grease from fingers can affect the centre display's performance and readability. Clean the screen frequently with a microfibre cloth.

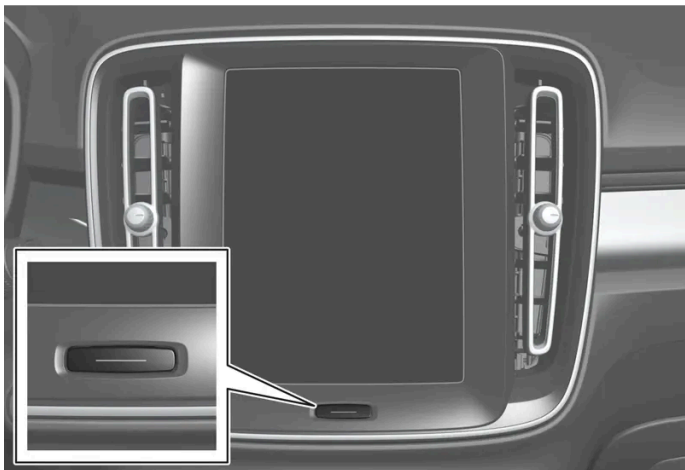

- 1 Turn off the centre display with a long press on the home button.
- 2 Wipe the screen with a clean and dry microfibre cloth using small circular movements. If necessary, lightly moisten the microfibre cloth with clean water.
- 3 Activate the display with a short press on the home button.

 **Important**

The microfibre cloth used to clean the centre display must be free from sand and dirt.

 **Important**

When cleaning the centre display, only use gentle pressure on the screen. Heavy pressure can damage the screen.

 **Important**

Do not spray any liquid or caustic chemicals directly on the centre display. Do not use window cleaning agent, other cleaning agents, aerosol spray, solvents, alcohol, ammonia or cleaning agent containing abrasive.

Never use abrasive cloths, paper towels or tissue paper, since they may scratch the centre display.

18.1.1.2. Cleaning the driver display

Gently wipe the display's cover glass with a clean and dry microfibre cloth. If necessary, lightly moisten the microfibre cloth.

Never use cleaning agent. A special cleaning agent available from Volvo dealers can be used for more difficult cleaning.

18.1.1.3. Cleaning the Head-up display*

Gently wipe the display's cover glass with a clean and dry microfibre cloth. If necessary, lightly moisten the microfibre cloth.

Never use strong stain removers. A special cleaning agent available from Volvo dealers can be used for more difficult cleaning.

* Option/accessory.

18.1.1.4. Cleaning the leather steering wheel

Use cleaning agents and car care products recommended by Volvo. Clean regularly, and deal with stains straight away. Vacuuming is important prior to using cleaning agents.

Leather needs to breathe. Never cover the leather steering wheel with protective plastic. We recommend Volvo Leather Care Kit/Wipes for cleaning the leather steering wheel. First remove dirt, dust, etc. with a damp sponge or cloth.

 **Important**

Sharp objects, e.g. rings, can damage the leather on the steering wheel.

18.1.1.5. Cleaning the seatbelts

Use cleaning agents and car care products recommended by Volvo. Clean regularly, and deal with stains straight away. Vacuuming is important prior to using cleaning agents.

Use water and a synthetic detergent. A special textile cleaning agent is available from Volvo retailers. Ensure that the seatbelt is dry before allowing it to retract.

18.1.1.6. Cleaning the interior

Use cleaning agents and car care products recommended by Volvo. Clean regularly, and deal with stains straight away. Vacuuming is important prior to using cleaning agents.

 **Important**

- Certain items of coloured clothing (e.g. dark jeans and suede garments) may stain the upholstery. If this occurs, it is important to clean and treat these parts of the upholstery as soon as possible.
- Never use strong solvents such as washer fluid, pure petrol or white spirit or concentrated alcohol to clean the interior, since this may damage the upholstery as well as other interior materials.
- Never spray the cleaning agent directly onto components that have electrical buttons and controls. Wipe them instead using a moistened cloth containing the cleaning agent.
- Sharp objects and Velcro may damage the fabric upholstery.
- Only use cleaning agents on the type of material for which they were intended.

18.1.1.7. Cleaning textile floor and entrance mats

It is recommended to use a fabric cleaning agent when cleaning mats. Clean regularly, and deal with stains straight away. Vacuuming is important prior to using cleaning agents.

Remove inlaid carpets for separate cleaning of the floor carpet and the inlaid carpets. Each inlay mat is secured with pins.

- 1 Remove the inlay mat by taking hold of the inlay mat at each pin and lifting the mat straight up.
- 2 Use a vacuum cleaner to remove dust and dirt.

 **Note**

The inlay mats must not be swung around without care or hit against objects to remove dirt since this can crack the inlay mats.

- 3 A textile cleaner is recommended for stains on the floor mat, after vacuuming.
- 4 After cleaning, fit the inlay mat in place by pressing it in at each pin.

 **Warning**

Only use one inlaid mat at each seat, and check before setting off that the mat by the driver's seat is firmly affixed and secured in the pins so that it does not get caught adjacent to and under the pedals.

18.1.1.8. Cleaning interior plastic, metal and wood parts

Use cleaning agents and car care products recommended by Volvo. Clean regularly, and deal with stains straight away.

A fibrillated fibre or microfibre cloth, lightly moistened with water, available from Volvo dealers, is recommended for cleaning interior parts and surfaces.

Do not scrape or rub stains. Never use strong stain removers, either.

 **Important**

Do not use solvent that contains alcohol when cleaning the glass for the driver display.

 **Important**

Keep in mind that high gloss surfaces are easily scratched. Clean these surfaces with a clean, dry microfibre cloth using small, circular motions. If needed, dampen the microfibre cloth with a little clean water.

18.1.1.9. Cleaning leather upholstery*

Use cleaning agents and car care products recommended by Volvo. Clean regularly, and deal with stains straight away. Vacuuming is important prior to using cleaning agents.

Volvo's leather upholstery* is treated to preserve its original appearance.

Leather upholstery* is a natural product that changes and acquires a beautiful patina over time. Regular cleaning and treatment are required in order that the properties and colours of the leather shall be preserved. Volvo offers a comprehensive product, Volvo Leather Care Kit/Wipes, for cleaning and treatment of leather upholstery. The protective outer layer of the leather is preserved when this is used according to the instructions.

To achieve results that are as good as possible, Volvo recommends cleaning and application of the protective cream one to four times per year (or more frequently if required). Volvo Leather Care Kit/Wipes is available from Volvo dealers.

Cleaning the leather upholstery

- 1 Apply the leather cleaner to a damp sponge and squeeze until a foam is created.
- 2 Use the sponge on the stain in a circular motion.
- 3 Thoroughly dampen the stain using the sponge, allow the sponge to absorb the stain without scrubbing.
- 4 Wipe the stain with a soft cloth and allow the leather to dry thoroughly.

Protecting the leather upholstery

- 1 Apply a small amount of leather protective agent to a cloth and then apply it to the leather in light circular motions.
 - 2 Allow to dry for about 20 minutes.
- Protecting the leather upholstery makes it more resistant to the stresses from the sun's UV radiation.

* Option/accessory.

18.1.1.10. Cleaning fabric upholstery and headlining

It is recommended to use fabric cleaning agent when cleaning textile fabric and Nubuck textile. Clean if necessary, and treat stains straight away.

 **Important**

Never scrape or rub a stain since this may damage the upholstery.

 **Important**

Never use stain removing agent or strong solvents, they could damage the upholstery.

Cleaning fabric upholstery

1. Start by vacuum cleaning the upholstery.
2. Follow the instructions for the fabric cleaning agent.
3. When cleaning fabric, a spray extraction cleaner is recommended for suction of the washing fluid and subsequent water rinsing.

 **Important**

Some coloured clothing (such as jeans and suede garments) may stain the fabric upholstery. Heavy stains such as oil may be difficult to remove.

 **Important**

Always clean the entire upholstery, even there are only individual stains. This is to avoid water rings.

 **Note**

Do not remove the upholstery for cleaning.

Cleaning the headlining

1. Brush the headlining carefully using a soft brush.
2. Follow the instructions for the fabric cleaning agent.
3. Then use a soft and lint-free cloth to wipe the headlining.

 **Important**

Careless cleaning can damage the headlining.

18.1.2. Exterior cleaning

18.1.2.1. Cleaning the exterior lamps

Dirty lamps have impaired functionality. Clean them regularly, e.g. when refuelling.

Clean the exterior lamps, such as headlamps and rear lamps, with a soft and clean sponge together with mild soap and lukewarm water.

Temporary condensation on the inside of the lens in connection with cleaning is quite normal. All exterior lamps are designed to withstand this. Condensation is normally vented out from the lamp housing after the lamp has been illuminated for a while.

Important

Do not use any strong cleaning agent or chemicals for cleaning the lamps. Such products, e.g. cleaning agents with alcohol content, may cause the lens to crack.

Important

Do not rub with a dry sponge or rag as it may cause electric discharges that damage components in the lamp.

18.1.2.2. Cleaning the wiper blades

The car should be washed as soon as it becomes dirty. The longer the car is left dirty, the more difficult it will be to get it completely clean and there is a risk of scratching the paintwork. Wash the car in a car wash with oil separator. Use car shampoo that is recommended by Volvo.

Asphalt, dust and salt residue on wiper blades, as well as insects, ice etc. on the windscreen, impair the service life of wiper blades.

When cleaning, set the wiper blades in service position.

Note

Wash the wiper blades and windscreen regularly with a lukewarm soap solution or car shampoo. Do not use any strong solvents.

18.1.2.3. Car paintwork

The paintwork consists of several layers and is an important part of the car's rustproofing, and should therefore be checked regularly.

The most common types of paintwork damage are stone chips, scratches, and marks on the edges of wings, doors and bumpers. To avoid the onset of rust, damaged paintwork should be rectified immediately.

18.1.2.4. Colour codes

The decal for the colour code is positioned on the car's right-hand door pillar between the front and rear door and will be visible when the right-hand rear door is opened.

Colour code

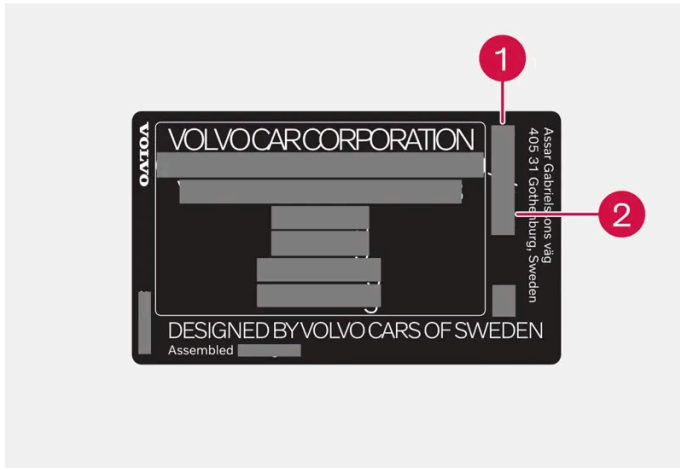

- 1 Exterior colour code
- 2 Any secondary exterior colour code

18.1.2.5. Touching up minor paintwork damage

Paint is an important part of the car's rustproofing and should therefore be checked regularly. The most common types of paintwork damage are stone chips, scratches, and marks on e.g. the edges of wings, doors and bumpers.

To avoid the onset of rust, damaged paintwork should be rectified immediately.

Note

When paint is repaired the surface must be clean and dry. The temperature of the surface should be at least 15 °C (59 °F).

Materials that may be needed

- Primer – a special adhesive primer in a spray can is available for e.g. plastic-coated bumpers.
- Basecoat and clearcoat - available in spray cans or as touch-up pens/sticks^[1].
- Masking tape.
- Fine sand paper.

Applying touch-up paint to the damaged surface

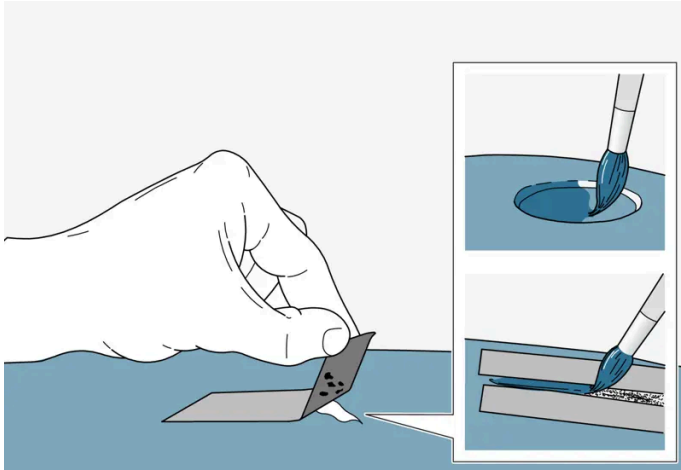

If the damage has not reached down to the metal, the touch-up paint can be applied directly after the surface has been cleaned.

- 1** Apply a piece of masking tape over the damaged surface. Then remove the tape to remove any loose paint.
If the damage is down to the metal, use of a primer is appropriate. In the event of damage to a plastic surface, an adhesive primer should be used to give better results - spray into the lid of the spray can and brush on thinly.
- 2** Before painting, gentle polishing using a very fine abrasive cloth may be carried out locally if required (e.g. if there are any uneven edges). The surface is thoroughly cleaned (grease and salt should be removed) and left to dry.
- 3** Stir the primer well and apply using a fine brush, a matchstick or similar. Finish off with a basecoat and clearcoat once the primer has dried.

For scratches, implement the same procedure but mask around the damaged area to protect the undamaged paintwork.

Touch-up pens and spray paints for touching up paintwork are available from Volvo dealers.

i Note

If the stone chip has not penetrated down to the metal and an undamaged layer of paint remains in place, fill in with base coat and clear coat as soon as the surface has been cleaned.

^[1] Follow the instructions that are included with the package for the touch-up pen/stick.

18.1.2.6. Cleaning the exterior

The car should be washed as soon as it becomes dirty. This means that the car is easier to clean since the dirt does not attach as firmly. It also reduces the risk of scratches and keeps the car fresh. Wash the car in a

cleaning area with an oil separator and use car shampoo. Use cleaning agents and car care products recommended by Volvo.

Important points to remember when washing the car

- Avoid washing the car in direct sunlight^[1]. This can cause the detergent or wax to dry and have an abrasive effect.
- Remove bird droppings, tree sap and resin from paintwork as soon as possible. They can contain substances that can very quickly affect and discolour paintwork. For example, use soft paper or a sponge soaked in plenty of water. An authorised Volvo workshop is recommended for the removal of any discolouration.
- After the car has been washed, there may be tar residue from asphalt. Use tar remover as recommended by Volvo to remove the residual stains.

^[1] Does not apply to washing in an automatic car wash.

18.1.2.7. Rustproofing

The car has protection against corrosion.

Anti-corrosion protection for the body consists of metallic protective coatings on the sheet metal, a high-quality painting process, corrosion-protected and minimised metal overlap, and shielding plastic components, abrasion protection and supplemental rust inhibitor on exposed areas. In the chassis, exposed components of the wheel suspension are made of corrosion-resistant cast aluminium.

Inspection and maintenance

The car's anti-corrosion protection normally requires no maintenance, but a good way to reduce the risk of corrosion is to keep the car clean. Strong alkaline or acidic cleaning solutions must be avoided on glossy trim components. Any stone chips should be rectified as soon as they are discovered.

18.1.2.8. Automatic car wash

It is important to prepare the car if it shall be washed in an automatic car wash. Follow the instructions carefully for how to handle the car before and during washing.



An automatic car wash may be a quick and easy way to clean the car, but will not reach all the parts of the car that need to be cleaned on a regular basis. Volvo recommends supplementing automatic car washing with hand washing.

Note

Avoid washing a brand new car in an automatic car wash during the first few months. This would allow the paintwork to fully harden.

Preparations before washing

In an automatic car wash where the car is pulled through the car wash, it is important to switch off functions that prevent the car from rolling freely.

- Secure or remove protruding exterior parts such as retrofitted auxiliary lamps and antennas.
- Make sure that the automatic rain sensor function is deactivated. The windscreen wipers must be switched off the whole time the car is being washed to avoid the risk of damage.
- Deactivate the automatic brake when stationary function using the button  on the tunnel console.
- Select the parking camera view  in the centre display and deactivate the park assist sensors and auto-brake when reversing. They may be reactivated if the car is restarted, and must be deactivated again.

During washing

Important

Keep the windows, doors, panoramic roof* and tailgate closed the whole time the car is being washed.

If the car is equipped with keyless locking and unlocking*:

Take out the key and store it openly in the front part of the car while the car is being washed. This minimises the risk of opening the tailgate unintentionally by pressing a button, or that the key is incorrectly detected outside the car.

Keep the seatbelt fastened the whole time the car is being washed.

- 1 Drive into the car wash and stop at the designated location.
- 2 Select gear position N.
- 3 Set the car in ignition position 0 by turning the start knob in the tunnel console clockwise for several seconds.
 - The engine is switched off, and at the same time the car can roll freely.
- 4 The car travels through the automatic car wash.
 - Do not forget to restore the adjustments that were made before the car wash.

After washing

Press the brake pedal gently for a short time while driving after the brake linings have been exposed to the wetness. This heats the brakes with friction so that they dry more quickly and reduces the risk of corrosion.

Warning

Always test the foot brake and parking brake after washing the car in order to restore their function.

* Option/accessory.

18.1.2.9. Cleaning exterior plastic, rubber and trim components

The car should be washed as soon as it becomes dirty. The longer the car is left dirty, the more difficult it will be to get it completely clean and there is a risk of scratching the paintwork. Use car shampoo that is recommended by Volvo.

A special cleaning agent available from Volvo dealers is recommended for the cleaning and care of coloured plastic parts, rubber and trim components, e.g. glossy trim mouldings. When using such a cleaning agent the instructions must be followed carefully.

Avoid washing the car with detergent with a pH value below 3.5 or above 11.5. This can cause discolouration of anodised aluminium components*, as illustrated. We advise against use of abrasive polishing agents, as illustrated.



Parts that should be washed using a cleaning agent with a pH value between 3.5 and 11.5.

! Important

Avoid waxing and polishing on plastic and rubber.

When using degreasant on plastic and rubber, only rub with light pressure if it is necessary. Use a soft washing sponge.

Polishing glossy trim mouldings could wear away or damage the glossy surface layer.

Polishing agent that contains abrasive must not be used.

! Important

Avoid washing the car with cleaning agent with a pH value lower than 3.5 or higher than 11.5. This may result in discolouration of anodised aluminium parts such as roof rack and around the side windows.

Never use metal polishing agent on anodised aluminium parts, this can result in discolouration and destroy the surface treatment.

* Option/accessory.

18.1.2.10. Cleaning wheel rims

The car should be washed as soon as it becomes dirty. The longer the car is left dirty, the more difficult it will be to get it completely clean and there is a risk of scratching the paintwork. Perform the cleaning in a car wash with oil separator. Use car shampoo that is recommended by Volvo.

Use rim cleaning agent recommended by Volvo.

Strong rim cleaning agents can damage the surface and cause stains on chrome-plated aluminium rims.

18.1.2.11. Handwashing

The car should be washed as soon as it becomes dirty. This means that the car is easier to clean since the dirt does not attach as firmly. It also reduces the risk of scratches and keeps the car fresh. Wash the car in a cleaning area with an oil separator, and use car shampoo. Use cleaning agents and car care products recommended by Volvo.

Important points to remember when handwashing the car

- Wash the underbody, including wheel housings and bumpers.
- Rinse the entire car until the dissolved dirt has been removed so as to reduce the risk of scratches from washing. Do not spray directly onto the locks.
- If necessary, use cold degreasing agent on very dirty surfaces. Note that in this case, the surfaces must not be hot from the sun.
- Wash using a sponge, car shampoo and plenty of lukewarm water. Ensure that the sponge is dirt-free. Dirt on the sponge may cause you to scratch the car during washing.
- Clean the wiper blades with a lukewarm soap solution or car shampoo.
- Dry the car using a clean, soft chamois or a water scraper. If you avoid allowing drops of water to dry in strong sunlight, you reduce the risk of water drying stains which may need to be polished out.

 **Warning**

Always have the engine cleaned by a workshop. There is a risk of fire if the engine is hot.

 **Important**

Dirty headlamps have impaired functionality. Clean them regularly, e.g. when refuelling.

Do not use any corrosive cleaning agents but use water and a non-scratching sponge instead. See separate section for more information.

 **Note**

Outside lighting such as headlamps and rear lamps may temporarily have condensation on the inside of the lens. This is normal, all exterior lighting is designed to withstand this. Condensation is normally vented out of the lamp housing when the lamp has been switched on for a time.

 **Important**

- Make sure that the panoramic roof* and sun visor are closed before washing the car.
- Never use polishing agent with abrasive properties on the panoramic roof.
- Never use wax on the rubber mouldings around the panoramic roof.

 **Important**

Remember to remove dirt from the drain holes in the doors, the sills, and in the panoramic roof after washing the car.

* Option/accessory.

18.1.2.12. High-pressure washing

The car should be washed as soon as it becomes dirty. The longer the car is left dirty, the more difficult it will be to get it completely clean and there is a risk of scratching the paintwork. Wash the car in a car wash with oil separator. Use car shampoo that is recommended by Volvo.

When using high-pressure washing, use sweeping movements and make sure that the nozzle does not come closer than 30 cm (13 in.) to the surface of the car. Do not spray directly onto the locks or within the fuel filler flap.

 **Important**

Do not rinse water hotter than 60 °C onto the exterior lamps, such as headlamps and rear lamps. See separate section for more information.

18.1.2.13. Polishing and waxing

Polish and wax the car if the paintwork is dull or to give the paintwork extra protection. The car does not need to be polished until it is at least one year old. However, the car can be waxed during this time. Do not polish or wax the car in direct sunlight, the surface being polished should be a maximum of 45 °C (113 °F).

- Wash and dry the car thoroughly before you begin polishing or waxing. Clean off asphalt and tar stains using tar remover or white spirit. More stubborn stains can be removed using fine rubbing paste designed for car paintwork. Use cleaning agent recommended by Volvo.
- Polish first with a polish and then wax with liquid or solid wax. Follow the instructions on the packaging carefully. Many preparations contain both polish and wax.

 **Important**

Never polish or wax any matt details on the car. This can destroy the matt effect and give the surface a permanent shine.

 **Important**

Avoid waxing and polishing on plastic and rubber.

When using degreasant on plastic and rubber, only rub with light pressure if it is necessary. Use a soft washing sponge.

Polishing glossy trim mouldings could wear away or damage the glossy surface layer.

Polishing agent that contains abrasive must not be used.

 **Important**

Use cleaning agent recommended by Volvo. Other treatment such as preserving, sealing, protection, lustre sealing or similar could damage the paintwork. Paintwork damage caused by such treatments is not covered by Volvo warranty.

18.2. Wiper blades and washer fluid

18.2.1. Wiper blades and washer fluid

Together with the washer fluid, the wipers aim to improve visibility as well as headlamp pattern.

The washer nozzles are heated* automatically in cold weather to prevent the washer fluid from freezing.

Information indicating that the washer fluid needs topping up appears in the driver display when there is approx. 1 litre (1 qt) of washer fluid remaining.

* Option/accessory.

18.2.2. Setting the wiper blades in service position

The content of this manual represents the status of the user manual at the time of printing and may not be completely valid in future instances. For more information, refer to the first page for the complete disclaimer note.

In some situations, the windscreen's wiper blades must be set in service position (vertical position), e.g. when they shall be replaced.



Wiper blades in service position.

In order to change, clean or lift the wiper blades (e.g. for scraping off ice from the windscreen) they must be in service position.

 **Important**

Before placing the wiper blades in the service position, make sure that they are not frozen down.

Activating/deactivating service mode

Service mode can be activated/deactivated when the car is stationary and the windscreen wipers are not on. Service mode is activated/deactivated via the centre display:

- 1 Press  in the centre display.
- 2 Then tap on **Controls** and activate/deactivate wiper blade service position.

The wiper blades also exit the service position if:

- Windscreen wiping is activated.
- Windscreen washing is activated.
- The rain sensor is activated.
- The car is driven away.

 **Important**

If the wiper arms in service position have been folded up from the windscreen, they must be folded back down onto the windscreen before the activation of wiping, washing or the rain sensor, as well as before driving. This is to avoid scraping the paint on the bonnet.

18.2.3. Topping up washer fluid

Washer fluid is used for cleaning the headlamps as well as the windscreen and rear window. Washer fluid with antifreeze must be used when the temperature is under the freezing point.

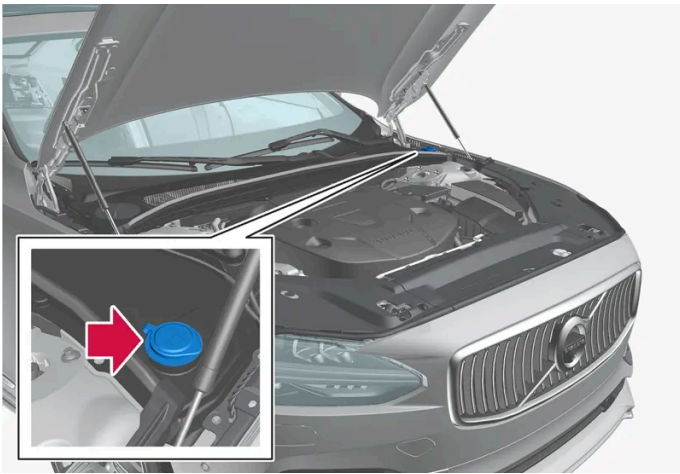

 **Note**

When approx. 1 litre (1 qt) of washer fluid remains in the reservoir, the message **Refill washer fluid, level low** appears together with the  symbol in the driver display.

When the **Refill washer fluid, level low** message together with the  symbol appear in the driver display, it is time to refill washer fluid

1 Open the bonnet with the handle in the passenger compartment and then with the handle under the front edge of the bonnet.

2 Open the washer fluid reservoir cap.

Washer fluid is filled into the reservoir with the blue cap. The reservoir is used for windscreen washer, rear window washer and headlamp washers*.

3 Top up with washer fluid.

4 Close the washer fluid reservoir cap and then close the bonnet.

Prescribed grade: Washer fluid recommended by Volvo – with frost protection during cold weather and for temperatures below freezing point.

! Important

Use Volvo genuine washer fluid or equivalent with a recommended pH of between 6 and 8, in working dilution (e.g. 1:1 with neutral water).

! Important

Use washer fluid with antifreeze when the temperature is below freezing to avoid the fluid freezing inside the pump, reservoir and hoses.

Volume:

- Cars **with** headlamp washing: 5.5 litres (5.8 qts).
- Cars **without** headlamp washing: 3.5 litres (3.7 qts).

* Option/accessory.

18.2.4. Replacing the wiper blade, rear window

The wiper blades sweep water away from the windscreen and rear window. Together with washer fluid, they aim to clean the windows and ensure visibility while driving. Windscreen and rear window wiper blades can be replaced.

Replacing the wiper blade, rear window



Lift the wiper arm from the window and pull the lower section of the blade to the right.

1 

Grip the centre of the wiper arm and lift it from the windscreen to lock position.

 **Note**

There is a lock position at half extension angle that may feel like resistance. This lock prevents the arm from falling back against the windscreen. The wiper arm must be pulled past the lock for wiper blade replacement.

2 

Grip the lower part of the blade and pull to the right until the blade loosens from the arm.

3 Press the new wiper blade into place. You should be able to hear a click. Check that it is firmly installed.

4 Lower the wiper arm.

 **Important**

Check the blades regularly. Neglected maintenance shortens the service life of the wiper blades.

18.2.5. Replacing windscreen wiper blades

The wiper blades sweep water away from the windscreen and rear window. Together with washer fluid, they aim to clean the windows and ensure visibility while driving. Windscreen and rear window wiper blades can be replaced.

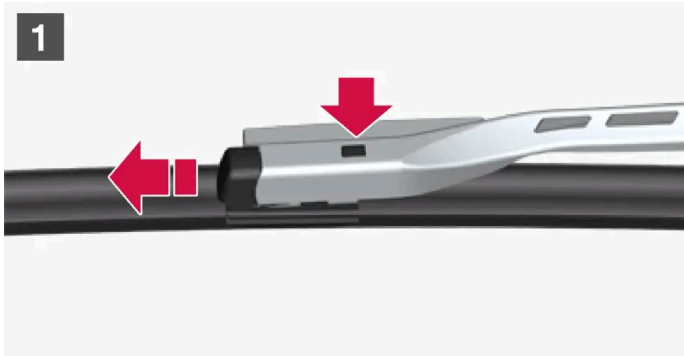

Make sure that the windscreen wipers are in service position and fold up the wiper arms. Service position is activated and deactivated via the centre display when the car is stationary and the windscreen wipers are not switched on.

- 1 **1**
Press the button located on the wiper blade mounting and pull straight out parallel with the wiper arm.
- 2 **2**
Slide in the new wiper blade until a "click" is heard.
- 3 Check that the blade is firmly installed.
- 4 Fold the wiper arm back towards the windscreen.

! Important

If the wiper arms in service position have been folded up from the windscreen, they must be folded back down onto the windscreen before the activation of wiping, washing or the rain sensor, as well as before driving. This is to avoid scraping the paint on the bonnet.

The wiper blades are different lengths

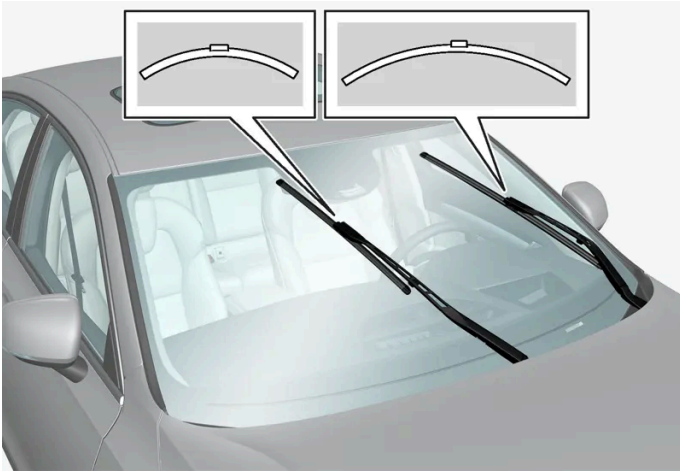

i Note

When replacing the wiper blades, note that they have different lengths. The blade on the driver's side is longer than on the passenger side.

18.3. Bulb replacement

18.3.1. Bulb replacement

This car is equipped only with LED^[1] lamps and therefore does not have any replaceable bulbs. Contact a workshop^[2] if a fault occurs in the lighting.

If a fault occurs in LED^[1] lamps, the entire lamp unit usually must be replaced.

i Note

For information about bulbs not covered in this Owner's Manual, contact a Volvo dealer or an authorised Volvo workshop.

i Note

Outside lighting such as headlamps and rear lamps may temporarily have condensation on the inside of the lens. This is normal and all exterior lighting is designed to withstand this. Condensation is normally vented out of the lamp housing when the lamp has been switched on for a time.

^[1] LED (Light Emitting Diode)

^[2] An authorised Volvo workshop is recommended.

18.3.2. Checking trailer lamps*

When connecting a trailer – check that the trailer lamps work before departure.

Checking trailer lamps*

Automatic checking

After a trailer is connected electrically, it is possible to ensure that the trailer lamps are working via an automatic lamp activation. The function helps the driver check that the trailer lamps are working before starting off.

- 1 When a trailer is connected to the towbar, the **Perform a trailer lamp check?** message is shown in the driver display.
- 2 Confirm the message by pressing the right-hand steering wheel keypad's **O** button.
 - > The lamp check starts.
- 3 Exit the car to check lamp functionality.
 - > All trailer lamps start to flash - then the lamps are switched on one at a time.
- 4 Visually check that all lamps available on the trailer are operational.
- 5 After a moment, all lamps on the trailer flash again.
 - > The check is complete.

Rear fog lamp on trailer

When connecting a trailer, there may be instances when the rear fog lamp on the car does not illuminate. In these cases, rear fog lamp functionality is transferred to only the trailer. Therefore, in these cases, check when the rear fog lamp is activated that the trailer is equipped with rear fog lamp in order to drive the vehicle combination in a safe manner.

Symbols and messages in the driver display

If one or more of the trailer's direction indicators or brake light bulbs is broken, the driver display shows a symbol and a message. Other lights on the trailer must be checked manually by the driver before setting off.

Symbol	Message
	Right trailer turn indicator malfunction Left trailer turn indicator malfunction
	Trailer brake light malfunction

If any lamp for the trailer's direction indicators is broken, the driver display symbol for direction indicators will also flash more quickly than normal.

* Option/accessory.

18.4. Engine compartment

18.4.1. Topping up washer fluid

Washer fluid is used for cleaning the headlamps as well as the windscreen and rear window. Washer fluid with antifreeze must be used when the temperature is under the freezing point.

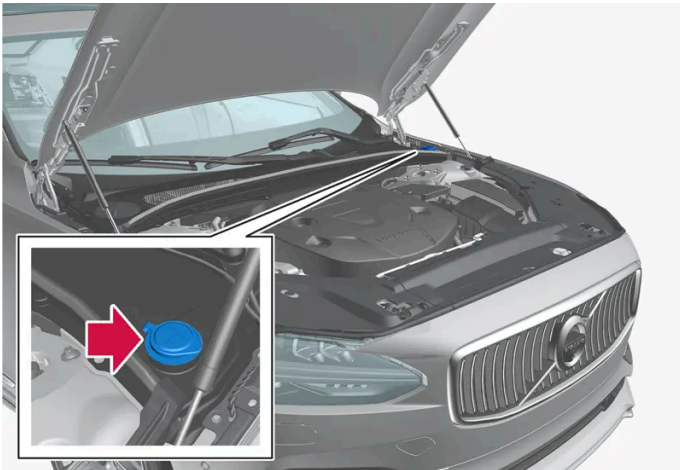

Note

When approx. 1 litre (1 qt) of washer fluid remains in the reservoir, the message **Refill washer fluid, level low** appears together with the  symbol in the driver display.

When the **Refill washer fluid, level low** message together with the  symbol appear in the driver display, it is time to refill washer fluid

- 1 Open the bonnet with the handle in the passenger compartment and then with the handle under the front edge of the bonnet.
- 2 Open the washer fluid reservoir cap.

Washer fluid is filled into the reservoir with the blue cap. The reservoir is used for windscreen washer, rear window washer and headlamp washers*.

- 3 Top up with washer fluid.
- 4 Close the washer fluid reservoir cap and then close the bonnet.

Prescribed grade: Washer fluid recommended by Volvo – with frost protection during cold weather and for temperatures below freezing point.

 **Important**

Use Volvo genuine washer fluid or equivalent with a recommended pH of between 6 and 8, in working dilution (e.g. 1:1 with neutral water).

 **Important**

Use washer fluid with antifreeze when the temperature is below freezing to avoid the fluid freezing inside the pump, reservoir and hoses.

Volume:

- Cars **with** headlamp washing: 5.5 litres (5.8 qts).
- Cars **without** headlamp washing: 3.5 litres (3.7 qts).

* Option/accessory.

18.4.2. Brake fluid – specifications

Brake fluid is the medium in a hydraulic brake system that is used to transfer pressure from e.g. a brake pedal via a master brake cylinder, which in turn acts on the brake callipers.

Prescribed grade: Volvo Original or equivalent fluid compliant with a combination of Dot 4, 5.1 and ISO 4925 class 6.

 **Note**

It is recommended that brake fluid is changed or filled by an authorised Volvo workshop.

18.4.3. Opening and closing the bonnet

The bonnet can be opened using the handle in the passenger compartment and a handle under the front edge of the bonnet. It is important to follow the instructions for closing and to check that the bonnet is fully

The content of this manual represents the status of the user manual at the time of printing and may not be completely valid in future instances. For more information, refer to the first page for the complete disclaimer note.

closed if it has been open.

Open the bonnet



1 Pull the handle beside the pedals to release the bonnet from its fully closed position.



2 Turn the handle under the bonnet anticlockwise to release the catch and lift the bonnet.

Warning - bonnet not closed



Open bonnet is indicated by a warning symbol and graphic in the driver display as well as by an acoustic signal.

i Note

If the car indicates that the bonnet is open despite it being fully closed – open the bonnet and follow the instructions for closing again. Visit a workshop if the problem persists – an authorised Volvo workshop is recommended.

Close the bonnet

 **Warning**

Make sure that nothing is in the way of the bonnet closing to avoid crushing damage.

- 1 Lower the bonnet until it reaches the bonnet lock catch.
- 2 Press down on the bonnet with both hands in order to fully close it.
 - The bonnet must be audibly locked on both sides.
- 3 Check that the bonnet has been properly locked and that it is not open slightly.

 **Warning**

Never drive with an open bonnet.

Thoroughly check that the bonnet is fully closed after it has been open.

If the car warns or indicates that the bonnet is open, or if something else suggests that it is not fully closed – stop immediately and close it firmly.

18.4.4. Engine compartment overview

The engine compartment contains several service-related parts.

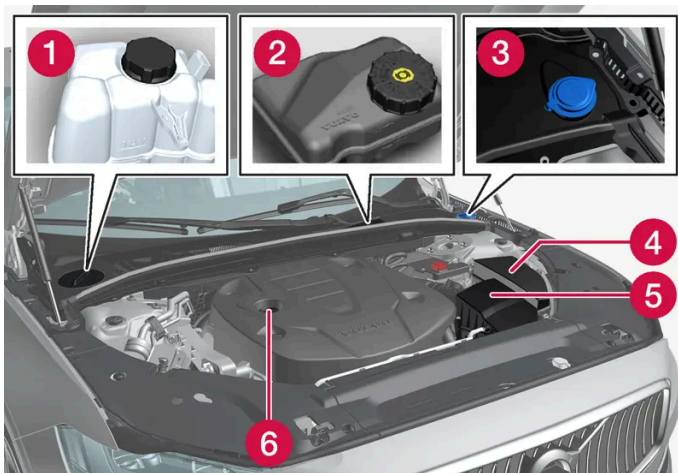

The appearance of the engine compartment may differ depending on model and engine variant.

- 1 Coolant expansion tank
- 2 Reservoir for brake fluid (located on the driver's side)
- 3 Washer fluid filler pipe
- 4 Central electrical unit

5 Air filter

6 Engine oil filler pipe

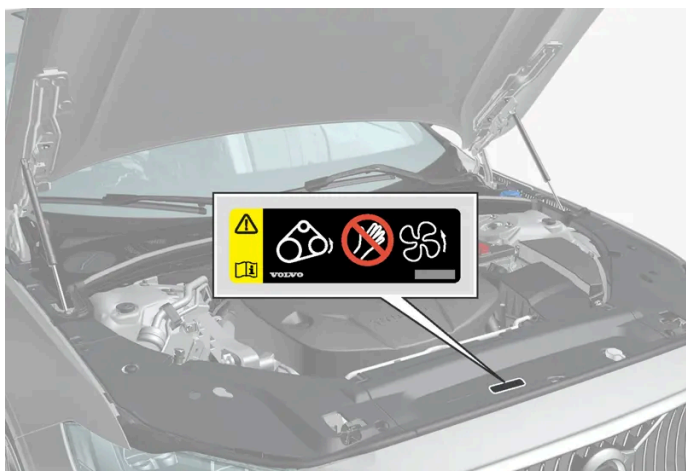

Location of warning decal for the engine compartment. The appearance of the engine compartment may differ depending on model and engine variant.

Note

It is not intended that the decals illustrated in the owner's manual should be exact replicas of those in the car. They are included to show their approximate appearance and locations in the car. The information that applies to your particular car can be found on the decal on the car.

Warning

Remember that the radiator fan (located at the front of the engine compartment, behind the radiator) may start automatically or continue to operate for up to approx. 6 minutes after the engine has been switched off.

Always have the engine cleaned by a workshop - an authorised Volvo workshop is recommended. There is a risk of fire if the engine is hot.

Warning

The ignition system works at a very high and hazardous voltage. The car's electrical system must always be in ignition position 0 when work is being performed in the engine compartment.

Do not touch the spark plugs or ignition coil when the car's electrical system is in ignition position II or when the engine is hot.

18.4.5. Coolant

The coolant cools the internal combustion engine to the correct operating temperature. The surplus heat can be used to heat the passenger compartment.

Prescribed grade:

Ready-mixed coolant approved by Volvo.

If the concentrated coolant is used, mix it with 50% pure water. Level of cleanliness must meet Volvo's requirements. Consult a Volvo dealer if unsure.

In order to prevent deterioration of cooling system function, which may lead to engine malfunction among other things, it is recommended that only coolant approved by Volvo should be used.

Warning

Coolant must not be swallowed. It can cause damage to the kidneys and other organs. The product contains, among other things, ethylene glycol, inhibitor and water.

18.4.6. Topping up coolant

Follow the instructions on the coolant's packaging for topping up. Never top up with water only. The risk of freezing increases with both too little and too much coolant concentrate.

If there are signs of leakage from the cooling system - avoid starting the car and have it towed in order not to risk engine damage. Signs of leakage may be coolant under the car, that coolant visibly evaporates, or that more than 2 litres (approx. 2 quarts) is needed for topping up.

Warning

The coolant can be very hot when the engine has been running. Always allow the coolant to cool down before unscrewing the filler cap.

When filling - carefully unscrew the cap to release any overpressure.



Coolant expansion tank, left-hand drive car.

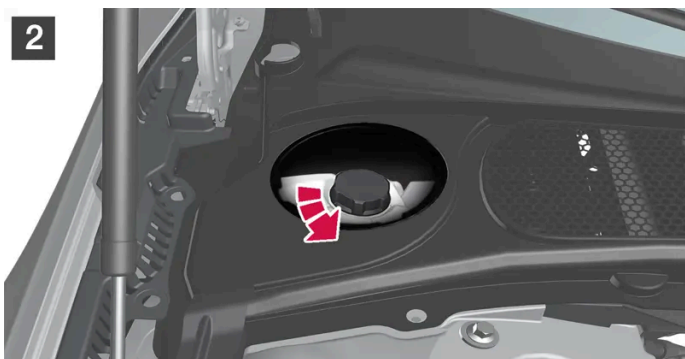
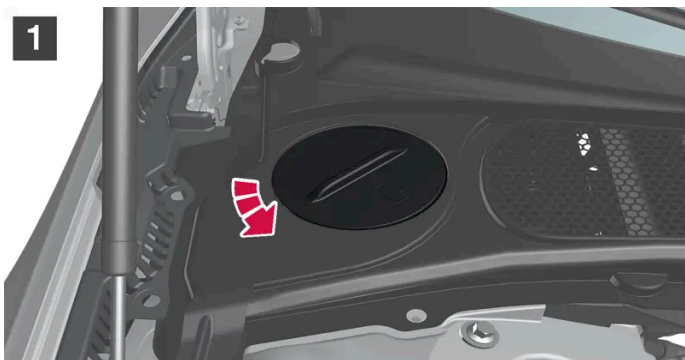

1 **1**
Screw off the cap in the plastic cover.

2 **2**
Screw off the cap and top up with coolant if necessary. The coolant level must not exceed the yellow **MAX** mark inside the expansion tank.

Reinstall the parts in reverse order.



Coolant expansion tank, right-hand drive car.

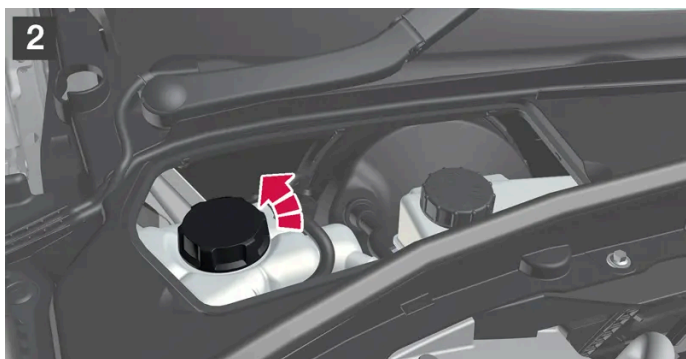

1 **1**
Grip the hatch's handle and lift/jiggle the hatch from the plastic cover.

2 **2**
Screw off the cap and top up with coolant if necessary. The coolant level must not exceed the yellow MAX mark inside the expansion tank.

Reinstall the parts in reverse order.

! **Important**

- Coolant is harmful to ingest and may cause organ damage.
- Only use coolant of Volvo-approved quality. If concentrated liquid is used, make sure that the ratio is 50 % coolant to 50 % water of approved quality.
- Hard water, and water with a high content of chlorine, chlorides and other salts or contaminants may cause corrosion to the cooling system.
- Do not mix different coolants.
- New coolant must be used to replace all coolant when replacing a large component in the cooling system.
- Only operate the engine when the cooling system is filled to the correct level. When the coolant level is too low, it may lead to overheating, resulting in engine damage.

18.4.7. Engine oil

Only use engine oil of the prescribed quality. This is a requirement in order for the recommended service intervals and warranty to be applicable.

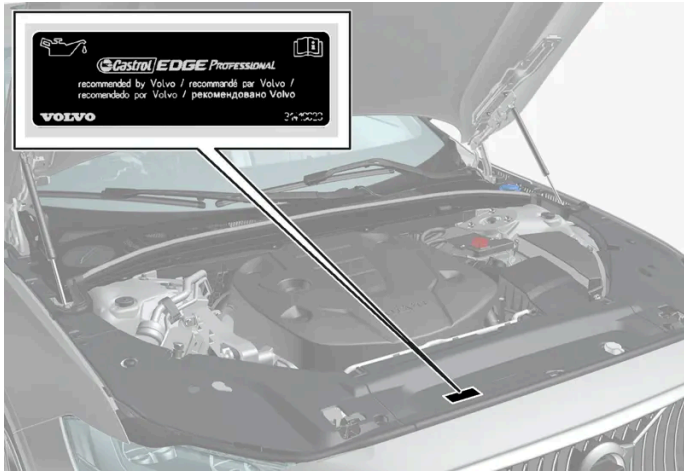

Location of warning decal for the engine compartment. The appearance of the engine compartment may differ depending on model and engine variant.

Volvo recommends:



If the engine oil cannot be checked on a regular basis and the level falls too low, there is a risk that this will cause serious damage to the engine.

i Note

It is not intended that the decals illustrated in the owner's manual should be exact replicas of those in the car. They are included to show their approximate appearance and locations in the car. The information that applies to your particular car can be found on the decal on the car.

! Important



In order to fulfil the requirements for the engine's service intervals all engines are filled with a specially adapted synthetic engine oil at the factory. The choice of oil has been made very carefully with regard to service life, starting characteristics, fuel consumption and environmental impact.

An approved engine oil must be used in order that the recommended service intervals can be applied. Only use a prescribed grade of oil for both filling and oil change, otherwise there is a risk of the service life, starting characteristics, fuel consumption and environmental impact of the car being affected.

If engine oil of the prescribed grade and viscosity is not used, engine related components may become damaged. Volvo disclaims any liability for any such damage.

Volvo recommends that oil changes are carried out at an authorised Volvo workshop.

Symbols for low oil level

Volvo uses different systems to warn about the oil level or low oil pressure. Low oil pressure is indicated by a warning symbol  in the driver display. Warning or information about the car's oil level can be indicated by a warning symbol  in the driver display as well as message texts. Contact a Volvo dealer for more information.

Change the engine oil and oil filter in accordance with the intervals specified in the Service and Warranty Booklet.

18.4.8. Checking and filling with engine oil

The oil level is detected with the electronic oil level sensor.

See oil level in the centre display

The oil level can be shown in the centre display when the car is started. It should be checked regularly.

- 1 Press  in the centre display.
 - 2 Select **Car status**.
- Different types of information about the car can be shown, including oil level.

Note

The system cannot directly detect changes when the oil is filled or drained out. The car must have been driven approx. 30 km (approx. 20 miles) and have been stationary for 5 minutes with the engine switched off and on level ground before the oil level indication is correct.

Note

If the right conditions for measuring the oil level (time after engine shutdown, the car's inclination, outside temperature, etc.) are not met, then the message **No value available** will be shown in the centre display. This does **not** mean that there is something wrong in the car's systems.

Important

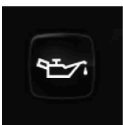

If this symbol is shown then the oil pressure may be too low. Stop the car as quickly as possible and have the car recovered to a workshop – an authorised Volvo workshop is recommended.

Fill the engine oil

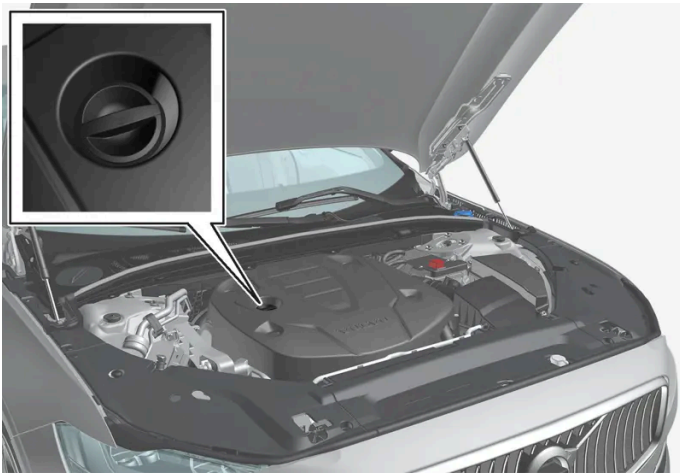

Filler pipe^[1], ^[2].

In some cases, oil may need to be topped up between service intervals. No action with regard to engine oil level needs to be taken until a message is shown in the driver display.

Warning

If the message **Engine oil level Service required** is shown, then the oil level may be too high. Visit a workshop – an authorised Volvo workshop is recommended.

Warning

Take care not to spill any oil in the engine compartment. This may lead to fire if the oil comes into contact with hot parts.

Important

If a message prompts you to top up the engine oil, only fill with the specified amount. If the level is too high, it may result in operational disruption.

^[1] Engines with electronic oil level sensor do not have a dipstick.

^[2] The appearance of the engine compartment may differ depending on model and engine variant.

18.4.9. Engine oil – specifications

Engine oil grade and volume for each respective engine alternative can be read in the table.

Volvo recommends:



Engine	Engine code ^[1]	Volume, incl. oil filter (litres, approx.)	Oil grade
B5	B420T2	6.1	Castrol Edge Professional V 0W-20 or VCC RBS0-2AE 0W-20
B6 AWD	B420T	6.1	

^[1] The engine code, component number and serial number can be found on the engine.

18.4.10. Fuses in engine compartment

Among other things, the engine compartment fuses protect functions related to the engine and the brake system.

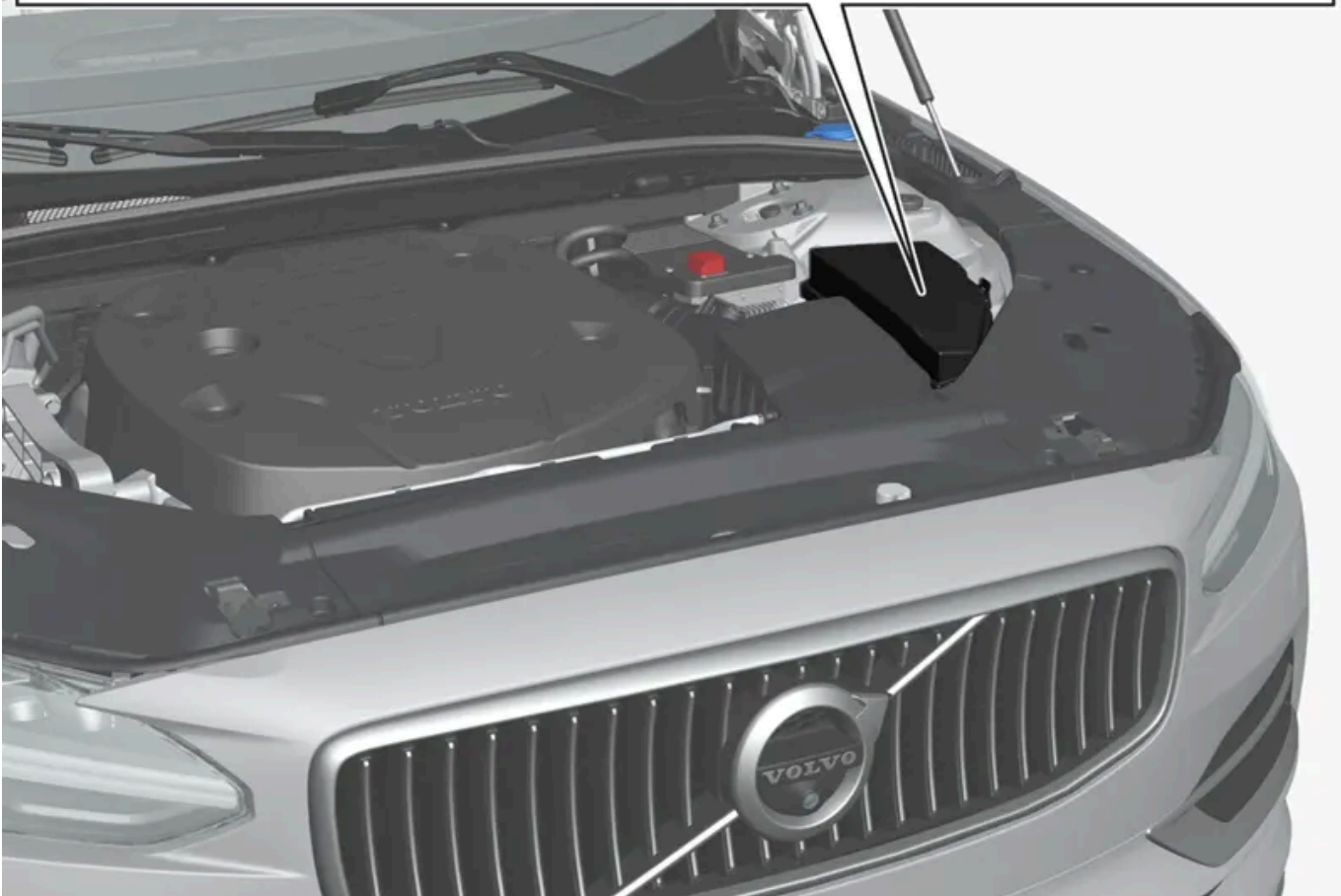
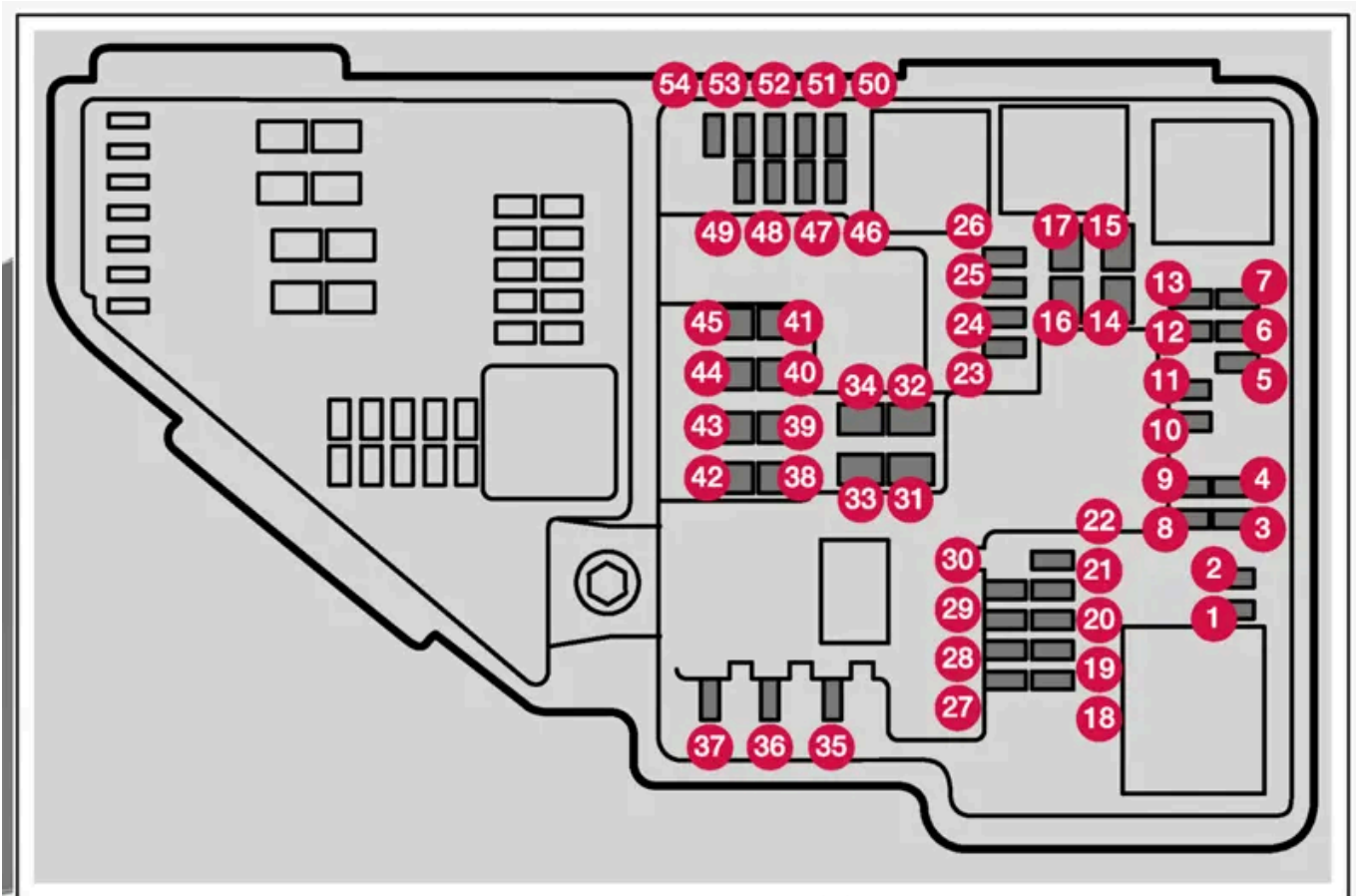

Special pliers are housed on the inside of the cover to facilitate replacement of tripped fuses.

The fuse box also provides space for several spare fuses.

Positions

Fuse locations are shown on the inside of the cover. Functions and components in the fuse table cover several models and engine alternatives. A fuse description can therefore apply to fewer than those in the table, or be completely missing, depending on how the car is equipped.

If a position has multiple table values, it is due to variations in equipment level. In which case, follow the value of the fuse being replaced. In the event of doubt – contact a workshop. An authorised Volvo workshop is recommended.

	Function	Ampere	Type
1	–	–	Micro
2	–	–	Micro
3	Charge pressure module, turbo (petrol) Lambda sond group (petrol)	15	Micro
4	Spark plugs/ignition coils (petrol)	15	Micro
5	Solenoid engine oil pump Lambda probe group Solenoid air conditioning compressor	15	Micro
6	Oil level and temperature sensors Engine component group 1 (components related to engine function, including turbo/compressor. Contents depend on engine alternative.)	7,5	Micro
7	Engine Control Module (ECM) Throttle control module Engine component group 2 (components related to engine function, including turbo/compressor. Contents depend on engine alternative.)	20	Micro
8	Engine Control Module (ECM)	5	Micro
9	–	–	–
10	Engine component group 3 (components related to engine function, including turbo/compressor and cooling/temperature control of drivetrain. Contents depend on engine alternative.)	10	Micro
11	Control module, spoiler damper Control module, radiator damper Switching valve, coolant	5	Micro
12	Coolant pump	15	Micro
13	Engine Control Module (ECM)	20	Micro
14	–	–	MCase ^[1]
15	–	–	MCase ^[1]
16	Oil pump (petrol) Transmission control module (petrol)	30	MCase ^[1]
17	–	–	MCase ^[1]
18	Calculation unit	5	Micro
19	–	–	Micro
20	–	–	Micro
21	–	–	Micro
22	–	–	Micro
23	USB port, tunnel console, rear	7,5	Micro
24	12 V socket, tunnel console, front	15	Micro

Function	Ampere	Type
25 –	–	Micro
26 12 V socket cargo area *	15	Micro
27 –	–	Micro
28 Headlamp, left	15	Micro
29 Headlamp, right	15	Micro
30 –	–	Micro
31 Heated windscreen *, left	Shunt	MCase ^[1]
32 Heated windscreen *, left	40	MCase ^[1]
33 Headlamp washers*	25	MCase ^[1]
34 Washer fluid pump, front	25	MCase ^[1]
35 Electric gear selector	15	Micro
36 Horn (honk)	20	Micro
37 Siren*	5	Micro
38 Control module, brake system (valves, parking brake)	30	MCase ^[1]
39 Windscreen wipers	30	MCase ^[1]
40 Washer fluid pump, rear	25	MCase ^[1]
41 Heated windscreen *, right	40	MCase ^[1]
42 Parking heater*	20	MCase ^[1]
43 Central electronic module CEM	30	MCase ^[1]
44 –	–	MCase ^[1]
45 Heated windscreen *, right	Shunt	MCase ^[1]
46 Supplied when the ignition is switched on: Engine control module, Transmission components, Electric steering servo, Central electronic module, Control module brake system	5	Micro
47 Radar, front	5	Micro
48 Headlamp, right	15	Micro
49 –	–	Micro
50 Transmission control module	10	Micro
51 –	–	Micro
52 Collision module (SRS)	5	Micro
53 Headlamp, left	15	Micro
54 Accelerator pedal sensor	5	Micro

^[1] This type of fuse should be replaced by a workshop. An authorised Volvo workshop is recommended.

* Option/accessory.

18.5. Tools and accessories

18.5.1. Jack*

The jack can be used to raise the car, for example, to change to a wheel.



! Important

If a jack* is included with the car, it is only designed for occasional, short-term use, such as when changing a wheel after a puncture. Only the jack belonging to the specific model is to be used to jack up the car. If the car is to be jacked up more often, or for a longer time than is required just to change a wheel, use of a garage jack is recommended. In this instance, follow the instructions for use that come with the equipment.

When the jack is not in use it should be stored in its storage space under the cargo area floor. Crank the jack down for it to fit.

The jack needs to be cranked together to the correct position in order to have space.

i Note

Applies to cars with level control*: If the car is equipped with air suspension, this must be disabled before the car is raised.

* Option/accessory.

18.5.2. Emergency puncture repair kit

The emergency puncture repair kit (TMK^[1]) is used to seal a puncture as well as to check and adjust the air pressure in the tyre.

Cars equipped with spare tyre* do not have the emergency puncture repair kit.

The puncture repair kit consists of a compressor and a bottle with sealing fluid. The sealing works as a temporary repair.

i Note

The sealing fluid is effective at sealing tyres with tread punctures but has limited ability to seal tyres with sidewall punctures. Do not use the emergency puncture repair kit on tyres displaying larger slits, cracks or similar damage.

i Note

The compressor is intended for temporary emergency puncture repair and is approved by Volvo.

Location

The puncture repair kit is located in the foam block under the cargo area floor.



Sealing fluid expiry date

The bottle of sealing fluid must be replaced if the bottle's expiry date has passed (see the decal on the bottle). Treat the old bottle as environmentally hazardous waste.

^[1] Temporary Mobility Kit

* Option/accessory.

18.5.3. First aid kit *

The first aid kit contains first aid equipment.

Store the first aid kit in the cargo area behind the elastic strap, if the car is equipped with one of these.

* Option/accessory.

18.5.4. Warning triangle

Use the warning triangle to warn other road users if the car is stationary in traffic.

Also activate the hazard warning flashers.

Storage spaces

The warning triangle is located under the panel on the inside of the tailgate.

Folding up the warning triangle

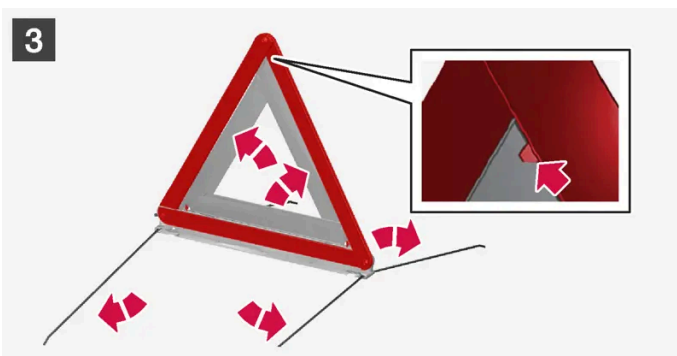
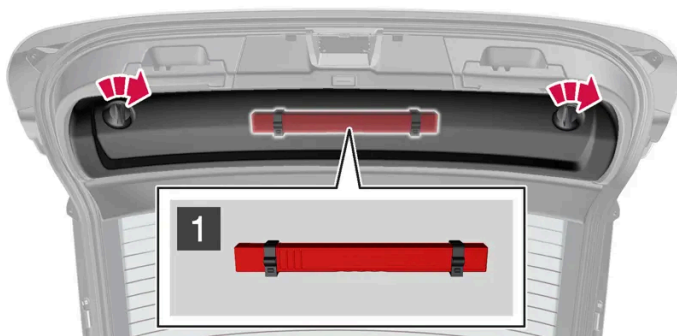

- 1** Detach the panel on the inside of the tailgate by first turning the two knobs a quarter turn and then unhooking the panel. Place the panel to one side.
Open the latch and take out the case.

2 **2**

Remove the warning triangle from the case, unfold it and put the ends together.

3 **3**

Fold out the warning triangle's support legs.

Follow the regulations for the use of a warning triangle. Position the warning triangle in a suitable place with regard to traffic.

Make sure that the warning triangle and case are properly secured in their storage space and that the hatch is fully closed after use.

18.5.5. Tool kit

Tools that can be useful during towing, wheel changes or similar are found in the car's cargo area.



Examples of tools that may be in the car.

- 1 Jack*
- 2 Tool for removing the plastic caps from the wheel bolts
- 3 Funnel for filling fluids
- 4 Wheel wrench* and towing eye

If the car is fitted with a spare wheel*, there is a jack and a wheel bolt wrench instead of emergency puncture repair kit.

* Option/accessory.

18.6. Fuses

18.6.1. Fuses and central electrical units

Electrical functions and components are protected by a number of fuses in order to protect the car's electrical system from damage by short circuiting or overloading. The fuses are fitted in the car's various fuse boxes.

Warning

Never replace a fuse with a foreign object or a fuse of higher amperage. This may lead to damage to the electrical system and cause fire.

Contact an authorised Volvo workshop about replacing the fuses not described in the owner's manual.

If an electrical component or function does not work, it may be because the component's fuse was overloaded, which must be changed. If the same fuse is overloaded repeatedly then there is a fault in the component. Volvo recommends contacting an authorised Volvo workshop for checking.

Location of central electrical units



The figure is schematic - appearance may vary depending on car model.

Central electrical unit locations in a left-hand drive car – for a right-hand drive car, the central electrical units under the glovebox change sides.

- 1** Engine compartment
- 2** Under the glovebox
- 3** Cargo area

18.6.2. Replacing a fuse

A fuse that has been overloaded needs to be changed in order to restore the function of the electrical component it is protecting.

- 1 Locate the correct fuse in the fuse lists for the various fuse boxes.
- 2 Pull out the fuse and check from the side to see whether the curved wire has blown.
- 3 If this is the case, replace it with a new fuse of the same colour and amperage.

 **Note**

Some fuse boxes may contain special tweezers for a better grip on the fuse.

 **Warning**

Never replace a fuse with a foreign object or a fuse of higher amperage. This may lead to damage to the electrical system and cause fire.

Contact an authorised Volvo workshop about replacing the fuses not described in the owner's manual.

 **Warning**

Contact an authorised Volvo workshop about replacing the fuses not described in the owner's manual.

18.6.3. Fuses under glovebox

The fuses in the fuse box under the glovebox protect components such as electrical sockets, displays and door modules.

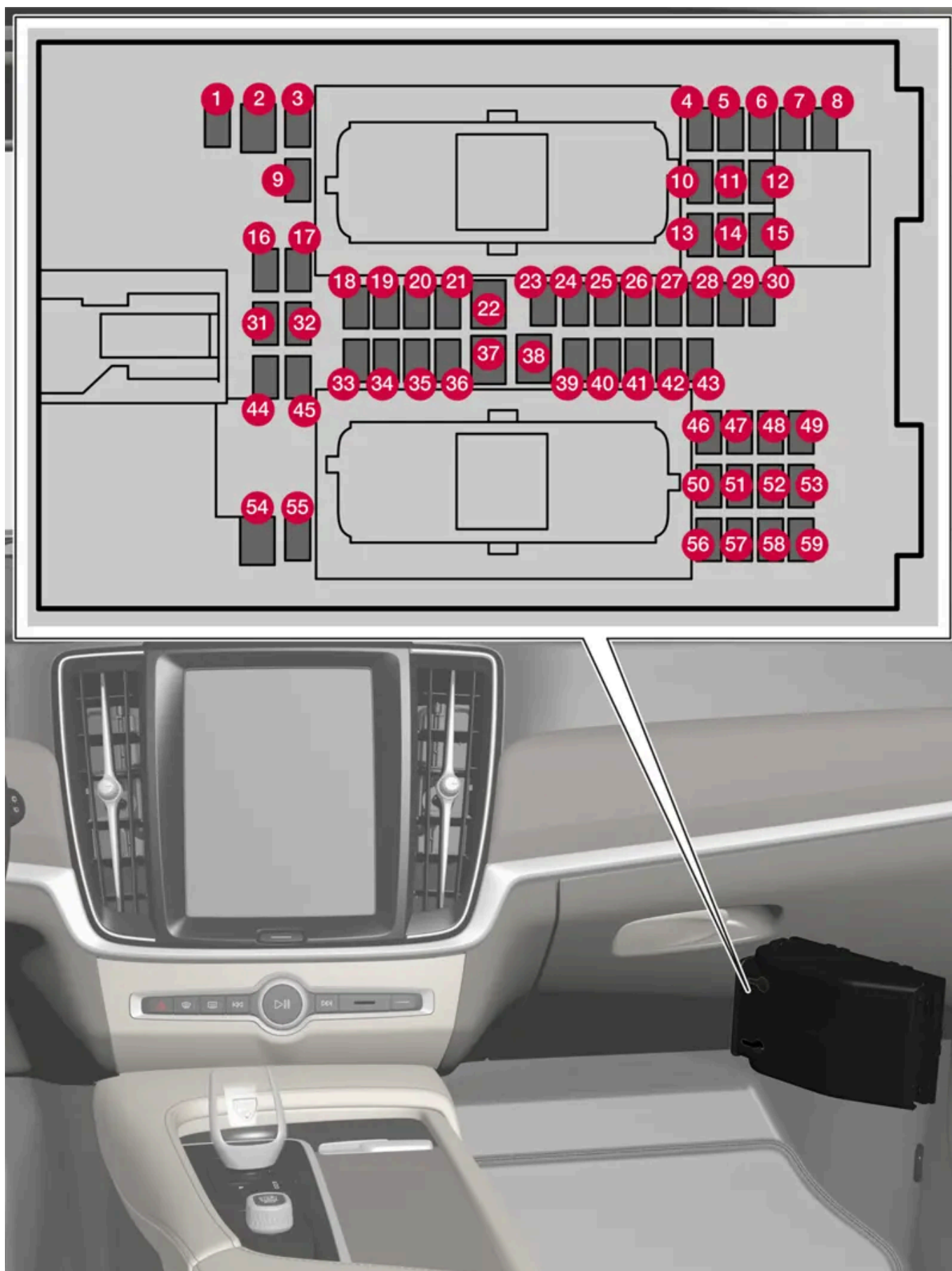

The central electrical unit is located behind the floor mat/side panel.

The content of this manual represents the status of the user manual at the time of printing and may not be completely valid in future instances. For more information, refer to the first page for the complete disclaimer note.

The **fuse box in the engine compartment** provides space for several spare fuses.

Positions

The positions of the fuses are shown on the inside of the cover. Functions and components in the fuse table cover several models and engine alternatives. A fuse description can therefore apply to fewer than those in the table, or be completely missing, depending on how the car is equipped.

If a position has multiple table values, it is due to variations in equipment level. In which case, follow the value of the fuse being replaced. In the event of doubt – contact a workshop. An authorised Volvo workshop is recommended.

	Function	Ampere	Type
1	Control module, 48 V battery	10	Micro
2	–	–	MCase ^[1]
3	–	–	Micro
4	Movement detector	5	Micro
5	–	–	Micro
6	Driver display	5	Micro
7	Keypad, centre console	5	Micro
8	Sun sensor Toll collection transponder	5	Micro
9	–	–	Micro
10	Infotainment system	15	Micro
11	Steering wheel module	5	Micro
12	Control module, start knob and parking brake	5	Micro
13	Heated steering wheel*	15	Micro
14	Airborne Particulate Matter Sensor (APMS)	5	Micro
15	–	–	Micro
16	–	–	Micro
17	Control module, rear lighting	15	Micro
18	Control module, climate control	10	Micro
19	Steering lock	7.5	Micro
20	Diagnostic port OBD-II	10	Micro
21	Centre display	5	Micro
22	Fan module, climate control, front	40	MCase ^[1]
23	USB hub	5	Micro
24	Controls lighting Passenger compartment lighting Dimming, interior rearview mirror* Rain and light sensors* Power front seats* Control panels, rear doors Fan module, climate control Ioniser Keypad, tunnel console at legroom rear seat*	7.5	Micro
25	Camera, front*	5	Micro

	Function	Ampere	Type
26	Roof console*	20	Micro
27	Head-up display*	5	Micro
28	Passenger compartment lighting	5	Micro
29	Wireless charging plate *	5	Micro
30	Display roof console Control module, camera wide-angle	5	Micro
31	–	–	Micro
32	–	–	Micro
33	–	–	Micro
34	Fuse box, cargo area	10	Micro
35	Control module, online car Control module, Volvo Services	5	Micro
36	–	–	Micro
37	Audio control device (amplifier)	40	MCASE ^[1]
38	–	–	MCASE ^[1]
39	Antenna module (TCAM)	5	Micro
40	Control module, seat comfort, front*	5	Micro
41	Alcohol lock* –	5 –	Micro
42	Rear window wiper	15	Micro
43	Control module, fuel pump	15	Micro
44	Converter 48 V Engine start module	5	Micro
45	Control module, driver support functions (active safety)	5	Micro
46	Seat heating, driver's side front	15	Micro
47	Seat heating, passenger side front	15	Micro
48	Coolant pump	7.5	Micro
49	Air cleaner	5	Micro
50	Power driver's seat*	20	Micro
51	Module, active damping*	20	Micro
52	Opening the boot lid/tailgate with foot motion *	5	Micro
53	Infotainment system	10	Micro
54	–	–	MCASE ^[1]
55	–	–	Micro
56	Electrically operated front passenger seat*	20	Micro
57	–	–	Micro
58	–	–	Micro
59	–	–	Micro

^[1] This type of fuse should be replaced by a workshop. An authorised Volvo workshop is recommended.

* Option/accessory.

The content of this manual represents the status of the user manual at the time of printing and may not be completely valid in future instances. For more information, refer to the first page for the complete disclaimer note.

18.6.4. Fuses in cargo area

Fuses in the cargo area protect, amongst other things, power seats*, airbags and seatbelt tensioners.

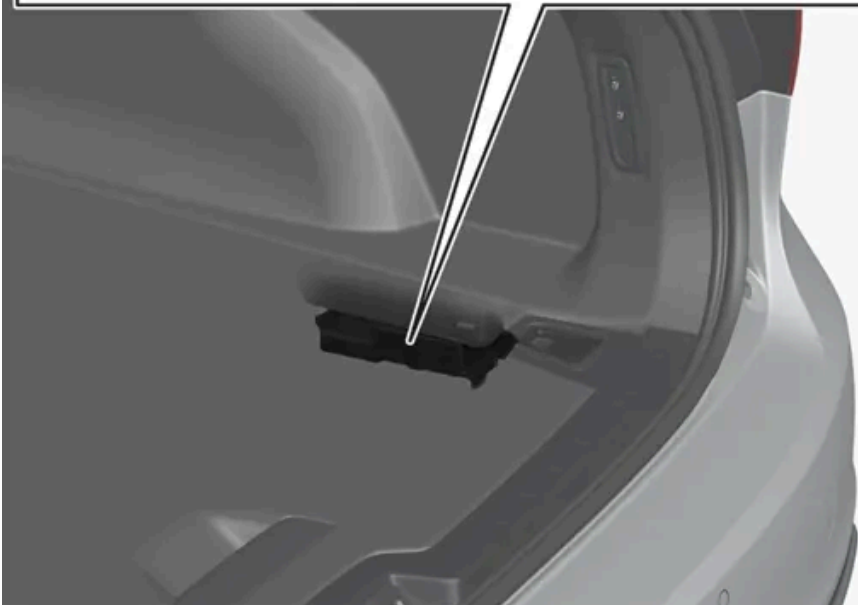
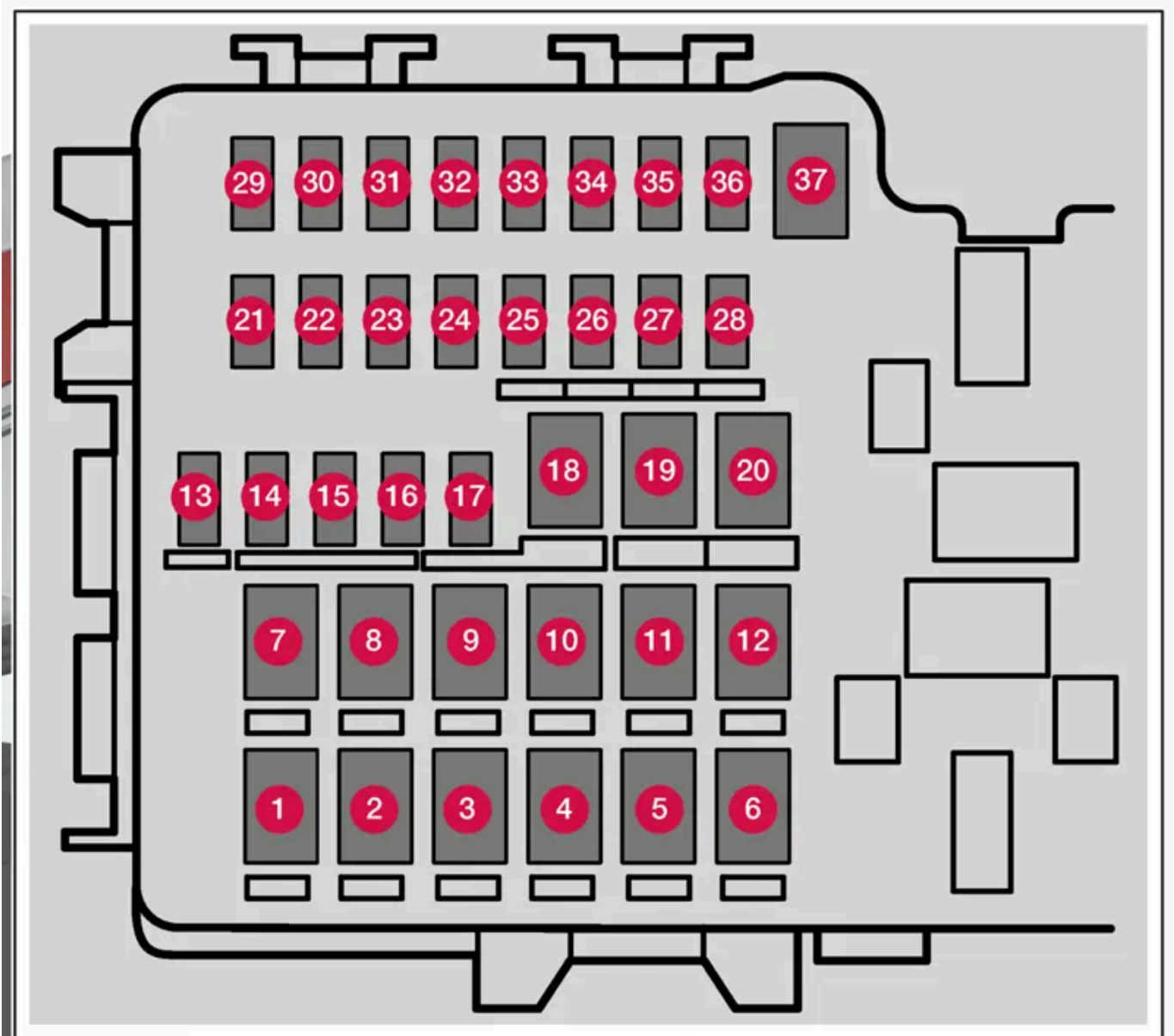

The central electrical unit is located behind the panel on the right-hand side.

Special pliers are housed on the inside of the cover to facilitate replacement of tripped fuses.

The **fuse box in the engine compartment** also provides space for several spare fuses.

Positions

Fuse locations are shown on the inside of the cover. Functions and components in the fuse table cover several models and engine alternatives. A fuse description can therefore apply to fewer than those in the table, or be completely missing, depending on how the car is equipped.

If a position has multiple table values, it is due to variations in equipment level. In which case, follow the value of the fuse being replaced. In the event of doubt – contact a workshop. An authorised Volvo workshop is recommended.

	Function	Ampere	Type
1	Rear window defroster	30	MCASE ^[1]
2	Central electronic module	40	MCASE ^[1]
3	Compressor, air suspension*	40	MCASE ^[1]
4	–	–	MCASE ^[1]
5	–	–	MCASE ^[1]
6	–	–	MCASE ^[1]
7	Door module, right rear	20	MCASE ^[1]
8	–	–	MCASE ^[1]
9	Power operated tailgate*	25	MCASE ^[1]
10	Door module, right rear	20	MCASE ^[1]
11	Towbar control module*	40	MCASE ^[1]
12	Seatbelt pretensioner, right	40	MCASE ^[1]
13	Internal relay coils	5	Micro
14	–	–	Micro
15	Door module, left rear	20	Micro
16	–	–	Micro
17	–	–	Micro
18	Towbar control module*	25	MCASE ^[1]
	Accessory module	40	
19	Door module, left front	20	MCASE ^[1]
20	Seatbelt pretensioner, left	40	MCASE ^[1]
21	–	–	Micro
22	Rear lighting (backup)	10	Micro
23	–	–	Micro
24	–	–	Micro
25	Supply when the ignition is switched on	10	Micro
26	–	–	Micro
27	–	–	Micro
28	Seat heating, left rear*	15	Micro
29	Actuator, exhaust system	5	Micro

	Function	Ampere	Type
30	Blind Spot Information (BLIS) *	5	Micro
31	–	–	Micro
32	–	–	Micro
33	–	–	Micro
34	–	–	Micro
35	Control module All Wheel Drive (AWD) *	15	Micro
36	Seat heating, right rear *	15	Micro
37	–	–	MCase ^[1]

* Option/accessory.

^[1] This type of fuse should be replaced by a workshop. An authorised Volvo workshop is recommended.

18.6.5. Fuses in engine compartment

Among other things, the engine compartment fuses protect functions related to the engine and the brake system.

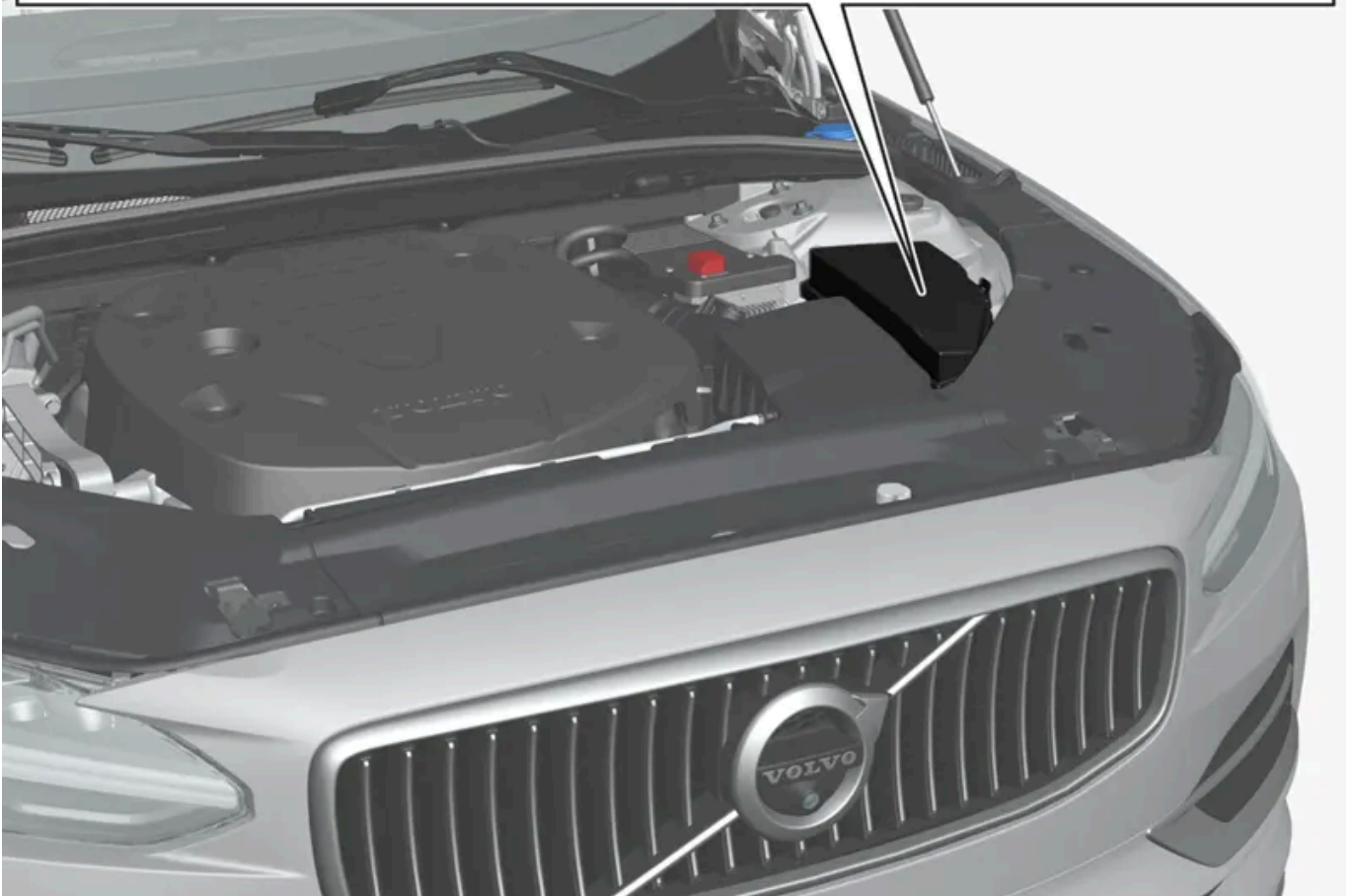
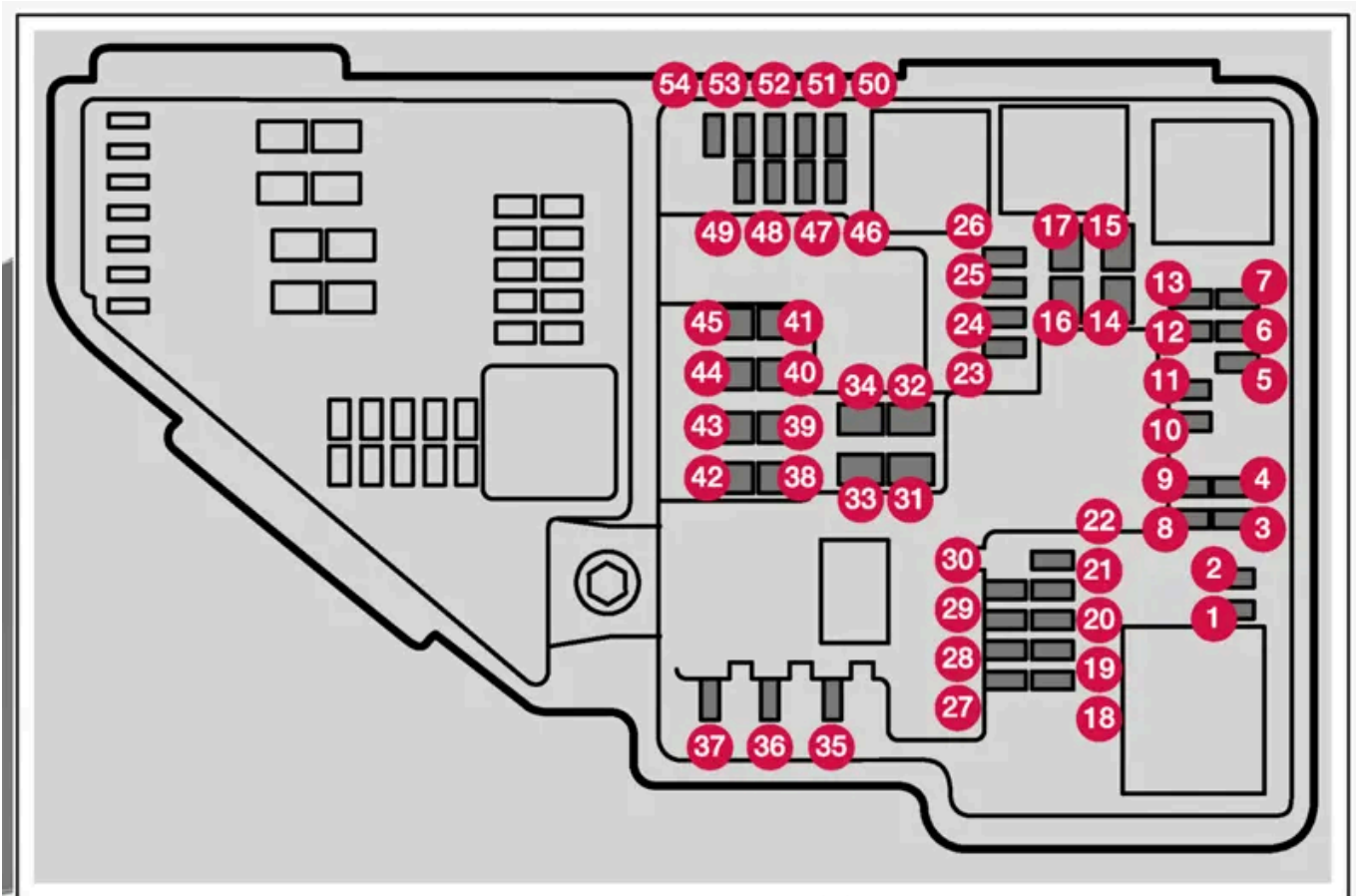

Special pliers are housed on the inside of the cover to facilitate replacement of tripped fuses.

The fuse box also provides space for several spare fuses.

Positions

Fuse locations are shown on the inside of the cover. Functions and components in the fuse table cover several models and engine alternatives. A fuse description can therefore apply to fewer than those in the table, or be completely missing, depending on how the car is equipped.

If a position has multiple table values, it is due to variations in equipment level. In which case, follow the value of the fuse being replaced. In the event of doubt – contact a workshop. An authorised Volvo workshop is recommended.

	Function	Ampere	Type
1	–	–	Micro
2	–	–	Micro
3	Charge pressure module, turbo (petrol) Lambda sond group (petrol)	15	Micro
4	Spark plugs/ignition coils (petrol)	15	Micro
5	Solenoid engine oil pump Lambda probe group Solenoid air conditioning compressor	15	Micro
6	Oil level and temperature sensors Engine component group 1 (components related to engine function, including turbo/compressor. Contents depend on engine alternative.)	7,5	Micro
7	Engine Control Module (ECM) Throttle control module Engine component group 2 (components related to engine function, including turbo/compressor. Contents depend on engine alternative.)	20	Micro
8	Engine Control Module (ECM)	5	Micro
9	–	–	–
10	Engine component group 3 (components related to engine function, including turbo/compressor and cooling/temperature control of drivetrain. Contents depend on engine alternative.)	10	Micro
11	Control module, spoiler damper Control module, radiator damper Switching valve, coolant	5	Micro
12	Coolant pump	15	Micro
13	Engine Control Module (ECM)	20	Micro
14	–	–	MCase ^[1]
15	–	–	MCase ^[1]
16	Oil pump (petrol) Transmission control module (petrol)	30	MCase ^[1]
17	–	–	MCase ^[1]
18	Calculation unit	5	Micro
19	–	–	Micro
20	–	–	Micro
21	–	–	Micro
22	–	–	Micro
23	USB port, tunnel console, rear	7,5	Micro
24	12 V socket, tunnel console, front	15	Micro

Function	Ampere	Type
25 –	–	Micro
26 12 V socket cargo area *	15	Micro
27 –	–	Micro
28 Headlamp, left	15	Micro
29 Headlamp, right	15	Micro
30 –	–	Micro
31 Heated windscreen *, left	Shunt	MCase ^[1]
32 Heated windscreen *, left	40	MCase ^[1]
33 Headlamp washers*	25	MCase ^[1]
34 Washer fluid pump, front	25	MCase ^[1]
35 Electric gear selector	15	Micro
36 Horn (honk)	20	Micro
37 Siren*	5	Micro
38 Control module, brake system (valves, parking brake)	30	MCase ^[1]
39 Windscreen wipers	30	MCase ^[1]
40 Washer fluid pump, rear	25	MCase ^[1]
41 Heated windscreen *, right	40	MCase ^[1]
42 Parking heater*	20	MCase ^[1]
43 Central electronic module CEM	30	MCase ^[1]
44 –	–	MCase ^[1]
45 Heated windscreen *, right	Shunt	MCase ^[1]
46 Supplied when the ignition is switched on: Engine control module, Transmission components, Electric steering servo, Central electronic module, Control module brake system	5	Micro
47 Radar, front	5	Micro
48 Headlamp, right	15	Micro
49 –	–	Micro
50 Transmission control module	10	Micro
51 –	–	Micro
52 Collision module (SRS)	5	Micro
53 Headlamp, left	15	Micro
54 Accelerator pedal sensor	5	Micro

^[1] This type of fuse should be replaced by a workshop. An authorised Volvo workshop is recommended.

* Option/accessory.

18.7. Battery

18.7.1. Replacing the battery in the key

The battery in the key can be replaced when it has discharged. The service life of the battery depends on how much the key is used. The Key Tag* battery cannot be replaced.

Note

All batteries have a limited service life and must eventually be replaced (does not apply to Key Tag). The service life of the battery varies depending on how often the vehicle/key is used.



The key's battery needs to be replaced when the information symbol is illuminated and the **The car key battery is low**. See **Owner's Manual for replacement**. message is shown in the driver display.

Another sign that the battery level is low is decreased range for the key.

The battery in the Key tag (Key Tag)* cannot be replaced. When the battery is discharged, a new Key tag can be ordered from an authorised Volvo workshop.

Important

Hand in a discharged Key Tag to an authorised Volvo workshop where it can be deleted from the car's system. The key can still be used to start the car via back-up start when the battery has been discharged.

Opening the key and changing its battery

Important

Avoid touching the contact surfaces of a new battery with your fingers. This impairs the battery's functionality.

Hold the key so that its front with the Volvo logotype is facing up, and with the keyring bracket facing you.

There is a catch on the left of the keyring bracket. If it is on the wrong side then the front and rear have been mixed up when the battery was replaced on an earlier occasion.

1 **1**



Slide the catch by the keyring bracket to the side, and slide the front shell away from the bracket.

- The shell detaches and can be lifted off.
There is a further catch under the shell to detach the rear.

2 **2**



Slide the catch that was behind the front shell to the side, and slide the rear shell away from the key ring bracket.

- The shell detaches and can be lifted off.
The battery cover is under the shell.

3 **3**



Turn the battery cover anticlockwise to OPEN position. Use a screwdriver or a coin, for example.
Lift off the battery cover. If it is difficult to detach, you can prize it upward using a narrow tool.

4 **4**



The battery (+) side is facing upwards. Loosen the battery by pressing on its edge and then lifting it out.

5 **5**



Install a new battery with the (+) side up. Avoid touching the key's battery contacts with your fingers.

Position the edge of the battery under the two outer plastic catches.

Then press down on the battery so that it is held in place by the upper plastic catch.

i Note

Use batteries with the designation CR2032, 3 V.

i Note

Volvo recommends that replacement batteries for the key meet UN Manual of Test and Criteria, Part III, sub-section 38.3. The batteries that are included or the batteries used for replacement by an authorised Volvo workshop will meet the same criterion.

6 **6**



Refit the battery cover and turn clockwise to CLOSE position.

7 **7**



Refit the rear shell in reverse order to how it was removed. There is no logotype on the rear shell. Press in the shell until you hear a click, and then slide it the last few millimetres to its original position.

- A further click will indicate that the shell is properly positioned and securely attached. There must be no gaps remaining.

8 **8**



Turn the key and refit the front shell in the same way as for the rear.

Warning

Check that the battery is fitted correctly with the correct polarity. If the key shall not been used for a long time, remove the battery to avoid battery leakage and damage. Batteries with damage or leaks may cause corrosive injury on contact with the skin. Therefore, use protective gloves when handling damaged batteries.

- Keep batteries out of the reach of children.
- Do not leave batteries lying around since they can be swallowed by children or pets.
- Batteries must not: be dismantled, short-circuited or thrown into open flames.
- Do not try to charge non-rechargeable batteries. They may explode.
- Check battery operated products for signs of damage on a regular basis.

The key should not be used if anything indicates that the key or its battery has been damaged or has started to leak. Keep defective products out of the reach of children.

Important

Used batteries must be recycled in an environmentally sound manner.

* Option/accessory.

18.7.2. Overloading the starter battery

High power consumption without the car being able to charge the starter battery leads to low battery level and some electric functions being reduced or switched off. If the battery level decreases to below a certain

The content of this manual represents the status of the user manual at the time of printing and may not be completely valid in future instances. For more information, refer to the first page for the complete disclaimer note.

limit, it is no longer possible to start the car without jump starting or charging the starter battery with an external charger.

There are several measures that reduce power consumption. Avoid using the ignition position II when the car is switched off. Instead, use ignition position I - which consumes less power. Do not use functions which use a lot of power when the car is not being driven. Examples of such functions are:

- ventilation fan
- headlamps
- windscreen wiper
- audio system
- accessories that are activated in the car.

If the battery level is low, a message is shown in the driver display. The energy-saving function then shuts down certain functions or reduces certain functions such as the ventilation fan and audio system.

- 1 In which case, charge the starter battery by starting the car and then running it for at least 15 minutes. Starter battery charging is more effective during driving than running at idling speed.

If the battery level continues to be low after the measures have been taken, the car should be checked at a workshop – an authorised Volvo workshop is recommended.

 **Note**

High current take-off may lead to low battery level, which temporarily limits the start/stop function. The engine can then be started automatically during a stop to charge the battery.

18.7.3. Using jump starting with another battery

If the starter battery is discharged then the car can be started with current from another battery.

Jump starting requires access to another car's 12 V battery as well as jump leads.

 **Important**

The charging points in mild hybrid type cars are designed for only jump starting the car itself. Do not use the charging points of mild hybrids to start other cars – the fuse for the charging circuit may be overloaded so that it stops working.

In mild hybrid type cars, a discharged starter battery may be caused by an overloaded fuse which prevents charging. If the fuse has blown, the message **12 V battery fuse failure Service required** is shown in the driver display. Volvo recommends that an authorised Volvo workshop is contacted.

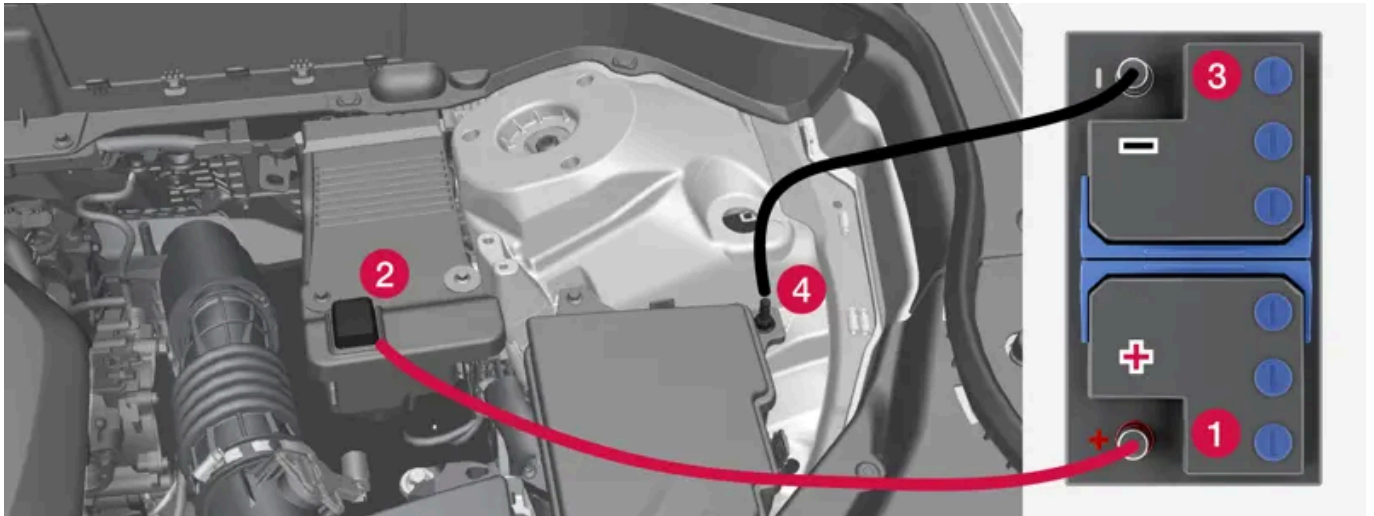

Charging points for jump starting own car. The appearance in the engine compartment may vary depending on car model and equipment level.

When jump starting the car, the following steps are recommended to avoid short circuits or other damage:

- 1 Set the car's electrical system in ignition position 0.
- 2 Check that the donor battery has a voltage of 12 V.
- 3 If the battery is installed in another car – switch off its engine and make sure that the cars do not touch each other.
- 4 Connect one of the red jump lead's clamps to the donor battery's positive terminal (1).

! Important

Connect the jump lead carefully to avoid a short circuit and contact with other components in the engine compartment.

- 5 Open the positive charging point's cover (2).
- 6 Attach the red jump lead's other clamp onto the car's positive charging point (2).
- 7 Connect one of the black jump lead's clamps to the donor battery's negative terminal (3).
- 8 Attach the black jump lead's other clamp onto the car's negative charging point (4).
- 9 Check that the jump lead clamps are affixed securely. Poor contact may cause sparks or the clamps to loosen during the starting attempt.
- 10 Start the engine of the donor car and allow it to run for a few minutes at a rotation speed higher than normal idle approx. 1500 rpm.
- 11 Start the engine in the car with the discharged battery.

 **Important**

Do not touch the connections between cable and car during the starting attempt. There is a risk of sparks forming.

12 Remove the jump leads in reverse order - first the black and then the red.

Make sure that neither of the black jump lead's clamps comes into contact with the car's positive charging point, the donor battery's positive terminal, or the clamp connected to the red jump lead.

 **Warning**

Mild hybrid type cars have components that work with 48 V voltage, which can be dangerous in the event of incorrect intervention. Do not touch components that are not clearly described in the owner's manual.

- 48 V support battery must never be used for jump starting.
- External electrical equipment must not, under any circumstances, be connected to the 48 V battery.
- The 48 V battery may only be serviced and replaced by a workshop – an authorised Volvo workshop is recommended.

 **Warning**

- The battery can generate oxyhydrogen gas, which is highly explosive. A spark can be formed if a jump lead is connected incorrectly, and this can be enough for the battery to explode.
- Do not connect the jump leads to any fuel system component or any moving part. Be careful of hot engine parts.
- The battery contains sulphuric acid, which can cause serious burns.
- If sulphuric acid comes into contact with eyes, skin or clothing, flush with large quantities of water. If acid splashes into the eyes - seek medical attention immediately.
- Never smoke near the battery.

 **Note**

If the starter battery has such a low State Of Charge (SoC) that the car has no normal electrical functions and the engine is then jump-started with an external battery or a battery charger, the Start/stop function may continue to be activated. If the Start/stop function then auto-stops the engine shortly afterwards, there is a great risk that engine auto-start will fail because the battery has not had the time to recharge sufficiently.

If the car has been jump-started, or if there is insufficient time to charge the battery using a battery charger, the Start/stop function will be temporarily deactivated until the battery has been sufficiently recharged by the car. In an outside temperature of approx. +15 °C (approx. 60 °F), the battery needs to be charged for at least 1 hour by the car. In a lower outside temperature, the charging time may increase to 3–4 hours. The recommendation is to charge the battery if possible using an external battery charger.

18.7.4. Batteries and power supply

The car's own power supply is connected to several different batteries and components. These make it possible to use the car's electrical functions.

The car's primary electrical system operates with 12 V voltage and powers electrical equipment.

In addition to the primary electrical system, mild hybrid* type cars are equipped with a 48 V system.

Batteries

In order to supply power to the various components, your car is equipped with the following:

- a 12 V starter battery that powers the car's primary electrical system
- a support battery that helps during the Start/Stop function's starting sequence. The battery is either a 12 V battery or, if the car is the mild hybrid* type, a 48 V battery that also allows regenerative braking while driving.

Warning

Mild hybrid type cars have components that work with 48 V voltage, which can be dangerous in the event of incorrect intervention. Do not touch components that are not clearly described in the owner's manual.

- 48 V support battery must never be used for jump starting.
- External electrical equipment must not, under any circumstances, be connected to the 48 V battery.
- The 48 V battery may only be serviced and replaced by a workshop – an authorised Volvo workshop is recommended.

* Option/accessory.

18.7.5. Recycling the batteries







Used batteries must be recycled in an environmentally sound manner.

Consult a workshop in the event of uncertainty about how this type of waste should be disposed of - an authorised Volvo workshop is recommended. The 48V battery is the mild hybrid* type and must only be handled by authorised workshop personnel.

* Option/accessory.

18.7.6. Symbols on the batteries

There are information and warning symbols on the batteries.

	Use protective goggles.
	Further information in the owner's manual for the car.
	Store the battery out of the reach of children.
	The battery contains corrosive acid.
	Avoid sparks and naked flames.
	Risk of explosion.
	Must be taken for recycling.

18.7.7. Starter battery

The starter battery powers the car's primary electrical system, which includes electrical equipment and starting the engine. If the car is the mild hybrid* type, the engine is instead started by the support battery.

The starter battery is a 12 V-battery that is dimensioned to power the car model's specific electrical system and functions.

- Never disconnect the starter battery when the engine is running.
- Check that the cables to the starter battery are correctly connected and properly tightened.

Important

On certain models, the battery is attached with a retaining strap. Make sure the retaining strap is properly tightened.

Important

If the battery is replaced, make sure you replace it with a battery with the same size, cold starting capacity and type as the original battery (see the decal on the battery). Volvo recommends that you use an authorised Volvo workshop for replacing the battery.

Warning

If the starter battery (12 V battery) has been disconnected, the automatic opening and closing function must be reset to work properly. A reset must take place for pinch protection to work.

Warning

- The battery can generate oxyhydrogen gas, which is highly explosive. A spark can be formed if a jump lead is connected incorrectly, and this can be enough for the battery to explode.
- Do not connect the jump leads to any fuel system component or any moving part. Be careful of hot engine parts.
- The battery contains sulphuric acid, which can cause serious burns.
- If sulphuric acid comes into contact with eyes, skin or clothing, flush with large quantities of water. If acid splashes into the eyes - seek medical attention immediately.
- Never smoke near the battery.

The starter battery's service life, capacity and long-term storage

The service life of the starter battery is influenced by a number of factors, such as the number of starts, discharges, driving style, driving conditions, and climate conditions. The battery's starting capacity gradually decreases over time. Extreme cold further limits starting capacity.

The battery level may become low if the car is not used for any length of time or if it only travels short distances.

To keep the starter battery in good condition, at least 15 minutes of driving a week is recommended, or connecting the battery to a battery charger with automatic trickle charging. A starter battery that is kept fully charged has a maximum service life.

Location

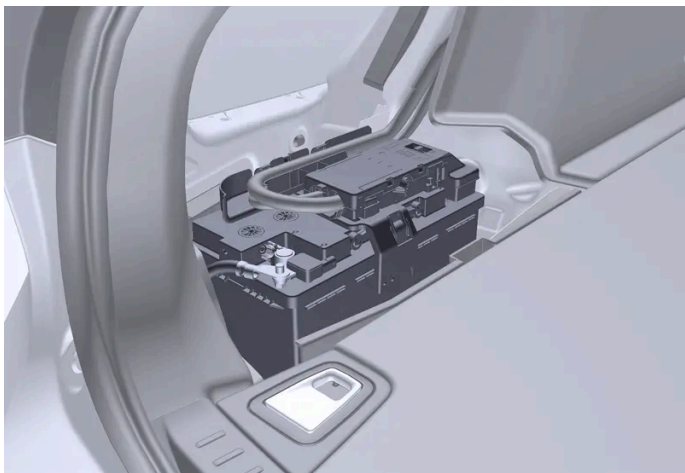

The starter battery is located in the cargo area.

Specifications for starter battery

Battery type	H7 AGM	H8 AGM
Voltage (V)	12	12

Battery type	H7 AGM	H8 AGM
Cold start capacity ^[1] - CCA ^[2] (A)	800	850
Size, L×B×H	315×175×190 mm (12.4×6.9×7.5 inches)	353×175×190 mm (13.9×6.9×7.5 inches)
Capacity (Ah)	80	95

* Option/accessory.

^[1] According to EN standard.

^[2] Cold Cranking Amperes.

18.7.8. Support battery

The car is equipped with a support battery that helps during the Start/Stop function's starting sequence.

The battery is either a 12 V battery or, if the car is the mild hybrid* type, a 48 V battery that also allows regenerative braking while driving.

Location



12 V support battery is located in the engine compartment.



The content of this manual represents the status of the user manual at the time of printing and may not be completely valid in future instances. For more information, refer to the first page for the complete disclaimer note.

Cars of the mild hybrid type have a 48 V support battery located under the cargo area. The battery and the box around it must only be handled by an authorised workshop.

Support battery maintenance

The support battery normally requires no more service than the normal starter battery. A workshop should be contacted in the event of questions or problems - an authorised Volvo workshop is recommended.

Important

If the 12 V battery is replaced, make sure you replace it with a battery with the same size, cold starting capacity and type as the original battery. Volvo recommends that you use an authorised Volvo workshop for replacing the battery.

Warning

Mild hybrid type cars have components that work with 48 V voltage, which can be dangerous in the event of incorrect intervention. Do not touch components that are not clearly described in the owner's manual.

- 48 V support battery must never be used for jump starting.
- External electrical equipment must not, under any circumstances, be connected to the 48 V battery.
- The 48 V battery may only be serviced and replaced by a workshop – an authorised Volvo workshop is recommended.

Specifications for support battery

Battery type	AGM
Voltage (V)	12
Cold start capacity ^[1] - CCA ^[2] (A)	170
Size, L×B×H	150×90×130 mm (5.9×3.5×5.1 inches)
Capacity (Ah)	10

If the car is the mild hybrid* type, the support battery is a lithium-ion type 48 V battery.

* Option/accessory.

^[1] According to EN standard.

^[2] Cold Cranking Amperes.

18.8. Service

18.8.1. Servicing the climate control system

The air conditioning system must only be serviced and repaired by an authorised workshop.

Troubleshooting and repair

The air conditioning system contains fluorescent tracing agents. Ultraviolet light is used for leak detection.

Volvo recommends that an authorised Volvo workshop is contacted.

The car's climate control system uses R1234yf freon-free refrigerant. Information about the refrigerant is printed on a decal located on the inside of the bonnet.

Warning

The air conditioning system contains pressurised refrigerant R1234yf. In accordance with SAE J2845 (Technician Training for Safe Service and Containment of Refrigerants Used in Mobile A/C System), service and repair of the refrigerant system must only be performed by trained and certified technicians in order to ensure the safety of the system.

18.8.2. Volvo service programme

To keep the car as safe and reliable as possible, follow the Volvo service programme as specified in the Service and Warranty Booklet.

Volvo recommends engaging an authorised Volvo workshop to perform the service and maintenance work. Volvo workshops have the personnel, special tools and service literature that can provide the highest quality of service.

Important

For the Volvo warranty to apply, check and follow the instructions in the Service and Warranty Booklet.

18.9. Recommended maintenance for camera, sensor and radar units

In order that the cameras, parking sensors and radar units shall work correctly, they must be kept clean of dirt, ice and snow, and be cleaned regularly with water and car shampoo.

- Do not affix any objects, tape or decals in the areas described below.
- Clean camera lenses regularly with lukewarm water and car shampoo - be careful not to scratch the lenses.
- Avoid fitting auxiliary lamps or similar in the grille as this may affect the performance of the front radar unit.

- Use only Volvo genuine emblems in the grille in front of the front radar unit so as not to affect the function of the front radar unit.

Radar unit locations



Location of front radar unit



Location of rear radar units

Location of the parking sensors

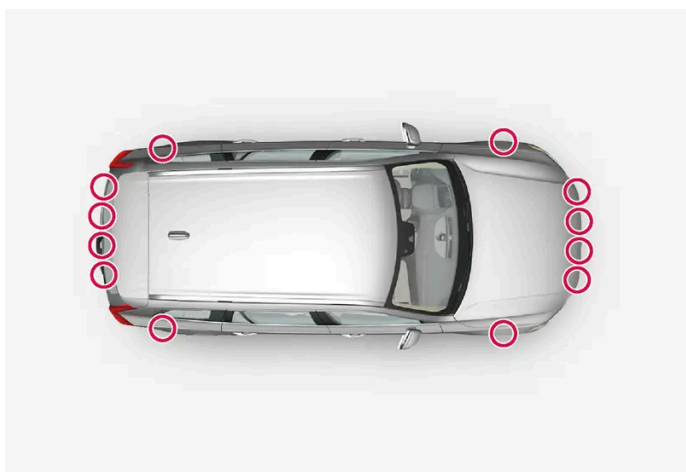

Location of the parking sensors around the car

i Note

Dirt, ice and snow covering the sensors may cause incorrect warning signals, reduced or no function.

Camera location



Location of front camera unit

! Important

Maintenance of driver support components must only be performed at a workshop – an authorised Volvo workshop is recommended.

18.10. Software updates

The car's software is updated through its connection to the mobile network, which is designated OTA (over-the-air).

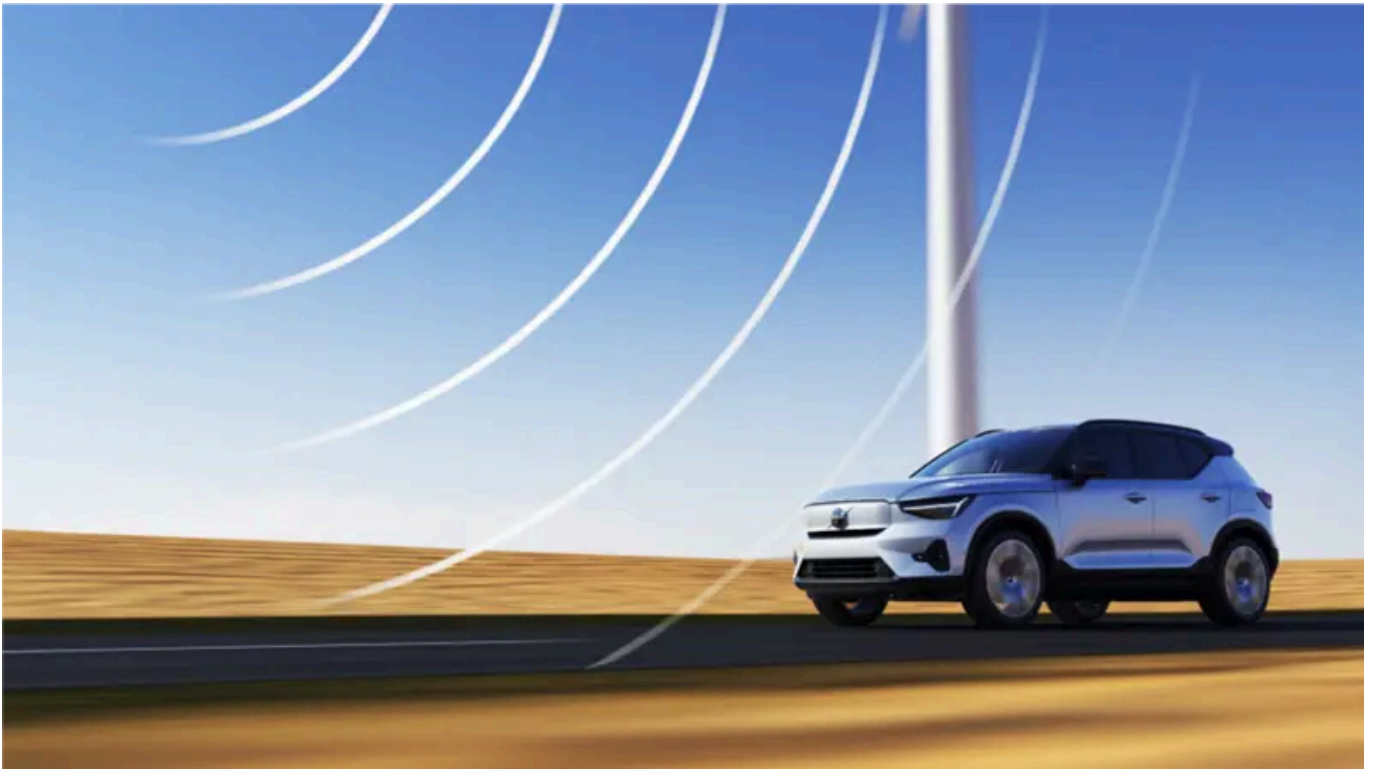

The notification view shows when a new software update is available. You can choose when to install it after it has been downloaded. Update the software in the car as soon as possible when an update is available.

Download

Note

The software in declared ordinary software release windows does not affect certification, safety, emissions or non-compliance.

The download takes place in the background via mobile network^[1]. It may take several hours, depending on the size of the update and the speed of the connection.

The following is required in order to download updates:

- the car is connected to the Internet^[2].
- approval of the use of online services.

Note

Depending on software version, download may start automatically, or be started via the notification of an available software update.

Installing an update

The content of this manual represents the status of the user manual at the time of printing and may not be completely valid in future instances. For more information, refer to the first page for the complete disclaimer note.

i Note

Do not use the data link connector when a software update is being installed, as it can affect the installation process and the car's system.

Once a software update has been downloaded and is ready for installation, this is shown in the notification view and by a message when the car is started. You can choose to install the update immediately, or have a further reminder at a later date.

Update view is accessed via , **System, System details, Software update**. There you can also see the current version number of the software in the car.

i Note

The installation of the software update may take up to 90 minutes. During this time, the car will be locked and its functions unavailable. Bear this in mind when scheduling the update.

During installation:

- 1 The notification view shows when an update is ready for installation. Open the notification and follow the instructions in the centre display.
- 2 Leave the car, close all doors, and lock the car.
 - The installation is started. The car must be locked within several minutes otherwise the installation is cancelled.
- 3 Wait until the installation is finished.
 - The installation may take up to 90 minutes. When the installation is finished the car can be used as normal.

i Note

- If possible, avoid handling the car, its charging cable and other functions during the installation.
- If you need to enter the car while installation is in progress, you must use the key blade.
- The car's anti-theft alarm is disarmed during installation in order to avoid false alarms.

Always read through what the update contains so that you know how the car and its functions are affected.

If the installation fails, the car's systems are reset to the latest installed version.

i Note

It is important to install software updates as soon as possible in order to avoid the risks that may be associated with old software. If you experience problems with the update – contact your Volvo dealer.

Information on contents

The content of this manual represents the status of the user manual at the time of printing and may not be completely valid in future instances. For more information, refer to the first page for the complete disclaimer note.

Tap on the information symbol in the centre display for more information on the content of the software update.

 **Note**

Functionality after updating may vary depending on market, model, model year and options.

^[1] Applies to cars with software 2.9 or later. For cars with older software, the download is only possible when the car is being driven. It can therefore take several drive cycles before the software is downloaded.

^[2] Use of the Internet involves data transfer (data traffic), which may involve charges. Volvo meets the cost of data traffic for system updates unless a personal SIM card is installed.

18.11. Brake system maintenance

Check brake system components regularly for wear.

To keep the car as safe and reliable as possible, follow the Volvo service intervals as specified in the Service and Warranty Booklet. After replacing brake linings and brake discs, braking effect is only adapted after they have been "worn in" for a few hundred kilometres (miles). Compensate for the reduced braking effect by depressing the brake pedal harder. Volvo recommends only fitting brake linings that are approved for your Volvo.

 **Important**

The wear on the brake system's components must be checked regularly.

Contact a workshop for information about the procedure or engage a workshop to carry out the inspection - an authorised Volvo workshop is recommended.

18.12. Operational disruption

If you experience an operational disruption or deviation from the car's normal function then it may be due to a fault or the specific circumstances of the situation.

Some functions have limitations in particular situations and require that certain conditions are fulfilled in order to work. The driver display and centre display may show messages in order to inform about such a situation.

Find out more about fault-tracing and the limitations of various functions in related articles below.

If the car is not drivable

Activate the hazard warning flashers if the car has broken down or been forced to stop unexpectedly in a trafficked environment. Think about safety. If possible, move the car out of danger from traffic. Put on a reflective vest and then position the

warning triangle so that other road users are warned in good time. Call roadside assistance if the cause cannot be remedied at your location.

18.13. Data transfer between car and workshop via Wi-Fi

Volvo's workshops have a specific Wi-Fi network for data transfer between the car and the workshop. The car is connected using the key's buttons, so it is important to take along a key with buttons in the event of a workshop visit.

During a workshop visit, your service technician can perform fault-tracing and update software via the network.

Connection with a key

Press three times on the lock button on the key to connect the car to the workshop's network. Connection is normally handled by the service technician.

When the car is connected to a Wi-Fi network, the  symbol appears in the centre display.

It is not possible to use the key to connect to other Wi-Fi networks.

 **Warning**

The car must not be driven when connected to the workshop's networks and systems.

18.14. Raising the car

It is important to use the correct lifting points on the car's chassis when using a jack* to raise the car. Different lifting points are available depending on which type of lifting equipment is used. Read through all of the instructions before raising the car.

The car can be raised using a jack designed for short-term raising, or using a garage jack if the car needs to be raised regularly, or by authorised workshop personnel that have access to larger lifting devices.

 **Note**

Volvo recommends only using the jack that belongs to the car model in question. If another jack has to be used, follow the enclosed instructions.

The normal car jack* is only designed for occasional, short-term raising, such as when changing a wheel after a puncture. If the car is to be jacked up more often, or for a longer time than is required just to change a wheel, a garage jack is recommended. In this instance, follow the enclosed instructions.

 **Warning**

- The car must not be allowed to roll while it is being raised. Apply the parking brake and set the gear selector in Park position (P).
- Chock in front of and behind the wheels that remain on the ground using solid wooden blocks or large stones.
- When changing a wheel, use a jack intended for the car model. Use additional stands to support the car for all other work.
- Do not use a jack in poor condition. Check that the threads are lubricated, and that it is free of damage and dirt.
- Check that the jack is stable. The surface underneath must be firm, flat and not slippery.
- Never position anything between the ground and the jack, or between the jack and the car's lifting point.
- Never allow passengers to remain in the car while the car is being supported by the jack. Make sure that they are standing in a safe location if a wheel needs to be changed in a trafficked location.
- No part of your body may be extended under the car while it is raised on the jack.

Lifting points

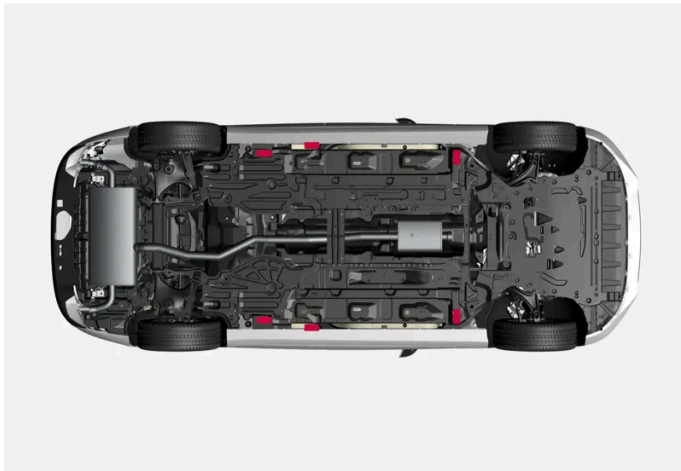

The car has outer lifting points for low level lifting, and inner lifting points for high level lifting, such as garage jack or lifting arms.

 **Warning**

If the car is raised with a garage jack then it must be positioned under the inner lifting points. Follow the instructions enclosed with the garage jack. Make sure that the jack is correctly positioned so that the car cannot slide off during lifting. Make sure the head of the jack is fitted with rubber guards so that the car remains stable and is not damaged. Use axle stands or similar when the car is in the raised position.

Raising the car with a jack

Read through all instructions before beginning. Take out the tools needed before jacking up the car.

- 1 Activate the hazard warning flashers if the car has to be raised in a trafficked location.
Set up the warning triangle.

- 2 Activate the parking brake. Select gear position P.

The content of this manual represents the status of the user manual at the time of printing and may not be completely valid in future instances. For more information, refer to the first page for the complete disclaimer note.

i Note

Applies to cars with level control*: If the car is equipped with air suspension, this must be disabled before the car is raised.

- 3 Position chocks in front of and behind the wheels that remain on the ground. Use, for example, heavy wooden blocks or large stones.
- 4 Position the jack under one of the car's lifting points with the crank handle pointing straight out from the side of the car. The positions of the outer lifting points are marked with triangular arrows along the lower edge of the side of the car. There are special notches for the head of the jack behind the markings.
- 5 Ensure that the jack is stable on flat firm ground and that the surface underneath is not slippery.
- 6 Crank up the jack so that it makes contact with the car's lifting point. Check that the head of the jack (or lifting arms at a workshop) is correctly positioned in the jacking point so that the bump in the centre of the head fits into the jacking point hole.



- 7 Check that the jack is completely vertical and at right angles to the side of the car.
 - The car is now ready to be raised.
- 8 Raise the car just high enough to carry out the work intended. Lower the car using the jack immediately after the work has been completed.

When the jack* is not in use, it is recommended to store it in the car, protected from moisture and dirt.

* Option/accessory.

19. Specifications

19.1. Dimensions and weights

19.1.1. Towing capacity and towball load

Towing capacity and towball load for driving with a trailer can be read in the tables.

Max. weight braked trailer

 **Note**

Use of vibration dampers on the towbar is recommended for trailers heavier than 1800 kg.

Engine	Engine code ^[1]	Max. weight braked trailer (kg)	Max. towball load (kg)
B5	B420T2	2000	100
B6 AWD	B420T	2200	100

 **Important**

When driving with a trailer, it is permitted to exceed the vehicle's gross vehicle weight (including towball load) by a maximum of 100 kg (220 lbs), provided that speed is limited to 100 km/h (62 mph). National legal requirements for the vehicle combination, such as speed, etc. must be observed.

 **Note**

If weight data is missing in the table, it will be updated at a later date.

Max. weight unbraked trailer

Unbraked trailer	
Max. weight (kg)	750
Max. towball load (kg)	50

^[1] The engine code, component number and serial number can be found on the engine.

19.1.2. Dimensions

Measurement of car length, height, etc. can be read in the table.

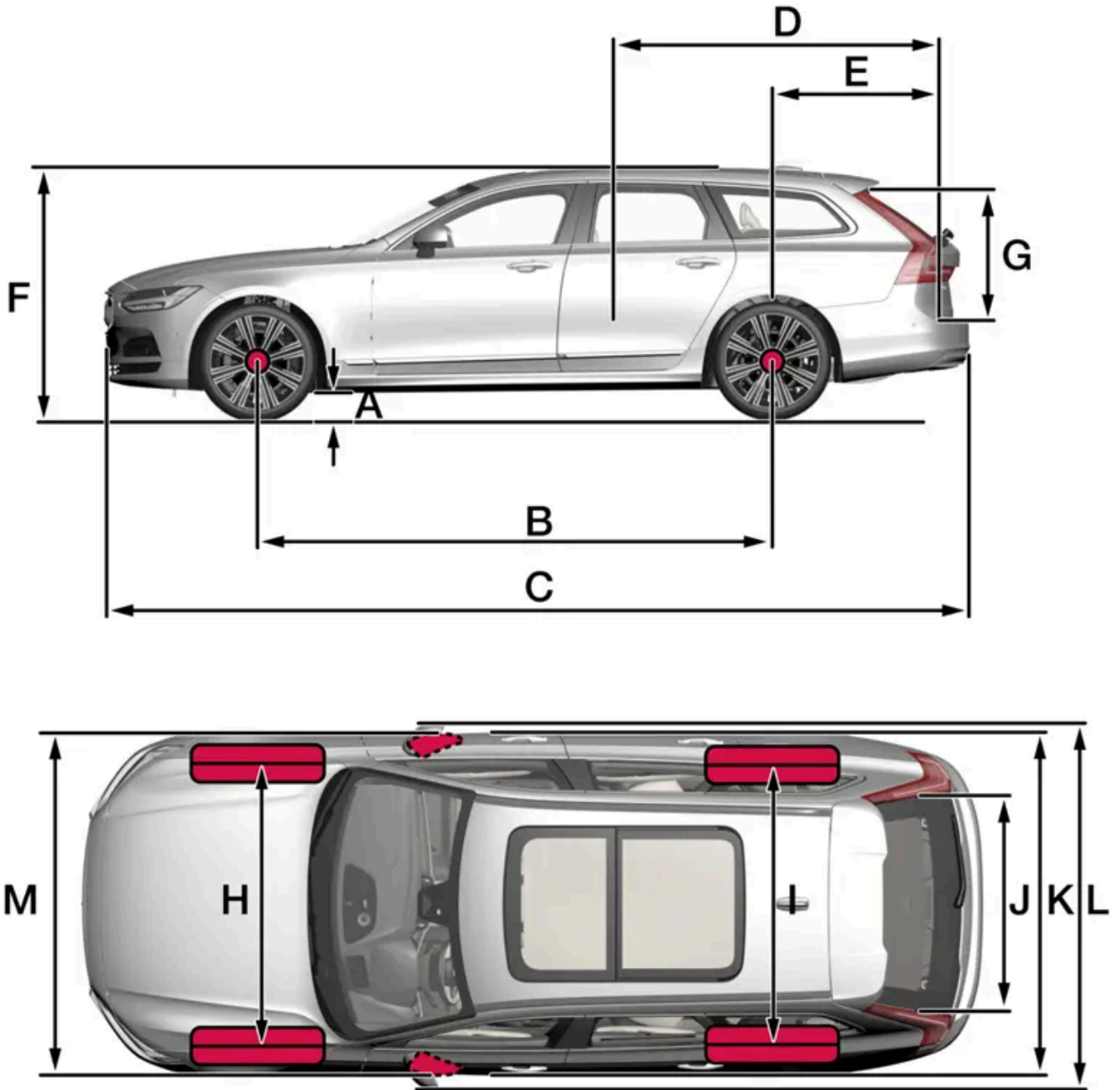

Dimensions		mm	inches
A	Ground clearance ^[1]	148	5,8
B	Wheelbase	2941	115,8
C	Length	4945	194,7
D	Load length, floor, folded seat	1988	78,3
E	Load length, floor	1153	45,4
F	Height ^[2]	1472	58,0
G	Load height	704	27,7
H	Front track ^[3]	1617–1638	63,7–64,5
I	Rear track ^[3]	1618–1639	63,7–64,5
J	Load width, floor	1130	44,5
K	Width	1879 ^[4] 1890 ^[5]	74,0 ^[4] 74,4 ^[5]
L	Width including folded-out door mirrors	2019	79,5
M	Width including folded-in door mirrors	1895	74,6

^[1] At kerb weight plus 1 person. (Varies slightly depending on tyre dimension, chassis option, etc.)

^[2] Including roof antenna, at kerb weight plus 1 person.

^[3] Depending on rim size.

^[4] Body width.

^[5] At door mouldings.

19.1.3. Weights

Maximum total weight, etc., can be read on a decal in the car.

Kerb weight includes the driver, the fuel tank 90% full, plus and all oils and fluids.

The weight of passengers and accessories, and towball load (when a trailer is hitched) influence the load capacity and are not included in the kerb weight.

Permitted max. load = Gross vehicle weight - Kerb weight.

Note

The documented kerb weight applies to cars in the standard version - i.e. a car without extra equipment or accessories. This means that for every accessory added the loading capacity of the car is reduced correspondingly by the weight of the accessory.

Examples of options that reduce load capacity are the different equipment levels, as well as other options such as tow bar, load holder, space box, audio system, auxiliary lamps, GPS, safety grille, carpets, cargo cover, power seats, etc.

Weighing the car is a certain way of ascertaining the kerb weight of your own particular car.

 **Warning**

The car's driving characteristics change depending on how heavily it is loaded and how the load is distributed.

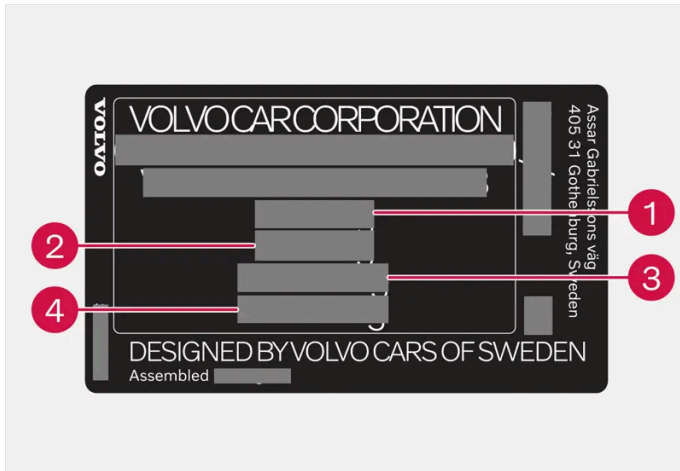

The decal is positioned on the door pillar, and will be visible when the right-hand rear door is opened.

- 1 Max. gross vehicle weight
- 2 Max. train weight (car+trailer)
- 3 Max. front axle load
- 4 Max. rear axle load

Maximum load: see registration document.

Max. roof load: 100 kg.

19.1.4. Specifications for towbar*

Dimensions and mounting points for towbar.

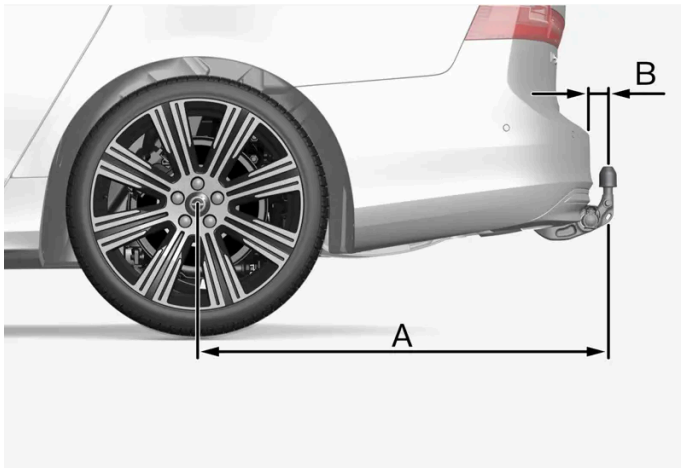

The illustration is generic and may vary depending on model.

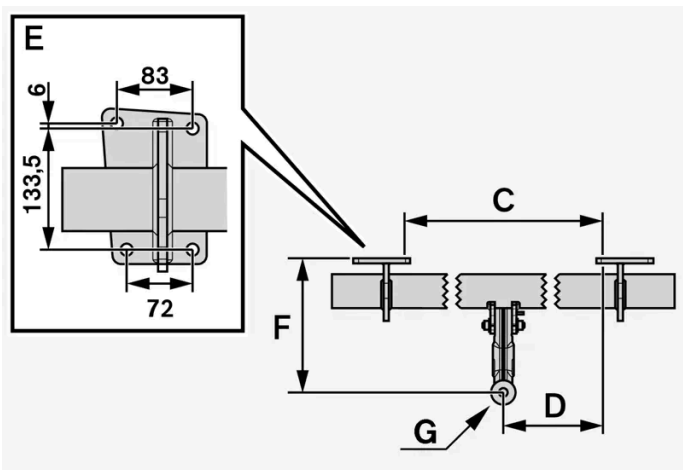

Dimensions, mounting points in mm (inches)	
A	1229 (48.4)
B	111.8 (4.4)
C	875 (34.4)
D	437.5 (17.2)
E	See the image above
F	310.5 (12.2)
G	Ball centre

* Option/accessory.

19.2. Specifications for engine

19.2.1. Engine specifications

Engine specifications (power, etc.) for each respective engine alternative can be found in the table below.

Note

Not all engines are available in all markets.

Note

If engine data is missing in the table, it will be updated at a later date.

Engine	Engine code ^[1]	Output (kW/rpm)	Output (hp/rpm)	Torque (Nm/rpm)	No. of cylinders
B5	B420T2	184/5400–5700	250/5400–5700	350/1800-4800	4
B6 AWD	B420T	220/5400	300/5400	420/2100–4800	4

^[1] The engine code, component number and serial number can be found on the engine.

19.2.2. Adverse driving conditions for engine oil

Adverse driving conditions can lead to abnormally high oil temperature or oil consumption. Below are some examples of adverse driving conditions.

Check the oil level more frequently for long journeys:

- towing a caravan or trailer
- in mountainous regions
- at high speeds
- in temperatures colder than -30 °C(-22 °F) or hotter than +40 °C(+104 °F).

The above also apply to shorter driving distances at low temperatures.

Choose a fully synthetic engine oil for adverse driving conditions. It provides extra protection for the engine.

Volvo recommends:



 **Important**

In order to fulfil the requirements for the engine's service intervals all engines are filled with a specially adapted synthetic engine oil at the factory. The choice of oil has been made very carefully with regard to service life, starting characteristics, fuel consumption and environmental impact.

An approved engine oil must be used in order that the recommended service intervals can be applied. Only use a prescribed grade of oil for both filling and oil change, otherwise there is a risk of the service life, starting characteristics, fuel consumption and environmental impact of the car being affected.

If engine oil of the prescribed grade and viscosity is not used, engine related components may become damaged. Volvo disclaims any liability for any such damage.

Volvo recommends that oil changes are carried out at an authorised Volvo workshop.

19.2.3. Engine oil – specifications

Engine oil grade and volume for each respective engine alternative can be read in the table.

Volvo recommends:



Engine	Engine code ^[1]	Volume, incl. oil filter (litres, approx.)	Oil grade
B5	B420T2	6.1	Castrol Edge Professional V 0W-20 or VCC RBS0-2AE 0W-20
B6 AWD	B420T	6.1	

^[1] The engine code, component number and serial number can be found on the engine.

19.3. Specifications for fluids and lubricants

19.3.1. Topping up washer fluid

Washer fluid is used for cleaning the headlamps as well as the windscreen and rear window. Washer fluid with antifreeze must be used when the temperature is under the freezing point.

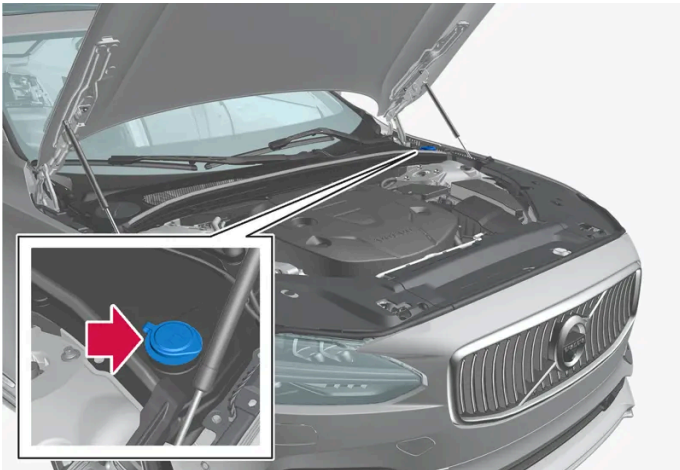

Note

When approx. 1 litre (1 qt) of washer fluid remains in the reservoir, the message **Refill washer fluid, level low** appears together with the  symbol in the driver display.

When the **Refill washer fluid, level low** message together with the  symbol appear in the driver display, it is time to refill washer fluid

- 1 Open the bonnet with the handle in the passenger compartment and then with the handle under the front edge of the bonnet.
- 2 Open the washer fluid reservoir cap.
Washer fluid is filled into the reservoir with the blue cap. The reservoir is used for windscreen washer, rear window washer and headlamp washers*.
- 3 Top up with washer fluid.
- 4 Close the washer fluid reservoir cap and then close the bonnet.

Prescribed grade: Washer fluid recommended by Volvo – with frost protection during cold weather and for temperatures below freezing point.

Important

Use Volvo genuine washer fluid or equivalent with a recommended pH of between 6 and 8, in working dilution (e.g. 1:1 with neutral water).

 **Important**

Use washer fluid with antifreeze when the temperature is below freezing to avoid the fluid freezing inside the pump, reservoir and hoses.

Volume:

- Cars **with** headlamp washing: 5.5 litres (5.8 qts).
- Cars **without** headlamp washing: 3.5 litres (3.7 qts).

* Option/accessory.

19.3.2. Air conditioning – specifications





A freon-free refrigerant (R1234yf) and compressor oil are used in the air conditioning system. Information about the refrigerant is printed on a decal located on the underside of the bonnet.

Decal

Decal for R1234yf



Symbol explanation, decal R1234yf

Symbol	Meaning
	Caution
	Mobile air conditioning system (MAC)
	Lubricant type
	A trained and certified technician is required in order to service the air conditioning system (MAC)
	Flammable refrigerants

Refrigerant R1234yf

The content of this manual represents the status of the user manual at the time of printing and may not be completely valid in future instances. For more information, refer to the first page for the complete disclaimer note.

Refrigerant amount is printed on the decal located on the underside of the bonnet.

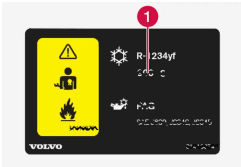

1 Refrigerant amount.

 **Warning**

The air conditioning system contains pressurised refrigerant R1234yf. In accordance with SAE J2845 (Technician Training for Safe Service and Containment of Refrigerants Used in Mobile A/C System), service and repair of the refrigerant system must only be performed by trained and certified technicians in order to ensure the safety of the system.

Compressor oil

Volume	Prescribed grade
80 ml (2.70 fl. oz.) ^[1]	ND12

Evaporator

 **Important**

The air conditioning system's evaporator must never be repaired or replaced with a previously used evaporator. A new evaporator must be certified and labelled in accordance with SAE J2842.

^[1] For some markets, 110 ml (3.72 fl. oz) applies. Consult a Volvo dealer if you are unsure.

19.3.3. Brake fluid – specifications

Brake fluid is the medium in a hydraulic brake system that is used to transfer pressure from e.g. a brake pedal via a master brake cylinder, which in turn acts on the brake callipers.

Prescribed grade: Volvo Original or equivalent fluid compliant with a combination of Dot 4, 5.1 and ISO 4925 class 6.

 **Note**

It is recommended that brake fluid is changed or filled by an authorised Volvo workshop.

19.3.4. Transmission fluid – specifications

Under normal driving conditions, the transmission fluid does not need to be changed during the service life of the gearbox. However, it may be necessary in adverse driving conditions.

Automatic gearbox

Prescribed transmission fluid:	AW-2
--------------------------------	------

 **Note**

Check with your Volvo dealer if you are not sure which variant your car is equipped with.

19.3.5. Fuel tank - volume

The fuel tank's filling capacity can be read in the table below.

	All engines
Litres (approx)	60
US gallons (approx)	15,9

19.3.6. Adverse driving conditions for engine oil

Adverse driving conditions can lead to abnormally high oil temperature or oil consumption. Below are some examples of adverse driving conditions.

Check the oil level more frequently for long journeys:

- towing a caravan or trailer
- in mountainous regions
- at high speeds
- in temperatures colder than $-30\text{ }^{\circ}\text{C}(-22\text{ }^{\circ}\text{F})$ or hotter than $+40\text{ }^{\circ}\text{C}(+104\text{ }^{\circ}\text{F})$.

The above also apply to shorter driving distances at low temperatures.

Choose a fully synthetic engine oil for adverse driving conditions. It provides extra protection for the engine.

Volvo recommends:



! Important

In order to fulfil the requirements for the engine's service intervals all engines are filled with a specially adapted synthetic engine oil at the factory. The choice of oil has been made very carefully with regard to service life, starting characteristics, fuel consumption and environmental impact.

An approved engine oil must be used in order that the recommended service intervals can be applied. Only use a prescribed grade of oil for both filling and oil change, otherwise there is a risk of the service life, starting characteristics, fuel consumption and environmental impact of the car being affected.

If engine oil of the prescribed grade and viscosity is not used, engine related components may become damaged. Volvo disclaims any liability for any such damage.

Volvo recommends that oil changes are carried out at an authorised Volvo workshop.

19.3.7. Engine oil – specifications

Engine oil grade and volume for each respective engine alternative can be read in the table.

Volvo recommends:



Engine	Engine code ^[1]	Volume, incl. oil filter (litres, approx.)	Oil grade
B5	B420T2	6.1	Castrol Edge Professional V 0W-20 or VCC RBS0-2AE 0W-20
B6 AWD	B420T	6.1	

^[1] The engine code, component number and serial number can be found on the engine.

19.4. Specifications for wheels and tyres

19.4.1. Approved tyre pressures

Approved tyre pressures for each engine alternative can be found in the table.

Note

All engines, tyres or combinations of these are not always available in all markets.

Tyre dimension	Speed	Load, 1-3 persons		Max. load		ECO pressure ^[1]
		Front kPa (psi) ^[2]	Rear kPa (psi)	Front kPa (psi)	Rear kPa (psi)	Front/rear kPa (psi)
245/45 R18 255/40 R19	0-180 km/h (0-112 mph)	230 (33)	230 (33)	280 (41)	280 (41)	280 (41)
255/35 R20	0-180 km/h (0-112 mph)	240 (35)	240 (35)	280 (41)	280 (41)	280 (41)
245/35 R21	0-180 km/h (0-112 mph)	250 (36)	250 (36)	280 (41)	280 (41)	280 (41)
Temporary Spare Tyre	max 80 km/h (max 50 mph)	420 (60)	420 (60)	420 (60)	420 (60)	–

^[1] Economical driving.

^[2] In certain countries the "bar" unit is used alongside the SI unit "Pascal": 1 bar = 100 kPa.

19.4.2. Approved wheel and tyre sizes

In certain countries not all approved sizes are indicated by the registration document or other documents. The following table shows all approved combinations of wheel rims and tyres.

✓ = Approved

Engine	245/45R18 8x18x42	255/40R19 8,5x19x47	255/35R20 8,5x20x47,5	245/35R21 8,5x21x44,5
B5 (B420T2)	✓	✓	✓	✓

19.4.3. Minimum permitted tyre load index and speed rating for tyres

The table below shows minimum permitted load index (LI) and speed rating (SS) for tyres.

Engine	Minimum permitted load index (LI) ^[1]	Minimum permitted speed rating (SS) ^[2]
B5 (B420T2)	96	H

^[1] The tyre's load index must be at least equal to or greater than indicated in the table.

The content of this manual represents the status of the user manual at the time of printing and may not be completely valid in future instances. For more information, refer to the first page for the complete disclaimer note.

[2] The tyre's speed rating must be at least equal to or greater than indicated in the table.

19.5. Type designations

The decals in the car contain information such as chassis number, type designation, colour code, etc.

Label location

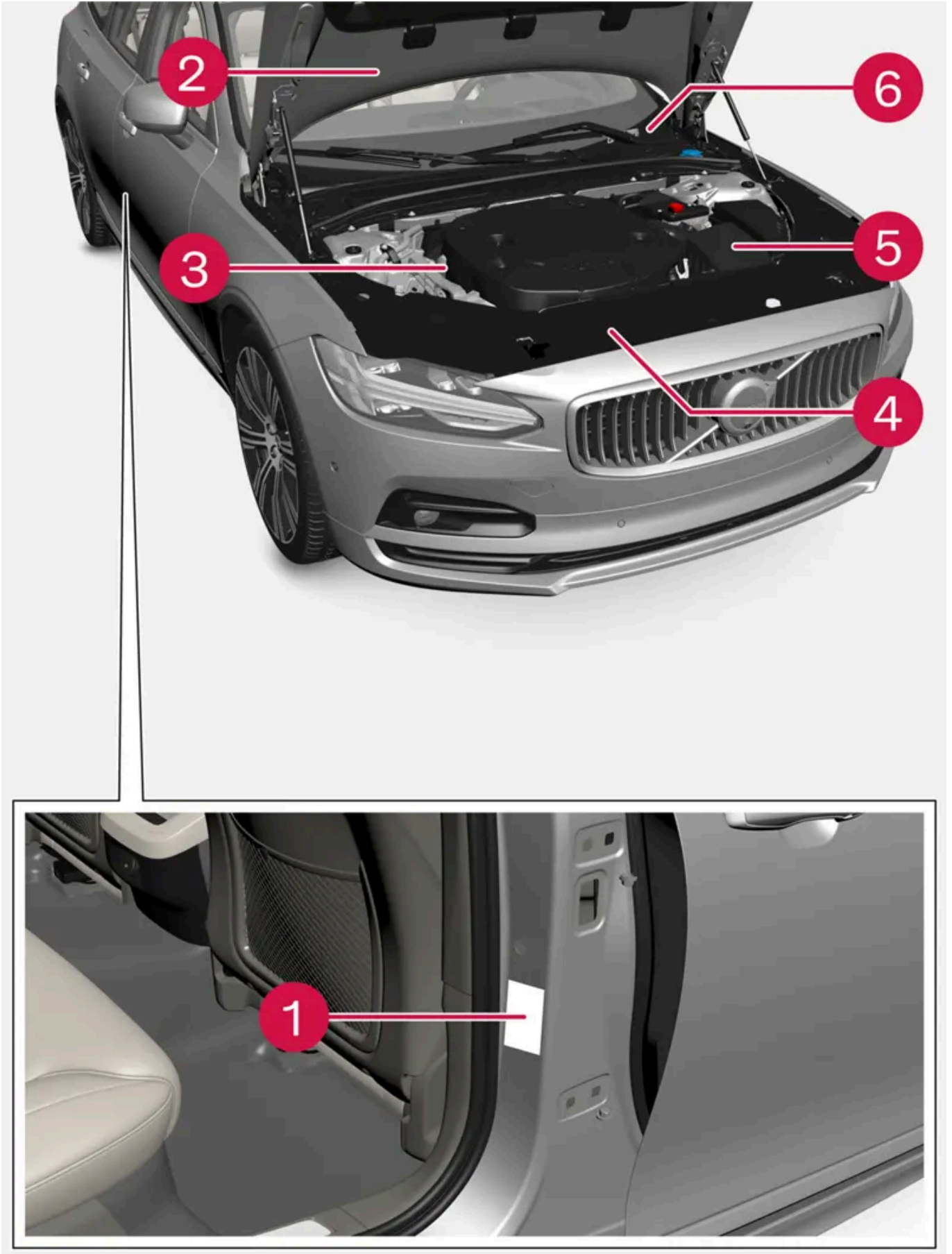

The figure is schematic - parts may vary depending on market and model.

Knowing the car's type designation, vehicle identification number and engine code can facilitate contact with a Volvo dealer regarding the car and when ordering spare parts and accessories.



1 Decal for type designation, vehicle identification number, permissible maximum weights and code designation for exterior colour and type approval number. The decal is positioned on the door pillar, and will be visible when the right-hand rear door is opened.



2 Decal for A/C system for cars with refrigerant R1234yf. The decal is placed on the underside of the bonnet.



3 Decal for engine code and the engine's serial number. For certain engine alternatives there is no decal. In these cases, the engraved engine code can be read directly on the engine instead.



4 Label for engine oil.



5 Decal for gearbox type designation and serial number.



6 Decal for the car's identification number - VIN (Vehicle Identification Number). The decal is located on the top left-hand part of the instrument panel and is visible through the windscreen.

Further information on the car is presented in the registration document.



Note





It is not intended that the decals illustrated in the owner's manual should be exact replicas of those in the car. They are included to show their approximate appearance and locations in the car. The information that applies to your particular car can be found on the decal on the car.

19.6. Fuel consumption/electric consumption and CO₂ emissions

The information in the tables below is in accordance with WLTP (Worldwide Harmonised Light-Duty Vehicles Test Procedure), which is an international test method for vehicles.















The fuel consumption for a vehicle is measured in litres per 100 km and carbon dioxide emissions (CO₂) are measured in gram CO₂ per km.

Explanation	
	Urban driving (slow)
	Suburban driving (average speed)
	Extra-urban driving (fast)

	Motorway driving (very fast)
	Combined value (combined driving)
CO ₂	Gram CO ₂ /km
	Litres/100 km
	Low value
	High value

 **Note**

If fuel consumption and emissions data are missing in the table, it will be updated at a later date.

											
		CO ₂		CO ₂		CO ₂		CO ₂		CO ₂	
B6 AWD(B420T)		271	11.9	179	7.9	150	6.6	170	7.5	179	7.9
		284	12.5	196	8.6	167	7.4	191	8.4	197	8.7

The values in the table above for fuel consumption and CO₂ emissions are based on special drive cycles (see below). The car's weight may increase depending on its equipment level. Together with how heavily the car is loaded, this affects fuel consumption and CO₂ emissions. According to WLTP, every car has unique fuel consumption and CO₂ emission values depending on how the car is equipped. These values range between the low value and high value in the table above. In many markets, you can find your car's unique fuel consumption and CO₂ emission values in the car's registration document.

There are several reasons for fuel consumption that is higher than the values in the table. Examples of these include:

- If the car is equipped with extra equipment that affects its weight or air resistance.
- Driving style.
- If the customer chooses wheels other than those mounted as standard on the basic version of the model, this could increase rolling resistance.
- High speed causes increased air resistance.
- Fuel quality, road and traffic conditions, weather and the condition of the car.

A combination of the examples above could increase consumption considerably.

The content of this manual represents the status of the user manual at the time of printing and may not be completely valid in future instances. For more information, refer to the first page for the complete disclaimer note.

There may be huge deviations in fuel consumption if comparing to the drive cycle profiles (see below), which are used in the certification of the car and on which consumption figures in the table are based. For further information, please refer to the referenced regulations.

 **Note**

Extreme weather conditions, driving with a trailer or driving at high altitudes, in combination with poorer fuel quality than recommended, are factors that considerably increase the car's fuel consumption.

WLTP standard

The WLTP standard (Worldwide Harmonised Light-Duty Vehicles Test Procedure) is a standard to calculate consumption values in the car. The WLTP standard represents the average driving conditions for everyday driving. In comparison with the previous standard (NEDC), WLTP takes into account more varied traffic situations and speeds, but also equipment and weight classes. Optional equipment that affects consumption is deactivated during testing, e.g. air conditioning, seat heating, etc. The new standard should provide more realistic figures when it comes to fuel consumption, carbon dioxide and emissions. The values are intended to allow comparison between different cars and not to represent your typical normal consumption.

Drive cycle profiles

A drive cycle simulates actual average driving of the car. The standard is based on four different drive cycle profiles, which are as follows:

- **Urban driving** – slow driving
- **Suburban driving** – average speed driving
- **Extra-urban driving** – fast driving
- **Motorway driving** – very fast driving.

Every drive cycle is determined by different conditions such as speed, time and mileage, for example.

The official value for combined driving, which is shown in the table, is a combination of the results from the four drive cycles, in accordance with legal requirements.

The exhaust gases are collected in order to extrapolate the carbon dioxide emissions (CO₂ emissions) during the four drive cycles. These were then analysed to determine the value for CO₂ emissions.